

05-002

Nature

A WEEKLY

ILLUSTRATED JOURNAL OF SCIENCE



Nature

A WEEKLY

ILLUSTRATED JOURNAL OF SCIENCE

VOLUME XXXV

NOVEMBER 1886 to APRIL 1887

*“To the solid ground
Of Nature trusts the mind which builds for aye.”—WORDSWORTH*

London and New York
MACMILLAN AND CO.

1887

INDEX

- ABBADIE (Antoine d'), Lightning-Flashes, 342
 Abbe (Prof. Cleveland): Influence of Wind on Barometric Readings, 29; Correction to Refraction-Tables, 134; Obituary Notice of William Babcock Hazen, 541
 Abel, the Mathematician, Statue in Honour of, 352
 Abel (Sir Fred., F.R.S.), Work of the Imperial Institute, 617
 Abercromby (Hon. R.): on the Peculiar Sunrise Shadows of Adam's Peak, 94; on the Relation between Tropical and Extra-Tropical Cyclones, 430; an Equatorial Zone of almost Perpetual Electrical Discharge, 487; Modern Developments of Cloud Knowledge, 575
 Aberdeen, Stone Circle near, 503
 Aberration, New Method of determining the Constants of, M. Leewy, 263, 282, 407, 424, 434, 454, 479; M. Houzeau, 377
 Aberration of Light, Phenomena connected with, 575
 Abney (Capt. W. de W., F.R.S.), Sunlight Colours, 498
 Abnormal-Tooth Cars, Heredity in, William White, 125; E. W. Claypole, 345; Dr. H. A. Hagen, 345; J. Herbert Hodd, 53
 Abnormal *Houd. m. leucalis*, an, R. J. Harvey Gibson, 392
 Abnormalities in the Vertebral Column of the Common Frog, Prof. C. Lloyd Morgan, 53
 Abnormality in the Crostyly of the Common Frog, Prof. C. Lloyd Morgan, 344
 Aboriginal Art in California and Queen Charlotte's Island, Dr. W. J. Hoffman, 285
 Abrahall (Rev. John Ho-lym--), Meteors, 29
 Acclimatisation of Flat Fish in American Waters, 473
 Accumulators, Complete Hand-book on the Management of, Sir David Salomons, 603
 Acetonuria in Children, 551
 Acland (Dr., F.R.S.), Address to the General Medical Council, 375
 Acoustics, Hand-book of, T. E. Harris, 270
 Actinometric Observations, 263
 Action, Instinctive, 392
 Adams (Prof. J. C., F.R.S.), Values of Logarithms, 381
 Adam's Peak, on the Peculiar Sunrise Shadows, Hon. R. Abercromby, 94
 Adelaide University, Sir W. W. Heughes's Contribution to the, 255
 Aden, Earthquakes at, 593
 Aerated Water, on some Phenomena connected with the Freezing of, George Maw, 325
 Aerial Eddies, Experiments on, 382
 Aerial Vortices, 551
 Aerial Vortices and Revolving Spheres, Experiments on, Ch. Weyher, 514
 Affinity, Residual, Valency and, Prof. H. E. Armstrong, F.R.S., 570, 590
 Afghan Delimitation Commission: Botany of the, W. Botting Hemby, 173; Geographical Results achieved by the Survey Officers in the, 309; Fauna and Flora of the, J. E. T. Aitchison, 381
 Africa: Don Manuel Trudier's Explorations in Africa, 182; Return of the Portuguese African Expedition, 182; Botany of South, 158; Study of the Coasts of North, Dr. Theobald Fischer, 353; Dr. Lenz's Maps of the Congo, 354; Pygmy Tribes in, 497; My African Home, Eliza Whigham Feilden, 221
 Amo Hauniness and the Uivolk of Japan, F. V. Dickins, 534
 Air, the Coefficient of Viscosity of, Herbert Tomlinson, 105
 Air, Compressed, Transmission of Power by, 272
 Air, Resistance of, Dr. Thiesen, 408
 Air, Movements of the, M. Ch. Weyher, 131
 Air, some New Micro organisms obtained from, G. C. Frankland and Dr. Percy F. Frankland, 477
 Air free Column of Water, Cohesion of an, Prof. Helmholtz, 459
 Airy (Sir G. B., F.R.S.): on the Earlier Types of the University of Cambridge, 397; on the Establishment of the Roman Dominion in South-East Britain, 562
 Aitchison (J. E. T.), Fauna and Flora of the Afghan Boundary, 381
 Alaska and the Seal Islands, an Arctic Province, Henry W. Elliott, 243
 Ala-ka, Alpine Region of, Lieut. H. Scion-Karr, 475
 Albumen precipitate with Salt, 455
 Albumen, Scours, Prof. Kronecker on, 504
 Albuminous Substances, Alimentary Value of Various, Prof. Zuntz, 480
 Alcock (Surgeon-Major Nathl.), Life-Energy, on the Dynamics of Health and Disease, 396
 Alcohol, How to make Colourless Specimens of Plants to be preserved in, Prof. Hugo de Vries, 149; Selmer Schonland, 173
 Alcohol, Effect of, on Metastasis in Man, 383
 Alcohol, Clausius's Characteristic Equation for Substances applied to Messrs. Ramsay and Young's Experiments on, Prof. Fitzgerald, 574
 Alcyonaria and Pennatulæ at the Arago Laboratory, 431
 Alexander (Prof. W. D.), Kilueca after the Eruption of March 1886, 451
 Alge, Classification of the, and Genetic Affinities, Alfred W. Bennett, 478
 Algebraic Forms with n Variables, on the Theory, M. R. Perrin, 335
 Algebraic Notation of Kinship, Prof. Alex. Macfaldane, 126
 Algeria, Arte-fian Wells in, M. de Lesseps, 287, 336
 Algiers Observatory, the, 16

- Algol-Type Variable, the New, Mr. Chandler, 329
 Alimentary Values of Various Albuminous Substances, Prof. Zuntz, 480
 Alkaline Solutions, Electrolysis of, M. Duter, 382
 Alkaline Vanadates, Study of the, M. A. Ditté, 600
 Allen (Alfred H.), Commercial Organic Analysis, Dr. C. R. Alder Wright, 293
 Alloys, Moduli of, 333
 Alloys, Colours of Metals and, Prof. W. Chandler Roberts-Austen, F.R.S., 106
 Alpine Flora surviving in the Paris District, 431
 Alpine Region of Alaska, Lieut. H. Seton-Karr, 475
 Alpine Winter and its Medical Aspects, A. Tucker Wise, 170
 Alps, Australian, on some Further Evidence of Glaciation in the, James Stirling, 182
 Altai Mountains, an Ice Period in the, E. Michaelis, 149; A. Bialove-ki, 513
 Alumina, Red Fluorescence of, 455, 527; Crimson Line of Phosphorescent, William Crookes, F.R.S., 310
 Amateurs, Practical Dynamo-Building for, Fred. W. Walker, 294
 America: American Journal of Science, 16, 93, 141, 237, 380, 451, 524, 621; American Journal of Mathematics, 28, 99, 477; Early Chinese Intercourse with America, Dr. W. H. Dall, 58; Industrial and High Art Education in the United States, J. Edwards Clarke, W. Odell, 97; Education of Women in, 229; American Society for Psychical Research, 281; Present Position of Science in the Secondary Schools of America, Pres. Eliot, 375; American Meteorological Journal, 376, 568; American Journal of Psychology, 407; American Association for the Advancement of Science, 444; Acclimatisation of Flat-fish in American Waters, 473; Prehistoric Remains in America, 476; American Geographical Society, 497; American Naturalist, 518; American Whitefish (*Coregonus albus*) at Burghley Park, 546; Restocking Streams in America, 546; American Exhibition, 612. *See also* United States.
 Amides, Decomposition of, by Water and the Diluted Acids, 144
 Ammonia, Caseine-like Substance obtained by the Addition of Hydrogen-Peroxide to White of Eggs, heated with, 576
 Ammoniacal Decomposition of Urine, Dr. W. R. Smith, 404
 Ammonio-Magnesian Phosphate, M. Berthelot, 119
 Anatomical Society of Berlin, 517
 Anatomy, Comparative, of Vertebrates, Robert Wiedersheim, W. Newton Parker, 121
 Anatomy of the Madreporian Coral Fungia, G. C. Bourne, 404
 Anatomy, a Work on, in Chinese, 568
 Ancient History, Studies in, comprising a Reprint of "Primitive Marriage," J. Ferguson McLennan, Dr. W. Robertson Smith, 3
 Ancient Monuments Act, 518
 Anderson (W.), on the Conversion of Heat into Work, 387
 Andree (Herr Richard), Cannibalism and its Prevalence in Ancient and Modern Times, 350
 Andrews (Thos.), Pyrometer- and Fusion-Points, 224
 Andromedes, the, November 27, 1886, P. F. Denza, 231
 Ångström (Knut), Sur une nouvelle Méthode de faire des Mesures absolues de la Chaleur rayonnante, 580
 Anhydrous Oxides, on the Action of the Chloride of Carbon on the, M. Eug. Demarçay, 288
 Animal Heat, Action of Glycose in Development of, A. Chauveau, 291
 Animal Life, Apparatus for studying the Influence of Pressure on, 444
 Animal Mechanics, Dr. B. W. Richardson, F.R.S., 57
 Animal Organism, Respecting the Active Oxygen in the, Dr. Gad, Dr. Wurster, 383
 Animals, Wild, Photographed and Described, J. Fortuné Nott, 220
 Animals, Geographical and Geological Distribution of, Angelo Heilprin, 510
 Annalen der Physik und Chemie, 333
 Annales de l'Institut Pasteur, 376
 Annam, Notes on, 206
 Annuaire of the Royal Observatory of Brussels, 351
 Antananarivo Annual and Madagascar Magazine, 497
 Antarctic Ocean, on the Distribution of the Temperature in the, J. Y. Buchanan, 516
Antedon rosacea, the Supposed Myzostoma-Cysts in, Dr. P. Herbert Carpenter, F.R.S., 535
 Anthropoid Apes, 383; Embryogeny of the, J. Deniker, 509
 Anthropology: Horatio Hale on the Origin of Language and the Antiquity of Speaking Man, 17; Dr. Colin on the Population of Bambouk, 22; M. Topinard on the Simian Characters of the Naulette Jaw, 22; M. de Quatrefages on Prehistoric Man, 23; M. Cartailhac, on the Human Bones found in France in Quaternary Caverns, 23; Anthropological Institute, 95, 143, 358, 431, 453, 503; Journal of the, 422; Les Ages Préhistoriques de l'Espagne et du Portugal, Emile Cartailhac, 244; Anthropological Society of Bombay, 328; General Pitt-Rivers's Anthropological Collection at Oxford University Museum, 349; Observations in Anthropology, by Dr. Ten Kate, 357; Revue d'Anthropologie, 357; Sociology of the Australian Races, 357; Anthropological Discovery in the Valley of Rebas, Prof. Miguel Marazta, 379; Histoire Générale des Races Humaines, A. de Quatrefages, 389; Anthropological Find in Belgium, 405; Ethnological Collection presented by Lieut. Quadenfeldt to the Anthropological Society of Berlin, 423; French Translation of Cesar Lombroso's "Uomo Delinquente," 423
 Antifebrine, Dr. Weill, 445
 Antimony, Tartrate of, M. Guntz, 528
 Anti-Phylloxeric Disinfection of the Grape Vine, 382
 Antiquities of Spain and Portugal, M. Emile Cartailhac, 244
 Antituberculous Vaccination, 144
 Ants, Habits of, Sir John Lubbock, 518
 Apes: an Anthropoid Ape, 383; Embryogeny of the, J. Deniker, 509; the Lumbar Curve in Man and Apes, Prof. Cunningham, 46; Domestication of Apes, 495
 Aphides, Notes on the Recent Swarming of, G. B. Buckton, F.R.S., 15
 Apochromatic Lenses, the Value of the New, 467
 Appalachia, 354
 April Meteors, W. F. Denning, 606
 Aquarium constructed for the Fisheries Exhibition, Sale of, 306
 Aquila, Lower Italy, Earthquake Shock in, 350, 376
 Arabia, South, Herr Glaser's Journeys in, 520
 Arago (François), Proposed Statue of, 84
 Arago Laboratory, Flourishing Condition of the Aleyonaria and Pennatulæ at, 431
 Arcturi, Observations of Nebule at, Wilhelm Tempel, 198
 Architects, Naval, Institution of, 538
 Arctic Province, an, Alaska and the Seal Islands, Henry W. Elliott, 243
 Arctic Species of Birds, Henry Seebohm on, 256
 Arctun Leaf-beds, J. Starkie Gardner, 382
 Argentine General Catalogue of Stars, 113
 Arithmetic, Chemical, Sydney Upton, 74
 Armagh Catalogue of 3300 Stars, Second, 159
 Armstrong (Prof. Henry E., F.R.S.): on the Nature of Solution, 64; Benzenoid Compounds, 407; Valency and Residual Affinity, 570, 596
 Army Candidates, Geometrical Drawing for, H. T. Lilley, 28
 Aroids, Walter Gardner on, 454
 Aroko or Symbolic Letters, Specimens of, 422
 Aromatic Bodies, Preliminary Communication on the Action of certain, T. Lauder Brunton, M.D., F.R.S., and J. Theodore Cash, 599
 Aron (Dr.), Theory of the Inductionless Coils, 383
 Arrow-Release, Ancient and Modern Methods of, Edward S. Morse, 12
 Art and Science in a New Light, 250
 Artesian Well, Attempt to sink an, to obtain Hot Water at St. Augustine, Florida, 376
 Artesian Wells in Algeria, M. de Lesseps, 287
 Artesian Wells and New Oases created in the Wed Riv', South Algeria, 336
 Asamayama, the Active Volcano in Japan, 133
 Ashes of Cider, on the Composition of the, 382
 Asia, Central: Central Asian Commercial Company Koudrine in, 258; A. D. Carey's Journey in, 475; Journeys and Discoveries in, 547
 Asia, Russian Central, Proposed Administrative Changes in, 258
 Asiatic Society of Bengal, 474
 Asiatic Society, Calcutta, Annual Address to, 375
 Asiatic Symbolism, Study of, H. G. M. Murray-Aynsley, 327
 Aspects of Clouds, Robert James Reilly, 391

- Assam, History of the Province of, during the last Fifty Years, 422
- Association's "Geometry," the, Prof. Geo. Bruce Halsted, 557
- Asteroids, Comets and, Prof. Daniel Kirkwood, 474
- Astigmatism in the Eye, Influence of, on Astronomical Observations, Prof. Seeliger, 59
- Astronomy: Astronomical Theory of the Great Ice Age, W. H. S. Monck, 7; Sir Robert S. Ball, F.R.S., 53; Rev. E. Hill, 101; Astronomical Refractions, Herr Oppolzer's, 17; Binary Star γ Coronæ Australis, H. C. Wilson, 17; Binary Star δ Equulei, 401; Temple Observatory, 401; Brightness and Mass of Binary Stars, W. H. S. Monck, 402; Astronomical Column, 17, 37, 59, 85, 113, 134, 159, 181, 206, 231, 257, 282, 307, 329, 352, 377, 401, 424, 445, 474, 496, 546, 569, 595, 614; Astronomical Phenomena for the Week, 18, 37, 59, 86, 113, 135, 160, 181, 207, 232, 258, 283, 308, 330, 353, 378, 402, 425, 446, 474, 497, 520, 546, 595, 614; Habénicht on the Morphology of the Kosmos, 35; the Leander McCormick Observatory, 35; New Map of the Moon, 58; Influence of Astigmatism in the Eye on Astronomical Observations, Prof. Seeliger, 59; Gould's Astronomical Journal, 59; Ten Years' Progress in Astronomy, Prof. C. A. Young, 67, 86, 117; Spectroscopic Method of Determining the Distance of a Double Star, A. A. Rumbaut, 206; Comet Barnard (1886 *f*), 207; T. W. Backhouse, 224; Prof. A. Ricciò, 296; Discovery of a New Comet (Barnard 2), 402; Comet Barnard (1887 *c*), Prof. S. Weiss, 352; Dr. H. Oppenheim, 424; Comet 1887 *d* (Barnard, February 15), Prof. Boss, 424, 446; Names of Minor Planets, 207, 402; New Minor Planet, Prof. C. H. F. Peters, 282; Observations of the Minor Planets, 312; Minor Planet No. 264, 353; Minor Planet No. 265, M. Bigourdan, 474; New Minor Planet, Herr Palisa, 425; Comet Finlay (1886 *c*), Dr. J. Holetschek, 207; Meteor, 224; Meteor of December 28, 1886, W. F. Denning, 248; the Andromedes, November 27, 1886, P. F. Denza, 231; Reduction of the Positions of Close Polar Stars from one Epoch to another, Prof. W. A. Rogers and Miss Anna Winlock, 231; Six Inner Satellites of Saturn, Prof. Asaph Hall, 257; Stellar Parallax, Prof. Asaph Hall, 258; Bright Lines in Stellar Spectra, O. T. Sherman, 378; Astronomical Prizes of the Paris Academy of Sciences, 258; Madras Observatory, Mr. Pogson, 282; New Method for the Determination of the Constant of Aberration, M. Lœwy, 282, 424, 431; M. Houzeau, 377; New Variables in Cygnus, Dr. Gould, 282; New Variables, S. C. Chandler, 307; the New Algol Type Variable, Mr. Chandler, 329; Gore's Variable near χ^1 Orionis, Dr. G. Muller, 329; Probable New Variable, 402; Three New Comets, 307; Washington Observatory, 308; Revue Mensuelle d'Astronomie populaire de Météorologie, et de Physique du Globe, 310; Photography the Servant of Astronomy, Edward S. Holden, 317; Progress of Astronomical Photography, 321; the Southern Comet, 329, 438; a Short Method for Computing Refractions, M. Schaeberle, 329; Celestial Motions, W. T. Lynn, 350; Comet Brooks (1887 *b*), Dr. Rud. Spitaler, 352, 424, 496; Minor Planet No. 262, 497; Harvard College Observatory, 497; Mr. Peek's Report on Rousdon Observatory, 353; Application of Photography to the Determination of Stellar Parallax, Prof. Pritchard, 377; Alleged Ancient Red Colour of Sirius, Mr. Lynn, 378; Observations of Variable Stars in 1885, Edward Sawyer, 378; Note on the Origin of Comets, 381; Harvard College Observatory, Prof. Pickering, 424; Solar Activity in 1886, Prof. Tacchini, 445; Warner Observatory, Lewis Swift, 446; Tails of the Comets of 1886, Prof. Th. Bredichin, 474; Comets and Asteroids, Prof. Daniel Kirkwood, 474; Paris Astronomical Congress, 584; Homeric Astronomy, A. M. Clerke, 585, 607; U.S. Naval Observatory, 595; Researches on the Sun's Diameter, Prof. Di Legge, 595; Liverpool Astronomical Society, 402; Telegraphic Determination of Australian Longitudes, 474; Researches on the Diameter of the Sun, Herr Auwers, 496; the Parallax of α 1516, M. O. Struve, 546; Baron D'Engelhardt's Observatory, 546; New Red Star, 546; Orbit of the Binary Star 14 (*i*) Orionis, J. E. Gore, 569; Washington Observatory, Capt. R. L. Phythian, 569; Names of Minor Planets, 569; Barnard's First and Second Comets 1887, 614; Probable Re-discovery of Hesperia, 614; Ellipticity of Uranus, 614; Washington Observatory, 614; Paris Conference, 614
- Atkinson (W. N. and J. B.), Explosions in Coal-Mines, Prof. T. E. Thorpe, F.R.S., 1
- Atlantic Weather Charts, 469
- Atlantic, Purity of the Air of, 595
- Atlantica, Spolia, 603
- Atom, Electric Charge on the, A. P. Laurie, 131
- Atomic Weights of Elements, 612
- Atmosphäre, Grundzüge einer Theorie der kosmischen Atmosphären mit Berücksichtigung der irdischen, 389
- Atmosphere, New Method for Quantitative Estimation of Micro-organisms in, Dr. P. F. Frankland, 188
- Atmosphere, on the Direct Fixation of the Gaseous Nitrogen of the, by Vegetable Soils, M. Berthelot, 335
- Atmosphere, Direct Fixation of the Gaseous Nitrogen of the, 479
- Atmosphere of β Lyrae, O. T. Sherman, 451
- Atmosphere, Movements of the, 479; M. Faye, 455
- Atmospheric Movements in Connection with Collaton and Lasne's Cyclonic Theories, 527
- Atmospheric Oxidation, Note on the Development of Voltaic Electricity by, C. R. Alder Wright, F.R.S., 598
- Atmospheric Temperature in Germany, 504
- Auk, the, 204
- Aurora, Prof. F. Hahn, 8; Dr. M. A. Veeder, 54, 126, 272
- Aurora Borealis: Display of, at Thronhjelm in Norway, 112; M. S. Lemström, A. M. Clerke, 433; in Northern Sweden, 443
- Australia: Australian Earthworms, J. J. Fletcher, 95; on some Further Evidence of Glaciation in the Australian Alps, James Stirling, 182; the Gould Collection of Australian Birds at Philadelphia, 204; Native Plants of Australia, 205; Baron von Mueller, on the Acacias (Wattles) of, 282; Sociology of the Australian Races, 357; Manual of Physical Geography of Australia, H. Beresford de la Poer Wall, 389; Bee-hives discovered in a Gigantic Eucalyptus-Tree in, 423; Relief of the Australian Mediterranean, Dr. Otto Krümmel, 447; Telegraphic Determinations of Australian Longitudes, 474; Catalogue of Minerals in the Australian Museum, 485; Australian Rabbit, 569
- Australasian Association for the Advancement of Science, 228
- Austria, Ice Cavern in, Discovery of, 17
- Autographometer, Floran de Villepigne, 444
- Autumnal Flowering, Dr. Maxwell T. Masters, 11
- Avifauna of the Western Spur of the Pamir Plateau, V. Bianchi, 328
- Awaruite, Oktibehite or, Dr. Jas. Hector, F.R.S., 513
- Axolotl, the, *in situ*, 16
- Ayrton (Prof. W. E.) and Prof. John Perry, Experiment to show that Capacity varies inversely as a Thickness of the Dielectric, 526; Note on Magnetic Resistance, 526; Practical Electricity, 601
- Azines, New Method of producing, 384
- Babington (Dr. Churchill), Birds of Suffolk, 193
- Bacillus, Luminous, 383
- Bacillus, Swamp Fever and, 405
- Backhouse (T. W.), Barnard's Comet, 54, 224
- Backlund (Herr), Mass of Mercury, 85
- Bacteria, on Staining, 404
- Baert (Lieut.), Journey up the Mongalla, 446
- Baginski (Dr. A.), Acetouuria in Children, 551
- Bagshot Beds of the London Basin, Physical History of, Rev. A. Irving, 382
- Bahamas, a Balanoglossus Larva from the, W. F. R. Weldon, 477
- Bailey (E. H. S.), and Edward L. Nichols, the Sense of Smell, 74
- Bailey-Denton (T.), Ten Years' Experience in Works of Intermittent Downward Filtration, 195
- Baird's (Prof.) Annual Report of the Smithsonian Institution, 372
- Baker (J. G.), Flora of Leicestershire including the Cryptogams, 411
- Baku, Outburst of Natural Naphtha Fountain at, 352
- Balanoglossus Larva from the Bahamas, a, W. F. R. Weldon, 477
- Baldness in the United States, 595
- Balfour (Prof. Bayley): Botanical Lecture Experiment, 126; Ginger-Beer Plant, 358
- Ball (John, F.R.S.), Notes of a Naturalist in South America, 529, 553

- Ball (Sir Robert S., F.R.S.), *Astronomical Theory of the Great Ice Age*, 53
- Ballistic Galvanometer and Earth Inductor, Determination of Coefficients of Mutual Induction by means of the, R. H. M. Bosanquet, 478
- Ballooning, War and, Eric S. Bruce, 259
- Banbury, Remarkable Meteor near, 58
- Bareggi (Dr.), Experiment on Rabies, 422
- Barley, Examination of Specimens of Injured, Miss Ormerod's Observations on, 256
- Barnaby (Sir Nathaniel), on the Connexion between the Royal Navy and the Merchant Service, 538
- Barnard, Comets, 59; T. W. Backhouse, 54, 224; Prof. Cacciatori, 181; Dr. Wentworth Frick, 198; at Perihelion, Prof. A. Riccò, 296; Comet (1886 *f*), 207; Dr. Oppenheim, 85; Dr. Aug. Svedstrup, 134; Comet (1887 *c*), Prof. E. Weiss, 352; Dr. H. Oppenheim, 424; Comet (1887 *d*), Prof. Boss, 424, 446; (Barnard 2), Discovery of a New Comet, 402; Second Comet, John L. Plummer on, 583; Barnard's First and Second Comets 1887, 614
- Barnard and Finlay, Comets, 17
- Barograph, Dr. Sprung, 456
- Barometer, on the Determination of the Air in the Vacuum of the, Dr. Pernet, 72
- Barometer free of Air, New Method of Filling, 432
- Barometers, Comparison of, Dr. Pernet, 600
- Barometric Readings, Low, Henry F. Blanford, 344
- Barometric Readings, Influence of Wind on, Prof. Cleveland Abbe, 29; G. J. Symonds, F.R.S., 53
- Barrett (Prof. W. F.), Physical Properties of Manganese Steel, 311
- Batavia, Zoological Station at, 376
- Bateson (Anna) and Prof. Francis Darwin, F.R.S., on the Effect of certain Stimuli on Vegetable Tissues, 429
- Bathy-orographical Chart of the Clyde Sea-Area, 334
- Batten (Dr. Rayner W.), Physical Training of Girls, 495
- Battery, Water, Henry A. Rowland, 452
- Bauxite Deposits in the South-East of France, on the Age of the, 383; M. L. Collot, 288
- Beam-Trawling, Fishery Board of Scotland and, 257
- Beaumont (W. Worby), Sounding a Crater, Fusion-Points, Pyrometers, and Seismometers, 296
- Beaver stated to be extinct in Northern Norway, 112
- Beckley (Mrs. E. M.), Hawaiian Fishing-Implements and Methods of Fishing, 327
- Béclard (Prof.), Statistics of the Number of Female Medical Students in Paris, 306; Death of, 375
- Becquerel (Edmond), Action of Manganese on Phosphorescent Quality of Carbonate of Lime, 168
- Beds of Chert in the Carboniferous Limestone of Yorkshire, on the Character of the, Geo. J. Hinde, 582
- Bee, Cell of the Honey-, Geometrical Construction, Prof. H. Hennessy, F.R.S., 502
- Bee-hives discovered in a Gigantic Eucalyptus-Tree in Australia, 423
- Beeby (W. H.), Flora of Shetland, 474
- Beetle in Motion, the, 29; Prof. C. Lloyd Morgan, 7; A. Wilkins, 414
- Beetroot, on the Destruction of Nematodes, 455
- Beetroot-Sugar, Production of, in the U.S., 351
- Begonia Fitchii*, Abnormal, 430
- Beira Alta, Earthquake in District of, 59
- Belgium, Ornithological Observations in, 423
- Bell (Louis), on the Absolute Wave-length of Light, 524
- Belladonna and Opium, Action of, in a Case of Acute Diabetes, 407
- Bengal, Eastern, Letters on Sport in, Frank B. Simson, 388
- Bengalis, Use of, in the Geological Survey of India, H. B. Medlicott, 472
- Ben Nevis Observatory, 517; Amount of the Rainfall at, 257; Rainband Observations at the, A. Rankin, 588
- Benn (T. G.), the Climate of Carlisle, 95
- Bennett (Alfred W.), Genetic Affinities and Classification of the Algae, 478
- Bentham (Geo., F.R.S.), Hand-book of the British Flora, 341
- Bentley (Prof.), Manual of Botany, 350
- Benzonoid Compounds, Henry Armstrong, F.R.S., 407
- Bérésófsky (M.), MM. Potanin, Skassy, and, Return of, from their Expedition to China and Mongolia, 309
- Beri-beri, the Disease, 206
- Berlin: Academy of Sciences, Grants for Zoological Research, 473; Proceedings of Anthropological Society, 496; Chemical Society of, 552; Opening of Ethnological Society, 180; Geographical Society, 60; Verhandlungen of the, 520; Meteorological Society of, 24, 71, 360, 455; Physical Society of, 24, 72, 264, 336, 408, 432, 456, 552, 600; Physiological Society, 264, 383, 455, 480, 504, 551, 576
- Bert (Paul): Obituary Notice of, 54; Proposed Memorial of, 84; First Year of Scientific Knowledge, 221; One of his Last Letters, 255
- Berthelot (M.): on Ammoniac-Magnesian Phosphate, 119; on the Direct Fixation of the Gaseous Nitrogen of the Atmosphere by Vegetable Soils, 335
- Berthelot and André, the Decomposition of Bicarbonate of Ammonia by Water, and Diffusion of its Components through Atmosphere, 23
- Bialoveski (A.), Ice-Period on the Altai Range, 513
- Bianchi (V.), the Avifauna of the Western Spurs of the Pamir Plateau, 328
- Bicarbonate of Soda, Production of, 624
- Bichloride of Copper, Combination of Orthotoluidine and, 383
- Bichromate of Soda Cell, 381
- Bicycles and Tricycles for the Year 1886, H. H. Griffen, 52
- Bidwell (Shelford): Electrical Resistance of Suspended Copper and Iron Wires, 526; Lecture Experiment in Self-Induction, 526
- Bigourdan (M.), Minor Planet No. 265, 474
- Biobites, Striated, 407
- Binary Stars: γ Coronæ Australis, H. C. Wilson, 17; δ Equulei, 401; Orbit of the Binary Star 14 (γ) Orionis, J. E. Gore, 569; Brightness and Mass of Binary Stars, W. H. S. Monck, 402
- Biology: Proposed Biological Societies for London and Liverpool, 180; W. Baldwin Spencer appointed to the Melbourne University Chair of, 280; General Biology, W. T. Sedgwick and Edmund B. Wilson, 413; Injurious Fungi in California, 521; Fertilisation of *Cassia maritima*, 521; Variations in the Nerve-Supply of the Lumbricales Muscles in the Hand and Foot, with some Observations on the Perforating Flexors, 521; Biological Notes, 521; Elementary Practical Biology—Vegetable, Thos. W. Shore, 556
- Birch (G. J.), on a Perspective Microscope, 358
- Bird (Charles), Lecture Notes and Problems on Sound, Light, and Heat, 52
- Birds: Siberian, presented by Mr. Seebohm to Natural History Museum, 15; Dispersion of Plants by Birds, D. Morris, 151; Birds of Suffolk, Dr. Churchill Babington, 193; the Gould Collection of Australian Birds at Philadelphia, 204; the Birds of Central Asia, 204; Types of Birds in the Vienna Natural History Museum, 204; Arctic Species of, Henry Seebohm on, 256; Morphology of, Prof. W. K. Parker, F.R.S., 331; Mechanism of the Flight of Birds, studied by Chronophotography, M. Marey, 335; Morphology of the Wings of, 599; Movement of a Bird's Wing, represented according to the Three Dimensions of Space, M. Marey, 382; Birds' Nests and Eggs, H. Seebohm, 236
- Birmingham, Mason Science College, 494
- Birnbaum (Dr.), Death of, 444
- Birth-rate, on the Decline of, in France, 357
- Bischoffsheim Observatory, the Great Refracting Telescope of the, 84
- Bishop's Ring in Colorado, Disappearance of, G. H. Stone, 581
- Black (Dr. W. J.), Ozone Papers in Towns, 76
- Blake (Dr. James), on the Connexion between Chemical Constitution and Physiological Action, 6
- Blanford (Henry F.), Low Barometric Readings, 344
- Blaschko (Dr.), Structure of the Epidermis, 551
- Blastoidea, the, Robert Etheridge and P. Herbert Carpenter, 267
- Blight and Mildew on Fruit in the U.S., 422
- Blomefield (L.), Vitality of Seeds, 463
- Blood, Influence of Extremes of Temperature on the Colour of the, 576
- Blue Hill Meteorological Observatory, U.S., 472
- Boas (Dr. Franz), Indian Tribes of British Columbia, 568
- Boehmer (G. H.), Norse Naval Architecture, 445
- Bohemia, Nationalities of, 518
- Boileau (Major-Gen. J. T., F.R.S.), Death of, 57, 84; Proposed Memorial to, 84

- Bois (H. du), Earthquakes, 8
 Bolivia, Thourar's Exploration of, 231
 Bollettino of the Italian Geographical Society, 403, 446
 Bolton (Sir Francis), Death of, 255
 Bolton (Thomas), Civil List Pension to, 204
 Bombay, Technical School at, 206
 Bonney (Prof. T. G., F.R.S.): Volcanic Dust from New Zealand, 56; Volcanic Eruption in Niua-Fu Friendly Islands, 127; Notes on the Structure and Relations of some of the Older Rocks of Brittany, 550; Oldhamia, 581
 Börnstein (Prof.), Investigations into Thunderstorms of July 1884, 24
 Borodin (M. Alexander), Death of, 473
 Borzi, (Prof. A.), *Nostoc elliptosporum*, 594
 Bosanquet (R. H. M.), Determination of Coefficients of Mutual Induction, by means of the Ballistic Galvanometer and Earth Inductor, 478
 Bosovich (Father), Centenary of the Death of, 375
 Boss (Prof.), Comet 1887 d (Barnard, February 15), 424, 446
 Botany: Unpublished Drawings by G. J. Camelli, 34; British Fungi, Hymenomyces, Rev. John Stevenson, 4; Autumnal Flowering, Dr. Maxwell T. Masters, 11; Botanical Lecture Experiment, Prof. Bayley Balfour, 126; *Rogeria longiflora*, 158; *Entyloma Ranuncul.*, Prof. H. M. Ward, 166; Hermann's "Ceylon Herbarium" and Linnaeus's "Flora Zeylanica," Dr. H. Trimen, 166; Narcissi, G. Maw, 166; Botany of the Afghan Delimitation Commission, W. Botting Hemsley, 173; the Honro Usufu work on Botany, 204; Native Plants of South Australia, 205; Botanical Federation in the West Indies, D. Morris, 248; Baron von Mueller on the Acacias (Wattles) of Australia, 282; Hand-book of the British Flora, Geo. Bentham, F.R.S., 341; the Crocus, Geo. Maw, 348; Manual of Botany, Prof. Bentley, 350; Report on the Botanical Garden, Saharanpur, Mr. Duthie, 356; Botanical Discoveries in the Tombs of Egypt, 405; Blight and Mildew in the U.S., 422; *Begonia Fitchii* abnormal, 430; Lemons irregularly developed, 430; *Primula imperialis*, 430; Wild White Daffodil, 430; Addition of a Commercial Laboratory to the Botanical Museum of Hamburg, 473; Dr. Urban's Proposed Botanical Investigation of the Higher Mountains of St. Domingo, 494; Thos. Moore's Botanical Collections acquired for the Herbarium, Kew Gardens, 495; on some Observations on Palaeobotany in Goebel's "Outlines of Classification and Special Morphology of Plants," Prof. W. C. Williamson, F.R.S., 535; Botanic Garden of Glasgow, 545; Hand-book of Practical Botany for the Botanical Laboratory and Private Student, Prof. E. Strasburger, 556; on the Term "Latex" in, M. A. Trécul, 600
 Bouinai (A.) and A. Paulus, La France en Indo-Chine, 221
 Bourgeois (M. L.), Preparation of a Silicostannate of Lime corresponding to Sphene, 335
 Bourne (G. C.), Anatomy of the Madreporian Coral Fungia, 404
 Boys (C. Vernon): Preliminary Note on the Radio-Micrometer, 549; on the Production, Preparation, and Properties of the Finest Fibres, 575
 Brain: Prof. T. Jeffery Parker, 208; on the Nomenclature of the, Dr. Wilder, 255; Functional Topography of the, Prof. Ferrier, F.R.S., 453
 Braun (Dr. C.): Kaloesa Observatory, 59; Sunspot Observations in Hungary, A. M. Clarke, 227
 Brazil: Longitudes in, Admiral E. Mouchez, 100; the Birds of, 204
 Bredichin (Prof. Th.), Tails of the Comets of 1886, 474
 Bright (Sir Chas. T.), Electric Telegraph, 282
 Brines, on Ice and, J. Y. Buchanan, 608
 Bristol University College, Reduction of the Salaries of the Professors, 326; Albert Fry on, 345
 Britain, Natural History, its Rise and Progress in, Prof. Alleyne Nicholson, 148
 Britain, South-East, on the Establishment of the Roman Dominion in, Sir G. B. Airy, F.R.S., 562
 British Association and Local Scientific Societies, 78; Principal Officers for the Manchester Meeting, 471
 British Columbia, Indian Tribes of, Dr. Franz Boas, 568
 British Flora, Hand-book of the, Geo. Bentham, F.R.S., 341
 British Fossils, Catalogue of, Prof. Morris's, 158
 British Fungi, Hymenomyces, Rev. John Stevenson, 4
 British Fungi, Text-book of, W. D. Hay, 364
 British International Polar Expeditions, 147
 British I-lands, Coleoptera of the, Rev. W. W. Fowler, 531
 British Medical Journal, Dr. Rayner W. Batten on Physical Training of Girls, 495
 British Museum, Catalogue of Fossil Mammalia in the, Rich. Lydekker, 532
 British Stalk-eyed Crustacea and Spiders, F. A. A. Skuse, 532
 Brittany, Notes on the Structure and Relations of some of the Older Rocks of, Prof. T. G. Bonney, F.R.S., 550
 Broeck (E. Van den) and A. Rutot, Observations nouvelles sur le Tufeau de Ciplly and sur le Crétacé supérieur du Hainault, 317
 Brooks, Comet (1887 b), Dr. Rud. Spitaler, 352, 424, 406
 Brouardel (M. J.), elected Dean by the Medical School of Paris, 422
 Brown (J.), Theory of Voltaic Action, 142
 Brown (J. Allen), Discovery of Palaeolithic Workshop Floor of Drift Period near Ealing, 189; Palaeolithic Man in North-West Middlesex, 554
 Brown-Séguard (Dr.), Experimental Researches connected with Cerebral Functions, 47; elected President of the Society of Biology, Paris, 544
 Bruce (Eric S.), War and Ballooning, 259
 Brunton (T. Lauder, M.D., F.R.S.): Action of Caffein and Theine upon Voluntary Muscle, 599; and J. Theodore Cash, Contributions to our Knowledge of the Connexion between Chemical Constitution and Physiological Action, Preliminary Communication on the Action of certain Atomic Bodies, 599
 Brushes, on Two Jade-handled, Prof. J. P. O'Reilly, 318
 Brydges (Rev. Thos.), Curious Subdivision of Colour among the People of Onisin, 283
 Buchanan (J. Y.): Similarities in the Physical Geography of the Great Oceans, 33, 76; on the Distribution of the Temperature in the Antarctic Ocean, 516; on Ice and Brines, 608
 Buckland Museum, Fish-Hatching at, 400
 Buckton (G. B., F.R.S.), Notes on the Recent Swarming of Aphides, 15
 Budden (Dr. E.), To prove that only One Parallel can be drawn from a given Point to a given Straight Line, 92; Prof. O. Henrici, F.R.S., 100
 Buildings Bill, Sanitary Registration of, 282
 Bulletin de l'Académie des Sciences de St. Pétersbourg, 286, 310, 356
 Bulletin of the Belgian Natural History Museum, 423
 Bulletin de l'Académie Royale de Belgique, 404
 Bulletin of the Paris Geographical Society, 353
 Bulletins de la Société d'Anthropologie de Paris, 286
 Bulletins des Sciences Mathématiques, 452
 Bunge (Dr.), Success of his Expedition, 309
 Burch (Dr. Geo. J.), Further Experiments on Flame, 165
 Burgess (William), Red Worm, 445
 Burmah, Lower and Upper, Resources of, 378
 Butler (Philip J.), Lung-Sick, 54
 Butterflies of India, Lionel de Nicéville, H. J. Elwes, 436
 Cacciatore (Prof.), Barnard's Comet, 181
 Caddy (Mrs. Florence), Through the Fields with Linnæus, 579
 Cadmium, Chloride of, 551
 Cæcilians, Classification of the, 280
 Caffein, Action of, and Theine upon Voluntary Muscle, T. Lauder Brunton, F.R.S., 599
 Cairo: Earthquake at, 112; Walks in, Major E. T. Plunkett, 256
 Calcium, Phosphorescence of the Sulphuret of, 455
 Caldwell (W. H.), Embryology of Monotremata and Marsupialia, 524
 Calendar and General Directory of the Science and Art Department, 320
 Calico-Printing, the Palissy of, the Life and Labours of John Mercer, F.R.S., Edward A. Parnell, Prof. T. E. Thorpe, F.R.S., 145
 California: Injurious Fungi in, Prof. W. G. Farlow, 521; Floods in Southern, 376; Aboriginal Art in California and Queen Charlotte's Island, Dr. W. J. Hoffman, 285
 Calorimetric Bomb and Measurement of Heats of Combustion, 551
 Calorimetric Studies on Sick Children, 528

- Cambridge: Pinnosophical Society, 167, 454; Cholera Fungus, Dr. E. Klein, F.R.S., 171, 295; Chas. Roy, 223; Walter Gardiner, 271, 319; George Massee, 319; Edgar Crookshank, 344; on the Earlier Tripos of the University of Cambridge, Sir G. B. Airy, F.R.S., 397; University Local Examination Report, 494; University Local Lectures, 544
- Camelidae, the Phylogeny of the, 568
- Camelli (G. J.), his Collection of Drawings of Plants, 34
- Cameron (William), Death of, 180
- Cameron (Capt.), Lecture on Urua, 259
- Cameroons Territory, Estimate of the Native Population in the, 354
- Canadian Plants, Catalogue of, Prof. J. Macoun, 350
- Canadian Species, Hand-book of Zoology, with Examples from, Sir J. W. Dawson, F.R.S., 295
- Canal and River Engineering, David Stevenson, Major Allan Cunningham, 169
- Cannibalism and its Prevalence in Ancient and Modern Times, Richard Andree, 350
- Canoe, Discovery of a Prehistoric, 423
- Capacity, Specific Inductive, Note on, John Hopkinson, F.R.S., 334
- Cape Boxwood, 444
- Cape Horn, Temperature of, 568
- Carbon, on the Action of the Chloride of, on the Anhydrous Oxides, M. Eug. Demarçay, 288
- Carbonic Acid in the Ground, 230; in the Air, 406
- Carey (A. D.), his Journey in Central Asia, 475
- Carlisle, the Climate of, T. G. Benn, 95
- Carp, German; Impartation of, 16; the Acclimatisation of, 58
- Carpenter (Dr. P. Herbert, F.R.S.): the Supposed Myzostoma-Cysts in *Antedon rosacea*, 535; and Robert Etheridge, F.R.S., on the Blastoida, 267
- Carr (G. S.), Elementary Results in Pure Mathematics, 292
- Carroll (Lewis), To find the Day of the Week for any given Date, 517
- Cartailhac (M.), the Human Bones found in Quaternary Caverns in France, 23
- Cartailhac (M. Emile), Les Ages préhistoriques de l'Espagne et du Portugal, 244
- Carter (August), Deformities among Fish, 230
- Carter (W. A.): the Axolotl *in sicco*, 16; Marine and Fresh-water Fishes, 472
- Casey (John), a Sequel to the First Six Books of the Elements of Euclid, containing an Easy Introduction to Modern Geometry, 28
- Cash (J. Theodore) and T. Lauder Brunton, F.R.S., Contributions to our Knowledge of the Connexion between Chemical Constitution and Physiological Action, Preliminary Communication on the Action of certain Aromatic Bodies, 599
- Cassagnes (G. A.), Steno-telegraphy, 192
- Cassia marilandica*, Fertilisation of, 521
- Cassiopeiaz, Prof. Colbert, 59
- Castilloa Rubber-tree of Central America, 142
- Catchpool (Edmund), Origin of Species, 76
- Cats with an Abnormal Number of Toes, Observations on Heredity in, Edward B. Poulton, 38; William White, 125; J. Herbert Hodd, 53; Dr. H. A. Hagen, E. W. Claypole, 345
- Caves, Prof. T. McKenny Hughes, 454
- Cecidomyia destructor* and Barley, Miss Eleanor Ormerod's Observations on, 256
- Cecil (Henry), Tabasheer, 437
- Celestial Motions, W. T. Lynn, 350
- Celestine, Recently-discovered Deposit of, H. G. Madan, 391; R. H. Solly, 414
- Cell, Bichromate of Soda, 381
- Cell of the Honey-bee, Geometrical Construction of the, Prof. H. Hennessy, F.R.S., 502
- Cells, Dry Portable, 331
- Censuses of France and Germany, Results of New, 281
- Centenary of the La Pérouse Expedition round the World, 443
- Centennial Exposition, New Orleans, Educational Exhibits and Conventions at the World's Industrial and Cotton, 245
- Centralblatt für Physiologie, 612
- Ceratohelys sthenurus* from Lord Howe's Island, Australia, Preliminary Note on the Fossil Remains of a Chelonian Reptile, Prof. Thos. H. Huxley, F.R.S., 615
- Cerebral Functions, Experimental Researches connected with, Brown-Séguard, 47
- Cerebral Localisation, Prof. E. A. Schäfer, F.R.S., 438, 464
- Ceylon: Tea-Planting in, T. C. Owen, 268; the Veddas of, 205
- Chaetopoda of the Firth of Forth, 544
- Chaffajon (M.), Exploration of the Orinoco, 446
- Chagos Archipelago Birds, Dr. Otto Finsch, 497
- Chalande (M. J.), Respiration in Myriapods, 288
- Chaldica, Metals and Minerals from, 359
- Chaleur rayonnante, Sur une nouvelle Méthode de faire des Mesures absolues de la, Knut Ångström, 580
- Chalk beneath the London Clay of the London Basin, on the Water in the, Robert B. Hayward, F.R.S., 335
- Challenger Expedition: Zoological Results of the, 49; Report of the Scientific Results of the Exploring Voyage of the, 351
- Chancourtois (M.), Death of, 57
- Chandler (S. C.): New Variables, 307; the New Algol-Type Variable, 329
- Charleston Earthquake: Report on the, Prof. T. C. Mendenhall, 31; Influence upon the Health of the Inhabitants, 281; Capt. Dutton's Report on, 351
- Charts, Atlantic Weather, 469
- Chauveau (A.), Action of Glycose in Development of Animal Heat, 291
- Chelonian Reptile, Preliminary Note on the Fossil Remains of a *Ceratohelys sthenurus*, from Lord Howe's Island, Australia, Prof. Thos. H. Huxley, F.R.S., 615
- Chemistry: Chemical Constitution and Physiological Action, Connexion between, Dr. James Blake, 6; the Decomposition of Bicarbonate of Ammonia by Water and Diffusion of its Components through Atmosphere, Berthelot and André, 23; on Atomic Weight of Oxide of Gadolinium, A. E. Nordenskjöld, 47; Chemical Society, 70, 143, 358, 384, 407, 453, 503, 526; Anniversary Meeting of the, 536; M. Moissan's Researches on Isolation of Fluor, 71; Chemical Arithmetic, Sydney Lupton, 74; Experimental Chemistry, C. W. Heaton, 74; Chemical Physics, Prof. Josiah Parsons Cooke's, 100; Action of Manganese on the Phosphorescent Quality of Carbonate of Lime, Edmond Becquerel, 168; Old or New Chemistry, Which is Fittest for Survival? Samuel Phillips, 270; a Treatise on Chemistry, Sir H. E. Roscoe and C. Schorlemmer, 316; Principle of Maximum Labour and the Laws of Chemical Equilibria, 382; on the Coefficients of Chemical Affinity, 455; Recent Progress of Chemical Science, Dr. Hugo Müller, 536; Chemical Action of Light on Mixed Hydrogen and Chlorine Gas, Dr. Pingsheim, 552; a Question for Chemists, Wm. West, 584; Chemical Constitution and Physiological Action, Contributions to our Knowledge of the Connexion between, Preliminary Communication on the Action of certain Aromatic Bodies, T. Lauder Brunton, F.R.S., and J. Theodore Cash, 599
- Chert, on the Character of the Beds of, in the Carboniferous Limestone of Yorkshire, Geo. J. Hinde, 582
- Chevrel (M.), Medal presented to, 144; Resignation of his Membership of the Academy of Sciences, 255
- Chicago Manual Training School, 444
- China: Folk-Lore of, J. H. Stewart Lockhart, 281; Return of MM. Potanin, Skassy, and Bérésowsky from their Expedition to China and Mongolia, 309; Early Chinese Intercourse with America, Dr. W. H. Dall, 58; Best Mode of conveying Scientific Knowledge to the Chinese, 112; a Work on Anatomy in Chinese, 568; Animal Worship amongst the Chinese, 613
- Chinook Winds, M. W. Harrington, 568
- Chios, Earthquake at, 112, 158
- Chlorochromic Acid and the Phosphates of Sesquioxide, on the Action of Tetrachloride of Carbon on, M. H. Quantin, 335
- Cholera Fungus, Cambridge, Dr. E. Klein, F.R.S., 171, 295; Chas. Roy, 233; Walter Gardiner, 271, 319; George Massee, 319; Edgar Crookshank, 344
- Christiania Society of Science, 336
- Christie (W. H. M., F.R.S.), the Earthquake, 462
- Chrysalides, Gilded, Edward B. Poulton, 470
- Church (A. H.), Food-Grains of India, Prof. John Wrightson, 51
- Cider, on the Composition of the Ashes of, M. G. Lechartier, 382
- Cinnabar, Gold, and Associated Sulphides, Natural Solutions of, 524
- City and Guilds of London Institute, Distribution of Prizes, 158; *Conversations*, 494

- Claim of Priority, a, V. Ventosa, 513
 Clarke (Dr. Hyde), *Svaatika* Cross and Sun, 366
 Clarke (J. Edwards), Industrial and High Art Education in the United States, W. Odell, 97
 Classification of the Cæcilians, 280
 Clausius's Characteristic Equation for Substances applied to Messrs. Ramsay and Young's Experiments on Alcohol, Prof. William Ramsay and Dr. Sydney Young, 262, 346; Prof. Fitzgerald, 574
 Clayden (A. W.), on the Internal Capacity of Thermometers, 94
 Claypole (E. W.), Abnormal Cats' Paws, 345
 Cleland (Prof. John), Culminating Sauropsida, 391
 Clerke (A. M.): Sunspot Observations in Hungary, Carl Braun, 227; *Aurora Borealis*, M. S. Lemström, 433; Dr. K. R. Koch, 433; Homeric Astronomy, 585, 607
 Clifford (W. K., F.R.S.), Lectures and Essays, 270
 Climate of Northern Europe and the Gulf Stream, 91
 Climatology of the Croydon District, 14
 Clocks, Electricity and, T. Wilson, 173; Prof. Silvanus P. Thompson, 224; H. Dent Gardiner, 198, 231; "Horloge" on, 438
 Cloez (M. Ch.) and M. E. Grimaux, Erythrene, 288
 Cloud Knowledge, Modern Developments of, Hon. Ralph Abercromby, 575
 Clouds: Aspects of, Robert James Reilly, 391; on the Forms of, A. F. Osler, F.R.S., 164; Iridescent, Jas. C. McConnel, 533; G. H. Stone, 581; Nomenclature of, 406
 Clyde Sea-Area, Bathy-ographical Chart of the, 334
 Coahuila Meteorites, O. W. Huntington, 451
 Coal, on the Age of, found in the Region traversed by the Rio Grande del Norte, 380
 Coal-Dust Theory, W. Galloway, 222, 296, 343
 Coal-Mines, Explosions in, W. N. and J. B. Atkinson, Prof. T. E. Thorpe, F.R.S., 1
 Coasts of North Africa, Study of the, Dr. Theobald Fischer, 353
 Cobra, Death from the Bite of a, 111; Supposed Suicide of the, R. D. Oldham, 560
 Cochenille at Rodriguez, 179
 Cockroach, Structure and Life-History of the, L. C. Miall, 365
 Coco de Mer (*Lodoicea seychellarum*), Gen. Gordon's Collection illustrative of the, presented to Kew Gardens, 494
 Cod, Curious Knife found in the Thick Flesh of a, 545
 Cod-Fisheries (Norwegian), Japanese Mission to inquire into the, 158
 Codices, Mexican, Z. Nuttall, 307
 Coefficient of Mutual Induction of Two Coils, Method of measuring, Prof. G. Carey Foster, F.R.S., 143, 478
 Coefficient of Self-Induction, on the Determination of the, 551
 Coils, Inductionless, Dr. Aron, 383
 Coils, Method of measuring the Mutual Induction of Two, 478
 Colbert (Prof.), ζ Cassiopeie, 59
 Colchicine, Properties of, 408, 432
 Coleoptera, New Zealand, David Sharp, 177
 Coleoptera of the British Islands, Rev. W. W. Fowler, 531
 Colin (Dr.), on the Population of Bambouk, 22
 Collections, National Science, 252, 272
 College of France, proposed Enlargement of the Buildings of the, 517
 College of Physicians, Edinburgh, proposed Establishment of a Laboratory for the Prosecution of Original Research, 399
 Colleges, University, Prof. Jowett, 441
 Collins (F. Howard): Herbert Spencer's Definition of Life, 487; Vitality and its Definition, 580
 Collot (M. L.), on the Age of the Bauxite Formation in the South-East of France, 288
 Colocasia, Disease of, in Jamaica, 478
 Colonial Conference, Sir Henry Holland, 544
 Colonial and Indian Exhibition, John R. Jackson, 16, 81, 225
 Colonial Science and Art Schools and the Department of Science and Art, 442
 Colorado, Disappearance of Bishop's Ring in, G. H. Stone, 581
 Colorado, Phenacite from, Sam. L. Penfield, 451
 Colour of the Blood, Influence of Extremes of Temperature on the, 576
 Colour-Hearing, 613
 Colour-Mixing Apparatus, Von Kries, Dr. König, 336
 Colourless Specimens of Plants to be preserved in Alcohol, how to make, Prof. Hugo de Vries, 149; Selmer Schönland, 173
 Colours of Metals and Alloys, Prof. W. Chandler Roberts-Austen, F.R.S., 106
 Colours, a Method of illustrating Combinations of, H. G. Madan, 513
 Colson (M. Albert), Erythrite, 288
 Colton (B. P.), Practical Zoology, 458
 Comets: Barnard's, 59; T. W. Backhouse, 54, 224; Prof. Cacciatore, 181; Dr. Wentworth Erck, 198; Prof. A. Riccò, 296; (1886 *f*), 17, 207; Dr. Oppenheim, 85; Dr. Aug. Svedstrup, 134; (1887 *c*), Prof. E. Weiss, 352; Dr. H. Oppenheim, 424; 1887 *d* (Barnard, February 15), Prof. Boss, 424, 446; First and Second of 1887, 614; Second of 1887, John I. Plummer, 583; Brooks (1887 *b*), 352; Dr. R. Spitaler, 424, 496; Finlay's 1886 *e*, 17, 59; Dr. Krueger, 85, 134; Dr. J. Holetschek, 207; Three New Comets, 307; Note on the Origin of Comets, 381; Discovery of a New, 1887 *d* (Barnard 2), 402; Tails of the Comets of 1886, Prof. Th. Bredichin, 474; the Southern, 329, 438; Comets and Asteroids, Prof. Daniel Kirkwood, 474
 Commercial Organic Analysis, Alfred H. Allen, Dr. C. R. Alder Wright, 293
 Compass in Iron Ships, Deviation of the, considered practically, W. H. Rosser, 473
 Compressed Air, Transmission of Power by, 272
 Conchology, J. C. Melvill on *Conus gloria maris*, 230
 Conder (Capt.), Translation of Hittite Inscriptions, 422
 Congo: Dr. Lenz's Exploration of, 232; his Map of the, 354; Rev. Geo. Grenfell's Exploration of the, 596; H. M. Stanley's, 615
 Conics, Pencils of, 477
 Connecticut Valley, Triassic Formation of the, 141
 Constant of Aberration, New Method of determining the, M. Læwy, 263, 282, 407, 424, 431, 454, 479; M. Houzeau, 377
 Constants of Fluids, Dielectric, Prof. G. Quincke, 334
 Constitution of Matter, on certain Modern Developments of Graham's Ideas concerning the, Prof. T. E. Thorpe, F.R.S., 522, 547
 Continuity of the Liquid and Gaseous States of Matter, Preliminary Note on the, William Ramsay and Sydney Young, 262
Conus gloria maris, J. C. Melvill on, 230
 Cooke's (Prof. Josiah Parsons) Chemical Physics, 100
 Coombe Rock, Clement Reid on, 502
 Copper, the Higher Oxides of, 141
 Coral Reefs of the Solomon Islands, Dr. H. B. Guppy, 77
 Corea, Geology of, 518
Coregonus albus, American Whitefish at Burghley Park, 546
 Corona, Extension of the, Prof. S. P. Langley, 52
 Counterpoint, Harmony and, Elements of, F. Davenport, 339
 Cranial Nerves of a Human Embryo, 336
 Crater, Sounding a, Prof. John Milne, 152; Fusion-Points, Pyrometers, and Seismometers, Dr. H. J. Johnston-Lavis, 197; W. Worby Beaumont, 296
 Crayfish, Fresh-water, Green Gland of, 455
 Crimson Line of Phosphorescent Alumina, on the, William Crookes, F.R.S., 310
 Critical Temperatures of Nitrogen and Oxygen, 331
 Crocus, the, George Maw, 348
 Crommelin (A. C.), Invisible at Greenwich, 414
 Crookes (William, F.R.S.): on the Crimson Line of Phosphorescent Alumina, 310; on Radiant-Matter Spectroscopy, Examination of the Residual Glow, 425, 447
 Crookshank (Dr.), Flagellated Protozoa in Animals' Blood, 191
 Crookshank (Edgar), Cambridge Cholera Fungus, 344
 Cross as a Sun Symbol, Dr. Chas. R. Dryer, 345
 Croydon District, Climatology of the, 14
 Cruise of the *Marchisot*, F. H. H. Guillemand, 369
 Cruls (M.), Geographical Co-ordinates of Punta-Arenas, 382
 Crustacea of Singapore, 525
 Crustacea, British Stalk-eyed, and Spiders, F. A. A. Skuse, 532
 Cryptogams, Flora of Leicestershire, including the, J. G. Baker, 411
 Crystalline Elliptically-polarising Media, on Reflection at the Surface of, 333
 Crystallographic Notes, 141
 Crystals, Absorption of Light in, 312
 Culminating Sauropsida, Prof. John Cleland, 391

- Cunningham (Prof.), the Lumbar Curve in Man and Apes, 46
 Cunningham (Major Allan): Canal and River Engineering, David Stevenson, 169; Hydraulic Power and Hydraulic Machinery, H. Robinson, 460
 Current Sheets, on Ellipsoidal, Horace Lamb, F.R.S., 574
 Currents, North Atlantic, Experiments made to determine the Direction of the, Prince Albert of Monaco, 288
 Curvature, Critical Mean of Liquid Surfaces of Revolution, Prof. A. W. Rucker, F.R.S., 143
 Curve, Lumbar, in Man and Apes, Prof. Cunningham, 46
 Curves, Traube-Hering, 576
 Cutting of Polarising Prisms, on the, Prof. Silvanus P. Thompson, 184
 Cycling Budget, 231
 Cyclones, on the Relation between Tropical and Extra-Tropical, Hon. Ralph Abercromby, 430
 Cyclones and Concurrent Storms and Hurricanes, on the Relations that exist between, M. H. Faye, 599
 Cyclonic Storms, Central Calm in, 575
 Cyclonic Theories, Atmospheric Movements in Connexion with, 527
 Cygnus, New Variables in, Dr. Gould, 282
 Cypripedium, Peculiar Conformation of the Flowers of, Dr. Maxwell Masters, 142
- Daffodil, Wild White, 430
 Dalarlia, Central Sweden, Brilliant Meteor seen in, 495
 Dall (Dr. W. H.), Early Chinese Intercourse with America, 58
 Dallinger (Rev. Dr., F.R.S.), Changes of Temperature to which the Lower Forms of Organisms can be adapted by Slow Modifications, 550
 Dana (Jas. D.): Revelations of a Dissected Volcano, 93; Volcanic Action, 451
 Danger, Rule for Escaping a, Frank Morley, 345
 Darwin (Capt.), Preliminary Account of the Observations of the Eclipse of the Sun at Grenada in August 1886, 287
 Darwin (Prof. Francis, F.R.S.), on the Effect of Certain Stimuli on Vegetable Tissues, 429
 Darwin (Dr. G. H., F.R.S.): on Jacobi's Figure of Equilibrium for a Rotating Mass of Fluid, 188; on the Dynamical Theory of the Tides of Long Period, 287
 Davenport (F.), Elements of Harmony and Counterpoint, 339
 Dawson (Sir J. W., F.R.S.), Hand-book of Zoology, with Examples from Canadian Species, 295
 Day (Dr. Francis): Lochleven Trout, 166; Fish Culture, 282
 Day of the Week for any given Date, to find the, Lewis Carroll, 517
 Decrement, Vertical, of Temperature and Pressure, S. A. Hill, 606
 Definition, Vitality and its, F. Howard Collins, 580
 Deighton (H.), the Elements of Euclid, 269
 Delage (Yves), a New Function of the Otocysts in the Invertebrates, 48
 Demarçay (M. Eug.), on the Action of the Chloride of Carbon on the Anhydrous Oxides, 285
 Démoniaques dans l'Art, Les, 376, 454
 Deniker (J.), Recherches Anatomiques et Embryologiques sur les Singes Anthropoïdes, 509
 Denning (W. F.): Meteor, 101; Meteor of December 28, 1886, 248; April Meteors, 606; Fireball of December 4, 1886, 151
 Denza (P. F.), the Andromedes, November 27, 1886, 231
 Department of Science and Art, Schools of Science and Art in the Colonies and the, 442
 Deposits of Volcanic Dust, Prof. Geo. P. Merrill, 174
 Deprez (Marcel), on the Intensity of the Magnetic Field in Dynamo-Electric Machines, 23
 Dessau (B.), Metal Films arising from the Disruption of a Kathode, 333
 Deutsche Geographische Blätter, 497
 Diabetes, Action of Belladonna and Opium in a Case of Acute, 407
 Diameter of the Sun, Researches on the, Herr Auwers, 496
 Diamonds, Crown, of France, Proposal to sell, 424
 Diastase, Loss of Activity experienced by, under the Action of Heat, 455
 Diatoms, Fresh-water, in the Bagshot Beds, Rev. A. Irving, 101
 Dickins (F. V.), Aino Hairiness and the Urvolk of Japan, 534
 Dielectric Constants of Fluids, Prof. G. Quincke, 334
 Dielectric, Experiment to show that Capacity varies inversely as a Thickness of the, Profs. W. E. Ayrton and John Perry, 526
 Diener (Dr. Carl), the Geology of the Lebanon, Prof. Edward Hull, F.R.S., 10
 Diet in Disease, Prof. G. Sée, 327
 Di-isobutylamine, on the Hydrochlorate and Platinochlorate of, 383
 Dimensions of Physical Quantities, the *Engineer* on, 462
 Dimmock (George), Fish-destroying Insects in the United States, 327
 Disinfection by Heat, B. Strachan, 7
 Dispersion of Plants by Birds, D. Morris, 151
 Ditte (M. A.), Study of the Alkaline Vanadates, 600
 Doberck (Dr. W.): Typhoons, 36; Law of Storms in the Eastern Seas, 135; and the Hong Kong Observatory, 229
 Dodge (Frank S.), Kilauea after the Eruption of March 1886, 451
 Doldrums, Electrical Discharges in the, David Wilson-Barker, 584
 Dolmens of Enfida, 551
 Donnelly (Col. J. F. D.): Normal School of Science and Royal School of Mines, 271; Industrial Studentships, 413
 Dorno (Alessandro), Notice of, 231
 Double Star, Spectroscopic Method of Determining the Distance of a, A. A. Rambaut, 206
 Draper (Andrew S.), Educational System in New York, 445
 Draught and Dust, Permanent Matrix Excluder of, T. J. Porter, 569
 Dryer (Dr. Chas. R.), the Cross as a Sun Symbol, 345
 Dublin, Royal Society of, 311
 Dundee University College, proposed Chair of Anatomy at, 158; proposed Medical School in connection with, 349
 Dunér (M.), Gore's Nova Orionis, 85
 Dungate (E. J.), Lung-Sick, 29
 Dust, Coal-, Theory, W. Galloway, 222, 296, 343
 Dutch Colonies in South America and the West Indies, K. Martin, Dr. A. Ernst, 459
 Duter (M.), Electrolysis of Alkaline Solutions, 382
 Duthie (Mr.), Report on the Botanical Gardens, Saharunpur, 356
 Dutton's (Capt.) Report on the Charleston Earthquake, 351
 Dyer (W. T. Thiselton, F.R.S.): Ipecacuanha Cultivation in India, 227; Tabasheer, 396; a Plant which destroys the Taste of Sweetness, 557
 Dynamical Theory of the Tides of Long Period, on the, G. H. Darwin, F.R.S., 287
 Dynamical Units, Mass, Weight and, Robt. F. Hayward, F.R.S., 604
 Dynamics, Lessons in Elementary, H. G. Madan, 51
 Dynamics of Health and Disease, Life Energy or the, Surgeon-Major Nathl. Alcock, 366
 Dynamo-Building, Practical, for Amateurs, Fred. W. Walker, 294
- Earth's Current in the Telegraph Lines of the German Empire, Dr. Weinstein's Observations, 336
 Earthquakes: Dr. F. A. Forel, 8; H. du Bois, 8; Thos. W. Kingsmill, 319; M. Oppermann on, 600; the Earthquake of February 23, 1887, 419; Rev. S. J. Perry, F.R.S., 438; W. H. M. Christie, F.R.S., 462; the Charleston Earthquake, Report on, Prof. T. C. Mendenhall, 31, 36, 134; Influence upon the Health of the Inhabitants, 281; Earthquake in Beira Alta District, 59; in Switzerland, 84, 205; Prof. Forel, 442; at Cairo, 112; at Chios, 112, 158; Nordheimsund, West Coast of Norway, 158; at Smyrna, 112, 158; Earthquake Shock at Tashkend, 112, 399; at Tchesme, 112; in Sierra Leone, J. S. Hay and Jos. M. Metzger, 141; at Sea, Reginald H. Hertslet, 157; the Recent, Prof. J. P. O'Reilly, 197; at Aquila, 350, 376; in Venice, 350; in Zurich, 350; at Vilayet Konia, Asia Minor, 376; in Japan, 399; Important Points in the History of Earthquake Investigation in Japan, Prof. John Milne, 559; Earthquake in South Eastern Illinois, 444; in South-Western Indiana, 444; in Philiatra, 444; Earthquake of February 23, 551; Note on, at Marseilles Observatory, 455; in Italy, 479; at Antibes, 527; Earthquake Shock felt at Mandalay, 472; Earthquakes in Norway, Dr. Hans Reuch, 517; in the Riviera, Clement

- Reid, 534; in Travnik, 545, 568; in Campfer and St. Moritz, 545; in Stuttgart, 545; in Savona, 545; at Friedau, 568; at Forli, 568; at Aden, 593; at Lisbon, 612; Pre-Scientific Theories of the Causes of, 428; Magnetic Effects of Recent, 479; Earthquakes in Connexion with Fire-Damp, 527; Possible Cause of the Earthquakes of 1755, 1884, and 1887, 528; Sekci Sekiya on the Comparison of, 593
- Earthworms, Australian, J. G. Fletcher, 95
- Eastern Seas, Law of Storms in the, Dr. W. Doberck, 135
- Eclipse of the Sun at Grenada in August 1886, Preliminary Account of the Observations of the, Capt. Darwin, 287; Dr. Arthur Schuster, F.R.S., 549
- Ecuador, Travels in the Wilds of, Alfred Simson, 437
- Edinburgh: Mathematical Society, 71, 191, 454; Royal Society, 191, 311, 454, 479, 551, 599; College of Physicians, 399; Royal Physical Society, 454; Scottish Meteorological Society, 575
- Edison (Mr.), Illness of, 257
- Education: Industrial and High Art, in the United States, J. Edwards Clarke, W. Odell, 97; Association for Promoting a Teaching University in London, 179; Japan Educational Society, 204; the State and Higher Education, 457; Necessity for a Minister of Education, 481; Organisation of Industrial Education, Prof. Huxley, 493; Technical Education, 592; Educational Exhibits and Conventions at the World's Industrial and Cotton Centennial Exposition, New Orleans, 245; Educational System in New York, Andrew S. Draper, 445
- Eels discovered in Masonry, 400
- Eggs, Birds' Nests and, H. Seebohm, 236
- Egypt: Specimens of the Different Strata of Soil in the Delta received from, 111; Botanical Discoveries in the Tombs of, 405
- Eichler (Dr. August Wilhelm): Death of, 443; Obituary Notice of, 493
- Eight Squares, Product of Two Sums of, 455
- Ekaterinburg, Scientific and Industrial Exhibition at, 133, 400
- Elastic Fluid, on the Movement of an Indefinite and Perfectly, 120
- Elasticity, History of the Theory of, Isaac Todhunter, F.R.S., A. G. Greenhill, 313
- Elasticity of Bending of Pure Zinc, Copper, Tin, and their Alloys, 333
- Electricity: Dynamo-Electric Machines, on the Intensity of the Magnetic Field in, Marcel Deprez, 23; Electro-Metallurgy, 57; Electric Conductibility of Vapours and Gases, the, Prof. Giov. Luvini, 85; Electric Charge on the Atom, A. P. Laurie, 131; Electrical Metronome established at the Paris Opera House, 158; an Error in Maxwell's "Electricity and Magnetism," 172; James C. McConnel, 172; Rev. Henry W. Watson, 223; Prof. A. Seydler, 512; Electrical Phenomenon, Thos. Higgin, 173; Electricity and Clocks, T. Wilson, 173; Henry Dent Gardner, 198, 231; Prof. Silvanus P. Thompson, 224; "Horloge" on, 438; Electro-Statics, M. A. Vaschy, 263; Lives of the Electricians, W. T. Jeans, 270; Electric Telegraph, Sir Chas. T. Bright, 282; Latest Industrial Application of Electric Welding, 331; Electromotive Force of the Voltaic Arc, 331; Quadrant Electrometers, 331; Pyro-Electricity of Quartz, B. von Kolenko, 333; Propagation of, in Telegraph-Wires, Ed. Hagenbach, 333; Prize offered to the Inventor of a Cheap Method for the Application of, 350; Spiders and Electric Light, 351; Electrolysis of Alkaline Solutions, M. Duter, 382; Formation of Peroxide of Hydrogen by Electrolysis, Dr. Richarz, 384; Electric Motor and its Applications, T. C. Martin and Jos. Wetzler, Prof. S. P. Thompson, 410; Equatorial Zone of almost Perpetual Electrical Discharge, Hon. Ralph Abercromby, 487; Experiments on Electrical Resistance of Suspended Copper and Iron Wires, Shelford Bidwell, 526; Gas-Lighting by Electricity, 569; Electrical Discharges in the Doldrums, David Wilson-Barker, 584; Train Lighted by Electricity, 595; Note on the Development of Voltaic, by Atmospheric Oxidation, C. R. Alder Wright, F.R.S., 598; Practical Electricity, Prof. W. E. Ayerton, F.R.S., 601; Electric Locomotion, 613
- Elemore Pit, W. Galloway on the Recent Explosion at, 133
- Elephantiasis, Species of, Investigations of, 473
- Ellet (President), Present Position of Science in the Secondary Schools of America, 375
- Elliot (Sir Walter, F.R.S.), Obituary Notice of, 543
- Elliott (Archd. C.), Units of Weight, Mass, and Force, 605
- Elliott (Henry W.), an Arctic Province, 243
- Ellipsoidal Current Sheets, on, Horace Lamb, F.R.S., 574
- Elliptical Integrals, 575
- Ellipticity of Uranus, Prof. W. Valentiner, 614
- Elwes (Capt. H. J.), Butterflies of India, Lionel de Nicéville, 436; Lepidoptera-Heterocera, 503
- Embryogeny of the Anthropoid Apes, J. Deniker, 509
- Embryology of Monotremata and Marsupialia, W. H. Caldwell, 524
- Emin Bey (Dr.): Proposed Expedition for Relief of, 83, 177; Dr. Junker on the Best Route by which to reach him, 258; Mr. Stanley's Expedition, 283, 330, 446, 475; Arrival of Dr. Junker's Caravan, 475; Short Biography of, 497
- Encyclopædia Britannica, 314
- Encyclopædia of Natural Science, Trewend's, 58
- Encyclopædic Dictionary, 485
- Encyclopædie der Wissenschaften, 593
- Endowed Schools Committee, Report of, 611
- Endowment of Medical Research, 409
- Enfida, Dolmens on, 551
- Engelhardt's (Baron D'), Observatory, 546
- Engineer, the, on the Dimensions of Physical Quantities, 462
- Engineering, Canal and River, David Stevenson, Major Allan Cunningham, 169
- Engineering Laboratories, on the Use and Equipment of, Prof. Alex. B. Kennedy, 245
- Engineering, Marine, 242
- Engineering: on the Conversion of Heat into Work, W. Anderson, 387; Hydraulic Power and Hydraulic Machinery, H. Robinson, Major Allan Cunningham, 460
- Engler's Botanische Jahrbücher, 405
- English Coasts, Erosion of the, W. Topley, 37
- Entomology: Notes on the Recent Swarming of Aphides, G. B. Buckton, F.R.S., 15; Entomological Society, 70, 191, 335, 453, 503, 623; the Lepidoptera and Hymenoptera of Middlesex, S. T. Klein, 167; Macro-Lepidoptera of East Sussex, J. H. A. Jenner, 230; Miss Eleanor A. Ormerod on the Hessian Fly, 256; Entomologist's Monthly Magazine, 473
- Entropy, Felix Lucas on, 455
- Entyloma Ranunculi, Prof. H. M. Ward, 165
- Eosin Silver, Use of, in Photography, 432
- Epidermis, Structure of the, Dr. Blaschko, 551
- Equatorial Observations of the New Comets, 382
- Equatorial Zone of almost Perpetual Electrical Discharge, Hon. Ralph Abercromby, 487
- Equilibrium of a Fluid Mass, 479
- Equinoctial Gales, Dr. R. Müller, 612
- Erck (Dr. Wentworth): Barnard's Comet, 198; Sunset Phenomenon, 391
- Ernst (Dr. A.), Dutch Colonies in South America and the West Indies, K. Martin, 459
- Erosion of the English Coasts, W. Topley, 37
- Eruption, Volcanic, in Niua-Fu Friendly Islands, Prof. T. G. Bonney, F.R.S., 127
- Eruption of Mount Tarawera, 406, 472; Meteorological Conditions at the Time of the, Capt. F. W. Hutton, 322
- Eruption of March 1886, Kilauca after the, 451
- Eruptions, New Zealand, Red Sunsets and, Lieut.-Col. A. T. Fraser, 224
- Erythrene, MM. E. Grimaux and Ch. Cloez, 288
- Erythrite, M. Albert Colson, 288
- Eskimo, Dr. H. Kink, Prof. A. H. Keane, 309
- Eskimos, some Popular Errors in regard to the, John Murdoch, 518
- Essex Field Club, the, 158
- Essex Naturalist, 545
- Etheridge (Robert, F.R.S.) and P. Herbert Carpenter, the Blastoidæ, 267
- Ethnological Collection presented by Lieut. Quedenfeldt to the Anthropological Society, 423
- Ethnological Collection presented by Gen. Gené to the Ethnographic Museum of Rome, 496
- Ethnological Museum at Berlin, Opening of, 180
- Ethnology: Cannibalism and its Prevalence in Ancient and Modern Times, Herr Richard Andree, 350
- Etiology of Scarlet Fever, E. Klein, F.R.S., 452
- Eucalyptus-Tree, Bee-hives discovered in, 423

- Euclid, a Sequel to the First Six Books of the Elements of, John Casey, 28
- Euclid, the Elements of, H. Deighton, 269
- Euclid Revised, R. C. J. Nixon, 269
- Euclid, Definitions of, with Explanations, R. Webb, 340
- Europe, Northern, Climate of, and the Gulf Stream, 91
- European Prehistoric Races, Prof. A. H. Keane, 564
- Evolution of a Satellite, Tidal Friction and the, James Nolan, 75
- Evolution, Factors of Organic, Herbert Spencer, Dr. Geo. J. Romanes, F.R.S., 362
- Ewing (Prof. J. A.): Seismometry in Japan, 75; on Seismometry, 172; on Seismometers, 606; Magnetisation of Iron in Strong Fields, 622
- Expansion of Solids by Heat, Lecture Experiments on the, H. G. Madan, 89; C. E. Stromeyer, 126
- Experimental Chemistry, C. W. Heaton, 74
- Experimental Science in Schools and Universities, Prof. G. F. Fitzgerald, 284
- Experiments on Flame, Further, Dr. Geo. J. Burch, 165
- Explorations of the North Sea, 73
- Explosion of Meteorites, on the, M. Hirn, 303
- Explosions in Coal-Mines, W. N. and J. B. Atkinson, Prof. T. E. Thorpe, F.R.S., 1
- Extension of the Corona, Prof. S. P. Langley, 52
- Eye, Influence of Astigmatism in the, on Astronomical Observations, Prof. Seeliger, 59
- Falk (Prof.), Peristaltic Movement, 264
- Farlow (Prof. W. G.), Injurious Fungi in California, 521
- Farmer's Crop, Tobacco a, Philip Meadows Taylor, Prof. John Wrightson, 52
- Fauna and Flora of the Afghan Boundary, J. E. T. Aitchison, 381
- Faye (H.): Geodesy and Geology, 71; Movements of the Atmosphere, 455; on the Relations that exist between Cyclones and Concurrent Storms and Hurricanes, 599
- Fayrer (Sir J., F.R.S.), Scorpion Virus, 488
- Feil (M.), Death of, 306
- Feilden (Eliza Whigham), My African Home, 221
- Female Medical Students in Paris, Number of, 306
- Féré (Ch.), Sensation and Movement, 513
- Fernando Norouha, Proposed Expedition to, by H. N. Ridley, 228
- Ferrier (Prof.), Functional Topography of the Brain, 453
- Fertilisation of *Cassia maritima*, 521
- Fewkes (J. Walter): Report on the Medusæ collected by the U.S. Fish-Commission Steamer *Albatross* in the Region of the Gulf Stream, 377; New Rhizostomatous Medusa, 451
- Fibres, on the Production, Preparation, and Properties of the Finest, C. V. Boys, 575
- Ficus, on the Genus, Dr. Geo. King, 525
- Field Club, the Essex, 158
- Field Naturalist in Eastern Bengal, 388
- Fields, through the, with Linnaeus, Mrs. Florence Caddy, 579
- Filtration, Intermittent Downward, Ten Years' Experience in Works of, T. Bailey Denton, 195
- Finland, on the Upheaval of the South-West Coasts of, M. Venukoff, 600
- Finlay, Comet 1886 e, 17, 59; Dr. Krueger, 85, 134; Dr. J. Holetschek, 207
- Fir and Epicea, on the Formation of the so-called "Red Wood" in the, 383
- Fire Symbol, the Svastika as both Sun and, Mrs. J. C. Murray-Aynsley, 558
- Fire-Damp, Earthquakes in Connexion with, 527
- Fireball seen at Stonyhurst College, Blackburn, December 4, 1886, 121, 133; W. F. Denning, 154
- Firth of Forth, Chaetopoda of the, 544
- Fischer (Dr. A.), Death of, 57
- Fischer (Dr. Philip), Death of, 350
- Fischer (Dr. Theobald), Study of the Coasts of North Africa, 353
- Fish; Work of the United States Fish Commission, 54; Deficiencies among Fish, 58, 230; Fish-Culture, 612; in Scotland, 205; Dr. Francis Day on Fish-Culture, 282; National Fish-Culture Association, 350; W. Burgess's Fish-Culture Establishment, 444; an "Egg-bound" Trout, 231; Fishes inhabiting very Deep Waters, M. Léon Vaillant, 288; Fish destroying Insects in the United States, George Diamond, 327; Phosphorescence of Marine Fish, Dr. Otto Hermes, 377
- Fish-hatching at the Buckland Museum, 400; Proposed Investigation of Fish-bearing Properties of Kiu Sawa, 444
- Marine and Fresh-water Fishes, W. A. Carter, 472; Value of Fish landed on the Coasts of Scotland, 473; Proposed Establishment of an Institution for Technical Education with regard to Fish and Fisheries, at Grimsby, 494; Fishes of Ecuador, 502; Tasmanian Fisheries, 233; Fourth Annual Report of the Fishery Board for Scotland, 128; Fishes Board of Scotland and Beam-trawling, 257; Hawaiian Methods of Fishing, Mrs. E. M. Beckley, 327
- Fitzgerald (Prof. G. F.): Experimental Science in Schools and Universities, 284; on the Thermodynamic Properties of Substances whose Intrinsic Equation is a Linear Function of the Pressure and Temperature, 358; Clausius's Characteristic Equation for Substances applied to Messrs. Ramsay and Young's Experiments on Alcohol, 574
- Flame, Further Experiments on, Dr. Geo. J. Burch, 165
- Flat-fish, Acclimatisation of, in American Waters, 473
- Fletcher (J. J.), Australian Earthworms, 95
- Floods in Southern California, 376
- Flora, Hand-book of the British, Geo. Bentham, F.R.S., 341
- Flora of Leicestershire, including the Cryptogams, J. G. Baker, 411
- Flora, Alpine, surviving in the Paris District, 431
- Flora of Shetland, W. H. Beeby, 474
- Florida: Angelo Heilprin on the Geology of, 230; Attempt to sink an Artesian Well at St. Augustine to obtain Hot Water, 376
- Flowering, Autumnal, Dr. Maxwell T. Masters, 11
- Fluid Mass, Equilibrium of a, 479
- Fluid and Electric Agencies, on a Means of increasing the Power of, 120
- Fluids, Dielectric Constants of, Prof. G. Quincke, 334
- Fluor, Moissan's Researches on Isolation of, 71
- Fluorescence, Red, of Alumina, 455
- Fluvial Swamps of New England, 524
- Fog, Map showing the Distribution of, on Various Parts of the Earth, 423
- Folk-Lore Society established in the Philippines, 134
- Folk-Lore of China, J. H. Stewart Lockhart, 281
- Folkestone Gault, C. E. De Rance, 296
- Fontannes (C. F.), Death of, 254, 263
- Fonville (W. de), La Mesure du Mètre, 388
- Food-Grains of India, A. H. Church, Prof. John Wrightson, 5
- Force, Units of Weight, Mass, and, Rev. Edward Geoghegan, 534; Prof. Alf. Lodge, 557; Archd. C. Elliott, 605
- Forel (Dr. F. A.): Earthquakes, 8; Earthquake in Switzerland, 442
- Forcrand (M. de), Glycerinate of Potassa, 268
- Forms of Clouds, on the, A. F. Osler, F.R.S., 164
- Forsyth (Sir Douglas), Death of, 179
- Fossil Mammalia in the British Museum, Catalogue of, Richard Lydekker, 532
- Fossil Meteorite found in Coal, a, Dr. Guret, 36
- Fossil Remains of a Chelonian Reptile, *Ceratochelys sthenurus*, from Lord Howe's Island, Australia, Preliminary Note on the Prof. Thos. H. Huxley, F.R.S., 615
- Foster (Prof. G. Carey, F.R.S.), on a Method of measuring the Coefficient of Mutual Induction of Two Coils, 143
- Fowler (Rev. W. W.), Coleoptera of the British Islands, 531
- France en Indo-Chine, La, A. Bouinain and A. Paulus, 221
- France: Result of New Census of, 281; Madagascar and, 306 the Depopulation of, 357; French Translation of Freyer's Physiology of the Embryo, 376; Number of Foreigners in France, 400; Inauguration of Railways in, 407; Proposal to sell the Crown Diamonds of, 424; Meeting of the French Congrès de Chirurgie in Paris, 444; Oyster-Culture in, 493
- Enlargement of the Buildings of the College of France, 517
- Frankland (G. C., and Dr. Percy), some New Micro-organisms obtained from Air, 477
- Frankland (Dr. P. F.), a New Method for the Quantitative Estimation of Micro-organisms in Atmosphere, 183
- Franklin Institute, State Weather-Service for Pennsylvania to be formed at Philadelphia by the, 281
- Fraser (Lieut.-Colonel A. T.), Red Sunsets and New Zealand Eruptions, 224
- Fraunhofer (Joseph), Collecting Treatises by, 496

- Freezing of Aërated Water, on some Phenomena connected with the, George Maw, 325
- Fresh-water Diatoms in the Bagshot Beds, Rev. A. Irving, 101
- Fresh-water Fishes, Marine and, W. A. Carter, 472
- Friction, Tidal, and the Evolution of a Satellite, James Nolan, 75
- Frog, Abnormalities in the Vertebral Column of the Common, Prof. C. Lloyd Morgan, 53, 344
- Frölich (Dr.), Measurements of Solar Heat, 455
- Fruit, Blight and Mildew in the United States, 422
- Fry (Albert), University College, Bristol, 345
- Fuel-Supply in Ships of War, 539
- Fungi, British, Text-book of, W. D. Hay, 364
- Fungi, Injurious, in California, Prof. W. G. Farlow, 521
- Functional Topography of the Brain, Prof. Ferrier, 453
- Fungus, Cambridge Cholera, Dr. E. Klein, F.R.S., 171, 295; Chas. Roy, 223; Walter Gardiner, 271, 319; George Masee, 319; Edgar Crookshank, 344
- Fungus on Orchids, 230
- Fusion-Points, Pyrometers and, Thos. Andrews, 224
- Fusion-Points, Pyrometers, and Seismometers, Sounding a Crater, Dr. H. J. Johnston-Lavis, 197; W. Worby Beaumont, 296
- Gad (Dr.), Active Oxygen in the Animal Organism, 383
- Gadolinium, Oxide of, on Atomic Weight of, A. E. Norden-skjöld, 47
- Gale of October 15-16, 1886, the, C. Harding, 95
- Gales, Recent, E. J. Lowe, 150
- Galesaurus planiceps, on the Skull and Dentition of, Sir R. Owen, F.R.S., 94
- Galileo: New Edition of the Works of, to be published at the cost of the State of Italy, 473; Monument to, erected in Rome, 612
- Galloway (W.): on the Recent Explosion at Elmora Pit, 133; Coal-Dust Theory, 222, 296, 343
- Galton (Capt. Douglas, F.R.S.), Sanitary Progress during the Reign of the Queen, 160
- Galton (Francis, F.R.S.), Pedigree Moth-breeding, 453
- Galvanometer, Ballistic, R. II. M. Bosanquet, 478
- Gambia, Climate of the Colony, 497
- Gardiner (Walter): Cambridge Cholera Fungus, 271, 319; *Tamus communis*, 454; Aroids, 454
- Gardner (Henry Dent), Electricity and Clocks, 198, 231
- Gardner (J. Starkie), Wrought Iron, 422
- Gas as a Constant Source in Experiments on Radiation, Employment of, 528
- Gas-lighting by Electricity, 569
- Gaseous Nitrogen of the Atmosphere, on the Direct Fixation of the, by Vegetable Soils, M. Berthelot, 335
- Gaseous Nitrogen of the Atmosphere, Direct Fixation of the, 479
- Gaseous State of Matter, Continuous Transition from the Liquid to the, at all Temperatures, 478
- Gases, the Electric Conductibility of Vapours and, Prof. Giov. Luvini, 85
- Gases, Kinetic Theory of, Prof. Tait, 311
- Gaskell (Dr. Walter H., F.R.S.), Sympathetic Nervous System, 185
- Gault, Folkestone, C. E. De Rance, 296
- Gecko, the, moves its Upper Jaw, Edward B. Foulton, 511
- Gems, Application of, to the Art of the Goldsmith, Alfred Phillips, 495
- Genetic Affinities and Classification of the Algae, Alfred W. Bennett, 478
- Gentiana, Notes and Queries, Prof. Huxley, 623
- Geodesy and Geology, Faye, 71
- Geodetic Conference, the, 15
- Geoghegan (Rev. Edward), Units of Weight, Mass, and Force, 334
- Geography: Similarities in the Physical Geography of the Great Oceans, J. Y. Buchanan, 33, 76; Geographical Notes, 60, 102, 258, 263, 308, 330, 353, 378, 422, 426, 475, 497, 500, 547, 596, 615; Proposed Exploration of the Melanesia, Prof. Kar, 182; Return of the Portuguese African Expedition, 282; Don Manuel Iradier's Explorations in Africa, 282; Geographical Results achieved by the Survey Officers on the Afghan Frontier Commission, 309; Physical Geography of Japan, Dr. Naumann, 330; on the Field and Methods of Geography, H. J. Mackinder, 331; Bulletin of the Paris Geographical Society, 353; Geographical Society of Paris, 354; Statistics of the Various Societies for, 354; Dr. Lenz's Map of the Congo, 354; Geographical Co-ordinates of Punta Arenas, M. Cruis, 382; Keith Johnston's Physical and Descriptive Geography, Abridged, 389; H. M. Stanley and the Relief of Emin Pasha, 416; Lieut. Baert's Journey up the Mongalla, 446; M. Chaffanjon's Exploration of the Orinoco, 446; Linguists of the Philippine Islands, 446; Italian Possessions on the Red Sea Coast, 446; Relief of the Australian Mediterranean, Dr. Otto Krimmel, 447; Expedition to Emin Pasha, Dr. Junker and H. M. Stanley and, 475; Dr. Zintgraff's Exploration of the Cameroon District, 475; A. D. Carey's Journey in Central Asia, 475; the Alpine Regions of Alaska, Lieut. H. Seton-Karr, 475; Readership in Geography at Oxford, 475; Geography at the Universities, 492; Climate of the Colony of Gambia, 497; Geographical and Geological Distribution of Animals, Angelo Heilprin, 510; Dr. O. Lenz, Letters, 520; Herr Glaser's Journeys in South Arabia, 520; Dr. Wolf's Exploring Work on the Sankuru, 520; Herr Ferdinand Seeland, on the Rate of Movement of the Pasterz Glacier, 520; Lieut. Wissmann, Fresh Expedition from Luluaburg, 521; J. T. Wills, on the Region between the Nile and the Congo, 521; Geo. Grenfell, Ascent of the Quango, 547; Proposal to cross South-East New Guinea, 547; Central Asia, 547; Dr. Hans Schinz, on the Lake Ngami Region, 547; Dr. Ochsenius, on the Age of certain Parts of the South American Andes, 547; News from Herr G. A. Krause, 547; Exploration of the Watershed of the River Yukon, 593; Death of James Wild, 594; Geographisches Jahrbuch, 596; Geographical Exhibition, 613
- Geology: Geology of the Lebanon, Prof. Edward Hull, F.R.S., 10; Erosion of the English Coasts, W. Topley, 37; and Geodesy, Faye, 71; Geological Society, 94, 167, 190, 382, 406, 502, 526, 550, 623; Medals awarded by the, 349; Station at Landsort (in Sweden) for Measurement of Shore-Elevation, 159; on the Drift of the Vale of Clwyd, Prof. T. McK. Hughes, 167; Discovery of Identity of Sand in New Zealand Rivers with Oktibehite, Prof. Ulrich, 190; the Metamorphic Rocks of the Malvern Hills, Frank Rutley, 190; Student's Hand-book of Historical Geology, A. J. Jukes-Browne, Prof. A. H. Green, 218; Angelo Heilprin on the Geology of Florida, 230; Observations nouvelles sur le Tufaut de Ciply et sur le Crétacé supérieur du Hainault, A. Ruteot and E. Van den Broeck, 317; Geological Evolution, Signor Enrico del Pozzo di Mombello, 350; the Relations between Geology and the Mineralogical Sciences, Prof. John W. Judd, F.R.S., 392, 414; Palæontological Researches near Rheims, 407; Sandstone of Organic Origin, 407; Geology of Jersey, Le P. Ch. Noury, 412; Mastodonsaurus discovered on Juckatoo Island, Sydney, 445; Geology of Lake Kelbia District, 455; Geology of Hampstead, Logan Loblely, 454; Geological Survey of India, Annual Report, 472; Geographical and Geological Distribution of Animals, Angelo Heilprin, 510
- Geometry: the Elements of Plane Geometry, 27; a Sequel to the First Six Books of the Elements of Euclid, containing an Easy Introduction to Modern Geometry, John Casey, 28; the Elements of Euclid, H. Deighton, 269; Euclid Revised, E. C. J. Nixon, 269; Geometrical Drawing for Army Candidates, H. T. Lilley, 28; Association for the Improvement of Geometrical Teaching, 204, 281; Origins of Geometry, Horace Lamb, F.R.S., 269; First Lessons in Geometry, B. Hanumanta Rau, 269; Developments of Naval Geometry, 382; Geometrical Construction of the Cell of the Honey-Bee, Prof. H. Hennessey, F.R.S., 502; the Association's "Geometry," Prof. George Bruce Halsted, 557
- German Carp, Consignment of, forwarded to Portugal by the National Fish-Culture Association, 350
- German Fishery Association, Seals destructive to Fisheries, 377
- German Lakes, North, Investigation of, by Dr. Otto Zacharias, 473
- Germany: Result of New Census of, 281; Atmospheric Temperature in, 504
- Gibney (Robert D.), Peculiar Radiation of Light, 536
- Gibson (E.) and R. E. Gregory, Tenacity of Spun Glass, 406
- Gibson (R. J. Harvey), an Abnormal *Blurred medicinalis*, 392
- Giglioli (Prof. Henry H.): *Lepidosiren paradoxa*, 343; Dr. Modigliani's Exploration of Nias, 342

- Gilded Chrysalides, Edward B. Poulton, 470
 Gilman (Dr.), Johns Hopkins University, Baltimore, 399
 Ginger-Beer Plant, Prof. Bayley Balfour, 358
 Ginnerup, in Denmark, Discovery of a Kitchen-Midden at, 112
 Girls, Physical Training of, Dr. Rayner W. Batten, 495
 Glacial Action, C. L. Griesbach, 594
 Glaciation in the Australian Alps, on some Further Evidence of, James Stirling, 182
 Glaciation, Lunar, S. E. Peal, 100
 Glaciation of North America, Great Britain and Ireland, Comparative Studies upon, Prof. H. Carvill Lewis, 89
 Glacier, the Muir, G. Frederick Wright, 380
 Glacier, Rate of Movement of the Pasterz, Herr Ferdinand Seeland, 520
 Gladstone (Dr. J. H., F.R.S.), on the Nature of Solution, 64
 Glaisher (Prof. J. W. L., F.R.S.), Mathematical Tripos, 101, 153, 199
 Gland, Green, of Fresh-water Crayfish, 455
 Glaser (Herr), his Journeys in South Arabia, 520
 Glasgow, Botanic Garden, 545
 Glass and other Surfaces, on the Intensity of Reflection from, Lord Rayleigh, F.R.S., 64
 Glass containing Lead, Note on the Manipulation of, H. G. Madan, 150; Prof. W. A. Shenstone, 223
 Glass-blowing, Methods of, W. A. Shenstone, 123
 Glass, Spun, Tenacity of, E. Gibson and R. E. Gregory, 406
 Glow, Residual, Examination of the, on Radiant-Matter Spectroscopy, W. Crookes, F.R.S., 425, 447
 Glycerinate of Potassa, M. de Forcrand, 288
 Glycose in Development of Animal Heat, Action of, A. Chauveau, 120, 144, 191
 Goebel's (Dr. K.) "Outlines of Classification and Special Morphology of Plants," on some Observations on Palæontology in, Prof. W. C. Williamson, F.R.S., 535, 577
 Gordon (General), Collection illustrative of the Coco de Mer (*Lodoicea seychellarum*) presented to the Museum, Kew Gardens, 494
 Gore (J. E.): Nova Orionis, M. Dunér, Herr Schwab, 85; Variable near χ^1 Orionis, Dr. G. Müller, 329; Orbit of the Binary Star 14 (*i*) Orionis, 569
 Gorgeu (M. Alex.), on the Artificial Production of Zincite and Willemite, 288
 Goss (Herbert), *Aporia cratægi*, 473
 Gothenburg, Proposed Free University at, 281
 Gould's (Dr.) Astronomical Journal, 59; New Variables in Cygnus, 282
 Gould Collection of Australian Birds at Philadelphia, 204
 Graham's Ideas concerning the Constitution of Matter, on certain Modern Developments of, Prof. T. E. Thorpe, F.R.S., 522, 547
 Grande Encyclopédie, 613
 Grape-Vine: Treatment of, with Salts of Copper against Mildew, 144; Anti-Phylloxeric Disinfection of, 382
 Gray (Thos.), Seismometry, 126, 198
 Great Britain and Ireland, North America, Comparative Studies upon Glaciation of, Prof. H. Carvill Lewis, 89
 Great Ice Age, Astronomical Theory of the, W. H. S. Monck, 7; Sir Robert S. Ball, F.R.S., 53; Rev. E. Hill, 101
 Great Men, Longevity of Joseph Jastrow, 10
 Great Oceans, Similarities in the Physical Geography of the, J. Y. Buchanan, 76
 Greely (Capt. A. W.), appointed Successor to the late Gen. Hazen, 443
 Green (Prof. A. H., F.R.S.): Student's Handbook of Historical Geology, A. J. Jukes-Browne, 218; Origin of Mountain Ranges, T. M. Reade, 361, 463
 Green Light at Sunset, R. T. Omond, 391
 Green Light at Sunrise and Sunset, Prof. A. Riccò, 584
 Greenhill (A. G.): History of the Theory of Elasticity, Isaac Todhunter, F.R.S., 313; Wave-Motion in Hydrodynamics, 477; Units of Weight, Mass, and Force, 486
 Greenleaf's Bequest to Harvard College, 229
 Greenwich, Solar Eclipse "Invisible" at, A. C. Crommelin, 414
 Grenfell (Rev. Geo.): Ascent of the Quango, 547; Exploration of the Congo, 596
 Gresham Lecture Fund, the, 16
 Gresham Lectures, 229
 Griesbach (C. L.), Glacial Action, 594
 Griffen (H. H.), Bicycles and Tricycles for the Year 1886, 52
 Grimaux (M. E.) and M. Ch. Cloez, Erythrene, 288
 Grönland, Berättelse om en Resa til, Nils O. Holst, 340
 Grosse (A.), a Wire Tape Rheostat, 334
 Grote (Arthur), Death of, 133
 Grothe (Dr.), Death of, 423
 Guillelard (F. H. H.), Cruise of the *Marchesa*, 369
 Gulf of Genoa, on the Existence of Submerged Valleys in the, 336
 Gulf Stream, Climate of Northern Europe and the, 91
 Guppy (Dr. H. B.), Coral Reefs of the Solomon Islands, 77
 Gurt (Dr.), a Fossil Meteorite found in Coal, 36
 Gurney (Edmund), Phantasms of the Living, Prof. C. Llo Morgan, 290, 345
 Guthrie (Frederick), Obituary Notice of, 8; Guthrie Memorial Fund, 127, 327
 Guthrie (F.), Virtual Velocities, 149
 Gymnasial Instruction, Report of the Swiss Commission for the Reform of, 257
Gymnema sylvestre, an Examination of the Leaves of, Dav Hooper, 565; Hooper's Paper on, J. C. Shenstone, 594
Gymnodinium polyphemus, Pouchet, 48
 Gyroscope, New Collimating, 600
 Habenicht, on the Morphology of the Kosmos, 35
 Hæmatoscopy, Hénoque, 48
 Hagen (Dr. H. A.), Abnormal Cats' Paws, 345
 Hagenbach (Ed.), Propagation of Electricity in Telegraph Wires, 333
 Hahn (Prof. F.), Aurora, 8
 Hailstones, Top-shaped, C. S. Middlemiss, 413; J. Spence Smithson, 438; Alex. Johnstone, 536
 Hairiness, Aino, and the Urvolk of Japan, F. V. Dickins, 534
 Haldane (Dr. Daniel Rutherford), Death of, 567
 Hale (Horatio), on the Origin of Languages, 17
 Halibut, Capture of a, in the Lower Potomac, 569
 Hall (Prof. Asaph): Six Inner Satellites of Saturn, 257; Stell Parallax, 258
 Hall (Maxwell): Temperature and Pressure in Jamaica, 437
 West Indian Meteorological Confederation, 485
 Halo with Parhelia observed at Fontainebleau, 359
 Halo, Solar, J. J. Walker, 272; R. T. Omond, 582
 Halos, Lunar, Prof. S. T. Moreland, 414
 Halsted (Prof. Geo. Bruce), the Association's "Geometry 557
 Hampstead, Geology of, Logan Lobley, 454
 Hand and Foot, Variations in the Nerve-Supply of the Lumbrical Muscles in the, with some Observations on the Perforated Flexors, 521
 Harcourt (A. Vernon, F.R.S.), Lighthouse Illuminants, 41, (Harding (Chas.): High Temperature in October, 18; the Ga of October 15-16, 1886, 95
 Harley (Rev. Timothy), Lunar Science, 246
 Harmony and Counterpoint, Elements of, F. Davenport, 339
 Harrington (M. W.), the Chinook Winds, 568
 Harris (T. E.), Hand-book of Acoustics, 270
 Hartley (Prof. W. N.), on the Nature of Solution, 64
 Harvard College: Stellar Photography at, Prof. Pickering, 37
 Mr. Greenleaf's Bequest to, 229; Observatory of, 424, 497
 Hatch (Dr. Fred. B.), Petrography, 482
 Hawaiian Fishing Implements and Methods of Fishing, Mr E. M. Beckley, 327
 Hawaiian Volcano Mauna Loa, Discharge from, 376
 Hay (J. S.) and Jos. M. Metzger, Earthquake in Sierra Leone, 141
 Hay (W. D.), Text-book of British Fungi, 364
 Hayward (Robert B., F.R.S.): on the Water in the Chal beneath the London Clay of the London Basin, 335; Mass Weight, and Dynamical Units, 604
 Hazen (William Babcock), Obituary Notice of, Prof. Cleveland Abbe, 541
 Health and Disease, Dynamics of, Life-Energy or the, Surgeon Major Nathl. Alcock, 366
 Hearing, Acuteness of, Dr. König, 480
 Hearth, Prehistoric, under the Quaternary Deposits in Western New York, 476
 Heat, Disinfection by, R. Strachan, 7
 Heat, Lecture Experiments on the Expansion of Solids by, F. G. Madan, 89; C. E. Stromeyer, 126
 Heat, the Sun's, Sir William Thomson, F.R.S., 297
 Heat into Work, on the Conversion of, W. Anderson, 387

- Heaton (C. W.), Experimental Chemistry, 74
 Heats of Combustion, Calorimetric Bomb and Measurement of, 551
 Heavens, Proposed Photographic Map of the, 35
 Hector (Dr. Jas., F.R.S.), Oktibehite or Awaruite, 513
 Heddlin (Angelo), Geographical and Geological Distribution of Animals, 510
 Heliography, Prof. Spörer on Sunspots, 72
 Helmholtz (Prof. von): the Formation of a Thunderstorm, 24; Cohesion of an Air-free Column of Water, 456
 Hemsley (W. Botting): Botany of the Afghan Delimitation Commission, 173; Primroses, 561
 Hennessy (Prof. H., F.R.S.): Trains of Pulleys and Drums, 452; Geometrical Construction of the Cell of the Honey-Bee, 502
 Hénoque (N.), Hæmatoscopy, 48
 Henrici (Prof. O., F.R.S.) Note on Mr. Budden's Proof that only One Parallel can be drawn from a given Point to a given Straight Line, 100
 Heptene, Action of Heat on, 455
 Herbarium, Lamarck's, Removal of, 312
 Heredity in Cats, with an Abnormal Number of Toes, Observations on, Edward B. Poulton, 38; William White, 125
 Heredity, Pedigree Moth-breeding as a Means of Verifying certain Important Constants in the Theory of, Francis Galton, F.R.S., 453
 Heritsch (A.), on Radiophony, 333
 Hermes (Dr. Otto), Phosphorescence of Marine Fish, 377
 Herring, Puzzling Migratory Habits of the, 567
 Hertslet (Reginald H.), Earthquake at Sea, 157
 Hesperia, Probable Re-Discovery of, Dr. R. Luther, 614
 Hessian Fly, Miss Eleanor A. Ormerod, on the, 256
 Heughes (Sir W. W.), Contributions to the Adelaide University, 255
 Heurck (Dr. Van), Photo-Micrographs, 359
 Hidden (William Earl), Mazapil Meteoric Iron, 572
 Higgin (Thos.), Electrical Phenomenon, 173
 Hill (Rev. E.), Astronomical Theory of the Great Ice Age, 101
 Hill (S. A.), Vertical Decrement of Temperature and Pressure, 606
 Hinde (Geo. J.), on the Character of the Beds of Chert in the Carboniferous Limestone of Yorkshire, 582
 Hirn (M.), on the Explosion of Meteorites, 303
Hirudo medicinalis, an Abnormal, R. J. Harvey Gibson, 392
 Historical Geology, Student's Hand-book of, A. J. Jukes-Browne, Prof. A. H. Green, 218
 Hittite Inscriptions, Capt. Conder's Translation of, 422
 Hodd (J. Herbert), Abnormality in Cats' Paws, 53
 Hoffman (Dr. W. J.), Aboriginal Art in California and Queen Charlotte's Island, 285
 Holden (Edward S.), Photography the Servant of Astronomy, 317
 Holetschek (Dr. J.), Comet Finlay (1886 c), 207
 Holland (Sir Henry), Colonial Conference, 544
 Holmes (W. H.), on the Great Serpent Mound in Ohio, 281
 Holmesdale Natural History Club, 206
 Holmestrand, Brilliant Meteor observed at, 352
 Holst (Dr. Nils O.), Berättelse om en Resa til Grönland, 340
 Holub (Dr.), Supposed Murder of, 379
 Homeric Astronomy, A. M. Clerke, 585, 607
 Hong Kong, the Meteorological Observatory of, 229
 Honzo Dsufu, the, Japanese Work on Botany, 204
 Hooper (David), an Examination of the Leaves of *Gymnema sylvestre*, 565; J. C. Shenstone, 594
 Hopkinson (John, F.R.S.), Note on Specific Inductive Capacity, 334
 Hours with a Three-Inch Telescope, Capt. Wm. Noble, 246
 Houzeau (M.), Method for the Determination of the Constant of Aberration, 377
 Howell (Mr.), Technical Education and the House, 326
 Howietoun, the History of, Sir J. Ramsay Gibson Maitland, 337
 Hughes (Prof. T. McK.): on the Drift of the Vale of Clwyd, 167; on Caves, 454
 Hulke (J. W., F.R.S.), Note on *Polacanthus fossilis*, 357
 Hull (Prof. Edward, F.R.S.), the Geology of the Lebanon, 10
 Hungary, Sunspot Observations in, Carl Braun, A. M. Clerke, 227
 Hunt (Thos. Sterry), Mineral Physiology and Physiography, 578
 Hunterian Oration, W. S. Savory, F.R.S., 379
 Huntington (O. W.): on the Crystalline Structure of Iron Meteorites, 16, 93; Coahuila Meteorites, 461
 Hutton (Capt. F. W.), Meteorological Conditions at the Time of the Eruption of Mount Tarawera, New Zealand, 322
 Huxley (Prof.): and Prince of Wales on the Imperial Institute, 265; on the True Functions of the Imperial Institute, 305; Royal Society and Scientific Federation, 289; Organisation of Industrial Education, 493; Preliminary Note on the Fossil Remains of a Chelonian Reptile, *Ceratochelys sthenurus*, from Lord Howe's Island, Australia, 615; the Gentians—Notes and Queries, 623
 Hydrate of Chloral, Prof. Liebreich, 264
 Hydraulic Power and Hydraulic Machinery, H. Robinson, Major Allan Cunningham, 460
 Hydrodynamics, on Jacobi's Figure of Equilibrium for a Rotating Mass of Fluid, Dr. G. H. Darwin, F.R.S., 188
 Hydrodynamics, Wave-Motion in, A. G. Greenhill, 477
 Hydrogen and Chlorine Gas, Mixed, Chemical Action of Light on, Dr. Pringsheim, 552
 Hydrophobia, M. Pasteur's Treatment of, 30
 Hydrophobia, Society for Prevention of, 57
 Hygiene, Proposed School of, at the University of Michigan, 377
 Hygiene, School, Arther Newsholme, 604
 Hygrometers: Sensitive, 331; Recording, 331
 Hymenomyces, British Fungi, Rev. John Stevenson, 4
 Hyotherium from the Pliocene of India, on a Jaw of, R. Lydekker, 94
 Hysteria Studied in Art Manifestations of the Past, 376
 Ice, Thickness of the, in North-Eastern Pennsylvania during the Glacial Epoch, 141
 Ice Age, Astronomical Theory of the Great, W. H. S. Monck, 7; Sir Robert S. Ball, F.R.S., 53; Rev. E. Hill, 101
 Ice Cavern in Austria, Discovery of, 17
 Ice Period in the Altai Mountains, an, E. Michaelis, 149; A. Bialoveski, 513
 Ice and Brines, J. Y. Buchanan, 608
 Iceland, Introduction of New Plants into, 356
 Ichthyology, Fishes inhabiting very Deep Waters, M. Léon Vaillant, 288
 Illinois, South-Eastern, Earthquake in, 444
 Illuminants, Lighthouse, A. Vernon Harcourt, F.R.S., 41, 60; T. and D. Stevenson, 63
 Imperial Institute, 34, 210; Sir Frederick Abel, elected Organising Secretary to the, 111; Scientific Basis of Proposed, 254; Prince of Wales and Prof. Huxley on, 265; Possible Results of the, 280; on the True Functions of the, Prof. Huxley, 305; Work of the, Sir Fred. Abel, F.R.S., 617
 Imperial University of Japan, Calendar of the, 401
 Index-Catalogue, Medical, A. T. Myers, 196
 Index, Subject, Two Hours with a, 123
 India: Food-Grains of, A. H. Church, Prof. John Wrightson, 52; Indian Silk Industry, the Decline of the, 84; on the Cultivation of the so-called Wild Silks of India, T. F. Peppe, 256; Ipecacuanha Cultivation in, W. T. Thiselton Dyer, F.R.S., 227; Indian Survey Staff, 281; Queen's Jubilee in, India, 349; Administration Report of the Meteorological Department of India, 365; Butterflies of India, Lionel de Nicéville, H. J. Elwes, 436; Annual Report of the Geological Survey of, 472; Indian Engineering, Survey of the Straits Settlements, 472
 Indian, West, Meteorological Confederation, Maxwell Hall, 485
 Indian, West, Seal (*Monachus tropicalis*), Henry A. Ward, 392
 Indian Tribes of British Columbia, Dr. Franz Boas, 568
 Indiana, South Western, Earthquake in, 444
 Indians, Consumption among the, 400
 Indo-Chine, La France en, A. Bouinain and A. Paulus, 221
 Inductionless Coils, Theory of the, Dr. Aron, 383
 Inductive Capacity, Specific Note on, John Hopkinson, F.R.S., 334
 Industrial Education, Organisation of, Prof. Huxley, 493
 Industrial Studentships, Col. J. F. D. Donnelly, 413
 Infant Navajos, Notes on Certain Traits of, R. W. Shufeldt, 346

influence of Wind on Barometric Readings, G. J. Symonds, F.R.S., 53
 ngram (William), the Recent Weather, 173
 noite, Preparation, Properties, and Constitution of, M. Maquenne, 335
 nsect-Life in the East, 527
 nsects and Patunias, J. W. Slater, 70
 nsects, Protective, Value of Coloured Markings in, 402
 nstantaneous Shutters: A. Mallock, 324; Col. H. Stuart-Wortley, 366
 nstinctive Action, 392
 nstitute of France, Change of Professorships in the, 256
 nstitution of Civil Engineers, 503
 nstitution of Mechanical Engineers, 355
 nstitution of Naval Architects, 538
 nstancy of Reflection from Glass and other Surfaces, on the, Lord Rayleigh, F.R.S., 64
 ntermittent Downward Filtration, Ten Years' Experience in Works of, T. Bailey-Denton, 195
 nternational Committee of Weights and Measures, 203
 nternational Medical Congress at Washington, Ninth Triennial Meeting of the, 350
 nternational Polar Expeditions, 147
 nternational Statistical Institute, 255
 nvertebrates, a New Function of the Otocysts in the, Yves Delage, 48
 nvisible at Greenwich, A. C. Crommelin, 414
 npecacuanha Cultivation in India, W. T. Thiselton Dyer, F.R.S., 227
 nradier's (Don Manuel) Explorations in Africa, 182
 nreland, North America, Great Britain and, Comparative Studies upon Glaciation of, Prof. H. Carvill Lewis, 89
 nridescent Clouds, Jas. C. McConnel, 533; G. H. Stone, 581
 nron, Mazapil Meteoric, William Earl Hidden, 572
 nron in Strong Fields, Magnetisation of, Prof. J. A. Ewing, 622
 nron Ships, Deviation of the Compass in, considered practically, W. H. Rosser, 437
 nron, Wrought, J. Siarkie Gardner, 422
 nritation in the Throat, Various Effects of, 575
 nring, (Rev. A.): Fresh-water Diatoms in the Bagshot Beds, 101; Physical History of the Bagshot Beds of the London Basin, 382
 nropykna Lines, Rotation between the Gaseous and Liquid States of Matter by, 333
 nry: Geographical Society of, 60; Learned Society formed in Italy for the Study of Eastern Languages and Archaeology, 328; Scientific Renaissance in, 350; Italian Emigration, 403; Italian Possessions on the Red Sea Coast, 446; New Edition of the Works of Galileo to be published at the Cost of the State, 473; Earthquake of February 23 in, 479; Stations established by the Italian Meteorological Society, 612

 nackson (John R.), Colonial and Indian Exhibition, 81, 225
 nado-handed Brushes, on Two, Prof. J. P. O'Reilly, 318
 namaica: Temperature and Pressure in, Maxwell Hall, 437; Disease of Colocasia in, 478
 napan: Volcanoes of, Prof. Milne, 19; Seismometry in, Prof. John Milne, 36; Prof. J. A. Ewing, 75; Seismological Society of, 518; the Active Volcano Asamayama, 133; Japanese Mission to inquire into the Norwegian Cod-Fisheries, 158; the Horae Danfu, Work on Botany, 204; Japan Educational Society, 204; Education of Women in, 229; Magnetic Map of, 330; Physical Geography of, Dr. Naumann, 330; Earthquake in, 399; Calendar of the Imperial University of, 401; Aino Hairiness and the Urwolk of, F. V. Dickins, 534; Important Points in the History of Earthquake's Investigation in, Prof. John Milne, 599
 nastrow (Joseph), Longevity of Great Men, 20
 nava, the Disease *Beri-beri* in, 206
 naw, the Gecko moves its Upper, Edward B. Poulton, 511
 nbeans (W. T.), Lives of the Electricians, 270
 nbenner (J. H. A.), Macro-Lepidoptera of East Sussex, 239
 njersey, Geology of, Le P. Ch. Noury, 412
 njevons (W. Stanley), Letters and Journal of, 23
 nJohns Hopkins University: Marine Laboratory connected with, 389; Dr. Gilman on, 399

Johnston-Lavis (Dr. H. J.), Sounding a Crater, Fusion-Points, Pyrometers, and Seismometers, 197
 Johnstone (Alex.), Top-shaped Hailstones, 536
 Joule (James Prescott, F.R.S.), Joint Scientific Papers of, 468
 Journal of Botany, 212, 404
 Journal of the Royal Agricultural Society of England, Prof. John Wrightson, 148
 Journal of the Royal Horticultural Society, 569
 Journal of the Society of Telegraph-Engineers, 569
 Jowett (Prof.), on University Colleges, 441
 Jubilee, Science and the, 217, 241; the Jubilee in India, 309
 Judd (Prof. John W., F.R.S.): the Relations between Geology and the Mineralogical Sciences, 392, 414; the Relation of Tabasheer to Mineral Substances, 488; Vitality and its Definition, 511
 Jukes-Browne (A. J.), Student's Hand-book of Historical Geology, Prof. A. H. Green, 218
 Junker (Dr.), on the Best Route by which to reach Emin Pasha, 258, 475
 Jupiter: Rotation-Time of the Red Spot on, Prof. Young, 481; Mean Periodicity of the Spots of, 359
 Jurassic Mammals, American, 622

 Kakke, the Disease, 206
 Kaloca Observatory, Dr. C. Braun, 59
 Kan (Prof.) Proposed Geographical and Geological Exploration of the Moluccas, 182
 Karachi Museum, W. D. Cumming at, 593
 Kathode, Metal Films arising from the Disruption of a, B. Dessau, 333
 Keane (Prof. A. H.): European Prehistoric Races, 564; the Eskimo, Dr. H. Rink, 309
 Kempe (A. B., F.R.S.), on the Theory of Mathematical Form, 574
 Kennedy (Prof. Alex. B.), on the Use and Equipment of Engineering Laboratories, 235
 Kent (Saville), Report on Tasmanian Fisheries, 233
 Kew, Bulletin of Miscellaneous Information issued from the Royal Gardens, 306
 Kew Gardens: Presentation to, of Gen. Gordon's Collection Illustrative of the Coco de Mer (*Louicea seychellarum*), 494; Thos. Moore's Botanical Collection acquired for the Herbarium, 495
 Kew, a Plant of Manilla Hemp at, 567
 Kew Observatory, Report of the Committee, 307
 "Khevir," or Great Salt Desert, 232
 Kilauea after the Eruption of March 1886, 451
 Kilogramme, Standard, 408
 Kinetic Theory of Gases, Prof. Tait, 311
 King (Dr. Geo.), on the Genus *Ficus*, 525
 Kingsmill (Thos. W.), Earthquakes, 319
 Kinship, Algebraic Notation of, Prof. Alex. Macfarlane, 126
 Kirchenpauer (Dr. Gustav Heinrich), Death of, 473
 Kirkwood (Prof. Daniel), Comets and Asteroids, 474
 Kitchen-Midden discovered at Ginnerup in Denmark, 112
 Kiu Sawa, Proposed Investigation of the Fish-bearing Properties of, 444
 Klein (Dr. E., F.R.S.): the Cambridge Cholera Fungus, 171, 295; Etiology of Scarlet Fever, 452
 Klein (Dr. L. Martial), Vitality of Seeds, 463
 Klein (Sydney T.): the Lepidoptera and Hymenoptera of Middlesex, 167; Best Method of capturing Lepidoptera, 282
 Klumpke (Miss), Assistantship in the Paris Hospitals, 206
 Knife of Curious Workmanship found in the Thick Flesh of a Cod, 545
 Knowledge, Scientific, First Year of, Paul Bert, 221
 Koch (Dr. K. R.), Aurora Borealis, A. M. Clarke, 433
 Kolenko (B. von), Pyro-Electricity of Quartz, 333
 König (Dr.), Von Kries' Colour-mixing Apparatus, 336
 König (Dr.), Acuteness of Hearing and its Estimation by means of Tuning-Forks, the Sound of which gradually died away, 480
 Kosmos, Habenicht on the Morphology of the, 35
 Kötter (Dr.), Mean Rate of Flow of a Fluid from a Small Aperture, 600
 Krause (Herr G. A.), News from, 547

- er (Prof.), on Serous Albumen, 504
 (Dr. A.), Comet Finlay (1886 c), 85, 134
 Strimmel (Dr. Otto), Der Ocean, 6; Relief of the Australian Mediterranean, 447
 Urachoe Technical College, the, 84
- ; Pérouse Expedition round the World, Centenary of the, 443
- Laboratories, Engineering, on the Use and Equipment of, Prof. Alex. B. Kennedy, 235
 Laboratories, New Building for the, of the Paris Medical School, 473
 Lacaze-Duthiers (Prof. de), Presentation from his Pupils, 473
 Lake, Soundings at Crater, 353
 Lake Ngami Region, Dr. Hans Schinz on, 547
 Lake Kelbia District, Geology of, 455
 Lake-Dwelling recently discovered at Wallishafen on the Lake of Zurich, 423
 Lakes, North German, Dr. Otto Zacharias's Investigation of, 473
 Lamarck's Herbarium, Removal of, 312
 Lamb (Horace, F.R.S.): Origins of Geometry, 269; Ellipsoidal Current Sheets, 574
- Lamellary Thomsonite from Bishopton, Renfrewshire, Description of a, 335
 Lamp, Herr Linnemann's New, 432
 Länderkunde des Erdteils Europa, 473
 Langley (Prof. S. P.), Extension of the Corona, 52
 Langner (Herr Hugo), Ueber eine Methode zur Messung kleiner Winkeldifferenzen, 329
 Languages, on the Origin of, Horatio Hale, 17
 Lapouge (M. de), on the Decline of the Birth-rate in France, 357
 Larva, a Balanoglossus, from the Bahamas, W. F. R. Weldon, 477
 Latent Heats of Vaporisation of some very Volatile Substances, 551
 "Latex," on the Term, in Botany, M. A. Trécul, 600
 Laurie (A. P.), Electric Charge on the Atom, 131
 Lavas, Acid, Nature and Origin of Lithophysæ and the Lamination of, J. P. Iddings, 380
 Law of Storms in the Eastern Seas, Dr. W. Doberck, 135
 Le Conte (Prof. John), Lightning Flashes, 342
 Lead, Note on the Manipulation of Glass containing, H. G. Madan, 150; W. A. Shenstone, 223
 Leaf-beds, Ardrin, J. Starkie Gardner, 382
 Leaves of *Gymnema sylvestre*, an Examination of the, David Hooper, 565
 Lebanon, Geology of the, Prof. Edward Hull, F.R.S., 10
 Lechartier (M. G.), on the Composition of the Ashes of Cider, 382
 Leclanché Battery, Modifications of the, 331
 Lecture Experiment on the Expansion of Solids by Heat, H. G. Madan, 89
 Lectures and Essays, W. K. Clifford, F.R.S., 270
 Legge (Prof. Di), Researches on the Sun's Diameter, 595
 Leicester Literary and Philosophical Society, 180
 Leicestershire, Flora of, including the Cryptogams, J. G. Baker, 411
 Lemons, Irregularly Developed, 430
 Lemström (M. S.), L'Aurore Boréale, A. M. Clerke, 433
 Lenses: Magnifying, Flat on both Sides, 331^o; Value of the New Apochromatic, 467
 Lenz (Dr. Oscar): Exploration of the Upper Congo, 232; his Arrival at Zanzibar, 283; his Map of the Congo, 354; Return of, from Zanzibar, 378; Letters from, 402, 520
 Lepidoptera, Best Method of capturing, Sydney T. Klein, 282
 Lepidoptera-Heterocera, Capt. H. J. Elwes, 503
Lepidosiren paradoxa, Prof. Henry H. Giglioli, 343
 Leprosy on the West Coast of Norway, 519
 Lésseps (M. de), Artesian Wells in Algeria, 287
 Lewis (A. L.), Stone Circles, 503
 Lewis (Prof. H. Carrill), Comparative Studies upon Glaciation of North America, Great Britain, and Ireland, 89
 Ley (Rev. W. Clement): the Recent Weather, 54; a Few of our Weather Terms, 323
 Leyden Museum, 181
 Leyden Museum, Notes from the, 477
- Leyst (Herr), Remarkable Forms of Lightning-Flash, 85
 Libraries of the United States, Statistics concerning, 519
 Lice, Tree-, at Rodriguez, Ravages of, 179
 Lieberkühn (Dr. Nathaniel), Death of, 612
 Liebreich (Prof.), Hydrate of Chloral, 264
 Life, Herbert Spencer's Definition of, F. Howard Collins, 487
 Life-Energy, or the Dynamics of Health and Disease, Surgeon-Major Nathl. Alcock, 366
 Light, Diffraction of, Hermann Struve, 423
 Light, on the Absolute Wave-length of, Louis Bell, 524
 Light, Peculiar Radiation of, Robert D. Gibney, 536
 Light, Chemical Action of, on Mixed Hydrogen and Chlorine Gas, Dr. Pringsheim, 552
 Light, Aberration of, Phenomena connected with, 575
 Light, the Zirconia Oxyhydrogen, Lewis Wright, 583
 Lighthouse Illuminants, A. Vernon Harcourt, F.R.S., 41, 60; T. and D. Stevenson, 63
 Lightning, Effects of, in Schleswig-Holstein, 360
 Lightning-Flash, Remarkable Form of, Herr Leyst, 85
 Lightning-Flashes, Prof. John Le Conte, Antoine d'Abbadie, 342
 Lightning-Rods, Radius of the Circle of Protection of, Herr Schiller, 376
 Lilley (H. T.), Geometrical Drawing for Army Candidates, 28
 Lime, Silicostannate of, Preparation of a, corresponding to Spheue, M. L. Bourgeois, 335
 Linneus, Through the Fields with, Mrs. Florence Caddy, 579
 Linnean Society, 70, 142, 166, 358, 381, 430, 478, 525, 623
 Linnean Society of New South Wales, 95; Annual General Meeting of, 519
 Liquid Surfaces of Revolution, Critical Mean Curvature of, Prof. A. W. Rücker, F.R.S., 143
 Liquid and Gaseous States of Matter, Preliminary Note on the Continuity of the, William Ramsay and Sydney Young, 262
 Lisbon, Earthquake at, 612
 Literature, Study of, John Morley, 422
 Lithophysæ, Nature and Origin of, and the Lamination of Acid Lavas, J. P. Iddings, 380
 Liverpool Astronomical Society, 402
 Liverpool Biological Society, 454
 Liverpool Literary and Philosophical Society, 546
 Lives of the Electricians, W. T. Jeans, 270
 Living: Phantasms of the, Edmund Gurney, Fred. W. H. Myers, and Frank Podmore, Prof. C. Lloyd Morgan, 290, 345
 Lobley (Logan), Geology of Hampstead, 454
 Local Scientific Societies, British Association and, 78
 Localisation, Cerebral, Prof. E. A. Schäfer, F.R.S., 438, 464
 Loch-buie Observatory, the, 58
 Loch-buie Marine Institute, 205
 Loch Creran, W. Alexander Smith, 484
 Lochleven Trout, Dr. Day, 166
 Lockhart (J. H. Stewart), Folk-Lore of China, 281
 Lockwood (Samuel), Snowflakes, 414
 Lodge (Prof. Alf.), Units of Weight, Mass, and Force, 557
 Loewy (M.), New Method for the Determination of the Constant of Aberration, 263, 282, 407, 424, 431, 454, 479
 Logarithms, Values of, Prof. J. C. Adams, F.R.S., 381
 London Institution Lectures, the, 84
 London, University for, 505
 Long Lost Reefs, Capt. W. J. L. Wharton, F.R.S., 347
 Longevity of Great Men, Joseph Jastrow, 10
 Longitude of Rio, Prof. C. A. Young, 172
 Longitudes in Brazil, Admiral E. Mouchez, 100
 Loo-Choo Islands, Collection of Reptiles and Batrachians from, the, 431
 Lord Howe's Island, Australia, Preliminary Note on the Fossil Remains of a Chelonian Reptile, *Ceratohelys sthenurus*, from, Prof. Thos. H. Huxley, F.R.S., 615
 Louisville, University of, Semi-Centennial Anniversary of, 545
 Lowe (E. J., F.R.S.): Recent Gales, 150; Snowstorm of January 7, 1887, 271
 Lu River of Tibet, General J. T. Walker, F.R.S., on the, 615
 Lubbock (Sir John, F.R.S.): the Forms of Seedlings—the Causes to which they are due, 235; Lecture on Savages, 255; Phytobiological Observations, 430; Habits of Ants, 518
 Lucas (Felix), Entropy, 455
 Lucasite, a New Variety of Vermiculite, 141
 Lumbar Curve in Man and Apes, Prof. Cunningham, 46

- Lumbricales Muscles in the Hand and Foot, Variations in the Nerve-Supply of the, with some Observations on the Perforating Flexors, 521
- Lunar Glaciation, S. E. Peal, 100
- Lunar Halos, Prof. S. T. Moreland, 414
- Lunar Science, Rev. Timothy Harley, 246
- Lung-Sick, E. J. Dungate, 29; Philip J. Butler, 54; Dr. Gérard Smets, 76
- Lupton (Sydney), Chemical Arithmetic, 74
- Luther (Dr. R.), Probable Re-discovery of Hesperia, 614
- Lüttich (Dr. Julius), Death of, 307
- Lavini (Prof. Giov.), the Electric Conductibility of Vapours and Gases, 85
- Lydekker (Richard): on a Jaw of Hyotherium from the Pliocene of India, 94; the Cetacea of the Suffolk Crag, 94; Catalogue of Fossil Mammalia in the British Museum, 532
- Lynn (Mr.), Alleged Ancient Red Colour of Sirius, 378
- Lyre, *B.*, Atmosphere of, O. T. Sherman, 451
- Macadam (Prof.), Sample of Talc used in Paper-making, 423
- McConnel (James C.): an Error in Maxwell's Electricity and Magnetism, 172; Magnetic Theory, 344; Iridescent Clouds, 533
- Macfarlane (Prof. Alex.), Algebraic Notation of Kinship, 126
- Machinery, Means of Controlling the Irregular Action of, 479
- Mackinder (H. J.), on the Field and Methods of Geography, 331
- McLennan (J. Ferguson), Studies in Ancient History, Dr. W. Robertson Smith, 3
- Macro-Lepidoptera of East Sussex, J. H. A. Jenner, 230
- Madagascar, Capt. Samuel Pasfield Oliver, 149
- Madagascar: the French and, 306; Mr. Sibree on, 497
- Madan (H. G.): Lessons in Elementary Dynamics, 51; Lecture Experiments on the Expansion of Solids by Heat, 89; Note on the Manipulation of Glass containing Lead, 150; Recently-discovered Deposit of Celestine, 391; a Method of illustrating Combinations of Colours, 513; the Production of Newton's Rings by Plane Soap-Films, 583
- Madras Observatory, Mr. Pogson, 282
- Madreporian Coral Fungia, Anatomy of the, G. C. Bourne, 404
- Madrid Geographical Society, 182
- Magnetism: on the Cause of Magnetic Rotatory Polarisation, 141; Magnetic Horizontal Intensity in Northern Siberia, A. C. von Tillo, 170; Theory of Magnetic Measurements, Francis E. Nipher, 295; Magnetic Theory, Rev. H. W. Watson, 296; Jas. C. McConnel, 344; Magnetic Map of Japan, 330; Determination of the Poles in Magnets, 479; Magnetic Effects of Recent Earthquakes, 479; an Error in Maxwell's "Electricity and Magnetism," Prof. A. Seydler, 512; Note on Magnetic Resistance, Profs. W. E. Ayrton and John Perry, 526; Magnetisation of Iron in Strong Fields, Prof. J. A. Ewing, 622
- Maitland (Sir J. Ramsay Gibson), the History of Howietoun, 337
- Mallock (A.), Note on Instantaneous Shutters, 324
- Malvern Hills: the Metamorphic Rocks of the, Frank Rutley, 190, 623; Inquiry into the Genesis of the Crystalline Schists of the, Dr. C. Callaway, 623
- Mammalia, Fossil, in the British Museum, Catalogue of, Richard Lydekker, 532
- Man and Apes, the Lumbar Curve in, Prof. Cunningham, 46
- Man, Palaeolithic, in North-West Middlesex, J. A. Brown, 554
- Manchester Literary and Philosophical Society, 527
- Manchester, Report of the Public Free Libraries of the City of, 134
- Mandalay, Earthquake Shock, 472
- Manganese and Bismuth, Fluorescence of, 144
- Manganese Steel, Physical Properties of, Prof. W. F. Barrett, 311
- Manilla Hemp at Kew, 567
- Manipulation of Glass containing Lead, Note on the, H. G. Madan, 150
- Manipulation of Glass containing Lead, Prof. W. A. Shenstone, 223
- Manipur District, Dr. G. Watts's Observations in, 308
- Map of the World, lent by the Pope, Facsimile of the Famous, 447
- Maps of the River Ogové in West Africa, 353
- Maquenne (M.), Preparation, Properties, and Constitution of Inosite, 335
- Marayta (Prof. Miguel), Anthropological Discovery in the Valley of Rebas, 379
- Marche (Alfred), Expedition to the Marianne Islands, 231
- Marchesa, Cruise of the, F. H. H. Guillemard, 369
- Mares and Foals attacked by Wolves, George Maw, 297
- Marey (M.), Mechanism of the Flight of Birds studied by Chrono-Photography, 335; Movement of a Bird's Wing represented according to the Three Dimensions of Space, 382
- Marianne Islands, Alfred Marche's Expedition to, 231
- Marine Biology, Pouchet on *Gymnodinium polyphemus*, 48
- Marine Meteorological Instruments and Apparatus, Exhibition of, 352, 443, 491
- Marine Engineering, Die Schiffsmaschine, ihre Construction Wirkungsweise und Bedienung, 242
- Marine Fish, Phosphorescence of, Dr. Otto Hermes, 377
- Marine and Fresh-water Fishes, W. A. Carter, 472
- Marine Temperature Observations, Dr. H. R. Mill, 527
- Marion's Practical Guide to Photography, 52
- Maroni, Journey up the River, 354
- Marseilles Observatory, Note on Earthquake of February 23 at, 455
- Marshall (A. Milnes, F.R.S.), a Junior Course of Practical Zoology, 506
- Marsupialia, Embryology of Monotremata and, W. H. Caldwell, 524
- Martin (K.), Westindische Skizzen, Reise-Erinnerungen, Dr. A. Ernst, 459
- Martin (T. C.) and Jos. Wetzler, Electric Motor and its Applications, Prof. Silvanus P. Thompson, 410
- Marx (Dr. Walfried), Death of, 400
- Mascart (M.), Waterspouts, 431
- Mason Science College, Birmingham, 494
- Mass, Weight and, 512
- Mass, and Force, Units of Weight, Prof. A. G. Greenhill, 486; Rev. Edward Geoghegan, 534; Prof. Alf. Lodge, 557; Archd. C. Elliott, 605; Robt. F. Hayward, F.R.S., 604
- Masse (George), Cambridge Cholera Fungus, 319
- Masters (Dr. Maxwell T.): Autumnal Flowering, 11; on the Peculiar Conformation of the Flowers of Cypripedium, 142
- Mastodonsaurus discovered on Juckatoo Island, Sydney, 445
- Mathematics: American Journal of, 28; Mathematical Society, 70, 166, 287, 406, 503, 599; Music and Mathematics, Prof. J. J. Sylvester, F.R.S., 132; Mathematical Tripos, Prof. J. W. L. Glaisher, F.R.S., 101, 153, 199; Acta Mathematica, 123; Elementary Results in Pure, G. S. Carr, 292; on the Theory of Mathematical Form, A. B. Kempe, F.R.S., 574
- Matrix Excluder of Draught and Dust, Permanent, T. J. Porter, 569
- Matter, Preliminary Note on the Continuity of the Liquid and Gaseous States of, William Ramsay and Sydney Young, 262
- Matter, on certain Modern Developments of Graham's Ideas concerning the Constitution of, Prof. T. E. Thorpe, F.R.S., 522, 547
- Mauna Loa, Eruption of the Volcano of, 423
- Maw (George): *Narcissus cyclamineus*, 166, 381; Wolves, Mares, and Foals, 297; on some Phenomena connected with the Freezing of Aërated Water, 325; the Crocus, 348
- Maxwell's "Electricity and Magnetism," an Error in, James C. McConnel, 172; Rev. Henry W. Watson, 223; Prof. A. Seydler, 512
- Mazapil Meteoric Iron, William Earl Hidden, 572
- Mean Values, on the Determination of, 120
- Measurements, Theory of Magnetic, Francis E. Nipher, 295
- Measuring-Instruments used in testing Materials, on some New, Prof. W. C. Unwin, F.R.S., 334
- Mechanics, Animal, Dr. B. W. Richardson, 57
- Mechanism of the Flight of Birds studied by Chrono-Photography, M. Marey, 335
- Medical Aspects, Alpine Winter and its, A. Tucker Wise, 170
- Medical Index-Catalogue, A. T. Myers, 196
- Medical Profession, Laws relating to, in the State of New York, 443
- Medical Research, Endowment of, 409
- Medical School in connexion with Dundee University College, proposed, 349
- Medical School of Paris, M. Brouardel elected Dean, 422
- Medical Students, Female, in Paris, Number of, 306

- Midland's Cabinet for Microscope-Slides, 158
 Miall (H. B.), the Use of the Bengal in the Geological Survey of India, 472
 Miasma, New Rhizostomatous, J. Walter Fewkes, 451
 Miasma, Report on the, J. Walter Fewkes, 377
 Melbourne Centennial International Exhibition, 421; First Meeting of the London Commission, 518
 Minite, the New Gun-powder, Accident with, 472
 Mivill (J. C.), on *Comus gloria maris*, 230
 Mors, Longevity of Great, Joseph Jastrow, 10
 Mordenhall (Prof. T. C.), Report on the Charleston Earthquake, 31
 Mental Straining in Young Persons, Bad Results of, 495
 Moadier (M.), Death of, 306
 Mörner (John, F.R.S.), the Life and Labours of, Edward A. Parnell, Prof. T. E. Thorpe, F.R.S., 145
 Mercury, Mass of, Herr Backlund, 85
 Mercury, on the Physical Properties of, 120
 Merrill (Prof. Geo. P.), Deposits of Volcanic Dust, 174
 Metal Films arising from the Disruption of a Kathode, B. Dessau, 333
 Metal Plates, on the Deformation of, by grinding, 333
 Metallic Propionates, 551
 Metals and Alloys, Colours of, Prof. W. Chandler Roberts-Austen, F.R.S., 106
 Metastasis in Man, Effect of Alcohol on, 383
 Meteoric Iron from Augusta County, Virginia, 381
 Meteoric Iron, Mazapil, William Earl Hidden, 572
 Meteorites, Iron: on the Crystalline Structure of, O. W. Huntington, 16; a Fossil found in Coal, Dr. Gurlt, 36; on the Crystalline Structure of Iron Meteorites, O. W. Huntington, 93; on the Explosion of, M. Hirn, 303; Coahuila, O. W. Huntington, 451
 Meteorology: Algiers Observatory, 16; High Temperature in October, Chas. Harding, 18; Investigations into Thunderstorms of July 1884, Prof. Börnstein, 24; Prof. von Helmholtz on the Formation of a Thunderstorm, 24; Sea-Level and Ocean-Currents, Prof. J. S. Newberry, 35; the Squall that capsized H.M.S. *Eurydice*, Hon. K. Abercromby, 36; the Law of Storms in the Eastern Seas, Dr. Doberck, 36; the Recent Weather, 198; F. T. Mott, 173; William Ingram, 173; Rev. W. Clement Ley, 54; the Climate of Carlisle, F. G. Benn, 95; the Gale of October 15-16, 1886, C. Harding, 95; Remarkable Phenomenon in Norway, 159; the Hong Kong Observatory, 229; Meteorological Conditions at the Time of the Eruption of Mount Tarawera, New Zealand, Capt. F. W. Hutton, 322; a Few of our Weather Terms, Rev. W. Clement Ley, 323; Low Barometric Readings, Henry F. Blandford, 344; Army Signal Service in the United States, 349; Comparison of the Daily Forecast issued by the Meteorological Office for the Midland District with the Actual Weather experienced in 1886, G. T. Ryves, 350; Exhibition of Marine Meteorological Instruments and Apparatus, 352; Exhibition of Marine Meteorological Instruments, 443, 491; Meteorological Society, 384, 504; Scottish Meteorological Society, 355; Berlin Meteorological Society, 360; Administration Report of the Meteorological Department, India, 365; Atlantic Weather Charts, 469; Blue Hill Meteorological Observatory, U.S., 472; West Indian Meteorological Confederation, Maxwell Hall, 485; Marine Temperature Observations, Dr. H. R. Mill, 527; Meteorological Stations established by Italian Meteorological Society, 612; Areas of High Pressure, Elias Loomis, 621
 Meteors, 58, 224; Joseph John Murphy on a, 18; Rev. John Hoskyns-Abrahall, 29; E. Parry, 29; Meteor, November 17, 1886, P. L. Sclater, F.R.S., 76; W. F. Denning, 101; Meteor of December 28, 1886, W. F. Denning, 248; Brilliant Meteor seen on the South-West Coast of Sweden, 112; at Holmestrand, 352; in Dalarlia, Central Sweden, 495; in Central Norway, 443; in Vårdalen, Norway, 612; April Meteors, W. F. Denning, 606; Meteors and Auroras, Dr. M. A. Veeder, 126
 Method of measuring the Mutual Induction of Two Coils, 478
 Methyl Alcohol, Thermal Properties of, William Ramsay and Sydney Young, 358
 Methylal, on the Physiological Action of, 336
 Metre, the Measure of the, W. de Fonvielle, 388
 Metronome, Electrical, established at the Paris Opera House, 158
 Metronome, New, 479
 Metzger (Jos. M.) and J. S. Hay, Earthquake in Sierra Leone, 141
 Mexican Codices and Graven Inscriptions, Mrs. Zelia Nuttall, 307, 328
 Miall (L. C.), the Structure and Life-History of the Cockroach, 365
 Michaelis (E.), an Ice Period in the Altai Mountains, 149
 Michigan, University of, Proposed School of Hygiene at, 377
 Microbe of Yellow Fever, 528
 Microscopy: Medland's Cabinet for Microscope-Slides, 158; Flagellated Protozoa in Animals' Blood, Dr. Crookshank, 191; Microscope, on a Perspective, G. J. Birch, 358; Size of Ancient Microscopes, 359; the Value of the New Apochromatic Lenses, 467; the Watson-Draper Microscope, 550; Studies in Microscopical Science, A. C. Cole, 568
 Micro-organisms in Atmosphere, New Method for the Quantitative Estimation of, Dr. P. F. Frankland, 188
 Micro-organisms obtained from Air, some New, G. C. Frankland and Dr. Percy F. Frankland, 477
 Midden, Kitchen, at Ginnerup, Denmark, 112
 Middlemiss (C. S.), Top-shaped Hailstones, 413
 Middlesex County Natural History Society, 167, 335, 454
 Middlesex, North-West, Palæolithic Man in, J. A. Brown, 554
 Migration of Primitive Peoples, 205
 Mill (Dr. H. R.), Marine Temperature Observations, 527
 Milne (Prof. John), Volcanoes of Japan, 19; Seismometry in Japan, 36; Sounding a Crater, 152; Important Points in the History of Earthquake Investigation in Japan, 559
 Mineralogy: O. W. Huntington on the Crystalline Structure of Iron Meteorites, 16; Mineralogical Society, 382; the Relations between Geology and the Mineralogical Sciences, Prof. John W. Judd, F.R.S., 392, 414; Mineral Resources of the United States, 401; Mineralogical Magazine, 423; Catalogue of Minerals in the Australian Museum, 485; the Relation of Tabasheer to Mineral Substances, Prof. J. W. Judd, F.R.S., 488; Mineralogical Study of the Fort Duncan Meteoric Iron, 528; Constituents of Mineral Naphthas, 552; Mineral Physiology and Physiography, Thos. Sterry Hunt, 578
 Mines, Royal School of, and Normal School of Science, Colonel J. F. D. Donnelly, 271
 Minister of Education, Necessity for a, 481
 Minor Planets: No. 262, 497; No. 264, 353; No. 265, M. Bigourdan, 474; New, Prof. C. H. F. Peters, 59, 282; Herr Palisa, 59, 425; Names of, 207, 569; Observations of, 312
 Miocene Vertebrate Fauna, 383
 Mitteilungen of the Vienna Geographical Society, 446
 Mittheilungen aus dem Gebiete des Seewesens, 612
 Mittheilungen of the Zurich Antiquarian Society, 423
 Modern War-Ships, W. H. White, 306
 Modigliani (Dr. E.), Excursion to Island of Nias, 60; Exploration of Nias, Prof. Henry H. Giglioli, 259, 342
 Moduli of Alloys, 333
 Moissan's Researches on Isolation of Fluor, 71
 Moluccas, Proposed Geographical and Geological Exploration of the, Prof. Kan, 182
 Monaco (Prince Albert of), Experiments made to determine the Direction of the North Atlantic Currents, 288
 Monck (W. H. S.): Astronomical Theory of the Great Ice Age, 7; Brightness and Mass of Binary Stars, 402
 Mongalla, Lieut. Baert's Journey up the, 446
 Monotremata and Marsupialia, Embryology of, W. H. Caldwell, 524
 Montagne Noire, French Pyrenees, Age of the Upheaval of, 551
 Montgaudier Cave, the, 119
 Moon, New Map of the, 58
 Moore's (Thos.) Botanical Collections acquired for the Herbarium, Kew Gardens, 495
 Moreland (Prof. S. T.), Lunar Halos, 414
 Morgan (Prof. C. Lloyd): the Beetle in Motion, 7; Abnormalities in the Vertebral Column of the Common Frog, 53; Supernormal Psychology, 290; Abnormality in the Urostyle of the Common Frog, 344; Scorpion Virus, 534
 Morley (Frank), Rule for escaping a Danger, 345
 Morley (John), Study of Literature, 422
 Morphiomaniacs, Characteristics of the Pulse in, 528
 Morphology of Birds, Prof. W. K. Parker, F.R.S., 331

- Morphology of the Wings of Birds, 599
 Morphology of the Sporophore in Mosses, J. R. Vaizey, 358
 Morris (D.): Dispersion of Plants by Birds, 151; Botanical Federation in the West Indies, 248
 Morris's (the late Prof.) Catalogue of British Fossils, 258
 Morse (Edward S.), Ancient and Modern Methods of Arrow-Release, 12
 Mosses, Morphology of the Sporophore in, J. R. Vaizey, 358
 Moth-breeding, Pedigree, Francis Galton, F.R.S., 453
 Mott (F. T.), the Recent Weather, 173
 Mouches (Admiral E.), Longitudes in Brazil, 100
 Mount Tarawera: New Zealand, Meteorological Conditions at the Time of the Eruption of, Capt. F. W. Hutton, 322; Eruption of, 406, 472
 Mountain Ranges, Origin of, T. Mellard Reade, 361, 463; Prof. A. H. Green, F.R.S., 361, 463
 Movements of the Atmosphere, 479
 Mueller (Baron Von), on the Acacias (Wattles) of Australia, 282
 Muir Glacier, the, G. Frederick Wright, 380
 Müller (Dr. G.), Gore's Variable near χ^1 Orionis, 329
 Müller (Dr. Hugo), Recent Progress of Chemical Science, 536
 Müller (Dr. R.), Equinoctial Gales, 612
 Mummy Seeds, Vitality of, Geo. Murray, 582
 Murdoch (John), some Popular Errors in regard to the Eskimos, 518
 Murphy (Joseph John): Meteor, 8; Origin of Species, 76
 Murray (Geo.), Vitality of Mummy Seeds, 582
 Murray (John): Scientific Knowledge in Scotland, 305; Total Rainfall of the Globe, 311
 Murray-Aynsley (H. G. M.), Study of Asiatic Symbolism, 327; the Svastika as both Sun and Fire Symbol, 558
 Muscle, Voluntary, Action of Caffein and Theine upon, T. Lauder Brunton, F.R.S., 599
 Muscles in the Hand and Foot, Variations in the Nerve-Supply of the Lumbricales, 521
 Mu-ic and Mathematics, Prof. J. J. Sylvester, F.R.S., 132
 Mutual Induction of Two Coils, Method of measuring, 478; Prof. G. Carey Foster, F.R.S., 143
 Myers (A. T.), Medical Index-Catalogue, 196
 Myers (Fred. W. H.), Phantasms of the Living, Prof. C. Lloyd Morgan, 290
 Myriapods, Respiration in, M. J. Chalande, 288
 Mythical Zoology of the Far East, 591
 Myzostoma-Cysts in *Antodon rosacea*, the Supposed, Dr. P. Herbert Carpenter, F.R.S., 535
- Naphtha Fountain, Outburst of Natural, at Baku, 352
 Naphtha, on the Constituents of Mineral, 552
Narcissus cyclamineus, G. Maw, 166, 381
 Nasal Index of the Living Subject, 357
 Natal Observatory, Mr. Neison, 85
 National Fish-Culture Association, 112, 350; Consignment of Whitefish Ova to the, 519
 National Science Collections, 252, 272
 National Union of Elementary Teachers, 567
 Nationalities of Bohemia, 518
 Natterer (Johann), his Ornithological Collection at the Vienna Natural History Museum, 204
 Natural History Museum, 15; Additions to, 593
 Natural History, its Rise and Progress in Britain, Prof. Alleyne Nicholson, 148
 Natural History, the Handy, J. G. Wood, 341
 Natural Philosophy, Mr. Maclean, 350
 Natural Science at Oxford, 229
 Naturalist in South America, Notes of a, John Ball, F.R.S., 529, 553
 Naturalist, Field, in Eastern Bengal, 388
 Naumann (Dr.), Physical Geography of Japan, 330
 Navajos, Notes on Certain Traits of Infant, R. W. Shufeldt, 346
 Naval Architects, Institution of, 538
 Naval Geometry, Developments of, 382
 Naval Observatory, United States, 595
 Nebule at Arcetri, Observations of, Wilhelm Tempel, 198
 Neison (Mr.), Natal Observatory, 85
 Nematodes of Beetroot, Destruction of, 455
- Nerve-Supply of the Lumbricales Muscles in the Hand and Foot, Variations in the, with some Observations on the Perforating Flexors, 521
 Nervous System, Sympathetic, Dr. Walter H. Gaskell, F.R.S., 185
 Nests and Eggs, Birds', H. Seebohm, 236
 New England: Planting of Foreign Trees in, 519; Fluvialite Swamps of, 524
 New Guinea: German Exploration in, 403, 615; Proposal to cross South-East, 547
 New York, Laws relating to the Medical Profession in the State of, 443; Educational System in, Andrew S. Draper, 445
 New Zealand: Volcanic Dust from, Prof. T. G. Bonney, F.R.S., 56; Salmon Ova sent to, 112; Coleoptera of, David Sharp, 177; Red Sunsets and New Zealand Eruptions, Lieut.-Colonel A. T. Fraser, 224; Signs of Fresh Disturbances in the Lake District in, 306
 Newberry (Prof. J. S.), Sea-Level and Ocean-Currents, 35
 Newsholme (Arthur), School Hygiene, 604
 Newton's Rings, the Production of, by Plane Soap-Films, H. G. Madan, 583
 Nias: Dr. E. Modigliani's Expeditions to, 60, 259; Prof. Henry H. Giglioli, 342
 Nicaragua, Proposed Canal across, 353
 Nicaragua and Costa Rica, Twelve Jade Objects found in, 496
 Nice, the Great Refracting Telescope of the Bischofsheim Observatory at, 84
 Nicéville (Lionel de), Butterflies of India, H. J. Elwes, 436
 Nichols (Edward L.), and E. H. S. Bailey, the Sense of Smell, 74
 Nicholson (Prof. Alleyne), Natural History, its Rise and Progress in Britain, 148
 Nicols (Dr. W. W. J.): on the Nature of Solution, 64; Super-saturation of Salt-Solutions, 527
 Niederrheinische Gesellschaft für Naturkunde, 36
 Nile Valley North of Khartoum, on the Tribes of the, Sir Chas. Wilson on, 431
 Nile and the Congo, on the Region between the, J. T. Wills, 521
 Nipher (Francis E.), Theory of Magnetic Measurements, 295
 Nitrate of Silver, Action of some Metals on Weak Solutions of, 431
 Nitric Acid, Action of, on Sugar, 432
 Nitrogen and Oxygen, Critical Temperatures of, 331
 Nitrogenous Organic Matter of Soils, on the Condition of the, R. Warington, F.R.S., 403
 Niua-Fu Friendly Islands, Volcanic Eruption in, Prof. T. G. Bonney, F.R.S., 127
 Nixon (R. C. J.), Euclid Revised, 269
 Noble (Capt. Wm.), Hours with a Three-Inch Telescope, 246
 Nolan (James), Tidal Friction and the Evolution of a Satellite, 75
 Nordenskjöld (A. E.), on Atomic Weight of Oxide of Gadolinium, 47
 Nordhainsund, West Coast of Norway, Earthquake at, 158
 Norites of the Cortlandt Series, 524; G. H. Williams, 452
 Normal School of Science and Royal School of Mines, 111
 Col. J. F. D. Donnelly, 271
 Norse Naval Architecture, G. K. Boehmer, 445
 North America, Great Britain, and Ireland, Comparative Studies upon Glaciation of, Prof. H. Carvill Lewis, 89
 North Atlantic Currents, Experiments made to determine the Direction of the, Prince Albert of Monaco, 288
 North Sea, Exploration of the, 73
 Norway: Science in, 122; New Journal of Science, 356; Remarkable Meteor in, 159; Proposal for fixing a Standard Time for, 280; Brilliant Meteor seen in, 443; Earthquakes in, Dr. Hans Reuch, 517; Leprosy on the West Coast of, 599
 Notation of Kinship, Algebraic, Prof. Alex. Macfarlane, 126
 Nott (J. Fortuné), Wild Animals Photographed and Described, 220
 Noury (Le P. Ch.), Geology of Jersey, 412
 Nova Orionis, Gore's, M. Dunér, Herr Schwab, 85
 Number, Theory of, 477
 Nuovo Giornale Botanico Italiano, 212, 405
 Nuttall (Zelia), Mexican Codices and Grav. n. Insertions, 307, 328
 Nyt Magazin for Naturvidenskaberne, 356

- letter (Herr J. B.), Death of, 612
- Algeria: the, 16; Ben Nevis, 517; Amount of the Rainfall at, 357; A. Rankin, 583; Blue Hill Meteorological, U.S., 472; Baron D'Engelhardt's, 546; Harvard College, 497; Prof. Pickering, 424; Kalocsa, Dr. C. Braun, 19; Report of the Leander McCarmick, 35; Madras, Mr. Popson, 282; Note on Earthquake of February 23, at Marseilles, 455; Report of the Natal, 85; Observatory of Rio de Janeiro, transferred to Santa Cruz, 593; Report of the Rousdon, 353; Sonnblick, 519; Temple, Mr. Scabroke, 401; U.S. Naval, 595; Washington, 308, 514; Captain R. L. Phythian, 569; for Women in America, 229
- an, the, Otto Krümmel, 6
- an Air, Purity of, 595
- ans, Similarities in the Physical Geography of the Great, J. Y. Buchanan, 33, 76
- us (Dr.), on the Age of certain Parts of the South American Andes, 547
- ctober, High Temperature in, Charles Harding, 18
- dell (W.), Industrial and High Art Education in the United States, J. Edwards Clarke, 97
- gorodnikoff (M.), Tin-Mines near Meshed, 376
- vé, Maps of the River, in West Africa, 353
- o, Great Serpent Mound in, W. H. Holmes, 281
- oil, the Use of, in lessening the Effect of Dangerous Seas, 63, 376
- oktibehite or Awaruite, Dr. Jas. Hector, F.R.S., 513
- Oldham (R. D.), Supposed Suicide of the Cobra, 560
- Oldhamia, on, 515; Prof. T. G. Bonney, F.R.S., 581
- Olive Oils, Characteristic Properties of, 383
- Oliver (Capt. Samuel Pasfield), Madagascar, 149
- Olszewski (M.): Critical Temperatures of Nitrogen and Oxygen, 331; his Experiments, 592
- omond (R. T.): Green Light at Sunset, 391; Solar Halos, 582
- onin, Rev. Thos. Brydges on the Curious Subdivision of Labour among the People of, 283
- onheim (Dr. H.): Comet Barnard (1836 f), 85; Comet 1887 c (Barnard, January 23), 424
- Oppermann (M.), Earthquakes, 600
- Oppölzer (Theodor von): on Astronomical Refractions, 17; Obituary Notice of, 224
- Orbit of the Binary Star 14 (δ) Orionis, J. E. Gore, 569
- Orchids, Fungus on, 230
- Ordinance Survey of the United Kingdom, Lieut.-Colonel T. Pilkington White, 170
- O'Reilly (Prof. J. P.): the Recent Earthquakes, 197; on Two Jade-handled Brushes, 318
- Organic Analysis, Commercial, Alfred H. Allen, Dr. C. R. Alder Wright, 293
- Organic Evolution, Factors of, Herbert Spencer, Dr. Geo. J. Romanes, F.R.S., 362
- Organism, Demonstration of Active Oxygen in the Living, 383
- of Mountain Ranges, T. Mellard Reade, Prof. A. H. n, F.R.S., 361, 463
- Origin of Species, Joseph J. Murphy, 76; Edmund Catchpool, 76; Dr. Geo. J. Romanes, F.R.S., 124
- Orinoco, Exploration of the, M. Chaffajou, 446
- Orionis, Orbit of the Binary Star 14 (δ), J. E. Gore, 569
- Orionis, χ^1 , Gore's Variable near, Dr. G. Müller, 329
- Ormerod (Eleanor A.), on the Hessian Fly and Barley, 256
- Ornithology: H. Seebohm's Specimens of Siberian Birds, 15; the Birds of Central Asia, 204; the Auk, 204; the Birds of Tasmania, 204; Types of Birds in the Vienna Natural History Museum, 204; Arctic Species of Birds, Henry Seebohm on, 256; Ornithological Observations in Belgium, 173; Additions to the Natural History Museum, 593
- (A. F., F.R.S.), on the Forms of Clouds, 164
- Otago University Museum, Notes from the, Prof. T. Jeffery Parker, 238
- Otaria hookeri at the Zoological Gardens, 327
- Otocysts in Invertebrates, a New Function of the, Yves Delage, 48
- Owen (Sir Richard, F.R.S.), on the Skull and Dentition of *Galesaurus planiceps*, 94; *Thylacoleo carnifex*, 111; *Thylacoleo*, Fossil, Lower Jaw of, 142
- Owen (T. C.), Tea Planter's Manual, 268
- Owens College, the, Joseph Thompson, 385
- Ox-Warble, Enormous Loss from, John Walker, 7; Dr. John Wrightson, 29
- Oxford: Natural Science at, 229; General Pitt-Rivers' Anthropological Collection at Oxford University Museum, 349; Readership in Geography at, 475
- Oxidation, Atmospheric, Note on the Development of Voltaic Electricity by, C. R. Alder Wright, F.R.S., 598
- Oxide of Lead, Action of the, on some Dissolved Chlorides, 382
- Oxygen, Active, in the Animal Organism, Dr. Gad, Dr. Wurster, 383
- Oxyhydrogen Light, the Zirconia, Lewis Wright, 583
- Oyster-Culture in France, 400, 495
- Oyster-Culture in Germany, 400
- Oyster-Fisheries of Isle of Wight, 57
- Oyster-Fisheries of Tasmania, 233
- Ozone, Dr. A. Tucker Wise, 584
- Ozone, Production of, 248
- Ozone Papers in Towns, Dr. W. J. Black, 76
- Palæobotany in Goebel's "Outlines of Classification and Special Morphology of Plants," on some Observations on, Prof. W. C. Williamson, F.R.S., 535
- Palæolithic Man in North-West Middlesex, J. Allen Brown, 554
- Palæolithic Workshop Floor of Drift Period near Ealing, Discovery of, J. Allen Brown, 189
- Palæontology: on the Skull and Dentition of a Triassic Saurian, *Galesaurus planiceps*, Sir R. Owen, F.R.S., 94; the Cetacea of the Suffolk Crag, R. Lydekker, 94; on a Jaw of *Hyotherium* from the Pliocene of India, R. Lydekker, 94; Discovery of Rare Fossils at Sydney, 159; Discovery of Skull of *Ceratodus* in Austria, 181; Fossil Chilostomatous Bryozoa from New Zealand, A. W. Waters, 190; Purchase of the Hillcock of Sansan by the French Government, 328; Palæontological Researches near Rheims, 407
- Palisa (Herr), New Minor Planet, 59, 425
- Palissy, the, of Calico Printing, the Life and Labours of John Mercer, F.R.S., Edward A. Parnell, Prof. T. E. Thorpe, F.R.S., 145
- Papers, Ozone, in Towns, Dr. W. J. Black, 76
- Parallel, to prove that only One, can be drawn from a given Point to a given Straight Line, Dr. E. Budden, 92
- Parallax, Stellar, Prof. Asaph Hall, 258
- Parallax of the Sun, New Method of determining the, 455
- Parallax of α 1516, the, M. O. Struve, 546
- Paris: Academy of Sciences, 23, 47, 71, 96, 119, 144, 167, 191, 263, 287, 312, 335, 359, 382, 407, 431, 454, 479, 503, 527, 551, 575, 599, 624; Astronomical Prizes of the, 258; Paris Geographical Society, 60, 180, 182, 354; Bulletin of the, 353; Proposed Telephonic Line: between Paris and Brussels, 133; Number of Female Medical Students in, 306; New Medical Paper to be published in, 376; Alpine Flora Surviving in the Paris District, 431; Meeting of the French Congrès de Chirurgie in, 444; New Building for the Laboratories of the Paris Medical School, 473; Bad Results of Mental Straining in Young Persons at Paris Academy of Medicine, 495; Alteration in the Mode of Competition for Fellowships of Paris Medical Faculty, 517; Proposed Telephone Line from Paris to London, 544; Statistics in Paris, 568; Astronomical Congress, 584
- Parker (Prof. T. Jeffery), Notes from the Otago University Museum, 208
- Parker (Prof. W. K., F.R.S.), Morphology of Bird, 331
- Parker (W. Newton), Comparative Anatomy of Vertebrates, Robert Wiedersheim, 121
- Parnell (Edward A.), the Life and Labours of John Mercer, F.R.S., Prof. T. E. Thorpe, F.R.S., 145
- Parry (E.), Meteors, 29
- Pasterz Glacier, Rate of Movement of the, Herr Ferdinand Seeland, 520
- Pasteur, Institute, the, 83; Statistics of Persons treated at the, 335; Treatment of Rabies, 30
- Pathological Anatomy and Pathogenesis, a Text-book of, E. Ziegler, 246
- Pathology, an Introduction to General, J. B. Sutton, 26
- Paulus (A.) and A. Bouinai, La France en Indo-Chine, 221
- Paws, Cats', Abnormality in, J. Herbert Hodd, 53; E. W. Claypole, 345; Dr. H. A. Hagen, 345
- Peach (C. W.), Memorial Fund, 83

- Peal (S. E.), Lunar Glaciation, 100.
 Pearls and Pearling Life, Edwin W. Streeter, 339
 Pedigree Moth-breeding, Francis Galton, F.R.S., 453
 Peek (Mr.), Report on Rousdon Observatory, 353
 Penfield (Sam. L.), Phenacite from Colorado, 451
 Pennsylvania, North-Eastern, Thickness of the Ice in, during the Glacial Epoch, 141
 Peppe (T. F.), on the Cultivation of the so-called Wild Silks of India, 256
 Peripatus, Species of, obtained in British Guiana, 381
 Peristaltic Movement, Prof. Falk, 264
 Pernet (Dr.), on the Determination of the Air in the Vacuum of the Barometer, 72; Comparison of Barometers, 600
 Peronospora of the Vine, 382
 Peroxide of Hydrogen, Formation of, by Electrolysis, Dr. Richarz, 384
 Perrin (M. R.), on the Theory of Algebraic Forms with p Variables, 335
 Perry (Rev. S. J., F.R.S.), the Earthquake, 438
 Perthshire Society of Natural Science, 206
 Petermann's Mitteilungen, 182, 232, 353, 403, 475
 Peters (Prof.), New Minor Planets, 59, 282
 Petrie (Prof.), Siberia as a Colony, 158
 Petrography, H. Rosenbusch, Dr. Fred. B. Hatch, 482
 Petroleum, Russian, the Coming Deluge of, C. Marvin, 120, 295
Petromyzon fluviatilis, some Points in the Development of, 404
 Petunias and Insects, J. W. Slater, 70
 Phantasms of the Living, Edmund Gurney, Fred. W. H. Myers, and Frank Podmore, Prof. C. Lloyd Morgan, 290; Edmund Gurney, 345
 Phenacite from Colorado, Sam. L. Penfield, 451
 Philadelphia, the Wagner Free Institute of Science, 230; Museum of the Academy of Natural Sciences, 424
 Philiatra, Earthquake Shocks in, 444
 Philippine Archipelago, Exhibition of the Products of, 567
 Philippine Islands, Tinguians of the, 446
 Philippines, Folk-Lore Society established in the, 134
 Phillips (Alfred), the Application of Gems to the Art of the Goldsmith, 495
 Phillips (John Arthur, F.R.S.): Obituary Notice of, 248; Death of, 382
 Phillips (Samuel), Old or New Chemistry, Which is fittest for Survival? 270
 Philosophical Transactions of the Royal Society, 399
 Phosphorescence of Marine Fish, Dr. Otto Hermes, 377
 Phosphorescent Alumina, Crimson Line of, William Crookes, F.R.S., 310
 Photography: Celestial, 35; Stellar Photography at Harvard College, Prof. Pickering, 37; Marion's Practical Guide to Photography, 52; Wild Animals Photographed and Described, J. Fortuné Nott, 220; Photography the Servant of Astronomy, Edward S. Holden, 317; Progress of Astronomical, 321; Instantaneous Shutters, 324, 366; Mechanism of the Flight of Birds studied by Chrono-Photography, M. Marey, 335; Photo-Micrographs, Dr. van Heurck, 359; Application of, to the Determination of Stellar Parallax, Prof. Pritchard, 377; Convention of Photographers in the Hall of the Society of Arts, 377; Photograph of the Nebula No. 1180, M. Mouchez, 407; Photographic Chart of the Heavens, proposed, 567; Use of Eosin Silver in Photography, 432; Measurement of the Photographic Plates of the Transit of Venus 1882, 455
 Phylloxera, Incubation of, during the Winter Season, 431, 600
 Phylogeny of the Camelidæ, 568
 Physical Geography of the Great Oceans, Similarities of the, J. Y. Buchanan, 33, 76
 Physical Geography of Japan, Dr. Naumann, 330
 Physical Geography of Australia, Manual of, H. Beresford de la Poer Wall, 389
 Physical History of the Bagshot Beds of the London Basin, Rev. A. Irving, 382
 Physical Notes, 331
 Physical Society, 94, 143, 334, 383, 478, 526, 575
 Physical Quantities, the *Engineer* on Dimensions of, 462
 Physics, Chemical, Prof. Josiah Parsons Cooke, 100
 Physiology: on the Connexion between Physiological Action and Chemical Constitution, Dr. James Blake, 6; Experimental Researches on the Cerebral Functions, Brown-Séquard, 47; a New Function of the Otocysts in the Invertebrates, Yves Delage, 48; Mr. Wallace on Physiological Selection, Dr. Geo. J. Romanes, F.R.S., 247, 366, 390; Proposal to devote the Legacy bequeathed by Sir Erasmus Wilson to Physiological and Pathological Research, 280; Preyer's French Translation of "Physiology of the Embryo," 376; Mineral Physiology and Physiography, Thos. Sterry Hunt, 578; Contributions to our Knowledge of the Connexion between Chemical Constitution and Physiological Action, Preliminary Communication on the Action of certain Aromatic Bodies, T. Lauder Brunton, F.R.S., and J. Theodore Cash, 599
 Phythian (Capt. R. L.), Washington Observatory, 569
 Phytobiological Observations, Sir J. Lubbock, 430
 Piano, on the Time of Contact between the Hammer and String in a, 141
 Pickering (Prof. S. U.): Stellar Photography at Harvard College, 37; Harvard College Observatory, 424; Influence of Temperature on the Heat of Dissolution of Salts, 453
 Pierie (Dr. Victor), Death of, 16
 Pierre (M.), Pension to, 545
 Pigeons, Sparrows chasing Two, 536; J. Jenner Weir, 584
 Pigeons, Fancy, Books on, 544
 Pisciculture: Spawning of Brook Trout, 16; the Acclimatisation of German Carp, 58; the Lochbuie Observatory, 58; Exportation of Salmon Ova to Antipodes, 181; Fish-hatching at the National Fish-Culture Association, 159
 Pitt-Rivers' (General) Anthropological Collection at Oxford Museum, 349
 Plane Geometry, the Elements of, 27
 Plane Soap-Films, the Production of Newton's Rings by, H. G. Madan, 583
 Planets, Minor: No. 262, 497; No. 264, 353; No. 265, M. Bigourdan, 474; Names of, 207, 569; New Minor, Herr Palisa, 59, 425; Prof. C. H. F. Peters, 59, 282: Observations of, 312
 Plant which destroys the Taste of Sweetness, W. T. Thiselton Dyer, F.R.S., 557
 Plants, how to make Colourless Specimens of, to be preserved in Alcohol, Prof. Hugo de Vries, 149; Selmer Schönland, 173
 Plants by Birds, Dispersion of, D. Morris, 151
 Plants, Outlines of Classification and Special Morphology of, Dr. K. Goebel, 577
 Plummer (John I.), Barnard's Second Comet, 583
 Plunkett (Major E. T.), Walks in Cairo, 256
 Podmore (Frank), Phantasms of the Living, Prof. C. Lloyd Morgan, 290
 Pogon (Mr.), Madras Observatory, 282
Polacanthus foxii, Note on, J. W. Hulke, F.R.S., 357
 Polar Expeditions, British International, 147
 Polar Stars, Reduction of the Positions of Close, from one Epoch to another, Prof. W. A. Rogers and Miss Anna Winlock, 231
 Polarisation, Magnetic Rotatory, on the Cause of, 141
 Polarising Prisms, on the Cutting of, Prof. Silvanus P. Thompson, 184
 Poles in Magnets, Determination of the, 479
 Porter (T. J.), Permanent Matrix Excluder of Draught and Dust, 569
 Portugal, Consignment of German Carp forwarded to, 350
 Potanin (M.), M. Skassy, and M. Bérésowsky, Return of, from their Expedition to China and Mongolia, 309
 Potassa, Glycerinate of, M. de Forcrand, 288
 Potato Tercentenary, 16, 175
 Pouchet, *Gymnodinium polyphemus*, 48
 Poulton (Edward B.): Observations on Heredity in Cats with an Abnormal Number of Toes, 38; Gilded Chrysalides, 470; the Gecko moves its Upper Jaw, 511
 Power, Transmission of, by Compressed Air, 272
 Pre-Scientific Theories of the Causes of Earthquakes, 428
 Preece (W. H., F.R.S.), on the Limiting Distance of Speech by Telephone, 501
 Prehistoric Man, A. de Quatrefages, 23
 Prehistoric Races, European, Prof. A. H. Keane, 564
 Prehistoric Remains in America, 476
 Prehistoric Station in the Wood of Chaville, Discovery of, 613
 Pressure, Vertical Decrement of Temperature and, S. A. Hill, 606
 Preyer's "Physiology of the Embryo," French Translation of, 376
 Price (F. G. Hilton), Vitality of Seeds, 463

- Primitive Marriage," Reprint of McLennan's, Dr. W. Robertson Smith, 3
 imoses, W. Botting Hemsley, 561
Amula imperialis, 430
 ingheim (Dr.), Chemical Action of Light on Mixed Hydrogen and Chlorine Gas, 552
 iority, a Claim of, V. Ventosa, 513; Prof. H. S. Hele Shaw, 581
 isms, on the Cutting of Polarising, Prof. Silvanus P. Thompson, 184
 itchard (Prof.), Application of Photography to the Determination of Stellar Parallax, 377
 oceedings of the Liverpool Geological Society, 133
 oessorships, *Science* on advertising for Candidates for Vacant, 229
 otoplasm, Prof. H. Marshall Ward, 300
 otoplasm, Living, Method for subjecting, to the Action of Different Liquids, 452
 ychical Research, American Society for, 281
 ychology, American Journal of, 400
 ychology, Supernormal, Phantasms of the Living, Edmund Gurney, Fred. W. H. Myers, and Frank Podmore, Prof. C. Lloyd Morgan, 290, 345
 armigan, the, Robert Service, 445
 illeys and Drums, Trains of, Prof. H. Hennessy, F.R.S., 452
 gmy Tribes in Africa, 497
 rometers, and Seismometers, Sounding a Crater, Fusion-Points, Dr. H. J. Johnston-Lavis, 197; W. Worby Beaumont, 296
 rometers and Fusion-Points, Thos. Andrews, 224
- radient Electrometers, 331
 antin (M. H.), on the Action of Tetrachloride of Carbon on Chlorochromic Acid and the Phosphates of Sesquioxide, 335
 arterly Journal of Microscopical Science, 404
 artz, Pyro-Electricity of, B. von Kolenko, 333
 aternary Beds of Nevada, finding of a Spear-head in the, 476
 aternary Deposits in Western New York, Prehistoric Hearth under the, 476
 atrefages (A. de): on Prehistoric Man, 23; *Histoire générale des Races humaines*, 389
 edenfeldt (Lieut.), Ethnological Collection presented to the Anthropological Society by, 423
 een, Sanitary Progress during the Reign of the, Capt. Douglas Galton, F.R.S., 160
 een's Jubilee in India, 349
 incke (Prof. G.), Dielectric Constants of Fluids, 334
- abbit, the Australian, 569
 abies, M. Pasteur's Treatment of, 30
 aces, European Prehistoric, Prof. A. H. Keane, 564
 aces humaines, *Histoire générale des A. de Quatrefages*, 389
 adiant-Matter Spectroscopy, on Examination of the Residual Glow, W. Crookes, F.R.S., 425, 447
 adiation of Light, Peculiar, Robert D. Gibney, 536
 adio-Micrometer, Preliminary Note on, C. Vernon Boys, 549
 adiophony, A. Heritsch on, 333
 ailways, Inauguration of, in France, 407
 ain-band Observations at the Ben Nevis Observatory, A. Rankin, 588
 ainfall of the Globe, Total, John Murray, 311
 alstonite, Chemical Composition of, 141
 ambaut (A. A.), Spectroscopic Method of determining the Distance of a Double Star, 206
 ansay (Prof. William) and Dr. Sydney Young: Preliminary Note on the Continuity of the Liquid and Gaseous States of Matter, 262; on Clausius's Formula, 346; on Thermal Properties of Methyl Alcohol, 358
 ance (C. E. De), Folkestone Gault, 296
 ankin (A.), Rain-band Observations at the Ben Nevis Observatory, 588
 ats at the South Kensington Exhibitions, 205
 u (B. Hanumanta), First Lessons in Geometry, 269
 ayleigh (Lord, F.R.S.), on the Intensity of Reflection from Glass and other Surfaces, 64
 ys and Bands, Law of Distribution of the Common to several Spectra of Bands, 576
- Reade, (T. M.), Origin of Mountain Ranges, Prof. A. H. Green, F.R.S., 361, 463
 Recording Hygrometers, 331
 Red Colour of Sirius, Alleged Ancient, 378, 391
 Red Sea Coast, Italian Possessions on the, 446
 Red Spot on Jupiter, Rotation-Time of the, Prof. Young, 181
 Red Star, New, 546
 Red Sunsets and New Zealand Eruptions, Lieut.-Col. A. T. Fraser, 224
 "Red Wood," on the Formation of the so-called, in the Fir and Epicea, 383
 Red Worm, William Burgess, 445
 Reefs, Coral, of the Solomon Islands, Dr. H. B. Guppy, 77
 Reefs, Long Lost, Capt. W. J. L. Wharton, F.R.S., 347
 Reflection from Glass and other Surfaces, on the Intensity of, Lord Rayleigh, F.R.S., 64
 Refraction Tables, Corrections to, Prof. Cleveland Abbe, 134
 Refractions, Astronomical, Herr Oppölzer's, 17
 Refractions, Schaeberle's Short Method for computing, 329
 Reichenbach (Dr. Reinhold von), Death of, 444
 Reid (Clement), Coombe Rock, 502; Earthquake in the Riviera, 534
 Reilly (Robert James), Aspects of Clouds, 391
 Reinold (Prof. A. W., F.R.S.), Lecture on Soap Bubbles, 229
 Rendiconti della R. Accademia dei Lincei, 405
 Rendiconti del Reale Istituto Lombardo, 286, 357, 405, 477, 524
 Residual Affinity, Valency and, Prof. H. E. Armstrong, F.R.S., 570, 596
 Residual Glow, Examination of the, on Radiant-Matter Spectroscopy, W. Crookes, F.R.S., 425, 447
 Respighi (L.), on the Objective Spectroscope, 405
 Reuch (Dr. Hans), Earthquakes in Norway, 517
 Revolving Spheres, Aërial Vortices, or Experiments on, Ch. Weyher, 514
 Revue d'Anthropologie, 22, 187, 357, 495
 Revue mensuelle d'Astronomie populaire de Météorologie, et de Physique du Globe, 310
 Rheostat, a Wire Tape, A. Grosse, 334
Rhinolophus ferrum-equinum, Drawings of the, in the *Zoologist*, 256
 Riccò (Prof. A.), Barnard's Comet at Perihelion, 296; Green Light a. Sunrise and Sunset, 584
 Richardson (Dr. B. W., F.R.S.), Animal Mechanics, 57
 Richarz (Dr.), Formation of Peroxide of Hydrogen by Electrolysis, 384
 Ridley (H. N.), Proposed Expedition to Fernando Noronha, 228
 Righi (Prof. Augusto), on the Cause of Magnetic Rotatory Polarisation, 141
 Right Hand and Left-Handedness, Dr. Daniel Wilson, 307
 Rink (Dr. H.), the Eskimo, Prof. A. H. Keane, 309
 Rio, Longitude of, Prof. C. A. Young, 172
 Rio de Janeiro, Observatory of, 593
 Rivers, List of 374, Dr. von Klöden, 354
 Riviera, Earthquake in the, Clement Reid, 534
 Rivista Scientifico-Industriale, 141, 237, 357, 405, 524
 Rix (Herbert) Royal Society's *Soirée*, 607
 Roberts-Austen (Prof. W. Chandler, F.R.S.), Colours of Metals and Alloys, 106
 Robinson (H.), Hydraulic Power and Hydraulic Machinery, Major Allan Cunningham, 460
 Rocks: on the Texture of Massive, 381; Abrasion of, 383; Notes on the Structure and Relations of some of the Older Rocks of Brittany, Prof. T. G. Bonney, F.R.S., 550; Rocks of the Malvern Hills, Frank Kutley, 623
 Rodriguez, Cochenille at, 179
Rogeria longiflora, 158
 Rogers (Prof. W. A.) and Miss Anna Winlock, Reduction of the Position of Close Polar Stars from one Epoch to another, 231
 Roman Dominion, on the Establishment of the, in South-East Britain, Sir G. B. Airy, F.R.S., 562
 Romanes (Dr. Geo. J., F.R.S.): Origin of Species, 124; Mr. Wallace on Physiological Selection, 247, 366, 390; Factors of Organic Evolution, Herbert Spencer, 362
 Rome, First General Meeting of the International Statistical Institute at, Preparations for, 356; Monument to Galileo in, 612
 Roscoe (Sir H. E., F.R.S.), a Treatise on Chemistry, 316

- Rosenbusch (H.), Petrography, Dr. Fred. B. Hatch, 482
 Rosser (W. H.), Deviation of the Compass in Iron Ships considered practically, 437
 Rostock, University of, Removal of Lamarck's Herbarium from, 312
 Rotation-Time of the Red Spot on Jupiter, Prof. Young, 181
 Rotatory Polarisation, Magnetic, on the Cause of, 141
 Rousdon Observatory, Report of, 353
 Rowland (Prof. Henry A.), Wave-Length of the Lines of the Solar Spectrum, 524
 Rowney (Thos.), Tabasheer, 512
 Roy (Chas.), Cambridge Cholera Fungus, 223
 Royal Agricultural Society of England, Journal of the, Prof. John Wrightson, 148
 Royal Geographical Society, New President of the, 615
 Royal Institution, Lecture Arrangements, 133
 Royal Meteorological Society, 95, 335, 406, 527
 Royal Microscopical Society, 191, 359, 550
 Royal Navy and the Merchant Service, Connexion between the, Sir Nathaniel Barnaby, 538
 Royal School of Mines, Normal School of Science and, Col. J. F. D. Donnelly, 271
 Royal Society, 34, 83, 142, 165, 188, 262, 287, 310, 334, 357, 381, 430, 452, 477, 501, 524, 549, 598, 622; Anniversary Address by Prof. G. G. Stokes, F.R.S., 113; Royal Society and Scientific Federation, Prof. Huxley, F.R.S., 289; Philosophical Transactions of, 399; Annual General Meeting, 406; *Soirée*, Herbert Rix, 607
 Royal Society of Göttingen, Prize offered by the, 350
 Royal Society of New South Wales, 71, 305
 Royal Society of Victoria, Transactions and Proceedings of the, 473
 Rücker (Prof. A. W., F.R.S.), Critical Mean Curvature of Liquid Surfaces of Revolution, 143
 Rule for escaping a Danger, Frank Morley, 345
 Russian Central Asia, Proposed Administrative Changes in, 258
 Russian Petroleums, 120
 Russian Petroleum, the Coming Deluge of, C. Marvin, 295
 Rust, Nature and Genesis of, 539
 Rutley (Frank), the Metamorphic Rocks of the Malvern Hills, 190
 Rutot (A.) and E. Van den Broeck, Observations nouvelles sur le Tuffeau de Cibly, et sur le Crétacé supérieur du Hainault, 317
 Ryves (G. T.), Comparison of the Daily Forecast issued by the Meteorological Office for the Midland District with the Actual Weather experienced in 1886, 350
- Saharanpur, Report on the Botanical Garden, Mr. Duthie, 356
 St. Domingo, Botanical Investigation of the Higher Mountains of, Dr. Urban, 494
 St. Petersburg, University of, Sixty-eighth Anniversary of, 422
 Salmon Ova sent to New Zealand, 112
 Salomons (Sir David), Complete Hand-book on the Management of Accumulators, 603
 Salt-Solutions, Supersaturation of, Dr. W. W. J. Nicol, 527
 Salts, Influence of Temperature on the Heat of, Dissolution of, Prof. S. U. Pickering, 453
 Sandstone of Organic Origin, 407
 Sanitary Assurance Association, Sixth Annual Meeting of, 375
 Sanitary Conditions of the City of York, 423
 Sanitary Institute of Great Britain, 257
 Sanitary Legislative Conference, 593
 Sanitary Progress during the Reign of the Queen, Capt. Douglas Galton, F.R.S., 160
 Sanitary Registration of Buildings Bill, 282, 352
 Sankuru, Dr. Wolf's Exploring Work on the, 520
 Sansan, Purchase by the French Government of the Hillock of, 328
 Sardine-fishing, 383
 Sardines, on the Food of the, 479
 Satellite, Evolution of a, Tidal Friction and the, James Nolan, 75
 Saturn, Six Inner Satellites of, Prof. Anaph Hall, 257
 Scarpoids, Culminating, Prof. John Cleland, 391
 Savages, Sir John Lubbock's, F.R.S., Lecture on, 255
 Savory (W. S., F.R.S.), John Hunter, 379
 Sawyer (Edward), Observations of Variable Stars in 1885, 378
 Scarlet Fever, Etiology of, E. Klein, F.R.S., 452
 Schaeberle (Mr.), a Short Method for computing Refractions, 329
 Schäfer (Prof. E. A., F.R.S.), Cerebral Localisation, 438, 464
 Schiller (Herr), Radius of the Circle of Protection of Lightning-Rods, 376
 Schinz (Dr. Hanz), Lake Ngami Region, 547
 Schizonemertians, Peculiarities in the Organisation of the, 336
 Schleswig-Holstein, Effects of Lightning in, 360
 Schönland (Selmer), how to make Colourless Specimens of Plants to be preserved in Alcohol, 173
 School Hygiene, Arthur Newsholme, 604
 Schorlemmer (C.), a Treatise on Chemistry, 316
 Schöyen (Herr), *Tylenchus hordei*, 336
 Schuster (Arthur, F.R.S.), Total Solar Eclipse of August 29, 1886, 549
 Schwab (Herr), Gore's Nova Orionis, 85
 Science and Art, 544
 Science, Art and, in a New Light, 250
 Science and Art Department, Calendar and General Directory of the, 320
 Science and Art Department, Speeches in the House of Commons on, 443
 Science Collections, National, 252, 272
 Science, English and American Professors, Difference in the Number of Lectures given by, 351
 Science, Experimental, in Schools and Universities, Prof. G. F. Fitzgerald, 284
 Science and the Jubilee, 217, 241
 Science, Lunar, Rev. Timothy Harley, 246
 Science, Normal School of, and Royal School of Mines, Col. J. F. D. Donnelly, 271
 Science in Norway, 122
 Science, Popular Lectures on, 35
 Science in the Secondary Schools of America, Present Position of, Pres. Eliot, 375
 Scientific Basis of the Proposed Imperial Institute, 254
 Scientific Federation, 289
 Scientific Knowledge, First Year of, Paul Bert, 221
 Scientific Knowledge in Scotland, 305
 Scientific Papers, Joint, of James Prescott Joule, F.R.S., 461
 Scientific Relief Fund, Sir William Armstrong, 349
 Scientific Renaissance in Italy, 350
 Scientific Research, Mrs. Elizabeth Thompson's Fund for the Advancement of, 471
 Scientific Results of the Exploring Voyage of the *Challenger*, Report of the, 351
 Scientific Societies, Local, and the British Association, 78
 "Scientist," Meaning of the Word, 519
 Sclater (P. L., F.R.S.), Meteor, 76
 Scorpion Virus, Sir J. Fayer, F.R.S., 488; Prof. C. Lloyd Morgan, 534
 Scorpions, Do they commit Suicide? 590
 Scortechini (Father), Death of, 157
 Scotland: Fishery Board for, Fourth Annual Report of the, 128; Fish-Culture in, 205; Scientific Knowledge in, 305; Trial of University Extension Scheme in, 327; Scottish Geographical Magazine, 334; Scottish Meteorological Society, 355, 544; Value of Fish landed on the Coasts of, 473; Scottish Naturalist, 474; Physical and Biological Work at Scottish Marine Station, 575
 Sea, Earthquake at, Reginald H. Hertslet, 157
 Sea, Official Report on the Use of Oil at, for modifying the Effect of Breaking Waves, 63
 Sea-Level and Ocean-Currents, Prof. J. S. Newberry, 35
 Sea-Lion, or Eared Seal of the Auckland Islands, Specimens of, at the Zoological Gardens, 377
 Sea-Trout in the Delaford Park Fishery, 519
 Seabroke (Mr.), Temple Observatories, 401
 Seal, West Indian, *Monachus tropicalis*, Henry A. Ward, 392
 Seal-Fisheries, W. H. Emory's Investigation of, 351
 Seals destructive to Fisheries, 177
 Seas, Law of Storms in Eastern, Dr. W. Doberck, 135
 Sedgwick (W. T.), General Biology, 413
 Sedgwick Memorial Museum, Cambridge, Sites for, 494
 Sée (Prof. G.), Diet in Disease, 327
 Seebohm (Henry): Specimens of Siberian Birds, 15; Birds' Nests and Eggs, 236; Arctic Species of Birds, 256

- Seedlings, the Forms of, the Causes to which they are due, Sir John Lubbock, F.R.S., 235
- Seeds, Vitality of, 414; F. G. Hilton Price, 463; L. Biomefield, 463; Dr. L. Martin Klein, 463; Geo. Murray, 582
- Seeland (Herr Ferdinand), on the Rate of Movement of the Pastern Glacier, 520
- Seelberg, Further Excavations in, 518
- Seeliger (Prof.), Influence of Astigmatism in the Eye on Astronomical Observations, 59
- Seismology: Volcanoes of Japan, Prof. Milne, 19, 36; Seismometry in Japan, Prof. J. A. Ewing, 75, 172, 606; Thomas Gray, 126, 198; the Recent Earthquakes, Prof. J. P. O'Reilly, 197; Sounding a Crater, Fusion-Points, Pyrometers, and Seismometers, Dr. H. J. Johnston-Lavis, 197; W. Worby Beaumont, 296; Report on the Charleston Earthquake, Prof. T. C. Mendenhall, 31; Earthquakes, Thos. W. Kingsmill, 319; Earthquake at Aquila, 376; at Vilayet Konia, 376; Earthquake in Japan, 399; Earthquake Shock at Tashkend, 399; Pre-scientific Theories of the Causes of Earthquakes, 428; the Earthquake, Rev. J. S. Perry, F.R.S., 438; Seismological Society of Japan, 518; Seismic Phenomena of February 1887, 575
- Seki Sekiya on the Comparison of Earthquakes, 593
- Selborne Society, Letters on the Objects and Work of, 328
- Selection, Physiological, Mr. Wallace on, Dr. Geo. J. Romanes, F.R.S., 390
- Self-Induction: Lecture Experiment in, Shelford Bidwell, 526; on the Determination of the Coefficient of, 551
- Sensation and Movement, Ch. Féré, 518
- Sense of Smell, Edward L. Nichols and E. H. S. Bailey, 74
- Sensitive Hygrometers, 331
- Serous Albumen, Prof. Kronecker on, 504
- Serpent Mound in Ohio, Great, W. H. Holmes, 281
- Service (Robert), the Ptarmigan, 445
- Seton-Karr (Lieut. H.), Alpine Regions of Alaska, 475
- Severn Fishery Board Almanac, 257
- Seydler (Prof. A.), an Error in Maxwell's "Electricity and Magnetism," 512
- Sharp (David), New Zealand Coleoptera, 177
- Shaw (Prof. H. S. Hele), a Claim of Priority, 581
- Sheets, on Ellipsoidal Current, Horace Lamb, F.R.S., 574
- Shenstone (J. C.), Hooper's Paper on *Gymnema sylvestre*, 594
- Shenstone (W. A.), Methods of Glass-blowing, 123; Manipulation of Glass containing Lead, 223
- Sherman (O. T.): Bright Lines in Stellar Spectra, 378; Atmosphere of β Lyræ, 451
- Shetland, Flora of, W. H. Beeby, 474
- Ships of War: Fuel-Supply in, 539; Armour of, 540
- Shore (Thos. W.), Elementary Practical Biology—Vegetable, 536
- Showers, Frequency and Duration of, 479
- Shufeldt (R. W.), Notes on certain Traits of Infant Navajos, 346
- Shutter, Instantaneous, A. Mallock, 324; Col. H. Stuart-Wortley, 366
- Siberia as a Colony, Prof. Petrie, 158
- Siberia, Northern, Magnetic Horizontal Intensity in, A. C. von Tillo, 170
- Siberian Birds presented by Mr. Seebohm to Natural History Museum, 15
- Sierra Leone, Earthquake in, J. S. Hay and Jos. M. Metzger, 141
- Silicostannate of Lime, Preparation of a corresponding to Spheue, M. L. Bourgeois, 335
- Silk, Indian, Industry, the Decline of the, 84
- Silk Cocoons, Machinery for winding from, 595
- Silks, Wild, of India, Cultivation of the, J. F. Peppe, 256
- Silver, on the Phosphates and Arseniates of, 144
- Similarities in the Physical Geography of the Great Oceans, J. Y. Buchanan, 33, 76
- Simson (Alfred), Travels in the Wilds of Ecuador, 437
- Simson (Frank B.), Letters on Sport in Eastern Bengal, 388
- Singapore, Crustacea of, 525
- Sirius, Alleged Ancient Red Colour of, Mr. Lynn, 378, 391
- Skassy (M.), M. M. Bérésafsky, Potanin and, Return of, from their Expedition to China and Mongolia, 309
- Skuse (F. A. A.), British Stalk-eyed Crustacea and Spiders, 520
- Slater (J. W.), Insects and Petunias, 70
- Smell, the Sense of, Edward L. Nichols and E. H. S. Bailey, 74
- Smets (Dr. Gérard), Lung-Sick, 76
- Smith (Charles Shaler), Death of, 229
- Smith (W. Alexander), Loch Creran, 484
- Smith (Dr. W. Robertson), Studies in Ancient History, J. Ferguson McLennan, 3
- Smith (Dr. W. R.), Ammoniacal Decomposition of Urine, 404
- Smithson (T. Spencer), Top-shaped Hailstones, 438
- Smithsonian Institution, Prof. Baird's Annual Report of the, 372
- Smyrna, Earthquake at, 112, 158
- Snowflakes, Samuel Lockwood, 414
- Snowstorm of January 7, 1887, E. J. Lowe, 271
- Soap-Bubbles, Prof. A. W. Reinold's Lecture on, 229
- Soap-Films, Plane, the Production of Newton's Rings by, H. G. Madan, 583
- Society of Antiquaries, 189
- Society of Arts, 57
- Soda, Heat of Formation of some Alcoholates of, 312
- Soda Cell, Bichromate of, 381
- Soils, on the Constitution of the Nitrogenous Organic Matter of, R. Warrington, F.R.S., 403
- Solar Activity in 1886, Prof. Tacchini, 445
- Solar Eclipse, Total, of August 29, 1886, Arthur Schuster, F.R.S., 549
- Solar Halos, J. J. Walker, 272; R. T. Omond, 582
- Solar Heat, Measurements of, Dr. Frölich, 455
- Solar Phenomena during the Year 1886, M. P. Tacchini, 335, 479
- Solar Spectrum, Wave-Length of the Lines of the, Prof. Henry A. Rowland, 524
- Solid in a Liquid, on the Movement of a, 527
- Solids, Expansion of, by Heat, Lecture Experiments on the, H. G. Madan, 89
- Solids by Heat, Lecture Experiment on the Expansion of, C. E. Stromeyer, 126
- Solly (R. H.), Recently-discovered Deposit of Celestine, 414
- Solomon Islands, Coral Reefs of the, Dr. H. B. Guppy, 77
- Solubility of Substances, on the Variation of, 551
- Solution, Opening of the Discussion by Prof. Tilden, British Association, 21, 64
- Solution, on the Nature of, Dr. Nicols, Prof. Tilden, Dr. Armstrong, Prof. W. N. Hartley, Dr. Gladstone, 64
- Solutions, Natural, of Cinnabar Gold and Associated Sulphides, 524
- Sonnblick Observatory, 519
- Sorghum Sugar, 184; Experiments in the Manufacture of, at Fort Scott, 472
- Soudan, the Western, Dr. Colin on the Population of Bambouk, 22
- Sound, Light, and Heat, Lecture Problems on, Charles Bird, 52
- Sounding a Crater, Fusion-Points, Pyrometers, and Seismometers, Prof. John Milne, 152; Dr. H. J. Johnston-Lavis, 197
- Soundings in the Australian Mediterranean, Dr. Otto Krümmel, 447
- South America, Dutch Colonies in, and the West Indies, K. Martin, Dr. A. Ernst, 459
- South America, Notes of a Naturalist in, John Ball, F.R.S., 529, 553
- South American Andes, on the Age of certain Parts of the, Dr. Ochsenius, 547
- South Kensington Exhibitions, the Rats at, 205
- Southampton, Proposed University College for, 473
- Southern Comet, 329
- Spain and Portugal, Antiquities of, M. Emile Cartailhac, 244
- Sparrow chasing Pigeons, a, 536; J. Jenner Weir, 584
- Spear-head in the Quaternary Beds of Nevada, finding of, 476
- Species, Origin of, Joseph J. Murphy, 76; Edmund Catchpool, 76; Dr. Geo. J. Romanes, F.R.S., 124
- Specific Inductive Capacity, Note on, John Hopkinson, F.R.S., 334
- Spectrum Analysis: a New Method of Analysing Blood by means of the Spectroscope, Hénocque, 48; Spectroscopic Method of determining the Distance of a Double Star, A. A. Rambaut, 206; on the Objective Spectroscope, L. Respighi, 405; on Radiant-Matter Spectroscopy—Examination of the Re-

- sidial Glow, W. Crookes, F.R.S., 425, 447; Sunlight Colours, Capt. W. de W. Abney, F.R.S., 498
- Speech by Telephone, on the Limiting Distance of, W. H. Preece, F.R.S., 501
- Spencer (Herbert): Factors of Organic Evolution, Dr. Geo. J. Romanes, F.R.S., 362; Definition of Life, F. Howard Collins, 487
- Sphene, Preparation of a Silicostannate of Lime corresponding to, M. L. Bourgeois, 335
- Spheres, Revolving, Aerial Vortices and Experiments on, Ch. Weyher, 514
- Spiders, British Stalk-eyed Crustacea and, F. A. A. Skuse, 532
- Spitaler (Dr. R.), Comet 1887 *b* (Brooks, January 22), 352, 424, 496
- Spitzer (Prof. Simon), Death of, 518
- Spolia Atlantica, 603
- Spörer (Prof.): Stormy Movements in the Atmosphere of the Sun, 71; on Sunspots, 72
- Sporophore in Mosses, Morphology of the, J. R. Vaizey, 358
- Sport, Letters on, in Eastern Bengal, Frank B. Simson, 388
- Sprung (Dr.): Hadley's Principle, 384; Barograph, 456
- Spun Glass, Tenacity of, E. Gibson and R. E. Gregory, 406
- Stalk-eyed Crustacea, British, and Spiders, F. A. A. Skuse, 532
- Stanley (H. M.): Honorary Freedom of the City of London conferred on, 280; Relief Expedition to Emin Pasha, 283; Letter from, 353; Expedition to Emin Pasha, 475; and the Relief of Emin Pasha, 446; Congo Expedition, 615
- Stars: Binary, γ Coronæ Australis, H. C. Wilson, 17; Binary, δ Equulei, 401; Brightness and Mass of Binary, W. H. S. Monck, 402; Binary Star, 14 (*i*) Orionis Orbit of the, J. E. Gore, 569; Argentine General Catalogue of Stars, 113; Second Armagh Catalogue of 3300, 159; Spectroscopic Method of determining the Distance of a Double Star, A. A. Rambaut, 206; Reduction of the Position of Close Polar Stars from one Epoch to another, Prof. W. A. Rogers and Miss Anna Winlock, 231; Variable, Observations of, in 1885, Edward Sawyer, 378; New Red Star, 546
- State, the, and Higher Education, 457
- Statesman's Year-book for 1887, 461
- Statistical Institute, International, 255
- Steam Navigation, Progress in, 538
- Steel, Manganese, Physical Properties of, Prof. W. F. Barrett, 311
- Steel, Viscosity of, C. Barus and V. Strouhal, 380
- Steel and Ingot Iron, Quantity made in a Year, 231
- Stellar Parallax: Prof. Asaph Hall, 258; Application of Photography to the Determination of, Prof. Pritchard, 377
- Stellar Photography at Harvard College, Prof. Pickering, 37
- Stellar Spectra, Bright Lines in, O. T. Sherman, 378
- Steno-Telegraphy, G. A. Cassagnes, 192
- Stevens Indicator, on the Prosperity of the Stevens Institute, 568
- Stevenson (T. and D.), Lighthouse Illuminants, 63
- Stevenson (David), Canal and River Engineering, Major Allan Cunningham, 169
- Stimuli on Vegetable Tissues, on the Effect of certain, Anna Bateson and Prof. Francis Darwin, F.R.S., 429
- Stirling (James), on some Further Evidence of Glaciation in the Australian Alps, 182
- Stockholm Academy of Sciences, 48, 144, 312, 528
- Stokes (Prof. G. G., P.R.S.), Address at the Royal Society Anniversary, 113
- Stone (G. H.), Iridescent Clouds, 581; Disappearance of Bishop's Ring in Colorado, 581
- Stone Circles, A. L. Lewis on, 503
- Storm, Recent Severe Storm, 157
- Storms in the Eastern Seas, Law of, W. Doberck, 135
- Strachan (R.), Disinfection by Heat, 7
- Straight Line, to prove that only one Parallel can be drawn from a given Point to a given, Dr. E. Budden, 92
- Strain-Indicator, Stromeyer's, 540
- Strasbourg (Prof. E.), Hand-book of Practical Botany for the Botanical Laboratory and Private Student, 556
- Streeter (Edwin W.), Pearls and Pearl Life, 339
- Stromeyer (C. E.), Lecture Experiment on the Expansion of Solids by Heat, 126
- Stromeyer's Strain-Indicator, 540
- Struve (Hermann) Diffraction of Light, 423
- Struve's (Prof. Otto) Jubilee, 422; the Parallax of α , 1516, 34
- Stuart-Wortley (Col. H.), Instantaneous Shutters, 366
- Students, Number of, at the University of Berlin, 444
- Studentships, Industrial, Colonel J. F. D. Donnelly, 413
- Studies in Ancient History, comprising a Reprint of "Primitive Marriage," J. Ferguson McLennan, Dr. W. Roberts Smith, 3
- Study of Literature, John Morley, 422
- Subject-Index, Two Hours with a, 123
- Submerged Valleys in the Gulf of Genoa, on the Existence of, 336
- Suffolk, Birds of, Dr. Churchill Babington, 193
- Sugar, Sorghum, 184; Experiments in the Manufacture of, 472
- Sugar, Beetroot, Production of, in the United States, 351
- Sugar, Action of Nitric Acid on, 432
- Sugar, on the Treatment of New Wines with, 432
- Suicide of the Cobra, Supposed, R. D. Oldham, 560
- Suicide, Do Scorpions Commit? 590
- Sulphuret of Calcium, Phosphorescence of the, 431, 455
- Sulphuric Acid, Action of, on the Solubility of the Sulphate, 432
- Sulphuric Anhydride, Experiments on, 384
- Sumatra, Volcanoes in, Verbeek, 60
- Sun, Stormy Movements in the Atmosphere of the, Prof. Spörer, 71
- Sun, Eclipse of the, at Grenada, Preliminary Account of the Observations of the, Capt. Darwin, 287
- Sun Symbol, the Cross as a, Dr. Chas. R. Dyer, 345; I. Hyde Clarke, 366; Mrs. J. C. Murray-Aynsley, 558
- Sun, New Method of determining the Parallax of the, 455
- Sun, Researches on the Diameter of the, Herr Auwers, 496
- Sun's Diameter, Researches on the, Prof. Di Legge, 595
- Sun's Heat, Sir William Thomson, F.R.S., 297
- Sunlight Colours, Capt. W. de W. Abney, F.R.S., 498
- Sunrise Shadows of Adam's Peak, on the Peculiar, Hon. Abercromby, 94
- Sunrise and Sunset, Green Light at, Prof. A. Riccò, 584
- Sunset Phenomenon, Dr. Wentworth Erck, 391
- Sunsets: Red, and New Zealand Eruptions, Lieut.-Col. A. Fraser, 224; Green Light at, R. T. Omond, 391; Prof. A. Riccò, 584
- Sunspots: Observations in Hungary, Carl Braun, A. M. Clerk, 227; Prof. Spörer, 72; Dr. M. A. Veeder, 584
- Supernormal Psychology, Phantasms of the Living, Edmund Gurney, Fred. W. H. Myers, and Frank Podmore, Prof. Lloyd Morgan, 290
- Supersaturation of Salt-Solutions, Dr. W. W. J. Nicol, 527
- Surgeons, Royal College of, proposed Extension of Museum at Library, 229
- Sutton (J. B.), an Introduction to General Pathology, 26
- Svastika: Cross and Sun, Dr. Hyde Clarke, 366; as both Sun and Fire Symbol, Mrs. J. C. Murray-Aynsley, 558
- Svedstrup (Dr. Aug.), Comet Barnard (1886 *f*), 134
- Swamp Fever and Bacillus, 405
- Swarming of Aphides, Notes on the Recent, G. H. Buckton F.R.S., 15
- Sweden: Station at Landsort for Measurement of Shore-Elevation, 159; Aurora Borealis in Northern, 443
- Sweetness, a Plant which destroys the Taste of, W. T. Thisleton Dyer, F.R.S., 557
- Swift (Lewis), Warner Observatory, 446
- Switzerland, Earthquake in, 84, 205; Prof. Forel, 442
- Sydney: Discovery of Rare Fossils at, 159; Discovery of Mastodonsaurus on Juckatoo Island, 445
- Symbol, the Svastika as both Sun and Fire, Mrs. J. C. Murray-Aynsley, 558
- Symbolism, Asiatic, Study of, H. G. M. Murray-Aynsley, 327
- Symonds (G. J., F.R.S.), Influence of Wind on Barometrical Readings, 53
- Sympathetic Nervous System, Dr. Walter H. Gaskell, F.R.S., 185
- Tabasheer: W. T. Thisleton Dyer, F.R.S., 396; Henry C. 437; Tokutaro Ito, 462; Thos. Rowney, 512; the Relation, to Mineral Substances, Prof. J. W. Judd, F.R.S., 428

- Tacchini (Prof.): Solar Activity in 1886, 445; Solar Observations for the Second Half of the Year 1886, 335; Solar Phenomena during the Year 1886, 479
- Taeonic Rocks, 622
- Tails of the Comets of 1886, Prof. Th. Bredichin, 474
- Tait (Prof.), Kinetic Theory of Gases, 311
- Talc, Sample of, used in Paper-making, Prof. Macadam, 423
- Tamus communis*, Walter Gardiner on, 454
- Tartrate of Antimony, M. Guntz, 528
- Tashkend, Earthquake at, 112, 399
- Tasmania, the Birds of, 204
- Tasmanian Fisheries, 233
- Taste of Sweetness, a Plant which destroys the, W. T. Thiselton Dyer, F.R.S., 557
- Taylor (Philip Meadows), Tobacco a Farmer's Crop, Prof. John Wrightson, 52
- Tchesme, Earthquake at, 112
- Tea-Planter's Manual, T. C. Owen, 268
- Technical Education, 592; Mr. Girling, 567; and the House of Commons, Mr. Howell, 326
- Technical School at Bombay, 206
- Telegraph Wires, Propagation of Electricity in, Ed. Hagenbach, 333
- Telegraphic Determinations of Australian Longitudes, 474
- Telephone, on the Limiting Distance of Speech by, W. H. Preece, F.R.S., 501
- Telephone Line from Paris to London, Proposed, 544
- Telephonic Line between Paris and Brussels, Proposed, 133
- Telescope of the Bischoffsheim Observatory, the Great Refracting, 84
- Telescope, Hours with a Three-Inch, Capt. Wm. Noble, 246
- Tempel (Wilhelm), Observations of Nebulae at Arcetri, 198
- Temperature: High, in October, Charles Harding, 18; Critical Temperatures of Nitrogen and Oxygen, 331; Influence of Temperature on the Heat of Dissolution of Salts, Prof. S. U. Pickering, 453; Continuous Transition from the Liquid to the Gaseous State of Matter at all Temperatures, 478; Temperatures of the Atlantic Coast Waters, Charts showing, 495; on the Distribution of Temperature in the Antarctic Ocean, J. Y. Buchanan, 516; Changes of Temperature to which the Lower Forms of Organisms can be adapted by Slow Modifications, Dr. Dallinger, F.R.S., 550; Temperature off Cape Horn, 568; Influence of Extremes of Temperature on the Colour of the Blood, 576; Temperature and Pressure in Jamaica, Maxwell Hall, 437; Vertical Decrement of Temperature and Pressure, S. A. Hill, 606
- Temple Observatory, Mr. Scabrooke, 401
- Ten Years' Progress in Astronomy, Prof. C. A. Young, 67, 86, 117
- Tepper (J. G. Otto), Native Plants of South Australia, 205
- Tercentenary, the Potato, 175
- Terrestrial Crust, on the Conditions of Form and Density, 120
- Terrestrial Radius, Contraction of the, 479
- Testing Materials, on some New Measuring-Instruments used in, Prof. W. C. Unwin, F.R.S., 334
- Tetrachloride of Carbon, on the Action of, on Chlorochromic Acid and the Phosphates of Sesquioxide, M. H. Quantin, 335
- Tetuan, Exploration of, 232
- Texture of Massive Rocks, 381
- Theine, Action of Caffein and, upon Voluntary Muscle, T. Lauder Brunton, F.R.S., 599
- Theory of Numbers, 477
- Thermometer, New Form of Standard Mercurial, Dr. Pernet, 600
- Thermometers, on the Internal Capacity of, A. W. Clayden, 94
- Thiesen (Dr.), Resistance of Air, 408; on the Standard Kilogramme, 408
- Thollon (M.), Death of, 592
- Thome (Mr.), New Comet, 307
- Thompson (Mrs. Elizabeth), Fund for the Endowment of Research, 471
- Thompson (Joseph), the Owens College, 385
- Thompson (Prof. Silvanus P.): on the Cutting of Polarising Prisms, 184; Electricity and Clocks, 224; Electric Motor and its Applications, T. C. Martin and Jos. Wetzer, 410
- Thomson (Sir William, F.R.S.), the Sun's Heat, 297
- Thorpe (Prof. T. E., F.R.S.): Explosions in Coal-Mines, W. N. and J. B. Atkinson, 1; the Life and Labours of John Mercer, F.R.S., Edward A. Parnell, 145; on certain Modern Developments of Graham's Ideas concerning the Constitution of Matter, 522, 547
- Thouar's Exploration of Bolivia, 231
- Throat, Various Effects of Irritation in the, 575
- Thronhjelm, in Norway, Display of Aurora Borealis at, 112
- Thunderstorm, on the Formation of a, Prof. von Helmholtz, 24
- Thunderstorms of July 1884, Investigations into, Prof. Börnstein, 24
- Thunderstorms, Dr. Hann's Observations on, 112
- Thylacolo carnifex*, Sir Richard Owen, F.R.S., 111, 142
- Tibet, Lu River of, Gen. J. T. Walker, F.R.S., 615
- Tidal Friction and the Evolution of a Satellite, James Nolan, 75
- Tides of Long Period, on the Dynamical Theory of the, G. H. Darwin, F.R.S., 287
- Tilden (Prof.), on the Nature of Solution, 21, 64
- Tillo (A. C. von), Magnetic Horizontal Intensity in Northern Siberia, 170
- Time, an Apparatus by which, may be communicated to Performers out of the Conductor's Sight, 120
- Tin, Deposits of, 455
- Tin Mines near Meshed, M. Ogorodnikoff, 376
- Tinguians of the Philippine Islands, 446
- Tippoo Tip and the Emin Pasha Expedition, 402
- Tissues, Vegetable, on the Effect of certain Stimuli on, Anna Bateson and Prof. Francis Darwin, F.R.S., 429
- Tobacco: a Farmer's Crop, Philip Meadows Taylor, Prof. John Wrightson, 52; Cultivation of, in England and Ireland, 443
- Todhunter (Isaac, F.R.S.), History of the Theory of Elasticity, A. G. Greenhill, 313
- Toes, Observations on Heredity in Cats with an Abnormal Number of, Edward B. Poulton, 38
- Tokutaro Ito, Tabasheer, 462
- Tolmie (Dr. W. F.), Death of, 228
- Tomlinson (Herbert), the Coefficient of Viscosity of Air, 165
- Topaz from Thomas Range, Utah, A. N. Alling, 452
- Top-shaped Hallstones, C. S. Middlemiss, 413; T. Spencer Smithson, 438; Alex. Johnstone, 536
- Topinard (M.), on the Simian Characters of the Naulette Jaw, 22
- Topley (W.), Erosion of the English Coasts, 37
- Topography, Functional, of the Brain, Prof. Ferrier, 453
- Torpedo Boats, 539
- Torpedoes, proposed Examination of, by Prof. Burdon Sander-son and Mr. Gotch, 132
- Total Solar Eclipse of August 29, 1886, Arthur Schuster, F.R.S., 549
- Towns, Ozone Papers in, Dr. W. J. Black, 76
- Traill (Dr. William), of Woodwick, Obituary Notice of, 419
- Train lighted by Electricity, 595
- Trains of Pulleys and Drums, Prof. H. Hennessy, F.R.S., 452
- Transmission of Power by Compressed Air, 272
- Traube-Hering Curves, 576
- Trécul (M.A.), on the Term "Latex" in Botany, 600
- Trees, Planting of Foreign, in New England, 519
- Trewent's Encyclopaedia of Natural Sciences, 58
- Triassic Formation of the Connecticut Valley, 141
- Tribes of the Nile Valley North of Khartoum, Sir Chas. Wilson on, 431
- Trimen (Dr. H.), Hermann's "Ceylon Herbarium" and Linnæus's "Flora Zeylanica," 166
- Tripes, Mathematical, Prof. J. W. L. Glaisher, F.R.S., 101, 153, 199
- Tripes, on the Earlier, of the University of Cambridge, Sir G. B. Airy, F.R.S., 397
- Tropical and Extra-Tropical Cyclones, on the Relation between, Hon. Ralph Abercromby, 430
- Trout: Brook, Spawning of, 16; Lochleven, Dr. Day, 166; an "Egg-bound," 231
- Tunicata, on the Colonial Vascular System of the, 336
- Tuning-Fork of Variable Pitch of Tone, 383
- Tylenchus hardi*, Herr Schöyen, 336
- Tyndall (Dr.), the Retirement of, 560
- Typhoons, Dr. Doberck, 36

- Ulrich (Prof.), Discovery of Identity of Sand in the New Zealand Rivers with Oktibehite, 190
Umberto, Il re, the Engines of, 352
 United Kingdom, Ordnance Survey of the, Lieut.-Col. T. Pilkington White, 170
 United States: Earthquakes in, 36; Fish Commission, Work of the, 55, 545; Observatory for Women in, 229; Greenleaf's Bequest to Harvard College, 229; Science on advertising for Candidates for Vacant Professorships, 229; A. Heilprin, on the Geology of Florida, 230; Fish-destroying Insects in the, George Dimmock, 327; Number of Female Teachers in the, 375; Coast Survey, 400; Geological Survey on Mineral Resources of the United States, 401; Blight and Mildew on Fruit in the, 422; National Museum, Report for the Year 1884 of the, 544; Baldness of Men in the, 595; Naval Observatory, 595. (See also America.)
 Units of Weight, Mass, and Force, Prof. A. G. Greenhill, 486; Rev. Edward Geophegan, 534; Prof. A. Lodge, 557; Archd. C. Elliott, 605; Robert F. Hayward, F.R.S., 604
 University of Berlin, Number of Students, 444
 University of Bologna, Eight Hundredth Anniversary, 399
 University College, the Career of, 179
 University College, Bristol, Albert Fry, 345
 University College, Liverpool, Generous Endowments, 280
 University Colleges, Prof. Jowett on, 441
 Universities: University Extension Scheme, 611; Trial of, in Scotland, 327; University Intelligence, 22, 69, 119, 212, 285, 380, 404, 451, 477, 501, 598, 621; University for London, 505; Semi-Centennial Anniversary of Louisville, 545; Sixty-eighth Anniversary of St. Petersburg, 422
 Unwin (Prof. W. C., F.R.S.), on some New Measuring-Instruments, used in testing Materials, 334
 Upsala University, Female Students at, 306; New University Building at, 518
 Uralian Society of Natural Sciences, 133
 Uranus, Ellipticity of, Prof. W. Valentiner, 614
 Urine, Ammoniacal Decomposition of, Dr. W. R. Smith, 404
 Urostyle of the Common Frog, Abnormality in the, Prof. C. Lloyd Morgan, 344
 Urua, Capt. Cameron's Lecture on, 259
 Urvolk of Japan, Aino Hairiness and the, F. V. Dickens, 534
- Vaerdalen, Norway, Brilliant Meteor seen in, 612
 Vaizey (J. R.), the Morphology of the Sporophore in Mosses, 358
 Valency and Residual Affinity, Prof. H. E. Armstrong, F.R.S., 570, 596
 Valentiner (Prof. W.), Ellipticity of Uranus, 614
 Van Slyke (L. L.), Kilauea after the Eruption of March 1886, 451
 Vanadic Acid, Quantitative Analysis of, 576
 Vanadium occurring in Rocks and Mineral Ores, on the Extraction and Analysis of the, 576
 Vaporisation of some very Volatile Substances, on the Latent Heats of, 551
 Variables: New, S. C. Chandler, 307; New, in Cygnus, Dr. Gould, 282; Gore's, near χ^1 Orionis, Dr. G. Müller, 329; the New Algol-Type, Mr. Chandler, 329; Observations of, in 1885, Edward Sawyer, 378; Probable New, 402
 Vaschy (M. A.), on the Nature of the Electric Actions in an Insulating Medium, 263
 Veddahs, C. Stevens on the, 134
 Veddahs of Ceylon, 205
 Veeder (Dr. M. A.): Aurora, 54; Meteors and Auroras, 126; Auroras, 272; Sunspots, 584
 Vegetable Soils, on the Direct Fixation of the Gaseous Nitrogen of the Atmosphere by, M. Berthelot, 335
 Vegetable Tissues, on the Effect of certain Stimuli on, Anna Bateson and Prof. Francis Darwin, F.R.S., 429
 Velocities, Virtual, F. Guthrie, 149
 Venezuela, Anthropological Notes from, 496
 Venice, Earthquake Shock in, 350
 Ventosa (V.), a Claim of Priority, 513
 Vennikoff (M.), on the Upheaval of the South-West Coasts of Finland, 600
 Verbeek, Volcanoes in Sumatra, 60
 Verhandlungen of the Berlin Geographical Society, 520
 Vertebral Column of the Common Frog, Abnormalities in the, Prof. C. Lloyd Morgan, 53
 Vertebrates, Comparative Anatomy of, Robert Wiedersheim, W. Newton Parkees, 123
 Vertical Decrement of Temperature and Pressure, S. A. Hill, 606
 Victoria Hall Lectures, 35
 Victoria Institute, 191, 454, 527
 Vienna Geographical Society, 354; Imperial Academy of Sciences, 72; Types of Birds in the Vienna Natural History Museum, 204
 Vilayet Konia, Asia Minor, Earthquake at, 376
 Villepigne (Floran de), Autographome'er, 444
 Vine, Anti-Phylloxeric Disinfection of the Grape, 382
 Vine, Peronospora of the, 382
 Virginia, Astronomy in, 35
 Virtual Velocities, F. Guthrie, 149
 Virus, Scorpion, Sir J. Fayrer, F.R.S., 488; Prof. C. Lloyd Morgan, 534
 Vitality of Mummy Seeds, Geo. Murray, 582
 Vitality of Seeds, 414; F. G. Hilton Price, 463; L. Blomefield, 463; Dr. L. Martial Klein, 463
 Vitality and its Definition, Prof. John W. Judd, F.R.S., 511; F. Howard Collins, 580
 Volcanoes: of Japan, Prof. Milne, 19; in Sumatra, Verbeek, 60; Revelations of a Dissected Volcano, Jas. D. Dana, 93; Active Volcano in Japan, 133; Volcano of Mauna Loa in Eruption, 423; Volcanic Action, Jas. D. Dana, 451; Deposits of Volcanic Dust, Prof. Geo. P. Merrill, 174; Volcanic Dust from New Zealand, Prof. T. G. Bonney, F.R.S., 56; Volcanic Eruption in Niua-Fu, Friendly Islands, Prof. T. G. Bonney, F.R.S., 127; Volcanic Eruption in Mount Tarumai, in Zezo, 472; in Northern California, 380
 Voltaic Action, Theory of, J. Brown, 142
 Voltaic Arc, on the, 576; Electromotive Force of the, 331
 Voltaic Electricity, Note on the Development of, by Atmospheric Oxidation, C. R. Alder Wright, F.R.S., 598
 Volumetric Determination of Hydrogen Sulphide, 384
 Vortices, Aerial, 551
 Vortices, Aerial, and Revolving Spheres, Experiments on, Ch. Weyher, 514
 Vries (Prof. Hugo de), how to make Colourless Specimens of Plants to be preserved in Alcohol, 149
- Wagner Free Institute of Science, 230
 Wahrlich on Fungus and Orchids, 230
 Wales (Prince of), Imperial Institute, Prof. Huxley, 265
 Walker (John), Enormous Loss from Ox-Warble, 7
 Walker (J. J.), Solar Halo, 272
 Walker (Gen. J. T., F.R.S.), on the Lu River of Tibet, 615
 Walker (Fred. W.), Practical Dynamo-building for Amateurs, 294
 Wall (H. Beresford de la Poer), Manual of Physical Geography of Australia, 389
 Wallace (Dr. Alfred R.), Geo. J. Romanes, F.R.S., on Physiological Selection, 247, 366, 390
 War and Ballooning, Eric S. Bruce, 259
 War-Ships, Modern, W. H. White, 306
 Ward (Henry A.), West Indian Seal, *Monachus tropicalis*, 392
 Ward (Prof. H. Marshall), *Entyloma Ranunculi*, 166; Proto-plasm, 300
 Warrington (R., F.R.S.), on the Constitution of the Nitrogenous Organic Matter of Soils, 403
 Washburn Observatory, Publications of the, 159
 Washington, Ninth Triennial Meeting of the International Medical Congress at, 350
 Washington Observatory, 308, 614; Capt. R. L. Phythian, 569
 Watch, Means to Convert a, into a Repeater, 312
 Water, Aerated, on some Phenomena connected with the Freezing of, Geoge Maw, 325
 Water Battery, Henry A. Rowland, 452
 Water in the Chalk beneath the London Clay of the London Basin, on the, Robert B. Hayward, F.R.S., 335
 Water, Cohesion of an Air-free Column of, Prof. Helmholtz, 456
 Waters (A. W.), Fossil Chitostomatous Bryozoa from New Zealand, 190
 Waterspouts, Ch. Weyher on, 407; M. Mascart, 431; on a Complementary Experiment relative to, 600

- Watson (Rev. Henry W.), an Error in Maxwell's "Electricity and Magnetism," 223; Magnetic Theory, 295
 Watson-Draper Microscope, 550
 Watt's (Dr. G.), Observations in the Manipur District, 308
 Wave-Length of the Ray of Light D₂, 432; on the Absolute, Louis Bell, 524
 Wave-Length of the Lines of the Solar Spectrum, Prof. Henry A. Rowland, 524
 Wave-Measurements, 180
 Wave-Motion in Hydrodynamics, Prof. A. G. Greenhill, 477
 Weather Charts, Atlantic, 469
 Weather, the Recent, 198; Rev. W. Clement Ley, 54; F. T. Mott, 173; William Ingram, 173
 Weather Terms, a Few of our, Rev. W. Clement Ley, 323
 Webb (R.), Definitions of Euclid with Explanations, 340
 Weight and Mass, 512
 Weight, Mass, and Force, Units of, Prof. A. G. Greenhill, 486; Rev. Edward Geoghegan, 534; Prof. Alf. Lodge, 557; Archd. C. Elliott, 605
 Weight, and Dynamical Units, Mass, Robt. F. Hayward, F.R.S., 604
 Weights and Measures, International Committee of, 203
 Weill (Dr.), Antifebrine, 445
 Weinstein (Dr.), Observations of the Earth's Current in the Telegraph Lines of the German Empire, 336
 Weir (J. Jenner), Sparrow chasing Pigeons, 584
 Weiss (Prof. E.), Comet Barnard (1887 c), 352
 Weldon (W. F. R.), a *Balanoglossus* Larva from the Bahamas, 477
 Wesley Naturalist, 444
 Wesley Scientific Society, 84
 West (Wm.), a Question for Chemists, 584
 West Indies: Botanical Federation in the, D. Morris, 248; Dutch Colonies in South America and the, K. Martin, Dr. A. Ernst, 459
 Wetzer (Jos.) and T. C. Martin, Electric Motor and its Applications, Prof. Silvanus P. Thompson, 410
 Weyher (Ch.): on Waterspouts, 407; Movements of the Air, 431; Aërial Vortices and Revolving Spheres, 514
 Wharton (Capt. W. J. L., F.R.S.), Long-Lost Reefs, 347
 White (Lieut.-Colonel T. Pilkington), Ordnance Survey of the United Kingdom, 170
 White (W. K.), Modern War-Ships, 306
 White (William), Heredity in Abnormal-Toed Cats, 125
 White Epidote, Note on a, from Beagle Channel, Tierra del Fuego, 335
 Whitworth (Sir Joseph): Obituary Notice of, 304; his Will, 473
 Wiederheim (Robert), Comparative Anatomy of Vertebrates W. Newton Parker, 121
 Wight (Isle of), Oyster Fisheries of, 57
 Wild (James), Death of, 594
 Wilder (Dr.), on the Nomenclature of the Brain, 255
 Wilkins (A.), Beetle in Motion, 414
 Willemite, on the Artificial Production of Zincite and, M. Alex. Gorgeu, 288
 Williams (G. H.), Norites of the Cortlandt Series, 452
 Williamson (Prof. W. C., F.R.S.), on some Observations on Palæobotany in Goebel's "Outlines of Classification and Special Morphology of Plants," 535
 Wills (J. T.), on the Region between the Nile and the Congo, 521
 Wilson (Sir Chas.), on the Tribes of the Nile Valley North of Khartoum, 431
 Wilson (Dr. Daniel), Right Hand and Left-Handedness, 307
 Wilson (Edmund B.), General Biology, 413
 Wilson (H. C.), Binary Star γ Coronæ Australis, 17
 Wilson (T.), Electricity and Clocks, 173
 Wilson-Barker (David), Electrical Discharges in the Doldrums, 20
 Wind, Influence of, on Barometric Readings, Prof. Cleveland Abbe, 29; G. J. Symonds, F.R.S., 53
 Winds, the Chinook, M. W. Harrington, 568
 Wines, Copper detected in, 312
 Wines, New, on the Treatment of, with Sugar, 432
 Wislock (Miss Anna) and Prof. W. A. Rogers, Reduction of the Position of Close Polar Stars from one Epoch to another, 231
 Winter, Alpine, and its Medical Aspects, A. Tucker Wise, 170
 Wires, Electrical Resistance of suspended Copper and Iron, Shelford Bidwell, 526
 Wise (Dr. A. Tucker): Alpine Winter and its Medical Aspects, 170; Ozon, 584
 Wissmann (Lieut.), Fresh Expedition from Luluaburg, 521
 Wolf (Dr.), Explorations on the Sankuru, 520
 Wolves, Mares, and Foals, George Maw, 297
 Women: Education of, in Japan, 229; Observatory for, in America, 229
 Wood (J. G.), the Handy Natural History, 341
 Worcester Victoria Institute, 205
 Wragge (Clement) appointed Meteorologist to the Government of Queensland, 229
 Wright (Dr. C. R. Alder): Commercial Organic Analysis, Alfred H. Allen, 293; Note on the Development of Voltaic Electricity by Atmospheric Oxidation, 598
 Wright (G. Frederick), the Muir Glacier, 380
 Wright (Lewis), the Zirconia Oxy-hydrogen Light, 583
 Wrightson (Prof. John): Enormous Loss from Ox-Warble, 29; Food-Grains of India, A. II. Church, 52; Tobacco a Farmer's Crop, Philip Meadows Taylor, 52; Journal of the Royal Agricultural Society of England, 148
 Wrought Iron, J. Starkie Gardner, 422
 Wurster (Dr.), Active Oxygen in the Animal Organism, 383
 Yacht-building, Fifty Years of, 539
 Yellow Fever: Microbe of, 528; Results obtained by the Preventive Inoculation of the Attenuated Virus of, 576
 York, Sanitary Conditions of the City of, 423
 Yorkshire, on the Character of the Beds of Chert in the Carboniferous Limestone of, Geo. J. Hinde, 582
 Youmans (Edward Livingstone), Death of, 305
 Young (Prof. C. A.), Ten Years' Progress in Astronomy, 67, 86, 117; Longitude of Rio, 172; Rotation-Time of the Red Spot on Jupiter, 181
 Young (Dr. Sydney) and Prof. William Ramsay: Preliminary Note on the Continuity of the Liquid and Gaseous States of Matter, 262; Clausius's Formula, 346
 Yukon, Exploration of the Watershed of the River, 593
 Zacharias (Dr. Otto), Investigation of North German Lakes, 473
 Zanzibar, Dr. Lenz's arrival at, 283
 Zeitschrift für physikalische Chemie, 376
 Ziegler (E.), a Text-book of Pathological Anatomy and Pathogenesis, 246
 Zincite and Willemite, on the Artificial Production of, M. Alex. Gorgeu, 288
 Zintgraff (Dr.), Exploration of the Cameroon District, 475
 Zirconia Oxyhydrogen Light, Lewis Wright, 583
 Zone, Equatorial, of almost Perpetual Electrical Discharge, Hon. Ralph Abercromby, 487
 Zoological Gardens: Additions to, 17, 36, 59, 85, 113, 134, 159, 181, 206, 231, 257, 282, 307, 329, 352, 377, 401, 424, 445, 474, 496, 520, 546, 569, 595, 614; Specimens of the Sea-Lion or Eared Seal of the Auckland Islands at the, 327
 Zoological Record for 1885, 341
 Zoological Record, 613
 Zoological Research, Grants for, Berlin Academy of Sciences, 473
 Zoological Results of the Challenger Expedition, 49
 Zoological Society, 93, 166, 311, 381, 431, 502, 526, 599
 Zoologist, 446; Drawings of the *Rhinolophus ferrum-equinum* in the, 256
 Zoology, Hand-book of, with Examples from Canadian Species, Sir J. W. Dawson, F.R.S., 295
 Zoology, Practical, B. P. Colton, 458
 Zoology, a Junior Course of Practical, A. Milnes Marshall, F.R.S., 506
 Zoology, Proposed Lectures on, at the Zoological Gardens, 567
 Zoology, Mythical, of the Far East, 591
 Zuntz (Prof.), Alimentary Values of Various Albuminous Substances, 480
 Zurich, Earthquake Shock in, 350



A WEEKLY ILLUSTRATED JOURNAL OF SCIENCE

*"To the solid ground
Of Nature trusts the mind which builds for aye."*—WORDSWORTH

THURSDAY, NOVEMBER 4, 1886

EXPLOSIONS IN COAL-MINES

Explosions in Coal-Mines. By W. N. and J. B. Atkinson, H.M. Inspectors of Mines. (London: Longmans, 1886.)

EVERYBODY in the least degree conversant with matters connected with coal-mining will at once admit that our knowledge of the remote causes of colliery explosions has increased enormously during the last few years. Whether, however, the practical application of this knowledge has kept pace with the rate of increase in the knowledge itself is another matter. Since 1851, when the first Mines Inspection Act was in force, the number of fatal explosions in collieries has steadily diminished, but the annual loss of life from these catastrophes is as great as ever. During the ten years ending 1860 there were 820 fatal explosions, resulting in 2441 deaths, or an average of 2.98 deaths per fatal explosion; during this de there was an average of 3000 persons employed and about the mines for every fatal explosion, and 1008 ns for each resulting death. During the ten years 1870 the number of fatal explosions fell to 565; deaths were 2267, or an average of 4.01 per fatal ilion; and the ratio of persons employed to each explosion was 5650, and hence to each resulting th 1408. During the ten years ending 1880 the number of fatal explosions was 424; the resulting deaths e 2686, or an average of 6.33 per fatal explosion; the o of persons employed to each fatal explosion was 372, and to each resulting death 1795. During the five trs ending 1885 we have had 146 fatal explosions, with loss of 906 persons, or an average of 6.20 deaths from explosion; the ratio of persons employed to each at explosion was 17,503, and to each resulting death 70. These figures are in the highest degree significant, they are not capable of telling everything. They do, for example, bring out the fact that the actual violence colliery explosions when they do occur is nowadays ater than formerly. This may seem to be indicated the increase in the average number of deaths from

Vol. XXV.—No. 288

each fatal explosion, but then, on the other hand, there are far more men employed in pits now than formerly. The diminished number of explosions is probably due, in the first instance, to the more general employment of safety-lamps, and, during late years, to the restrictions which have been placed upon the use of explosives. The increase in the average number of deaths to each explosion is doubtless owing to the gradual deepening of the pits and to differences in the mode of origin and character of the explosion. Thirty years ago the pits as a rule were comparatively shallow and damp. Such a sinking as that of the Ashton Moss pit at Audenshaw, which is upwards of half a mile deep, was unknown. Explosions in these damp shallow pits were usually caused by the ignition of gas, most frequently by naked lights; they were very local in their action, and the loss of life was small. Nowadays an explosion in a deep and dry mine not unfrequently penetrates throughout the whole pit; it is often extremely violent, and the number of deaths, mainly from after-damp, is correspondingly great.

There can be very little doubt that such explosions are, in the main, caused by dust. The fact that fire-damp is not the only explosive agent which may be present in coal-mines is now generally recognised. It is, however, a moot point with many practical men whether coal-dust alone, in the entire absence of gas, can bring about an explosion of any magnitude. It is generally conceded that a very small amount of gas, an amount, indeed, too small to be recognised by the elongation of the flame of a safety-lamp, or the formation of a "cap," is sufficient in the presence of coal-dust to form a dangerously explosive atmosphere, but colliery managers and many mining engineers have, apparently, been slow to believe that dust itself may, under certain conditions, effect an explosion quite as violent in its character as the most formidable gas explosion of which we have any record. The Royal Commissioners appointed to inquire into accidents in mines reported that in their opinion it was well established that even when the air is quite free from fire-damp, an exceptionally inflammable coal-dust, in a very finely-divided and dry condition, and existing in abundance in the immediate vicinity of a blown-out shot, may when

raised by the shot be ignited so readily and carry on the flame so rapidly that it may produce explosive effects of a similar character to those caused by a gas explosion. The flame as it rushes along, if fed by freshly raised dust, may extend under these circumstances to very considerable distances, with results resembling, in their disastrous nature, those of explosions originating with, and mainly due to, fire-damp. This conclusion is very greatly strengthened by the evidence which the Messrs. Atkinson have brought together in the book before us. Their work indeed constitutes the most formidable indictment against coal-dust as a cause of colliery explosions which has yet been drawn up. In their capacity of Inspectors they have investigated with the most patient care the circumstances connected with what we may call six typical explosions. These were—

Date 1880	Name of colliery	Deaths	Time of explosion	Seams affected
Sept. 8	Seaham	164	2.20 a.m.	Maudlin and Hutton
1882				
Feb. 16	Trimdon Grange	74	2.30 p.m.	Harvey
April 18	Tudhoe	37	1.15 a.m.	Brockwell
April 19	West Stanley	13	1.0 a.m.	Basty
April 25	Whitehaven	4	11.15 p.m.	Main Band
1885				
March 2	Usworth	42	8.58 p.m.	Maudlin

All the explosions with the exception of that at Whitehaven were in the county of Durham. It would be quite impossible in the space at our disposal to follow the successive steps in the minute analysis to which the authors have subjected each of these explosions. We should require, moreover, many of the numerous plans of the colliery workings with which the book is illustrated were we to attempt such a task. All that can now be done is to point out the characteristic features of the several explosions, and to indicate the general conclusions which the authors draw from the consideration of the various circumstances connected with them. We are conscious that in some respects this method of treating their work hardly does justice to the authors. It fails to convey any idea of the thoroughly scientific manner in which the Messrs. Atkinson's investigations have been conducted; of the minute and painstaking mode of their observation; or of the care and skill with which their deductions have been made. The authors, even in the earlier pages of the book, make their position in regard to the question of Gas *versus* Dust perfectly clear, but not even the most prejudiced opponent of the dust hypothesis can complain of the manner in which the evidence is presented.

The Durham explosions presented many features in common. In the first place no accumulations of gas were known to exist in quantity sufficient to cause the widespread destruction which happened, nor were such accumulations considered possible. In all these explosions the downcast shafts were more or less damaged. At Trimdon Grange, Tudhoe, West Stanley, and Usworth the explosions did not cross the downcast shafts; these were wet, and the roadways near them were damp. At Seaham the shaft was dry, and the explosion crossed it and extended far beyond it. In all cases the violence and game of the explosions were confined to roads on which there was much coal-dust. The explosions were most violent in the intake and haulage roads, or between

practically no gas was to be expected, and where naked lights were in constant use. The path of the explosion was in all cases that of the fresh air traversing the pit in no case did it extend by means of the return air-ways. The return air-ways carry off the gases evolved in the pit but are practically free from dust. In certain of the intake air-ways at Seaham and Usworth no coals were led, and they were consequently comparatively free from coal-dust; no traces of the explosions were observed these roads. The explosions were in many cases arrested where the haulage roads were wet. In no instance did the explosion ascend or descend vertically through step or shafts communicating with other planes of working. If the explosions were due to gas, their extension would not be influenced by the direction of a communication passage; on the other hand, very little coal-dust collected in vertical passages. In almost every case of an explosion which could with certainty be attributed to fire-damp there is evidence that men have been alarmed and have attempted to escape from the workings before the actual occurrence of the disaster: in all the five Durham explosions there was no indication that any movements had taken place amongst the men suggestive of alarm; their bodies were found in the places where their work required them to be, close to their tools and lamps.

At Seaham, Tudhoe, West Stanley, and Usworth the explosions were simultaneous with the firing of shots; in these cases the explosions occurred when the pits were occupied by stonemen and repairers and at the only time when the operations of the mines allowed the firing of shots. At Seaham, Tudhoe, and Usworth the shots were fired on a main intake air-road and at points where currents of air of between 20,000 and 30,000 cubic feet per minute were passing. At West Stanley the explosion was fired, in stone, at a working place by a naked flame and the air in the vicinity would probably contain a small quantity of fire-damp, but not sufficient in amount to show its presence in the safety-lamp or by itself to be explosive. In the other cases it is almost impossible to conceive that the air could contain any sensible quantity of gas. At Seaham it would be necessary to assume that the gas came down the shaft, or that there were three separate and simultaneous outbursts of it on the three main roads diverging from the shaft. At Tudhoe, where the air came direct from the surface by two shafts, it would be necessary to assume two separate and simultaneous outbursts. Usworth the air had passed no working place, and could hardly have contained even a trace of fire-damp. At West Stanley no appreciable quantity of gas could be present in the main intakes, although a small quantity might be contained in the air near the place where the shot was fired.

There remains the Trimdon Grange explosion, which was unconnected with shot-firing. There was distinct evidence that it originated with the ignition of gas at the light of a boy engaged at a pump in connection with the drowned workings from which gas was found to issue and that it extended with great force to parts of the mine more than a mile distant from its origin along the main intake air-ways.

Now all the circumstances connected with the Durham disasters make it almost certain that the main agent in the propagation of the explosion was dust, and in all

out of the five cases it was dust alone. In four out of the five cases the immediate cause was shot-firing, *but in no instance was the shot blown out.* It is not at all necessary that the shot should be blown out to cause the ignition of the dust-cloud which the concussion raises in a dusty road. Properly fired shots show flame even when they dislodge the stone or coal; and the flame is often considerable if there has been an overcharge of powder, or if small coal or earth mixed with coal-dust has been used, as frequently happens, in the tamping. At Seaham, Tudhoe, West Stanley, and Usworth the flame of the shot ignited the dry inflammable dust dislodged from the roof or raised from the floor by the concussion of air which followed, and the explosion was propagated by fresh dust-clouds raised in the manner described by the Royal Commissioners. At Trimdon Grange an explosion of fire-damp operated in the same way: the violent movement of air resulting from the ignition of fire-damp and air raised a cloud of coal-dust into which the flame from the fire-damp passed, and the ignition of the coal-dust propagated itself as in the other cases, and, as in these, continued so long as it was fed by fresh fuel. This rapid ignition of dust containing upwards of 80 per cent. of carbon would result in the formation of large quantities of carbonic acid, and possibly even of the more poisonous carbonic oxide: when it is considered that it is impossible to live in air containing even $\frac{3}{4}$ per cent. of carbonic acid, the deadly character of the after-damp so formed is readily conceivable.

In striking contrast to the Durham explosions was that at Whitehaven. This was in a wet pit; the coal being worked was wet, and all the surroundings were damp, and free from dust. The cause of the explosion was gas, which was known to be in the pit, and frequently present in large quantities. Although it is probable that some 30,000 cubic feet of an inflammable mixture of air and fire-damp were ignited, the explosion was confined to a limited area of the workings, which extend to nearly three miles from the shafts. Seven men were within the district of the explosion, of whom three escaped. The survivors stated that all the men were alarmed by the appearance of gas immediately before the explosion, and hurried away. In the act of retreating the gas ignited at a lamp which was afterwards proved to have been defective and to allow of the passage of the flame. This the authors say was the most considerable explosion of fire-damp and air that they are acquainted with. They have personally investigated during the last twelve years almost all the explosions occurring in the North of England, and they cannot point to a case where there was direct evidence of so large a quantity of fire-damp and air exploding.

The moral of all this is obvious. It can scarcely be gainsaid that some of the most disastrous explosions of the last thirty years are primarily to be attributed to the practice of firing gunpowder in dusty mines. That under certain circumstances gunpowder can be used with safety is allowed. But the Royal Commissioners have issued a warning in no uncertain terms. They have convinced themselves that the abolition of the use of powder in dry and dusty mines will not generally involve any formidable inconvenience, inasmuch as the work which is accomplished by its employment both in coal and in stone can be performed with equal efficiency, and at very little

if any greater outlay, by other means. Unless, therefore, mining engineers, or those immediately responsible for the working of collieries, can devise some satisfactory method of minimising the danger due to dust, they will be compelled before very long, in deference to public opinion, to renounce the practice of blasting by means of gunpowder, or by any other agent which causes a flame.

T. E. THORPE

McLENNAN'S "STUDIES IN ANCIENT HISTORY"

Studies in Ancient History: comprising a Reprint of "Primitive Marriage." By the late John Ferguson McLennan. A New Edition. (London: Macmillan and Co, 1886.)

THE first edition of "Primitive Marriage" appeared in 1865, and the book was already extremely rare when, in 1876, it was reprinted as the first part of the "Studies in Ancient History." The reprint also soon became scarce, and while the influence of the author has been steadily growing, and almost all students of early society have come to attach great importance to his speculations, his principal writings have for some years been almost inaccessible. This new edition therefore supplies a real want, and it is doubly welcome for the sparing, but judicious, notes and appendixes which the editor, Mr. D. McLennan, has attached to his brother's book. "Primitive Marriage" broke ground in a new field of research, and, as the point of view was wholly novel, the collection, sifting, and marshalling of the evidence on which the argument was based was entirely pioneer's work. At the close of his life, McLennan was in possession of a much larger material; he had pursued his argument in new directions and to further conclusions, and on one or two points he had come to change his views. But new research had only confirmed the main lines of the argument sketched with so firm a hand in his original essay; and read with the *caveats* which his brother has introduced at one or two points—chiefly as regards the interpretation of the Levirate, and the prevalence of Agnation—the present reprint may be taken as generally representing, so far as it goes, the author's final conclusions on the subjects discussed. I say *so far as it goes*, for in many directions his conclusions had been added to and his views developed. The editor promises us a second volume, to consist for the most part of writings hitherto unpublished, which will throw a good deal of light on these new developments; meanwhile he has restricted himself in the notes "to certain matters on which the author had announced a change of view, and to certain others where circumstances had made an additional statement imperative." Of the additional statements, the most important is contained in two long notes appended to the essay on Morgan's "classificatory system" of relationships, in which it is clearly made out that Morgan's theory rests on misconception of the facts, and that the supposed classificatory system of relationship is not a system of relationship at all, but a system of terms of ceremonial or friendly address, used in conversation even between persons who are not related to one another in any way. This comes out so clearly in the cases about which we are best informed, that it is very questionable

There can be no doubt that all that portion of the work which contains translations from the "Monographia" of Fries will be exceedingly valuable to British mycologists, and this extends through the whole of the first volume and 165 pages into the second; the only regret being that the few remaining species, which have not as yet been recorded in these Isles, were not inserted in brackets, or published as an appendix, so that the whole of Fries's excellent work might have been in the hands of every mycologist in this country. Perhaps even now such an appendix might be published, and no doubt it would meet with a hearty welcome.

Despite of such strictures as we have been impelled to make, we venture to hope that the present edition will soon be exhausted, and that its author will be called upon to prepare a new and revised edition, with a key to all the mysteries of the old one.

M. C. C.

THE OCEAN

Der Ozean. Von Otto Krümmel. (Leipzig und Prag: Freytag-Lempsky, 1886.)

THE great interest which oceanographical studies have aroused within the last few years is shown in a marked manner by the publications destined to popularise the notions acquired respecting this vast and important chapter of physical geography. Not long after the appearance of the "Lehrbuch der Ozeanographie" by Boguslawski, whose untimely death has interrupted the publication of the second volume, we have a new and small manual by Dr. Otto Krümmel, whose name is already known to oceanographers.

This little treatise is clearly written, and the most important general notions concerning the physical geography of the sea are well stated, and discussed with ability. The author has succeeded in expressing briefly the essential notions about the ocean, which have been recently acquired by the *Challenger* and other deep-sea expeditions.

The author describes, in the first place, the ocean's surface and its subdivisions ("Die Meeresflächen und ihre Gliederung"); discusses the relation of oceanic and terrestrial areas from the point of view of their respective size; indicates the distribution according to hemispheres; and points out the classification he has adopted into *oceans*, properly so called, with their general systems of ocean currents, and *secondary seas*, which are more or less cut off from the great oceans. The *secondary seas* are again subdivided into *interior*, or *inter-continental*, and *border seas*, situated on the outer edges of the continents. The volume of oceanic water is then estimated. In the second chapter the interesting questions connected with the deformation of the level and surface of the ocean, owing to the attraction of the continental masses, are examined. The depths and contours of the ocean basins are next pointed out, and the work of the *Challenger* and other deep-sea expeditions, together with the apparatus employed, is described. The observations of the *Challenger* upon the nature and distribution of deep-sea deposits are summarised. The physical and chemical properties of sea-water are set forth in a special chapter—the salinity of the ocean, its distribution and origin; the gas contents; the transparency and colour, are, in turn,

treated of. After having made known the principal phenomena regarding the temperature of the ocean and its distribution, Krümmel treats of the glacial phenomena of the Arctic and Antarctic Oceans, pointing out the limits of the floating ice and icebergs in each region, and the influence of these regions on the questions of general oceanic circulation. The last chapter is reserved for a consideration of the movements of water, such as currents, waves, and tides.

Such is the general order and method of this manual. There is no attempt to give any general notion of the life of the shores, deep sea, and surface of the ocean, or of any of the phenomena due to organisms. The author shows himself to be everywhere *au courant* with the most recent discoveries in his subject. It would appear, however, that he has not had an opportunity of consulting the "Narrative of the Cruise of the *Challenger*," published last year, or he would have embraced in his descriptions some additional interesting details and general views. The work is illustrated by many woodcuts and small charts, some of which are instructive, others conveying little information to the reader, but when the low price of the book (one shilling) is remembered it would be unfair to criticise closely these illustrations. Dr. Krümmel has attained the object he had in view—to popularise in a scientific manner our knowledge relative to the physical geography of the sea, a subject full of interesting questions for all cultured minds.

J. M.

LETTERS TO THE EDITOR

[The Editor does not hold himself responsible for opinions expressed by his correspondents. Neither can he undertake to return, or to correspond with the writers of, rejected manuscripts. No notice is taken of anonymous communications.]
[The Editor urgently requests correspondents to keep their letters as short as possible. The pressure on his space is so great that it is impossible otherwise to insure the appearance even of communications containing interesting and novel facts.]

On the Connection between Chemical Constitution and Physiological Action

AS regards Dr. Brunton's letter in last week's *NATURE* (p. 617), I would express myself as more than satisfied with the personal explanation, but Dr. Brunton has not noticed the most important point to which I wished to call attention, viz. the whatever may be the value of my experiments, as showing a connection between physiological action and chemical constitution the researches of Crum Brown and Fraser have really no bearing on the subject, for the simple reason that they had no knowledge of the chemical constitution of the re-agents employed. There is an old receipt for cooking a hare which commences "*First catch your hare*," and in attempting to show the influence of change in chemical constitution on physiological action, it is well first to get a constitution. In the last edition of Watts's "*Organic Chemistry*" (1886) it is stated, "All the bases (the alkaloids), like the amines, are derivatives of ammonia, but their molecular structure is for the most part unknown." Even as regards inorganic compounds, our knowledge of their chemical constitution is not the most definite, but I believe that the arrangement of the elements in isomorphous groups expresses most clearly the resemblance in the chemical constitution of their compounds.

After again reading carefully Dr. Brunton's paper, I must confess that I cannot find anything showing the connection between chemical constitution and physiological action, except perhaps, in the case of the alcohols. Here we have a class of bodies in which the different members of the series have probably the same relation to each other as the elements in the same isomorphous group, and it is an interesting fact that all

only do they resemble each other in their physiological action, but that their toxic action increases with their molecular weight, as I have shown to be the case with the inorganic elements, where, in each isomorphous group, the toxic action increases with the atomic weight of the elements.

In conclusion, I would reprint an extract from a paper published forty years ago:—"A moment's reflection on the problems to be solved will suffice to show that experiments conducted with this class (inorganic) of substances are more likely to furnish useful results than those made with bodies derived from the animal or vegetable kingdom, although, owing to the striking effects caused by some of these substances, physiologists have mostly directed their attention to them. By so doing, however, we are employing re-agents with the properties and composition of which we are imperfectly acquainted, to the neglect of those on the nature of which chemistry has already thrown much light, for not only are we better acquainted with the more purely chemical properties of inorganic compounds, but their relation to heat, electricity, and molecular polarity has been to a considerable extent made out." JAMES BLAKE

Disinfection by Heat

In Dr. Parsons's Report on Disinfection by Heat (NATURE, vol. xxxiv. p. 583) occurs the statement: "It appears that there are no tables or formulæ in existence by which the degree of humidity of the air corresponding to a given difference between the wet and dry bulb thermometers at these high temperatures can be ascertained." There are both tables and formulæ; but the tables are the numerical values for the formulæ, and such tables are to be found in Balfour Stewart on "Heat," Dixon's "Treatise on Heat," Blanford's "Meteorologist's Vade-mecum," and numerous works on the steam-engine.

Let the degree of humidity be represented by h ; vapour-tension at dew-point by x ; wet-bulb temperature by t , its vapour-tension by f ; dry-bulb temperature by T , its vapour-tension by F ; barometric pressure by b . Then, the theory of the dew-point gives

$$h = \frac{x}{F};$$

and

$$x = f - \frac{0.382(T-t)b}{1115 - 0.7t};$$

hence

$$h = \frac{f}{F} - \frac{0.382(T-t)b}{(1115 - 0.7t)F}$$

The tables give the vapour-tension, consequently if T , t , and b are known, h can be found. At these high temperatures the degree of humidity would probably not be required very accurately. If within 1 or 2 per cent. of accuracy would suffice, the second term may be omitted. This results from the fact that the higher the temperature of the air, the nearer is the dew-point to the wet-bulb temperature.

The quantity sought then is $h = \frac{f}{F}$. Given $T = 299, 299$, and 249 ; $t = 146, 165, 190$; and taking F and f in pounds from a table in "Lardner on the Steam-Engine":—

(1) $h = \frac{3.5}{63} = .05;$

(2) $h = \frac{5.5}{63} = .08;$

(3) $h = \frac{9.5}{29} = .32.$

Here saturation is represented by unity. This is at once a short and simple method of calculating the degree of humidity at these very high temperatures. If the barometrical pressure were observed, and the long second term worked out, the results would not be materially different, but would be something less.

R. STRACHAN

11, Offord Road, London, N., October 25

The Beetle in Motion

MUCH has been written on "the horse in motion." Can any readers of NATURE supply me with references to published matter on the subject of hexapod progression?

The few observations I have made may be summed up in a few words. I use the letters r and l to signify the right and left legs respectively, and number the limbs from before backwards. When walking rapidly the appearance is as if $l1, r2$, and $l3$ moved forward together simultaneously, alternating with $r1, l2$, and $r3$. When the pace is slower it is seen that $l1$ and $r2$ start together and come down at about the same time, some-

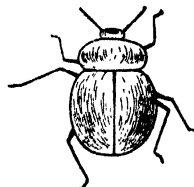

times one sometimes the other being a little the first. Then, lifted almost but apparently not quite at the same time, $l3$ starts. The motion of this leg being somewhat slower, and the limb having further to travel, the foot generally comes to the ground appreciably later than $l1$ or $r2$. The general effect is to produce, at the moments of pause between the strides, the position indicated in the figure, which differs considerably from the conventional position delineated by artists who seek to represent the beetle in motion.

C. LLOYD MORGAN

University College, Bristol

The Astronomical Theory of the Great Ice Age

IN Sir Robert Ball's paper on this subject, which appears in your last number (p. 607), that author states that the calculation given "has convinced him that Mr. Croll's theory affords an adequate explanation of the Ice age." It is more in the hope of obtaining from Sir Robert a statement of the grounds of this conviction than for the purpose of controversy that I write this letter.

It will of course be conceded that the frost and snow of a single winter, melted off during the following summer, would not produce an Ice age. But, on Sir Robert Ball's figures, the increase of winter cold at the period in question was accompanied by a corresponding and equal increase of summer heat. Why, then, should the latter prove insufficient to melt the winter accumulation of snow and ice in any locality where it now suffices to melt it?

The question is one of the joint result of two opposing forces. Both, under the supposed conditions, are intensified and equally intensified. How does this affect the result? More snow and ice is doubtless formed in the winter, but then more heat is employed in melting it during the ensuing summer. Why, then, was it not melted in any place where it is now melted? A kind of answer to this question may be extracted from the writings of Mr. Croll, but not, I think, a satisfactory one. I am therefore anxious (in common, I am sure, with many others of your readers) to hear the reply of Sir Robert Ball.

Llandudno, October 25

W. H. S. MONCK

The Enormous Loss from Ox-Warble

I VENTURE to solicit your co-operation in making some points better known in order that farmers may be better able to protect themselves from the enormous loss from warbles on cattle from the bot-fly, positive proof having been furnished that it largely exceeds 2,000,000*l.* to 3,000,000*l.* yearly! To begin: I appeal to those farmers who have somewhat studied the question to make it clear to those who have not done so that each warble lump has a large maggot under it, feeding on the juices of the hide or flesh. These lumps many call "health lumps" or "thriving bumps," and seem to prefer that their cattle should have them. It is readily seen how this serious fallacy has arisen, viz. from the fact that the warble lumps begin to show about Christmas (from the growth of the maggot under them), which also happens to be the time that the cattle receive their most nourishing food, and are then warmly housed or sheltered. But there could be no greater mistake than to think that the swellings

from the ravages of these horrid maggots are proof of a thriving condition! A correspondent writes me: "Since reading recent issues on the ox-bot or warble-fly, I have visited several cattle markets and slaughter-houses to see for myself if the ravages of the maggots are so serious as the statements led one to believe. I must frankly state that what I have seen convinces me that the statements are much under the mark rather than over it. The first beast I handled showed 42 warbles, some only 3 to 6, whilst many others showed 30 to 70; and on examining hides at slaughter-houses this state of things was again confirmed (the warbles are more readily seen upon the *under-side* of the skin, and many are small ones that would not show as a lump. I am certain a farmer has only once to make such a visit to be not only convinced of the great loss, but also, if he has any neighbourly feeling about him, to make him call the attention of his brother-farmers to the subject."

I am anxious to indorse this recommendation, for the farmers should now satisfy themselves as to the actual state of the matter, as in a few weeks from now the warble lumps will have vanished, and I fear the farmers will hardly take protective measures during the summer, when the warbles are not visible, unless they are convinced; whilst seeing would be believing. I may remark that the following simple remedies are all efficacious to destroy the maggots: mercurial ointment and carbolic oil, to be applied with caution by a careful man; or, better still, quoting from the Report of the Royal Agricultural Society, "As a general application, safe in all hands, McDougall's preparation has proved excellently useful," and I have convinced myself it is the best and safest remedy that can be applied, not only for destroying the maggots, but, later on, as a wash to prevent the attacks of the flies. I would not have occupied so much of your space, but I am convinced this is a subject of national importance.

JOHN WALKER

Southport

P.S.—Farmers wishing for further information should read "Observations on Ox-Warble or Bot-Fly," 1884, and a second Report on "Ox-Warble or Bot-Fly," 1885, by Eleanor A. Ormerod, F.R. Met. Soc., &c. (London: Simpkin, Marshall, and Co.), and a new pamphlet called "The Bot-Fly," just issued by J. C. Jack, Grange Publishing Works, Edinburgh. This work fully defines every minute detail of the history, life, prevention, and losses sustained by the dreaded pest.

Aurora

THE remarkable aurora borealis observed by Prof. Piazzi Smyth at Edinburgh on July 27 (*NATURE*, vol. xxxiv. p. 312) seems to have been visible over a very great area. In my meteorological journal it is remarked on July 27 that the bright silver-clouds appeared beautiful between 9.30 and 11 p.m. "The colour of the northern sky above the silver-clouds was misty and brownish, though not cloudy." I had never seen such a tint in the sky. I have no hesitation in saying that the unusual darkness was the same as observed at Edinburgh. The fair white arc I did not see; clouds came up at midnight. It may be interesting to state that I also saw, on July 26 at 9.30 p.m., an aurora-like white cloud in the north-west. This cloud was very different from the well-known silver-clouds so often described in 1885 and 1886. On the 28th and 29th nothing extraordinary is mentioned in my journal, but on the 30th faint traces of the silver-clouds and again "a very strange yellow-brownish colour of the north and north-west sky" are remarked. The great aurora on March 30 we also observed very well at Königsberg.

F. HAHN,

Professor of Geography at the Königsberg University
Königsberg, Prussia, October 25

Earthquakes

IT is always interesting to look for coincidences in the earthquakes in different parts of the world. In *NATURE*, vol. xxxiv. p. 627, you announce that a violent earthquake was felt at Charleston and many other places in the United States of North America, on the 22nd inst. at 3 o'clock in the afternoon, *i.e.* 20h. 20m. Greenwich time. On the same day a very slight shock is recorded as having occurred at Neuchâtel, Switzerland, at 9h. 20m. evening, Berne time, *i.e.* 20h. 50m. Greenwich time: It is not impossible, but I must confess scarcely probable,

that the faint shock at Neuchâtel was the re-percussion of the severe earthquake of North America.

F. A. FORST

Morges, Switzerland, October 31

IN connection with Prof. O'Reilly's letters in *NATURE* 1 October 14 and 28 (pp. 570, 618), and your notice of October 21 (p. 599), I supply a few data, which at first I thought of to little interest for your columns. At 6.12 p.m. local time (17h. 41m. universal time), on October 16, two shocks occurred with a short interval, the direction being approximately that of the meridian. The intensity was such as might be produced by very heavy carts passing.

H. DU BOIS

Strasbourg, October 31

Meteor

THIS evening, at about 8.25, I saw a magnificent meteor, of a blue colour, falling a little to the left of the Pleiades.

Belfast, October 31

JOSEPH JOHN MURPHY

FREDERICK GUTHRIE

FREDERICK GUTHRIE was born in Bayswater on October 15, 1833, and was the youngest of six children. His father, Alexander Guthrie, was a tailor carrying on business in New Bond Street, and is said to have been a man of literary taste and ability; that he was a man of cultivation is shown by the education he provided for his children, one of whom, Francis, early distinguished himself at University College, London, and at the London University, as a mathematician, and is now Principal of the South African College, Cape Town. As a boy, Frederick Guthrie was taught privately until his twelfth year by the late Henry Watts, F.R.S.; afterwards he was sent to University College School, the under the head-mastership of Prof. Key, whence he passed into University College, London. There he remained three years, the last two of which were devoted mainly to the study of chemistry, under Profs. Graham and Williamson, and of mathematics under De Morgan, a teacher with whom it was impossible for a young man of Guthrie's power to come into contact without receiving a life-long impress. There also he again came into contact with Watts, who was then principal assistant in Prof. Williamson's laboratory, and an intimate friendship was cemented with his old tutor that remained unbroken till the death of the latter. In the spring of 1854 Guthrie went to Germany to continue his chemical studies, and worked first at Heidelberg, under Bunsen, and then at Marburg, under Kolbe, where he took the degree of Doctor of Philosophy ("*summa cum laude*") in 1854, having previously graduated as Bachelor of Arts of the University of London. After returning to England he was appointed, in 1856, assistant to Dr. Frankland, the Professor of Chemistry in Owens College, Manchester. In 1859 he went to Edinburgh as assistant to the late Vice-President of the Council, who had just succeeded Dr. William Gregory as Professor of Chemistry in the Edinburgh University.

Two years later Guthrie accepted the Professorship of Chemistry and Physics in the Royal College, Mauritius. He arrived in the island in May 1861, and for six years he devoted himself to endeavouring to introduce an establishment on a durable basis scientific instruction in the colony. Here one of his colleagues was Mr. Walt Besant, the eminent novelist, with whom he formed a friendship that remained intimate and uninterrupted through life. He returned to London on leave in 1866 and in 1869 he was elected Lecturer on Physics in the Royal School of Mines, a post which, with extended duties and modified title, he retained till his death.

In the spring and early summer of this year many of Guthrie's friends remarked upon his looking ill and seeming to be in low spirits. After a while he complained of a difficulty in swallowing, which presently became

serious that he was unable to take solid food. When at last he was prevailed upon to consult a physician, it was discovered that he was suffering from cancer of the throat. He sank rapidly during the last two or three months, and the inevitable end of his disease came on October 21. He was buried in Kensal Green Cemetery on the 26th.

Such were some of the chief outward and visible stages in Frederick Guthrie's career. Perhaps the first thing to strike anyone on making his acquaintance was his strongly-marked individuality. His opinions were, much more than most men's, of his own forming, not simply picked up as they floated about in talk or in print. And his conduct followed his opinions: he did what he thought right, with very little regard to the consequences to himself, or to what might be thought of him by others. His scientific knowledge, too, was, much more than most men's, of his own getting, the result of his own observation and experiment. In others, also, he valued even a small scrap of self-gotten knowledge more than a large store of secondhand erudition. In this respect he sometimes went to excess, and, though not without mathematical knowledge, he was somewhat apt to underrate the scientific importance of the work of mathematical physicists in comparison with that of pure experimentalists. But even this mistake had root in the thoroughly sound conviction that it is the duty of a man of science to be a strictly faithful interpreter of the observed facts of Nature, and that, the further he ventures in the field of theoretical deduction the more room is there for self-deception. He seemed, however, sometimes to forget that phenomena do not present themselves to the natural philosopher ready clothed in words, and that all that can be expressed in human language is the conception formed in the mind of the observer. The true function of the mathematical physicist is in reality, as Kirchhoff has pointed out, nothing more than to find out the simplest statements that are consistent with observation.

Guthrie's devotion to science was complete and single-minded. He had a deep conviction of the value and dignity of any kind of genuine, self-forgetful, scientific work, and he knew how, if necessity arose, to claim the dignity due to a sharer in such work. But from affectation or vanity he seemed entirely free. His wonderful gift of humour and power of terse and telling speech made it easier for him, than for most men, to put down any approach to impertinence or presumption; but, except where he felt that a lesson was needed, he was most considerate of others, both in speech and action. He delighted in playful mystifications (see, for example, Prof. von Nudeln's letter in NATURE, vol. xxi. p. 185, on the "Potential Dimensions of Differentiated Energy"), but his drollery was never ill-natured. He was generous and kind-hearted in the extreme; as a friend he was steady and faithful. Although essentially a man of science, he had considerable literary attainments, and had an excellent knowledge of both German and French, while his powers of literary expression were remarkable. It will not astonish those who knew his ability in this direction to learn that as a young man he published (under the *nom-de-plume* of Frederick Cerny) a poem called "The Jew," and a metrical drama called "Logroño."

With regard to Guthrie's scientific position and achievements it may be remarked, in the first place, that he belonged to a class that was probably commoner in his generation, and in that which preceded it, than it is likely to be in the future—that, namely, of physicists who served their time as chemists. Until within the last twenty years or so the only accessible school of experimental science was a chemical laboratory, and consequently, for the last two generations, a large proportion of the most prominent physicists have been men who began their scientific career as chemists. Among many others, it may suffice to mention Faraday and Regnault. Guthrie's first published investigation seems to have been his

dissertation on taking his Ph.D. degree; it was entitled "Ueber die chemische Constitution der ätherschwefelsauren Salze und über Amyloxydphosphorsäure." In the six years between taking his degree and going to Mauritius, he published eight or ten papers, mostly on points of organic chemistry—one of them, on the amyl group, contains the discovery of the therapeutic action of nitrite of amyl, and suggestions for its introduction into the pharmacopœia. His first physical investigations were published while he was in Mauritius, and included two researches into the formation of drops and one into the properties of bubbles. It is striking evidence of the reality of Guthrie's love of science and of his force of character that, under circumstances in almost all respects adverse to scientific work beyond what was required by his official position, he should have persevered steadily with his experiments and produced papers of great value. While in Mauritius he also published a paper on the iodide of iodammonium, and a pamphlet on "The Sugar-Cane and Cane-Sugar," and made complete analyses of the waters of the principal rivers of the island. After his return to England his scientific work was almost wholly confined to physics, but it is perhaps significant of the side from which he approached the study that the subjects that occupied him principally had relation to what is usually called in the text-books "molecular physics." Among many other researches the following may be specially mentioned: on the thermal conductivity of liquids; on approach caused by vibration; on stationary vibrations of liquids in rectangular and circular troughs; on salt-solutions and attached water (the results of this investigation were contained in a series of eight papers, and included the discovery of the substances named by Guthrie "cryhydrates," a class of solid hydrated salts which melt without change of composition, in most cases below 0°C .); on "Eutexia," an investigation into the properties, especially the melting-points, of metallic alloys and mixtures of salts.

As a teacher, it has been well said of Guthrie by one who knew him well, that "he did not desire merely to fill his pupils' heads, but to make them use them"—a far more valuable but more difficult result to attain. A large proportion of his pupils consisted of "certificated science teachers," and for these he introduced a system of instruction, consisting largely in making them construct with their own hands the apparatus required for their experiments, which was probably more fruitful (especially in the case of this particular class of pupils) than any other that he could have adopted.

In 1873 Guthrie issued to his scientific friends a characteristically worded little circular, which resulted in the formation, early in the following year, of the Physical Society of London, a Society which now includes, with very few exceptions, all the leading physicists of the United Kingdom. Through his intervention, permission was obtained from the Lords of the Committee of Council on Education for the meetings of the Society to be held in the Physical Laboratory of the Science Schools at South Kensington. He chose for himself the somewhat onerous post of "Demonstrator" to the Society, and in this capacity placed his time and the resources of his laboratory freely at the disposal of those who wished to exhibit experiments or apparatus at the Society's meetings. It was not till 1884 that he consented to become President.

In the early part of the present year he gave a course of three lectures before the Society of Arts on "Science Teaching," in which he advocated with equal vigour and humour the advantages of a training in experimental science.

Besides the poetical works already mentioned, and his numerous papers on scientific subjects, Guthrie was the author of the following books:—"Elements of Heat and Non-Metallic Chemistry," "Electricity and Magnetism,"

"Molecular Physics and Sound," and "The First Book of Knowledge."

He was elected a Fellow of the Royal Society of Edinburgh in 1859, and a Fellow of the Royal Society of London in 1873.

G. C. F.

THE LONGEVITY OF GREAT MEN¹

THE conclusion that the intellectual giants of the race are favoured by an abundance of years on the scene of their heroic activity, and are thus further differentiated from their more common fellow-men, seems natural, and has been accepted upon evidence which, in a less pleasing conclusion, would be considered ridiculously insufficient, and even false. The usual method of attempting to answer the question whether great men are longer-lived than others, is to prepare a list of the ages, at death, of a number of eminent men, take the average age, and compare it with a similar average of a number of ordinary men, or even with the average lifetime of the race, and in this way to make the results speak decidedly in favour of the superior longevity of great men. All that such a method can prove (and this it does prove) is that it takes long to become great. It neglects to consider that a select class of men is dealt with, and that, to be even potentially included in this class, one must have lived a certain number of years.

For example: in an article translated in the *Popular Science Monthly* for May 1884, it is argued that astronomers are a long-lived race because the average life-period of 1741 astronomers is 64 years and 3 months. An average human life is only 33 years; but as one cannot be an astronomer before adult life, the author takes the expectation of life at 18 years, which is 61 years, and thus makes an excess of over 3 years in favour of astronomers. He also divides his astronomers into four degrees of eminence, and finds that those of the first rank live longer than those of the second, and they in turn longer than those of the third, and so on, thus implying that the best astronomers are most favoured with years. The true conclusion is, that it takes longer to become a first-rank astronomer than it does to become a less eminent one.²

If great men were great from their infancy, and we had the means of ascertaining this fact, the method would be correct. But, as it is, we must define in some way or other what we mean by greatness, and then fix the average age at which it becomes possible to distinguish an amount of talent sufficient to enable its possessor to be enrolled in the ranks of the great as already defined. What is known as the "expectation of life" at any number of years tells the most probable age at death of one who has attained the years under consideration: a comparison of this age with the age at death of great men will decide whether they are longer-lived or not.

The attempt was made to select about 280 to 300 of the greatest men that ever lived.³ Throwing out about 30 of the doubtful names, there remain 250 men, about whom the statement is hazarded that a list of the 250 greatest men, prepared by another set of persons, will not mate-

¹ From *Science*.

² Mr. Galton ("Hereditary Genius," p. 34) has allowed himself to neglect a similar consideration. In giving the number of men in each class that the population of the United Kingdom would have between certain ages, he gives 35 as the number of men of class G (a very high degree of eminence) between the ages 28 and 30, and only 21 such men between 40 and 50 years. But this cannot be true, because only a very small proportion of men could possibly attain the eminence requisite to be classed among the G's in 20 to 30 years, while almost all (of those who will attain it at all) will have attained it before the end of their fiftieth year. And this consideration far outbalances the excess in absolute number of men between the former ages over those between the latter. Similarly the falling-off in the number of men of class G, &c. before, from decade to decade, would be more rapid than in ordinary men,—a fact which the tables fail to show.

³ The names were selected by three others and myself, while engaged in a study of what might be called the natural history of great men. The process of selection was most rigid and careful, by a system which it would take too long to describe.

rially differ from our list, as far as all the purposes for which it is to be used are concerned. From this list I have selected at random a set of men of whom it was probably easy to fix the age at which they had done work which would entitle them to a place on this list, or work which almost inevitably led to such distinction: it is a date about midway between the first important work and the greatest work. The average of over 60 such ages is 37 years; which means, that, on the average, a man must be 37 years old in order to be a candidate for a place on this list. The real question, then, is, How does the longevity of this select class of 37-year-old men compare with that of more ordinary individuals? The answer is given by the expectation of life at 37 years, which is 29 years, making the average age at death 66 years. And this is precisely the age at death of these 60 great men; showing, that, as a class (for these 60 may be considered a fair sample), great men are not distinguished by their longevity from other men.

Further interesting conclusions can be drawn if we divide the men into classes, according to real psychological and physiological differences in the ways of manifestation of the several kinds of genius. It is almost surprising how well the ordinary trinity of faculties—intellect, emotions, and will—accomplishes this purpose. Greatness seems to appear either in a brilliant thought, a deep feeling, or a powerful will. Under men of thought would be included philosophers, scientists, historians, &c.; under men of feeling, poets, musicians, religionists, &c.; under men of action, rulers, commanders, statesmen, &c. Before comparing the relative longevity of these three classes of men, I assure myself that the period at which greatness begins to be possible does not materially differ in the three classes, and, as was done in the former case, I exclude all cases of unnatural death. I find that men of thought live 69.5 years, or 3.5 years longer than ordinary men; while the lives of men of feeling are 3 years, those of men of action 5 years, shorter than those of average men,—a conclusion that agrees with the commonly accepted view on the subject. If we subdivide these three classes, we find, that, while all classes of men of thought live longer than ordinary men, the moralists live longest, scientists coming next; that among the men of feeling the religionists alone live the full period of life, while poets' lives are 5 years, and musicians' lives 8 years, too short; that, of men of action, rulers and commanders both fail to complete the full term of life by 4 years. One sees from these statements (which, however, in their detail at least, must be accepted with hesitation, owing to the fewness of examples) that the kind of psychical and physical activity pursued influences the life-period; that certain types of genius are apt to die young, while others are particularly favoured with a full allowance of years.

The question of longevity becomes important when we consider that through it the leaders of civilisation are allowed to exercise their important function a few years longer, thus enabling more great men to be alive at the same time; and that, by its tendency to be inherited by the offspring, the children of great men will begin life with a better chance of reaching maturity, and, in turn, of becoming important to the world, if, as we have reason to believe it would, the genius of their ancestors has left its traces in them.

JOSEPH JASTROW

THE GEOLOGY OF THE LEBANON

WE are indebted to Dr. Carl Diener, of the University of Vienna, for an able monograph on the geological and physical formation of the Lebanon and surrounding districts, accompanied by maps, sections, and

¹ Mr. Sully (*Nineteenth Century*, June 1886) has shown that men of feeling are more precocious than men of thought; but the difference is the age at which their first great work is done, though in favour of men of feeling, is very slight indeed.

illustrations reproduced from photographs.¹ Notwithstanding the observations of Russegger, Fraas, and others, on the physical features and structure of this region, a complete monograph on its geology has long been a desideratum, and the work of Dr. C. Diener forms a fitting continuation of the survey of Lartet in Palestine, and of the Palestine Exploration Society in Arabia Petræa and the Jordan Valley.

Down to a comparatively recent period, the ranges of the Lebanon and Anti-Lebanon were supposed to be formed of Jurassic limestones, but the observations of Oscar Fraas showed that this was an error, and that they are mainly formed of Cretaceous and Eocene limestones. It is only within the limits of a narrow belt at the western base of Mount Hermon that Jurassic beds really occur; this being their first appearance on proceeding northwards from Arabia Petræa. The formations overlying the Jurassic strata are referable to the "Neocomian" (?), Cenomanian, Turonian, Senonian, Eocene, and newer Tertiary periods; while great sheets of basaltic lava of late Tertiary age occur both to the north and to the south of the region embraced by the memoir.

Dr. Diener has worked out with great success the numerous lines of faulting and flexuring which the strata have undergone since their deposition, and which have been produced mainly during the Miocene epoch. Mount Hermon itself owes its position in a great degree to the elevation of its mass along the line of a great fault which coincides with its western base. Its beds of limestone, belonging to the age of the Lower Chalk of Europe, are disposed in the form of a low arch, the axis of which passes under the summit, and ranges in a north-northeast direction along the line of the heights of Anti-Lebanon. Other faults range along the southern and eastern flanks of the great dome-shaped mount which has thus been bodily upheaved in respect of the bordering strata. There can be no question that the system of terrestrial disturbances along which the Syrian mountains have been fractured and dislocated is the same as that which has given origin to the Jordan-Arabah depression; and amongst the lines of displacement traced out by Dr. Diener, we can have no difficulty in recognising that which is the actual prolongation of the leading fault of the Jordan Valley. This great line of fracture and displacement appears to enter the valley of the Leontes (Litany) at the western base of Hermon, where a complete change of the stratification takes place on either side, and the "Lebanon Limestone," with the subordinate Lower Cretaceous beds, are thrown into a nearly vertical position, and brought into contact with horizontal strata of the Upper Chalk (Senonkreide). It may therefore be inferred that the great valley of Cœle-Syria (El Bekâ'a), separating the range of the Lebanon from that of Anti-Lebanon, owes its origin, in the first instance, to the same system of faults which has caused the depression of the Jordan Valley, the original features having been modified by extensive denudation; and if we suppose that the primary line of fault reaches as far north as the Lake of Homs, in the valley of the Orontes, and as far south as the Gulf of Akabah, the distance through which this great line of fracture of the earth's crust will have been traced will amount to about 350 English miles.

Dr. Diener expresses some doubts regarding the former existence of glaciers in the Lebanon, notwithstanding the opinions of such observers as Hooker, Fraas, Girard, and others. Hooker especially identifies the mound upon which the grove of ancient cedars is planted as an ancient moraine. The author throws some doubt upon this view, because he was unable, after three hours of search, to find scratched or striated boulders, although he admits that, viewed in certain directions, the mounds do present the appearance of a terminal moraine. In reference to this

subject, it may be observed that the position and altitude of the Lebanon Range makes it extremely probable that perennial snow, giving origin to glaciers, occupied the higher regions during the Glacial epoch. Amongst the Caucasus, which are only a few degrees further north, though somewhat higher, glaciers occur at the present day, and during the Glacial epoch the valleys were brimful of ice. Hence it would be strange if in the Lebanon it were proved that they had been entirely absent. The scarcity or absence of glacial striations, on which Dr. Diener founds his objection, is easily accounted for when we recollect that the blocks and stones consist of rather friable limestone which has been exposed through thousands of years to the effects of frost, heat, and rain. It is only when the surface of a rock, or of a boulder, has been protected by a coat of stiff glacial clay, that we can expect the striae and scars to be preserved throughout a long period of time.

On another point Dr. Diener expresses his dissent from the views of previous observers, arising, as it seems to the writer, from his want of appreciation of the full effect of eroding agencies. The neck of land which connects the Râs Beyrût with the outer ridges of the Lebanon is formed of beds of stratified gravel or conglomerate rising from 120 to 150 feet above the sea. This is to all appearance an old sea-bed formed at a time when the land was submerged to the extent above indicated, during which Râs Beyrût was an island. The author cannot accept this view, because his observations of the coast-line of Syria, bearing on the present state of the harbours, do not appear to show a change of level of more than a few feet; less, in fact, than would be necessary to submerge the neck of land. On the other hand, he accepts the evidence offered by Lartet and the writer of a submergence of the coast of Southern Palestine and Philistia to an extent even greater than this, namely 200 feet and upwards; and he points to the evidence of great changes of level on the coast of Northern Syria and Asia Minor. May not the absence of raised beaches on the coast of Southern and Middle Syria be due to the waste caused by the wave action of the Mediterranean, which would tend to carry away such soft materials during the period of emergence where exposed and unprotected? In another case the author throws doubt on the observations of Dr. Post regarding the presence of shell-beds at levels of 150 to 250 feet near Lâdikieh, an account of which appeared in NATURE, vol. xxx. p. 385, and which is given with much detail. It seems an instance of hypercriticism to call in question an authenticated statement merely on the ground that the author was unable to personally verify it.

The above instances will, however, go to show with what care and labour Dr. Diener has accomplished his task, and he is to be congratulated upon the production of a work which will doubtless be considered a standard of reference regarding the physical history of the Syrian mountains. I may perhaps be allowed to remark that his admirable geological map would have been improved by following the English custom of showing the dip of the strata by means of small arrows, and of distinguishing between ordinary boundaries of formations and those which are produced by faults and fractures, and the book itself would have been rendered easier for reference by an index.

EDWARD HULL

AUTUMNAL FLOWERING

THE "extraordinary gooseberry" season seems to have set in this year with more than usual severity. Country clergymen and amateur gardeners, who would see nothing unusual in the autumnal flowering of a hybrid perpetual rose (which reminds them, perhaps, of their old school-days, when they read of "*biferique*

¹ "Lebanon: Grundlinien der physischen Geographie und Geologie von Mittel-Syrien." (Wien, 1886.)

rosaria Pestis"), are moved with astonishment at the sight of a second crop of flowers on an apple-tree or a laburnum. Common as the phenomenon is, however, not many persons, even among botanists, bestow a thought as to how it is brought about. Gardeners recognise two distinct modes in which flowers may be produced, either from the "old wood," meaning the wood formed in the previous season, or from the shoot of the present year's growth. A rhododendron with its flowers packed up in a "winter-bud" destined to unfold in spring, an apple or a laburnum with their winter-buds at the ends of short contracted shoots or "spurs," afford illustrations of the one type, while a rose, with its newly-formed shoots crowned with one or more rose-buds, supplies an example of the latter. There is the same sort of difference between these two kinds of flowers that there is between the so-called "annual" plants whose course of life is outrun in a single season, and "herbaceous perennials" which die down in winter, leaving a winter-bud to carry on the work when circumstances become propitious in spring. The second growth of flowers in autumn may, therefore, be due to two different causes. In the one case it is an anticipation of spring; the flowers being produced afore time. Conditions of growth being persistently favourable, the winter-bud, instead of remaining dormant, bursts prematurely into growth, and repeats in autumn what its predecessor had done in spring. The great difficulty in such a case is to explain why one bud, or at any rate only a small proportion of the total number of buds, acts in this way when the circumstances of the case would appear to be substantially alike in all. To talk of the individuality of buds is to denote a fact which every observer must be conversant with, but which does not supply any explanation. In the second class of cases the flowers are, as in "hybrid perpetual" roses, placed at the ends of some of the shoots of the year. In this case gardeners have availed themselves of what was originally an occasional tendency to continue the development of flowers on the end of certain shoots, and have, as it were, converted an accidental into a constant occurrence. Doubtless they might do the same in the case of the laburnum, were they so disposed. It is here that the skill of the gardener comes in, and even enables him, to some extent, to baffle adverse climatic influence and induce a plant, as a regular thing, to flower twice in a season, or even more or less continuously, when, if left to itself it would either not do so at all, or only in a fitful, uncertain manner. It is worth notice, too, that these second blooms are often (but by no means invariably) malformed. Some rhododendrons now before me are so, while the double-flowered apples that one occasionally sees are always, in my experience, formed on the midsummer shoots of the tree. So, again, with pears, the second crop of flowers is usually produced on shoots of the year, and very generally the flowers are more or less imperfect or misshapen. The "Napoleon" pear behaves in this way every year. Every year, too, I am indebted to Mr. Burbidge, of the Trinity College Botanic Garden, Dublin, for specimens of "Bishop's Thumb" pears, produced on the summer shoots. These pears are more like fingers than thumbs, and are destitute of core. The flower-stalk swells up as usual, and produces an eatable pear, but the carpels and seeds are conspicuous by their absence. The developing force has been energetic enough to produce flower- and fruit-stalk, but it has failed in the more essential process of seed- and embryo-formation. Possibly in some cases the absence of seed may be the result of want of fertilisation. It may be that in the flowers some at least of the carpels are present with their contained ovules, but, owing to the want of effective fertilisation, they have dwindled away and left no trace.

It would be a curious and important matter to ascertain whether, and to what extent, this repeated flowering process exhausts the plant. If no seed were produced the

extra outlay of energy would probably not be severely felt. But every rose-grower knows how great are his losses, and how difficult it is to keep his "standards" in good form and good health. Of course there are many causes for this, but it is not unreasonable to suppose that one of them arises from exhaustion from continuous flowering, which produces a condition that predisposes to disease.

Another phenomenon of a somewhat similar character is very commonly met with this autumn, although, not unnaturally, it does not attract so much attention. I allude to the production of buds and leaf-shoots on the partially withered stems of herbaceous perennial plants, such as various species of *Epilobium*, *Malva*, &c. The branches of these plants usually dry up after flowering, leaving only a rosette of leaves or a winter-bud to carry on the growth next season; but occasionally they retain some amount of vitality, and, as at this season, produce a new generation of shoots from the old ones.

These variations show how artificial are the distinctions denoted by the terms annual, perennial, herbaceous, and the like, and they show what a wide range of physiological diversity may exist within the limits of the same species.

MAXWELL T. MASTERS

ARROW-RELEASE¹

AT the commencement of this very interesting and instructive monograph, Prof. Morse tells us that when he began collecting data illustrating the various methods of releasing the arrow from the bow, as practised by different races, he was animated merely by curiosity; nor was it until he had accumulated quite a collection of sketches and other memoranda on the methods of arrow-release, not only of existing but of ancient races, as shown by frescoes and rock-sculptures, that he realised that even so trivial an art as that of releasing the arrow might possibly lead to interesting results in tracing the affinities of races. Hence he publishes in the present pamphlet the data which he has thus far collected, in the hope that further material may be secured for a more extended memoir on the subject. The great difference which Prof. Morse observed between the ordinary English and Japanese methods of using the bow first led him to investigate the subject, with the curious results to be presently narrated. The various forms of release, with their different modifications, are classified, and perhaps Prof. Morse's investigations may be most succinctly described by using his classification.

(1) *Ordinary Release*.—This is the simplest form of release, and is that which children all the world over naturally adopt in first using the bow. It consists in simply grasping the arrow between the end of the straightened thumb, and the first and second joints of the bent forefinger (Figs. 1 and 2). With a light or weak bow, says Prof. Morse, this release is the simplest and best; it makes little difference on which side of the bow the arrow rests, provided the bow is held vertically. On the other hand, however, a stiff bow cannot be drawn in this way, unless one possesses enormous strength in the fingers. This simple or primary release is that in use amongst the Ainos of Yezo, by the Demerara Indians apparently also by the Utes. The Navajos employ it when shooting at prairie dogs, so that the arrow will not penetrate the ground if it misses its mark; so do the Chippewas. The Micmac Indians of the Cascapedia settlement, on the north shore of the Bay of Chaleur, used it, and it is said that the other tribes in this part of Canada draw the arrow in the same way. A member of the Penobscot tribe at Moosehead Lake, seemed incredulous when Prof

¹ "Ancient and Modern Methods of Arrow-Release." By Edward J. Morse, Director Peabody Academy of Science. Essex Institute Bulletin October-December, 1885.

told him that there were other methods of drawing arrow.

(2) *Secondary Release*.—This is a direct outgrowth from the primary release. It consists in grasping the arrow with the straightened thumb and bent forefinger, while the ends of the second and third fingers are brought to the string to assist in drawing (Figs. 3 and 4).

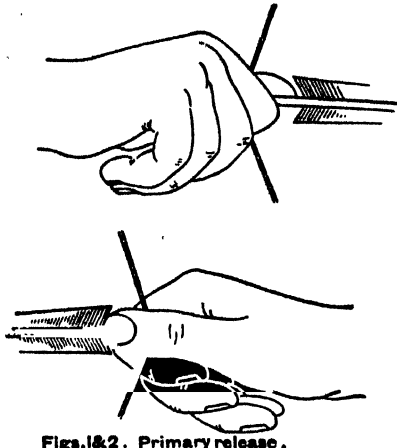

Figs. 1&2. Primary release.

The Ottawas and Zuñi Indians practised this, as also did the Chippewas of Northern Wisconsin.

(3) The *Tertiary Release* differs little from the secondary. The forefinger, instead of being bent, is nearly straight, with its tip, as well as the tips of the second and third fingers, pressing or pulling on the string, the thumb, as in the primary and secondary release, active in assisting in pinching the arrow and pulling it back. This is used amongst various tribes of American Indians—Sioux, Arapahoes, Cheyenne, Assinboins, Comanches,

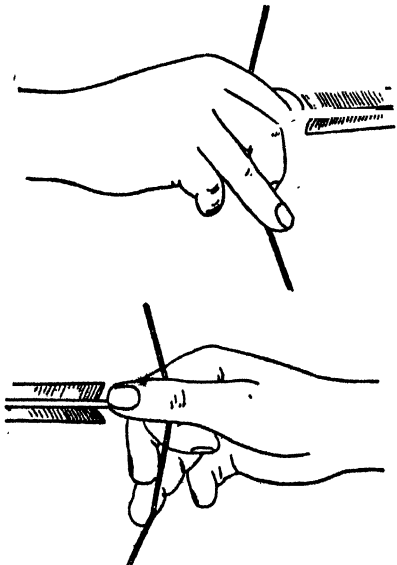

Figs. 3&4. Secondary release.

Ojibwas, and Blackfeet. The Siamese, too, practise this release, with the difference that one finger only is used on the string instead of two. It appears, too, from Mr. Huxley's recent paper before the Anthropological Institute, that the Andaman Islanders use this method.

(4) *The Mediterranean Release*.—This release has been in vogue among the northern Mediterranean nations for

centuries, and among those of the southern Mediterranean for tens of centuries, and is the oldest release of which we have any knowledge. It is practised to-day, continues Prof. Morse, by all modern English, French, and American archers, and is the release used by the European archers of the Middle Ages. It consists in drawing the string back with the tips of the first, second,

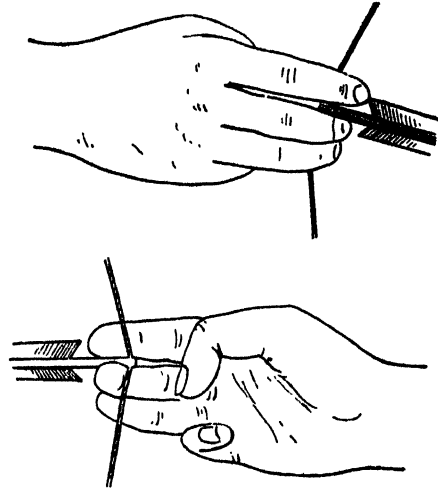

Figs. 5&6. Mediterranean release.

and third fingers, the balls of the fingers clinging to the string, with the terminal joints of the fingers slightly flexed. The arrow is held lightly between the first and second fingers, the thumb straight and inactive (Figs. 5 and 6). A leather glove or leather finger-strings are worn, as Roger Ascham expresses it in his "Toxophilus," published in 1584, "to save a man's fingers from hurtinge,

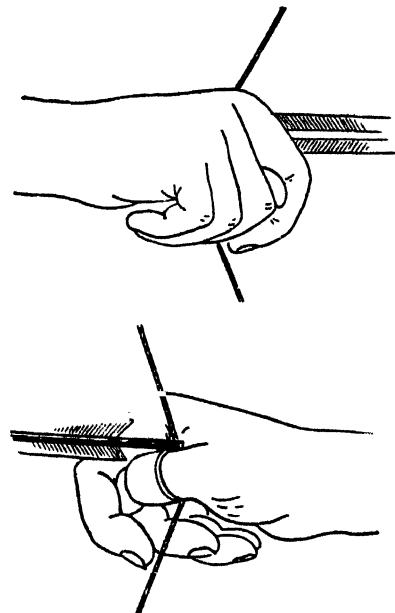

Figs. 7&8 Mongolian release.

that he may be able to bear the sharpe stringe to the uttermoste of his strengthe." In this release, the arrow must be to the left of the bow vertical. The Eskimo of Alaska employ this release, using, however, only the first and second fingers in drawing the string, and it appears to be almost universal in the Arctic regions.

These four releases may be considered, Prof. Morse

thinks, as successive modifications of each other; but the next release is an entirely independent form, having no relation to the other.

(5) *The Mongolian Release.*—In this the string is drawn by the flexed thumb bent over the string, the end of the forefinger assisting in holding the thumb in position (Figs. 7 and 8). The arrow is held at the junction of the thumb and forefinger, the base of the finger pressing the arrow against the bow. For this reason the arrow is always placed to the right of the bow vertical. This release is characteristic of the Asiatic races, such as the Manchu, Chinese, Korean, Japanese, and Turk. The Persians also use it. The thumb is protected by a guard: the Manchus, Chinese, and others use a thick ring worn near the base of the thumb. It may be made of any hard material, such as horn, bone, ivory, quartz, agate, or jade. The Japanese archer uses a glove consisting of the thumb and two fingers.

These are the principal and most efficient forms of release, although doubtless there are others. Of the methods employed by ancient peoples, as represented in manuscripts, sculptures, &c., the Assyrians at one stage of their history appear to have used the primary form, while subsequently they used the secondary, and still later the Mediterranean release. The ancient Egyptians appear to have practised three, if not four, definite and distinct methods of release, but many of the representations in the old sculptures are evidently purely conventional, while some are clearly impossible. Following on these, Prof. Morse discusses the methods employed in ancient Greece, Persia, Japan, China, India, Mexico. Here he is naturally on less secure ground, for he has to endeavour to spell out a conclusion from various and conflicting positions of the hand in various ancient graphic representations of life amongst these peoples. The discussion involves a considerable amount of detail and numerous woodcuts by way of illustration, for which the reader must be referred to Prof. Morse's pamphlet. We must content ourselves with reproducing briefly his conclusions, which, it will be understood, are at present for the most part provisional, pending additional information and wider discussion. The persistence of a particular release in a people is well illustrated in the case of the Ainos. For centuries the Ainos have battled with the Japanese, and must have been mindful of the superior archery of their enemies; indeed, on all hands, with the exception possibly of the Kamchatdales to the north, the Ainos have been surrounded by races practising the Mongolian release, and yet have adhered to their primitive methods of shooting. The two strongest releases—both perhaps equally powerful—are the Mediterranean and Mongolian, and it is interesting to note that the two great divisions of the human family who can claim a history, and who have been dominant in the affairs of mankind, are the Mediterranean nations and the Mongolians. For several thousands of years each stock has had its peculiar arrow-release, and this has persisted through all the mutations of time to the present day. Language, manners, customs, religions, have in the course of centuries widely separated these two great divisions into nations. Side by side they have lived; devastating wars and wars of conquest have marked their contact; and yet the apparently trivial and simple act of releasing the arrow from the bow has remained unchanged. At the present moment the European and Asiatic archer, shooting now only for sport, practise each the release which characterised their remote ancestors. The following classified list shows in a general way that the primary, secondary, and tertiary releases are practised by savage races to-day, as well as by certain ancient civilised races, while the Mediterranean and Mongolian releases, though originating early in time, have always characterised the civilised and dominant races. The exceptions to this generalisation are curious: the Little Andaman Islanders practise the Mediterranean

release, and those of the Great Andamans the Tertiary; various groups of Eskimo practise the Mediterranean release, and have designed a distinct form of arrow for this method.

Primary Release.—Savage: Ainos, Demerara Indians, various North American tribes; civilised: early Assyrian, Egyptian, and Grecian (?)

Secondary Release.—Savage: some North American tribes; civilised: later Assyrian and Indian (?)

Tertiary Release.—Savage: North American tribes, Great Andamans; civilised: Siamese, Egyptian, Grecian, and Mexican (?)

Mediterranean Release.—Savage: Eskimo, Little Andamans; civilised: European nations now, and the archers of the Middle Ages, later Assyrian, early Egyptian, Arabian, Indian, and Roman.

Mongolian Release.—Manchus, Chinese, Koreans, Japanese, Turks, Persians, Scythians, Egyptians (?)

In conclusion, Prof. Morse expresses a belief that the method of using the bow may form another point in establishing or disproving relationships, in identifying the affinities of past races. Travellers and explorers should not content themselves with observing the simple fact that such and such people use bows and arrows, but they should accurately record (1) the attitude of the shaft hand; (2) whether the bow is held horizontally or vertically; (3) whether the arrow is to the right or left of the bow vertical; and (4) whether the extra arrows are carried in the bow hand or shaft hand. The method of bracing the bow is of importance also. While anxious to get information respecting the arrow-releases of tribes and peoples, he is particularly desirous of hearing about those employed by the Veddahs of Ceylon, the hill-tribes of India, African tribes, and those of South America, especially the Fuegians. Such material, in the shape of descriptions, photographs, drawings, and if possible specimens of bows and arrows, may be sent to Prof. E. S. Morse, Peabody Academy of Science, Salem, Massachusetts, and will be acknowledged and used in a future publication on the subject.

CLIMATOLOGY OF THE CROYDON DISTRICT¹

IN a little tract of thirty-six pages, which has just appeared in the *Transactions* of the Croydon Microscopical and Natural History Club, Mr. Eaton has discussed the climatology of this part of England with a skill, clearness, and fairness seldom met with in local climatologies. The observations of temperature, which were conducted on the same systematic plan with Stevenson's screens, were made at seven stations, these being, in the order of their heights, Park Hill, Addiscombe, South Norwood, West Norwood, Waddon, Wallington, and Beddington. The periods selected for discussion are the five years 1881 to 1885 inclusive. The stations are included within an area measuring 4 miles from north-east to south-west by 2½ miles from south-east to north-west. The monthly results are given on fourteen pages with satisfactory fullness; and with them are conjoined, for the sake of comparison, the corresponding records of temperature at the Greenwich and Kew Observatories.

The heights and mean temperatures of the five stations from which observations are available for the whole of the five years are these:—Beddington, 102 feet, 48°·8; Waddon, 156 feet, 49°·0; South Norwood, 190 feet, 49°·4; Addiscombe, 202 feet, 49°·3; and Park Hill, 259 feet, 49°·4. —Park Hill, the highest station, being thus 0°·6 warmer than Beddington, the lowest station. This subversion of the general rule that the temperature diminishes with greater elevation is shown to be due to the frequency with which, on clear calm nights, the air in contact with the ground is cooled and rendered denser by radiation,

¹ "Report on the Temperature and the Rainfall of the Croydon District, 1881-85," by Henry Stocks Eaton.

d thereafter descends to the low-lying grounds of the lleys, displacing the warmer air below. During the usually dry clear months of January and July 1881 the mean temperature of Park Hill exceeded that of Bedington by $3^{\circ}5$ and $2^{\circ}5$ respectively. Hence the first three of the five stations which are on sloping ground have, though at greater elevations than the other two stations low, higher mean temperatures.

This peculiarity in the distribution of the night and winter temperature becomes the more intensified as the valley is deeper and its sides steeper, and as calm and light winds prevail. Thus at Klagenfurt, situated in one of the valleys of the Tyrol, the mean temperature of January is $20^{\circ}7$, whereas at the station of Obergipfel, about seven miles distant and 4270 feet higher, the mean for the same month is $19^{\circ}9$, being thus less than a degree warmer than that of Klagenfurt. The subject is one that is seldom received the earnest attention it deserves, particularly in drawing the isothermals of the globe. The Boydon Club would make a clear addition to their observing-system if new stations were established on hills in the valley of the Wandle for the further prosecution of this inquiry.

The means of temperature from Greenwich and Kew would have had real value in this inquiry if Mr. Eaton had availed himself of observations made at these observatories with thermometers exposed in the Stevenson screen. But, as pointed out, the different modes of posing the thermometers render the results of the three stems of observing incomparable *inter se*. Thus the mean of the daily highest temperature of August for the five years is $72^{\circ}5$ for Greenwich, and $69^{\circ}5$ for Kew.

The rainfall has been far more extensively observed in the district, the returns of no fewer than seventy stations being available. Grouping the stations according to height, the annual amounts at stations below 200 feet show a mean of $23^{\circ}27$ inches; 200 to 400 feet, $25^{\circ}39$ inches; 400 to 600 feet, $29^{\circ}12$ inches; 600 to 800 feet, $36^{\circ}66$ inches; and above 800 feet, $31^{\circ}36$ inches. The greatest amounts of rain occur not on the ridge of the North Downs, but some distance on the lee-side in regard to the prevalent rainy south-westerly winds; and the amount at like elevations seems also to diminish from west to east. As regards the monthly rainfall, the depth is greater in the upper groups; but the ratios of the monthly to the annual fall show that in spring, but more particularly in summer, there falls proportionally a larger amount of rain in the lower group of stations, whose average elevation is 193 feet. The relatively large increase in the summer rainfall over low-lying plains is one of the most striking facts in the geographical distribution of the rainfall, and is probably due to the physical causes concerned in the development of thunderstorms.

NOTES ON THE RECENT SWARMING OF APHIDES

THE immediate cause of the sudden appearance of clouds of insects in certain localities is not very apparent, but it may be surmised that the predominance or scarceness of their natural insect foes has much to do over the phenomenon; added to which must be taken into account the effects of weather and temperature. A few days ago I had a notice from an obliging Birmingham correspondent, Mr. George Baker, who kindly furnished me with the following particulars:—

On October 5 the town of Mansfield, on the borders of Sherwood Forest, was visited by a cloud of Aphides, which swarmed in the town and over the country round, across an area of many miles. The town was visited literally by millions; every one, as they walked along, waving their handkerchiefs or newspapers before their faces to avoid inhaling the insects. . . . Wet paint was covered by a mass of these black Aphides." This swarm

continued with decreasing numbers throughout five days, and heavy rain during part of this time did not seem much to affect them. On the road to Nottingham these insects were noticed as engaged in singular gyrations and undulatory dances above the tops of the spruce-firs, there forming dense pyramidal columns.

A similar cloud, but less remarkable as to numbers, was observed about the same time at Birmingham; which, however, as the town must be at least 50 miles distant, can be scarcely considered as forming a part of this same swarm. Possibly similar causes operated to produce the like phenomenon in both places.

These insects proved on examination to be *Rhopalosiphum dianthi* of Schrank, which is identical with *Aphis persica* of Morren, and *A. rapæ* of Curtis, and *A. vastator* of Smeë. It is a veritable pest in some years, doing considerable damage to turnip, mangel, and other crops, and in our gardens injuring our peach-trees. This present notice of its swarming is, however, by no means unprecedented.

In September and October 1834 Morren noted an immense swarm all over Belgium, and states his belief that it came across the sea from England. He says they obscured the light of day, and covered the walls of the houses so as partially to conceal them. Gilbert White notes that in August 1785 the people of Selborne were surprised by a swarm of "smother flies." Those that were walking in the street found themselves covered with these insects, which blackened the hedges and vegetables round. White thought these might be emigrations from the hop-gardens of Kent and Sussex, and from those near Farnham. If so, the species differs from the insects above noticed.

The choice of high objects to dance over is not confined to Aphides, e.g. many of the Tipulidæ. The singular persistent dance of *Anthomyia meteorica* over the heads of horses is familiar to all.

G. B. BUCKTON

NOTES

A MOST attractive group of birds has just been placed by Prof. Flower in the great hall of the Natural History Museum at South Kensington. The case is intended to illustrate the hybridisation of species in a state of nature, and the species selected are the hooded and carrion crows (*Corvus cornix* and *C. corone*) and the European and Asiatic goldfinches (*Carduelis elegans* and *C. orientalis*). The series of these birds has been presented to the Museum by Mr. Henry Seebohm, who procured the specimens himself during his travels in Siberia. The case of the crows is one of the few instances known of actual wild hybridisation, though many more are suspected, especially among the game birds. It is certain, however, that wherever the colonies of hooded crows meet the carrion crow throughout the Palearctic region the two species interbreed freely, and the result is shown in the young, the gray saddle-back of the hooded crow exhibiting a considerable admixture of black owing to the strain of *C. corone* in the parentage. The case of the goldfinches is not quite so completely proved, but is apparently a parallel instance of hybridisation. The British Museum has been for some time indebted to Mr. Seebohm for very valuable presents of birds, which have been mounted in the bird-galleries. Not long ago he gave a specimen of Ross's gull (*Rhodostethia rossi*), one of the rarest of the *Laridæ*, and a species which was a desideratum to the national collection. He presented also, last year, a fine case of Steller's sea-eagle (*Haliaeetus pelagicus*) from Kamchatka.

THE Geodetic Conference began its meetings in Berlin last week. The countries represented are Belgium, by two delegates; Denmark, by one; Germany, by fourteen, including Prof. Dr. Förster, of the Royal Observatory, Prof. Helmholtz,

Dr. W. Siemens, and Colonel Golz, of the Trigonometrical Survey: France, by two, namely, MM. Faye and Tisserand; Italy, by one; the Netherlands, by one; Norway, by one; Austria, by three; Portugal, by one; Roumania, by two; Russia, by two, including Dr. von Struve, of the Observatory at Pulkowa; Sweden, Switzerland, and Spain, each by one. England, strange to say, is not represented; nor has any one come from the United States. Prof. Dr. Förster, of Berlin, was elected President, and Dr. von Struve, of Pulkowa, Vice-President of the Conference. In his opening address, Herr von Gossler, Prussian Minister of Public Worship, indulged in some general observations as to the progress and aims of geodetic science, and, in the name of the Prussian Government, thanked the various foreign deputies for their appearance in Berlin. The chief task of the present Conference has been to settle the organisation of the central geodetic bureau, which is to have its permanent seat in Berlin, in connection with the Geodetic Institute of Prussia, founded by the late Lieut.-General von Bayer. It was at the instance of Lieut.-General Bayer that the first constituent international meeting of geodetic experts was held in Berlin in 1864, and it is by the establishment of a central international bureau here, supported by quotas from the various countries which it represents, that it is intended to preserve to Prussia the leading part she has always taken in promoting the science of earth-measuring and all its kindred branches. The permanent Committee elected includes Prof. Hirsch, of the Neuchâtel Observatory (Secretary), Professors Förster (Prussia), Sande (Holland), Faye (France), Ferrero (Italy), Ibanez (Spain), Ragel (Saxony), Oppolzer (Austria), Stepnicki (Russia), and Zachariae (Denmark). The next Conference will be held in 1887 at Nice, on the invitation of M. Bischoffsheim, owner of the great Observatory there. Before separating, the Conference passed a resolution requesting the Prussian Government to invite other States to join the International Geodetic Society.

At a recent meeting of the Common Council it was decided that it be referred to the Gresham Committee to consider whether the moneys now paid for lectures under the provisions of Sir Thomas Gresham's will might be devoted to the encouragement of students destined for commercial careers acquiring a useful knowledge of modern languages, with instructions to confer with the Mercers' Company, and to report thereon forthwith.

THE Professor of Physics of the University of Vienna, Dr. Victor Pirie, died suddenly of apoplexy in his laboratory on Friday last.

AT the Potato Centenary on December 2 and 3, to which we have already referred, the following subjects for conferences have been proposed:—First day, Morning: (1) historic consideration of the question, Whence came the potato to England? (2) the Incas and their cultivation of the potato; (3) distinct wild species of the potato as at present recognised; (4) the production of varieties by cultivation. Afternoon: (5) the potato disease; (a) historic sketch, (b) our present knowledge of the disease. Second day, Morning: (1) proposed methods for preventing the disease; (2) methods for using partly diseased potatoes; (3) methods for storing and preserving potatoes. Afternoon: conference of cultivators on rates for transport of potatoes.

THE French Government has granted the funds required for the completion of the Algiers Observatory, which will be in full operation next spring. Two assistant astronomers have already been sent to join M. Trépied, and two others will be selected from among the pupils of the School of Astronomy this winter. A special Congress will be held in Paris, in the month of April,

for determining the part that the Algiers Observatory will take in stellar photography. The direct image of the sun will be 6 centimetres in diameter. A spectroscope by Thollon will be put into operation. The extent of the spectrum will be 10 metres. M. Trépied has organised the electrical transmission of the time to the Hôtel de Ville of Algiers and Tunis. Colonel Perrier, head of the French and Algerian Survey, is arranging the measurement of the requisite triangles for connecting the Algiers Observatory with the Colonne Voïrol, the starting-point of the Algerio-Tunisian system of triangulation.

MR. W. A. CARTER, of the Colonial and Indian Exhibition, writes to us that during this last spring he placed a specimen of the Mexican axolotl in an empty (? dry) receptacle, where it has remained ever since. It is in a lively condition. The colour of the animal has become less intense, the gills have apparently disappeared, and the powers of locomotion seem quickened.

IT is worthy of note that at the establishment of the National Fish Culture Association many of the brook trout (*Salmo fontinalis*) hatched during February 1885 commenced to spawn last week, yielding about five hundred ova each. This fact is another proof of the extraordinary reproductive capacity of fishes in spite of age and artificial existence, for the fish in question have been maintained in a pond of limited dimensions. The size of the ova is small as compared with those of mature fish, therefore it is not likely that the trout when hatched will be large. The parents are in a healthy condition, and seem in no way weakened.

A CONSIGNMENT of nearly a thousand German carp of various kinds has arrived at the Colonial and Indian Exhibition. The great hardihood of the carp is evidenced by the fact that the fish in question were retained in carriers for sixty hours before being placed in tanks, when only two were found to have succumbed.

In a paper in the October number of the *American Journal of Science* by Mr. O. W. Huntington, "On the Crystalline Structure of Iron Meteorites," the author concludes as follows:— "We have tried in this paper to establish the following points: (1) that many of the masses of meteoric iron in our collections are cleavage crystals, broken off probably by the impact of the mass against the atmosphere; (2) that these masses show cleavages parallel to the planes of all the three fundamental forms of the isometric or regular system, namely, the octahedron, the cube, and the dodecahedron; (3) that the Widmanstätten figures and Neumann lines are sections of planes of crystalline growth parallel to the same three fundamental forms of the isometric system; (4) that on different sections of meteorites Widmanstätten figures and Neumann lines can be exhibited in every gradation, from the broadest bands to the finest markings, with no break where a natural line of division can be drawn; (5) that the features of the Widmanstätten figures are due to the eliminations of incompatible material during the process of crystallisation. This investigation throws no new light upon the origin of meteorites, except so far as it strengthens the opinion that the process of crystallisation must have been extremely slow. The occurrence of large masses of native iron occluding hydrogen gas, and containing nickel, cobalt, phosphorus, sulphur, &c., implies a combination of conditions which the spectroscope indicates as actually realised in our own sun and in other suns among the fixed stars, and the most probable theory seems to be that these masses were thrown off from such a sun, and that they very slowly cooled, while revolving in a zone of intense heat. In this paper we have not taken into consideration a number of iron masses, whose meteoric origin has been generally accepted, which show no Widmanstätten figures, and not even any Neumann lines. A considerable proportion of these are certainly not meteoric. In the Harvard cabinet there are two specimens, labelled respectively Campbell County (Tennessee), and Hemby

Creek (North Carolina), which are evidently nothing but cast- and a third, labelled Tarapaca Hemalga (Chili), which is probably of similar material. We could find on the specimens of this class in the Harvard collection no distinct evidences of stialisation; but also we could find no features incompatible with that unity of structure which it has been the chief object of this paper to illustrate."

MR. HORATIO HALE has issued in pamphlet form his address "On the Origin of Languages and the Antiquity of Speaking Man," delivered before the Anthropological Section of the American Association for the Advancement of Science at Buffalo last August. The author's views were much discussed at the time, and those interested in the subject will be thankful to have them presented in this convenient form. Rejecting all the theories hitherto advanced by Lyell, Frederick Müller, and others, he endeavours to account for the vast number of specifically distinct languages spoken by races not specifically distinct by assuming that they originated from children's prattle in independent centres after the spread of speechless man over the globe. The cases are mentioned of the Boston twins born in 1860 and of some other "Geschwister," who appear to have evolved and practised for some time infantile jargons understood only amongst themselves, which it is argued might, under favourable conditions of isolation and so forth, develop into regular forms of speech consistently worked out with their own vocabularies and grammatical structure. In this way linguistic families differing absolutely one from the other need not be of any great antiquity, and in fact may have been developed from slight germs in many places and at different times since the dispersion of the "homo alallus" from some given centre. This *homo alallus* himself is admitted to be the lineal descendant of the men of the Stone Age, who are assumed to have been speechless, so that all forms of speech now current may be of comparatively recent date, say, not more than 8000 or 10,000 years, notwithstanding their great number and profound differences. This theory, which refers human speech in the first instance to "the language-making instinct of very young children," is presented with considerable force and plausibility, but will scarcely be taken seriously either by philologists or anthropologists. The latter especially will find it difficult to accept the conclusion that man properly so called, the *homo sapiens*, as distinguished from his precursor of the Neolithic Age, does not date further back than "somewhere between 6000 and 10,000 years ago." The theory also requires us to regard this first speaking man as already fully developed, possessing "intellectual faculties of the highest order, such as none of his descendants has surpassed," thus reversing the conclusions of modern anthropology.

IT is reported from Vienna that a great ice cavern has been discovered on the southern slope of the Dachstein, or Schneeberg, the very conspicuous lofty mountain in Lower Austria, which is visible from the ramparts of the capital. The general direction of the cavern runs from south to north, and it has been explored for a distance of 600 metres, a sharp precipice seemingly 14 metres deep having stopped for the time further progress. The cavern is from 5 to 6 metres broad, and very lofty, giving the impression that the ice is enormously thick. The explorers are of opinion that a subterranean lake will be found in the cavern.

THE additions to the Zoological Society's Gardens during the past week include a Bonnet Monkey (*Macacus sinicus* φ) from India, presented by Miss Edith Prowse; four Common Hedgehogs (*Erinaceus europæus*), British, presented by Mr. W. Walkinshaw; a — Buzzard (*Buteo* —) from Mogador, North Africa, presented by Mr. P. L. Forwood; a Ring-necked Parakeet (*Palaornis torquatus* φ) from India, presented by Mr. W. S. Bradshaw; an Aldrovandi's Skink (*Plestiodon*

auratus) from North Africa, deposited; a Rusty-spotted Cat (*Felis rubiginosa*) from Ceylon, two Diuca Finches (*Diuca grisea*) from Chili, two Wood Larks (*Alauda arboræ*), British, purchased; eight Long-fronted Gerbilles (*Gerbillus longifrons*), born in the Gardens.

OUR ASTRONOMICAL COLUMN

THE BINARY STAR γ CORONÆ AUSTRALIS.—Mr. H. C. Wilson, of Cincinnati Observatory, has published elements of the orbit of this interesting southern double star in the *Sidereal Messenger* for October. These elements, which do not differ much from a set recently computed by Mr. Gore (*Monthly Notices*, vol. xlvii. p. 104), are as follows:—

P = 78.80 years	$\lambda = 139^{\circ}0$
T = 1887.40	$\Omega = 41^{\circ}0$
$e = 0.324$	$a = 1''.85$
$\gamma = 50^{\circ}.5$	

Comparing observations made 1834.47 to 1883.62 with this orbit, Mr. Wilson finds that the position-angles are well represented, with the exception of those observed by Powell from 1859 to 1864, which seem to be affected by systematic error, and thinks we may conclude the period is not far from eighty years. It is to be hoped that numerous observations of this star will be obtained during the next ten years, while the distance is small and the angular motion rapid.

OPPOLZER'S ASTRONOMICAL REFRACTIONS.—Herr Oppolzer has recently published, in the *Transactions* of the Mathematical and Natural Science Section of the Imperial Academy of Sciences of Vienna, vol. liii., a paper containing a theoretical discussion of the problem of astronomical refraction, followed by numerical tables intended to facilitate the practical application of the results at which he arrives. The relation between the temperature (t) and density (ρ) of the atmosphere which Herr Oppolzer adopts is

$$\frac{\delta t}{\delta \rho} = \epsilon + \Sigma k \rho^{\sigma-1},$$

where k and σ are quantities depending on the state of the atmosphere and on the place of observation. Whatever may be thought of the legitimacy of a relation of this form from a theoretical point of view, it at all events has the advantage, in Herr Oppolzer's skilful hands, of leading to a comparatively simple expression for the amount of refraction, deduced from a modification of the ordinary differential equation. And that it is capable, when the approximations are carried far enough, of giving results of great accuracy for large zenith distances, is shown by a comparison made between the computed values of the refraction and the well-known observations of Argelander, which form the basis of Bessel's supplementary table given in the "Tabula Regiomontana," with the following results:—

Z.D.	Observed—Computed	Z.D.	Observed—Computed
85 0	... - 1".1	88 0	... - 2".5
86 0	... + 1".2	89 0	... + 2".3
87 0	... - 1".3	89 30	... + 1".8

COMETS FINLAY AND BARNARD.—The following ephemerides for Berlin midnight are from the *Astronomische Nachrichten*, No. 2752:—

Comet Finlay (1886 ϵ)

1886	R. A.	Decl.	Log r	Log Δ
	h. m. s.	°		
Nov. 8	19 25 22	24 56'.8 S.	0.0751	0.0970
10	33 49	24 36'.5		
12	42 24	24 14'.1	0.0718	0.0932
14	51 5	23 49'.5		
16	19 59 51	23 22'.7 S.	0.0697	0.0899

Comet Barnard (1886 f)

1886	R. A.	Decl.	Log r	Log Δ
	h. m. s.	°		
Nov. 7	12 7 8	8 18'.5 N.	0.0735	0.2031
9	15 5	9 0'.3		
11	23 31	9 44'.3	0.0551	0.1772
13	32 29	10 30'.7		
15	12 42 1	11 19'.2 N.	0.0366	0.1507

ASTRONOMICAL PHENOMENA FOR THE WEEK 1886 NOVEMBER 7-13

(FOR the reckoning of time the civil day, commencing at Greenwich mean midnight, counting the hours on to 24, is here employed.)

At Greenwich on November 7

Sun rises, 7h. 6m.; souths, 11h. 43m. 49.6s.; sets, 16h. 22m.; decl. on meridian, 16° 21' S.; Sidereal Time at Sunset, 19h. 29m.

Moon (Full on November 11) rises, 15h. 4m.; souths, 20h. 58m.; sets, 3h. 2m.; decl. on meridian, 1° 49' S.

Table with columns: Planet, Rises (h. m.), Souths (h. m.), Sets (h. m.), Decl. on meridian. Rows include Mercury, Venus, Mars, Jupiter, Saturn.

* Indicates that the rising is that of the preceding evening and the setting that of the following morning.

Occultations of Stars by the Moon (visible at Greenwich)

Table with columns: Nov., Star, Mag., Disap., Reap., Corroding angles from vertex to right for inverted image (h. m.). Rows include Ceti, B.A.C., Piscium, Tauri, etc.

Saturn, Nov. 7.—Outer major axis of outer ring = 43".5; outer minor axis of outer ring = 16".8; southern surface visible.

Nov. 13 ... 17 ... Mercury at greatest elongation from the Sun, 22° east.

Variable Stars

Table with columns: Star, R.A., Decl., h. m., Nov. Rows include S Cassiopeæ, U Cephei, Algol, R Aurigæ, S Cancri, U Ophiuchi, B Lyræ, R Lyræ, η Aquilæ, R Vulpeculæ, δ Cephei.

M signifies maximum; m minimum.

Meteor Showers

A radiant near δ Hydræ, R.A. 124°, Decl. 4° N., and one in Camelopardus, R.A. 102°, Decl. 73° N., are active in the early part of this week.

THE HIGH TEMPERATURE IN OCTOBER

THE warm weather which occurred at the commencement of the month was so exceptional for the season, and extended over so large a part of Europe, that a few facts as to its general character may be of interest...

The highest temperatures were experienced during the first five days of the month, and were chiefly confined to Western, Central, and Southern Europe.

pressure was generally high over Central Europe, and decreased towards the western or Atlantic coasts, so that the conditions of pressure were favourable to anticyclonic circulation over France and the south-east of England...

At this season of the year our warmest weather in England is commonly experienced with south-easterly winds, as is well shown in the valuable discussion of the Greenwich observations for the years 1849 to 1868...

Table showing Monthly means and Highest hourly means for directions: N, N.E., E, S.E., S, S.W., W, N.W.

The same discussion also shows the striking difference which exists, in October, between the temperature with a cloudless and a cloudy sky:—

Table comparing Cloudless sky and Cloudy sky means for Mean, Mean max., and Mean min.

The high temperatures experienced over England in October this year occurred with an exceptionally clear sky, as well as with a remarkably steady south-easterly wind...

The following table gives the maximum day temperatures at twenty stations selected from the Daily Weather Report of the Meteorological Office and from the Paris Bulletin International for the first five days of October:—

Table with columns: Station, Day 1, 2, 3, 4, 5, Mean. Rows list stations across various countries like British Islands, France, Germany, Belgium, Austria, Spain, Portugal, Italy.

The stations have been selected as representative of Western, Central, and Southern Europe, and the table shows well the area over which the warm weather extended.

The more northern parts of Europe did not experience any exceptional heat, the highest temperature at Copenhagen being 63°, and at Stockholm 61°. The more western parts were also but little affected...

The Greenwich observations from 1841 show that a higher temperature has only once been registered in October, viz. 81° on the 4th in 1859; but the daily mean, which was 67°.1 on the 4th this year, is higher than any previously recorded.

The observations which were made in the apartments of the Royal Society from the year 1794, excepting the years 1811 to 1819, do not show so high a reading between 1794 and 1840. At Kew Observatory the highest temperature recorded was 72°.

on the 4th, and this is the highest ever observed in the month of October; on the 5th, 76° was registered, which corresponds with the temperature observed on October 4, 1859. The returns of the Meteorological Office show that 80° was observed on the 14th in London and at Cambridge, whilst 77° was registered at several stations in the east of England and in the Midland Counties.

It is difficult to make any satisfactory comparison with previous records, except at one or two places, but these tend to show that so high a temperature at this season does not occur more than about twice in a century. CHAS. HARDING

VOLCANOES OF JAPAN

THE last number (vol. ix. part 2) of the *Transactions* of the Seismological Society of Japan is wholly occupied by a paper of Prof. Milne's, on Japanese volcanoes, which is the longest contribution that has yet appeared in the Society's *Transactions*. The paper is partly historical and partly scientific, and contains, so far as the writer has been able to collect, references to everything that is known on the subject. Very much comes from his own observations, for he has travelled over the greater part of Japan, and has ascended many of the volcanoes. The paper also contains an epitome of some thirty or forty works in Japanese. On the whole, it is a systematic account of material which has been accumulating for the last eleven years.

The following are the more important conclusions which Prof. Milne has formulated in the paper:—

1. *Number of Volcanoes.*—As Japan has not yet been completely explored, and, moreover, as there is considerable difficulty in defining the kind of mountain to be regarded as a volcano, it is impossible to give an absolute statement as to the number of volcanoes in the country. If under the term volcano be included all mountains which have been in a state of eruption within the historical period, those which have a true volcanic form, together with those which still exhibit on their flanks matter ejected from a crater, we may conclude that there are at least 100 such mountains in the Japanese Empire. If to this list be added the ruins and basalt wrecks of volcanic cones, the number would be considerably increased. These mountains are distributed as follows:—

Northern Region..	{ Kuriles	23
	{ Yezo	28
Central Region ...	{ Northern main island	} 35
	{ Central " "	
	{ Oshima group	
Southern Region..	{ Southern main island ...	1
	{ Kiushiu	13
	{ Southern islands }	—
	Total	100

Of this number about 48 are still active, or have been so during the historical period. These active volcanoes are distributed as follows:—

Northern Region..	{ Kuriles	16	} 27
	{ Yezo	11	
Central Region.....		12	
Southern Region		9	
	Total	48	

From this it will be seen that volcanic activity in Japan decreases from the north towards the south.

2. *Number of Eruptions.*—Altogether about 232 eruptions have been recorded, and of these the greater number took place in the southern districts. This may perhaps be accounted for by the fact that Japanese civilisation advanced from the south. In consequence of this, records were made of various phenomena in the south when the northern districts were still unknown and unexplored regions. The greater number of eruptions took place in February and April. Comparing the frequency of eruptions in the different seasons, the volcanoes of Japan appear to have followed the same law as the earthquakes, a greater number having taken place during the cold months. This winter frequency of volcanic eruptions may possibly be accounted for in the same manner that Dr. Knott accounted for the winter frequency of earthquakes. During the winter months the average barometric gradient across Japan is steeper than in

summer. This, coupled with the piling up of snow in the northern regions, gives rise to long-continued stresses, in consequence of which certain portions of the earth's crust are more prepared to give way during the winter months than they are in summer.

3. *Position and Relative Age of Japanese Volcanoes.*—The youngest of the Japanese volcanoes appear to be those which exist as, or on, small islands. On the islands in the Kuriles, in the Oshima group, and in the Satsuma sea, many of the volcanoes are yet young and vigorous. Moreover, many of these islands have been formed during the historical period. The island-forming period in the Satsuma sea, for example, was about the year 1780.

The volcanoes of Japan form a long chain running from N.E. towards S.W.; but a closer examination of the distribution of the volcanic vents shows that there are probably four lines:—

(a) The N.E.—S.W. line running from Kamchatka through the Kuriles and Northern Yezo.

(b) The curved line following the backbone of the main island, and terminating on the western side of the Yezo anticlinal.

(c) The N.N.W.—S.S.E. line of the Oshima group. This line, coming from the Ladrões, passes through Oshima and Fujisan parallel to and near to the line of a supposed fault. Here it intersects the main line running through the main island. Volcanic vents are here very numerous. As the main island line is intersected, while the Oshima line is the intersector, it may be argued that the Oshima-Fujisan line of volcanoes are younger than many of those on the main island line.

(d) The Satsuma line, coming from the Philippines through Sakurajima and culminating in the famous Mount Aso, which is the nucleus of Kiushiu.

4. *Lithological and Chemical Character of Lavas.*—Although Prof. Milne has made an extensive collection of the volcanic rocks of Japan, the opportunity for examining them has not yet presented itself, and therefore he can only speak of them in general terms. They are at present being carefully studied by the officers of the Geological Survey. The rocks in his possession are chiefly andesites. Those containing augite, like the rocks of Fujisan, closely approximate to basalts. True basalt is, however, rare. Another common rock is hornblende andesite, some of which contains free quartz. Quartz trachytes occur in the north of Japan. The following table shows the percentages of silica, and ferrous and ferric oxide, contained in the rocks of ten volcanoes:—

Locality.	SiO ₂	FeO	Fe ₂ O ₃
1. Norokura	61.72	1.35	3.50
2. Misake	59.97	3.27	3.86
3. Kusatsu	61.49	3.30	4.35
4. Amagi (Hakone)	65.34	2.45	3.09
5. Komagadake.....	56.27	2.19	6.69
6. Moriyoshi	59.17	2.65	4.15
7. Chokai	{ 60.64	{ 3.81	{ 3.14
	{ 54.55	{ 5.19	{ 4.42
8. Hakone (Tonosawa).....	48.97	4.02	4.81
9. Fujisan	49.00	5.1	6.06
10. Oshima	52.00	13.70(?)	

One feature exhibited by the table is that the rocks of Oshima, Fujisan, and Tonosawa are basic, while those like Chokaisan and Moriyoshiyama belonging to the line of volcanoes of the main island, are relatively acidic. More extended observations of this description may show that different lines of volcanoes have thrown out different lavas, or that the lavas of different constitution are of different ages.

5. *Magnetic Character of Rocks.*—In a study of the soils in the neighbourhood of Tokio, Mr. E. Kinch refers specially to the magnetite they contain. A great portion of this comes from the disintegration of volcanic rocks. Many of the Japanese lavas have a distinct effect upon a compass needle, and many of the black lavas from the crater of Fujisan will easily turn the needle of an ordinary compass through 360°. Many of the pieces of lava are not only magnetic but polar. Dr. Naumann found a block of augite trachyte on the top of Moriyoshiyama which would deflect the needle of a compass through 155°. The most curious observation made by this investigator was that the magnetic declination near Gaijusan has during the last eighty years (when it was about 14° 30' E.) decreased 19°, being now about 5° W. As we recede from this mountain the amount of

change is less. Assuming this result to be correct, it would seem justifiable to look to Gaujusan as connected with these local changes. Some of the volcanoes in the Kuriles are said to exert a marked influence upon the compasses of ships. When a vessel is lying near certain mountains, as, for instance, in Bear Bay at the north end of Iturup, a distant mountain will have a very different bearing to that which is indicated by the same compass when the vessel is a short distance outside Bear Bay. In both cases the ship may be lying in the same direction, and the direction of observation is practically along the same line. This leads Prof. Milne to urge, as he has already done, that a magnetic observatory should be placed on or near one of the nine active volcanoes of Japan. Changes in volcanic activity are probably accompanied by local changes in the magnetic effects produced by subterranean volcanic magmas. These changes may be due to alterations in position, alterations in chemical constitution, and changes due to the acquisition or loss of heat. If such is the case, he argues, the records of a magnetic observatory would lead up to a knowledge of the changes taking place beneath the ground. When it is remembered that volcanoes like Oshima (Vries Island), where it seems probable that there may be local and rapid changes in magnetic variation taking place, lie in the track of so many vessels, the proposed investigation has a practical as well as a scientific aspect. An investigation of earth-currents at and near volcanoes might be added to the magnetic investigations.

6. *Intensity of Eruptions.*—It appears from the accounts of eruptions which are given in the paper that the intensity of volcanic action in Japan has been as great as in any other part of the world. One period of unusual activity was between the years 1780 and 1800, a time when there was great activity elsewhere in the globe. It was during this period that part of Mount Unsen was blown up, and from 27,000 to 53,000 persons (according to different accounts) perished, that many islands were formed in the Satsuma sea, that Sakurajima threw out so much pumice material that it was possible to walk a distance of 23 miles upon the floating debris in the sea, and that Asama ejected so many blocks of stone—one of which is said to have been 42 feet in diameter—and a lava-stream 68 kilometres in length.

7. *The Form of Volcanoes.*—The regular so-called conical form is very noticeable in many of the Japanese mountains, especially perhaps in those of recent origin. Outlines of these volcanoes, as exhibited either by sketches or photographs, show curvatures which are similar to each other. From a collection of photographs Prof. Milne traced the profiles of a number of important mountains in Japan. These are reproduced in the paper (see Fig. 1). From an examination of these figures he found that the



FIG. 1.—Outline of Fujiyama, from a photograph. This may be taken as typical of many Japanese volcanoes.

curvature of a typical volcano was logarithmic, or, in other words, the form of such a mountain was such as might be produced by the revolution of a logarithmic curve round its asymptote. In his original paper on the subject he said that the form agreed with that which would be produced by the piling up of loose material. He ought to have said it was the form assumed by a self-supporting mass of coherent material. Mr. George F. Becker (*American Journal of Science*, October 1885) continues these observations by an analytical investigation of the conditions of such equilibrium. If the height of a column is a , its radius y , the distance of any horizontal plane from the base x , the specific gravity of the material ρ , and the co-efficient of resistance to crushing at the elastic limit k , then the equation of the curve, which by its revolution about the x axis will generate the finite unloaded column of the "least variable resistance" is—

where

$$c = \frac{2k}{\rho}$$

This latter quantity is of course different for different materials. It can be expressed in terms of x and y —

$$\frac{2k}{\rho} = \frac{y}{(\tan^2 d - 1)^{-1}}$$

d being the angle which the tangent at any point makes with the x axis. The value of c can be obtained from photographs or drawings of a mountain, while ρ may be obtained from pendulum experiments or from specimens of volcanic material. With these data we can determine the modulus of resistance at the elastic limit of the materials which compose a mountain on a large scale for many constituents of the earth's crust. Mr. Becker concludes his observations by remarking that a study of the form and dimensions of lunar volcanoes would lead to values of $\frac{k}{\rho}$, from

whence we might approximately determine whether the lunar lava is similar to that of terrestrial origin. In the table which follows, Prof. Milne has followed out Mr. Becker's suggestion, and calculated the modulus of resistance to crushing at the elastic limit in pounds per square foot for a number of Japanese mountains. The different values for $\frac{2k}{\rho}$ for the same mountain

is in great measure due to the absence of an accurate scale for the various photographs which had to be investigated. Another difficulty was obtaining a value for ρ , or the density of the mountain. Prof. Mendenhall, who made a number of experiments with pendulums on the summit of Fujisan, says the rocks of that mountain have a density of 1.75. This is when they have air in their pores. As powder the density becomes 2.5. Wada gives the specific gravity of the rock on Fujisan as 2.6.

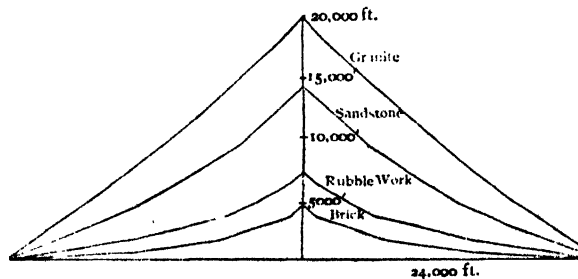

FIG. 2.—Theoretical Mountains.

Assuming the density of the earth at 5.67, then the density of Fujisan, as determined by Prof. Mendenhall's experiments, is 2.08. In the following table the density of the materials of all the mountains mentioned is taken at 2.5.

	Height in feet	$\frac{2k}{\rho}$	$\frac{k}{\rho}$	Load in lbs. per square foot	
Fujisan	12,441	4200	Photograph
	...	5000	"
	...	4240	"
	...	3500	"
	...	5420	"
	...	5450	"
	...	5440	"
	...	3945	"
	...	4133	"
	...	4430	Surveyed section
	...	3640	"
Average for					
Fujisan	...	4490	2245	350,220	"
Iwakisan	5260	2360	1180	174,080	Photograph
Nantaisan	3800 ¹	2000	1000	156,000	"
Alaid	7773	2195	1078	163,168	
		2120			
Krakatao	2745	1310	655	102,180	Surveyed section
	...	1310			

Comparing the results given in the above table with the numbers given in the next section, which are based on experi-

¹ This is the height above Lake Chuzenji.

nents referred to in Rankine's "Civil Engineering," it may be said that the average strength of Fujisan lies between that of rubble work and sandstone; Iwakisan, Nantaisan, and Alaid are like good rubble masonry, while the strength of the ill-fated Rakatso is not much above that of ordinary brickwork.

8. *Theoretical Mountains.*—As it might be interesting to compare actual mountains with theoretical mountains constructed from the equation—

$$y = \frac{c}{2} \left(e^{\frac{x}{c}} - e^{-\frac{x}{c}} \right)$$

such mountains have been drawn, and are shown in Fig. 2. The values of *c* are given in the following table.

In drawing up the table the instantaneous breaking strength of granite and its crumbling strength, which is the largest possible value for *k*, are taken as being equal. For sandstone the crumbling strength is assumed to be three-fourths of the breaking strength, while for rubble work and brickwork it has been taken as one-half.

Material	Instantaneous breaking strength in lbs. square feet	Crumbling strength or <i>k</i> in lbs.	Weight cubic foot lbs.	$c = \frac{ak}{\rho}$
Granite	1,584,000	1,580,000	170	18,500
Sandstone.....	790,000	590,000	144	8,200
Rubble masonry ...	316,000	150,000	120	2,500
Brickwork	144,000	72,000	112	1,300

The diameter of the base of each of these mountains is 48,000 feet, and the height to which mountains of the following different materials could be built upon such a base without crushing would approximately be:—

Brickwork	4,600 feet	Sandstone.....	14,500 feet
Rubble masonry ..	7,300 ,,	Granite.....	20,000 ,,

9. *Causes Modifying Volcanic Forms.*—Causes modifying the natural curvature of a mountain are:—

- (1) The tendency during the building up of the mountain of the larger particles to roll farther down the mountain than the smaller particles.
- (2) The effects of atmospheric denudation, which carries materials from the top of the mountain down toward the base.
- (3) The position of the crater, and the direction in which the materials are ejected.
- (4) The existence of parasitic craters on the flanks of a mountain.
- (5) The direction of the wind during an eruption.
- (6) The sinking of a mountain in consequence of evisceration beneath its base.
- (7) The expansions and contractions at the base of a mountain due to the acquisition or loss of heat before and after eruptions.

10. *Effect of Volcanic Eruptions on the People.*—The eruptions in Japan from time to time have exerted a very marked influence upon the minds of the Japanese people. Divine interference has been sought to prevent eruptions, priests have been ordered to pray, taxes have been repealed, charities have been instituted, special prayers against volcanic disturbances have been formulated, and have remained in use for the period of 100 years, while special days for the annual offering up of these prayers have been appointed. At the present day a form of worship to mountain deities is not uncommon.

SOLUTION¹

Opening of the Discussion by Prof. Tilden

FOR want of time, the consideration of various phenomena connected with the subject was necessarily omitted. Thus no reference could be made to the various formulæ relating to expansion or density of solutions, nor to their optical properties, magnetic rotation, nor to the subject of electrolysis. In what follows, a review is presented of the principal phenomena observed in the act of solution of solids (especially metallic salts and other comparatively simple compounds) in liquids, and the chief properties of the resulting solutions, with the object of arriving (if possible) at some conclusion as to the physical explanation of the facts. The question must at once arise whether these phenomena are to be considered as chemical or mechanical, and all the theories which have been put forward to explain the nature of solution are roughly divisible into two classes, according as, on the one hand, they represent the process as a kind of chemical combination, or, on the other, explain the

¹ Report of a discussion at the Birmingham meeting of the British Association.

phenomena by reference to the mechanical intermixture of molecules, or by the influence of the rival attractions of cohesion in the solid and liquid, and of adhesion of the solid to the liquid. The former hypothesis seems to have been universally adopted by the older writers, such as Henry and Turner, and it seems pretty clear that Berthollet also regarded solution as an act of chemical combination. Among modern chemists, Prof. Josiah P. Cooke takes a similar view, but M. Berthelot is the most consistent and powerful supporter of the same hypothesis. In his "Mécanique Chimique," tome ii. p. 160, will be found a very clear and formal statement of the views upon this subject which, it is interesting to know, are retained by M. Berthelot without modification in any essential particular.

On the other hand, there are a number of writers who, whilst referring the phenomena of solution to a molecular attraction of some kind, do not attribute solubility to the formation of chemical compounds of definite composition. Graham distinctly ranges himself on this side. Brande also appears to have taken a similar view; Daniell, Miller, Nicol, and Dossios may be more or less ranked with them. A theory differing in some important respects from those of the above writers was briefly enunciated in a paper communicated to the Royal Society by Tilden and Shenstone in 1883. In discussing the connection between fusibility and solubility of salts, the authors point out that the facts tend to "support a kinetic theory of solution, based on the mechanical theory of heat. The solution of a solid in a liquid would accordingly be analogous to the sublimation of a solid into a gas, and proceeds from the intermixture of molecules detached from the solid with those of the surrounding liquid. Such a process is promoted by rise of temperature, partly because the molecules of the still solid substance make longer excursions from their normal centre when heated, partly because they are subjected to more violent encounter with the moving molecules of liquid." This theory, however, only relates to the initial stage of the process of solution, and does not sufficiently explain saturation nor the influence of dissolved substances upon vapour-pressure, specific heat, specific volume, &c. How far is it true that evolution of heat indicates chemical combination: does the evolution of heat which often takes place on dissolving a solid in water, or on adding more water to its solution, indicate the formation of hydrates, *i.e.* compounds of the dissolved body with water in definite proportions? Thomsen answers this question in the negative ("Thermochemische Untersuch.," Band iii. p. 20).

Take the case of sulphuric anhydride (SO₃). It is evident from the diagram exhibited that more than half the total evolution of heat occurs on addition of the first molecule of water to the solid substance; yet the succeeding molecules give quite an appreciable thermal change. At what point in such a curve should we be justified in setting up a distinction between the effect due to chemical combination and that due to other causes, such as the change of volume consequent on dilution or the possible loss of energy from the adjustment of the motion of the molecules of the constituents to the conditions requisite for the formation of a homogeneous liquid, or (though not in the present case) the decomposition of the compound by the water? In the act of solution of the solids, and especially of anhydrous salts in water, the volume of the solution is always less than the sum of the volumes of the solid and its solvent, with the exception of some ammonium salts in which expansion occurs. Similarly the addition of water to a solution is followed by contraction. This contraction may be due to mere mechanical fitting of the molecules of the one liquid into the interspaces between the molecules of the other (see Mendelejeff's abstract in *Journ. Chem. Soc.*, Feb. 1885, p. 114). This would probably not be attended by loss of energy. Or the contraction may arise from the readjustment of molecular motion already referred to.

If we know the coefficient of expansion of the liquid and its specific heat, we can calculate the amount of heat evolved for a given contraction. If this is done for sulphuric acid, and many other cases, it is found that, after accounting for the thermal change due to alteration of volume alone, there is a surplus of heat evolved which may really indicate some kind or some amount of chemical combination.

Thomsen has found that as a rule the heat of solution and of dilution are both either positive or negative. Of thirty-five salts examined, only four supply well-marked exceptions. However we may ultimately explain the anomaly exhibited by these salts, the fact remains that the heat evolved or absorbed during the admixture of any substance with water is in every case a continuous function of the quantity of water added. Similarly

the contraction which ensues on diluting an aqueous solution proceeds continuously, and the molecular volume of a salt in solutions of different strengths is continuously greater the larger the amount of salt present. So that in none of these thermal or volumetric phenomena is any discontinuity observed, or any indication of the formation of compounds of definite composition, distinguishable by characteristic properties.

The question we are now considering, as to whether in a solution the solvent and the substance dissolved in it—or any portion thereof—exist independently of each other, is in some degree answered by the facts known as to the specific heats and vapour-pressures. For instance, when water is added to a solution of sodium nitrate, the molecular heat of the resulting liquid seems to show that all the water added is influenced at least until a very large quantity is present. In this case one molecule of sodium nitrate can affect the movements of a hundred molecules of water, and probably more. It is also well known that the vapour-pressures of water holding in solution almost any dissolved solid is less than the vapour-pressure of pure water, and that the boiling-point of a liquid is raised by the addition to it of any soluble non-volatile substance. This fact of reduction of pressure can only be explained upon the hypothesis that there is no free water present at all; that is, that there is no water present which is not more or less under the influence of the dissolved substance.

What becomes of water of crystallisation forms a part of the same question as to the relation of solvent to solvent. Observed facts lead us to conclude that white copper sulphate, blue anhydrous cobalt chloride—and, by analogy, other salts which are colourless—retain their hold upon water of crystallisation when they are dissolved in water. A very important observation has been made by Dr. Nicol which bears directly upon this question. In his study of the molecular volumes of salt solutions he finds that, when a salt containing water of crystallisation is dissolved, this water is indistinguishable by its volume from the rest of the water of the solution. In the report presented to the British Association last year, the following passage occurs: "These results point to the presence in solution of what may be termed the anhydrous salt in contradistinction to the view that a hydrate, definite or indefinite results from solution; or in other words, no part of the water in a solution is in a position relatively to the salt different from the remainder."

These two statements, however, are not strictly consequent upon each other. The view seems preferable that (save, perhaps, in excessively dilute solutions) the dissolved substance is attached in some mysterious way—it matters not whether it be supposed to be chemical or physical—to the *whole* of the water. We cannot otherwise get over the difficulty presented by the hydrated salts, which give coloured solutions, by the control of the vapour-pressure of the dissolved salt, and by the altered specific heat. With regard to water of crystallisation, E. Wiedemann has shown that hydrated salts in general expand enormously at the melting-point; and the observations of Thorpe and Watts on the specific volume of water of crystallisation in the sulphates of the so-called magnesium group show that, whilst the constitutional water occupies less space than the remaining molecules, each successive additional molecule occupies a gradually increasing volume. So that when a salt, with its water of crystallisation, passes into the liquid state (either by melting or by solution in water), it requires a very slight relaxation of the bonds which hold the water to the salt for it to acquire the full volume of liquid water, whilst the water of constitution is not so easily released. And this conclusion accords with Nicol's observations on the molecular volumes of the salts when in solution.

Now comes the question as to what determines the solubility of a substance. Why, for example, is magnesium sulphate very soluble in water, whilst barium sulphate is almost totally insoluble? With regard to salts the following propositions seem to be true:—(1) Nearly all salts which contain water of crystallisation are soluble in water, and for the most part are easily soluble; (2) insoluble salts are almost always destitute of water of crystallisation and rarely contain the elements of water; (3) in a series of salts containing nearly allied metals the solubility, and capacity for uniting with water of crystallisation generally, diminish as the atomic weight increases.

The fusibility of a substance has also much to do with its solubility. Neither fusibility alone nor chemical constitution alone seems to be sufficient to determine whether a solid shall be soluble or not. But it may be taken as a rule to which there

are no exceptions that when there is a close connection in chemical constitution between a liquid and a solid, and the solid is at the same time easily fusible, it will also be easily soluble in that liquid.

Salts containing water of crystallisation may be considered as closely resembling water itself, and these are for the most part both easily fusible and easily soluble in water. But space is wanting for the discussion of the details of these matters, as well as of the relation of molecular volume to fusibility of solids.

The fascinating character of the phenomena of supersaturation has attracted a host of experimenters, but no definite explanation has been generally accepted. In the opinion of the speaker supersaturation is identical with superfusion. Supersaturated solution of, say, alum, thiosulphate of sodium melted in its water of crystallisation, and fused sulphur at 100°, exhibit phenomena of exactly the same kind.

Finally, we are led to the consideration of what is meant by chemical combination. From the phenomena under discussion, and others, the conclusion seems inevitable that chemical combination is not to be distinguished by any absolute criterion from mere physical or mechanical aggregation; and it will probably turn out ultimately that chemical combination differs from mechanical combination, called cohesion or adhesion, chiefly in the fact that the atoms or molecules of the bodies concerned come relatively closer together, and the consequent loss of energy is greater.

UNIVERSITY AND EDUCATIONAL INTELLIGENCE

CAMBRIDGE.—Of the students in Natural Science entered at Cambridge this term no fewer than 116 have already announced their intention of studying medicine.

DUBLIN.—The Senate of the Royal University has conferred the degree of Doctor of Science *honoris causa* upon James Bell, Ph.D., F.R.S., Principal of the Somerset House Laboratory.

SCIENTIFIC SERIALS

Revue d'Anthropologie, troisième série, tome I, Paris, 1886.—On the Simian characters of the Naulette jaw, by M. Topinard. This celebrated find, which was discovered at the bottom of an obscure cavern 25 m. below the present level of the Lesse, near Dinant, in Belgium, is chiefly remarkable for its excessive prognathism, which is due alike to the great thickness of the horizontal branch of the jaw when compared with its height, and to the special obliquity of the axis of the alveolus of the second molar. In its relative proportions the Naulette jaw must be characterised not only as non-human, but as plus-Simian. A careful comparison of the Naulette jaw with the maxillary processes of the anthropoids, and of several of the lowest extant human races, has led M. Topinard to the conclusion that in the age of the mammoth, tichorine rhinoceros, and cave-bear, there had already appeared numerous mixed human types, to one of the lowest of which it may be presumed that the Naulette jaw belonged.—On the population of Bambouk, on the Niger, by Dr. Colin. An interesting paper on an extensive, but very imperfectly-known, region of Western Soudan, exclusively inhabited by a branch of the great Manding race, known as the Mali-nkés. The Bambouk territories, more than 600 kilometres in length, and from 80 to 150 in width, are divided into numerous little States, most of which enjoy a complete autonomy. Their want of consolidation, and the indifference of the people to all forms of religion, have made the Mali-nkés objects of contempt to their Mussulman black neighbours, but according to the narrations of the Griotes, or itinerant bards, who are to be met with in every part of Western Africa, they had at one time extended their dominion over all the tribes on the right banks of the Niger, and were preparing to invade Saigon when the advance of the French forced them to fall back within their original limits. For a time they submitted to the restrictions of Mohammedanism, but now they appear to have absolutely no religion. They prepare an intoxicating drink from honey, called "dolo," in which women as well as men indulge to excess. The men are indolent, hunting only to avert starvation, and working their exten-

sive gold-mines imperfectly, and chiefly by the help of the women, to whom falls the chief share of providing for the wants of the community, but who, after marriage, enjoy great freedom, although the young girls are kept under strict supervision.—On the human bones found in France in caverns belonging to the Quaternary age, by M. Cartailhac. Of such finds, none can be referred to the early period of the Saint Acheul, or Chelles deposits, the oldest belonging apparently to the Mousterian age, while the most abundant human remains are found in the comparatively recent beds of Solutré and La Madelaine. The former of these are remarkable for the enormous number of horse-bones accumulated about the stone hearths and in the kitchen-middens of this station. According to Dr. Cartailhac, 40,000 skeletons might be reconstructed from these equine remains, which seem to have been exposed to the action of fire, the greater number of the bones having been broken for the extraction of the marrow, whence he assumes that the horse must have reached its maximum development and served in the place of all other game at the period of the Solutré deposits. The writer compares together the human and other remains found in various Mediterranean and inland caves, with the special object of ascertaining how far the condition and mode of deposition of the skeletons can throw light on the vexed question whether the great preponderance of fractured over whole bones in these primæval graves indicates the practice of cannibalism, or whether it may not be dependent on the observance of special modes of burial, involving the burning or dismemberment of the body after death.—The facial angle proposed by Cuvier and Geoffroy Saint-Hilaire for comparative anatomical determinations and for measuring facial differences in the living subject, by Dr. Collignon. The writer, who considers at length the merits of the various angles proposed by Camper and others, concludes by showing the superiority, for practical purposes, of adopting Cuvier's facial angle, measured by Topinard's goniometer for determining the median angle.

SOCIETIES AND ACADEMIES

PARIS

Academy of Sciences, October 26.—M. Jurien de la Gravière, President, in the chair.—On the unequal flow of gases, by M. Haton de la Goupillière. In continuation of his recent communication on this subject the author here deals with the reverse problem of a receptacle originally filled with compressed air discharging itself freely into the atmosphere.—On the intensity of the magnetic field in dynamo-electric machines, by Marcel Deprez. Assuming that the most important element of a dynamo-electric machine, whether employed as a generator or receiver, is the magnetic field, the author deals with the influence of the deviation of the magnetic pieces, and shows that, contrary to the opinion of certain electricians, the intensity of the field decreases far less rapidly than the distance of the magnetic pieces increases. The influence of the dimensions perpendicular to the lines of force is also considered.—Researches on the decomposition of the bicarbonate of ammonia by water, and on the diffusion of its components through the atmosphere, by MM. Berthelot and André. From the experiments here described, the authors are led to the conclusion that it is the diffusion of the carbonic acid that determines the decomposition by water of the bicarbonate of ammonia, and consequently the transport of the ammonia itself. These results are of the greatest importance even for the purely physical study of the circulation of gases between the ground, the waters, and atmospheric air, apart altogether from the phenomena of vegetation.—Note accompanying the presentation of his work entitled "An Introduction to the Study of the Human Races," by M. de Quatrefages. This is the first volume of the "Bibliothèque d'Ethnologie," edited jointly by the author and M. Hamy. It contains a summary of the views expounded in greater or less detail in his other writings, while dealing more fully with a number of other matters, which he had hitherto merely indicated, or else entirely neglected for lack of the fresh data and discoveries which now enable him to discuss them seriously. One of the most important is the question of prehistoric man, and he now shows that even in Quaternary times the human race had already spread over the whole earth to the remotest extremities of the Old and New World. This ubiquity of Quaternary man already suggested the existence of the species in the previous epoch, and direct proofs of

this fact have recently been multiplied to such an extent that the presence of man in Europe during Tertiary times may now be regarded as placed beyond reasonable doubt, although his presence in America is not yet established. The results yielded by palæontology, geology, and even history point to the extreme north of Asia as the cradle of the human race and the centre of dispersion, which had already begun in Tertiary times. Here also were differentiated the three fundamental types, to which all races may still be reduced, as well as the three linguistic types diffused throughout the globe. It is further shown that hypsistenocephaly is the main feature distinguishing the American from the European primitive race, and that the man of Canstadt, hitherto regarded as the oldest Quaternary type, in reality dates back to the Tertiary epoch.—Note on the meteorite which fell on January 27, 1886, at Nammianthul, in the Presidency of Madras, by M. Daubrée. This meteorite, a specimen of which has been received from Mr. Medlicott, of the Indian Geological Survey, presents the ordinary characters of the group of small sporadic asters.—Experiments on the transmission or force by means of a series of dynamo-electric machines coupled together, by M. Hippolyte Fontaine. These important experiments (carried out with seven Gramme machines, under the inspection of the Commissioners, MM. Bertrand, Becquerel, Cornu, Maurice Lévy, Marcel Deprez, and Mascart) show that it is possible to transmit an effective force of fifty horse-power through a resistance of 100 ohms at a loss of less than 50 per cent.—On algebraic surfaces capable of a double infinity of birational transformations, by M. E. Picard. In supplement to his previous communication on algebraic surfaces, the author here shows that, for all surfaces capable of a double infinity of birational transformation, the co-ordinates of any given point are expressed by the uniform (Abelian) functions of two parameters.—On the transformation of surfaces in themselves, by M. H. Poincaré. It is shown in connection with M. Picard's theorem that, in certain cases, the Abelian functions may degenerate into triply periodical, elliptical, or even rational functions.—Extension of Riemann-Roch's theorem to algebraic surfaces, by MM. Noether.—On the recomposition of white light by means of the colours of the spectrum, by M. Stroumbo. A process is described by means of which the recomposition of white light is effected, taking as the starting-point the very colours of the spectrum, and utilising, as in Newton's experiment with the disk, the persistence of the images on the retina.—Note on the principal showers of shooting-stars and the aurora borealis, by M. Ch. V. Zenger. A careful study of M. Rubenson's great Catalogue of the Auroras from 1800 to 1877 has unexpectedly revealed the fact that August 10 and November 14 show a great frequency of these lights, thus coinciding with the periods of the shooting-stars and suggesting a connection between these two orders of phenomena.—Influence of the amplitude of the lunar oscillation in declination on the shiftings of the northern trade-winds, by M. A. Poincaré. A study of the tables for 1880-83 shows certain relations between these phenomena, which, however, differ greatly according to the seasons.—On the phenomena associated with the heating and cooling of molten steel, by M. Osmond. It is shown that, as the quantity of carbon is increased, the temperature of transformation of the iron is lowered, and that of recalescence raised, so that both coincide in the hard steel.—Saturation of normal arsenic acid by the water of baryta, by Ch. Blarez.—On the function of the semicircular canals of the inner ear, by M. Yves Delage. The chief function of this apparatus, as already recognised by Goltz, Flourens, and others, is shown to be distinct from that of the auditory sense, and connected rather with the rotatory movements of the head, either alone or with the body.—On Syndesmis, a new type of Turbellariæ described by W. A. Sillimann, by M. Ph. François. This organism is shown to be, not an ectoparasite of the large green nematoid, as supposed by Sillimann, but a true endoparasite of *Strog. lividus*.—On two Synascidians new to the French sea-board (*Dianona hebridica*, Forbes and Goodsir, and *Distaplia rosea*, Della Valle), by M. A. Giard.—Organisation of *Lepidomenia hystrix*, a new type of Solenogaster, by MM. Marion and Kowalevsky.—On the Gephyrians belonging to the family of the Priapulidæ collected by the Cape Horn Mission, by M. Jules de Guerne. The discovery of these organisms is a remarkable instance of the presence in the southern seas of forms almost identical with those of the Arctic Ocean.—The simple epidermis of plants considered as a reservoir of water, by M. J. Vesque.—Remarks on *Porosylon stephanense*, by MM. C. Eg. Bertrand and R. Renault.—On

the taxonomic importance of the petiole, by M. Louis Petit.—On the reproductive organs of vegetable hybrids, by M. Léon Guignard.—On the relations of geodesy and geology: a reply to the observations of M. Faye, by M. A. de Lapparent.

BERLIN

Meteorological Society, October 5.—Dr. Brix, in the name of the Telegraph Administration, handed over to the Society a paper containing the results of observations respecting earth-currents instituted through the medium of German telegraph lines, and giving a brief history of these investigations.—Dr. Assmann spoke of the thunderstorms of the summer of 1886.

Physical Society, October 22.—Prof. von Helmholtz in the chair.—Prof. Börnstein communicated the results of his investigations into the thunderstorms of July 1884. The days from July 13 to 17 were very prolific in thunderstorms, and respecting them the speaker had collected and elaborated observations from more than 200 stations in Germany. For twenty-four separate thunderstorms, drawings were made of the "isobronts," isobars, and isothermals, from which it appeared that a fall in the barometer always preceded the outburst of the storm; that with the occurrence of the sinking of the barometer the atmospheric pressure rose very steeply and then relapsed gradually to its former level; and that the temperature, which was very high before the storm, declined rapidly with the outbreak of the storm. Local observations had formerly led to the same result. The "isobronts," or the lines uniting the places where the first peal of thunder was simultaneously heard, had in general a north-south direction. The "isobronts" made the passage from west to east with an average swiftness of from 38 to 39 kilometres an hour. The "isobronts" were attracted by the mountains, so that the part in whose west-east direction a mountain was situated approached it sooner, and, after the passage of the "isobront," delayed there longer than did the remaining part. Rivers retarded the progress of thunderstorms, and small thunderstorms often terminated at large rivers without crossing them. This relation of thunderstorms to mountains and rivers might be explained on the assumption that the storms were caused by ascending air-currents. When such an ascending air-current approached a mountain, then the mountain hindered the horizontal air from flowing in at the anterior side of the ascending current. The air flowing in at the posterior side, on the other hand, thereby obtained the preponderance, and urged the phenomenon with all the greater force to the mountain. The reverse occurred after the thunderstorm had surmounted the mountain. The horizontal currents in front then obtained the preponderance, and delayed the progress of the storm. The influence of the rivers found its explanation in the fact that the air above the water was considerably cooler than the air above the land, whereby a descending air-current was continuously maintained, operating in opposition to the ascending current of the thunderstorm, to the possible degree even of annulling it. The speaker had been able artificially to produce an imitation of all these processes by causing, in accordance with the directions of Dr. Vettin, visible currents to ascend in a glass box filled with tobacco smoke, by means of local depressions of temperature, by setting these currents in constant motion, and making them strike against obstructions (corresponding with the mountains), as also on descending currents which were likewise artificially created. In the discussion which followed the above address, Dr. Vettin laid stress on the fact that precisely at the moment when the barometer mounted steeply from its lowest position, the thunder followed the lightning most rapidly, and discussed how, in accordance with his conception of the nature of thunderstorms, by the curving round of the ascending air-current, a whirling movement round a horizontal axis came into shape, whereby, as determined by its situation and its extent, were produced thunderstorms, sleet, and hail.—Prof. von Helmholtz described the formation of a thunderstorm observed by him in Rigi-Kaltbad. From a free point of prospect, allowing a survey of the plain as far as the Jura, he observed how the lower warm and moist layer of air was distinguished by a sharp horizontal boundary of somewhat long strips of cloud from the upper dry and cooler air. The cloud-masses resembling the stripe-shaped cirri diffused themselves and formed a coherent level boundary-layer between the two air-masses. He next noticed, at different spots, balls of cloud arise above the boundary-layer, evidently as the effects of ascending air-currents. The different cloud-heaps then rose higher and grew into larger cloud-masses

within which different electric sparks leapt from one spot another. It was only subsequently that he saw the lightning do downward to the earth. At last a heavy rain rendered the low air-mass, bounded by the horizontal cloud-basis occupying position nearly at a level with the height of the stand-point which had hitherto been clear, opaque. The phenomenon developed itself under weather in which the wind was at rest and could be followed very precisely into its details.—Prof. Schwalbe reported on an investigation of Herr Meissner, who in the Strasburg Laboratory, had determined the warmth effect on the wetting of powdery bodies. In the way of powder was used amorphous silicic acid, glass, emery, carbon; as fluid distilled water, benzol, and amyl alcohol. In all cases increase of temperature was observed.

BOOKS AND PAMPHLETS RECEIVED

La France en Indo-Chine: Bouinai and Paulus (Challamel, Paris).
Zeitschrift für Wissenschaftliche Zoologie, October 1886 (Engelmann, Leipzig).—Huddersfield Technical School Calendar for 1886-87 (Broadbent Huddersfield).—Student's Hand-Book of Historical Geology: A. J. Juk Browne (Bell and Sons).—Units and Physical Constants, and edition: J. Everett (Macmillan and Co.).—Principles and Practice of Canal and River Engineering, 3rd edition: D. Stevenson (Black, Edinburgh).—Monthly Weather Report, June 1886.—Quarterly Weather Report, January-March 1886.—Report of the United States Commission of Fish and Fisheries Part 11, for 1883 (Washington).—Phantasms of the Living, 2 vols.: Gurne Myers, and Podmore (Trübner and Co.).—Den Norske Nordhøus Expedition, 1876-78, XV. Zoologi; Crustacea, 11.: G. O. Sars (Gronlund Christiania).—Bulletin of the U.S. National Museum, No. 30: J. Marcou (Washington).—Proceedings of the Society for Psychical Research October (Trübner and Co.).—Scientific Prevention of Consumption: G. V Hambleton (Churchill).

CONTENTS

PAGE

Explosions in Coal-Mines. By Prof. T. E. Thorpe, F.R.S.

McLennan's "Studies in Ancient History." By Dr. W. Robertson Smith

British Hymenomycetes

The Ocean

Letters to the Editor:—
On the Connection between Chemical Constitution and Physiological Action.—Dr. James Blake
Disinfection by Heat.—R. Strachan
The Beetle in Motion.—Prof. C. Lloyd Morgan. (Illustrated)
The Astronomical Theory of the Great Ice Age.—W. H. S. Monck
The Enormous Loss from Ox-Warble.—John Walker Aurora.—Prof. F. Hahn
Earthquakes.—Dr. F. A. Forel; H. du Bois
Meteor.—Joseph John Murphy

Frederick Guthrie

The Longevity of Great Men. By Joseph Jastrow 1

The Geology of the Lebanon. By Prof. Edward Hull, F.R.S. 1

Autumnal Flowering. By Dr. Maxwell T. Masters 1

Arrow-Release. (Illustrated) 1

Climatology of the Croydon District 1

Notes on the Recent Swarming of Aphides. By G. B. Buckton, F.R.S. 1

Notes 1

Our Astronomical Column:—
The Binary Star γ Coronæ Australis 1
Oppolzer's Astronomical Refractions 1
Comets Finlay and Barnard 1

Astronomical Phenomena for the Week 1886
November 7-13 1

The High Temperature in October. By Chas. Harding 1

Volcanoes of Japan. By Prof. Milne. (Illustrated). 1

Solution 2

University and Educational Intelligence 2

Scientific Serials 2

Societies and Academies 2

Books and Pamphlets Received 2

THURSDAY, NOVEMBER 11, 1886

LETTERS AND JOURNAL OF W. STANLEY JEVONS

Letters and Journal of W. Stanley Jevons. Edited by His Wife. (London: Macmillan and Co., 1886.)

A STRIKING but sad book is this autobiography; for though "written to give the best idea of the character of the man in the various relations of life more than to recount scientific work," it is practically an autobiography: there is scarcely a critical remark upon his thoughts or conduct in it.

The family for many generations had been settled in Staffordshire. The grandfather came to Liverpool, and commenced business as an iron-merchant there, and his son Thomas, a man of ability in many ways, joined him in it. This was the father of William Stanley Jevons, who had, moreover, the almost invariable precedent of a clever man (*pace* Mr. F. Galton), viz. a clever mother, whom, however, he had the misfortune to lose at ten years old. She was the daughter of William Roscoe, author of the "Life of Lorenzo de Medici" and "Leo the Tenth." Another misfortune, from which, however, he learnt the value of money in a practical sense, befell him at the age of thirteen, when the firm of Jevons and Sons failed; and his grandfather, who died in 1882 at the advanced age of ninety-one, came to live with them.

A characteristic very marked, and to a marvellous extent affecting his whole subsequent life, was a bashfulness or "natural timidity of character which," his father wrote him, "is the worst, or perhaps I may say the only, weakness you have." This led to self-depreciation, and at school the French master complained that he was far too quiet and made no noise, and did not read above his breath. Shrinking from his companions and their fun, however, he early acquired the habit of directing his attention and mental powers at his will, and nothing tried his naturally passionate temper more than to be compelled to leave the pursuit of the moment while still engrossed in it. Reports of him as a scholar naturally kept continually improving, and, though laboriousness is throughout his characteristic, his sister writes in her diary that she saw in Stanley at the age of fourteen the dawns of a great mind.

Botany and chemistry, in both of which he subsequently took honours, were the two sciences which attracted him first. The former was begun under the loving eye of his mother: the latter was the first that he took up at University College School, and "followed fiercer and fiercer till he gained the University gold medal."

He had decided at seventeen to go into a chemical manufactory at Liverpool, in order to remain near home; but before he had ended his last term of study at the University his wishes and plans were all upset by Profs. Williamson and Graham recommending him for the appointment of Assayer to the new Mint in Australia. He shrank from it as being too heavy a post for a youth of eighteen, and as going terribly against his wish to settle at home. But an income of 675*l.* a year was too good an offer to be refused. On June 29, 1854, not yet nineteen years old, he set sail for Sydney.

VOL. XXXV.—No. 889

While at Sydney he attacked the Australian meteorology, and published his observations; more, as he explains, to show what phenomena had to be solved and what interesting connections of cause and effect might be suggested. Geology also, which he had commenced shortly before he left England, he there followed up. There he first suggested a collection of newspapers from all parts of the world as a curious exhibition; there also he heard of the death, after seven years of reviving prosperity in trade, of his father in November 1855. Though doing so well financially, he still cherished the feeling that he was losing time which he might put to better advantage. After four years he resigned his post, and on his return, *vid* Callao, Panama, St. Thomas, Havanna, and several cities of the United States, he made his way up country past Minneapolis, to visit a brother who had gone out to settle there. Returning thence by way of Niagara and Montreal to New York, he landed at Liverpool, but soon went on to London and re-entered the University. He joined several senior classes in company with his younger brother, whose education he was then paying for. He had decided thenceforth to follow up political economy and mental philosophy.

His "Theory of Political Economy" was read as a paper but not "approved" by the British Association at Cambridge in 1862. It was published in 1871, and reached a second edition in 1879. Though it attracted the attention of some eminent foreigners, it was coldly received in England—the free use of mathematical symbols placing it above the heads of those practically engaged in commercial pursuits. In 1875, at the British Association meeting at Bristol, he read another well-known paper on the connection between sunspots and the price of corn—bad crops of the latter, we need hardly add, being followed by a high price and bad trade—and though he spoke at first very doubtfully of his theory, yet up to the time of his death, in 1882, he believed that a great revival of trade would take place almost immediately, to be followed by seven years of unprecedented prosperity, and he had speculated accordingly. Gold, however, alas, seems a more important factor than sunspots.

A more famous paper still was his "Coal Question," published in 1865. It was a question in which the whole nation took an interest, and it supplied a text for one of Mr. Gladstone's economical budgets. Accordingly it was discussed in every paper, political, economical, or social, and is perhaps better known now than any of his other writings.

His earlier writings had brought him in very little, and in 1863 he had accepted the not very lucrative post of tutor at Queen's College, Manchester. In 1866 he was appointed Professor of Logic and Mental and Moral Philosophy, and Cobden Professor of Political Economy, at 300*l.* a year. A thorough teacher, he was much liked by his pupils, never tiring of making them understand, and watching their careers in after life.

In December 1867 he married the daughter of Mr. J. E. Taylor, founder and proprietor of the *Manchester Guardian*. To her we are indebted for this well-arranged selection of letters.

In 1864 he published his first work on "Pure Logic," chiefly founded upon Prof. Boole's system. In 1865 he invented a logical machine or abacus which he

describes as working in a few moments any logical problems involving no more than four distinct terms or things. It was like a small piano, three feet high, with twenty-one keys. A second book upon logic was published in 1869, just after this had been made to work correctly, entitled "The Substitution of Similars," containing a sketch of the fundamental doctrine of his great work, "The Principles of Science," which was not published in full till 1874, but reached a second edition in one volume in 1877.

In 1870 his "Elementary Lessons in Logic" appeared in Macmillan's series of science class-books, followed in 1876 by the "Primer of Logic," one of the same publishers' more elementary series; and in 1880 "Studies in Deductive Logic" for students desiring a more thorough course of logical training.

In 1868 he had prepared three articles attacking J. S. Mill's system of logic. They were declined at first, but three years afterwards, soon after the death of Mr. Mill, they were accepted by the *Contemporary Review*. It is curious to see two such mighty champions of such a learned science referring their differences to an uneducated public and to their instinctive logic!

Though sorry on many accounts to leave Manchester, his heart had never left London and its University, to which he returned in 1876 as Professor of Political Economy. In that year he boldly read a paper laying it down that the United Kingdom Alliance was the worst existing obstacle to temperance reform in the kingdom—driving the enemy to a man into fierce opposition.

His first illness through over-work had occurred in 1869, and from that time his letters in large proportion are from various places—Norway was his favourite resort—to which he had been driven to regain strength. Trip after trip was taken, but with no permanent effect. As soon as he returned he again overwhelmed himself with work, involving too great tension of the brain. The labour especially of taking his class when out of sorts was a "painful" labour to him. To relieve himself from this he resigned his Professorship in 1880, and in 1882, after two years more of work at home, but still at high pressure, a plunge into the sea was too sudden a chill for his enfeebled frame, and insensibility and death were the sad result, at the prime age of forty-six.

One cannot help sorrowfully noting how his childish bashfulness was the cause of his early death. It led to unsociability and abstinence from recreation. Instead of rejoicing in his strength, he shunned his companions, and persuaded himself, moreover, that it was his duty to do so, though he bitterly regrets it afterwards, one result being an inability to speak in public and communicate his ideas as he would wish. The ardent cultivation of his many talents, again, increased a feeling of superiority, yet often left him low-spirited. In some it might have brought carelessness and improvidence, but in Jevons it was attended by a feeling of responsibility almost religious. At twenty-three he threw up his easy and lucrative post at the Sydney Mint in obedience to this feeling, and, later on, he resigned one laborious duty only to buckle to another, and under such labour his life was quenched.

GENERAL PATHOLOGY

An Introduction to General Pathology. By J. B. Sutton, F.R.C.S. (London: J. and A. Churchill, 1886.)

UNTIL recently, pathologists have confined their attention to studying the processes of disease in human beings, and but little effort has been made to take advantage of the vast field of material presented by the animals which die in the Gardens of the Zoological Society. Since 1878 the author has systematically examined the bodies of 12,000 animals and of over 800 still-born and immature fetuses; and from this vast stock of material he has, for the purposes of the present work, selected, from all parts of the animal kingdom striking examples which illustrate the main pathological and physiological processes of life. The same principle govern both, and processes which in one group of animals are the cause of disease, in another, owing to anatomical differences, habits of life, and surroundings, have no such influence. Moreover, pathological defects are frequently inherited, and become looked upon as racial peculiarities. Thus the horns of the Ungulata, the curved canines of the Babiroussa, the atrophied right ovary and right carotid artery in many birds, the large third with the small second and fourth metacarpals of the horse, are now persistent, but were probably originally accidental and pathological.

The degree of development of the muscular tissue of the gizzard of a bird is dependent upon the nature of its food. The herring-gull of the Shetland Islands changes its food twice every year—in the summer living on grain, when its gizzard is of the granivorous type, and in the winter on fish, when the gizzard reverts to the carnivorous condition. The same variations have been artificially produced by varying the food of sea-gulls, pigeons, ravens, and owls. While excessive function is the great cause of hypertrophy of organs, deficient usage is the determining factor in the abnormal overgrowths of hair, nails, beaks, and teeth. Rodents in captivity frequently require their teeth to be artificially shortened in order to avert the fatal effects of excessive overgrowth.

Monkeys, when in confinement, frequently die with symptoms of more or less complete paraplegia, which has recently been shown to be due to an overgrowth (frequently rickety) of the vertebræ near the intervertebra lamellæ. This gradual compression of the cord also occurs in tigers, lambs, bears, and others. These facts observed in animals throw light upon the agonising pain of mollities osium, which are doubtless in like manner due to compression of the cord and nerves, which is permitted by the softening of the bones which the disease causes.

Metschnikoff's definition that inflammation is a struggle between irritant bodies and white blood-corpuscles is adopted. Illustrations are given showing the white corpuscles surrounding and digesting micro-organisms and other foreign bodies, or dying in the attempt to do so. When the tails and gills of larval batrachians are being absorbed, numerous amoeboid cells can be seen containing fragments of nerve-fibres and muscle.

Our present knowledge of the nervous system quite fails to offer any explanation of the experiment which the author performed by transposing the median and ulnar nerves in

a cat. The two nerves were divided about the middle, and the distal end of the median was united to the proximal end of the ulnar, and *vice versa*. Union occurred: sensation and motion returned in six weeks. The cat regained complete use of the limb, and did not appear to suffer any inconvenience. It would be of great interest to repeat the experiment by attaching the proximal end of the median to the distal end of the ulnar, but to prevent the other ends from uniting. Would the result be an unimpaired function of the median nerve, transmitted from the portions of the brain and cord formerly associated with the function of the ulnar?

The classification of the cysts and neoplasms of the animal kingdom are illustrated by many typical examples. The teratomata are fully discussed, and it is shown that they almost invariably occur only in spots where the epi-, meso-, and hypo-blastic layers have been temporarily but directly in continuity with each other. Thus præseracral tumours are associated with the obsolete neurenteric canal; pituitary tumours with the canalis craniopharyngeus (a canal through the floor of the basi-sphenoid), lingual dermoid cysts with the ductus thyroglossus (a canal running from the basihyoid to the foramen cæcum of the tongue), and ovarian dermoid cysts with the obsolete Müllerian and Wolffian ducts. The predisposition of obsolete ducts to disease has for some time been recognised, but the close relationships of teratomata to such ducts is a more recent piece of work.

The novel illustrations of the leading pathological processes make the work one of extreme interest, and we heartily congratulate the author on the good use to which he has turned his exceptional opportunities.

PLANE GEOMETRY

The Elements of Plane Geometry. Part II. (corresponding to Euclid, Books III., IV., V., VI.). (London: Swan Sonnenschein, 1886.)

THIS book contains a revised edition of Books III., IV., V., of the "Syllabus of Plane Geometry" drawn up by the Association for the Improvement of Geometrical Teaching, with demonstrations of the propositions, and an excellent, though limited, collection of suitable exercises. If nothing else than these two parts had been the outcome of the movement first set on foot in our columns, the Association would have amply justified its formation. Much difference of opinion has prevailed as to the desirability or expediency of the Association producing such a work as this. The late Mr. Merrifield for some years strenuously opposed any such proceeding, but at the annual meeting of 1881 he expressed himself as "now satisfied from the experience which he had had in dealing with the examining bodies that they would not get their work really adopted by the public until they had a text-book. Everywhere he was met with the impossibility of wading through a dry Syllabus. Nobody who was not thoroughly versed in mathematics could judge whether there was any real possibility of teaching from the Syllabus at all." Circumstances appear to have compelled the Association at last to take the field with demonstrations put forward by a selected committee of its members; a principal reason being that the Association was bound to help teachers. The plan of teaching the Syllabus without

giving written proofs was found to succeed so long as the teaching was confined to the earlier parts of the subject, but when the later books were reached it was found necessary to give formal written proofs for subsequent reference (Report, 1881, p. 30).

Some teachers who wish for the more copious introduction of modern ideas and methods into the very elements may not consider the work of the Association as satisfactory as could be wished, and may think there is very little of the influence of the aforesaid modern ideas in the Syllabus, yet even such admit, and express satisfaction in making the admission, that "the use of the Syllabus has spread pretty widely, and it is to be hoped that it will continue to do so" (Prof. Henrici, British Association address, NATURE, vol. xxviii. p. 500). It is to be borne in mind that the Professor hardly gave the Syllabus a fair trial, though he says that when it appeared "I resolved to give it a thorough trial, and took the best means in my power to form an opinion on its merits by introducing it into one of my classes. The fact that it did not quite satisfy me, and that I gave up its use again, does not of course prove that it fails also for use in schools, for which it was originally intended."

These students had, we assume, to take down in writing the Professor's proofs, and it is not as agreeable work to "grind up" manuscript as it is to read a printed page; then there would be by-gone remains of the old text-book haunting the students' brains, want of familiarity with the Syllabus possibly on the teacher's part, and finally shortness of time over which the trial extended. At this point we may cite some remarks by the late Dr. Todhunter, which make as much for Syllabus upholders as for Euclidians. "It will be hard to secure that pupils shall be selected of equal power, and be trained with equal assiduity; and then if our teacher is to try various methods he is liable, since he knows that a controversy is now existing as to the result, to deviate from impartiality in his treatment of the rival methods. Moreover, there may naturally arise some disagreement as to the means to be used for testing the value of the results, and as to the accurate application of the principle which may be finally adopted for this end" ("Conflict of Studies," &c., p. 156). A fair trial would be to take two classes of students of as nearly as possible equal mental calibre, and with equal want of acquaintance with geometry, and to take each through the respective courses for the same time, and to take care that each teacher should be equally skilled and acquainted with his author and equally enthusiastic, for, as our essayist just cited writes, "if the teacher is only languid without being positively hostile, his real sentiments are soon discovered: hypocrisy has but a slender chance of deceiving school-boys" (p. 164). But such a fancy is Utopian; the hope of the Association at first lies in such far-away parts as the Cape and India, where its work is being taken up by enthusiastic and able teachers.

We have read the proofs, and believe them to be thoroughly accurate; there is also a careful avoidance of all looseness of language. Dr. Todhunter's "deliberate judgment" was that "our ordinary students would suffer very considerably if instead of the well-reasoned system of Euclid any of the more popular but less rigid manuals were allowed to be taken as a substitute" (p. 168). So

fearful was he of looseness or slipshoddiness that he more than once returns to this matter, and upon this very point of an Association text-book writes as follows:—"There are various considerations which seem to me to indicate that if a change be made it will not be in the direction of greater rigour" (p. 172). He owns himself once to have been in favour of *hypothetical* constructions, but that he had subsequently seen reason to alter his opinions: in many places in his essay he shows that he has not renounced *hypothetical* statements. His idea of an Associationist seems to have been that he is a being who tries to evade the difficulty of passing a pupil in geometry by asking for a less stringent text-book than that of Euclid.

It is vain to wish for the verdict of such able critics as De Morgan and Todhunter on the work before us, but we feel sure that the former would not have written concerning it "Non est geometria," nor the latter have found it wanting in Euclidian rigour.

As to this matter of a different order from Euclid's sequence we cite with cordial approval the following remarks of a writer in our columns (vol. xxxiv. p. 50):—"We believe that those who have most carefully considered the question of a rival order of sequence of geometrical propositions would agree that the best order in a logical arrangement does not seriously conflict with Euclid's order, except by simplifying it. Rather, by bringing the proofs of each proposition nearer to the fundamental axioms and definitions than Euclid does, it renders less assumption of previous propositions necessary for the proof of any given proposition. It stretches the chain of argument straight instead of carrying it round one or many unnecessary pegs."

The influence which the Syllabus has had upon modern editions of Euclid is patent to any reader of the works in question. And now, little book, that the Association has at the end of days sent forth on to (it may be) tempestuous seas, we wish thee *bon voyage!*

OUR BOOK SHELF

American Journal of Mathematics. Vol. viii. No. 4. (Baltimore, August 1886.)

The number opens with a memoir, by M. Poincaré, "Sur les Fonctions Abéliennes." The author gives here a *résumé*, with additional details, of a demonstration and generalisation of two of Weierstrass's theorems, which he had previously published in the *Proceedings* of the Mathematical Society of France (tome xii. p. 124). He then extends a theorem of Abel's from plane curves to surfaces, and refers, for fuller details, to a crowned memoir of M. Halphen's, "Sur les Courbes gauches algébriques." He next discusses some properties of "fonctions intermédiaires," using the term in the sense given by MM. Briot and Bouquet. This memoir occupies fifty-four pages. The second paper, on "A Generalised Theory of the Combination of Observations so as to obtain the best Result" (24 pp.), is by the editor, Prof. Newcomb. A very valuable article, with important practical applications. The final article (22 pp.), "On Symbolic Finite Solutions and Solutions of Definite Integrals of the Equation—

$$\frac{d^2y}{dx^2} = x^m y,$$

is by Mr. J. C. Fields. It discusses finite solu-

tions analogous to the symbolic solutions of Riccati's equation.

A Sequel to the First Six Books of the Elements of Euclid; containing an Easy Introduction to Modern Geometry (with numerous Examples). By John Casey LL.D., F.R.S. (Dublin: Hodges, 1886.)

THIS is the fourth edition of a book which has been received with warm approval by English and Continental geometers. The first eight sections present no notable changes from the corresponding sections in the last edition. In our previous notice (*NATURE*, vol. xxix. p. 571), we remarked that the author was "not so well up in the literature of the modern circles as he might be." This reproach is quite removed in the present edition. Indeed in this direction the author has himself now done excellent yeoman's service. The "supplementary chapter" of fifty-eight pages gives an admirable account of this modern branch in six sections. The first section states and illustrates the theory of isogonal and isotomic points, and of anti-parallel and symmedian lines. The second discusses "two figures directly similar" in homothetic figures. The third section is headed "Lemoine's and Tucker's circles." The fourth discusses the "general theory of a system of three similar figures." The fifth gives "special applications of the theory of figures directly similar," more particularly with reference to Brocard's circle and triangles. In the sixth section on the "theory of harmonic polygons," the author, starting from Mr. Tucker's extension of the Brocard properties to the harmonic quadrilateral, and Prof. Neuberg's continuation of the same, gives his own beautiful generalisations to the harmonic hexagon and other allied polygons. This latter extension has been made the subject of a communication by MM. Tarry and Neuberg to the French Association meeting at Nancy in August of the present year. The paper, which is not expected to be published until April 1887, contains a complete generalisation of points of Lemoine and Brocard, and the modern circles cited above for polygons and polyhedra.

The success of the "Sequel" is due to the fact that the author and the subject are exactly suited to each other: the union is a most harmonious one, and the result is a work indispensable to all lovers of geometry.

Geometrical Drawing for Army Candidates. By H. T. Lilley, M.A. Pp. x., 54. (London: Cassell and Co. 1886.)

IN a short introduction to this little work the author gives some useful advice to those beginning practical geometry, and rightly lays stress on the proper method of handling instruments, and on a good style of working.

The book contains altogether 300 problems in plane constructive geometry; they are nearly all straight forward and easy, but 180 of them are specially indicated as forming, according to the author's experience, a suitable first course for the majority of students.

The problems are conveniently grouped together, and hints are given in aid of the solution of typical ones, and of those presenting extra difficulty. Beginning with the construction of scales, we have the usual series of polygons, proportionals, equivalent areas, and, in conclusion, several cases of circles touching other circles or given lines.

As a book of examples this collection seems likely to prove useful in class-teaching. But in order to insure sound instruction, much that is not contained herein will have to be provided for the student. Thus in the note to the problems before us no reasons are given or indicated for the various steps in the constructions, and there is no distinction drawn between those methods of construction which are exact, and those which do not admit of proof.

LETTERS TO THE EDITOR

[The Editor does not hold himself responsible for opinions expressed by his correspondents. Neither can he undertake to return, or to correspond with the writers of, rejected manuscripts. No notice is taken of anonymous communications.]

[The Editor urgently requests correspondents to keep their letters as short as possible. The pressure on his space is so great that it is impossible otherwise to insure the appearance even of communications containing interesting and novel facts.]

The Enormous Loss from Ox-Warble

I HAVE read Mr. John Walker's remarks on "warbles." This is one of the many important subjects to which Miss Eleanor Ormerod has lately drawn attention. I can readily believe that there is a loss of two to three millions to the country through the ravages of this fly, but such statements, it must be remembered, should be qualified by the thought that it might cost two or three millions to protect all the cattle of this country against such attacks. The labour would be great, the vigilance would entail higher-classed stock-men, in almost all cases with higher wages, for you cannot get our labourers, dairy-men, and bailiffs even, to attend to such matters without great difficulty. The loss does not, I think, fall upon farmers, unless it is from the irritation to the cattle when they hear the buzz of the fly meditating her attack.

As to the damage to the hide, I never, in my experience, heard a butcher or dealer make warbles in the hide a pretext for offering one shilling less for a bullock. They take no notice of them at all; and, if the maggots injure the hide, this is a matter for fell-mongers and tanners, rather than for farmers. This is one of the cries emanating from the scientific friends of agriculture which it is well to listen to. It will probably gain the ear of only a select circle of agriculturists, because, to use a very homely phrase, "the game is scarcely worth the candle." Animals pass through the market too rapidly, and the prices asked and given are so approximate only to the absolute value, that a few warbles in the skin do not in the least influence the selling price. Still, anything which can be shown to influence the comfort of live stock or the value of their products must be considered as worth attention.

JOHN WRIGHTSON

College of Agriculture, Downton, Salisbury, October 31

"Lung Sick"

MR. H. RIDER HAGGARD, in his excellent novel, "King Solomon's Mines," has the following passage. He is speaking of Zulu oxen, and says:—

"As for 'lung sick,' which is a dreadful form of pneumonia very prevalent in this country, they had all been inoculated against it. This is done by cutting a slit in the tail of an ox, and binding in a piece of the diseased lung of an animal which has died of the sickness. The result is that the ox sickens, takes the disease in a mild form, which causes its tail to drop off, as a rule about a foot from the root, and becomes proof against future attacks."

Presumably this account is *bonâ fide*. It will be gratifying to me, then, if any of your correspondents will kindly explain how it is that the virus, which has not been weakened by cultivation, produces the disease in a mild rather than in a virulent form.

E. J. DUNGATE

6, Marchmont Road, Edinburgh, November 1

The Beetle in Motion

WITH reference to Prof. Lloyd Morgan's letter in last week's NATURE (p. 7), the following passage, which occurs in an interesting chapter on "Motions of Insects" in Kirby and Spence's "Entomology," may be quoted:—

"In walking and running, the hexapods, like the larvæ that have perfect legs, move the anterior and posterior leg of one side and the intermediate of the other alternately."

This passage is in complete accord with the observations of your correspondent.

C. J. G.

November 9

Meteors

YESTERDAY (November 2), about 8.8 p.m., I chanced to see here a meteor that, I think, deserves record, especially if my

report of its position in the sky can be compared with that of some one who observed it at another place.

Returning from Oxford, I was about half a mile east of Combe Church, on the lofty plat that is the remnant of Combe Common. "Stepping westward," I was startled by a sudden splendour, flooding with light the moonlit heaven. This splendour was above me and before me; it was a little on my left. A large meteor was rapidly descending, at an angle of 60° or 70°. Not much east of it shone the half-orbed moon; but little west of it stretched the eastern branch of the Milky Way's western termination. When it had traversed about three-fourths of the distance between its apparent starting-point and the undulating ground beneath, it swelled out for a moment grandly, and, before it burst, displayed a globe at least as big as the sun, and of about the same hue, though not of dazzling lustre. After it had vanished, its track was marked for a second or two by a brilliant trail, which, in the light of the neighbouring moon, sparkled with all the tints of the rainbow, and resembled a gorgeous shower of precious stones.

JOHN HOSKYNs-ABRAHALL

Combe Vicarage, near Woodstock, November 3

I HAVE read Mr. Murphy's letter (NATURE, November 4, p. 8). At the same time as Mr. Murphy saw a large meteor (October 31, 8.25 p.m.) I also saw an immense one coming from the same portion of the sky, and travelling west. It disappeared behind a cloud. There was a loud rushing noise.

E. PARRY

Dinorwic Quarries, Llanberis, North Wales

INFLUENCE OF WIND ON BAROMETRIC READINGS

I AM glad to see (NATURE, vol. xxxiv. p. 461) that the Scottish Meteorological Society recognises the importance of the effect of wind upon the barometer. I assume that the gradient, the density, and all other sources of error had been fully corrected for before concluding the existence of the large effect attributed to the wind on Ben Nevis.

There certainly is a purely local and dynamic effect of the wind on the barometer due to the exposure, and for which there must be found some method of correction or elimination before we can proceed much farther in barometry: this effect has been independently reasoned out by G. K. Gilbert ("A New Method, &c.," 1883), and has been discussed by Prof. H. A. Hazen (*Annual Report*, C.S.O., 1882, p. 897), and by Mr. Clayton and others in recent numbers of *Science*, but its existence was long since demonstrated by Sir Henry James (*Transactions Roy. Soc. Edinburgh*, vol. xx., 1853), whose memoir seems to have been quite lost sight of by meteorologists.

The suction of wind on tubes, cowls, and chimneys was investigated by Ewbank (*Journal of the Franklin Institute*, 1842), Wyman (*Proceedings of the American Academy*, Boston, 1848), Fletcher (*B.A.S. Reports*, 1867 and 1869), Magius (Copenhagen, 1875?), Holten (Copenhagen, *Oversigt Vidensk.-Selskabs*, 1877), and was used by Hagemann as the basis of his anemometer; it was Hagemann's memoir (Copenhagen, 1876, translation will appear in *Van Nostrand's Magazine*, Dec. 1886) that suggested a method of determining and correcting for the amount of this important effect, whose existence had long been known to me. This method is sketched out in the *Annual Report of the Chief Signal Officer, U.S.A.*, 1882, p. 99, where I state that a close determination simultaneously of both dynamic wind-pressure and static air-pressure is probably attainable by exposing above the roof, side by side, a Pitot tube facing toward the wind and a vertical tube over which the wind blows. Close the lower ends of these tubes and place within each an aneroid barometer, and the latter will record respectively the static pressure plus the effect of the wind-velocity and the static pressure minus the wind's effect. A stop-cock, cutting off at will communication between the aneroids

and the exposed mouths of the tubes, allows one to catch the influence of any gust and read the pressure at leisure.

The theoretical problem of the precise mechanical action of these tubes, especially that which Hagemann calls a Magius tube, *i.e.* one across which the wind blows at right angles, will, I hope, prove attractive to the mathematical physicists of England. Some interesting experimental work by Robinson will be found in *Van Nostrand's Magazine*, vol. xviii., 1878, p. 255, and xxxv., 1886, p. 89. A small closed room with only a chimney flue opened, such as usually obtains at the mountain stations of meteorologists, is virtually a Magius tube, and the barometer within must, under favourable conditions, show a depression depending on the so-called suction or draft up chimney. The direction of the wind combines with the structure of the building and the aspect of the various doors and windows to modify the influence of the force of the wind; the sluggishness due to the close cisterns, and the pumping due to the inertia of the liquid of ordinary mercurial barometers, further complicate the phenomena of suction during gusty winds, so that a simple general rule for correcting the observed barometric readings becomes impracticable, but the use of aneroids within closed Pitot or other tubes, with air-tight stop-cocks as above, simplifies the wind's action, and allows of its measurement at definite moments.

The distribution of pressure over the face of a large building fronting the wind, and in some part of which is the window of the room containing the barometer, is approximately known from Curtis's and Burton's measurements for a thin flat plate.

The location of each station with respect to mountains or other orographic features has also an influence on the pressure, which will still remain to be investigated; thus, on the leeward side there is a diminution, and on the windward side an increase of pressure, but this may be generally inappreciable.

It may also be mentioned in this connection that in delicate barometric measurements, such as those made by the International Bureau of Weights and Measures, it is important to prevent even the slightest currents from blowing across the open end of the siphon tube.

The suction effect of wind blowing over chimneys surmounted by cowls of different shapes was under investigation from 1878 to 1881 by a special committee of the Sanitary Institute, but, so far as I can learn, their experiments were never completed. Lord Rayleigh also read a short paper on the same subject at the meeting of the British Association in 1882, but as I do not know of its publication, I take this opportunity to express the hope that he will give meteorologists both a theoretical and experimental exposition of the action of the Pitot, the Magius, and the reversed Pitot tubes, and a suggestion as to the best method of determining, by means of stationary apparatus, the static pressure within a mass of moving air.

CLEVELAND ABDE

Washington, October 23

M. PASTEUR'S TREATMENT OF RABIES

AT the meeting of the Paris Academy of Sciences on November 2, M. Pasteur submitted a further communication on the results hitherto obtained from his method of treating hydrophobia by inoculation, which has now been in operation for a twelvemonth. The paper is divided into three parts, the first giving the statistical details brought down to the present date, the second describing certain modifications in his method as originally applied, the third giving the results of fresh experiments on animals. Up to October 31 as many as 2496 persons were inoculated at his Paris establishment, and at first the treatment was uniform for all alike, whatever their age, sex, or other varying conditions. Of the total number 1726 were from France and Algeria, 191

from Russia, 165 from Italy, 107 from Spain, 80 from England, 57 from Belgium, 52 from Austria, 22 from Roumania, 18 from the United States, 14 from Hellas, the rest from various other parts of Europe, besides from Brazil and 2 from British India. Of 1700 French patients, apart from 2 who arrived too late, 10 only succumbed, whereas of the small minority not treated at the laboratory as many as 17 died in the same period in the rest of France, while for the last five years the average yearly mortality from hydrophobia was 11 in the Paris hospitals alone. Last year it rose to 21, but in November 1885, when the new system was introduced 2 only died, and these had not been inoculated, besides third who had been imperfectly treated. Most of those who perished were children bitten in the face and subjected to the simple treatment, which experience now shows to be insufficient in such cases.

A first lesson on the necessity of stronger doses was taught by the 19 Russians bitten by a mad wolf, one whom died while under treatment, and two others shortly after. In consequence of these deaths the 16 survivors were subjected to a second and third treatment with the strongest and freshest virus from the spine of the rabbit of 4, 3, and 2 days' standing, whereas, for the milder treatment, virus from 14 to 5 days' old had also been used. To these repeated treatments should most probably be attributed the recovery of these Russians, who are reported to be all still in excellent health.

Encouraged by these results and by the fresh experiments described further on, M. Pasteur modified his treatment, making it at once more rapid and more active for all cases, and even still more energetic for bites on the face, or for deep and numerous lacerations of exposed parts of the body. In such cases the inoculations are now hastened, in order to arrive more promptly at the freshest virus. Thus, on the first day, virus of 12, 10, and 8 days will be used at 11, 4, and 9 o'clock; on the second day that of 6, 4, and 2 days, at the same hours; on the third, virus 1 day old. Then the treatment is repeated the fourth day with virus 8, 6, and 4 days old; the fifth with that of 3 and 2 days; the sixth with that of 1 day the seventh with virus of 4 days; the eighth with that of 3; the ninth that of 2; the tenth with that of 1 day.

If the bites are not healed, or the patients arrive soon what late, the same treatment may be renewed at intervals of two or a few days for four or five weeks, which are the critical periods for children bitten in the face. The system of vaccination has been in operation for the last two months, hitherto with excellent results, as shown by comparing the case of the six children who perished under the mild treatment, with that of ten others seriously bitten last August, and subjected to the more energetic treatment, and all of whom were doing well the first of this month. This new system requiring an increase of the staff, M. Pasteur and his assistant, Dr. Grancher, have been aided for some time past by Dr. Terrillon, Dr. Roux, Dr. Chantemesse, and Dr. Charr.

With regard to the fresh experiments on dogs, an objection to the inoculation of human beings after being bitten might be raised on the ground that the immunity of animals treated before being bitten had not been sufficiently demonstrated after their undoubted infection by the virus. In reply to this objection M. Pasteur points to the immunity of dogs after trepanning and intra-cranial inoculation with the virus of ordinary street rabies. Trepanning is the surest method of infection and its effects are constant. The first experiments on this point, dating from August 1885, had but partial success. They were resumed during the last few months with certain modifications which produced the best results. The vaccination is begun the day after inoculation, and proceeded with rapidly, the series of prophylactic virus being all administered within twenty-four hours and even in a shorter period, and then repeated

once or twice at intervals of two hours. The failure of Dr. Frisch, of Vienna, in experiments of this kind is due to the slow process of vaccination adopted by him. Success can be secured only by the rapid method here described. The immunity conferred under such conditions is the best proof of the excellence of this method.

REPORT ON THE CHARLESTON EARTHQUAKE¹

THE earthquake of August 31, which, from the locality in which its greatest power was displayed, will generally be known as the "Charleston Earthquake," was, perhaps, the most notable disturbance occurring within the limits of the United States of which we have any knowledge. It is entitled to this rank both on account of the wide area over which it was distinctly felt, and of the magnitude of the disaster which it caused in the immediate vicinity of the point of maximum intensity.

The earthquake consisted of a series of seismic disturbances which began in slight but distinctly noticeable tremors occurring on August 27 and 28, at the town of Summerville, about twenty-five miles north-west of Charleston, South Carolina.

The shock of greatest violence occurred a little before ten o'clock on the night of Tuesday, August 31. It was followed by several of lesser magnitude on that night, and during the succeeding three or four weeks. The great shock began in the city of Charleston within a few seconds of 9.51 p.m., 75th meridian time. The duration of the vibratory motion of the earth at that point was probably about forty seconds; the motion at first being moderate, but increasing with great rapidity during the last ten or fifteen seconds.

All of the loss of life and property during the whole series of disturbances is to be attributed to this first shock. Five minutes later another occurred, and ten minutes later still another; the latter being of considerable violence, but neither alone would have done any damage. The same may be affirmed of the succeeding series of disturbances, which, with greatly diminished intensity and at increasing intervals of time, continued to maintain the conditions of alarm and terror into which the people of the afflicted locality were naturally thrown by the first disturbance. Although some injury to buildings resulted from these after shocks, it is tolerably certain that in all such cases displacement and fracture had taken place in the great shock; the lesser disturbances simply finishing what had then been nearly completed.

The origin of the disturbances, appears to have been somewhere below a point fifteen or twenty miles north-west of Charleston; that is, in the neighbourhood of the town of Summerville. A chart of provisional co-seismal lines drawn by Mr. Hayden of the Geological Survey, and published in *Science* for September 10, seems to locate this centre somewhat further north than the point indicated above. At the time of its construction, however, information from many points was lacking, and that which was at hand was admittedly doubtful in some degree.

Reference is made later to the iso-seismal chart which accompanies this Report, and which indicates that the origin was near the point referred to above. Strong proof of this is also furnished in the intensity and character of the disturbance as shown by the effects which were still visible when an examination was made a few days after the principal shock. The appearance of the brick piers upon which many houses in Summerville rest was such as to justify the conclusion that the principal component of the motion at that point was vertical, and it was evident that the destruction of buildings was much less than would have resulted from a horizontal movement equal to that

which had taken place in Charleston and elsewhere in the neighbourhood.

Another fact of importance is that in the vicinity of Summerville the disturbances preceding that of August 31 took place, and here they have been most numerous and most persistent. Indeed, at the present writing, nearly a month after the first perceptible shock, they still occur at irregular intervals varying from a few hours to a few days. Only the most violent of these have been felt as far as Charleston.

Nearly all the movements in Summerville and vicinity have been accompanied by, and, indeed, generally preceded by, a low rumbling sound, lasting one or two seconds, and not unfrequently this sound, always unmistakable in its character, was neither accompanied nor followed by a perceptible movement. This was a common occurrence at Summerville and in the immediate vicinity, and it was found that among several observers there would be no agreement upon the direction from which the sound appeared to come.

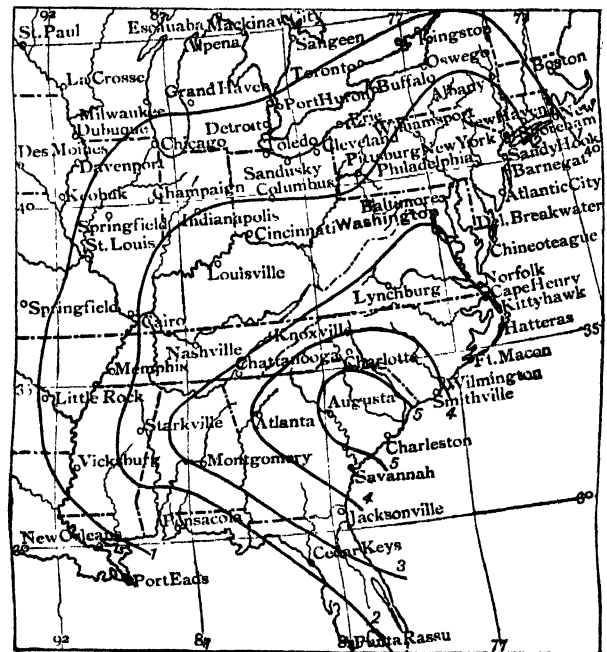

Chart of iso-seismal lines.

At a distance from ten to fifteen miles from Charleston in the direction of Summerville some of the most curious and interesting effects of the disturbance were to be seen. These were the "sand craters" and crevices, out of which extensive eruptions of sand and water had taken place on the night of August 31. The craters thus formed varied in size from an irregular oval, twenty-five feet long by fifteen feet wide, to shallow cones not over an inch in diameter and beautifully symmetrical in form. The area surrounding these openings was generally flooded with sand, often acres in extent, to a depth varying from a fraction of an inch to fifteen and eighteen inches. About the larger cavities the average depth was probably not less than six inches, and the area covered often an acre or more. The flow of sand was unquestionably only an incident to the outflowing of vast quantities of water, the greater part of which disappeared within a few hours after its appearance. The few crevices or "cracks" in the earth which were found were in character and origin similar to the "craters," being long and narrow openings, through which water with sand had been ejected.

It was difficult, in fact quite impossible, to obtain reli-

¹ By Prof. T. C. Mendenhall, Assistant. From the *Monthly Weather Review*, U.S. Signal Serv. Co., August 1886.

able information concerning the nature of this phenomenon at the moment of its occurrence. The locality in which it was principally exhibited is near a station on the South Carolina Railway, between Charleston and Summerville, known as "Ten-mile Hill." It is thinly populated, and almost entirely by negroes. Several persons who pretended to have been eye-witnesses of the outburst gave widely different testimony as to its character. According to one account, the water and sand from one of the "geysers" spouted to a height greater than that of a telegraph pole and continued to flow for four or five hours. Another, and apparently an equally credible witness, declared that the stream reached a height of six or eight feet, and that the flow continued four or five minutes. The latter statement is probably nearer the truth than the former.

A few instances of sand eruptions were found in the city of Charleston, and a few also at Summerville, and at the latter place water continued to flow from one of the openings for several days after the first shock.

It is important to observe that in no case was it found that the water thus issuing from the earth was hot or noticeably above the temperature of water in shallow wells in the neighbourhood. Reports of boiling water having been thrown up were very numerous, but no evidence that the water was really hot appeared. The use of the word "boiling" doubtless grew out of the appearance of the water as it issued from the openings, and was probably used by eye-witnesses to describe this appearance with no reference whatever to temperature.

There were also reports of the appearance of blue flames in the neighbourhood of these eruptions, but no reliable testimony to their existence could be obtained. There was also a report that was circulated extensively through the medium of the press of the country that two or three showers of hot stones had fallen upon and near the office of the *Charleston News and Courier*. An examination of some of these shortly after they had fallen forced the conviction that the public was being made the victim of a practical joke.

In the city of Charleston about forty lives were lost. The greater number of casualties resulted from injuries sustained by persons who were either in the street at the time of the shock or who rushed out and were caught by the falling debris. No adequate description of the injury to property can be given in this place, and, indeed, the results of this earthquake have been so thoroughly considered in the public press that note is unnecessary.

While there was probably not a single house in the city which was not in some degree affected by the shock of August 31, there was naturally great diversity as to the extent of the damage in different localities. Some parts of the city are built upon what is called "made land," resulting in many cases from the filling up of old creek bottoms and from other extensive levelling and grading. A more careful study of these peculiarities and their distribution may lead to the discovery of some relation between local differences in structure and the areas of greatest destruction.

Unquestionably much is to be attributed to the difference in the character of the buildings themselves, and to the relation of their lines of greatest or least strength to the direction of the wave front. As was to be expected, buildings constructed of wood suffered much less than those of brick. The interior of wooden buildings, however, would often exhibit a scene of total destruction, furniture, book-cases, &c., having evidently been moved with great violence. A very brief examination of injured buildings sufficed to establish, in a general way, the principal direction of the movement, which was probably in a north-west and south-east line.

The probability of the destruction of a building depends so largely on conditions other than the amplitude or direction of the vibration of the earth particle that the study

of destroyed or damaged structures can yield little exact information concerning these elements. The displacement of bodies of simple form and structure, lying near to or upon the surface of the earth itself, is a vastly more reliable index of the direction and intensity of the disturbance. In the churchyards of Charleston many instances of displacement and overturned monuments, columns, urns, &c., were found. These were examined with some care, and a careful study of the results may bring out some information concerning the dynamics of the earthquake. A cemetery containing many pyramidal or cylindrical shafts resting upon flat stone bases is tolerably certain, when disturbed by an earthquake, to exhibit not only displacement but also instances of twisting about a vertical axis; cases of this kind were numerous at Charleston. Such rotations by no means imply a similar gyratory motion of the earth, as it is well known that they may result, and doubtless always do, from vibratory motion in a single plane. It was not at all uncommon to find two columns, very near to each other, twisted in opposite directions.

A table was given containing a *résumé* of information received at the office of the Chief Signal Officer from regular observers of the Service and from a number of voluntary observers. The place, time, supposed direction, duration, and estimated intensity were given. Much discrepancy is observable in the records of time. Confusion is especially great in a few portions of the country in which so-called "local time" is still adhered to. When ever "standard time" is known to have been used reduction has been made to that of the 75th meridian. In a few cases, however, no reasonable supposition can explain the discrepancies. Such records must be erroneous.

A study of this column will show the great importance in making such observations, of determining the error of the clock or watch at the earliest possible moment by comparison with the time of some known meridian. It must be said, however, that the extended use of standard time has rendered these results vastly more accurate than they otherwise would have been. Telegraphic time signals are now within the reach of most people, and during the past two or three years a great improvement in the accuracy of time-keeping among the people has taken place.

The direction of the movement recorded against each station is that given by the observer. As it is based in many instances on the motions of swinging objects, or easily movable objects, it is of necessity often erroneous. In the absence of correct instrumental records, however, such observations are of value. The numbers expressing the intensity of the disturbance were applied at this office from descriptions furnished by observers, according to scale adopted by the Director of the Geological Survey.

This scale is as follows:—

No. 1. Very light. Noticed by a few persons; not generally felt.

No. 2. Light. Felt by the majority of persons; rattling windows and crockery.

No. 3. Moderate. Sufficient to set suspended objects, chandeliers, &c., swinging, or to overthrow light objects.

No. 4. Strong. Sufficient to crack the plaster of houses, or to throw down some bricks from chimneys.

No. 5. Severe. Overthrowing chimneys and injuring the walls of houses.

With these intensity numbers an attempt has been made to plot a chart of iso-seismal lines, or lines of equal intensity. The result is shown in the chart. Nothing short of the use of well-constructed seismographs can furnish satisfactory measures of the amplitude of vibrations of the earth particle or the maximum velocity of the same, but in the absence of records of such instrument this chart, or a more perfect one constructed upon the same plan, will afford opportunity for study.

In conclusion, it ought to be stated that this brief review of the Charleston earthquake must be regarded only as an attempt to place some of the leading facts upon record, for the benefit of the readers of the *Monthly Weather Review*. It is in no way intended to anticipate the investigations now in progress by the United States Geological Survey, a full report from which, based upon all attainable information, will be looked for with great interest.

THE SIMILARITIES IN THE PHYSICAL GEOGRAPHY OF THE GREAT OCEANS¹

AT the outset Mr. Buchanan reminded the audience of the similarities observed in the eastern and western continents, especially in their southern extremities. Such similarities in corresponding localities had been called homologous geographical features, in imitation of the homologies of comparative anatomy, and they had received much attention from students of geography. A remarkable group of similarities of this kind is to be found in the arrangement of inclosed seas lying to the northward of the three southern continents. To the northward of South America there are the Gulf of Mexico and the different basins of the Caribbean Sea; to the northward of Africa there are the Mediterranean with its different basins, and on the north-east the Red Sea; and to the northward of Australia there are the well-known seas of the Eastern Archipelago. These seas are bounded on all sides by islands and insular groups, and they are in continuous connection with two oceans, the Pacific and the Indian. The African seas are bounded entirely by continental land and communicate directly with two oceans; but in the limited sense that one sea, the Red Sea, communicates with the Indian Ocean by a single channel, and the Mediterranean Sea with the Atlantic, likewise by a single channel. Finally, the American seas are all in continuous communication with only one ocean, the Atlantic, the continental barrier towards the Pacific being continuous.

It is not unworthy of remark that the great depths (over 4000 fathoms) of the Atlantic and the Pacific Oceans occur immediately to the northward of these groups of seas, and in the western sinus of the northern portions of both oceans; while the greatest depression of the continental land, the region of the Dead Sea, is found similarly situated with regard to Africa. The analogy here, however, does not hold good all through, because it is a mere accident of climate that this area does not form a large and not excessively deep fresh-water lake.

The seas of the Malay Archipelago and those of the West Indies have important functions in the physical geography of the oceans, as they receive the warm dense water of the westerly-running equatorial currents of the Pacific and the Atlantic Oceans. The Pacific current finds no obstacle in the chains of islands which bound the Malayan seas, and is able to pass freely through into the Indian Ocean; while the Atlantic current is stopped by the continuous continental barrier of South America, and the head of water thus produced is relieved by the overflow of the Gulf Stream all the year round. Although there is no static barrier, in the shape of continuous land, to the westerly Pacific current, there is, during one season of the year, a kinetic one, furnished by the prevalence of the south-west winds during the monsoon season. These furnish the intermittent *kuro siwo*. The main cause of the westerly equatorial current is the propulsive action of the trade winds.

These winds have also great evaporating power; and, by making the surface water saltier, they furnish the mechanical means of propagating the surface heat into the deeper layers of the ocean. Hence the leading cha-

racteristic of the westward or leeward regions of the intertropical oceans is water of considerable density and of high average temperature in the sub-surface layers. This characteristic is seen most clearly in the Atlantic, where there is no communication with another ocean. In the Pacific the non-continuous boundary neutralises to some extent this effect, and gives to the eastern parts of the Indian Ocean a borrowed leeward character, independent of its own climate. A secondary consequence of a leeward position in the ocean, and due to the above-mentioned characteristics of the temperature and density of such water, is the prevalence of coral formations in the western regions of the Atlantic and Pacific, and, owing to the mixture of conditions, in both eastern and western regions of the Indian Ocean.

Continental homologies, or similar features in corresponding localities, are found on the western as well as on the eastern sides of the continents. One of the most striking is the resemblance of the Gulf of Guinea on the African coast with the great Central American bight stretching from Cape St. Lucas at the extremity of the Californian Peninsula, by Panama, to the mouth of the Guayaquil River, and with the unnamed bight in the Indian ocean bounded continentally by the north-west coast of Australia and insularly by the chain of islands stretching from the Peninsula of Malacca to Australia. Oceanically these bights are homologous. It is in them that the beginnings of the westerly-running equatorial currents are to be found, and perhaps more important still, it is in them that the easterly-running counter equatorial currents end. They are to be found in each of the three oceans, and generally on the northward side of the axis of the westerly-running current. In the Atlantic it is best known by its eastern portion, the Guinea current.

The observations here recorded of the Guinea current, a hitherto unexplored region of the ocean, were made on board the steamship *Buccaneer*, at the invitation of the owners, the India-rubber, Gutta-percha, and Telegraph Works Company, of Silvertown, and were carried out during a survey for a telegraph cable from Sierra Leone to St. Paul de Loanda. From a diagram showing the variation of salinity of the surface water of the Guinea current, with distance from the coast, it appeared that for a considerable distance along the Guinea coast the salinity of the surface water was an almost accurate test of the proximity of the land. The Guinea current starts in mid-ocean, but it is most constant near the African coast. The density of the water is low, its temperature high, and its velocity, especially in-shore, is sometimes as great as three miles an hour. It varies somewhat with the season.

Bottle experiments showed an average rate of fifteen miles per day in the months of January and February, for a thousand miles along the coast. In March, the *Buccaneer* experienced no easterly current, and in connection with this absence of easterly currents off the coast may be taken the very remarkable under-current which is found setting in a south-easterly direction with a velocity of over a mile per hour at three stations almost on the equator, and to the northward of the Island of Ascension. For the double purpose of examining the currents and of obtaining a large specimen of the bottom, the *Buccaneer* was anchored in 1800 fathoms of water by means of an ordinary light anchor fitted with a canvas bag to receive the mud which would otherwise fall off the flukes on its being weighed. While the ship was lying thus at anchor, the surface water was found to have a very slight westerly set. At a depth of 15 fathoms there was a difference, and at 30 fathoms the water was running so strongly to the south-east, that it was impossible to make observations of temperature, as the lines, heavily loaded, drifted straight out, and could not be sunk by any weight the strain of which they could bear. In the Pacific the counter equatorial current in the open ocean was well observed by the

¹ Abstract, by the Author, of a Paper read at the meeting of the Royal Geographical Society on Monday, November 8, by Mr. J. Y. Buchanan.

Challenger on her voyage from Hawaii to Tahiti. Her observations were illustrated by two diagrams, one showing the direction of the current, and the other the distribution of temperature and density in the upper layers of the water traversed. The easterly current was found between the parallels of 5° N. and 10° N., there being two streaks of maximum velocity, one between 7° and 8° N., and the other between 9° and 10°. In the former the mean daily set was 54 miles; in the latter it was probably quite as high, but it could not be accurately determined, as the ship passed from westerly to easterly current in the course of the 24 hours, and the observed current of 20 miles represented the difference of the two. The streaks or axes of strong easterly current are sharply defined by areas of abnormally low surface density. The whole of the area of easterly-running water has a comparatively low density, but where there is a sudden acceleration of its velocity, there is a correspondingly sudden drop in its density, so that the existence of a strong easterly current in equatorial regions may be guessed with great probability by the use of the hydrometer. The diagram showed also in a very marked way the protective action of the fresh surface water in preventing the penetration of heat into the lower layers of the water. A temperature of 60° Fahrenheit is found here at a depth of 50 fathoms from the surface, while in the westerly-running current, a little further south, the same temperature occurs at a depth of over 100 fathoms. In this region there are great inequalities in the density of layers of water at the same depth and within a short distance of each other. Thus, if the column of water between 20 fathoms and 70 fathoms from the surface be considered, its weight at the station where the westerly-running equatorial current prevails is only 88 per cent. of its weight under the counter equatorial current, the distance between them being not more than 200 miles. This disturbance of static equilibrium must be balanced by circulation of water between the localities, and hence the violent and conflicting currents observed in these regions. The study of the currents of equatorial regions would well repay the trouble of the investigation. The counter equatorial current is particularly interesting, and its dynamics obscure. Its range is very superficial, and its physical conditions can be studied without the elaborate and costly equipment required for the research of oceanic depths.

To the north and to the south of the equatorial bights of the western shores of Africa and America we have a remarkable similarity in the distribution of temperature in the coast waters. The transition from equatorial heat to extratropical cold is very marked: on the North American shore, at Cape St. Lucas, the southern extremity of the Californian peninsula; on the North African, at Cape Verd; on the South American shore, at Cape Blanco; and on the South African, at Cape Frio. In rounding Cape St. Lucas the temperature was observed to fall from 75° to 65° F. in less than an hour; and a similar difference of temperature was found in rounding Cape Blanco between Payta and the Guayaquil river. On the Morocco coast the water is found to have a temperature quite 10° lower than is found twenty miles to sea. These sharp transitions are found only close inshore, and they have usually been attributed to surface currents from higher latitudes. This explanation is at variance with the observations of navigators on the coasts, who do not notice any currents which would be strong enough to bring water many hundreds of miles under a burning sun without sensible rise in temperature. The occurrence of these coast areas of abnormally cold water is explained when we recognise that they are the windward shores of the oceans. The trade winds blow from them towards the equator, and in doing so mechanically remove water, which has to be supplied from the readiest source. This source is the deep water lying off the continental coasts, which is supplied by a gradual drift of cold

water from high latitudes. Hence, though the low temperature of the coast waters referred to is due to the cold of high latitudes, it is not supplied by a long coast Polar current, but by a short vertical one. This view was very strongly supported not only by the temperature of the water, but by its other characteristics, especially colour. The outside ocean water is of an intense ultramarine blue; the coast water off Mogador had the clear olive-green colour met with constantly in Antarctic seas. The same is observed on the west coast of North and South America, and it would be of the highest interest to have these waters investigated from a biological point of view. No waters in the ocean so teem with life as those on the west coast of South America. A bucket of water collected over the side is turbid with living organisms, the food of countless shoals of fish, who, in their turn, afford prey for innumerable schools of porpoises. One remarkable school which accompanied the ship for some time consisted entirely of females, each accompanied by a calf following in her wake and mimicking her every movement. Along with abundance of life this coast unites facilities for investigating it. At every port there are plenty of shore boats anxious for a fare, and with a tow-net and a few bottles a naturalist might make a rich collection of the shore-water fauna of the coast in one trip from Valparaiso to Panama.

The most remarkable confirmation of the view that the cold water on the windward shores is due to a submarine source has been quite recently supplied by the observations of Capt. Hoffmann, of the German man-of-war *Mowe*, on a voyage from Zanzibar to Aden. He kept close to the coast as far as possible, and observed a very uniform surface temperature of 78° to 80° F. from Zanzibar to Cape Warschek, when it began to fall, and remained at a temperature of from 60° to 65° F., until Cape Guardafui was reached, when the temperature went up rapidly to 86°. The minimum temperature observed was 59° F., and Capt. Hoffmann calls particular attention to the dark-green colour of the water, and in speaking of its low temperature he recognises that its source can only be the deep water in the neighbourhood, as the surface water on both sides has a temperature bordering on 80° F. The *Mowe* passed through these seas in the month of July, when the south-west monsoon is blowing most strongly, and at this season the Somali coast is a pronounced windward shore, and exhibits the same characteristics as the windward shores of Morocco or South America. The coral growths, too, which are so abundant north and south of it are here quite absent, thus accentuating the eastern or windward character of the shore.

NOTES

The following is the list of selected names to be submitted to the Fellows of the Royal Society at the forthcoming anniversary meeting (November 30) for election into the Council for the ensuing session:—President: Prof. George Gabriel Stokes, M.A., D.C.L., LL.D.; Treasurer: John Evans, D.C.L., LL.D.; Secretaries: Prof. Michael Foster, M.A., M.D., Lord Rayleigh, M.A., D.C.L.; Foreign Secretary: Prof. Alexander William Williamson, LL.D.; other Members of the Council: Prof. Robert B. Clifton, M.A., Prof. George Howard Darwin, M.A., LL.D., W. T. Thiselton Dyer, M.A., Prof. David Ferrier, M.A., Edward Frankland, D.C.L., Arthur Gamgee, M.D., Archibald Geikie, LL.D., Prof. Joseph Henry Gilbert, M.A., John Hopkinson, M.A., D.Sc.; J. Norman Lockyer, F.R.A.S., Sir Lyon Playfair, K.C.B., LL.D., Prof. Bartholomew Price, M.A., Prof. Pritchard, M.A., Admiral Sir George Henry Richards, K.C.B., Prof. Arthur Schuster, Ph.D., Philip Lutley Sclater, M.A., Ph.D.

In the third volume of Ray's "Historia Plantarum" there is a list of plants collected in the Island of Luzon by George Joseph

Camelli. This botanist was a member of the Society of Jesus, and was born at Brana, in Moravia, April 21, 1651; after a life spent for the most part in the Philippines, he died at Manila, May 2, 1706. Linnæus commemorated him in the genus *Camellia*, and the introduction of this well-known plant into Europe is generally attributed to him. The manuscript transmitted by Camelli to Ray was accompanied by a large number of drawings, part only of which Ray seems to have been able to afford the expense of publishing. We learn from the *Comptes rendus* of the Société Royale de Botanique de Belgique for October 9, 1886, that the whole of the drawings still exist in a folio volume in good preservation in the library of the Jesuits' College at Louvain. It contains 257 autograph plates, with 556 figures of plants, and three plates, with nine figures relating to zoology. It was purchased at the sale of the library of Antoine Laurent de Jussieu (February 6, 1858), in whose handwriting it is carefully annotated, and was presented to the Jesuit College by Count Alfred de Limminghe.

DR. WALTER L. BULLER, C.M.G., F.R.S., the well-known New Zealand ornithologist, has been promoted to the Knighthood of the Order of St. Michael and St. George.

THE honorary degree of D.Sc. has been conferred by the Senate of the Royal University of Ireland upon the Rev. S. J. Perry, F.R.S., and Prof. John Perry, F.R.S.

THE Committee appointed by the Prince of Wales to assist in framing a scheme for the proposed Imperial Institute is ludicrously inadequate and unrepresentative. The President of the Royal Academy appears, but why is the President of the Royal Society omitted? Surely science will have far more to do with such an institute than art. The only representative of science is Sir Lyon Playfair, and he has been appointed probably more on account of his connection with the 1851 Exhibition than with science. If the Committee is to gain the confidence of the public it must be of a very different character.

IN view of the progress achieved of late in the domain of celestial photography, the French Academy of Sciences has decided to propose that an International Conference be held in Paris next spring to make arrangements for the elaboration of a photographic map of the heavens to be simultaneously executed by ten or twelve observatories scattered over the whole surface of the globe.

ACCORDING to the Report of the Director of the Leander McCormick Observatory of the University of Virginia for the year ending June 1, 1886, the buildings and instruments are in excellent repair; the great 45-foot dome revolving fully as easily as when first erected. The Parkinson and Frodsham clock, formerly belonging to the Physical Laboratory, has become the property of the Observatory. It is now in Washington, in the hands of a jeweller, to be cleaned and recased. The great equatorial has been chiefly employed in the examination and sketching of southern nebulae. The nebula in Orion and the Trifid and Omega nebulae have received special attention. 351 observations of miscellaneous nebulae have been made, resulting in 226 drawings, and the discovery of 233 nebulae which are supposed not to have been hitherto detected. The features seen indicate that the performance of the instrument employed surpasses that of any of the great reflectors which have been used in the examination of nebulae, the examination of complicated structures seldom failing to show features not noticed elsewhere. Only a few nights have been suited to the micrometrical measurement of double stars. Seventy-six observations have, however, been made of stellar pairs, nearly all of which are close and difficult. According to the Director, Mr. Ormond Stone, the past year has been, without exception, the poorest for astronomical observa-

tions which he has ever known. Not only have there been an unusual number of cloudy nights, but even on clear nights the definition has been almost always extremely poor. The Observatory is open to the general public every day, except holidays and Sundays, between 2 and 5 p.m. It is also open to a limited number of visitors once each month at 8 p.m.

By the kindness of the under-mentioned gentlemen, lectures will be delivered as follows before Christmas at the Royal Victoria Hall and Coffee Tavern.—November 16, Mr. A. T. Arundel (Madras Civil Service), "Glimpses of India and its People"; November 23, Mr. Arthur Brown, "The Yellowstone Region"; November 30, Prof. A. W. Rucker, "Early History of the Earth and Moon"; December 7, Rev. W. H. Dallinger, "Plants that Prey on Animals and Animals that Fertilise Plants"; December 14, Prof. Boyd Dawkins, "Introduction of the Arts into Britain." With regard to the classes now held in the building, about eighty students have joined, many of whom are attending more than one class, and it is expected that fresh classes will shortly be started. A very satisfactory feature of the matter is that the students are genuine artisans, who would not otherwise have good teaching within their reach.

IN the form of a leaflet reprinted from *Humboldt* (Band v. Heft 10), M. Habenchicht, of Gotha, sends us a "Contribution to the Morphology of the Kosmos." Although his emendation of the nebular hypothesis can scarcely be called an improvement upon it, it is one among many symptoms of the breaking up of ideas on the subject, and their tendency to flow into new channels. M. Habenchicht remarks that, in the primitive nebula, "the laws of Nature slumber." For the convenience of the majority of speculators on origins, their awakening should be indefinitely postponed. His theory of planetary formation depends upon disparity of temperature, the inner side of the originating ring being warmed by the central body, while the outer side radiates freely into space. The result is unequal contraction occasioning rupture at the weakest place, whereupon a remarkable process ensues. Through the tightening of its outer surface, the ring coils up from the outside into two spirals containing very different quantities of matter, which eventually rush together from opposite directions, and coalesce into a planet. This dual origin is visible in the dissimilarity of the terrestrial hemispheres, as well as in certain aspects of Mars, and in some rare glimpses by Dawes of the disposition of light and shade on Jupiter's third satellite. The analogy is even carried out, we are told, in the organic world, from the tiny seed-leaves of the embryo-plant to the symmetrical yet not strictly balanced arrangement of limbs in the highest order of beings. But the planet-producing rings, to behave as M. Habenchicht supposes them to have behaved, should have possessed rather the qualities of caoutchouc than those of any known or imaginable "nebulous" stuff.

UNDER the title of "Sea-Level and Ocean-Currents," Prof. J. S. Newberry sends the following letter to *Science*:—"Put in Bay Island, October 16, 1886.—At 11 o'clock Thursday evening, the 14th inst., I witnessed here a remarkable fact, the effect of the late tremendous wind-storm. This commenced about 7 a.m., and began to let up at 11 o'clock in the evening, or a little later. I then went down to the shore in front of my house, and found the lake lower than the average by fully 6 feet! This is the greatest depression from such cause I have noticed during a residence here of nearly twenty-four years. We have not, within this period, had such a high wind steadily continued for so long a time. The captain of the steamer *Chief Justice Waite*, running between Toledo and the islands, reports the fall of water-level at Toledo as about 8 feet." In discussing the general question with reference to previous correspondence, Prof. Newberry says:—"The question is, not whether the

wind has the power of raising the water-level on a coast, but whether wind-friction can, in the great equatorial belt and in the track of the Gulf Stream, produce the flow of water which is there observed. The striking cases of the power of wind to heap water on coasts, and to move bodily great masses of it in lakes, are only interesting and relevant as demonstrating the sufficiency of wind-friction to produce broad and rapid surface-currents. This conceded, and the case is won, because, in the lakes and open ocean, like causes produce like effects. Wind of given velocity raises in both places waves of equal height in equal times: against these waves the wind presses in the direction of its flow, with no opposing force. As a consequence, the roughened water-surface, from greatly increased friction, is moved bodily forward just as though impelled by the paddles of a revolving-wheel. This surface-flow is in time communicated to underlying strata, and, if the wind continue to blow in the same direction, ultimately a large body of water will be set in motion; in other words, an ocean-current will be produced. There is no escape from this conclusion. The great truth remains that wind-friction can produce ocean-currents."

A SHOCK of earthquake of a more or less severe nature was felt at noon on November 5 at Washington, Richmond, Wilmington, Raleigh, Augusta, Charleston, Savannah, Macon, and other places in North and South Carolina. At some points the seismic disturbance was the severest since August 31. A shock of earthquake was also felt at Greenville, Alabama, on Friday last. The captain of a vessel which has since arrived at Charleston reports having experienced a seismic disturbance on that day while at sea.

PROF. JOHN MILNE, of Tokio, Japan, writes with reference to Prof. Ewing's article on seismographs in NATURE, vol. xxxiv. p. 343, that the instruments therein described represent the state of general knowledge of the Seismological Society of Japan with regard to seismometry at the time of Prof. Ewing's departure from that country. With the exception of one or two which have been modified, a set of instruments like those recommended by Prof. Ewing are, so far as Japan is concerned, quite obsolete. A very much better form of instrument is Prof. Milne states, now in use in the Government observatories and throughout the country.

In a paper by the Hon. Ralph Abercromby, reprinted from the *Quarterly Journal* of the Meteorological Society, on the origin and course of the squall which capsized H.M.S. *Eurydice* on March 24, 1878, the author concludes as follows:—"The squall which capsized H.M.S. *Eurydice* was one belonging to the class which is associated with the trough of V-shaped depressions. The line of this trough was curved like a scimitar, the convexity facing the front. The whole revolved round a point near the Scaw, in Denmark, like the spoke of a wheel. For this reason the portion of the squall over the east of England moved only at the rate of 13 miles an hour, while the western portion travelled nearly 50 miles in an hour. The portion which struck the *Eurydice* was advancing at the rate of 38 miles an hour. The length of the squall over England was more than 400 miles, but only 1 to 3 miles in breadth. Hence we have the picture of a scimitar-shaped line of squalls, 400 miles long and about 2 miles broad, sweeping across Great Britain at a rate varying from 13 to 50 miles an hour. The V-depression was one of an uncommon class, in which the rain occurs after the passage of the trough, and not in front of it, as is usually the case. The weather generally for the day in question was unusually complex, and of exceptional intensity, and for this reason some of the details of the changes cannot be explained."

AT a recent meeting of the Niederrheinische Gesellschaft für Natur- und Heilkunde at Bonn, Dr. Gurlt described a fossil meteorite found in a block of Tertiary coal, and now in the

Salzburg Museum. He said it belonged to the group of meteoric irons, and was taken from a block of coal about to be used in a manufactory in Lower Austria. It was examined by various specialists, who assigned different origins to it. Some believed it to be a meteorite; others, an artificial production; others, again, thought it was a meteorite modified by the hand of man. Dr. Gurlt, however, came to the conclusion, after a careful examination, that there is no ground for believing in the intervention of any human agency. In form, the mass is almost a cube, two opposite faces being rounded, and the four others being made smaller by these roundings. A deep incision runs all round the cube. The faces and the incision bear such characteristic traces of meteoric iron as to exclude the notion of the mass being the work of man. The iron is covered with a thin layer of oxide; it is 67 mm. high, 67 mm. broad, and 47 mm. at the thickest part. It weighs 785 grammes, and its specific gravity is 7.75; it is as hard as steel, and it contains, as is generally the case, besides carbon, a small quantity of nickel. A quantitative analysis has not yet been made. This meteorite resembles the celebrated meteoric masses of Saint Catherine in Brazil and Braunau in Bohemia, discovered in 1847, but it is much older, and belongs to the Tertiary epoch.

DR. DOBERCK, the Government Astronomer in Hong Kong, has published a pamphlet entitled "The Law of Storms in the Eastern Seas," containing the practical results of investigations of about forty typhoons, continued during three years. He divides typhoons into four classes, according to the paths which they usually follow:—(1) Those which cross the China Sea and travel either in a west-north-westerly direction from the neighbourhood of Luzon towards Tonquin, passing south of, or crossing the Island of Hainan; or, if pressure is high over Annam, they travel first westward and then south-westward. These, which occur at the beginning and end of the typhoon season, can generally be followed for five or six days. (2) The second class are most frequently encountered, and their paths can be traced farthest. They generally travel north-westward while in the neighbourhood of Luzon, and either strike the coast of China south of the Formosa Channel, in which case they abruptly lose the character of a tropical hurricane, re-curve in the interior of China, and re-enter the sea to the north of Shanghai, pass across or near Corea, and are finally lost to the east-north-east. Typhoons of this class may pass up the Formosan channel, and re-curve towards the coasts of Japan, or they may strike the coast of China north of Formosa. A third of the typhoons belong to this class; they can be followed between five and twelve days, and are most common in August and September. (3) This class is probably the most numerous of all, although not so frequently encountered. Their path is along the east of Formosa, travelling northwards and passing near Japan. (4) Typhoons of this class pass south of Luzon, travelling westward. Their dimensions are very limited, and hitherto they have not been followed for more than a day or two. When a few hundred typhoons have been investigated, no doubt complete lists of the sub-classes of these four main classes will be obtained, and exceptional cases will be better understood. The pamphlet, which is largely written for the guidance of ship-masters and others, concludes with the remark that typhoons are of simpler construction, and their paths are more regular, than the storms of Europe. Typhoons are so violent near their centre that the whole disturbance is evidently ruled thereby; whereas storms in the North Atlantic and in Europe appear to be made up of a number of local eddies, some of which are by degrees detached from the chief disturbance and form subsidiary depressions. Dr. Doberck has not been able to ascertain the existence of a subsidiary depression in the China Seas during the last three years, and it is, therefore, doubtful whether they ever occur.

THE additions to the Zoological Society's Gardens during the last week include two Rhesus Monkeys (*Macacus rhesus* ♀ ♀) from India, presented respectively by Col. J. M. McNeile and Mrs. E. White; a Rose-crested Cockatoo (*Cacatua moluccensis*) from Moluccas, presented by Miss Townshend Wilson; twelve Turtle Doves (*Turtur risorius*) from Africa, presented by Mr. E. L. Armbrecht, F.Z.S.; four Copper-head Snakes (*Cenchrus contortrix*), two Rattlesnakes (*Crotalus durissus*), a Hog-nosed Snake (*Heterodon platyrhinos*) from North America, presented by Mr. W. A. Conklin, C.M.Z.S.; a Long-nosed Snake (*Heterodon nasicus*) from Indiana, U.S.A., presented by Miss Catherine Hopley; a Fire-bellied Toad (*Bombinator igneus*) from Germany, presented by Mr. G. A. Boulenger, F.Z.S.; a Bactrian Camel (*Camelus bactrinus* ♂), bred in England, two Eleonora Falcons (*Falco eleonora*) from North Africa, a Macaque Monkey (*Macacus cynomolgus* ♂) from India, deposited; two Mantchurian Crossoptilons (*Crossoptilon mantchuricum* ♂ ♀), two Bar-tailed Pheasants *Phasianus reevesi* ♂ ♀) from Northern China, purchased; ten Barbary Turtle Doves (*Turtur risorius*), four Ring Doves (*Turtur communis*), bred in the Gardens.

OUR ASTRONOMICAL COLUMN

STELLAR PHOTOGRAPHY AT HARVARD COLLEGE.—Prof. Pickering has recently presented to the American Academy of Arts and Sciences an important memoir on the work in stellar photography which has been carried on at Harvard College, mainly by aid of an appropriation from the Bache Fund. The memoir commences with a brief sketch of the history of stellar photography, from its origination in 1850, when Mr. J. A. Hippie succeeded in obtaining a satisfactory daguerreotype of Vega with the Harvard 15-inch equatorial, the first stellar photograph ever secured. In 1857, the collodion process having then been introduced, Prof. G. P. Bond resumed the investigation, and showed that photography was capable of doing real work in the observation of double stars. In 1882 some preliminary experiments with a lens of 2½ inches aperture were made, and with such satisfactory results that in 1885 the work was resumed with a Voigtländer lens of 8 inches aperture, and about 45 inches focal length, that focal length having been selected that the photographs might correspond in scale to the maps of the "Durchmusterung." Of the three departments into which stellar photography may be divided, viz. star-charting, photographing star-trails, and spectrum photography, Prof. Pickering is chiefly interested himself in the two latter. Star-trails—the images, that is, produced on a plate when the telescope is stationary, or is not following the star with precision—are made exceedingly useful. It furnishes the best method of determining the magnitudes of stars photographically, and the average deviation of the measures of the brightness of circumpolar stars on different plates proved to be less than a tenth of a magnitude, a greater accordance than is given by any photometric method. It is Prof. Pickering's intention to obtain determinations of the brightness of all stars north of 30° S. decl. by this method, and he work is now nearly completed. One of the plates taken on November 9, 1885, incidentally affords conclusive evidence that Mr. de Nova Orionis was then much less bright than it was on the date of its discovery, some five weeks later. By photographing the same plate circumpolar stars near their upper and lower culminations, the means for determining the atmospheric absorption on the nights of observation have been secured. Prof. Pickering has also made some experiments on the applicability of photography to the transit instrument, and concludes that the position of a star may be determined from its trail with an average deviation of only 0.03s. Prof. Pickering also shows how star-trails may be made useful in determining the errors of pointing of the photographic instrument. Photographs of stellar spectra have been obtained by simply placing a large prism in front of the object-glass. The spectra of all the stars in an extended area are thus obtained at a single exposure; an exposure of five minutes giving the spectra of all stars down to the sixth magnitude in a region 10° square. The entire sky north of 23° S. decl. is to be examined in this way, and the work is now far on the way to completion. An exposure of an hour shows the spectra of stars down to the ninth magnitude. A photograph of the Pleiades in this manner brings out the in-

teresting fact that, with very few exceptions, all have spectra of the same class—a circumstance which seems strongly to confirm the idea of a community of origin. The exceptions may not improbably lie at a considerable distance on this side or the other of the group, and should, as Prof. Pickering suggests, receive attention in any study of the parallax of the Pleiades. Prof. Pickering also here discusses several theoretical points of interest, one being the relation between the dimensions of the lens employed and the light of the faintest star that can be photographed with it. He concludes, on the whole, that, where the telescope follows the star with exactness, the limiting amount of light may be assumed as proportional to the aperture divided by the square root of the focal length. Three photographic plates accompany the memoir: the first showing the photographic instrument, the second the trails of a number of close circumpolar stars, and the third several specimens of photographs of stellar spectra, those of Vega, Altair, and of the Pleiades being amongst the number.

ASTRONOMICAL PHENOMENA FOR THE WEEK 1886 NOVEMBER 14-20

(FOR the reckoning of time the civil day, commencing at Greenwich mean midnight, counting the hours on to 24, is here employed.)

At Greenwich on November 14

Sun rises, 7h. 18m.; souths, 11h. 44m. 35'5s.; sets, 16h. 11m.; decl. on meridian, 18° 18' S.; Sidereal Time at Sunset, 19h. 46m.
Moon (at Last Quarter November 18) rises, 17h. 54m.*; souths, 1h. 43m.; sets, 9h. 37m.; decl. on meridian, 18° 13' N.

Planet	Rises h. m.	Souths h. m.	Sets h.	Decl. on meridian
Mercury ...	9 37 ...	13 17 ...	16 57 ...	25 11 S.
Venus ...	6 49 ...	11 27 ...	16 5 ...	16 16 S.
Mars ...	10 39 ...	14 23 ...	18 7 ...	24 36 S.
Jupiter... ..	4 35 ...	9 57 ...	15 19 ...	8 15 S.
Saturn ..	20 2* ...	4 4 ...	12 6 ...	21 19 N.

* Indicates that the rising is that of the preceding evening.

Occultation of Star by the Moon (visible at Greenwich)

Nov.	Star	Mag.	Disap.	Reap.	Corresponding angles from vertex to right for inverted image
14 ...	115 Tauri...	6 ...	4 2 ...	5 11 ...	139 295
Nov. h.	16 ...	13 ...	Saturn in conjunction with and 3° 3' north of the Moon.		

Variable Stars

Star	R.A.	Decl.	h. m.
U Cephei ...	0 52.2 ...	81 16 N. ...	Nov. 18, 3 8 m
R Arietis ...	2 9.6 ...	24 31 N. ...	,, 18, m
Algol ...	3 0.8 ...	40 31 N. ...	,, 14, 0 45 m
ζ Geminorum ...	6 57.4 ...	20 44 N. ...	,, 18, 21 30 m
U Canis Minoris...	7 35.2 ...	8 39 N. ...	,, 18, M
R Virginis ...	12 32.7 ...	7 37 N. ...	,, 18, m
S Ursæ Majoris ...	12 39.0 ...	61 43 N. ...	,, 14, m
U Virginis ...	12 45.3 ...	6 10 N. ...	,, 18, M
R Scuti ...	18 41.4 ...	5 50 N. ...	,, 17, m
β Lyrae... ..	18 45.9 ...	33 14 N. ...	,, 16, 0 0 M
η Aquilæ ...	19 46.7 ...	0 43 N. ...	,, 16, 19 0 M
δ Cephei ...	22 24.9 ...	57 50 N. ...	,, 14, 0 0 m

M signifies maximum; m minimum.

Meteor Showers

November 14 is the date of the Leonid shower, R.A. 149°, Decl. 22° N.

THE EROSION OF THE ENGLISH COASTS

THE opening meeting of the present session of the Geologists' Association took place last Friday evening at University College, when an address was delivered by Mr. W. Topley, President of the Association and Secretary of the British Association Committee on Coast Erosion. The subject of the address was "The Erosion of the Coasts of England and Wales."

Mr. Topley, in his address, referred to the great service

rendered to the country by Mr. J. B. Redman, who had given much attention to the question of coast erosion, and to whom the British Association Committee was greatly indebted. The speaker then proceeded, by the aid of diagrams and drawings on the blackboard, to describe the mode in which the sea acts on coasts of various kinds, and stated the rate at which erosion is taking place in different parts of the country. It was greatest along the coast of Holderness and Norfolk, where the sea gained on the land at the average rate of from 2 to 3 yards per year. But locally and during exceptional gales the rate was much higher. On January 30, 1877, parts of Norfolk lost an average of 3 yards for several miles, and near Bacton the loss was 15 yards. Typical instances of erosion were cited, among the places mentioned being Folkestone, Brighton, Worthing, Bournemouth, Westward Ho! and Pembrokeshire. The speaker then went on to describe the shingle beaches and their changes, and to discuss the effects of natural and artificial groynes. On the south coast of England the shingle travelled from west to east, and if left to itself it would form a natural protection along the greater part of the coast, and the average amount of erosion would be small. But in certain places land-owners, town-councils, and other corporations desired that there should be no loss of land, and they erected groynes to collect the shingle, and so robbed the coast to the east of its natural protection. Worthing was heavily groyned and the shingle largely collected, but just east of the town the coast was rapidly receding. Folkestone pier was a large groyne which had collected an extensive area of shingle on its west side; Copt Point and Eastwear Bay, once protected by a continuous band of shingle, were now nearly bare, and the coast was rapidly going. At Copt Point land was laid out for building, and roads were made; but the notice-board advertising "this desirable freehold building land," was seen half-way down the cliff. Natural groynes were sometimes recklessly destroyed, and this was the case at Hengistbury Head, where ironstone was quarried from the cliff and foreshore; the reef had held back sufficient shingle to protect the land to the west, but when the reef was removed, the shingle travelled on, and the land rapidly receded. Great damage was done by taking shingle for road metal, ballast, or other purposes. The amount so taken appeared small and unimportant because a single storm might throw up as much as might be taken in many months, but the aggregate amount so removed was enormous, and must tell in time. It had been estimated that the shingle removed near Kilnsea in twenty years represented a bank 3 miles long, 31 yards wide, and 6 feet deep. It was interesting to note that the erosion of that part of the coast averaged only from three-quarters of a yard to a yard and a half per year for some time before the shingle trade was so largely developed; but later on, owing to the loss of the shingle, the rate of erosion rose from 3 to 6 yards per year. The change might not be entirely due to the cause mentioned, but it clearly was so to a large extent. Although the Board of Trade had now stopped the practice at that part of the coast, it was still in full action in a large number of places. The speaker then passed to the consideration of the land gained from the sea. A great part of the material worn from the coasts of Holderness and Norfolk was carried into the estuaries of the Humber and the Wash, and there formed banks of sand and silt of great hindrance to navigation, but when reclaimed of great agricultural value. Recent estimates showed that the area of land thus made in the Humber and Wash was far in excess of that lost. Taking the whole coast-line of England, it was probable that the total area of land was as great now as it was 500 years ago. Although the general result of a survey of this question was less serious than was generally supposed, it was evident that greater control was requisite over the action of land-owners and public bodies along the coast. The powers now vested in the Board of Trade might be more rigorously and systematically applied, or fresh powers obtained. This was especially desirable along the south coasts, as there the damage done by reckless groyning was enormous, but the area of land now gained was small.

OBSERVATIONS ON HEREDITY IN CATS WITH AN ABNORMAL NUMBER OF TOES

IN 1883 I contributed an article to NATURE (vol. xxix. p. 20) upon this subject, giving an account of my observations from 1879 up to the date at which the paper was written. The last observation was concerned with a family of four male tabby

kittens, all of which possessed the abnormality to a very marked extent. This was the first family produced by a female tabby (and slight tortoiseshell) cat which, when born, was the most abnormal form which had come under my notice, possessing two extra toes on all the paws, *i.e.* seven on each fore-paw and six on each hind-paw. The right paws of this cat were figured in



FIG. 1.—Right fore-paw from above, with extra toes.



FIG. 2.—Right fore-paw from below, with extra toes.



FIG. 3.—Right fore-paw from above, normal.



FIG. 4.—Right fore-paw from below, normal.



FIG. 5.—Right hind-paw from above, with extra toes.



FIG. 6.—Right hind-paw from below, with extra toes.

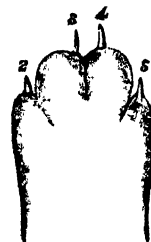

FIG. 7.—Right hind-paw from above, normal.



FIG. 8.—Right hind-paw from below, normal.

the paper referred to, together with the corresponding paws of a normal cat, for comparison. These figures are now reproduced in order to illustrate the present paper. I quote the description of the figures from the previous paper. "It is seen that the extra toes (in the fore-feet) are those labelled A and B (in Figs. 1 and 2), and they confer the extraordinary breadth upon the foot. The most recently added is B, which is still

rtially coalesced with A, and has but one pad in common with it (Fig. 2). . . . There is seen to be an extra pad behind the additional toes, of which there is no trace in the normal foot." In some families to be described, and also in two previously noted, the large extra toe, A, is present, while the insignificant pollex (Fig. 1, 1) is absent, and thus the paw appears extremely odd, although with only the normal number of toes. In the hind-paws (Figs. 5 and 6) "there is little doubt that the nearest toe I is the hallux lost in the normal foot. . . . The second extra toe is that labelled A. . . . On the under side (Fig. 6) all the toes have separate pads, and there is an additional pad behind the extra toes," which is sometimes fused with that behind the normal toes.

This cat produced her first family, described in the previous paper, on July 10, 1883. Continuing the observations from that date, the next family (of four tabby kittens) was born in June 1884. (1) and (2) were normal—a male and a female. (3)—a male—possessed six toes on the fore-paws, each toe with a separate front pad, and a bifid hind pad (distinct from that for the other toes) to the two inner toes (I and A in Figs. 1 and 2); the toe marked B—the last to be added in all cases. The hind-paws possessed six toes each, as in the mother, and with the same arrangement of pads as in her left hind-paw, *i.e.* with separate front pads to each toe (as in Fig. 6), but with the hind pads for the extra toes I and A continuous with those for the four normal toes (unlike Fig. 6 in this respect). (4), a female, possessed seven toes on the right fore-paw; the front pads separate except in the case of those for the toes A and B, g, 2, which were slightly fused. The hind pad for the three nearest toes was quite separate from that for the others. In this paw, in fact, almost exactly resembled that of the mother on the same side, shown in Figs. 1 and 2. The left fore-paw possessed six toes, the small one marked B in Figs. 1 and 2 being absent. The pads were in other respects similar to those of the right paw. Thus the relative amounts of abnormality on the two sides are as with the mother, the preponderance being on the right side in both cases. But the difference here greater in both directions, the right paw having rather more abnormality than in the mother, because of the less complete fusion between the front pads of the toes A and B, while on the left side the abnormality is much less than in the other, in the complete suppression of the toe B. The hind-paws were as in the last kitten, and similar to the left hind-paw of the mother.

The next family (of three) was born September 22, 1884. (1), a female tabby kitten, was normal. (2), a female tabby kitten, possessed seven toes on the right fore-paw, with separate front pads to each toe and the hind pad as in Fig. 2. The innermost claw was double, the two divisions being arranged vertically one above the other, the lower being small and incomplete. In this respect, and in the separate front pad to the toe B, this paw is far beyond the mother's paw of the same side in abnormality. The left fore-paw possessed six toes, that marked B being absent. Otherwise the arrangement of pads was similar to that shown in Fig. 2. Hence this paw is more normal than that of the mother on the same side, and both fore-paws compare with those of the mother in the same manner as those of No. 4 of the first family, the only difference being the even greater abnormality of the right paw in the present instance. The hind-paws possessed six toes with separate front pads and continuous hind pads, as in the left hind-paw of the mother. (3), also a female tabby kitten, possessed seven toes on both fore-paws. The arrangement of pads on both paws was similar to that on the left fore-paw of the mother, except that the toe B could not be said to possess a front pad at all. The hind-paws were as in the last kitten and the left hind-paw of the mother.

The next family (of three) was born in September 1885. (1), a female tabby and slight tortoiseshell kitten, possessed the normal number of five toes on the fore-paws, but the foot appeared almost as broad as in the abnormal kittens. This was caused by the large extra toe (A in Figs. 1 and 2) was present like the much smaller pollex I was absent. The front pad of the large abnormal toe was also slightly bifid, so that there was no indication of the next small toe B. The hind-paws possessed five toes with separate front pads and fused hind pads. (2), a female tortoiseshell and tabby kitten, possessed fore-paws as those of the kitten just described. The right hind-paw was similar, with five toes, but the left possessed six like the mother. The front pads were separate, as usual, on the hind-

paws. (3), a female tabby and slight tortoiseshell kitten, with fore-paws having seven toes like the mother, and also resembling her in the difference between right and left. The right paw possessed most abnormality, and was more advanced than the mother, as all the toes—even that marked B—possessed separate front pads. On the left side, however, the toe marked B possessed no separate pad. The hind-paws were like those of the mother, possessing six toes with separate front pads. This kitten was given to a friend, and will be again referred to.

The next and last family (of four kittens) up to the present time was born about July 1, 1886. (1), a female tabby kitten, was normal. (2), a female tabby kitten, possessed five toes on the fore-paws, but the feet were very broad, because the large abnormal toe (marked A, Figs. 1 and 2) was present instead of the small pollex. The hind-paws possessed six toes like those of the mother. (3), a male sandy kitten, possessed seven toes on the left fore-paw, the innermost (pollex) being *exceedingly* small and rudimentary, while the right paw possessed only six toes, the pollex being absent, although both abnormal toes (A and B, Figs. 1 and 2) were present. In this kitten the difference between the sides is therefore the reverse of that in the mother. The hind-paws possessed six toes like those of the mother. (4), a male tabby kitten,—by far the most abnormal form which has yet come under my personal notice. Both fore-paws have seven toes, each possessing a separate front pad, while the claw of the small toe B is well formed and large, and its pad is large and quite distinct and separate from that of A. The claw of the pollex I on both sides is partially divided (towards the apex) into a large upper, and rather smaller lower, division. This tendency towards a vertical proliferation has been already described in one of the kittens of the family born September 22, 1884. In the hind pads this was also the most abnormal form yet seen, for, interior to the normal fused hind pads for the four normal toes 2, 3, 4, and 5, were arranged three pads forming an almost continuous series with each other and with those belonging to the four normal toes. These three pads diminished in size from within outwards, and the one behind the toe B was very small, and was somewhat separated from the others, and especially associated with the internal side of the fused normal pads. The hind pads for the toes I and A were fused, but a distinct furrow indicated the line of separation. There was no practical difference between the fore-paws of the right and left side. The right hind-paw possessed seven toes, or three more than in the normal animal. This is the first time that I have come across so great an abnormality in the hind-paws, although Mr. Vaughan remembers it on both right and left sides in two individuals. All the seven toes are large and distinct, and have separate front pads. Interior to the normal fused hind pads, and continuous with them, is an ill-defined series of three pads, irregularly diminishing in size towards the interior, and crowded together so that the innermost is not behind the innermost toe. The foot is somewhat deformed. The left hind-paw possesses the usual six toes with separate front pads and fused hind pads.

I now return to (3) of the family mentioned before the last—the highly abnormal female tabby which was given to a friend in Oxford. This cat produced a family (of four) on July 10, 1886. (1) and (2), both sandy male kittens, were normal; (3) and (4), both tabby female kittens, were like the mother, possessing seven toes on the fore-paws and six toes on the hind-paws. These two kittens were given to Prof. Meldola and Mr. W. White, and I trust that they will be frequently referred to in some future number of NATURE. I am now able to give a somewhat longer account of these two kittens. In Prof. Meldola's kitten the left fore-paw is somewhat less abnormal than the right, because the toe B is very small, although it possesses a front pad separate from that of A. Of course the pollex I has a distinct front pad. There is a single, although somewhat divided, hind pad for the three inner toes, separate from the normal pad behind the four outer digits. On the right side the toe B is large, but the arrangement of front and hind pads is the same as that on the left side. The hind-paws have large and distinct front pads on all the six toes of both sides, and the hind pads of the abnormal toes form a continuous series with those behind the normal digits.

The fore-paws of Mr. White's kitten are precisely similar in every respect, the toe B being much larger on the right side, and the arrangement of pads being exactly the same. The hind-paws only differ in the fused hind pads for the abnormal toes being somewhat separated from those behind the normal

I. TORTOISESHELL ♀ normal (Bristol)				
II. TORTOISESHELL ♀ normal (Bristol, and ? Haverfordwest)				
III. TORTOISESHELL ♀ abnormal, but notes not taken (? Bristol, and Haverfordwest)				
IV. TORTOISESHELL ♀ "Punch," 6 toes on all paws (Haverfordwest)				
V. TABBY ♀ 6 toes on all feet (born 1873) and sent to Reading)	Very many families, among which two kittens with 7 toes on all paws have occurred. All varieties between the extreme and normal form have occurred constantly. In old age all kittens are described as normal			
VI. (1) 1880 (Reading) i. ♂ F P 5 but abnormal, H P 5 ii. and iii. ♀ normal iv. TABBY ♀ F P 5 but abnormal, H P 6 (Reading)		(2) 1881 (Reading) Tabbies { i. and ii. ♂ ♀ normal iii. ♀ 6 on all paws	(3) 1881 (Reading) Colour { i. and ii. ♀ 6 on all paws iii. sex unnoted, 6 on all paws	Many other families born in Reading, and always a large proportion of abnormality, but I was unable to obtain notes
VII. (1) 1881 (Reading) i. and ii. ♂ ♀ normal iii. ♀ F P 5 but abnormal, H P 6 iv. ♀ F P 5 but abnormal, H P 5		1882 (Reading, and sent to Oxford same year) TABBY ♀ F P 7, H P 6 (sent to Oxford) (Others in same family unnoted)		Many other families born in Reading, and always a large proportion of abnormality, but I was unable to obtain notes
VIII. (1) 1883 (Oxford) i. ii. and iii. all ♂ and all F P 7, H P 6 ii. ♂ R F P 7, L F P 6, H P 6 iii. ♀ R F P 7, L F P 6, H P 6 iv. ♂ R F P 7, L F P 6, H P 6		(2) 1884 (Oxford) i. and ii. ♂ ♀ normal iii. ♀ F P 6, H P 6 iv. ♀ R F P 7, L F P 6, H P 6	(3) 1884 (Oxford) i. ♀ normal ii. ♀ R F P 7, L F P 6, H P 6 iii. ♀ F P 7, H P 6	(4) 1885 (Oxford) Tabbies { i. ♀ F P 5 but abnormal, H P 5 ii. ♀ F P 5 but abnormal, R H P 5, L F P 6 iii. TABBY ♀ (with slight tortoiseshell), F P 7, H P 6
IX.			(1) 1886 (Oxford) Sandy i. and ii. ♂ normal Tabbies iii. and iv. ♀ F P 7, H P 6	(5) 1886 (Oxford) Tab- { i. ♀ normal ii. ♀ F P 5 but abnormal, H P 6 Sandy iii. ♂ L F P 7, R F P 6, H P 6 Tabby iv. ♂ F P 7, R H P 7, L H P 6

Capitals used for those female cats which have produced families of which some note has been taken

"I., II., &c. = generations

"1, 2, &c. = families

"i., ii., &c. = kittens in each family

Dates and localities indicate times and places of birth of the families to which they are affixed

"F P" = fore-paw { the numbers after = toes

"H P" = hind-paw { the letters R or L before = right or left side

"F P 5 but abnormal" indicates that the small pollex is absent, but the large abnormal toe A in Figs. 1 and 2 is in its place, making the paw abnormally broad, although with only the normal number of toes

digits on the left side, while the two sets are continuous on the right paw, as in Prof. Meldola's kitten.

All the observations recorded in this paper were made in Oxford. The abnormality has now been observed through nine generations, and I have recorded notes of ten families, so that now there is sufficient material to present in a tabular form.

The notes given in this paper are much more complete than before, because the families were born in my own house or in that of a friend living near, who kindly gave me every opportunity of making notes. The results, however, would have been far more extensive if I had received intelligence of the birth of families in various quarters to which kittens had been sent.

I believe there is little doubt that the next period of three years will produce much better results in this way, for at the recent meeting of the British Association at Birmingham I exhibited the cats, and was able to give away three abnormal females to scientific gentlemen (Prof. Haddon, Prof. Meldola, and Mr. W. White) who I am sure will assist me by sending complete accounts of all the families born. I remarked in my last paper on the immense strength of heredity which was shown in the observations then recorded, remembering that the results were in all cases due to the mothers of the families. The continued observations now published serve to illustrate the same facts. As I said before, "it is practically certain that the fathers of the families have always been normal." There has, indeed, been an abnormal male cat in Oxford for the last two years—one of my kittens which I gave to Prof. Moseley for a museum specimen, and which has been kept in order that it may be quite mature. But this cat lives at some distance from my house and that of the friend to whom I gave the female kitten in 1885, and it has never been seen in our neighbourhood, while numbers of normal cats have been seen in company with our abnormal females. But nevertheless a family containing abnormal kittens was born in a house near that in which Prof. Moseley's cat is being kept, and of which, of course, the latter must be the male parent. Unfortunately, as in so many other cases, I was unable to obtain any data, and the kittens are, I believe, all dead.

We therefore see in these observations a proof of the extraordinary ease with which a distinct breed can be produced from a spontaneously appearing variety. In spite of all the swamping effect of continual and uninterrupted crossing with the normal form, I have never been able to record a normal family, while in many cases some of the kittens were equal to, or even beyond, the abnormal parent in her peculiarity. This being the case, it is clear that a breed would have been quickly established if abnormal males had been selected to pair with the abnormal females. These observations have, therefore, an interesting bearing upon the existence of such a local breed as the tailless Manx cats, as Prof. E. Ray Lankester pointed out to me when talking over the subject. Prof. Lankester supposes that a tailless individual appeared spontaneously, and that it was considered interesting and a curiosity; and when the abnormality re-appeared in some of the off-spring, these were kept in preference to the normal forms. It seems quite certain that the result might have been produced in this way, and I have arranged with Dr. Grabham, of Madeira, that some of my abnormal kittens shall be sent to him to turn loose upon some neighbouring Atlantic rock on which rabbits are the only other living mammals. I should add that Prof. Lankester found a support for the theory of the origin of the Manx breed of cats in the fact that there are tailless breeds of other animals which are also fashionable in the locality, and which seem to point to the existence of the same peculiarities of taste working upon a spontaneous variety. In fact, as Prof. Lankester suggested, the people may have rather looked out for other tailless or abnormally short-tailed animals, when their interest had been excited by the existence of one such reed. But the observations here recorded have also a bearing upon those cases in which natural, instead of artificial, selection has been the agent. Granting, as I believe we must do, that some adaptive characters of great importance owe their beginning to flashes of structural or functional originality—appearing suddenly and spontaneously in one individual, and the extra digits appeared in the ancestor of my cats,—we see from these observations that in spite of all the effects of constant intercrossing with normal forms, there would be a most persistent offer of material upon which natural selection might work, for the variation would appear to a greater or less extent in a very large proportion of the individuals of the various families produced, while again and again the peculiarity would

be inherited in a form equal to or even beyond that of the parent. It is therefore of interest to actually test a few instances in as complete a manner as possible, taking care that only one parent possesses the abnormality, for this is what must have happened for the first few generations of any such variety which originally appeared in a single individual in a natural state. It is chiefly with the object of adding another to the instances already known and worked out that these observations have been undertaken, and will be continued and rendered as complete as possible. It need scarcely be pointed out that such instances differ essentially from all the cases in which breeds of domestic animals have been established, for in these well-known and numerous breeds heredity has had undisturbed possession of the field, without any conflict between the normal and abnormal forms, except indeed in the case of the first family produced by the original parent of certain breeds of which the peculiarity appeared spontaneously in a single individual, as in the breed of "otter" sheep.

EDWARD B. POULTON

LIGHTHOUSE ILLUMINANTS¹

THE details of the construction of the three towers and lanterns, and of the lenses and lamps in each lantern, of the magneto-electric machines, and of the gas-works, have no doubt been placed on record, and will be reported by the Trinity House engineers. But the following may serve as a general description of the arrangements.

Three low towers, constructed of massive timber, have been erected in a line inland from the higher of the two permanent lighthouses on the South Foreland, the nearest being 245 feet distant from the lighthouse, and the three being separated one from another by intervals of 180 feet. Their height, varying with the level of the ground, so that the lanterns may be on the same level, is from 20 to 30 feet; upon these structures rest three similar lanterns about 20 feet in height and 14 feet across. Within the lanterns are columns of lenses forming two opposite sides of a hexagonal framework which rises from the base to near the top of each lantern. The whole framework can be made to revolve so that either column of lenses may be made to face in any direction; each column consists of three or four similar lenses superposed, but the lenses forming different columns are different in their purpose and structure, and in their size. One column in each lantern consists of lenses designed to gather the divergent rays which fall upon them from the central source of light into a level sheet which spreads over the surface of sea or land, but not downwards or upwards; each of these lenses is a segment of a cylinder, and may be described as a cylindrical lens. The opposite column in the gas and oil lanterns consists of lenses designed to gather the divergent rays, not into a sheet, but into a single cluster or cone of small vertical angle, which is sent forth horizontally in any one direction. These lenses are made up of a central circular lens, surrounded by annular prisms and segments of such prisms, the whole fitting into a rectangular frame; they may be called annular lenses. The corresponding column of lenses used with the electric light consists of cylindrical lenses with condensing prisms placed in front of them; the cylindrical lens flattens a broad cone of light into a fan, the condensing prisms close the fan.

The size of the cylindrical lenses placed in front of the gas and oil lamps is the same, but the lenses in front of the superposed electric lights are smaller. The annular lenses, of which three form a column in the oil lantern, are each 6 feet 3 inches in height, while the four superposed annular lenses in the gas lantern are each 3 feet 9 inches in height. Both sets of annular lenses have the same width, namely, 3 feet 5 inches.

The electric lights are large arc lights, supplied with the electric current by three magneto-electric machines, which are worked by the steam-engine in the engine-house built for the ordinary work of the station. The electrical apparatus is of the construction of Baron de Méritens.

The gas-burners tried hitherto are of Mr. Wigham's construction, consisting each of a multitude of small fish-tail jets on brass stems about 6 inches long and an inch one from another, arranged on the same level in concentric rings. A tall funnel, a few inches above the cluster of burners, draws their flames together into the form of a bell. The number of concentric rings may be changed quickly so as to increase or reduce the size of

¹ Preliminary Report of Mr. Vernon Harcourt to the Board of Trade on the Experimental Lights exhibited at the South Foreland.

the burner from a diameter of about 4 inches with 23 jets, to a maximum of 11 inches diameter and 108 jets.

The oil lamps are of the usual Trinity House pattern with six concentric wicks, and are fed with paraffin oil.

Cannel gas is manufactured and stored at a short distance from the experimental towers, and supplied through a meter to the gas-burners.

For the observation of the lights, which were first shown in the week beginning March 30, three huts have been erected at different distances along a line perpendicular to the line of the towers, and this line has been marked by posts showing the distance from the central tower. The lighthouse-keepers who are stationed in one or other of these huts are instructed to make hourly observations during the time the lights are exhibited, expressing in figures their estimate of the relative brightness of the three lights. When the night is misty the keepers are instructed to patrol the line of posts, and to record the distance at which each light is lost or becomes visible. To avoid prejudice in favour of either an old or a new mode of lighting, the towers have been labelled, and are called A (electricity), B (gas), and C (oil). The huts are numbered. No. 1 is rather more than 700 yards distant from the central tower, No. 2, about 1½ mile, and No. 3, 2½ miles. Steps have also been taken to obtain estimates of the relative brightness of the three lights from observers at greater distances. To secure the identification in each hut of the lights observed when all three are not visible, three tubes have been fixed in each hut directed towards the lights A, B, and C, and labelled accordingly.

The huts serve also for measurements by various photometric methods of the light sent forth from each lantern. A number of such measurements have already been made, the results of which have been communicated to the Board of Trade by the Trinity House.

Near the engine-house on the South Foreland a long gallery has been built, in which the light emitted by the various lamps employed or proposed to be employed, can be measured so as to ascertain the value of these lamps independently of the lenses by which, within the lighthouse lanterns, their apparent brightness is variously augmented.

The experimental inquiry thus instituted will serve:—

(1) To ascertain the amount of light given by the six-wick and seven-wick oil-lamps, and of other oil-lamps, or modifications of them (if any) which may be proposed for lighthouse service.

(2) To ascertain similarly the amount of light given by Wigham's gas-burners on different scales (28, 48, 68, &c.) with different rates of consumption, and, if thought well, with different qualities of gas, and to test other gas-burners in like manner.

(3) To furnish further and trustworthy measurements of the light given by the electric arc with various carbons and with various tensions and quantities of electricity, and to test the efficiency of the De Méritens magneto-electric machines in converting mechanical into electrical energy, and whether they work without difficulty or risk of break-down or need of repair or loss of power; also to test the working of the De Méritens electric lamp, and of other electric lamps, if thought well.

(4) To furnish additional data for estimating the cost of maintaining any given light for a certain time, say 1000 candles for one hour, by each mode of producing light, and on the various scales suitable to different localities.

(5) To measure the efficiency of the lenses employed, especially with flames of different sizes in their foci.

(6) To prove experimentally (if such proof be desired) that 2 or 3 or n similar lights, when juxtaposed, give twice or thrice or n times as much light as a single light gives.

(7) To ascertain what light is sufficient to be visible from its horizon on a clear night, and in what ratio on the average of many nights the visibility of a light at great distances increases with its total intensity, or lens area, or proportion of red or of blue rays.

(8) To test the effect of the variations last named in haze, or mist, or fog, or rain, or snow, that is, when the air is made more or less opaque by particles of liquid or solid water of various sizes suspended in or falling through it. Such testing may be made either photometrically, which is only possible in slight haze and at small distances, or by observations of the distance at which each light is lost or reappears.

(9) To try the question of the utility of ex-focal light, whether,

that is, it often happens that the position of a lighthouse may be seen by the illumination of cloud or fog above or around it, when its position would be unknown if equal light from a smaller focus were directed almost wholly towards the mariner, and not allowed to spread.

(10) To test further whether in mist or haze sudden flashes of a powerful beam of light are noticeable when an equal light maintained constantly, or waxing and waning gradually, would not be noticed.

It is likely that other subjects of experimental inquiry may be suggested by those experienced in lighthouse illumination, or may occur as the experiments proceed. But, taking those above enumerated in order, I will attempt to indicate the conclusions which at present appear probable, and to make some suggestions as to points still to be investigated.

(1) It appears that the six-wick oil lamp behind the annular lens sheds light of as great intensity as the seven-wick lamp, while its consumption of oil is much smaller. Probably this result is due, in part, to the fact that the outer ring of flame which the seventh wick adds is further from the focus of the lens, while each ring of flame is partially opaque to the light from the rings inside it; and partly to the fact that the seven-wick lamp has not yet been brought to so perfect an adjustment of oil-supply to air-supply as the six-wick lamp.

I do not know whether any oil-lamp used in other than English lighthouses is such as to merit a trial against the Trinity House lamp.

(2) Some observations have been made with Mr. Wigham's burners with 88 and with 108 jets, which seem to show that with gas as with oil, behind the annular lens, no gain in intensity of light results from the circaposition of another ring of flame. Some evenings should, I think, be devoted to trying this question out. The value of ex-focal light behind an annular lens seems to be almost *nil* as regards intensity, and, if so, it may be well to use with revolving light a smaller flame than that of the six-wick lamp. Excellent experiments on this question can be made with Mr. Wigham's burner by exhibiting on a clear night through the annular lens one of these burners, whose size should be reduced, after an interval sufficient for photometry, from 108 jets to 88, and so on to the smallest size, measuring also after each change the consumption of gas. It will probably be found that a large fraction of the directed light is still obtained with a relatively small consumption of gas, and with the accompanying advantage of a low temperature within the lantern.

Similar measurements should be made with a cylindrical lens and with the naked flame in the photometric shed.

At present one other gas-burner besides Mr. Wigham's has been tried, a ten-ring gas-burner devised by Sir J. Douglass, which has given an excellent yield of light. Two others, by W. Sugg and Co., and by the F. Siemens Company, await a trial. The problem which the maker has to solve is to pack as much highly luminous flame as possible into a sphere of 3 or 4 inches diameter.

Where gas has to be manufactured expressly for a lighthouse, it would generally be best to make cannel gas, but near a town where common gas could easily be laid on, it would be cheaper to use common gas. It might, therefore, be worth while during the course of the experiments to charge the small gas-holder with common gas, and to note the consumption and the light developed. It would probably be found that with suitable burners the chief disadvantage in using common gas was the greater development of heat, the same light being obtained from the consumption of a larger volume of lower priced gas.

(3) Many measurements have been made in recent years of the light of the electric arc, but the difficulty of making measurements of so variable a light, and the uncertainty attaching to the standards of light employed, and the great differences between one arc light and another, according to the electric current and the carbons employed, make it clearly desirable to have further measurements of the electric light at the South Foreland.

Photometry should be accompanied, as with oil and gas, by a measurement of consumption. The mechanical energy absorbed can be measured at the strap which connects the magneto-electric machine with the steam-engine. The electrical energy developed can be measured in tension maintained, and quantity used, at the leads connecting the machine with lantern A. The cost of each horse-power per hour on the actual scale of working at the South Foreland must be already known. The rate at which the two forms of carbons which have been tried are consumed is also known.

It is essential to the value and significance of the photometry that simultaneous electrical measurements should be made.

The possible variations in the coupling of the magneto-electric machines, in the rate of running, and in the nature, form, and adjustment of the carbons, present a wide field of experimenting.

The continuance of the experimental working for many months will serve for a trial of the trustworthiness of the De Méritens' apparatus for lighthouse service.

(4) The cost of maintaining a lighthouse supplied with gas has been very variously estimated. It must vary from place to place, especially with the price of coal. The actual working expenses of oil lighthouses on the English coast, and gas lighthouses on the Irish coast, with allowance for the price of coal and labour, should furnish trustworthy data for a comparison. But to complete these data the quantity of light produced and utilised in each case needs also to be known, and as both the oil and gas burners tried hitherto at the South Foreland are of the service kind, the photometry now in progress will supply this knowledge. Some information may also be gathered from the expenditure on each illuminant at the outset and during the course of the experiment. It should be possible to state, if it were desired to maintain on the South Foreland a light of 50 or 100 or 200 thousand candles, what its annual cost would be with each illuminant.

(5) Although the action of lenses is mainly calculable, and, so far, does not require trial, it is modified by two quantities which vary slightly, namely, the reflection and absorption of light by glass, and is affected to some extent by errors of workmanship. It will, therefore, be of interest to obtain an exact comparison between the light emitted by a naked flame, and that from the same flame concentrated by different types of lighthouse lens. The prediction of the effect of a lens is less possible when the illuminant is of large size; and the failure of lenses, constructed for use as a revolving light with gas, to utilise (except by broadening the beam) the light produced at a distance of more than two or three inches from the focus of the lens, if they are found to fail so far, may be worth demonstrating.

With the electric light a very close correspondence should be found between the calculated effect of the cylindrical lens and of the condensing prisms and the results of photometry.

(6) The measurements which have been made of multiform gas and oil may be taken to show that any number of lights at a given distance cause so many times the illumination which one light causes; or assuming that the above must be the case, and is involved in the conception of comparative illumination, the proportional variation of the photometric results with the changes from uniform to biform, &c., on clear nights, gives evidence of the trustworthiness of the photometric methods.

(7 and 8) The two questions, which I have numbered thus, can hardly be treated separately, since clearness differs only in degree from slight haze, and slight haze from fog. Together they constitute the chief object of this inquiry.

The observations of the experimental lights which have been made from a distance, may be expected to yield, when they are collected and compared, much information as to the distances at which the several lights have been seen in various weather. But the changes which are necessary when photometric testings are to be made, or when an extensive programme is to be exhibited, must to some extent have interfered with the observation of the changes due to variations in the transparency of the atmosphere. It might be well for at least one month, to show the same lights nightly, and to inform the distant observers that this was about to be done, in order that their observations might have the more value. A single light of each kind shown through the cylindrical lenses would serve as well as multiform lights, and it would be best to use that size of gas-burner which had through the lens equal illuminating power with the six-wick oil lamp. Unless, indeed, it is assumed, as I should be inclined to assume, that equal lights from gas and oil have the same power of penetrating haze; in which case it would be more instructive to show from tower A a single electric light supplied from one machine, and from B and C either gas or oil also single, and either oil or gas of such size and number as to have at close quarters on a clear night an illuminating power equal to that of the electric light. A sufficient series of distant observations of these lights would show

(1) whether the electric light maintained its equality with the larger hydrocarbon flame through slight haze, or became more nearly equal to a flame of much less initial brightness; and (2) whether the taller beam of multiform oil or gas had much

advantage over the beam sent forth from a single lens. I believe it will be found that the relative brightness of two, or more, to one, will be maintained at any distance and through any haze which permits of photometry, but that, when the single light is lost at 5 miles or 500 yards, the triple light will be invisible at 6. The actual figures corresponding to these conjectural figures must be found, and the Trinity House Committee will then be able to judge in what cases such an extension of range is worth the increased expenditure.

In the case of the electric light, the observations which have already been made show that it loses in haze a larger proportion than the hydrocarbon flames. Further observations on this point will be of much interest and importance. The most valuable are observations of the distances at which an electric and a gas or oil light, whose relation in clear weather is known, cease to be visible. Such observations are strictly photometric observations, in which the lights observed are brought to an equality of minimum appreciable brightness, and the distances at which their brightness is equal are measured. These are dependent upon the weather, and may be practicable on only a few days in each month. Still more rarely will the opportunity offer of measuring the lights in but No. 1 through a slight uniform mist; but such measurements ought to be made. I would suggest the possibility of testing in the photometric shed through an artificial mist produced by blowing steam from the boiler in the adjoining engine-house into the middle of the shed.

It is said that Faraday proposed at first the use of a very small lens with the electric light. Unless conclusive experiments have been made on this point, it may be well to place the experimental electric light in the focus of a larger and of a smaller annular lens, each subtending the same angle, and to note whether the effect differs.

It might also be worth trying whether biform gas, with a small enough number of jets to have the same illuminating power as single oil, would be better seen through slight haze. The trial would not be between gas and oil, but between placing a strong light behind one lens, and placing half the light behind each of two superposed lenses.

(9) Owing to the nearness of the three lanterns, the illumination or halo which spreads round each of them in a fog seems almost to blend. That which surrounds the gas lantern is not much greater than that around its neighbours on either side. I do not think that, on the one occasion on which I have seen the lights in a fog, the ex-focal light was of much service.

If a lighthouse lantern was surrounded by a mist or cloud extending far enough laterally to extinguish its principal beam, but so little above it as to allow the scattered light to fall upon a higher stratum of cloud, the position of the lighthouse might only be seen from the illumination of the cloud above it. But this state of things would happen rarely in most places, and a better plan of turning it to account than the addition to a burner of rings of ex-focal flame would be to employ the upper prisms to send a second beam skyward. Whether the general illumination about the experimental lanterns has been visible when the three centres of light were not visible to an observer towards whom the beams were directed, may perhaps be gathered from the record of observations.

(10) When engaged on a clear night in judging of the experimental lights, the eye of the observer is continually caught by the sudden flashes of the Calais light. The revolving light at Grisnez is equally visible, but does not catch the eye in the same manner. It might be well to try on some rather hazy night, whether, if one lantern alone were lighted, and during successive quarters of an hour the light were alternately kept steady and flashed in some such groups of flashes as the Calais light, the observers patrolling the line of posts became aware of the light at a greater distance when it was flashed than when it was steady or revolving. Even a slight mist is a great leveller of distinctions, but it seems possible that the use of flashing may increase the range of a light as much as an addition to its intensity or size.

Some of the questions raised in the latter part of this report might perhaps have been omitted, as having already received an answer, if, while thinking the matter over, I had been able to consult some of the experienced members of the Trinity House Committee who are charged with the conduct of this inquiry. I have ventured here in writing, as at other times by word of mouth, to make the suggestions which have occurred to me, knowing that they will receive friendly attention if they are

submitted to the Committee, and hoping that some of them may be of service.

(Signed)

July 26, 1884

A. VERNON HARCOURT

Since¹ the foregoing preliminary report was presented to the Board of Trade, the experimental inquiry has come to an end, and a complete account of the apparatus, observations, and testings has been published by the Committee of the Trinity House who had charge of the inquiry, followed by a statement of the conclusions at which the Committee have arrived.

I propose to arrange the remarks I have to offer under the following heads:—

- I.—Apparatus for the exhibition of the experimental lights.
- II.—Arrangements for observation.
- III.—Photometry.
- IV.—Comparison of lights.
- V.—Range of lights in hazy weather.
- VI.—Cost of each system.

I.—Apparatus for the Exhibition of Experimental Lights

In my preliminary report I have given a general description of the temporary towers, the lenses and lamps. In Parts I. and II. of the Trinity House Report are to be found plans and measurements giving the full details of these constructions. The towers are admirably suited to their purpose, and their situation and the distance between them proved most convenient for observation.

In regard to the arrangements for exhibiting the electric light, it is to be observed that, although the electric light completely outshone its competitors, it was heavily handicapped in the competition. The "leads" were not of sufficient calibre to carry the large electrical currents used, for a distance of nearly 300 yards, without considerable loss. Prof. Adams estimates the loss at more than one-fourth the electrical energy supplied.

The five vertical prisms used in the case of the electric arc to bring together the horizontal rays, subtended an angle of only 30°, while the annular lenses which served the same purpose in the gas and oil lanterns subtended an angle of 60°. Thus the fraction of the light emitted from the central source of light, which composed the revolving beam, was only half as great in the case of the electric arc, as in the case of the gas and oil flames. It seems probable also that a beam of less divergence may be used with advantage to obtain a maximum range in hazy weather; and such a beam may be obtained from the electric arc with lenses of moderate size. On a few occasions when an annular lens similar to those used in the other two lanterns was placed in front of the electric arc, the light was dazzling at a distance of more than a mile, and surprisingly vivid at a distance of 20 miles. I see that on a clear night when the 108-jet gas burner behind an annular lens gave a light of 60,000 candles, the electric arc behind its cylindrical lens and vertical prisms gave a light of 1,200,000 candles, and behind an annular lens a light of 12,000,000 candles. In the one case the arc was five times as powerful as Mr. Wigham's "quadriform," in the other fifty times as powerful.

For the sake of uniformity and comparison under similar conditions, only the central belt of the Fresnel apparatus was placed round the electric lamp as round the gas and oil burners. The suppression of the top and bottom prisms, though entailing a loss of 30 per cent. of the light produced, is a necessary sacrifice where large burners developing great heat are placed immediately one over the other. But each of the electric lamps in tower A might have been surrounded with a complete Fresnel apparatus, adding nearly one-third to their light, without any difficulty or any necessity for separating them more widely.

Thus, if the principle which has been enunciated had been followed, of doing for each illuminant the best that could be done within the limits of the lighthouse lantern, if a trifling electric light had been exhibited, with leads of low resistance, with a lens subtending an angle of 60°, and with top and bottom prisms, the power of this light might have been more than tripled. By also reducing the divergence of the beam, which I think might be done with advantage, a further increase of power could have been gained. This fact should be borne in mind in comparing the results which were obtained with the three illuminants.

¹ Further Report of Mr. Vernon Harcourt to the Board of Trade on the Experimental Lights exhibited at the South Foreland.

In M. Allard's interesting and important "Mémoire sur les Phares électriques," 1880, he gives the results of a trial of three Gramme dynamo-machines and an electro-magnetic machine of the Alliance Company. The former gave for the same horse-power 40 or 45 per cent. more light than the latter. But M. Allard measured only horse-power and light, not the electrical energy developed; and it does not appear whether the larger yield of light was due to a more powerful electrical current, or to the position of the carbons, and the form of the incandescent ends, being more favourable to the emission of light with the continuous current. Probably the De Méritens machines, which produced a light of about 1000 candles per horse-power, are superior to those of the Alliance Company, which yielded only 540 candles, and are equal to the Gramme machines which yielded 800 candles per horse-power. Of all that relates to the economical production of powerful arc lights, knowledge is advancing rapidly. The ample provision of steam power, and the excellent photometric gallery at the South Foreland, will no doubt be used from time to time for the trial of new types of electrical machines, of regulators, and of carbons. For the past experiment, and apart from the question of cost, the De Méritens machines worked admirably, converting, according to the measurements of Prof. Adams, mechanical into electrical energy with a loss of only 16 per cent. The current supplied was more than sufficient for the largest carbons; indeed, carbons exceeding 1½ inches in diameter were heated to redness through their entire length.

In regard to the apparatus for exhibiting the gas system of Mr. Wigham and the oil lamps of the Trinity House, little can be added to the full and clear account of the Trinity House Committee. But as it has been stated, since the publication of the Trinity House Report, that Mr. Wigham's foreman was not left unfettered to make the best display which the apparatus in his charge would allow, I may here put on record what I saw and believe in the matter. I paid many visits to the gas lighthouse by day and by night, and was in frequent communication with the foreman, Mr. Higginbotham, from the beginning to the close of the experiments. The arrangement of each night's programme rested with the Committee of the Trinity House, who so ordered matters that abundant opportunity was given for the observation and measurement of all the varieties of each illuminant. Among these were Mr. Wigham's combinations of 28 jets, 48 jets, 68 jets, 88 jets, and 108 jets, the ready conversion of one of which into another is among the merits of his ingeniously constructed burner. When the effect of the smaller number of jets was to be observed, it is clear that the full power of the burner could not also be shown. Therefore, there were necessarily times when Mr. Wigham's foreman was not free to make the best display which the apparatus in his charge would allow. With this exception only, I believe that Mr. Wigham's foreman was perfectly free to do his best and make any improvements Mr. Wigham or he could devise. I see from the summary in the Trinity House Report that the full power of Mr. Wigham's burners was shown on 127 nights; and it appears from the photometric record that it was measured 57 times. This ought to suffice for an accurate judgment of its merits.

Comparing the gas and oil towers as they appeared to a visitor when in full operation, the gas had one striking advantage, and one equally obvious disadvantage. The advantage was that it needed no care. When the lenses had not to be revolved by hand, nor the number of jets changed, one attendant in the tower was sufficient, and he had little or nothing to do. In the oil tower, on the other hand, I have seen a keeper on every one of the three stages, each man watching and from time to time adjusting his lamp. The disadvantage encountered in the gas tower was the excessive heat from the large gas-burners, which by causing unequal expansion of the glass lenses and their metal framing, and of the outer and inner surfaces of the lenses themselves, caused cracks to appear, which in the continuous belt of thick glass gradually spread from side to side. But though the burning of gas yields for the same light more heat than the burning of oil, there is no reason to think that with a diminished consumption of gas, e.g. the 160 cubic feet an hour of the 68 jets instead of the 300 of the 108 jets, such a disaster would recur. When the gas flame is surrounded by a chimney, as in Sir James Douglass's and Mr. Sugg's multiple Argands, the heating of the lenses is greatly diminished.

When the lights were first exhibited, the behaviour of the oil lamps in C tower was a matter of much interest. Using gas, Mr. Wigham had succeeded in quadrupling the power of a large

urner behind a lens more than a yard square, by placing over it three other similar burners and lenses. But it seemed a hazardous experiment to imitate this plan by placing three lamps side by side with mineral oil one over the other. However, the skilful arrangements of Sir James Douglass were completely successful. The three superposed oil lamps burnt as safely and well as if each had had the lantern to itself.

II.—Arrangements for Observation

A short account of these arrangements has been given in my previous report, and a complete account is to be found in the report of the Trinity House Committee.

The plans for making observations on shore at small distances had been well laid. The home at St. Margaret's, stationed between the two observing huts, with telephone to all points; the measured distances; the huts themselves, welcome refuges on a cold night, and most convenient for photometry with their helpful occupants; all bore witness to the wise forethought which had been bestowed upon the details of the inquiry.

For obtaining records of the relative brightness of the different lights from the impressions of those who saw them, probably no better plan could have been devised than that of distributing forms to be filled in with a numerical estimate of the ratio which two of the lights bore to the third. And the enlisting a multitude of observers, by the wide distribution of these forms, secured the two advantages, of an average drawn from a very large number of observations, and of an obviously impartial judgment. The observations made at sea from the Trinity House yacht *Argus*, which was in constant attendance, were of great importance; and I may add that, for the landsmen whose main business was photometry at small distances on shore, taking part in these observations was an essential help towards the full appreciation of the problem before them.

III.—Photometry

The chief assistance which I found myself able to render to the Committee was in devising and improving photometric apparatus and methods. A full description of these is given in the Committee's Report, especially in Mr. Dixon's "Record," part ii., pp. 30–36. During my visits to the South Foreland, I was principally occupied with photometry, in the dark gallery by day, and in one of the huts by night. Frequently Mr. Longford or Mr. Dixon worked with me, and the observations which I made are included in the general record. I believe that the standard of light employed was constant and of a definite and reproducible value, and that the methods of comparison were trustworthy and accurate. The excellent idea of Sir James Douglass, of using a large lens to concentrate the rays from the lighthouses upon the photometric disk, made possible the measurement in the more distant hut of lights whose intensity was too feeble to be accurately estimated without such aid. Mr. Dixon's polariscope photometer and the ingenious obscuration photometer of Captain Nisbet, are instruments well adapted for the direct comparison of distant lights or lights enfeebled by haze; the former can only be used for lights which are near together. Two movable photometer-bars, designed by Sir James Douglass, and suitable for use with any form of disk and any standard, were in constant employment throughout the trial. These were placed in the photometric gallery and in hut II. The observations in hut I. were reduced by means of a portable bar devised and made by Mr. Dixon.

A glance at the 16 columns of the closely-printed photometric record,—each number being, as a rule, the average of many observations,—will give to those who know the effort of attention which accurate photometry requires a conception of the diligence with which this branch of the inquiry was pursued. I have spent many hours in one or other of the huts with Mr. Dixon or Mr. Longford, and I wish to express my conviction that the results which they obtained and which are printed in the Trinity House Report, are as complete and trustworthy as zealous, patient, and skilful work could make them.

IV.—Comparison of Lights

Although an observer's opinion on the relative brightness of two or more lights, like an opinion on the force of the wind, is better expressed by means of numbers than by descriptive terms, such numbers must not be regarded as expressing the relative intensity of the lights so compared. Perhaps on any future occasion it would be better to call the brightest light 10 rather than 100, since the use of the larger number suggests that an

inferiority just sufficient to be noted with confidence is to be expressed by a difference of 2 or 3 per cent., whereas it probably amounts to at least 10 per cent., and 9/10 or 8/10 would be nearer the ratio of the two lights than 98/100 or 95/100. No doubt by practice in comparing lights whose relative intensity is known, a fair power of judging may be acquired; but without such training the natural tendency is to under-estimate differences. For example, the average of 294 estimates by eye of the relative power of "triform oil" and "quadriform gas," assigns to the gas a superiority of 6 per cent., whereas the actual superiority as shown by measurement is 23 per cent. According to the same series of estimates the electric light has a superiority over "quadriform gas" of 59 per cent., the actual superiority being more than 400 per cent.

Equally remarkable evidence of the tendency to overlook differences of intensity when the estimate is made directly by eye, is found on comparing the values assigned to "multiform" lights. The figures relating to the 108-jet gas-burners, and representing the relative value of the single, biform, triform, and quadriform lights, each by comparison with the electric light, are 56, 61, 59, and 63. If these numbers represented the intensity of the light falling upon the eye from the whole surface of the illuminated lenses, they should stand in the ratio of 1, 2, 3, and 4. The explanation at once suggests itself that while the photometer measures the total light received from a large illuminated surface, the eye judges of the brightness of the surface or the light received from equal areas. To an observer looking down a street on a clear night, the more distant gas-lights seem as bright as those which are nearer, though smaller in size; if asked to estimate the lights he would probably assign the same figure to all. And the visual angle subtended by the flame of a street-lamp at 100 yards is about the same as that subtended by 18 feet of lenses at a distance of 4 miles. The singular fact that as estimated by eye, on a separate comparison with the electric light, "multiform" have no superiority to single lights, may to a small extent admit of the explanation which applies to the familiar case which has been given. In this case the observer distinguishes between size and brightness, and sets himself to judge of the latter only; or it may be that the intensity of the sensation of light depends upon the brightness and not the size of the spot of light formed upon the retina. But the South Foreland observations were not made chiefly at distances of only 2 or 3 miles; nor were the observers likely to disregard the apparent magnitude of a light in estimating its value. At distances of from 12 to 14 miles, at which the largest lights have no appreciable magnitude, the average values assigned to the biform, triform, and quadriform lights are 75, 66, and 60.

I fear the true explanation is that the results have suffered from the electric light having been adopted as the term of comparison. To a small extent its fluctuations and difference of colour, and to a much greater extent its incomparable power, have made the estimates entirely uncertain; and thus it is vain to institute cross comparisons between the different lights which were not seen together, but only estimated by reference to the electric light as a standard. This conclusion, however, does not affect the value of the comparisons, chiefly aimed at, between the gas and oil lights, which were seen together, nor the significance of the direct comparison of the flame lights with the electric light at all distances and in all weathers. Indeed, the adoption of the electric light as the standard with which all others were to be compared, has served to establish on the basis of thousands of observations the important fact that, as far as the eye can judge, the electric light appears to excel the light of gas or oil lamps almost as much at greater as at smaller distances, and in hazy weather as in clear. The mean ratio of the electric light to all the gas and oil lights exhibited, taken from the whole number of recorded observations, is, at distances of from 1 to 8 miles 1000/626, at distances of from 8 to 15 miles 1000/613. In clear weather the mean ratio is 1000/591; in weather not clear it is 1000/608.

The photometric record presents many points of interest.

In the measurement of naked flames the long gallery, which has wisely been made a permanent structure at the South Foreland, afforded unexampled facilities. The electric arc was measured at a distance sufficiently great for its intensity to be similar to that of the other lights which were measured. The values assigned to it, from 10,000 to 15,000 candles, are not so high as some which have been obtained; but this is perhaps due to the fact that extreme values were rejected, and care was taken to obtain an average result.

In one respect the observations are incomplete, and need to be supplemented at some future time. Within the lighthouse the source of light is surrounded by an apparatus which gathers together the light sent forth in all directions, excepting a small angle above and below. Thus, the intensity of the light sent in a sloping direction upwards and downwards is of as great importance as that of the light sent forth in the horizontal plane. But only the latter has hitherto been measured in the photometric gallery. According to M. Allard the electric arc produced by an alternate current sends out horizontally an amount of light which is 11 per cent. greater than the average amount sent in all directions. With a continuous current the strongest light is thrown on the side opposite to the positive carbon; but it happens that with an arc light of this description horizontal measurement gives the average value. Probably Mr. Wigham's wide cluster of gas jets sends forth less light horizontally, owing to the imperfect transparency of one flame to the light of another, than it sends in an upward direction; and the same may be the case with the concentric gas-burners and oil lamps. Mirrors might hereafter be arranged within the photometric gallery, which would serve for making these measurements.

To determine accurately at a distance the power of the various lights exhibited was an essential preliminary to calculating the range of any of the lights in hazy weather. And although this power is approximately calculable, the power and dimensions of each flame, and the structure of each lens being known, it was of great interest to make actual measurements of the intensity of the light at two different points, and in different states of the atmosphere. I am not aware that such measurements had ever before been attempted. Owing to the novelty of the photometric problem, and to some extent of the methods employed, it was highly important to have some means of testing how far the results were trustworthy. Such means were furnished by the multiform system of Mr. Wigham. At any distance, and in any state of the atmosphere, the illumination produced by a combination of two or more similar lamps and lenses is so many times as great as the illumination produced by a single lamp and lens of the same kind. Thus, among the lights to be measured were several whose relative power was known beforehand. If testings of single and multiform lights, made in succession while the degree of clearness of the air was unchanged, gave values varying approximately as the number of lights, an equal degree of exactness may be ascribed to the testings of other lights and lenses.

On July 12, the weather being "clear, calm, overcast," the light from the single, biform, triform, and quadriform 108-jet burners, showing through Mew Island lenses, was measured at hut I. The results in thousands of candles were 50, 98, 168, and 214. Three testings intervened between the second and third, and probably the air had become a little clearer, but the numbers are not far from the ratio 1, 2, 3, 4. Three days later the same single, triform, and quadriform combinations were tested one after the other, also at hut I. The values found are 48, 145, and 186. Similar testings were made on July 23, on a clearer night, of all four combinations; their power was found to be 58, 112, 171, and 220 thousands of candles. Probable values in the ratio of 1, 2, 3, 4, are 56, 112, 168, and 224. On the same night the value found for a single six-wick oil lamp behind an Eddystone lens was 56,000 candles, and for three such lamps behind three such lenses 168,000 candles. On November 1, in thick haze, the value found at the nearer hut for "I. Gas, 108, M.," was 25,500 candles, and for "IV. Gas, 108, M.," 102,000. The results obtained at hut II., with a wholly different photometer, are confirmed in the same manner. For example, on February 7, consecutive testings on a misty night of "single" and "quadriform gas" gave in thousands of candles the numbers 26 and 101. On March 20, on a very clear night, the values found for the same two lights were 63 and 252.

In looking over the tables of the photometric record, and comparing the figures standing against combinations of equal numbers of oil lamps behind Eddystone lenses, and of the larger gas-burners behind Mew Island lenses, in all weathers in which the lights were measurable, the eye is struck by the similarity of the numbers. The rival systems are nearly equal; there is little to choose between them. Still less difference, as has been pointed out, was discernible on looking, as we did night after night, at the lights themselves. Other considerations than that of visibility in either clear or hazy weather, must decide which,

if either, of the two systems is to be generally adopted for lighting our coasts. By multiplying burners and lenses, and by enlarging the size of the lenses, more powerful lights still may be produced, if it is thought desirable, with either illuminant.

But the most prominent fact on the face of the photometric record is the immense superiority of the electric light. The conclusion forces itself upon the reader of these tables that if greater power is needed, it is to be found, not by magnifying lenses or multiplying combinations of gas or oil burners, but by substituting the light of the electric arc.

The Trinity House Committee report that the electric light in clear weather is certainly not popular with sailors, chiefly on account of its dazzling effect at short ranges. But at ranges exceeding two or three miles, "hyper-radiant," or even multiform lenses, are not visibly larger than such a lens as is suitable to the electric arc; and at such ranges the "dazzling effect" is simply that due to the power of the light. If a double quadriform were as powerful it would dazzle as much. Also the use of a powerful electric arc in clear weather may be avoided. It would not be difficult to arrange for the use of a small electric arc during clear weather, and the quick substitution of a powerful arc light when the weather became hazy. I would venture to suggest that the singular circumstance which led or contributed to the removal of the electric light at Dungeness, that a vessel went ashore near the lighthouse, may have been due, not to the dazzling effect of the light, but rather to the diminution of brightness as the approaching vessel passed within and beneath the range of the light. With the condensed and sharply-defined beam of the electric light, it may perhaps be desirable to devote some part of the optical apparatus to spreading a portion of the light over the space intervening between the coast and the point, a mile or two away, at which the principal beam first strikes the sea. If this is done, the light at short ranges might be made sufficient, but not too dazzling; and for longer ranges there seems to be no reason why the powerful beam produced by the electric arc behind one of the Mew Island lenses should not be employed. This beam had a divergence of about 1°. Even from the high level of the South Foreland lights, if the axis of such a beam were so inclined that only about $\frac{1}{4}$ of the light passed over the horizon, the full light would extend to within about three miles of the shore. Since the apparent brightness of every light must vary with the state of the atmosphere, as well as with the distance of the light, and as the angle subtended, even by a multiform light, at a few miles distance is very small, it cannot be possible by the appearance of a light without other data to judge of its distance. The electric light is not singular in this respect.

(To be continued.)

THE LUMBAR CURVE IN MAN AND APES

WE are indebted to Prof. Cunningham, of Trinity College, Dublin, for a well-illustrated and exhaustive memoir on the subject of the lumbar curve in man and apes. This memoir has been printed by the Royal Irish Academy as one of the Cunningham Memoirs, and is illustrated by thirteen plates, several of which are large folding ones, and two of which are large coloured drawings of the two surfaces of a mesial section of a male chimpanzee; these are life-size, and are the first accurate representations of the topographical anatomy of this anthropomorphic ape we have seen.

The structural differences between man and the anthropoid apes are no doubt in a great measure due to the assumption by man of an erect attitude, and to his having from an early period of his life dispensed with the use of his anterior extremities as organs of locomotion. The vertebral column of man might be expected to exhibit in a marked degree differences distinguishing it from other animals, and that more or less deep convexity forwards in the region of the loins has been considered by some not only as a marked character of the human spine but even as peculiar to humanity; other anatomists have denied that this is so, and consider that man and certain of the man-like apes have it in common. In this memoir Prof. Cunningham seems to minimise the importance of the lumbar curve as a distinctive character of any special group. Not only the higher, but also the majority of the lower apes, possess this curve; and, under

certain conditions, even some quadrupeds show clear traces of it. In the course of his investigations, Prof. Cunningham has brought many new and interesting facts and phenomena to light. Thus in man and the chimpanzee the quality of this lumbar curve is identical; the only differences are its extent and its development. And then among the members of the human race this curve does not appear to be equally prominent; upon some—as the Australian, the Negro, and the Andaman Islander—the curve is by no means so well marked as it is in the European. Not that the absolute degree of curvature is less in these races, but whereas in the European the bodies of the vertebræ are more or less moulded in adaptation to the curve, in the lower races there is to be found no trace of this. With this subject the first part of this memoir is taken up, and the adaptation of the vertebral bodies with reference to the lumbar curve is considered in a first section. The method of making the measurements, and the results derived from them, are given, and special points in connection with the European and several of the lower races (Australian, Tasmanian, Andaman, Negro, and Bushman) are given. Then follow details of the indices of the lumbar vertebræ in the four man-like apes, as well as in nine of the lower apes. The statement that this curve is more marked in the female than in the male is strongly supported by the evidence adduced in this memoir, and it would seem that the vertebral bodies of the female are moulded more in adaptation to the curve than those of the male.

The second section of this part of the memoir treats of the entire lumbar curve as found in man and the apes. The difficulties in the way of securing accurate curvatures of the living spine seem to be insuperable. Parow, who worked hard on this subject, has signally failed; hence the standard of comparison must be sought for in the dead, and the details of how this has been done are given at some length. Racial differences are next discussed, and the development of the spinal curve is treated at great length, with some excellent illustrations. The condition of the lumbar column in the anthropoid apes is next considered. It was, as we have seen, thought that the lumbar curvature did not exist save in man. Goodsir is positive about it. Sir W. Turner at one time was equally so. Sir Richard Owen denies its presence in the gorilla and orang-utan. Huxley was among the first to assert its existence. Broca and Topinard followed. As to the facts to be seen by frozen sections, Cunningham has not succeeded in getting fresh material for the gorilla; but in the case of the chimpanzee the curve differs but little from that in man. In the orang it is feeble, resembling that in man in some respects, and in others differing from that in the chimpanzee. In a gibbon (*Hyllobates agilis*) it stands intermediate between the chimpanzee and orang. In some of the monkeys it is also to be found, and even in some quadrupeds.

In a second part of his memoir, Prof. Cunningham, taking advantage of the same anatomical method which enabled him to make such interesting discoveries as to the extent of the curves of the vertebral column, viz. by sections through recently frozen bodies, has been able to advance our knowledge of the topographical anatomy of the orang, chimpanzee, and gibbon, very considerably. Certain relations of distinct morphological importance cannot by any other method be with accuracy ascertained. The question of how far the cerebrum in the anthropoid apes projects backwards in relation to the upper surface of the cerebellum, was at one time a burning question, and, although fairly set at rest, cannot be said to have been unmistakably demonstrated until now; when the whole of the parts were frozen in their places, sections were made, and we have the results in this memoir amply corroborating previous inductions. Sections of the brain *in situ* in the adult male and newly-born child, in the male and female chimpanzee, female orang, and gibbon, are all figured. Other points in the anatomy of the brain, as the condition of the corpus callosum, and of the hippocampus minor are also alluded to, and a few further details as to other visceral anatomy are given.

The memoir forms a quarto volume of some 150 pages, the typography of which is extremely creditable. The woodcut illustrations and plates are excellent, and the publication of this treatise as a Cunningham Memoir marks the appreciation of its value by the Council of the Royal Irish Academy, as the series of its publication—known as the Cunningham Memoirs, because the expenses thereof are defrayed out of the funds left by a Mr. Cunningham—is reserved only for works which the Council believe contribute some new facts to science.

SCIENTIFIC SERIALS

Bulletin de l'Académie Royale de Belgique, August.—Note on the eruptive rocks of the islands of Marion, Prince Edward, Macdonald, and Heard, by A. F. Renard. These insular groups, which stand on the great submarine plateau in the southern regions of the Indian Ocean, are shown to be entirely volcanic, in no way connected either with the Madagascar group or with the lands of the South Polar seas. Marion and Prince Edward, which were visited and partly explored by Mr. Buchanan, of the *Challenger* Expedition, consist of old plutonic formations, such as feldspar basalts and much more recent black and other lavas. Heard, discovered in 1853 by the American captain Heard and also visited by the *Challenger*, is largely covered with a black volcanic sand formed of grains of magnetite and augite. Elsewhere occur more recent lava formations, which show no trace of the erosive action exercised by the sands on the older rocks. All the specimens collected here belong mainly to the group of feldspar basalts.—On the presence in Belgium of *Bothriocephalus latus*, Bremser, by Edouard van Beneden. A few recent instances are recorded of the presence in Belgium of this human parasite, which is common enough in Holland.—Experimental researches on the influence of magnetism on the phenomenon of polarisation in dielectrics, by Edmond van Aubel. In this second communication the author gives the result of fresh experiments, showing how, by means of a specially-constructed electro-magnet, the electric field which interfered with previous researches may be completely eliminated, while preserving an intense magnetic field. The electro-magnet here described may also be used in ordinary physical experiments, wherever it is necessary to ascertain whether the phenomena observed with the Ruhmkorff and other electro-magnets are due to magnetism and not to the electric field or to the heat of the current traversing the bobbins.

SOCIETIES AND ACADEMIES

PARIS

Academy of Sciences, November 2.—M. Jurien de la Gravière, President, in the chair.—Fresh communication on rabies, by M. Louis Pasteur. (For summary of this report, see p. 30).—Note on the unequal flow of gases, by M. Haton de la Goupillière. Having, in previous papers, given a complete analytical solution of the various problems connected with this subject, the author here determines the true character of his formulas in their relation to experimental applications.—Remarks on M. Fontaine's report concerning his experiments on the transport of power by electricity, by M. Marcel Deprez. It is pointed out that M. Fontaine's method, which replaces the generator and receiver by a series of machines coupled together in sufficient number to produce the desired effect, so far from being based on any new principle, is the same as that proposed by all electricians who have sought to obtain high tensions without having recourse to the construction of the special machines first suggested by the author. The means employed by M. Fontaine to control simultaneously the four series of generators is also stated greatly to resemble that described in a patent taken out on April 28, 1885, by M. Deprez.—Experimental researches connected with the cerebral functions, by M. Brown-Séquard. These researches have been undertaken in order to show how varied and numerous are the purely dynamic effects proceeding from influences exercised on the encephalon by the sensitive nerves, and on the motor nerves by the nervous centres. Experiments carried on for seven or eight years lead to the general conclusion that all the motor nerves, and nearly all the excitable parts of the nervous centres, may have their excitability greatly modified, even under the influence of remote and slight irritations of the greater part of the nervous system.—On the atomic weight of the oxide of gadolinium, by M. A. E. Nordenskjöld. This compound is not a simple oxide, but consists of the three closely-related oxides of yttrium, erbium, and ytterbium, all with very different atomic weights. Nevertheless, even when derived from quite different minerals occurring in localities far removed from each other, it is here shown to possess a constant atomic weight. On the other hand, this substance is not a true chemical combination, but an isomorphous mixture, thus presenting a new phenomenon in chemistry and mineralogy. It is the only known instance of three isomorphous substances of the class which must still be regarded as

elements that are found in Nature not only always together, but always together in like proportions. — On a new function of the ootocysts in the invertebrates, by M. Yves Delage. A long series of researches recently conducted at the laboratory of Roscoff leads to the conclusions that these organs, occurring chiefly in the higher crustaceans and mollusks, serve not only as organs of hearing, but also, and perhaps mainly, as organs of locomotion, thus corresponding to the labyrinth of higher animals. — On *Gymnodinium polyphemus*, P., by M. Pouchet. Although hitherto regarded as a member of the vegetable kingdom, this organism presents the remarkable peculiarity of possessing an organ of vision of a somewhat complicated type. It is a headless Peridinioid, occurring on the French coast, and, like all Peridinioids, feeds on vegetables by endosmotic absorption. The eye, which always occupies a uniform position, is formed of two parts—a true crystalline and a true choroid—and its real character cannot be mistaken, resembling, as it does, in the most striking manner, the eyes of certain worms and Turbellariæ. — Saturation of selenious acid by the bases, and acidimetric analysis of this acid, by M. Ch. Blarez. — On the heat of neutralisation of the homologous or isomeric monobasic acids, by MM. H. Gal and E. Werner. The heat of neutralisation, already determined by Berthelot and Louguine for formic, butyric, and some other fatty acids, is here determined, together with the heat of dissolution for others, such as isobutyric, isopropylacetic, trimethylacetic, caproic, &c. — Synthesis of pentamethylenediamine, of tetramethylenediamine, of piperidine, and of pyrrolidine, by M. A. Ladenburg. — On two new chloruretted derivatives of methylbenzoyl, by M. Henri Gautier. The process is explained by which the author has obtained a trichloruretted and a dichloruretted methylbenzoyl. — A new reaction of the chloride of aluminium: syntheses of the fatty series, by M. Alph. Combes. The chloride of aluminium, which has effected so many syntheses in the aromatic series, is here for the first time systematically applied to the production of substances of the fatty series. — Hæmatoscopy, a new method of analysing blood, based on the employment of the spectroscope, by M. Hénoque. This method, already tested on 200 subjects, comprises two classes of observations: (1) determination of the quantity of oxyhæmoglobin, or active colouring-matter of the blood, by means of instruments here figured, and named "hæmatoscopes" and "hæmatospectroscopes"; (2) duration of the reduction of the oxyhæmoglobin estimated by spectroscopic examination. — Fresh remarks on the stem of Poroxylon, a fossil Gymnosperm of the Carboniferous epoch, by MM. C. Eg. Bertrand and B. Renault. By comparing together homologous sections of stems of the same order but of different periods, the authors have succeeded in determining the variations introduced by time into the normal stem of this plant. — On a fundamental condition of equilibrium for the living cells of plants, by M. Léo Errera. — Petrographic study of a carboniferous diabase from the neighbourhood of Dumbarton, by M. A. Lacroix. The rock here under consideration, a vertical greenish stratum traversing the old red sandstone, presents an opportunity of studying in a small space the various structural forms which a volcanic rock may assume under the influence of a progressive cooling process. — The dislocations of the globe during recent periods, their lines of fracture, and the conformation of the continents, by M. Jourdy. — On the unity of forces in geology (continued), by M. H. Hermite. It is argued that simple oscillations of sea-level, produced by meteorological causes, would suffice, without having recourse to internal agencies, to explain the apparent oscillations of the land in relation to latitude, which are characteristic of the Quaternary epoch. — On the pathologic physiology of the supra-renal capsules, by M. Guido Tizzoni. — On the contractions determined by the currents of polarisation of the living tissues, by MM. Onimus and Larat. The experiments here described place beyond doubt the existence and energy of the currents of polarisation in our tissues, thus exposing the errors of the fundamental experiments carried out by Du Bois-Raymond and most German physiologists. — Note on a remarkable substance collected at Luchon on July 28, 1885, after the fall of a thunderbolt, by M. Stanislas Meunier.

STOCKHOLM

Academy of Sciences, October 14. — Contributions to the anatomy and histology of the limnivore Annelids, by Dr. A. Wirén. — On the electric nature of drift-snow, by Prof. A. Holmgren. — On the work and activity of the Ornithological

Committee of the Academy for studying birds of passage, by Prof. F. A. Smitt. — On new acquisitions to the Botanical Garden of the Bergian donation, by Prof. V. Wittrock. — The lichens of the islands of the west coast of Sweden, by P. Hellborn. — Contributions to the anatomy of the *Marogra-ceæ*, by Hr. H. O. Juel. — Studies of the influence of wo and forests on the climate of Sweden, by Dr. Hamberg. — remains of *Dryasoctopetala*, L., in calcareous tuff near V stena, by Prof. A. G. Nathorst. — On combinations of pben methyl-triazol, by Hr. J. A. Bladin. — On the orbit of the comet 1877, VII., by Dr. R. Larsén. — Demonstration of the proposition that the complete integral of differential equations of n th order contains n arbitrary constants, by Dr. G. Eneström

BOOKS AND PAMPHLETS RECEIVED

Chemical Arithmetic, 2nd edition: S. Lupton (Macmillan). — Chas. By-Laws, and List of Members of the Institution of Civil Engineers (Great George Street). — Minutes of Proceedings of the Institution of Civil Engineers, vols. lxxxiii. to lxxxvi. (25, Great George Street). — Lectures, Essays, and edition: W. K. Clifford (Macmillan). — The Rotifera Wheel Animalcules, part 6: C. T. Hudson and P. H. Gosse (Longmans). — Calendar of University College of North Wales, 1886-87 (Cornish, Chester). — Persia as it is: Dr. C. J. Wills (S. Low). — High Life and Low of Silence: Mrs. Fred Burnaby (S. Low). — Smithsonian Report, 1885 (Washington). — Proceedings of the U.S. National Museum, vol. viii. 1885 (Washington). — Practical Dynamo-Building: F. W. Wa (Iliffe and Son). — Journal of the Royal Agricultural Society, October (Murray). — Rendiconto dell' Accad. delle Scienze, Fisiche e Matematiche anno xxiii., xxiii., xxiv., 1883-84-85; anno xxv. fasc. 1, 2, 3 (Napoli). — Musings on Holy-days and Holidays: Rev. N. Curmeck (W. Mer). — Commercial Organic Analysis, vol. ii: A. H. Allen (Church). — A Synopsis of Elementary Results in Pure Mathematics: G. S. (Hodgson). — Our Temperaments: A. Stewart (Lockwood). — The Con Deluge of Russian Petroleum: C. Marvin (Anderson). — Methods of Analysis of Commercial Fertilisers (Washington). — Publications of Leader McCormick Observatory of the University of Virginia, vol part 3, Nebula of Orion, 1885.

CONTENTS

PA

Letters and Journals of W. Stanley Jevons	
General Pathology	
Plane Geometry	
Our Book Shelf:—	
"American Journal of Mathematics"	
Casey's "Sequel to the First Six Books of the Elements of Euclid"	
Lilley's "Geometrical Drawing for Army Candidates"	
Letters to the Editor:—	
The Enormous Loss from Ox-Warble.—Dr. John Wrightson	
"Long Sick."—E. J. Dungate	
The Beetle in Motion.—C. J. G.	
Meteors.—Rev. John Hoskyns-Abramhall; E. Parry	
Influence of Wind on Barometric-Readings. By Prof. Cleveland Abbe	
M. Pasteur's Treatment of Rabies	
Report on the Charleston Earthquake. By Prof. T. C. Mendenhall. (<i>With a Map</i>)	
The Similarities of the Physical Geography of the Great Oceans. By J. Y. Buchanan	
Notes	
Our Astronomical Column:—	
Stellar Photography at Harvard College	
Astronomical Phenomena for the Week 1886 November 14-20	
The Erosion of the English Coasts. By W. Topley	
Observations on Heredity in Cats with an Abnormal Number of Toes. By Edward B. Poulton. (<i>Illustrated</i>)	
Lighthouse Illuminants, I. By A. Vernon Harcourt, F.R.S.	
The Lumbar Curve in Man and Apes	
Scientific Serials	
Societies and Academies	
Books and Pamphlets Received	

THURSDAY, NOVEMBER 18, 1886

THE ZOOLOGICAL RESULTS OF THE
"CHALLENGER" EXPEDITION

Report on the Scientific Results of the Voyage of H.M.S. "Challenger" during the Years 1873-76 under the Command of Capt. G. S. Nares, R.N., F.R.S., and Capt. F. T. Thomson, R.N. Prepared under the Superintendence of the late Sir C. Wyville Thomson, F.R.S., &c., and now of John Murray, one of the Naturalists of the Expedition. Zoology—Vols. XV. and XVI. (Published by Order of Her Majesty's Government, 1886.)

VOLUME XV. contains three Reports on the univalve Mollusca collected. The first is a short Report, by Dr. Rudolph Berg, on the Marseniadæ. This family has slowly gathered round the *Helix perspicua* of Linnaeus and the *Bulla latens* of O. F. Müller. These species are found in all seas. The shell is either altogether enveloped in the mantle or is very partially exposed, always either calcareous or horny. Six genera are recognised, with 33 species, 11 of which are described and figured as new.

The great bulk of the volume is taken up with the Report, by the Rev. R. Boog Watson, on the Scaphopoda and Gasteropoda. This laborious memoir occupies over 750 pages, and is illustrated by an atlas of fifty plates. Some 1300 species, new and old, were recognised among the mass collected, and there were some 400 indistinguishable forms. In a short appendix, the Marquis de Folin describes and figures the Cæcidæ. The classification adopted, "for want of a better," is that of the Messrs. Adams. The more important of the general conclusions based on the examination of the facts attending the habitat of all the distinguished forms are as follows:—(1) Depth is an important condition in connection with Molluscan life; (2) but temperature is even a more important condition than depth; (3) great differences in either depth or temperature prove barriers to distribution; (4) where these do not exist, there would seem to be no limit to universality of distribution; (5) there are without doubt such universally distributed forms. The author sees no evidence in the oldest or most widely distributed species of any essential, lasting, and progressive change.

The last Report is on the Polyplacophora, by Prof. A. C. Haddon. The number of Chitons collected was, considering the frequency and wide distribution of the group, surprisingly small. Almost the only shore-collecting done during the cruise was on or near coral-reefs, and Chitons would seem to be rare in such places. The really deep-sea forms belong to Leptochiton, of which 4 species were found, and 2 are new. These species were taken at depths of from 60 to 2300 fathoms. Three plates accompany this Report: two are from drawings by the author, and the third, a coloured plate, gives the portraits of the new species by T. H. Thomas.

Volume XVI. contains the four following Reports:—(i) On the Cephalopoda, by W. Evans Hoyle, M.A. Oxon., Naturalist on the Editorial Staff. In a preface to this valuable Report, the author acknowledges the kindly and generous assistance which he received in its execution

VOL. XXV.—NO. 890

from Prof. Steenstrup, of Copenhagen, whose knowledge of the Cephalopods is immense, and the collection under his charge is unrivalled. This Report is almost exclusively systematic in its scope, but we are promised a supplement with anatomical details. It commences with a provisional synopsis of recent Cephalopods, which will certainly be of immense value to all workers. While it is true that no systematic treatment of the class can for some time to come be other than provisional, yet the author seems to have taken the greatest pains that his shall be as natural as possible, and until we have a nearly complete knowledge of the life-history of all the forms, more will not be attainable. This list contains 388 species referred to 68 genera. It would have been, we think, an improvement if all those collected during the Expedition had been in this list distinguished by some special mark, as well as having the recorded habitats for each given. Of the 72 species found, some 32 are described as new, and for these 4 new genera and 1 family had to be established. Out of the 388 species, some 60 or 70 had been so badly described as not to be recognisable, but of some of these no doubt the types still remain. Of the new species, none pertain to those great monster cuttles—source of many a battle. The exceedingly interesting genus Cirroteuthis is enriched with three species—one, *C. magna*, being the giant of the group, and measuring 1155 millimetres in length. The type species of this genus (*C. mülleri*, Esch.) was the only one known until 1883, when a second species was described by Fischer, and now (1885) five new species have been described by Hoyle and Verrill. The balance of the evidence seems to be in favour of all the species being deep-sea forms, though at present there are great difficulties in the way of settling the question. A new genus, Amphitretus, is established for a form in which the mantle is fused with the siphon in the median line, so that there are two openings into the branchial sac. This is a quite unique feature among Cephalopods. The species *A. pelagicus* was taken near the Kermadec Islands. It seems strange that but one specimen of *Argonauta argo* was found, for this and other species are not very rare. Of the genus Octopus, 20 species are enumerated, of which 11 are described as new. The one specimen of *Spirula peronii*, found living off Banda, is referred to, but Prof. Huxley is preparing a report on its anatomy. To the already large genus, Sepia, large additions were made, and it is interesting to note that all of the 10 new species were found between Port Jackson (Australia) and Japan. The shell, or sepio-staire, was found to present differential characters in the species, and a series of new terms has been adopted to describe its various parts. The suckers also seem to offer characters of specific importance, and so possibly will the hectocotylised arms when sufficiently known. Two species of Steenstrup's genus Taonius are recorded, one, *T. hyperboreus*, the common North Atlantic form, and the second the *T. (Procalistes) suhmi* of Lankester. Willemoes-Suhm had taken it for a Clionid Pteropod. Lankester described it as a new genus; but the author regards it as but a species of Taonius, and with this Prof. Steenstrup agrees, though he thinks that the specimens found may appertain to two species. As in the case of the Argonaut so in that of the Paper Nautilus but a single specimen was found, and that off Matakau, Fiji Islands. A most

important means of obtaining specimens seems to have been by the examination of the stomachs of birds, fish, and Cetacea. These creatures seem to be much more satisfactory collectors than the tow-net, in which, though it was so constantly in use, few Cephalopods were taken. Possibly the immense activity of the cuttlefish will account for this. An atlas of thirty-three plates accompanies this Report.

(2) On the Stomatopoda, by W. K. Brooks, Johns Hopkins University. These Crustacea are in their adult forms inhabitants of shallow water. The collection brought home was but small, and contained no startling novelties, so that at first the author was somewhat disappointed; but this feeling turned to delight when he discovered that the material furnished some excellent opportunities for tracing out, and that with great completeness, the phylogeny and ontogeny of this little order. This order includes about 60 adult species and a vast number of tropical larvæ. The *Challenger* collection of adult forms consisted of only 15 species, 8 of these new, while 2 others had been, to this, very inadequately described; but the collection of pelagic larval Stomatopods was peculiarly rich, and in Mr. Brooks's hands it has yielded the material for tracing the history of several of the larval types, and also, more remarkable still, for establishing in every genus except one the connection between the adults and their larval types. The larval history of these Stomatopods has been one of the most puzzling problems in morphology, and the very admirable researches of Claus had been the only guide. Though often in error, Mr. Brooks confesses that without Claus's memoir to guide him his own labours must have failed. Unlike most Malacostraca, the Stomatopods, instead of carrying their developing eggs about with them, deposit them in their deep and out-of-the-way burrows under the water. They are thus most difficult to procure, and so difficult to rear that probably not a single instance of a young Stomatopod being reared from the egg is known. The growth of the larvæ is slow, and the larval life long, and, as they are as independent and as much exposed to changes in their environment and to the struggle for existence as the adults, it has come to pass that they as larvæ have undergone countless modifications which have no reference to the life of the adult, and are therefore unrepresented in the adult organism, in which the larvæ differ *inter se* more than the adults do, thus reversing the general rule. The history of each larval type has thus to be traced by the selection and comparison of those larvæ which belong to the series, and in doing this the author was partly guided by general resemblances and partly by a series of comparative measurements. The differences between the genera are slight, and all can be grouped into a single family, Squillidæ. In the description of *Lysiosquilla excavatrix* we have a very interesting account of its habits. The Report concludes with an elaborate account of the various larval forms and their adult connections. Sixteen plates accompany the Report.

(3) On the Reef Corals, by John J. Quelch, B.Sc. Lond. The author apologises for this Report of just 200 pages being so short, as he was limited both as to time and space. A careful perusal of the memoir inclines us to the opinion that no such apology is needed. Without being a monograph, the Report forms a most important

contribution to our knowledge, and this not only of the distribution of the reef corals, but also, in many instances, of their structure. The term reef coral is undoubtedly vague, but the forms described in this report belong almost entirely to the Reef Madreporæ, descriptions of some few species of Milleporæ being added. The collection made contained representatives of 293 species referable to 69 genera, and many of the species were represented by series of specimens often presenting a considerable degree of variation. As a proof of how little known are the corals of the Pacific and Indo-Pacific Islands, it may be mentioned that 71 of the new species were found in these regions, while but 2 were from the Atlantic. No attempt has been made to describe the soft parts of the specimens. Special attention is directed to the fact that the descriptions of species apply to specimens in which the calyces are perfect; in most museum specimens these are generally to be found greatly injured, and then it is often impossible to distinguish between closely-related forms. In the treatment of the distribution of these corals, lists are given of the species obtained at each locality, together with lists of the new species, and of old species recorded from the stations for the first time. While the classification adopted is on the main based on that of Milne-Edwards and Haime, a rather startling novelty in arrangement is the merging of the Madreporia Rugosa with the section of Madreporia Aporosa. The detailed reasons for this are given on pp. 40-43; and as a result the author considers that there is not a single characteristic of the old group Rugosa which will essentially separate forms usually included under it from the more typical Astræids. Thus in many Astræids the septa present are not multiples of six, while in some typical Cyathophyllidæ the septa are simply radially arranged, without any indication whatever of a tetrameral type. Again, the presence of a fossula is scarcely even of generic value; and as to the presence in the adult rugose coral of but two sizes of septa, this phenomenon is not always present in the species, and is to be met with in some typical Astræids; while as to the tabulæ, which are no doubt very characteristic of the Rugosa as a group, still even these are present in some Astræids, and absent in some Rugosa. In a striking new Madreporæ, *Moseleya latistellata*, the characters are to a marked degree intermediate.

There is yet a great deal of work to be done ere the distributional areas of the reef corals is known. Probably the coral fauna of no district, unless that of the Red Sea, has been fairly worked out. It was in the nature of things that the cruise of the *Challenger* could not, from the shortness of its sojourn at any one coral district, do much in this direction. Still some few facts of great interest have been brought to light, one of the most remarkable being the occurrence of an undoubted reef-building species, *Manicina areolata*, in Simon's Bay, between lat. 34° and 35° S., at a depth of from 10 to 20 fathoms, and at a temperature of 65° F., and this is all the more peculiar, as this coral is a well-known West Indian reef-building form. Another coral, *Cladocera arbuscula*, was also found at Simon's Bay, though a West Indian species.

Notes and descriptions of eight species of Millepora are given in an appendix. One new species is called after Mr. Murray, being the one on which he saw the

living zooids of this remarkable group of Hydroids. It was *M. nodosa*, occurring at Tahiti, that afforded Prof. Moseley the material for his brilliant confirmation of the observations of L. Agassiz. Twelve plates, the figures on which are beautifully executed by Mr. H. Gawan, accompany this Report.

The concluding Report in this volume is by Prof. Sir William Turner, being on the Human Crania, &c., collected during the cruise. This forms Part 2, being on the bones of the skeleton, and is an Essay on the Comparative Osteology of those Races of Men whose bones are described in the Report, for it incorporates the study not only of the material collected during the cruise of the *Challenger*, but that brought together by the authors' eminent predecessors in the Chair of Anatomy in the University of Edinburgh.

Just a century ago Camper pointed out some of the differences existing between the pelvis of a Negro and a European, and since then a vast amount of information on the subject has been accumulated, and so far as the races described in this Report are concerned, it has been exhaustively treated by Sir W. Turner. He classifies the pelvis into three groups: dolichopellic, with a brim index above 95; mesatipellic, with a brim index from 90 to 95; and platypellic, with index below 90. As to the race and age characters of the pelvis, the details, however interesting, are too technical to be abstracted. In reference to the question of how far the mode of life may act as modifying the transverse diameter of the pelvic brim, we may add that the expression "to sit on one's hunkers," would be readily understood in the North of Ireland, where it is an attitude strictly forbidden to young people. In the section treating of the spinal column, the subjects of peculiarities of individual vertebrae and the lumbar curve are investigated; and in another section the scapula, inferior and superior extremities, are examined. In a concluding section we have a general summary, and an appendix to the first part of the memoir on the "Human Crania," in which some additional details are given of some crania from Australia, the Sandwich Islands, New Guinea, and Fuegia. An index to both parts also accompanies this Report, which is illustrated by three plates of the pelvis of different races.

The greater portion of the manuscript of these two large volumes was handed to the editor between July 1885 and July 1886, and the editor is to be congratulated on the successful manner in which this immense amount of scientific matter has been seen through the press.

ELEMENTARY DYNAMICS

Lessons in Elementary Dynamics. Arranged by H. G. Madan, M.A., Assistant Master in Eton College. Pp. 180. (Edinburgh: W. and R. Chambers, 1886.)

IN this little book the author has provided teachers of elementary mechanics with a rich storehouse of materials for experimental demonstrations, although the work is not quite satisfactory in some other respects. His endeavour has been to explain some of the properties of matter, Newton's laws of motion, and the modern conceptions of energy and work, in such a manner as involves only the most elementary knowledge of mathematics. Thus symbolical reasoning and formulæ

are dispensed with, and nothing assumed beyond a knowledge of arithmetic and a little easy geometry. There is a successful attempt made to arouse a real interest in the subject by continual reference to phenomena of every-day life, and especially by illustrations drawn from the sports and games of the pupils. In some cases detailed instructions are given for performing the experiments. These are valuable, and similar aid might with advantage be provided in many other instances.

The author is of opinion that mechanics ought to have the first place in a boy's scientific education. This position would be strengthened, if some series of simple experiments, to be performed by the pupils themselves, were provided, and regarded as essential.

Some expressions, such as "above," "below," "on the same level," which are usually left undefined, have their exact scientific meaning pointed out. On the other hand, there is occasionally looseness and confusion in the use of technical terms. For example, in Section 103 we read: "Momentum is the term used to express the *force* with which anything is moving." In Section 159 we have the accurate statement that, by finding the momentum of a body, we learn what *impulse* has been applied to it: here the accepted expression for the time-integral of a force is used, but we do not notice any definition of the word "impulse"; and the exposition of the second law of motion appears vague in consequence. Similarly, the *force* exerted in throwing a cricket-ball is spoken of in Section 156, where the time-integral of the force is in question.

Section 302 is devoted to the "exact valuation of the energy in a moving body," and the usual expression—energy = $\frac{1}{2}$ (mass \times velocity²)—is obtained, but by a process which is at least startling. Witness these statements:—"If the work could be done *in an instant*, the energy would be exactly expressed by the product of the mass \times velocity²;" and again, "The whole amount of work which a moving body can do in the time during which its motion is being stopped will correspond to the *average or mean* amount of energy between that which it has at the beginning of the time and that which it has at the end of the time." *Unde, quo veni?*

After the preceding, it is a small matter to refer to Section 311, where this statement occurs: "The motion of the pendulum is an accelerated motion, and, as in all other uniformly accelerated motions, the spaces described are as the squares of the times." Here, of course the reasoning is fallacious; and, although the proof intended is sound, it involves the doctrine of limits, and wants development. It is surely better at this stage of the pupil's progress to rely on the experiments in Section 312.

There is an appendix on the metric system, and, in conclusion, a dozen pages of questions and exercises on the several chapters of the book. A. R. W.

OUR BOOK SHELF

Food-Grains of India. By A. H. Church, M.A. (London: Chapman and Hall, 1886.)

A WELL-WRITTEN, well-illustrated, and well-turned-out volume. Its thinness only enhances its elegance. Its illustrations, by Mr. G. W. Ruffles, are charming, clear,

without hardness, and life-like. The text is interesting, and the number of food-grains described in excess of what most of us were aware existed. Prof. Church commences his work by what must have been to him a familiar task—describing the chief constituents of food, splitting up the sugars into their groups, and pointing out the differences between true nutrients and food-adjuncts. Part 2 is devoted to dietaries and rations. With Part 3 commences the peculiar merit and *raison d'être* of the work. After some remarks upon cereals generally, the reader is introduced *seriatim* to no fewer than twenty-three cereals, the only member of the group conspicuous by its absence being rye—a grain which occupies a very important place in Europe. The presumption is that it does not occur in India, but such a presumption surely presumes too much. Wheat is described as an annual grass of unknown origin, but we scarcely see why this *nescience* as to the origin of wheat should be especially set forth. Are we to infer that barley, oats, maize, rice, the millets, &c., are annual grasses of known origin? If so, would that the Professor had devoted a few lines in each case to this particular point! The origin of our food-grains is a deeply interesting subject, veiled, we are afraid, for the most part in mist, and only conjecturally outlined.

The author disclaims any special originality, and duly credits the works of Dr. Forbes Watson, and Messrs. Duthie and Fuller, as well as other authors, as sources from which he has industriously gathered information. Messrs. Duthie and Fuller's work, however, dealt but little with the chemistry or physiology of the plants they described, and they treated more exclusively of the cultivation of the various crops.

The interest of Prof. Church's book lies in the illustrations, which are super-excellent; in the analyses, many of which were made in the author's own laboratory; in fixing the nutrient-ratio and nutrient-value of so many foods; and, lastly, in the comprehensive view given of Indian cereal and other crops. The Indian local names and Sanskrit equivalents are also interesting. These are taken by our author on trust, but all or many of them also occur in Mr. Duthie's book, which would be a guarantee of their correctness.

JOHN WRIGHTSON

Tobacco a Farmer's Crop. By Philip Meadows Taylor. (London: Edward Stanford, 1886.)

THIS is a small book of seventy pages. The first half is occupied by pleasant matter relating to the history of tobacco in Europe not strictly or seriously relevant to the title. The latter half redeems the whole from the stigma of being unpractical. An interesting account is given of the despotic regulations of the "Régie des Tabacs," a Government Department which grants licenses for growing, manufacturing, and selling tobacco throughout France, and whose powers extend to the nomination of the cultivators, the variety of tobacco to be grown, the number of plants per hectare, and even the number of leaves permitted per plant, so that the unfortunate cultivator may and must give a perfectly accurate account of his yield down to a single leaf. The methods of cultivation followed in France are described plainly and apparently practically. The important question as to whether tobacco can be grown profitably in England is answered unhesitatingly in the affirmative, and a sensible scheme is propounded for bringing its culture into harmony with the Excise. The coldness exhibited by our Royal Agricultural Society towards the tobacco movement last April is strongly animadverted upon. As to our climate, Mr. Taylor writes as follows:—"It is stated to be too cold, too damp, too uncertain in England to allow of the introduction of the proposed culture. I cannot conceive or allow that there can exist any sensible difference between the climate of the southern counties of England and that of Picardy

and Flanders. I do not take notice of Prussia and even Russia, where tobacco is grown. I believe that the general climate in Southern England is more genial than in the countries across the Channel, and I feel confident that in the said southern counties of England and in Ireland tobacco could be advantageously grown. I recall my former statement that the plant is only on the ground from June to September: cold winters, early frosts, and November fogs have naught to do with the question. The author does not appear to take into account the comparative coolness of the summer months in England which has always prevented the successful growth of maize, vines, and probably tobacco also. This very readable little book, with its unstudied side-lights upon French rural life, and its pleasant style, may be recommended without any hesitation to the reading public.

JOHN WRIGHTSON

Marion's Practical Guide to Photography. (London: Marion and Co., 1886.)

HERE we have a very good book, which contains all necessary information and useful hints for those who are practising the art of photography. The whole process is gone through in a very clear and easy way. Extra chapters are given on different parts of the subject, such as photographic optics, re-touching, portraiture, &c. On p. 95 a table of exposures is added, preceded by explanations, taking into consideration all the variations of scenes and subjects which the amateur is likely to come across. The manufacturers deserve great credit for publishing a book in which the best way of using their apparatus is described; a book published under such conditions ought to be truly practical, and one would think that the manufacturer of bad apparatus would not be too anxious to teach his customers how to find it out.

Lecture Notes and Problems on Sound, Light, and Heat By Charles Bird, B.A., F.G.S. (London: Relfe Bros. 1886.)

FOR students who are attending lectures on these subjects this book will be very useful, as it contains the chief fundamental formulæ, set out in a very clear manner, and it is very compact, capable of being put into one's pocket without inconvenience.

Bicycles and Tricycles for the Year 1886. By H. H. Griffin, London Athletic Club. (London: L. Upcott Gill, 1886.)

Now that cycling has become so general, and consequently the cycle industry increased so largely, a book on the subject will doubtless be most welcome. We have here one which gives a *good* description, and in many cases a woodcut, of every known make, with the exception, perhaps, of one or two very new patterns which have been introduced very recently. We need not enter into the details from the scientific point of view as they have been previously described (NATURE, vol. xxxiii. p. 132). A description of different varieties of bells, lamps, &c., is also given. Great pains seem to have been taken by the author to bring the book up to date, and to give an accurate account; each machine as he tells us, having been examined by himself.

LETTERS TO THE EDITOR

[The Editor does not hold himself responsible for opinions expressed by his correspondents. Neither can he undertake to return, or to correspond with the writers of, rejected manuscripts. No notice is taken of anonymous communications.]
[The Editor urgently requests correspondents to keep their letters as short as possible. The pressure on his space is so great that it is impossible otherwise to insure the appearance even of communications containing interesting and novel facts.]

Extension of the Corona

IN reference to the failure of observers at the late eclipse note any such extension of the corona as was seen in 1874,

desire to add my testimony to Mr. Common's opinion (NATURE, vol. xxxiv. p. 470), that the conditions of the sky must have been wholly different; and where the visibility of the corona is in question, the atmospheric diffusion is all-important.

We have a most trustworthy criterion of the amount of diffused sky light in the visibility of the moon's limb outside the sun on the coronal background. This appears not to have been observed at all last August, and it may be useful to recall what it looked like under certain almost ideal conditions, which are not likely to recur.

On July 29, 1878, I observed it in the remarkably clear air of Colorado, and at an altitude of over 14,000 feet, on Pike's Peak, and have a vivid recollection of its appearance then. After totality, and while writing my notes, I heard a call from some bystander of "Look at the moon!" and glancing up from the paper (with an eye which could not have been in a sensitive condition), saw the moon's limb outside the sun, most conspicuously defined by a band of pearly light, which faded outward, but whose visible width can be estimated from the fact that though I went on intermittently with my notes, and took no other precaution to shield the eye than keeping it in the shadow cast by my telescope stand, the limb continued in my view under these unfavourable circumstances for *four minutes and twelve seconds* after totality was over. A similar duration was recorded by Gen. Myer, the Chief Signal Officer of the United States, who observed near me; and others at a lower altitude certified to having observed it over three minutes. Something is due to the increased sensitiveness of the eye after the darkness, but there is no doubt that, with even the slight rest of the retina which totality afforded, the phenomenon was such a salient one as to force itself on the attention of those not regarding it.

This is for a very exceptionally pure sky, of course; but if, as is stated, observers specially seeking it could not even see the limb a little outside the sun (where the corona is brightest) last August, it seems clear that no conclusions as to its non-visibility under any ordinary means are to be drawn from negative evidence of such a kind.

S. P. LANGLEY

Allegheny Observatory, Allegheny, Pennsylvania

The Astronomical Theory of the Great Ice Age

IN your issue of November 4 (p. 7), my friend Mr. W. H. S. Monck asks one or two questions relative to the paper on "The Astronomical Theory of the Great Ice Age" which you did me the honour to reprint.

I take as a convenient unit the mean daily sun heat on one hemisphere. The amount of this unit is indicated by the fact that it continuously maintains the earth's temperature some 300° more or less above what it would be were the sun's heat withdrawn.

The calculations I gave showed that in the glacial winter the mean daily receipt of heat sunk to '68 of a unit, while in the brief glacial summer the mean daily receipt was 1.38 unit.

Considering the magnitude of the unit, it is obvious that fluctuations like this must correspond to vast climatic changes of the kind postulated in the Ice age. Here it seems to me lies the great originating cause of the Ice age, and to dwell on the minor phenomena merely obscures the real point.

If it be said that no great climatic change takes place because the total sun heat in the year remains the same, then I remark, as I did at the Royal Institution, that on this principle it would be the same thing to give a horse 15 lbs. of oats a day for six months and 5 lbs. a day for the other six months as to give him 10 lbs. of oats a day all the year round.

ROBERT S. BALL

The Observatory, co. Dublin, November 11

P.S.—I take this opportunity of correcting a misprint in my paper as given in NATURE (vol. xxxiv. p. 608). The maximum number of days' difference between summer and winter is 465 × eccentricity.

Abnormality in Cats' Paws

AMONG the many interesting features suggested by the genealogical table in last week's NATURE (p. 40), showing the persistence of abnormality in the number of toes on a cat's paw, there is one the significance of which seems not to have occurred to, or to have been passed over by, Mr. Edward Poulton. The peculiarity I refer to is the larger percentage of abnormality among the female offspring than among the male. Taking "Tabby

V." as a starting-point, and leaving out one abnormal kitten of which the sex was unnoted, as well as the families of which no particulars are given, the total number of descendants in the table is 36, of which 12 are males and 24 females. Of the 12 males, 5 are normal and 7 abnormal, or 41½ and 58½ per cent. respectively; and among the 24 females 7 are normal and 17 abnormal, or 29½ and 70½ per cent. respectively. Or, to put it in another way, among the 12-normal kittens 5 are males, 7 are females, or 41½ and 58½ per cent. respectively, instead of 33½ and 66½ per cent. as it should be; and among the abnormal 7 are males and 17 females, or 29½ and 70½ per cent. instead of 33½ and 66½.

This would seem to indicate either (1) that there is a greater tendency among the male offspring than among the female to revert to the normal condition, or (2) that there is a tendency among the offspring to inherit rather the peculiarities of the parent of their own sex—the male parent in all cases in the table being assumed to be normal. If rather, probably the former, though the latter could easily be tested by a similar set of observations with cats, the male parent of which was abnormal, the mothers being in each case normal.

J. HERBERT HODD

Hatton Garden, London, E.C., November 15

Abnormalities in the Vertebral Column of the Common Frog

IN preparing skeletons of the frog, my students came across the following abnormalities in the vertebral column, a record of which may be not without interest:—

(1) In a large *Rana temporaria*, the centrum of the eighth vertebra, instead of being biconcave (amphicoelous), is concavo-convex (procoelous), like that of the preceding vertebra. This abnormality I have observed before.

(2) In a medium-sized *Rana temporaria*, the eighth and ninth vertebrae are both abnormal. The ninth vertebra has well-developed only one transverse process (the right) for articulation with the ilium. The other (the left) is quite small and ill-shaped; there is no anterior zygapophysis on this side. The centrum is anteriorly convex on the right side and concave on the left side. Posteriorly, there is on the right side a convex articular surface for the urostyle; but on the left side the articular surface is ill-developed and irregular. In the eighth vertebra, the left transverse process is abnormally large and strong, has a marked backward direction, and has taken on itself the sacral function on this side, articulating with the ilium. The right transverse process is nearly, but not quite normal. There is a right, but no left, posterior zygapophysis. The anterior end of the centrum is normally concave; but the posterior end is convex on the left side and concave on the right side. The urostyle and the ilia are slightly modified in accordance with the abnormalities of the vertebrae.

C. LLOYD MORGAN

University College, Bristol

Influence of Wind on Barometric Readings

ALLOW me a few words of supplement to Prof. Abbe's useful letter in NATURE of November 11, p. 29.

Sir H. James's paper is perhaps better known on this side of the Atlantic than Prof. Abbe thinks; but there undoubtedly is too great a tendency to rush into print without previously reading up what has been done. The great bibliographical work which the Signal Office has in hand will do more to check this evil than anything which could be suggested, and hence its enormous importance.

As regards the application of suction to anemometers, no reference is made to that of Bourdon,¹ of which my friend Dr. Fines was recently kind enough to show me a very fine specimen at work at his observatory at Perpignan.

The Cowl Committee of the Sanitary Institute, far from being (as has been imagined) asleep or dead, has been very hard at work, and will in a few months report the result.

I sincerely hope that Lord Rayleigh will accede to Prof. Abbe's suggestion, but in the interim I append the report of Lord Rayleigh's Southampton paper which appeared in the *Meteorological Magazine* for October 1882, p. 130:—

"On the Effect of Wind on the Draught of Chimneys," by Prof. Lord Rayleigh, F.R.S.

¹ See also Laughton, "Historical Sketch of Anemometry," *Quart. Journ. Roy. Met. Soc.* vol. viii. (1882), p. 177.

"The author said that the draught diminished as the direction of the wind was more and more downwards, but did not go backwards until the inclination amounted to about 30°. The maximum up-draught would occur, not, as was often supposed, with a direction of wind vertically upwards, but with one making an angle of about 30° with the vertical. A chimney with a T-piece at the top never produced an unfavourable effect on the up draught, and only in one case failed to produce a favourable one. With a T-piece to which was affixed vertical ends, every wind met with would have a favourable effect, and no wind known would have an unfavourable effect.

"Prof. De Chaumont thought that vertical ends increase the resistance of the up-draught, and described a chimney with a lamp-shade-like top and conical cap, with which it was impossible to get a down-draught." G. J. SYMONS,
62, Camden Square, N.W. Registrar Sanitary Institute

Barnard's Comet

I WONDER that more has not been written about Barnard's comet (/ 1886). On the 9th, at 17h. 50m., in spite of the strong twilight, it was plain with the naked eye as a star. I did not notice its exact brightness, but it was perhaps equal to ρ Virginis. With the telescope its head was about 8' diameter, and it had two faint tails at about position-angles 250° and 300°. The former, which was the brighter at its origin, was $\frac{1}{2}$ ' long, and was straight; the latter I believe was curved, and was $1\frac{1}{2}$ ' long. T. W. BACKHOUSE

Sunderland, November 11

Aurora

LAST evening (November 2), between the hours of seven and eight o'clock, a bright aurora was visible in this vicinity. At intervals later in the evening, patches of cirrus clouds in the northern sky became luminous. The disturbance of the suspended magnet was at its height early in the evening, when the aurora was brightest. It is interesting to note the fact that this aurora was twenty-six days removed from that of October 7 and 8, corresponding to the time of the revolution of the sun on his axis. It is noteworthy, also, that very near to the time of the appearance of each aurora there was a slight renewal of earthquake activity in South Carolina and other localities.

Lyons, New York, November 3 M. A. VLEDER

"Lung Sick"

DR. EMIL HOLUB, in writing to me a few months ago from Panda-ma-Tenka, Albert Country, Zambesi, mentions having treated his cattle in a similar manner to that referred to in NATURE of the 11th inst. (p. 29). He says:—

"Shortly after I started northward from the Vaal, a contagious disease broke out among my cattle; there was any amount of sickness among the numerous trains (forty teams a day) going to the Diamond Fields, but I could get no clue to the lameness of the front legs of my bullocks for a long time. Having shot one, the disease proved to be a contagious pleuro-pneumonia, similar to the 'lung sick' so prevalent in this neighbourhood, affecting hips and shoulder-blades, causing lameness. The lungs were partly destroyed, but the animal had but little cough. I disinfected the whole herd, and vaccinated the healthy as well as the sick. The end of the tail was pierced with a narrow-bladed dagger, and a piece of lung full of virus inserted and then bandaged. The second vaccination effectually prevented the spreading of the disease for the whole journey, even in native locations similar to the Bechuanas, in which we were surrounded with 'lung-sick' cattle dying near our encampment."

PHILIP J. BUTLER

55, De Beauvoir Road, London, N., November 13

PAUL BERT

PAUL BERT, who has died at his post as Governor of Tonquin, was born at Auxerre in 1833, graduated Doctor of Medicine in 1863, and Doctor of Science in 1866. Obtaining a professorship in the Faculty of Science at Bordeaux, M. Bert devoted himself especially to physiology, and in 1869 he obtained the Chair of General Physiology in the Faculty of Science at Paris.

He continued here his experiments on the influence of changes of barometric pressure on life, and presented series of papers on the subject to the Academy of Sciences, which awarded him, in 1875, its great biennial prize of 20,000 francs. He entered political life in 1870, and has all along been known as an advanced Radical. He, however, never lost his interest in science; he did much to promote education in France, and took an active part in the legislative movement which obtained for M. Pasteur an annual pension of 12,000 francs as national recompense. M. Bert was elected President of the Biological Society in 1878, in succession to Clau Bernard, whose most brilliant pupil he was, and he there was admitted to the Academy of Sciences. Gambetta's Cabinet of 1881 he was Minister of Public Instruction, and a few months ago accepted the post of Governor of Tonquin, where one of his most notable acts was the founding of a Tonquinese Academy. M. Bert's papers on "Barometric Pressure" were published as a separate volume in 1877, and his lectures at the Museum of Natural History were in 1869 published under the title of "Leçons sur la Physiologie Comparée de la Respiration." He also issued, in 1869-70, "Notes d'Anatomie et de Physiologie Comparées." For many years had charge of the scientific department of the *République Française*.

At the sitting of the Academy of Sciences on Monday, the President, M. Jurien de la Gravière, expressed regret that politics had diverted M. Paul Bert from physiology; and M. Vulpian remarked that his death, though glorious for the country, was a calamity for science, his numerous memoirs having placed him among the first physiologists of the age. The Academy adjourned in sign of mourning.

THE RECENT WEATHER

AT the close of a short period of somewhat unusual weather conditions, it may be worth while to call attention to the more prominent features of those conditions.

Cyclonic systems, some of wide, some of small dimensions, have been primarily developed over Western Europe in unusually large numbers. Opportunities for studying those atmospheric conditions from which barometric depressions originate within the area of our European stations are by no means very rare, but they are nevertheless sufficiently scarce to merit careful scrutiny at the hands of every student of weather knowledge. So much is this the case that a meteorologist of eminence made, some years since, the statement that no one had ever been present at the birth of a storm.

Considering the disastrous nature of the floods, the sloppiness of earth and sky, and the general misery in the aspect of things, which characterise the event, few of us can wish to be very frequently spectators of it. But when it occurs, the conditions accompanying it should be carefully attended to. These may perhaps be briefly summarised thus:—

(1) Barometric depressions are primarily developed over a region where atmospheric gradients are slight, the exceptions to this rule being those systems (secondary or subsidiary, as they are termed) which first appear as loops or bulges in the isobars of a large pre-existing cyclone.

(2) They originate either in the rear of a depression which has already passed away or in the inter-space between two large anticyclones, and more especially when the anticyclones are so large that this inter-space constitutes what is called a "trough" of relatively low pressure.

(3) They are preceded and accompanied by an enormous condensation of vapour into cloud.

(4) They do not, at the moment of their birth, appear

to affect the upper currents of the atmosphere, but, if growing large, soon afterwards do so, in such a manner that the hypothetical isobars at the level of the cirrus appear to be bent into a V-shaped hollow from the great polar depression to a point nearly above the centre of the circular depression at the earth's surface.

Of the depressions lately developed near the British Isles and over the south-west of France, the greater number originated in "troughs" of relatively low pressure, such as have been above alluded to: and their movements may be said to have been unusually erratic. Yet they obeyed the ordinary rule of progression, in so travelling, as to have the highest general pressures on the right of their course. Thus, those depressions which originated near the east side of a "trough" lying north-north-west to south-south-east, tended to move to north-north-west, while those which originated on the other side of the "trough" travelled in the contrary direction. On the 10th inst., Great Britain lay between two depressions travelling in parallel but opposite directions, these directions being transverse to the mean direction of movement prevalent at this season of the year. The same phenomenon was repeated on the 12th inst. It is now more than twenty years since I began constructing daily charts of the directions taken by European depressions, and during the whole of that period there has been no instance entirely comparable with these.

We must wait for reports from a very extensive portion of the earth's surface before a comprehensive study of these phenomena can be undertaken. Two questions, so correlated that they may require but a single answer, are of prime importance:—What causes the abnormal, but temporarily persistent, determination of aqueous vapour to certain portions of the globe? What causes the abnormal, but temporarily persistent, occupation of certain portions of the globe by anticyclonic systems?

W. CLEMENT LEY

THE WORK OF THE UNITED STATES FISH COMMISSION¹

A BRIEF memorandum of what the U.S. Fish Commission hopes to accomplish in time, in connection with its mission, is as follows:—

(1) In the department of investigation and research there is yet to be carried out an exhaustive inquiry into the character, abundance, geographical distribution, and economical qualities of the inhabitants of the waters, both fresh and salt. The subject is practically unlimited in extent, and, so far as the ocean is concerned, has scarcely been touched. With the powerful apparatus, however, at the command of the Commission it is expected that much progress will be made year by year, and that the publication of the results and the distribution of duplicate specimens to colleges and academies in the United States will be carried out on a large scale, so as to meet a large and increasing demand from teachers and students.

(2) A second object, in connection with the sea fisheries, is the improvement of the old methods and apparatus of fishing and the introduction of new ones.

The work of the Commission in bringing to the notice of American fishermen the importance of gill-nets with glass-ball floats for the capture of codfish has already revolutionised the winter cod-fishery industry in New England. Looked upon almost with ridicule by the Gloucester fishermen, when first brought to their notice by the Commission, these nets have come rapidly into use, until at the present time they represent the most important element in the winter fisheries, the number of fish taken being not only much greater than heretofore but the fish themselves of finer quality.

¹ From the "Report of the U.S. Commission of Fish and Fisheries" (Washington, 1885).

The ability to maintain a successful fishery without the use of bait is of the utmost importance, in view of the fact that when the cod are most abundant bait is almost unprocurable. Other forms of apparatus of less importance have also been introduced, and a constant look-out is maintained, by correspondence and otherwise, in connection with the improvement of fishing machinery.

(3) Another important point for consideration is that of improvement in the pattern of fishing vessels. There is annually a terrible mortality in the fishing crews of New England, especially those belonging to the port of Gloucester, to say nothing of the total loss and wreck of the fishing vessels and their contents. There has gradually developed in connection with the mackerel and cod fisheries of New England a pattern of vessel which, while admirable for speed and beauty of lines and of rig, is less safe under certain emergencies than the more substantial and deeper vessel used abroad, especially in England and Scotland.

The subject of the best form of fishing vessel has been intrusted to Captain Collins, of the Commission, himself a most experienced fisherman, and, after a careful study of the boats of all nations, he has prepared a model which is believed to combine the excellences of both English and American vessels.

An appropriation will be asked from Congress for means to construct an experimental vessel and test its qualities; but until a successful experiment has been made it will be difficult to induce the fishermen to change their present form of construction.

(4) The fourth object of the Commission is to determine the extent and general character of the old fishing localities and to discover new ones. There is no doubt whatever that there still remain many important areas, even in the best-known seas, where the codfish and the halibut will be found in their former abundance. There has never been any formal investigation on this subject, and the banks that are known have been brought to light purely by accident. It is believed that by a systematic research and a careful survey the area of known grounds can be greatly extended.

There is very great reason to hope for successful results from this inquiry in the waters off the South Atlantic coast and in the Gulf of Mexico. These regions, the latter especially, may be considered as practically unknown, the few established localities for good fishing being in very small proportion to what must exist. It is here that the service of the fishing schooner referred to above, if means can be obtained to build it, will be brought into play, and it is not too much to hope that an industry will be developed that will represent to the Southern and South-Western States the same source of income and occupation that the mackerel, cod, and halibut furnish to the fishermen of New England.

(5) There is also much to be learned in the way of curing and packing fish for general and special markets. The American methods have grown up as a matter of routine, and are adapted to only one class of demand. There are, however, many modes of preparation which can be made use of to meet the wants of new markets; and thus we can enter more efficiently into competition with European nations for European trade, as well as for that of the West Indies and South America.

A great advance has already been made towards this desired improvement since the Centennial Exhibition of 1876, where many methods of curing and putting up fish were shown in the foreign sections that were almost entirely unknown in America. Notable among these were the preparations of sardines and other species of herring in oil, as well as in spiced juices. Quite recently this industry has been well established in Maine, amounting to a value of millions of dollars, and there are many other parts of the country where the same work can be done with other kinds of fish. The whole subject is receiving the careful consideration of the Commission, and numer-

ous facts bearing upon it have been announced in its reports and bulletins.

(6) The work of increasing the supply of valuable fishes and other aquatic forms in the waters of the United States, whether by artificial propagation or by transplantation, although very successful, may be considered as yet in its infancy.

It must be remembered that the agencies which have tended to diminish the abundance of the fish have been at work for many years and are increasing in an enormous ratio. This, taken in connection with the rapid multiplication of the population of the United States, makes the work an extremely difficult one. If the general conditions remained the same as they were fifty years ago, it would be a very simple thing to restore the former equilibrium.

At that time, it must be remembered, the methods of preservation and of wholesale transfer, by means of ice, were not known, while the means of quick transportation were very limited. Hence a small number of fish supplied fully the demand, with the exception, of course, of species that were salted down, like the cod, the mackerel, and the herring (including the shad). Now, however, the conditions are entirely changed. The whole country participates in the benefits of a large capture of fish, and there is no danger of glutting the market, since any surplus can be immediately frozen and shipped to a distance, or held until the occurrence of a renewed demand.

Another impediment to the rapid accomplishment of the desired result is the absence of concurrent protective legislation of a sufficiently stringent character to prevent unnecessary waste of the fish during the critical period of spawning, and the erection or maintenance of impediments to their movements in reaching the spawning-grounds. This is especially the case with the shad and the salmon, where the simple construction of an impassable dam, or the erection of a factory discharging its poisonous waste into the water, may in a few years entirely exterminate a successful and valuable fishery.

It is to be hoped that public opinion will be gradually led up to the necessity of action of the kind referred to, and that year by year a continued increase in the fisheries will be manifested. Even if this does not occur as rapidly as some may hope, the experiments so far furnish the strongest arguments in favour of continuing the work for a reasonable time. A diminution that has been going on for fifty or more years is not to be overcome in ten, in view of the increasing obstacles already referred to.

Among the species an increase of which in their appropriate places and seasons is to be hoped for, in addition to those now occupying the attention of fish-culturists, are the cod, the halibut, the common mackerel, the Spanish mackerel, the striped bass, or rockfish, &c.

One of the most important, and at the same time among the most promising, fish is the California trout, with which it is hoped to stock large areas of the country. Its special commendations are mentioned elsewhere in this Report.

Another fishery earnestly calling for assistance, and capable of receiving it, is that of the lobster, the decrease of which has been very marked. The experiments of the Fish Commission suggest methods by which the number can be greatly increased. Something, too, may be done with the common crab of the Atlantic coast and its transfer to the Pacific. Some kinds might also be advantageously brought to the eastern portion of the United States from the Pacific coast and from the European seas.

A subject of as much importance as any other that now occupies the attention of the Fish Commission is an increase in the supply of oysters. In no department of the American fisheries has there been so rapid and alarming a decrease, and the boasted abundance of this mollusk on the Atlantic coast, especially in Chesapeake Bay, is rapidly being changed to a condition of scarcity which threatens

practical extermination, as is almost the case in England. A fishing industry producing millions of dollars is menaced with extinction, and needs the most stringent measures for its protection.

The U.S. Fish Commission has been very fortunate, through its agents and assistants, in making important discoveries in connection with the propagation of the oyster, which are referred to hereafter in this Report; and it is proposed to establish several experimental stations for applying the discoveries thus made, so as to constitute a school of instruction and information to persons practically engaged in the business.

There are other shell-fish besides the oyster that will well repay the trouble of transplantation and multiplication. Among these are several species of clams belonging to the Pacific coast of the United States, which are much superior in size, in tenderness, and in excellence of flavour to those on the eastern coast. Most of these are natives of Puget Sound, and the completion of the Northern Pacific Railway is looked forward to as a convenient means of transferring them to Eastern waters. The common clams of the Atlantic coast are also fair subjects of experiment.

VOLCANIC DUST FROM NEW ZEALAND

A SHORT time since, Sir Julius von Haast sent me a small packet of volcanic dust from New Zealand, and requested me to examine it. The dust fell on June 10 of the present year (the day of the Tarawera eruption) at Matakava, Hicks Bay, 115 miles from the scene of the eruption. This dust is very fine, and, when regarded in the mass, is a dull, darkish gray colour. When examined under the microscope, it may be divided into—

(a) Bits of a more or less scoriaceous aspect—tiny lapilli, commonly almost opaque, being only translucent on thin edges—consisting of a somewhat brownish glass containing much disseminated ferrite. With reflected light they are a light to a darkish gray in colour, sometimes slightly reddish or brownish, with moderately rough surfaces. In size they usually vary from about $\cdot 005$ to $\cdot 008$ inch in the longest diameter; the former being the more common measurement; the latter is but rarely exceeded, the largest fragment in the portion which I have examined being $\cdot 012$ inch in diameter; lapilli also occur of less than $\cdot 005$ inch.

(b) Chips, more or less transparent, generally not exceeding $\cdot 005$ inch in diameter, and of all dimensions downwards to the finest dust. The majority of these chips are glass, commonly quite colourless; some of them contain bubbles, spherical, spheroidal, or more or less cylindrical. Sometimes these are quite $\cdot 001$ inch in longest diameter. Many chips show a ridgy surface, and are evidently formed by the destruction of a very frothy pumice like that of Krakatao. Some of the glass is of a light brown colour; occasionally it contains microliths of feldspar or trichites. The mineral chips are much less numerous than those of glass; the great majority of them are feldspar. Many of these are flat flakes apparently detached from a basal plane, but a few exhibit twinning. Some may be sanidine, but a plagioclastic feldspar is certainly present. The chips, however, are ill-suited for optical measurements, and the results which I have obtained are rather discordant. So far as I can come to a conclusion, I should say that the extinction-angles seem to indicate the not unfrequent presence of a feldspar which belongs rather to the oligoclase-albite group than to the labradorite-anorthite. I find very few indications of the presence of a pyroxenic constituent. One or two fragments are a greenish hornblende; three or four in general appearance resemble small flakes of magnesia-iron mica—lying on their basal faces, but some of these show dichroism, and only extinguish in certain positions between crossed Nicols, so that they cannot be this mineral. As to

their true nature I have not yet been able to decide; however, I think it probable some of the brown flakes are mica.

The result of my examination leads me to conclude that the dust is formed of material which was a glass wherein a porphyritic structure, on a large or a minute scale, was inconspicuous. This Matakava dust appears to agree generally with, though it differs varietiesly from, that described by Prof. Joly in *NATURE* (vol. xxxiv. p. 595), the main difference being that the biotite, which seems rather common in his samples, is rare in, if not absent from, the present one. I have not noticed sulphur, pyrite, or magnetite in a recognisable form.

It may be interesting to compare this dust with some samples projected from Cotopaxi, and described by myself (*Proc. Roy. Soc.* No. 231). These specimens came from various distances, ranging from twenty to sixty-five miles from the volcano. That which fell on the summit of Chimborazo (the most distant locality) consists of lapilli and chips; the majority of the grains range from about .001 to .003 inch; a very few only attain to a diameter of .01 inch, and this is barely exceeded. In this dust, however, the lapilli are comparatively rare, the chips of glass and mineral dominating, with a fair proportion of the latter. A reference to the above paper will show the difference between this ash, that from Krakatão, and the above-described from New Zealand. This may be explained by the fact that a porphyritic structure is common in the lavas of Cotopaxi (as in the other summits of the district).

T. G. BONNEY

NOTES

WE have to record the death of General John Theophilus Beaulieu, F.R.S., at the age of eighty-one years. He entered the Indian Army in 1820 as a lieutenant in the Bengal Engineers, and was for some time Superintending Engineer in the Public Works Department for the N. W. Provinces. Among other services to science and to India, General Beaulieu inaugurated the system of magnetic observations in India, and was the author of a book of logarithms of wide reputation. General Beaulieu was elected a Fellow of the Royal Society fifty years ago, and has served on its Council.

THE death is announced, at Berlin, of Dr. A. Fischer, so long resident at Zanzibar, and who has done so much for the exploration of the Kilimanjaro region.

M. CHANCOURTOIS, General Inspector of Mines in France, author of several works on geology, and Professor in the School of Mines, has died suddenly at Paris at the age of sixty-seven.

THE following are the probable arrangements for the meetings of the Society of Arts before Christmas:—“November 24, William Anderson, M.Inst.C.E., “Purification of Water by Agitation with Iron and by Sand Filtration.” December 1, adjourned discussion on the paper by Dr. C. Meymott Tidy, on “Sewage Disposal” (read April 14, 1886). December 8, Major-General C. E. Webber, R.E., C.B., “Glow-Lamps, their Use and Manufacture.” December 15, J. B. Marsh, “Cameo-cutting as an Occupation.” There will be five courses of Cantor Lectures during the session:—(1) “Principles and Practice of Ornamental Design,” by Lewis Foreman Day. (2) “Diseases of Plants, with special reference to Agriculture and Forestry,” by T. L. W. Thudichum, M.D. (3) “Building Materials,” by W. Y. Dent, F.C.S., F.I.C. (4) “Machines for Testing Materials, especially Iron and Steel,” by Prof. W. C. Unwin. (5) “The Structure of Textile Fibres,” by Dr. Frederick H. Bowman, F.L.S., F.G.S. Two Juvenile Lectures on “Soap Bubbles,” by A. W. Reinold, F.R.S., will be given on Wednesday evenings, January 5 and 12, 1887. The

meetings of the Colonial Section and of the Indian Section will not commence till after Christmas.

THE General Committee of the Society for the Prevention of Hydrophobia and Reform of the Dog Laws held its fourth meeting on Friday last at the offices, 50, Leicester Square, London, W.C., to consider a programme which had been drafted by a sub-committee and circulated among members and supporters. Mr. Victor Horsley, B.S., F.R.S., Secretary to the Commission on Hydrophobia, attended this meeting by invitation, and was unanimously elected a Member of Committee. Many letters were read expressing approval of the programme and regretting that the writers were unable to attend. Among the gentlemen who thus wrote were Dr. Drysdale, Prof. Fleming, Dr. Norman Kerr, Prof. E. Ray Lankester, Mr. Arthur Nicols, and Prof. Pritchard. The Honorary Secretary having made a financial statement of a satisfactory nature, the Chairman, Colonel R. H. Rosser, briefly explained the care and time given by the sub-committee to the programme, which was then discussed in detail, and ordered to be printed with some additions and alterations.

It is intended, in Section III. of the Manchester Jubilee Exhibition, to exhibit the historical and modern methods adopted in the several branches of electro-metallurgy, such as gold, silver, platinum, nickel and copper plating, the purification of metals by electrolysis, and generally to illustrate the connection between electricity and chemistry.

INFORMATION has been received by the Board of Trade respecting the oyster fisheries of the Isle of Wight. The oyster grounds and breeding ponds of the Isle of Wight are as follows:—(1) Medina River; (2) Brading Harbour; (3) Newtown; (4) Fishhouse or Fishbourne. In 1867 the Isle of Wight Oyster Fishery Company was started, having the Medina River and Newtown Creek for its grounds. This oyster fishery is said to have done well until 1871, when it was troubled by refuse and sewage discharged by mills at Newport, and a large quantity of the broods were destroyed. The Medina fishery is now for sale. About the year 1873 Major Boyle started a system for breeding oysters at Brading, but in 1876 the harbour works were commenced, and Major Boyle had to relinquish his ponds. The Harbour Board, however, still carry on the oyster breeding at Brading. They have six or seven ponds near St. Helens, which are estimated to contain five or six millions of oysters at the present time. As Brading is not suitable for fattening, the young oysters are sold to various growers to be laid down for one or two years to render them fit for food. Newtown Creek is the best fattening ground in the Isle of Wight, but the fishery company is now in liquidation through want of funds, and the business is in abeyance. At Fishhouse there has been a good fall of spat this last summer, but the ground is much disturbed by barges, which prevents the fishery from being fully developed. The oyster fishery is consequently not very prosperous. The creek, it may be mentioned, was recently cleared, and some sixty or seventy thousand oysters were transferred to Newtown to fatten in a pond placed at their disposal by the Newtown Company. Besides the oyster fishery companies above referred to, there are several fishermen who dredge for oysters at sea in the Solent, and particularly in Osborne Bay. The oysters dredged up are seldom fit for the market, and have usually been sold to one of the companies to be laid down and fattened.

IN Dr. B. W. Richardson's recent Cantor Lectures on “Animal Mechanics,” speaking of the mechanism of the heart, he described the number of the pulsations of the heart in different animals—in fish, frog, bird, rabbit, cat, dog, sheep, horse—and made a few comments on the remarkable slowness of the heart—40 strokes per minute—in the horse. Then the number of

pulsations in man at various periods of life, and at different levels, from the level of the sea up to 4000 feet above sea-level, was brought under review, and was followed by a computation of the average work performed by the heart in a healthy adult man. The work was traced out by the minute, the hour, and the day, and was shown to equal the feat of raising 5 tons 4 cwt. one foot per hour, or 125 tons in twenty-four hours. The excess of this work under alcohol in varying quantities formed a corollary to the history of the work of the heart, Parkes's calculation showing an excess of 24 foot-tons from the imbibition of eight fluid ounces of alcohol. The facts relating to the work of the heart by the weight of work accomplished was supplemented by a new calculation, in which the course of calculation was explained by mileage. Presuming that the blood was thrown out of the heart at each pulsation in the proportion of 69 strokes per minute, and at the assumed force of 9 feet, the mileage of the blood through the body might be taken at 207 yards per minute, 7 miles per hour, 168 miles per day, 61,320 miles per year, or 5,150,880 miles in a lifetime of eighty-four years. The number of *beats* of the heart in the same long life would reach the grand total of 2,869,776,000.

A METEOR of unusual splendour was seen from the Oxford Road, Banbury, on Tuesday, November 2, at about 8.5 p.m. The fall became visible at about mid-distance between zenith and horizon in a direction west by north. At first the meteor burned with a faint, apparently reddish, light, but when a third of its path had been passed, it burst into an intense blue flame, and, increasing in brilliancy during the next third of its course, it finally died away before reaching the horizon, leaving behind it a long red trail distinguishable for several seconds afterwards. The fall was at an angle of 60°, and during the middle third of the flight the flame was of such intensity as to light up the surrounding country.

REFERRING to a paper at the Paris Geographical Society by Dr. Hamy on "The Interpretation of one of the Monuments at Copan, Honduras," in which an inference is drawn as to early Chinese intercourse with America, Dr. W. H. Dall, writing to *Science*, states his belief that the very wide hypothesis thus broached, and which in one form or another has had a certain currency for more than a century, rests upon a totally insufficient foundation. That wrecked Japanese, and possibly Chinese, from time to time were cast on the shores of America, is beyond question. But there is every reason to believe that the wrecked people were (1) nearly always males, and incapable of colonising; (2) were either killed or enslaved by the Americans in accordance with a general usage; and (3) that neither in arts nor language have they left any appreciable trace on American anthropology. "The statement of Brooks, that the Japanese and Aleuts could communicate without an interpreter, is true to this extent. I was present when the aforesaid Japanese, three males, were brought to the port of Unala-hka, and took pains to inquire into the assertion which was made to me at the time. I found that the communications were wholly by signs, and not by spoken language, as the Aleuts could not understand a word of Japanese without its accompanying signs. Secondly, Brooks, who was long Consul in Japan, informed me that he had particularly searched into the matter of the voyage to Fu-sang, and that he had conclusive evidence that the voyage which actually took place was to the well-known and still existing province of Fu-sang in Korea (see Griffis' work), and had no connection whatever with America. Lastly, the mere presence of two simple curved lines on a circular stone, taken by itself, proves nothing as to their meaning, and still less that they had any connection with the Chinese symbol." Dr. Dall concludes by stating that such unbridled hypotheses are the "curse of anthropology."

We have received a fresh instalment of the very valuable work emanating from the firm of Eduard Trewendt, Breslau:

the now well-known "Encyclopædia of Natural Sciences," namely, Nos. 48 and 49 of the first part, and 37 and 38 of the second part. These four numbers deal with three different branches of science. No. 48 of the first part is botanical, a continuation of Drude's masterly work, "Systematic and Geographical Arrangement of the Phanerogams," copiously illustrated with woodcuts, as was the earlier portion of the same publication. No. 49 of the "Alphabetical Manual of Zoology, Anthropology, and Ethnology," takes the reader from "Landschaft" to "Lithodina." Of the abundant material embraced in this compass may be particularly mentioned "Landschnecken," by E. von Martens; "Larven," by Dr. Griesbach; two especially interesting contributions, "Larynx," by von Mojsi ovics, and "La Tène-Zeit," by Mehlis; treatises by Jaeger on "Life, and its Conditions, Phenomena, and Stimulations, &c.," as "Linsen," and "Lippen," by Dewitz. Nos. 18 and 19 of the second part belong to the "Alphabetical Manual of Chemistry," containing the papers—Furfurgruppe (conclusion), Gährung, Galle, Gallium, Gehirn, Gerberei, Gerbsäuren or Gerbstoffe, Germanium, Glas, Glycerin, Glycidsäuren, Glycocoll, Glyc side. As of most general interest in this list of articles may be specially cited "Glycoside," by Prof. Oskar Jacobsen, of which the firm is preparing a separate impression; as also "Gährung," by Tollens; and "Glas," by Engler. The newly-discovered "Germanium" is treated by the editor, Herr Ladenburg himself. In Prof. Liebrich's contribution, "Gehirn," we have valuable paper on this subject by a recognised authority.

TWO remarkable specimens of deformed fish were taken from a rearing-pond at Delaford this week, and brought to the South Kensington Aquarium. One is a trout about three years old, whose tail is bent to such an extreme that it stands at right angle with the body of the fish. Its mode of progress is laboured, and its appearance is very peculiar. The other specimen is an ordinary stickleback, measuring 4 inches in length, whose body is swollen through dropsy to the extent of 1 inch in diameter. At first sight its appearance is similar to a young mouse, and it requires close inspection to grasp the fact that it is a fish. It moves very slowly, with great expenditure of force, the weight of the contorted body being considerable.

THERE has been a great demand for the German carp lately imported into this country by the Marquess of Exeter and others for the purpose of acclimatisation in this country, and a numerously expressed desire to stock waters that are useless for the purpose of maintaining other fish than carp has been made for the German species.

THE operations in connection with the new Observatory and Marine Fish-Culture Station at Lochbuie, Isle of Mull, to be established under the auspices of the National Fish-Culture Association, are to be commenced forthwith. At a meeting of the Council, held last week, it was arranged to form ponds for the propagation of lobsters, and to make certain observations upon marine fauna. The details of the scheme were placed in the hands of a special scientific committee.

WE have received from Messrs. Horne, Thornthwaite, and Wood, opticians, a map of the moon, 12 inches in diameter, mounted on good stout cardboard, represented as she appears when viewed through a telescope with an astronomical eyepiece. This will be a very useful companion and guide for those amateurs who are studying the lunar surface; it can be conveniently held in the hand while observations are being made. About 300 craters and walled plains are marked very clearly, and the names of the different seas are given in larger letters. At the back is added a short description of some of the chief features.

A SHOCK of earthquake was felt in the district of Beira Alta on the 11th inst.

THE additions to the Zoological Society's Gardens during the past week include a Patas Monkey (*Cercopithecus patas*), from West Africa, presented by Mr. Thomas Baily; a Yellow Baboon (*Cynocephalus babuin*), from West Africa, presented by Capt. J. Henderson Smith, R.A.; two Goshawks (*Astur palumbarius*), European, presented by the Baron d'Epresnil; a Hobby (*Falco subbuteo*), caught in the Indian Ocean, presented by Dr. Rivis Mead; two Java Sparrows (*Padda oryziavora*) from Java, four St. Helena Seed-Eaters (*Crithagra butyracea*), from South Africa, presented by Mrs. Conrad Pile; two Sing-sing Antelopes (*Cobus sing-sing* ♂ ♀), from West Africa, received in exchange; a Woodcock (*Scopolax rusticula*), European, purchased; an Ocelot (*Felis pardalis*) from America, a Bactrian Camel (*Camelus bactrianus* ♀) from Central Asia, two White-backed Piping Crows (*Gymnokitta leucanota*) from South Australia; a Banded Parrakeet (*Palaornis fasciatus* ♂), from India, deposited; a Vinaceous Turtle Dove (*Turtus vinaceus*), bred in the Gardens.

OUR ASTRONOMICAL COLUMN

THE INFLUENCE OF ASTIGMATISM IN THE EYE ON ASTRONOMICAL OBSERVATIONS.—Prof. Seeliger has published, in the *Abhandlungen der k. bayer Akademie der Wiss.*, ii. Cl., xv. Bd., 3 Abth., an interesting paper on this subject. The paper is divided into four sections. The first part treats of certain details connected with the refraction of light which are used in the subsequent investigations. The second part gives the theory of the formation of images in an astigmatic eye, and its application to measures made with an altitude instrument. In the third and fourth parts the author treats of the application of his theory to the heliometer and wire-micrometer respectively. It appears, from Prof. Seeliger's researches, that this malformation in the eye, which is far from uncommon, exerts a larger influence on astronomical measurements than is commonly supposed. Thus, he shows that a systematic error in a series of observed declinations amounting to 0".26 may very well be due to it. And it appears that the discordances in observed position-angles of double stars, depending on the inclination of the line joining the components to the vertical, with which the measures of some observers are affected, may in part be referred to the same cause. Prof. Seeliger's paper is one which may be profitably studied by those who aspire to the attainment of greater accuracy in astronomical observations.

THE KALOCSA OBSERVATORY.—Dr. C. Braun has recently published a report of this Observatory, founded by Cardinal Haynald, Archbishop of Kalocsa. The equipment of the Observatory consists of a refractor, by Merz, of 7 inches aperture; another of 4 inches; a transit by Cooke, aperture 2.3 inches; an altazimuth by Breithaupt, of Cassel; a chronograph, three clocks, and a chronometer; several spectroscopes, of which a large solar spectroscope with automatic adjustment to minimum deviation is the principal; a star photometer by Zöllner, and a spectro photometer by Vogel and Glan. The two most important works effected at the Observatory have been the determination of the geographical position of the Observatory, and the observation of sunspots. A special value attaches to the former, as hitherto the position of no place in Hungary had been fixed by direct astronomical methods. The latitude of the standard pillar of the Observatory was determined by geodetic observations to be 46° 31' 41".92; the astronomical methods made it 0".07 greater. The longitude was found to be sh. 15m. 54".343s. east of Greenwich. The observations of sunspots extend from May 14, 1880, to January 31, 1884, and form a useful record of an interesting period. The method of projection was employed in observing; the observations were reduced first by means of a projection of the sun, and secondly by calculation. In the latter method Dr. Braun employed an instrument of his own device, which he terms a trigonometer, for the direct solution of spherical triangles. From his observations Dr. Braun deduces the following expression for the velocity of rotation:— $865^{\circ}.33 - 209^{\circ}.85 \sin^2 \lambda$. He also shows the downward tendency in latitude of the mean spotted area, and points out the

curious partial effort at recovery which shows itself at tolerably regular intervals. The observations of each rotation are grouped together and given in short tables, and diagrams similar to Carrington's, showing the spots of each rotation in shape and position, are also added. The volume concludes with full descriptions of a number of ingenious instrumental devices, some actually employed at Kalocsa, others still only projected. Amongst these is an ingenious transit micrometer for eliminating personal equation in the observation of transits.

♄ CASSIOPEIÆ.—The *Sidereal Messenger* reports, on the authority of Prof. Colbert of Chicago, that this star appeared to increase its brilliancy by quite half a magnitude on the night of August 20. The most remarkable point of the observation was the shortness of duration of the phenomenon: for, about half an hour after it was first noticed, the star began to return to its normal magnitude. It will be interesting to learn if the change was observed elsewhere.

NEW MINOR PLANETS.—Prof. Peters discovered a new minor planet, No. 261, on October 31, and Herr Palisa two—Nos. 262 and 263—on November 3.

COMET FINLAY.—The following ephemeris for Berlin midnight is in continuation of that given in NATURE for November 4 (p. 17):—

1886	R.A.		Decl.	log r	log Δ
	h.	m. s.			
Nov. 16	19	59 51	23 22' 7" S.	0.0697	0.0899
18	20	8 42	22 53' 7"		
20	20	17 38	22 22' 4"	0.0589	0.0874
22	20	26 37	21 48' 8"		
24	20	35 39	21 13' 0" S.	0.0693	0.0856

COMET BARNARD.—The following ephemeris for Berlin midnight is given by Dr. E. Lamp (*Astr. Nachr.*, No. 2753):—

1886	R.A.		Decl.	log r	log Δ	Bright-ness
	h.	m. s.				
Nov. 18	13	16 59	13 12' 4" N.	9.9433	0.0637	10.8
20	13	31 51	14 5' 9"	9.9306	0.0485	12.3
22	13	47 57	14 58' 3"	9.9180	0.0340	13.9
24	14	5 20	15 47' 7"	9.9055	0.0207	15.7
26	14	24 2	16 32' 5"	9.8934	0.0089	17.5
28	14	43 57	17 10' 3"	9.8817	0.9990	19.3

The brightness at the time of discovery is taken as unity.

GOULD'S "ASTRONOMICAL JOURNAL."—The first number of the new issue of this journal appeared on November 2. It contains the following papers:—On the light-variations of Sawyer's variable in Vulpecula, by S. C. Chandler, Jun., in which the elements of the star are given as Max. = 1885 Nov. 2d. 20h. 35m. G.M.T + (4d. 10h. 29m.) E. The minimum is 1.060d. earlier. The rapidity of the rise is a striking characteristic of this star.—A new short-period variable, by E. F. Sawyer. The star, 57 Sagittarii, has a period of not more than 6 days; the variation is from 5.6 mag. to 6.6. Place for 1875.0, R.A. 18h. 14m. 2s.; Decl. 18° 54' 8".—Elements and ephemerides and observations of Comets Finlay and Barnard, by Profs. Winlock, Boss, and Frisby.—Observations of U Ophiuchi, by E. F. Sawyer; and the first part of a paper on the lunar theory, by Prof. Stockwell.

ASTRONOMICAL PHENOMENA FOR THE WEEK 1886 NOVEMBER 21-27

(FOR the reckoning of time the civil day, commencing at Greenwich mean midnight, counting the hours on to 24, is here employed.)

At Greenwich on November 21

Sun rises, 7h. 31m.; souths, 11h. 46m. 3".1s.; sets, 16h. 1m.; decl. on meridian, 19° 58' S.; Sidereal Time at Sunset, 20h. 3m.

Moon (New on November 25) rises, 1h. 37m.; souths, 8h. 4m.; sets, 14h. 18m.; decl. on meridian, 1° 57' N.

Planet	Rises		Souths		Sets		Decl. on meridian
	h.	m.	h.	m.	h.	m.	
Mercury	9	30	13	11	16	52	25 2 S.
Venus	7	12	11	35	15	58	13 46 S.
Mars	10	33	14	18	18	3	24 32 S.
Jupiter	4	15	9	34	14	53	8 45 S.
Saturn	19	34	3	36	11	38	21 22 N.

* Indicates that the rising is that of the preceding evening.

Occultations of Stars by the Moon (visible at Greenwich)

Nov.	Star	Mag.	Disap.	Reap.	Corresponding angles from vertex to right for inverted image
			h. m.	h. m.	
22 ...	46 Virginis ...	6 ...	4 42 ...	5 31 ...	72° 17'
22 ...	47 Virginis ...	6 ...	4 58 ...	near approach	304 —
22 ...	48 Virginis ...	6 ...	6 36 ...	7 8 ...	104 163
23 ...	B. A. C. 4647 ...	6 ...	4 42 ...	5 40 ...	24 222

Nov.	h.	
23 ...	1 ...	Jupiter in conjunction with and 3° 0' south of the Moon.
23 ...	14 ...	Mercury stationary.

Variable Stars

Star	R.A.		Decl.		h. m.
	h. m.	...	h. m.	...	
U Cephei ...	0 52.2	...	81° 16' N.	...	Nov. 28, 2 27 <i>m</i>
ζ Geminorum ...	6 57.4	...	20 44 N.	...	" 23, 21 30 <i>M</i>
S Canis Minoris ...	7 26.5	...	8 34 N.	...	" 24, <i>M</i>
S Sagittarii ...	19 12.8	...	19 14 S.	...	" 21, <i>M</i>
η Aquilæ ...	19 46.7	...	0 43 N.	...	" 24, 0 0 <i>M</i>

M signifies maximum; *m* minimum.

Meteor Showers

The *Andromedes*, maximum November 27, R.A. 24°, Decl. 44° N., form the most interesting shower of the week. A radiant near μ Persei, R.A. 60°, Decl. 49° N., supplies very swift meteors; swift meteors are likewise seen from a radiant near η Ursæ Majoris, R.A. 208°, Decl. 43° N.

GEOGRAPHICAL NOTES

THE *Bulletin* of the Paris Geographical Society for the present year (Nos. 1 and 2) contain several papers of interest. We need do no more than mention M. Ch. Mannoir's annual report on the progress of geography during the past year, which fills 130 pages. M. Grandidier writes on the rivers and lagoons of part of the east coast of Madagascar, and M. Gouin, of Nam-dinh, contributes a long paper on Tonquin, which deals with the commercial geography of the country rather than with the geography proper. No. 2 opens with the report of a strong Committee of the Society on the orthography of geographical names, which will be read with interest. No elaborate or exhaustive reforms are proposed; the suggestions are rather a series of simple modifications "based on good sense rather than on high philological science, which is only accessible to the few initiated." The Committee take up the programme of the Royal Geographical Society, "completing it in some respects, and making some additions sensible to musical ears." The bases of the proposals are the same as those of our own Society: (1) not to seek an absolute perfection in the representation of sounds; (2) to preserve in European names the form of the country of their origin; (3) to retain in the case of other places the mode commonly employed. M. Rolland contributes a long paper on the hydrography and orography of the Algerian Sahara; and M. Marteil examines the map of the French establishments on the Senegal recently issued by the Ministry of Marine. Lieut. Baudens describes a trip which he made last year along the Black River of Tonquin; and finally there is an account written by Dr. Potagos in 1880 of a journey which he made in the Pamir in 1870, including a visit to the famous Yakub Beg of Kashgar.

WE have received the *Verhandlungen* (Bd. xiii. No. 8) and the *Zeitschrift* (Bd. xxi. Nos. 4 and 5) of the Geographical Society of Berlin. The first contains only one paper, but that an interesting one, by Dr. Sievers, on a recent journey in the Sierra Nevada de Santa Marta, in Columbia. The object of the journey was to study the geology and physical geography of the region, and especially to ascertain whether these mountains belong to the system of the Andes or not. As Dr. Sievers has only been back for a short time, he was unable to give any definite results, and he confines himself to describing the course of the journey, and to mentioning important points necessary for a proper understanding of the physical geography of the region. In the *Zeitschrift*, Herr Jung continues and concludes his analysis of the Indian census of 1881; this is followed by a translation, from the *Proceedings* of the Russian Geographical Society, of Dr. Iwanow's paper on certain ancient monuments discovered by him in the course of a geological examination of Turkestan. Prof. Geleisch has a highly technical history of the

methods of ascertaining the area of a country, and Dr. von Danckelmann one on the frequency of rain in the Indian Ocean. Herr Sandler makes a contribution to the history of cartography by giving an account of the life and works of Johann Baptist Homann, a geographer of the latter part of the seventeenth century. A curious map appended to this paper (which is of considerable length) shows, by means of white and red outlines the world according to present cartography and according to Homann's maps. The number concludes with a short paper on the hot springs of Kamchatka.

IN a recent work on the geology and geography of Sumatra M. Verbeek, a Dutch engineer, says that sixty-seven volcanoes are known to exist on that island. There may be more even than this, for parts of the north-west, which are covered with primæval forests, have never been penetrated. Two only of these are active, Merapi and Talang (or Soclau), the former being 2892, and the latter 2542 metres in height.

THE October issue of the *Bollettino* of the Italian Geographical Society contains an account of an excursion made during the summer by E. Modigliani to the rarely visited island of Nias which lies some thirty miles from the west coast of Sumatra, little north of the equator. The explorer spent two months in the place, but owing to local feuds was unable to penetrate beyond Fadoro, a large village near Telok Dalam Bay on the south side. The natives, apparently of Malayan or Indonesia stock, but speaking a language quite different from Malay, and by Crawford described as "a simple, mild, and primitive people, he found on the contrary to be fierce and treacherous savages everywhere addicted to head-hunting. Their hostility was such that he failed to make any botanical or zoological collections but fortunately secured eleven human skulls from the southern districts, which have been sent to the Anthropological Museum of Florence. No similar specimens appear to have hitherto reached Europe, nor are any found even in the Batavian collection. Head-hunting is taken so much as a matter of course, the on Sig. Modigliani offering to purchase some skulls, the rajah of Bavalovalani on the south coast quietly remarked that it would be rather an expensive business, as an expedition would have to be specially fitted out and sent to the hills to raid upon some neighbouring tribes and carry off the required number of heads. He had no idea of craniological specimens being collected except from the living subject. The interior of Nias still presents a promising field of exploration, never having been visited by an European traveller.

LIGHTHOUSE ILLUMINANTS¹

II.

V.—Range of Lights in Hazy Weather

THE observations on this subject of the Trinity House Committee have served to confirm the conclusions announced by M. Allard in his "Mémoire sur l'intensité et la portée de phares," 1876, and in his more recent "Notes sur quelques objections relatives à l'emploi de la lumière électrique dans les phares." The Committee find that the gas and oil lights which are equal in clear weather are equal also in fogs; that in rather dense fog the more powerful light had but little advantage over the less powerful, for example, "the triform electric appeared at 1500 feet, while the quadriform gas and triform oil showed together a little before the observers reached 1400 feet," and that the electric light, while suffering, according to the photometric results, a somewhat greater loss in hazy weather than the flame lights, is "visible at a greater distance than the highest powers tried in gas or oil." Using M. Allard's formula, which appears to rest on well-established physical and physiological data, I have calculated the range in fogs of various degrees of thickness of some of the lights exhibited at the South Foreland. The range of a light, or the limit at which it is just lost or just picked up, is that limit at which its intensity diminished by distance and haze to the minimum intensity perceptible by a good eye, such as the practised eye of seamen and M. Allard gives this minimum intensity, on the authority of "des expériences qui ont été faites sur ce sujet au Champ de Mars," as that of 1/100 Carcel at a distance of one kilometre or a perfectly clear night. This corresponds to $\frac{1}{2}$ candle at a distance of one nautical mile. When the air is not perfectly clear

¹ Further Report of Mr. Vernon Harcourt to the Board of Trade of the Experimental Lights exhibited at the South Foreland. Continued on p. 61.

its degree of transparency may be expressed by stating the fraction of light which escapes obstruction in passing through a certain length. Of this fraction the same fraction escapes obstruction in passing through another equal length of air, and so forth. Thus, if this fraction is called a , and l is the intensity at any point of a beam of parallel rays, such as a beam of sunlight reflected from a plane mirror, after the beam has traversed a mile of hazy air its intensity is diminished to la , at two miles its intensity is diminished to la^2 , and at a distance of d miles to la^d . But divergent light, such as is even the most condensed beam from a lighthouse, diminishes also as the square of the distance. Thus, if L is a lighthouse light whose intensity at one mile is La , its intensity at any number of miles, d , is $La^d \times \frac{1}{d^2}$ and

when the combined effect of haze and distance is such that its intensity is only equal to that of $\frac{1}{2}$ candle as one mile, at that point the light ceases to be visible. Thus it is possible to calculate for any particular degree of haze what will be the range of any given light. To give some examples:—In a moderate uniform haze such that a single 108-jet gas-burner, showing as a fixed light of about 14,000 candles, was lost at a distance of 10.9 miles, the same light shown in biform would be lost at 11.8 miles, while the corresponding triform and quadriform lights would be lost at 12.5 and 12.8 miles respectively. In a rather thicker haze, in which a single 108-jet gas-burner, showing as a revolving light of 60,000 candles, was visible up to 10 miles, but no further, the extreme range of the biform would be 10.73 miles, of the triform 11.16 miles, of the quadriform 11.48 miles. In still thicker haze the increase of range obtained by increasing the power of the lighthouse light becomes not only absolutely but relatively less.

Light shown	M. I. lens	...	2	...	1	...	0.5
Single 108-jet	"	...	2.11	...	1.05	...	0.52
Biform	"	...	2.17	...	1.08	...	0.54
Triform	"	...	2.22	...	1.1	...	0.55
Quadriform	"	

The above results represent the maximum range of the direct beam through uniform haze of lights of the same kind but varying in power. But in certain cases the increase of range gained by increasing the power of the light may be either less or greater than it is in the foregoing case.

In the first place, the light which has suffered obstruction is diverted from its direct course but is not lost; and a portion of this light may reach the eye from a direction slightly different from that of the source of light, producing the impression of a halo or burr. Prof. Stokes, Pres. R.S., who has kindly given me much help in considering this subject, concludes that, especially in a fog in which the particles of water are not very minute, the burr might be seen at a substantially greater distance than that at which the direct light could be seen. "The intensity of this diffused light will not decrease in geometric progression as the distance from the source increases, but rather will tend ultimately to decrease inversely as the square of the distance; but being so widely spread, there will be danger of its being unperceived unless it be flashy." In this case the more powerful lights would retain in fog more nearly the advantage which they possess in clear weather, in which a fourfold light has double the range of a single light. But since the eye can distinguish between the point of light which is seen by the direct rays and the blurred nimbus, whose properties Prof. Stokes has investigated, the question whether the range of powerful lights is materially increased by the diverted and re-diverted light which surrounds the principal beam could be solved by an appeal to experience.

In answer to my inquiry whether it often happens that in approaching a lighthouse on a hazy night that which is first seen is an indistinct brightness or halo, not the light itself, and whether this effect is seen at considerable distances or only at short distances, and in what kind of fog, the Deputy Master of the Trinity House tells me that it happens, occasionally, at short ranges, in thick fog or mist, when nothing of the light is seen beyond 1 or 2 miles. "In clearer weather (*i.e.*, slight haze) this peculiarity is not observable at any range; it is the direct beam from the lantern (of course lessened and indistinct by reason of the density of the atmosphere) which then comes to the eye of the observer when approaching from seaward." I think, therefore, it may be concluded that at short distances powerful lights may occasionally have an advantage over feebler lights greater than is indicated by M. Allard's formula, in consequence

of the scattered light being less diminished by fog than the direct light.

There are two other cases in which the formula is not immediately applicable; the second exception being, if the haze is not uniform. This case may be illustrated by taking an extreme example. Suppose that the amount of fog extending 5 miles from a lighthouse were just sufficient to extinguish a light of 60,000 candles, and that beyond this distance the air were perfectly clear, a light of four times the initial power would have at the margin of the fog four times the minimum visible brightness, and would only disappear altogether at a distance of 10 miles. But, on the other hand, if the fog were thicker further to seaward, the larger light would have scarcely any advantage over the smaller light.

Thirdly, if the lights compared differ in quality, of which the visible sign is colour, as well as in power. In this case the particles of water of which haze at sea consists (differing from the coloured particles of a London fog) are only likely to exercise a selective action on lights of different refrangibilities when the particles are so small as to be comparable with a wave of light. In a thick mist, in which the particles of water have often a visible magnitude, this effect is probably absent. Clouds are of this character, and sunlight is not reddened by passing through them. But the red colour of the sun when near the horizon, and the assimilation in colour of the electric light to gas-light when seen from a distance through slight atmospheric haze, shows that such haze does interfere with the more refrangible blue rays, to a greater extent than it does with the yellow, orange, and red rays. It is therefore certain that the electric light, which contains a relatively large proportion of the more refrangible rays, suffers a greater loss than the light from gas or oil flames in certain states of the atmosphere. The larger particles of mist or rain probably obstruct light of all sorts in the same degree. If we suppose that the effect of haze is to cut off all the blue and violet rays, the loss to the flame lights would not exceed 1 or 2 per cent., while that of the electric light, which is perhaps rather bluer than sunlight, may amount to 20 per cent. But this loss, though considerable, would not materially affect the range of the electric light in hazy weather.¹

It has been claimed as an advantage of multiform lights, compared with the electric arc behind a small lens, that the larger surface of illuminated lens is more favourable to visibility in hazy weather; and the late Sir W. Siemens gave some countenance to this view. Speaking in the discussion of Sir James Douglass's paper "On the electric light applied to lighthouse illumination," 1879, he said:—"He had held that, in order to get more penetrating power, not intensity alone, but intensity with quantity as represented by large surface, would be required." M. Allard in his "Note," pp. 10 and 11, makes some interesting observations on this subject, but deals rather with visibility at great distances in clear weather than with visibility through haze. I do not know on what grounds, either of theory or observation, the opinion formed by Sir W. Siemens is based. Desiring further information on this and some other points, I have consulted Lord Rayleigh, Sec. R.S., who with Prof. Stokes joined me in a visit to the South Foreland lights a year ago. I may quote his opinion:—"With the same total brightness of source, and angle of divergence, it can make no difference at a distance (at which the apparent magnitude of the lens is inappreciable), whether the lens be large or small. At smaller distances the advantage might be with the smaller lens. So far as I see, the only advantage that the large lens could ever have would be more room for a bulky light, which, with a small lens, might give too great a divergence."

While referring to the assistance I have received from Prof. Stokes and Lord Rayleigh, to whom I desire to accord my thanks, I should mention that I have received from both the same emphatic suggestion, that further trial should be made of sudden flashes in fog. Lord Rayleigh writes: "I should like to see proper experiments tried on sudden and periodic flashes, such as might be produced by gunpowder, the periodicity serving for identification and the intermittence being necessary to

¹ Since this report was written, a paper has been communicated to the Royal Society by Captain Abney, R.E., F.R.S., and Major-General Festing, R.E., F.R.S., giving the result of measurements of the illuminating power of different parts of the spectrum of the electric arc. According to these measurements, the illuminating power of that part of the light from the electric arc which lies beyond the line "E" in the spectrum, including the greater part of the green rays as well as the blue and violet rays, is rather less than one-sixth of the total illuminating power.

get the necessary contrast, which is here between appearances at consecutive *times*, instead of as in ordinary vision between appearances in neighbouring *directions*."

Prof. Stokes writes, on various occasions:—"The diffused light of a powerful lamp would be weak and perfectly steady, and might thus escape notice, while a diffused light, even though no stronger, if almost momentary like lightning might be sufficient to attract attention, and you could afford to throw great chemical force into the formation of a flash which was to last only, as it were, for a moment." "If there are to be any more experiments, I think it would be well worth while to try explosions." "The more I think of it the more disposed I am to think that it would be worth while to try some experiments with flashes, I mean with explosions. The plant would not be at all costly; in fact, it would hardly cost anything. The chemicals would not cost very much. Preliminary experiments on a small scale, which could be tried anywhere, would show what chemicals were good to use in order to get a flash as bright as may conveniently be. But when the actual experiments in fog are tried, the quantity used should not be by any means very small. It should be enough to make the quantity of light for the moment much greater than what was kept up in your most powerful burners; but that would not require a very large quantity."

I should add that Prof. Stokes is aware that "flares" have been tried and used, but is clearly of opinion that further trials should be made in that direction. As to the great effect of sudden illumination in attracting attention there can be no doubt; but I find it hard to believe that in a fog in which an observer at a small distance was unconscious when the beam from the electric arc, through such a lens as the Mew Island lenses, passed quickly across him, any "flare" would be perceptible at the same distance. I do not know whether the experiment has been tried of combining a light-and-sound signal, by placing the materials used to produce a flash together with a charge of compressed gun-cotton in the head of a rocket, and so firing the rocket that it would explode at a fixed distance and bearing from the station and at a moderate altitude. A rocket will go through any fog, and might be used to give a lift seaward to the light and sound.

VI.—Cost of each System

I have not the data which are necessary for forming an independent opinion upon the estimates furnished in the Trinity House report. These estimates rest on unexceptionable authority; and I only venture to make any remarks on the subject because I am not entirely satisfied with the position assigned to the electric light.

I gather from the reference to the photometric results of Mr. Valentin that in a former estimate the cost was considered in relation to the yield of light by each illuminant. And I think that an estimate of what light can be had on any system for a given expenditure, or what the cost is on any system of a desired quantity of light, is needed to make the comparison of the relative cost complete. For example, a comparison is made in the Report (Tables I. and II., pp. 62-63), between a "first order oil-lighted tower for one six-wick burner only," and a "gas station to show a quadriform light of four times 68-jet power." The annual cost of maintenance, including interest on capital outlay, is estimated at 724*l.* for the first, and 1687*l.* for the second. But the light from a six-wick burner shown as a fixed light is probably rather less than 7000 candles, while that from the 68-jet quadriform is 35,000 candles. Thus, if such a quadriform were substituted for or adopted instead of the single light, both the cost and the light would be largely increased, but the increase of light would be more than double the increase of cost. Comparing the two as revolving lights, the increase of light would be one-third greater than the increase of cost. So in the comparison between the cost of the electric light and the other illuminants. The expense of annual maintenance, with interest on capital outlay, is estimated as being one-seventh greater for the electric light than for the quadriform 68-jet gas; but if the yield of light is taken into account, the figures appear very differently. The electric light is ten times as powerful as the quadriform. The actual cost of light, which is the commodity produced, may be compared in the two cases by stating the cost of maintaining for one year each 1000 candles intensity of light in the beam sent forth. By the electric arc the cost is about 1*l.*, by the quadriform gas 8*l.* 10*s.*

As to the actual estimate of the cost of the electric light, I

venture to suggest that some reduction may be found practicable. Two engines of 30 horse-power, at a cost of 1250*l.*, seems a very full provision for the unfailing maintenance of one arc light. The actual horse-power absorbed by one of the De Méritens machines is given by Prof. Adams as 10*·*4. M. Allard states the price of one of M. de Méritens' machines, tested and recommended by him in 1880, as 350*l.* Dynamo-machines are, I believe, less costly. I think all that is needful and best of machines, lamps, and cables, may now be obtainable for less than 2154*l.*; and the estimate of 1217*l.* a year for wages, clothing, coke, oil, carbons, &c., and repairs and renewals, may perhaps be found in excess of the necessary cost. M. Allard gives the following details of the cost of the apparatus and expenses at Grisez:—

Two steam-engines of from five to six horse-power ...	488
Two magneto-electric machines	852
Four lamps	240
Total	1580

Annual expenses 537

He also furnishes an estimate, which I transcribe, of the average cost of converting an oil lighthouse into an electric lighthouse:—

Engine-house, keepers' dwellings, water-supply, &c. ...	1600
Two steam engines, of from six to eight horse-power, with shafting and straps	640
Two electric machines with cables, &c.	560
Four lamps	240
First order lantern with oblique framing	800
Optical apparatus, two feet in diameter, with arrangements for revolving light	520
Sundries, packing, carriage, and setting up	240
Contingencies	400
Total	5000

Add "First cost of an ordinary first order oil-lighted tower" (T. H. Report, Part I., p. 75), less "Apparatus, lantern and glass," viz. 4834*l.*; and it would seem to follow that the first cost of an electric light station need not exceed 10,000*l.*

The rather large difference between this estimate and that of 17,749*l.* furnished by the Trinity House Committee has no doubt already received the consideration of the Elder Brethren, who have had the details of M. Allard's scheme before them.

In order to obtain some further information, I have inquired of a London firm of electric light contractors as to the cost of such an installation, and have received the following figures:—

Two 30 horse-power <i>effective</i> engines	700
Three lamps, necessary cable, and labour	400
Two dynamos and spare armature to fit either	480

It will be seen that these figures are not very different from those of M. Allard's estimate.

In concluding this report I desire to thank the Elder Brethren of the Trinity House, and especially the Members of the Committee, for the kindness which has made the duty of co-operating with them in this inquiry a continual pleasure.

March 9, 1886

A. VERNON HARCOURT

Letter to the Board of Trade from the Commissioners of Northern Lighthouses

Northern Lighthouse Board, 84, George Street,
Edinburgh, December 10, 1885

SIR,—I am directed by the Commissioners of Northern Lighthouses to acknowledge the receipt of your letter of the 3rd instant, in which you request to know whether the Commissioners propose to make any general report or observations relative to the recent Lighthouse Illuminants Experiments at the South Foreland.

In reply I am directed to state that in view of the very able and exhaustive Report (Part I.) by the Committee of the Elder Brethren on this subject, in the conclusions of which the Commissioners concur, and of the report by their engineers dated October 14 last, which accompanied my letter to the Elder Brethren of the following day, and copy of which is herewith transmitted for the information of the Board of Trade, the

Commissioners do not propose, at least in the meantime, to make any general report or further observations in regard to these experiments.—I am, &c.,

(Signed) J. M. DUNCAN

The Assistant Secretary, Harbour Department,
Board of Trade

Report on Part I. of Report by the Special Committee of the Elder Brethren on Lighthouse Illuminants, by T. and D. Stevenson, Engineers, to the Northern Lighthouse Board

On September 2 last, the Board remitted to us, for consideration and report, Part I. of the Report of the Committee of the Trinity House, on the experiments at South Foreland, and having perused the reports of the experiments, we now beg our report as follows:—

As the Board is aware, the object of these experiments was to determine the relative merits of gas, oil, and electricity, as lighthouse illuminants, especially as regards their penetrative power in fog; also to ascertain the merits of certain optical arrangements, and test certain improved oil and gas burners patented by Sir James Douglass and Mr. Wigham. We think that these experiments embrace all the suggestions that were brought under the notice of the Elder Brethren for trial by the Board of Trade, and which led that Board to suggest that this train of experiments should be entered upon.

We have had several opportunities of inspecting the various kinds of apparatus, and also of witnessing the experiments, and in our opinion these experiments have been of an exhaustive character, and have been conducted with great care, and, we believe, in a spirit of the most perfect fairness and impartiality to all parties; and we have further to express our concurrence in the conclusions of the Committee as expressed in the following terms:—

“(1) That the electric light, as exhibited in the A experimental tower at South Foreland, has proved to be the most powerful light under all conditions of weather, and to have the greatest penetrative power in fog.

“(2) That for all practical purposes the gaslight, as exemplified by Mr. Wigham's multiform system in B experimental tower, and the oil light, as exemplified by the Trinity House Douglass six-wick burners in multiform arrangement up to triforium in C experimental tower, when shown through revolving lenses, are equal, light for light, in all conditions of weather; but that quadriform gas is a little better than triforium oil.

“(3) That when shown through fixed lenses, as arranged in the experimental towers, the superiority of the superposed gas light is unquestionable. The larger diameter of the gas flames and the lights being much nearer to each other in the gas lantern, give the beam a more compact and intense appearance than that issuing from the more widely separated oil burners.

“(4) That for lighthouse illumination with gas, the Douglass patent gas-burners are much more efficient and economical than the Wigham gas-burners.

“(5) That for the ordinary necessities of lighthouse illumination, mineral oil is the most suitable and economical illuminant, and that for salient headlands, important landfalls, and places where a very powerful light is required, electricity offers the greatest advantages.”

We may explain that so far back as 1869 we had also occasion to conduct a series of experiments at Edinburgh on certain large burners patented by Mr. Wigham, and brought before the Board, with the view of increasing the power of sea lights, and again in 1870 a further series of experiments was carried out by us, by the direction of the Board of Trade, on the merits of the electric light, and certain important results were obtained during these sets of experiments at Edinburgh. The general result of the gas experiments then made was that the large 52-jet gas-burner was in no way superior to the 4-wick oil-burners when used in connection with the ordinary annular lens, as the “greater portion of the 7-inch gas flame” was with that size of lens necessarily ex-focal. The large burner was slightly superior, however, when used in a fixed light apparatus. Our opinion, which has been corroborated by the recent experiments, therefore, was that in order to bring out the full power of these large flames, an apparatus of larger focal distance than usual must be employed, and hence we designed the lens of 1,330^{mm} radius, which has recently been tried at the South Foreland with the most satisfactory results.

The electric light experiments made at Edinburgh in 1867–1869, showed that if the electric light beam was made to

diverge artificially to the same extent as the 4-wick oil flame, it was in no way superior in brilliancy, and pointed to the advisability of adopting for the electric light the azimuthal condensing system of Mr. Thomas Stevenson. This system has been adopted for the electric light apparatus at the South Foreland experiments. The Edinburgh experiments further showed that it was necessary in any test of the intrinsic merits of electricity, gas, or oil, that the maximum condensation consistent with the requirements of navigation for each should be employed. At the South Foreland experiments, however, the condensation of the electric light was only 30' into 5", that is only 6 times, whereas the Isle of May apparatus, which was exhibited at the South Foreland, condensed 45" into 3", that is 15 times. Had this or a still more condensed light been used in the experiments, the electric light would have shown even greater superiority than it did.

We shall afterwards report as to what, in our opinion, is the arrangement of optical apparatus best suited for each illuminant. (Signed) T. and D. STEVENSON

Edinburgh, October 14, 1885

OFFICIAL REPORT ON THE USE OF OIL AT SEA FOR MODIFYING THE EFFECT OF BREAKING WAVES¹

THE following Memorandum, dated June 16 last, on the use of oil at sea for modifying the effect of breaking waves, has recently been printed and circulated by the Admiralty:—

“Many further practical experiments at sea have been made since the report by Capt. Chetwynd, R.N., to the Royal National Lifeboat Institution, dated September 30, 1884, on the use of oil for smoothing broken or troubled waters, which report was communicated to Commanders-in-Chief in Admiralty

3206

Circular Letter of December 1, 1884, N.S.—

8305

“As these further experiences go to show that the use of oil, under different circumstances, is of very extended and simple application, my Lords Commissioners of the Admiralty consider it desirable, in order that the facts may be generally known, to re-issue the report above mentioned, together with such other information as may serve for the guidance of officers, whose attention is hereby called to the fact that a very small quantity of oil skilfully applied may prevent much damage both to ships (especially the smaller classes) and to boats by modifying the action of breaking seas.

“The principal facts as to the use of oil are as follow:—

“On free waves, i.e. waves in deep water, the effect is greatest.

“In a surf, or waves breaking on a bar, where a mass of liquid is in actual motion in shallow water, the effect of the oil is uncertain, as nothing can prevent the larger waves from breaking under such circumstances; but even here it is of some service.

“The heaviest and thickest oils are the most effectual: refined kerosene is of little use; crude petroleum is serviceable when nothing else is obtainable; but all animal and vegetable oils, such as waste oil from the engines, have great effect.

“A small quantity of oil suffices, if applied in such a manner as to spread to windward.

“It is useful in a ship or boat, both when running, or lying-to, or in wearing.

“No experiences are related of its use when hoisting a boat up in a seaway at sea, but it is highly probable that much time and injury to the boat would be saved by its application on such occasions.

“In cold water, the oil being thickened by the lower temperature, and not being able to spread freely, will have its effect much reduced. This will vary with the description of oil used.

“The best method of application in a ship at sea appears to be hanging over the side, in such a manner as to be in the water, small canvas bags capable of holding from one to two gallons of oil, such bags being pricked with a sail needle to facilitate leakage of the oil.

“The position of these bags should vary with the circumstances. Running before the wind, they should be hung on

¹ From the Board of Trade Journal.

either bow, e.g. from the cathead, and allowed to tow in the water.

"With the wind on the quarter, the effect seems to be less than in any other position, as the oil goes astern while the waves come up on the quarter.

"Lying-to, the weather bow and another position farther aft seem the best places from which to hang the bags, with a sufficient length of line to permit them to draw to windward while the ship drifts.

"Crossing a bar with a flood tide, oil poured overboard and allowed to float in ahead of the boat, which would follow with a bag towing astern, would appear to be the best plan. As before remarked, under these circumstances the effect cannot be so much trusted.

"On a bar with the ebb tide, it would seem to be useless to try oil for the purpose of entering.

"For boarding a wreck, it is recommended to pour oil overboard to windward of her before going alongside. The effect in this case must greatly depend upon the set of the current and the circumstances of the depth of water.

"For a boat riding in bad weather from a sea-anchor, it is recommended to fasten the bag to an endless line rove through a block on the sea-anchor, by which means the oil is diffused well ahead of the boat, and the bag can be readily hauled on board for refilling if necessary."

ON THE INTENSITY OF REFLECTION FROM GLASS AND OTHER SURFACES¹

THE author pointed out that most previous experimenters, especially Rood, had measured the amount of the transmitted light, and that any percentage of error in this measurement was greatly multiplied when the results were used to calculate the amount of reflected light. In his experiments the amount of reflected light was measured directly. The method was as follows. Light from a cloud was passed through ground glass in the window of a darkened room, and made to fall at the polarising angle on a plate of glass. The transmitted and reflected rays were conducted along different paths by a series of reflectors, but finally emerged side by side and of equal intensity. One of the reflectors in the path of the reflected ray was the glass surface to be tested, the light falling on it at an almost perpendicular incidence. This glass was now removed, and a single mirror was shifted so as to make the angles and points of incidence of the reflected ray on the several mirrors the same as before. The reflected ray was now brighter than the transmitted. To re-establish equality a disk with holes in a ring round the centre was rotated in the path. The ratio of the sum of the breadths of the holes to the whole circumference of the ring gave the percentage of the light that was reflected. For a piece of optically-worked blackened glass the amount reflected was 0.58 of the total incident light. It was found that the amount of reflection depended greatly on the clearness and polish of the surface. Thus in one case re-polishing increased the amount from 0.4095 to 0.445. Fresnel's formula gave in this case 0.4514. Generally it appeared that the amount reflected was less than according to Fresnel's formula—a result contrary to that of Rood's. The numbers for polished glass and for silver on glass were .94 and .83.

ON THE NATURE OF SOLUTION²

IN connection with the discussion on the "Nature of Solution," in Section B, at the Birmingham meeting of the British Association, the following paper was read by Spencer Umfreville Pickering, Professor of Chemistry at Bedford College:—

The "hydrate" theory attributes dissolution to the existence, in a stable or partially dissociated condition, of definite liquid compounds (generally unknown in the solid form) of the substance dissolved and its solvent, and the mixing of these compounds with excess of the solvent.

In certain special instances we have direct evidence of the reality of such compounds,³ but it is on general grounds rather than on any special experiments that I would seek to establish their existence.

¹ Abstract of a Paper read at the Birmingham meeting, 1886, of the British Association, by Lord Rayleigh.

² Continued from p. 22. From the *Chemical News*.

³ See especially Berthelot, *Ann. Chim. Phys.* (5), 4, 445 to 537.

There is, in the first place, a strong *prima facie* improbability that substances such as copper sulphate, potassium hydrate, &c., which possess such an intense affinity for water, should be capable of existing in the anhydrous condition in the presence of an unlimited amount of water.

We know, moreover, that in a great number of cases—where a dehydrated salt is placed in water—hydration does undeniably precede dissolution,¹ and in such cases the salt can only exist in the liquid in the uncombined state if the continued action of the solvent is to decompose the hydrate which it has just formed. The only two forces by which such a decomposition might be supposed to be effected are (1) the attraction of the bulk of the water present for the few molecules of water combined with the salt; (2) the attraction of this same bulk of water for the (anhydrous) salt molecules. On the one hand, however, it is absurd to imagine that the mass of water molecules possess such a strong attraction for the few contained in the hydrate as to decompose this latter, or, even if they did, that they would ever have given them up to the salt in the first instance; and, on the other hand, it is equally absurd to urge the intensity of the attraction of the salt molecules for the water molecules as a reason for these two parting company.

Another general fact, which lends considerable support to the view that the dissolution of a salt is due to the formation of a hydrate, is, that those salts which combine with water always dissolve in that liquid, and, as a rule, the greater the energy with which they do combine with it, the greater is their solubility.

The thermal phenomena attending the act of dissolution point incontestably to the same conclusion. When a dehydrated salt (say $MgSO_4$) is dissolved in water a considerable evolution of heat occurs: and by the simplest experiment it can be established, beyond any possibility of doubt, that all, or the greater portion of this heat is due to the hydration of the salt. If the salt be taken in the hydrated condition less heat is evolved, and, without a single known exception, this evolution diminishes continuously as the salt taken is more and more highly hydrated; but even when taken in its most highly hydrated condition the evolution of heat is in many cases still very considerable.² Now, unless we can reconcile ourselves to attribute the heat evolution in this latter case to a cause entirely different from that which exists in the other cases,—unless we are content to shut our eyes to the proportionality between the heat evolved and the degree of hydration of the salt taken,—we must admit that even with a fully hydrated solid salt the heat evolved is due to further hydration; that not only do hydrates exist in solution, but that they are often of a higher order than the highest known in the solid condition.

Coming now to the other side of the question, we find many general considerations, as well as special results, brought forward against the hydrate theory of solution. The latter, however, are for the most part, I consider, urged on mistaken notions, and prove nothing *pro* or *con*.

Thus Dr. Nicol's study of the molecular volumes of salts in solution shows that their volumes are entirely uninfluenced by the presence or absence of water of crystallisation in the solid salt; that if any water is still combined with the salt when dissolved it acts in the same way, and is quite indistinguishable from the rest of the solvent present. In so far as his conclusion that these molecular volumes afford no evidence in support of the existence of combined water, I entirely agree with Dr. Nicol; but in concluding that therefore no water is combined, he has pushed his conclusions far beyond legitimate limits. The same reasoning that leads to the belief that the water and the salt bear no chemical relationship towards each other in solution would hold equally good with reference to the radicles of which the salts themselves are constituted, as Favre and Valson indicated in 1875 (*Comptes Rendus*, lxxv. 1000). Each radicle possesses its own specific volume entirely uninfluenced by the

¹ Dr. Nicol (*Phil. Mag.* 1885, i. 453, and ii. 595) quotes experiments with sodium sulphate in opposition to this view. He shows that the dehydrated salt may dissolve in water under certain circumstances without any signs of previous hydration. When it does so, however, it forms a supersaturated solution, which is certainly very different from a normal solution, being, according to Dr. Nicol's determination of the stability, due to the extension at lower temperatures of conditions which exist naturally only above 33°; but when it dissolves to form a normal solution it is with evident signs of hydration. Whatever this may prove as to the supersaturated solution, it certainly does not prove that the normal solution contains the anhydrous salt,—rather the opposite.

² Thus the "true" heat of dissolution of $MgSO_4 \cdot 7H_2O$ is +7000 cal., and even this number is probably 1000 to 3000 cal. too low, as it contains no allowance for the heat of fusion of the $MgSO_4$ molecule. (See *Chem. Soc. Trans.* 1886, 279.)

nature of the other radicle with which it is combined: the radicles behave independently, and as if there were no combination between them.

Nor is it only from a study of the volumes of salts in the dissolved state that such results are obtained. Numerous determinations of the extent to which the vapour-pressure, the freezing-point, and the temperature of maximum density of water is influenced by the presence of various salts in it, have been made by Wüllner, Blagden, Dufour, Depretz, Rüdorff, and De Coppet,¹ with the general results that certain hydrates of the salt are in some cases present, and in others the salt is anhydrous; but these conclusions, which would tell more against the hydrate theory than for it, are eminently unsatisfactory. The whole question, however, has been re-opened by Raoult (*Ann. Chim. Phys.* (5), 28, 133; (6), 2, 66, 4, 401); and by an exhaustive extension of the work, and by including solvents other than water, and solids other than salts, he has thrown a new light on the subject. Not only does the salt, in its influence on the freezing-point, show no signs of the presence of combined water, but it shows no signs of itself being a single compound; each of the radicles contained in it acts independently of the other, and in precisely the same manner as a *molecule* of a non-saline substance (see especially *loc. cit.* 4, 426). Precisely similar conclusions as to the apparent non-combined state of radicles in a dissolved salt were arrived at by Valson in his work on capillarity (*ibid.* 1870), and by Hugo and Vrië (*ibid.* 1883) in their examination of the effect of membranes on salt-solutions. Other instances of a similar nature, physical and thermo-chemical, might be quoted.

That atoms or molecules which are undoubtedly united may retain their individuality so far as to act towards certain agents as if they were free, is surely not surprising; and from such methods as would lead us to conclude that the very radicles composing a salt are uncombined, it would be useless to look for evidence of the more feeble combination of the salt with its water, and inconsistent to argue, from the absence of such evidence, that no combined water is present.

Although I am not inclined to attribute any weight to these special experiments brought forward against the hydrate theory, it is otherwise with more general considerations.

The formation of hydrates cannot explain the absorption of heat which in many cases accompanies dissolution. The phenomena of solution are too universal to permit of imagining the existence of some definite compound of the dissolved substance with the solvent in every case. There is a continuous influence exerted by the salt on its solvent too extensive to be accounted for by the effect of mass on partially dissociated hydrates; there is a continuity between the fused and dissolved states in many cases, and a regularity in the variation of solubility with change of temperature, &c., which cannot be thoroughly explained on the hydrate theory.

However undeniable the existence of these compounds may be in many cases, they do not give an adequate explanation of all the facts of dissolution.

The hydrate theory can be neither rejected nor accepted.

The explanation of this contradiction is not, I think, very difficult to find. We are talking about molecules of solids and liquids, not as they exist, but as they do *not* exist. Our chemical formulæ for them represent but the results of analysis, or, at the best, the constitution of the substance in that transitory state of simplification which immediately precedes entire decomposition; what their composition may be when in the free state, and removed from all decomposing forces, we know not; all we do know or believe about them is, that they are then far more complex than chemical formulæ represent.

Crystalline form alone would show that a number, probably a very great number, of our so-called molecules combine together, bear certain definite relations and hold certain definite positions towards each other, producing a molecular aggregate or physical unit, which alone should receive the name of molecule.²

Just as a number of similar particles unite to form an aggregate

or true molecule of any simple substance, so will dissimilar particles unite to form aggregates of a more complex nature.

It is but natural that our prejudices in favour of the "laws" of chemical combination and atomic valency, to which we owe so much, should lead us to attribute the variable composition of certain substances to our imperfect means of investigation rather than to the nonconformity of these substances to our laws. Whether we be right or not in our explanation, we must acknowledge that apparent inconstancy in composition is one of the most marked features of immense classes of substances which cannot be termed other than chemical compounds.

The varied composition of minerals is said to receive an explanation in the statement that isomorphous substances may displace each other in definite proportions, but to an indefinite extent. This is undoubtedly true, but it does not obviate the necessity of recognising the existence of some form of attraction between these isomorphous substances. No purely mechanical or physical cause can explain this phenomenon; mere similarity of crystalline form has been proved to be incompetent to produce such results. A selective power is exhibited by the substances which thus unite,³ as well defined as that selective power which in the case of simpler substances has received the name of chemical affinity, and the resulting compounds are characterised by the same uniformity in composition and physical properties² which is the attribute of acknowledged chemical compounds.

Nor is it with minerals and artificial crystals only that we find ourselves in what would appear to be a wide border-land between chemical compounds and mixtures. Whether we study the formation of alloys, the occlusion of gases by solids, ranging from the most mechanical action by insensible gradations to the formation of a substance having every appearance of a definite compound, or the decomposition of some of the firmest chemical bodies by so-called mechanical means (filtration), or the constant change in composition of many basic salts with change in the circumstances of their formation,—we are forced to admit that the definiteness which characterises the combination of atoms may be absent from, or at any rate unrecognisable in, the combination of our so-called molecules to form complex aggregates.

When we examine the constituents of these apparently indefinite compounds, it becomes clear that it is only substances which resemble each other which can combine in this manner; and one of the most striking features of dissolution offers such a strict parallel to this, that its meaning can scarcely be mistaken.

A certain degree of similarity in nature between the solvent and the substance dissolved is the invariable accompaniment of dissolution.

Dissolution, I believe, is but one of the many results of apparently indefinite chemical combination.

We cannot obtain a satisfactory explanation of the composition of minerals by admitting the existence of *definite* double salts only, nor can we explain the phenomena of dissolution by confining our attention to *definite* hydrates only. These may, and in all probability do, exist in solution, but they are only small circles within the larger ones; their successive formation and decomposition would give rise to irregularities and effects such as those which are observed in some cases; but these irregularities would form but ripples on the more regular changes which would accompany the variations in the molecular aggregates,—variations which, as in the case of minerals, would be so dependent on physical conditions as to obliterate their chemical nature when examined from many points of view.

The evolution of heat accompanying dissolution will still be attributable, as on the ordinary hydrate theory, to the formation of chemical compounds, but the far greater complexity, and, consequently, instability of these, than of atomic hydrates, if I may so call them, will remove all difficulty in comprehending the continuous effect of the mass of the solvent upon them, even when the latter exceeds that of the salt many hundred-fold; where heat is evolved, therefore, the evolution will be increased, though at a diminishing rate, by dilution.

The rapid increase in the heat of dissolution, produced by a rise of temperature, is but a necessary consequence of the formation of a chemical compound possessing a specific heat less

¹ For a general summary and discussion of the results from the point of view of these physicists, see De Coppet, *Ann. Chim. Phys.* (4), 23, 366; 25, 22; and 26, 96.

² In a Paper read before this Section last year (Report, p. 989), I argued that our formulæ adequately represented the molecules of solids and liquids, and which chemical reactions deal, although I fully recognised the existence of far more complex aggregates; my opinions have so far altered that at present I consider these aggregates to be recognisable in many operations which must be termed chemical, although in the great bulk of ordinary reactions the simpler or ultimate molecules need alone be considered.

³ A power or "affinity" so strong that it will sometimes induce a salt to separate out in a crystalline form and with a proportion of water foreign to its nature, as well as from a solution too weak to yield it of its own accord (Aston and Pickering, "Multiple Sulphates," *Chem. Soc. Trans.*, 1886).

⁴ J. M. Thomson, on the "Double Sulphates of Nickel and Cobalt" (*Brit. Assoc. Rep.* 1877, 209).

than the sum of those of its components, and would of itself go far to prove that a solution did in reality contain such a compound. But a rise of temperature would also undoubtedly have another and opposing effect, for, being inimical to the complexity of these hydrates, they would be more dissociated at higher than at lower temperatures, and hence the heat of dissolution would not be so great as it should be according to the various specific heats. This is precisely what Dr. Tilden has proved to be the case (*Proc. Roy. Soc.* 1885, 401).

There is, however, another action which I believe accompanies every act of dissolution resulting in the *absorption* of heat.

The heat absorbed by a large number of salts in dissolving cannot be freely accounted for by the mere physical change of the solid into the liquid salt. Thus, the heat of dissolution of potassium nitrate is -8500 cal., and that of sodium nitrate -5000 cal., whereas the heat of fusion of these salts at the same temperature is but -1300 and -2300 cal. respectively. There must be some other heat-absorbing action besides the fusion of the salt. The amount of heat thus absorbed increases also with the dilution of the liquid. Moreover, we cannot, I think, account for the manner in which heat is evolved in one case and absorbed in another, or the way in which an absorption of heat sometimes gives place to an evolution, as the temperature or other conditions are changed, but by admitting the constant co-existence of two actions producing opposite thermal effects, and being influenced to different extents by an alteration of circumstances.¹

On the theory which I am here advocating, this absorption of heat receives a ready explanation. Whatever be the complexity of the molecular aggregates of a liquid, those of a solid will be still more complex. Fusion would, therefore, entail their simplification; it would be but a chemical decomposition absorbing heat; this simplification would be pushed much further, however, when the salt is dissolved instead of being merely fused, for the particles of the liquid act chemically (*et hyp.*) on those of the solid and combine with them themselves; the cold absorbed on dissolution would exceed that absorbed on fusion, and would, moreover, be increased by increasing the amount of the solvent. This accords fully with the facts observed.

All the phenomena attending dissolution are, therefore, I contend, accounted for by a full recognition of the real complexity of the units of matter, and by taking the more liberal view of chemical combination which is inculcated by a study of minerals and other substances. Every act of dissolution involves two actions. The chemical decomposition of the more complex aggregates of the solid into a simpler form, absorbing heat, and a chemical combination of these with the liquid, evolving heat; the only quantity which we can at present measure is the algebraic sum of these two.

Mr. Durham next gave a short statement of his own theory of solution:—

When, for example, common salt (NaCl) is placed in water, all the atoms act upon each other. The sodium of the salt acts upon the oxygen of the water, and the chlorine of the salt upon the hydrogen of the water; and the result is a definite compound, which we call a solution. The heat of formation of the acid is neutralised by the heat of formation of the oxide. If they be not equal, the difference is the heat of the solution; if they be equal, the heat is of course *nil*. If the former be the greater, the heat of the solution is negative; if the latter, it is positive. Solution arises from chemical affinity, and takes place inversely as the attraction between the positive element and the oxygen—and the negative element and the hydrogen—of water. But chemical affinity is itself physical; the atoms are physical, and all forces which act upon them must be physical forces. In a chemical mixture every atom is acting upon every other atom, but such action can be nothing else than physical; and we are therefore led to the conclusion that there is really no difference between chemical and physical action, and, consequently, that the alternative between the two does not exist.

In the course of the discussion, and preceding the reading of Mr. Pickering's paper, the following remarks were made:—

Dr. Armstrong said that, from the summary given by Prof. Tilden, it appeared that the two important questions for dis-

ussion were—(1) Does water of crystallisation exist in solution combined with the salt as it did prior to dissolution? and (2) What distinction is to be drawn between chemical combination and mechanical association or adhesion? In short, are the phenomena of dissolution of a chemical or of a mechanical character? But Prof. Tilden had made an important omission, inasmuch as he had not discussed the possible simplification of the molecules on dissolution: in discussing the evidence afforded by the various phenomena, everything turned upon the question whether the crystal molecules are of the composition represented by our ordinary formulæ, or are more or less complex.

As regards the first question, Prof. Tilden appeared to differ from Dr. Nicol, and to think that water of crystallisation did exist in solution. (Prof. Tilden, interposing, desired to explain that what he had said was that it was impossible, in the case of any solution, to say that one portion of the water is in combination with the salt and that another is not; all the phenomena of dissolution and dilution being continuous, no point can be found at which such a distinction can be set up. He believed that the salt was attached to all the water present without exception.)

Dr. Armstrong, resuming, said that much of the evidence appeared, he thought, to favour the conclusion that in certain cases water of crystallisation did exist in solution; e.g. the difference in colour between many hydrated and dehydrated salts taken in conjunction with the colour of their solutions. Again, many dehydrated salts dissolved much less readily than the corresponding hydrated salts: instances of this kind were not common among inorganic salts, but were often met with among organic salts, and the speaker cited calcium butyrate and certain naphthalene- and naphthol-sulphonates as examples. Dextrose, again, ordinarily crystallises with two molecules of water, but if dehydrated and carefully dissolved in water at a low temperature it may be crystallised out from the solution in the anhydrous state. T. Thomsen's recent experiments, however, appeared to show that when two substances were dissolved in water they appropriated the water in the proportions in which they were present, thus favouring a purely mechanical interpretation of the phenomena of dissolution: but, on the other hand, it was to be noted that in the case of citric and sulphuric acids, for example, Thomsen's results were in accord with this conclusion only when it was assumed that the citric acid was present as the dihydrate, and sulphuric acid as the monohydrate, $H_2SO_4 \cdot OH_2$. In fine, the speaker was of opinion that while the question could not be regarded as settled, yet there was a considerable amount of evidence that the water was not evenly distributed, but was, in some cases at least, in part directly combined with the dissolved substance. Dr. Nicol had deduced an ingenious argument from J. Thomsen's observations on heats of neutralisation. As a criticism of Dr. Nicol's argument from the existence of neutralisation constants he would venture to say "Put not your faith in constants." If the views which he held—views which probably were at present peculiar to himself—were correct, the quantities in question ought to have a constant value. According to Helmholtz, all atoms hold a positive or negative electrical charge, a single charge being associated with a monad, two with a dyad, and so on. If when combination takes place these charges exactly neutralised each other, all compounds would be neutral and saturated; but actually this is not the case: in point of fact, there is no such thing as a saturated compound. Helmholtz seems to think that the charges may be held by different atoms with different degrees of force, but the speaker took a somewhat different view, and thought that probably when two atoms combined, in consequence perhaps of peculiarities of structure, their charges were not completely used up; the resulting molecules therefore possessed a certain residual charge or affinity, and were consequently in a position to enter into combination with other molecules. Thus water, he thought, was not a saturated compound; its oxygen atom was still possessed of residual affinity. The same was true of sulphuric acid. Consequently the two could combine together to form a hydrate. On neutralising a dilute solution of alkali by a dilute solution of acid, a stable condition is finally attained, and it is to be assumed that the affinities are fully satisfied, or very nearly so—that the charges practically neutralise each other: hence it may be expected that the heat of neutralisation will have nearly a constant value provided there be no disturbance such as the separation of a precipitate would produce. But the value of each of the several processes which go to make up the heat of neutralisation are entirely unknown to us, and in the absence of such knowledge it

¹ hydrates), impresses very forcibly the co-existence of these two actions, although Thomsen himself does not seem to have noticed it.

impossible to place much confidence in arguments based upon a study of such complex phenomena.

As regards the question of chemical *versus* mechanical action, a speaker could only imagine one form of mechanical action ending dissolution, viz. that of the water molecules bombarding the surfaces of the solid, and as it were chipping off particles. Other actions, in so far as they could be regarded as involving attraction of the molecules of the dissolved substance by use of the solvent, he was inclined to class as chemical. Nothing was more certain than that dissolution depended on the tube both of the solvent and of the substance dissolved. Like solves like—water is *the* solvent for bodies containing oxygen; phosphorus compounds are dissolved by carbon bisulphide; phosphorus compounds by chloride of phosphorus; shale spirit, which is rich in olefines, and especially rosin spirit, which is rich in acetylenes and benzenes, were far better solvents of hydrocarbons and resinous bodies than petroleum, which consisted of saturated inert hydrocarbons, and was the worst of solvents. Facts such as these spoke strongly in favour of the conclusion that the phenomena of dissolution are largely of a chemical character.

Prof. W. N. Hartley was understood to base the argument in favour of the hydration theory chiefly on the changes of colour observed in the solution of certain salts in various proportions of water. The chlorides, bromides, and iodides of cobalt, nickel, and copper exhibit these phenomena most plainly. Thus the hydrate of cobalt in the anhydrous state is black, its dihydrate is green, the hexhydrate a reddish brown. If this last be dissolved in water a pink solution is formed, which probably contains a hexhydrate. The brown saturated solution of the hexhydrate is a very dense liquid, of specific gravity about 3, and when water is added to it the formation of the pink liquid is attended with a large evolution of heat, and this affords evidence that the hydrate exists in the solution. Again, hydrated cupric chloride contains two molecules of water, and when quite dry is of a pale blue colour. Its solution in water has the same colour unless it is heated, and then it turns green. Nickel salts behave similarly. So that the evidence, on the whole, warrants the belief that when a hydrated salt is dissolved in water the water of hydration remains a constituent part of the molecule.

Dr. Gladstone commenced his remarks by a discussion of the question, What is a salt in solution? Is the solution of a salt in water a process analogous in any degree to the decomposition which takes place when one salt is mixed with another? Take, for instance, chloride of sodium and water. Many years ago the speaker had endeavoured to determine whether any chemical decomposition of the salt by the water occurred so as to give rise to sodium hydrate and hydrochloric acid, but he had come to the conclusion that this decomposition took place, if at all, only to a very small extent. Many salts, as had already been noted, combine with water to form coloured hydrates, and the hydrate is of a colour different from that of anhydrous salt. In a coloured hydrate, when dissolved in a sufficient quantity of water, is never changed by further dilution. The speaker had endeavoured to ascertain whether the specific refraction of substances was altered by solution. He had found that no alteration could be detected, and this result was afterwards confirmed by the experiments of other chemists. The refraction equivalent of a solution is equal to the sum of the refraction equivalents of the salt and the water present. In an alum solution, the water of crystallisation supposed to be in combination with the salt is indistinguishable by its refractive power from the water of solution outside it. It seems impossible, however, to arrive at a conclusion with regard to the constituents of a solution. The theory of reciprocal decomposition is not supported by experimental evidence, save in some exceptional cases, and the actual addition of a dissolved salt seems beyond expression by *mutæ*.

TEN YEARS' PROGRESS IN ASTRONOMY¹

THE Earth.—In what may be called the astronomy of the earth there is no very great discovery, nothing extremely new and brilliant to record during the past decade; but there has been considerable and steady progress.

a) As regards the earth's form and dimensions, it has become more certain that Bessel's ellipticity (1/300) is too small. The true value of 1/294 is now admitted and employed on the

¹ "Ten Years' Progress in Astronomy, 1876-86," by Prof. C. A. Young, read May 27, 1886, before the New York Academy of Sciences.

U.S. Coast Survey with a decided improvement of accordance. A slightly larger value even is suggested by the most recent pendulum observations, and 1/292 is now adopted in Europe.

One of the most important steps in this branch of investigation is the discovery by Mr. Peirce (of our own Coast Survey), of the large correction required in many former pendulum determinations, on account of the yielding of the stand from which the pendulum is suspended.

During the past ten or fifteen years a great amount of material has been collected towards a complete gravitational survey of the earth, by the work of Lieut.-Col. Herschel in India, and of the officers of the Coast Survey in this country and elsewhere, and a very important part of it has consisted in connecting the older work with the new, by Peirce's operations in Europe, and those of Herschel in this country.

At the same time it has become increasingly evident that very little is now to be gained by endeavouring to find a spheroid fitting the earth's actual form more closely. It will be best simply to adopt some standard (say that of Clarke, but it makes very little difference what), and to investigate hereafter the local deviations from it. These deviations seem to be larger and more extensive than used to be supposed, the station errors in latitude and longitude being at least quantities of the same order as the variations of elevation.

We mention, in passing, the investigations of Fergola, based on observations at Pulkowa and Greenwich, and leading to a suspicion that the axis of the earth is slightly changing its position and shifting the place of the Poles on the earth's surface. Operations have been organised to determine the question by co-operation between different observatories in nearly the same latitude, but widely differing in longitude.

Nor ought we to pass unnoticed an elaborate paper by Kapteyn, of Groningen, on the determination of latitude by a method depending upon time-observation of stars, at equal altitudes, though in widely different parts of the sky; the stars being so selected that all errors of star-place, instrument, and clock, are almost perfectly eliminated. In the same connection we ought to mention also the new equal-altitude instrument, the Almucranar, invented by Chandler, of Cambridge, and his development of the method of determining time by its use. It may possibly supersede the transit instrument for this purpose, as he seems to expect, though we think it hardly likely.

Rapid progress has been made in determining the difference of longitude between all the principal parts of the earth. There now remain very few stations of much importance which have not their longitude from Greenwich telegraphically settled within a small fraction of a second. In Europe Albrecht has combined into a consistent whole all the different data for more than one hundred points. Our American system has been similarly worked out by Schott, and is connected with the European by no less than four different and independent cable-determinations. South America is connected with the United States by the recent operations of our naval officers in the West Indies and along the eastern and western coasts of the continent; and with Europe by a cable connection between Lisbon and Pernambuco, also effected by them. It is worth noting that two large errors in European longitudes owe their detection to American astronomers. The difference of longitude between Greenwich and Paris was corrected by our Coast Survey in 1872 to the extent of nearly half a second of time, and our naval officers in 1878 showed that the then received longitude of Lisbon was 8'.54s. too small! It is a less surprising fact that an error of 35s. was found in the longitude of Rio.

Our navy has also determined an important series of telegraphic longitudes along the eastern coast of Asia and through the East Indies. The French have been doing similar work in the same regions, especially in connection with the transits of Venus; and the English have determined a large number of longitudes in India. These Asiatic longitudes have been recently connected with Australia and New Zealand by English astronomers, and a telegraphic longitude connection has been effected down the eastern coast of Africa from Aden to the Cape; so that now it is perfectly practicable, if it is desirable, to have one standard of time in all the civilised world.

A word perhaps is here in place as to this question of standard time and the beginning of the day. The adoption by our railroads of the system of standards differing from Greenwich time only by entire hours has, I think, been admittedly a great step in advance, as regards public convenience and safety in travelling. At a few points, where standard and local time happen

to differ by nearly the maximum possible amount of half an hour, some annoyance is felt, and there is still some opposition; but it seems quite clear that, in this country at least, all resistance will soon die out.

As regards the more purely astronomical question of making the astronomical day coincide with the civil day, by beginning at midnight, instead of noon, as it does at present, there is more difference of opinion. For my own part, I am frankly in favour of the change, because I see no use in perpetuating an anomaly which is sometimes annoying and confusing. At the same time the change would, of course, involve some inconvenience to computers and night-observers, and it must be admitted that at present a large number, and possibly a majority, of the most eminent astronomers, in other countries as well as in this, are opposed to it. Those of us whose work falls about as much in the day as in the night, and those, I think, who take a long look ahead, are in favour of the reform; but those whose work is mainly nocturnal, or is based on observations made chiefly at or near the "witching hour," dread the inconvenience of a change of date in the midst of the record, and the risk of confusion in the interpretation of old observations.

The question, however, seems to me not a very important one.

I notice that the visitors of the Royal Observatory have just recommended that the change be introduced into the British *Nautical Almanac* for 1891.

Before passing to the moon, a word should be added as to the outcome of the most recent investigations regarding the steadiness of the earth's rotation. Some irregularities in the lunar motions have appeared to justify a suspicion, at least, that they might be caused by irregularities in the length of the day. The researches of Newcomb upon ancient eclipses and occultations of stars give results not necessarily inconsistent with this hypothesis, perhaps even slightly in its favour, but his careful examination of the past transits of Mercury contra-indicates it pretty decidedly.

The Moon.—During the past ten years there has been no work upon the lunar theory quite on a level with that of Hansen, Delaunay, Plantamour, and Adams in the years preceding; but the labours of Neison, Hill, and Newcomb well deserve mention. The former especially has carried his approximations to a considerably higher point than any of his predecessors, though not without making a few numerical mistakes, which have been detected and corrected by Hill. The investigation of ancient and mediæval observations of the moon by Newcomb is also a very important work, as showing clearly that the lunar theory is still incomplete, and that it is impossible by any tables yet made to represent accurately the whole series of observations. A value of the secular acceleration which suits the observations of the last 200 years will not fit the Arabian observations made 1000 years ago, nor will it satisfy the eclipse observations of still more ancient date, unless at least the received interpretation of those ancient eclipses be admitted to be wrong, as Prof. Newcomb seems to consider rather probable. From his discussion he derives for the secular acceleration a value of $8''\cdot4$, as against the value of $12''\cdot1$, deduced by Hansen.

It will be remembered probably by every one present that the theoretical value of this quantity is about $6''$, and that Ferrel, Adams, Delaunay, and others, attributed its apparent increase to $12''$ to the action of the tides in retarding the earth's rotation and so lengthening the day; if Newcomb's value is correct, this tidal retardation is cut down from $6''$ to about $2''\cdot5$.

The study of the moon's surface has been carried on with assiduity, but I do not know that any remarkable results have been reached, though Klein's observation, in 1877, of what he supposed to be a newly-formed crater (Hyginus N.), excited a good deal of interest and discussion for a number of years; and the most eminent selenographers are still divided in opinion on the question.

The publication by the German Government of Schmidt's great map of the moon, in 1878, unquestionably marks an epoch in selenography; and the photographic work of Pritchard, and the heliometric determination of the moon's physical libration by Hartwig, must not pass unnoticed.

Probably, however, the lunar work which has drawn to itself most attention and interest is the investigation of the moon's heat by Lord Rosse and Prof. Langley.

The earliest observations of the kind date back now forty years, when Melloni, in 1846, first detected the moon's heat by means of the then newly-invented thermopile. But the first really scientific measurements are only about fifteen years old, due to Lord Rosse, at Parson-town, and to Marie Davy, at Paris;

and they seemed to show that at the time of full moon we receive from our satellite, not merely reflected heat, but warmth radiated from the moon's surface; as if this surface were raised to a considerable temperature by the long insolation to which it has been exposed during the preceding fortnight. Lord Rosse estimated the probable temperature of this heated rock to be as high as from 300° to 500° F.

But within the past four or five years this conclusion has been called in question. Observations at Parsonstown, of the rapid diminution of radiation during a lunar eclipse, seem to favour the newer view that the moon's surface, like that of a lofty mountain-top on the earth, never gets very hot, since the absence of air enables the solar heat to escape nearly as fast as it is received.

Prof. Langley's recent and still progressing work upon this subject far excels in delicacy and elaborateness anything done before. At first it seemed to show that the temperature of freezing water was never reached even at the hottest parts of the lunar surface; but the later observations throw some doubt on the legitimacy of this inference. It is found that the radiation from the moon unquestionably contains a considerable percentage of rays which have a wave-length longer than any of the heat-rays from melting ice; and this fact has been supposed to make it probable that the moon's surface was colder than the ice. But then, within a few weeks, Prof. Langley has found the long-waved rays in the radiation from an electric arc! So the question still hangs debatable.

The Sun's Parallax.—I think we may say that, during the past ten years, substantial progress has been made with the problem of the solar parallax. The transit of Venus in 1882 adds whatever value its results may have to those obtained eight years before; but, on the whole, so far as can be judged from the reductions thus far completed and published, it would seem likely that the outcome of the transit observations will be simply to confirm the results obtained by other methods. It may be that the data obtained from the German heliometer measurements will prove more accordant and decisive than those derived from photographs and from the contact observations; there are flying rumours that they will, but it will be necessary to await the official publication for certain knowledge on this point. If they do not, we shall be obliged, hereafter, to relegate transit observations to a secondary rank, as a means of determining the sun's distance. From the various observations of the two transits, different computers have deduced values of the parallax all the way from $8''\cdot6$ to $8''\cdot95$, corresponding to a distance ranging from 95,000,000 to 91,500,000 miles.

The case is quite different with the heliometer observations of the opposition of Mars, in 1877, made by Mr. Gill at Ascension Island. These give, in a most definite and apparently authoritative manner, a value of $8''\cdot783$, and are apparently irreconcilable with any value much greater than $8''\cdot81$, or less than $8''\cdot75$. So far as can be judged from the number, nature, and accordance of the observations, I believe we must accept this as the most trustworthy of the geometrical methods yet employed; though the weight of the result would certainly be increased if it did not depend to such an extent upon the work of a single individual.

The confidence of astronomers in the correctness of this value is greatly fortified by the fact that the most recent and reliable determinations of the velocity of light, made by Michelson and Newcomb, in 1877, 1880, 1881, and 1882, when combined with the Pulkowa constant of aberration determined by Nyren from all the data available up to 1882, give a solar parallax accordant with the preceding almost to the hundredth of a second— $8''\cdot794$ as against $8''\cdot783$. It is true there are possible theoretical objections to the method; as, for instance, that the result may be slighted affected by the motion of the solar system through space. Enough is not known certainly about the constitution of the medium that transmits light through space, to decide all such questions *a priori* and authoritatively; but it is unquestionable that any correction needed on account of such possible causes of error must be very minute.

We believe, therefore, that it is safe to assume pretty confidently that the solar parallax is about $8''\cdot8$ (though probably a trifle less), which makes the sun's mean distance 93,000,000 miles, with an error not likely much to exceed 150,000 miles. A larger value of the parallax (about $8''\cdot85$) still holds its ground in the nautical almanacs, and undeniably is nearer the average of the results given by all the known methods. But none of the other methods seem to us to compete at all in precision with the two whose authority we accept.

The Sun and Meteorology.—The study of the solar surface has been carried on very persistently by Spörer, in Germany, as well as by others, and a great amount of material has been collected bearing upon the theory and nature of sunspots, and their periodicity. The extensive series of photographs obtained at Kew, and at Dehra Doon, in India, constitutes almost a continuous record of the solar surface for several years. The relation between this periodicity and terrestrial conditions has been assiduously examined, but on the whole the outcome seems to me to leave this connection as doubtful as it ever was, in most cases at least. While in some parts of the earth it looks as if there were a slight but marked increase of storm and rainfall at the time of sunspot maximum, the reverse seems to be true in other countries. In South America, Dr. Gould thinks that he has demonstrated a very perceptible effect of the condition of the sun's surface in modifying the strength and direction of the winds; but thus far similar investigations elsewhere show no such result. It will evidently be necessary to wait for a longer and more widely extended collection of statistics to settle the question. We do not even know as yet whether we get more or less than the average heat from the sun during the sunspot maximum.

But I think it may be set down as certain that the condition of the sun's surface exerts, if perhaps a real, yet only a very slight effect upon our earthly meteorology. With terrestrial magnetism the case is markedly and singularly different, and one of the most interesting problems now pressing for solution is the nature of the connection between solar disturbances and magnetic storms.

Solar Heat.—A great deal of labour has been expended upon the study of the sun's heat during the last decade. The investigations that strike me on the whole as most worthy of mention are those of our own Langley and of the Italian Rosetti, whose early death a few months ago is a great loss to science. Secchi and Ericsson, on the one side, had contended for a solar temperature of some millions of degrees, basing their results on Newton's law of cooling; while, on the other, Crova and Violle, from their measures of the solar radiation, reduced according to the so-called law of Dulong and Petit, maintained that the temperature does not much exceed that of many terrestrial furnaces, somewhere from 1500° to 2500° C. Rosetti's experiments upon the radiation of the electric arc and other sources of intense heat showed pretty clearly the inapplicability of Dulong and Petit's law to high temperatures, and indicate a solar temperature not far from 10,000° C., or 18,000° F. But they also make it clear that the limits of uncertainty are still very great.

Prof. Langley, by his invention of the bolometer, has been able to investigate separately the amount of energy transmitted to the earth in the solar rays of every possible wave-length, and to determine the effect of our atmosphere in absorbing each kind of ray. He has shown that the older method of investigating his solar radiation, *in a lump* so to speak, gives fallacious results on account of atmospheric absorption; and that the necessary correction compels us to increase our estimate of the sun's energy at least 20 per cent. In my own little book upon the sun, published in 1881, I had set the so-called solar constant at twenty-five calories per square metre per minute. It is now certain that it must be put at least as high as thirty. Prof. Langley's investigations seem also to show another remarkable fact—that we do not receive from the sun any at all of the low-pitched, slowly-pulsing waves, such as we get from surfaces at or below the temperature of boiling water. The solar spectrum appears to be cut off abruptly at the lower end; and this cutting off we know cannot have been effected in the earth's atmosphere, because we receive from the moon in considerable quantity just this very sort of low-pitched rays. Langley finds them also abundant in the radiation of the electric arc, so that we can hardly suppose them to be *originally* wanting in the solar heat. It now looks as if we must admit that they have been suppressed either in the atmosphere of the sun itself, or in interplanetary space. Another striking conclusion first clearly pointed out by Langley is that, if the sun's atmosphere were removed, its light would be strongly blue.

The Solar Surface and Spots.—As regards the general make-up of the solar surface, I do not think there has been any new fact of extreme importance brought out within ten years. Janssen has, however, carried solar photography to higher excellence than ever attained before, and has obtained plates that show the "granules" and their grouping on a scale previously unknown.

He thinks that his plates prove a peculiar constitution of the solar surface, consisting in collections of clearly-defined and rounded granules, separated by regions or streaks where they are ill defined and elongated; and he calls the phenomenon the "reseau photosphérique," or photospheric network. According to him the "net" remains approximately constant for some minutes at a time, as shown by plates taken in quick succession, but is subject to rapid and enormous changes in periods exceeding a quarter of an hour or so. I find some scepticism among high authorities as to the trustworthiness of his conclusions. There are suggestions that the appearances presented may be due to currents of air in the telescope tube and at the surface of the sensitive plate; but I am disposed to think he is right, for, on several occasions when the seeing has been exceptionally fine, I have observed with my own eyes something quite analogous, in our large telescope at Princeton.

The spots have been carefully studied by several observers, by Spörer especially, in a statistical way, and by Vogel, Lohse, Tacchini, and others, as to structure and detail. Spörer has brought out very clearly the connection between the number and average latitude of the spots. It appears that, speaking broadly, the disturbance which produces the sunspots begins in two belts on each side of the sun's equator in a latitude of over 30°; these belts or spot-zones then gradually move in towards the equator, the sunspot maximum occurring when their latitude is about 16°, while the disturbance gradually and finally disappears at a latitude of 8° or 10°, some twelve or fourteen years after its first appearance. But two or three years before this disappearance a new zone of disturbance shows itself in the same latitude as its predecessor, so that for a while, about the time of sunspot minimum, there are two well-marked zones of spots on each side of the sun's equator—one pair near the equator, due to the expiring disturbance which began some ten or eleven years ago; the other far from the equator, and due to the newly-arising outburst, which will reach its maximum in three or four years, and then pass away like the former.

There can be no doubt that the phenomenon is a very significant one, but its explanation, like that of the periodicity itself, is still to be found.

Nor is the problem of the spots themselves yet fully solved. Not that there is any reasonable question that they are *hollow* in the solar photosphere; but how they originate, how deep they are, and what are the causes of their darkness, and the condition and temperature of the darkening substance—these are questions to which only uncertain answers can now be given. A long and important series of observations upon the widening of the lines of certain elements in the sunspot spectra has been made by Mr. Lockyer, and establishes clearly the fact that those lines, of *iron* for instance, which are conspicuously black and wide in the sunspots, are often just those which do *not* show themselves conspicuously in the prominences; and moreover both in spots and prominences the iron lines that do show themselves are most frequently those which closely coincide with lines in the spectra of other substances. Singularly, also, and so far quite without explanation, it appears according to his observations that at the sunspot maximum those *iron* lines which at other times are conspicuous in spot-spectra entirely disappear.

Perhaps I may be allowed to mention here a recent observation of my own upon these spot-spectra: with a high dispersion the darkest part of the spot-spectrum is found to be not continuous, but made up of fine lines overlapping or almost touching each other, with here and there a clear space left, like a fine bright line. It means, I think, that the absorbing vapours which darken the interior of the spot are wholly gaseous, and tends to disprove the idea that they are mostly of the nature of smoke or steam. We mention also, in passing, another thing which has been shown by our large instrument at Princeton—that the apparently bulbous, finger-tip-like terminations of the penumbral filaments are often, under the best circumstances of vision, resolved into fine, bright, sharp-pointed hooks which look like the tips of curling flames.

(To be continued.)

UNIVERSITY AND EDUCATIONAL INTELLIGENCE

CAMBRIDGE.—At the biennial election of members of the Council of the Senate, Prof. Michael Foster and Dr. Donald MacAlister were elected to serve for four years.

SOCIETIES AND ACADEMIES

LONDON

Mathematical Society, November 11.—Mr. J. W. L. Glaisher, F.R.S., President, in the chair.—Mr. F. S. McAulay, St. Paul's School, was elected a Member.—The following gentlemen were elected to form the Council for the ensuing session:—President: Sir J. Cockle, F.R.S.; Vice-Presidents: J. W. L. Glaisher, F.R.S.; E. B. Elliott, Prof. Greenhill, J. Hammond, Prof. M. J. M. Hill, C. Leudersdorf, Capt. Macmahon, R.A., S. Roberts, F.R.S., and J. J. Walker, F.R.S.—The retiring President, J. W. L. Glaisher, F.R.S., delivered an address, which treated of the Mathematical Tripos Examinations at Cambridge, and of the bearings of recent changes in the same upon the advancement of mathematics.—The following communications were made:—Certain operators in connection with symmetric functions, by R. Lachlan.—The transformation of a certain quartic elliptic element, by R. Russell.—Discussion of a multilinear operator, with applications to the theories of invariants and reciprocants, by Capt. Macmahon.—The theory of screws in elliptic space (fourth note), by A. Buchheim.—The rectification of certain curves, by R. A. Roberts.—Rectification of a sphero-conic, by H. F. Burstall.—Third paper on reciprocants, by L. J. Rogers.—The "sine-triple-angle" circle, by R. Tucker.

Linnean Society, November 4.—Mr. William Carruthers, F.R.S., President, in the chair.—The President paid a passing tribute to, and commented on the loss sustained in the death of, Mr. George Busk, a former Secretary and Vice-President of the Society. Afterwards he drew attention to phosphorescent organisms obtained by him in the Firth of Clyde last September.—Mr. John Murray also made remarks on the same, alluding to his own observations of *Ceratium tripos* being found in long chains in the ocean ("Narrative of the Cruise of the *Chalenger*"), and to Klebs's opinion of *Ceratium* being a genus of unicellular Algae, and not an infusorian.—Prof. J. Macoun made remarks on a series of cones of Canadian *Piceas*. He showed that the various forms occurring from east to west of the continent, which had been hitherto considered different species, were doubtless local varieties of but one species, slightly modified according to the altitudes and region they inhabited.—Dr. F. Day exhibited a salmon parr, twenty months old, raised at Howietoun from parents which had never visited the sea. He also showed coloured drawings of hybrids raised in the same establishment—one being a cross between the American charr and the Loch Leven trout, a second between the American and the British charr, and a third between the last-mentioned hybrid and the Loch Leven trout; all were fertile.—Fresh specimens of a white variety of *Crocus nudiflorus* from Biarritz, France, were shown for Mr. W. D'Arcy Godolphin Osborne, who first observed the variety there in 1882, but since then it has been figured by Mr. G. Maw in his monograph of the genus.—Mr. E. M. Holmes exhibited examples of *Lycopodium echinatum*, Pers., viz. the young plants, and the reticulate appearance of the peridium left by the falling off of the spines.—Mr. F. Pascoe exhibited one of the round olive green balls from Sicily, formed by the action of the sea on fragments of the *Fosodonium caulinia*, and reduced, after a few days' exposure, to a flat cake-like body densely covered with minute crystals of salt. He also showed some acorn-shells (*Balanus*), where several individual animals had united their shells into a common tube, and where the outer valves of each animal had lengthened, forming a series of irregular subsidiary tubes radiating from the apex of the primary one.—Mr. E. C. Rousfield read a paper on the natural history of the genus *Dero*. In this he gives a full account of their habits and the best method of observing them. The *Naias digitata*, Müll., he rejects as a specific appellation, Müller's reference being defective. He shows wherein the *Deros* differ from the *Naiades*, viz. in the former having a respiratory apparatus at the end of the tail. He diagnoses seven species, four being new; all are figured.—Mr. S. O. Ridley gave in abstract his researches on the genus *Lophopus*, and description of a new species from Australia. This latter, *L. lendenfeldi*, obtained by Dr. Lendenfeld near Sydney, N.S.W., is distinguished from *L. crystallinus* by length of tentacles equalling the body of the polypide, and by the non-pointed outline of the statoblast. The new species is the fourth fresh-water Polyzoan recorded from Australia, and the first of its

genus satisfactorily determined from the southern hemisphere. Staining with borax-carminé brings out multipolar cells in the ectocyst, indicating mesodermal elements, and denoting that the ectocyst is something more than mere epithelium. A modification of the diagnosis of the genus is necessitated from these observations.

Chemical Society, November 4.—W. Crookes, F.R.S., Vice-President, in the chair.—Messrs. H. Crompton, G. Dyson, T. B. Tyson, and S. Williamson were admitted Fellows of the Society.—The following papers were read:—The action of chlorosulphonic acid on naphthalene- α - and β -sulphonic acids, by Henry E. Armstrong and W. P. Wynne, B.Sc.—The action of bromine on (Schäfer's) β -naphtholsulphonic acid, by Henry E. Armstrong and F. W. Streatfeild.—The action of bromine on the naphthalenesulphonic acids, by Henry E. Armstrong and W. P. Wynne, B.Sc.— α -Nitro-, α -bromo-, and α -chloronaphthalenesulphonic acids, by Henry E. Armstrong and S. Williamson.—The hydrolysis of sulphonic acids, by A. K. Miller, Ph.D.—The action of bromine on toluene-*para*-sulphonic acid, by A. K. Miller, Ph.D.—Phosphorus tetroxide, by T. E. Thorpe, F.R.S., and A. E. Tutton.—Conversion of ditolane-azotide into diphenanthrylene-azotide, by Francis R. Japp, F.R.S., and Cosmo Innes Burton, B.Sc.—A chemical study of vegetable albinism; part 3, experiments with *Quercus rubra*, by A. H. Church.—The synthetical formation of closed carbon-chains; part 2, some derivatives of tetramethylene, by W. H. Perkin, Jun., Ph.D.—The action of the halogens on the salts of organic bases; part 2, tetramethylammonium salts, by Leonard Dobbin, Ph.D., and Orme Masson, M.A., D.Sc.—Glycyphyllin, the sweet principle of *Smilax glycyphylla*, by Edward H. Rennie, M.A., D.Sc.

Entomological Society, November 3.—Mr. Robert McLachlan, F.R.S., President, in the chair.—The following gentlemen were elected Fellows:—Messrs. P. Cameron, F. Archer, H. J. S. Pryer, H. Norris, N. P. Fenwick, J. Brown, J. P. Tutt, and A. P. Green.—Mr. E. B. Poulton exhibited a mass of minute crystals of formate of lead, caused by the action of the secretion of the larva of *Dicranura vinula* upon suboxide of lead. He stated that a single drop of the secretion had produced the crystals which were exhibited; and he called attention to the excessively high percentage of formic acid which must be present in the secretion.—Mr. S. Stevens exhibited a specimen of *Laphygma exigua*, recently captured by Mr. Rogers in the Isle of Wight.—Mr. W. F. Kirby exhibited, and read notes on, a specimen of *Perilampus manrus* recently bred by Mr. Walter de Rothschild from *Antheraea tirreha*, one of the rarer South African Saturniæ.—Mr. T. W. Hall exhibited a number of specimens of *Xanthia fulvago* (*cerago*), somewhat remarkable in their variation, and showing a graduated series, extending from the pale variety, *flavescens* of Esper, to an almost melanic form.—Mr. Boyd exhibited, and made remarks on, the larva of a species of *Ornithoptera* from New Guinea.—Mr. H. Goss exhibited a series of *Bankia argentula* collected by him in Cambridgeshire in June last; and also, for comparison, a series of specimens of the same species taken at Killarney in June 1877. It appeared that the Irish form of the species was larger and more brightly coloured than the English form.—Mr. Eland Shaw exhibited a female specimen of *Decticus verrucivorus* taken in July last at St. Margaret's Bay, Kent.—Mr. Waterhouse recorded the recent capture of *Deiopeia pulchella* at Ramsgate, by Mr. Buckmaster; and the capture of *Anosia flexippus* at Gibraltar was also announced.—Mr. J. W. Slater read a paper on the relations of insects to flowers, in which he stated that many flowers which gave off agreeable odours appeared not so attractive to insects as some other less fragrant species; and he stated that *Petunias*, according to his observations, were comparatively neglected by bees, butterflies, and Diptera. Mr. Distant, Mr. Stainton, Mr. Weir, Mr. Stevens, and the President took part in the discussion which ensued, and stated that, in their experience, *Petunias* were often most attractive to insects. Mr. Stainton referred to the capture, by himself, of sixteen specimens of *Sphinx convolvuli* at the flowers of *Petunias*, in one evening in 1846.—Jonkeer May, the Dutch Consul-General, asked whether the reported occurrence of the Hessian fly (*Cecidomyia destructor*) in England had been confirmed. In reply, Mr. McLachlan stated he believed that several examples of an insect, thought to be the Hessian fly, had been bred in this country, but that everything depended upon correct specific determination in such an obscure and difficult genus as *Cecidomyia*.

EDINBURGH

Mathematical Society, November 12.—Dr. R. M. Ferguson, President, in the chair.—The President gave a retiring address, for which, and for the gratuitous use of the rooms of the Edinburgh Institution for the Society's meetings, a vote of thanks was awarded to him.—Mr. J. S. Mackay read a paper on the solutions of Euclid's problems with a ruler and one fixed aperture of the compasses by the Italian geometers of the sixteenth century; and communicated a note from Mr. R. Tucker giving some novel properties connected with the triangle.—Mr. A. Y. Fraser read a note by Mr. William Renton on the quivoocal sign.—The following office-bearers were elected for the session:—President: Mr. George Thom; Vice-President: Mr. W. J. Macdonald; Secretary: Mr. A. Y. Fraser; Treasurer: Mr. John Alison; Committee: Mr. R. E. Allardice, Dr. R. M. Ferguson, Mr. George A. Gibson, Mr. William Jarvey, Mr. J. S. Mackay, Mr. Thomas Muir.

SYDNEY

Royal Society of New South Wales, September 1.—Mr. Ch. Rolleston, President, in the chair.—Mr. Fredk. B. Gipps, M.E., read a paper on "Our Lakes and their Uses." The lakes of New South Wales being all liable to dry up, Mr. Gipps stated that it is possible, however, to impound large artificial lakes. The leading features of Lake George were described, and a means of utilising its waters for irrigating a large area were entered into.—A very beautiful specimen of gold from calcite was exhibited by Dr. Leibius, of the Mint. The lime having been dissolved in acid, the gold was left as a network of the finest ramifying filaments.

PARIS

Academy of Sciences, November 8.—M. Jurien de la Gravière, President, in the chair.—On the relations of geodesy and geology, by M. Faye. This is a reply to M. de Lapparent's recent criticisms of the author's well known views on the relations of the geodetic and geological sciences. M. de Lapparent's objections are treated in detail, and it is argued that the law of unequal cooling of the terrestrial crust dates back to times anterior to the astronomico-geological epoch, when the seasons began to be established. It controlled the whole series of geological evolutions from the first formation of the oceanic basins.—Thermic researches on the reactions between ammonia and the magnesian salts, by M. Berthelot. These studies tend to define the action of ammonia on the magnesian salts, determining the analytical conditions which enable magnesia to be separated from the other alkaline salts, and showing that, by union with sulphuric acid or with hydrochloric acid, the complex ammoniaco-magnesian base liberates a quantity of heat greater than pure ammonia or pure magnesia, and very near that liberated by potassa and soda.—On the incandescent substance in fusion recently reported to have fallen during a thunderstorm at Luchon, by M. A. Trécul. In connection with M. St. Meunier's remarks on this subject, the author refers to a communication made by him to the Academy in 1881 (*Comptes rendus*, xcii. p. 775), showing that in thunder-clouds there may exist an incandescent substance in fusion, which under certain conditions may fall to the ground in the form of variable drops or globules.—Report made on behalf of the Section for Chemistry on M. Moissan's researches relating to the isolation of fluorine, by M. Debray. After describing the attempts made by Davy and subsequent chemists to solve this problem, the report gives a detailed account of M. Moissan's researches, and considers his final conclusion fully justified, that the gas liberated by the electrolysis from the pure anhydrous hydrofluoric acid, with which he experimented, is undoubtedly fluorine. The question consequently now enters on a new phase, and chemistry may henceforth deal directly with fluorine, and attack problems of great interest, formerly regarded as insoluble.—Observations of the new planet 261, made at the Paris Observatory (equatorial of the West Tower), by M. G. Bigourdan.—On an extended class of uniform transcendents, by M. H. Poincaré.—On Maclaurin's series in the case of a real variable: application to the development of a homogeneous body in series of the potential, by M. O. Callandreau.—Note on the octahedron, by M. P. Serret.—On the transport of force; a reply to M. Deprez, by M. Hippolyte Fontaine. It is admitted that the principle of a series of machines linked together is not new; but the author claims that the results of his researches obtained by the employment of special dynamos, and by a re-

arrangement of the mechanical elements, must be regarded as new. The transport of 50 horse-power through a resistance of 100 ohms with a loss of only 48 per cent., by employing dynamos jointly weighing only 8400 kilograms and costing only 6581., is now realised for the first time.—Determination of the heats of neutralisation of the malonic, tartaric, and malic acids: remarks on the heats of neutralisation of the homologous acids of oxalic acid and of the corresponding hydroxylated acids, by MM. H. Gal and E. Werner. The results here tabulated of the authors' researches show that the heat of neutralisation of the homologous bibasic acids under consideration diminishes in proportion as the molecular weight increases.—General methods of crystallisation by diffusion; reproduction of mineral species, by M. Ch. Er. Guignet. These experiments are described as a generalisation of M. Becquerel's ingenious researches on the slow action set up between two liquids separated by a film, a porous wall, or even a glass tube with a fissure or capillary aperture. The methods employed are applicable to a large number of bodies, and yield crystals in any required quantities.—Synthesis of concine, by M. A. Ladenburg. The processes are described by which the author has succeeded in obtaining synthetically three bases possessing the same mutual relations as racemic and tartaric acids, one of which is absolutely identical with natural concine.—On the chemical transformations brought about by the action of solar light, by M. E. Duclaux. Having already examined the sterilising action of solar light on microbes, the author here proceeds to show that the influence at play belongs to the order of chemical phenomena, which in this case assume a physiological character. The action of the solar rays is shown to be analogous to that of the ferments.—On a new means of preventing secondary fermentations in the alcoholic fermentations of commerce, by MM. U. Gayon and G. Dupetit. This process consists in adding to the wort antiseptic substances capable of arresting the development of the countless germs contained in the primary substances and in the yeast, without, however, impairing the activity of the leaven itself.—On the alcoholic fermentation of dextrine and of starch, by MM. U. Gayon and E. Dubourg. A new kind of mucus is described, which possesses the twofold property of fixing the water on dextrine, and even on starch, and superinducing fermentation in the products of this saccharification, without, however, affecting cane-sugar or transforming it to alcohol.—On the reduction of the sulphate of copper during vinous fermentation, by M. H. Quantin.—On the genus *Cepon*, by MM. A. Giard and J. Bonnier. Two new species (*C. pilula* and *C. elegans*) of this little-known genus have been discovered by the authors, the former a parasite of *Xantho floridus*, the latter of *Pilumnus hirtellus*. Both occur on the French seaboard.—On the homologies of the larvæ of Comatulæ, by M. J. Barrois.—On the cave-dwellers of Bêche-aux-Roches, by MM. Marcel de Puydt and Max. Lohest. The authors disclaim all responsibility for the recent remarks of M. de Nadaillac describing the culture of this prehistoric race in somewhat exaggerated language.—On the affinities of the Eocene floras of West France and Saxony, by M. Louis Crié.—On a serious malady analogous to scurvy observed in certain reptiles, by M. Magiot.—On a technical process for the diagnosis of Gonococcus, whereby this parasite may be distinguished from other species of cocci, by M. Gabriel Roux.

BERLIN

Meteorological Society, November 2.—Prof. von Bezold in the chair.—Prof. Spörer spoke of stormy movements in the atmosphere of the sun. He discussed a long series of details respecting the physics of the sun, which were illustrated by heliographic maps, and emphasised the fact that spots invariably appeared only in very hot luminous regions of the solar surface. Of his theoretical explanations it may be more particularly mentioned that, in the opinion of the speaker, the luminous regions originated in the ascending of gases and vapours from the hot interior of the sun. When such a thing happened at the circumference of the sun, then metallic prominences were observed. In consequence of their higher temperature the luminous regions caused ascending currents, whither cooler gases streamed from all sides. The gases, which in certain circumstances mounted to heights of 30,000 German (135,000 English) miles, cooled, sank as cooler masses endowed with greater linear velocity to the same localities, and there formed the sunspots. In the discussion following this address, Prof. Spörer stated that according to his observations the last maximum had shown itself 1884.0. He further stated that occasionally, under special conditions of illumination, he had, with the aid of the tele-

scope, seen in clouds small, round bodies moving up and down, which he had taken for rain-drops, and commended to those interested in the study of the atmosphere such observations of clouds. Respecting the possibility of seeing the rain-drops of clouds in this manner there arose a lengthy discussion.

Physical Society, November 4.—Prof. von Helmholtz in the chair.—Prof. Spörer produced and made the subject of discussion a long series of heliographic maps which he had drawn from phenomena he had himself witnessed, and which demonstrated in a very graphic manner the occasionally very important proper motions of different spots. These self-movements always occurred on the west side of the spots, and of the groups of spots. They always followed therefore in the sense of the sun's rotation. They were recognised when the spots were observed several times in the course of a day, and they sometimes attained values of from 1000 to 2000 geographical miles in one day. These movements were especially intense in the case of the formation of larger spot-groups; later on they grew slower. For the explanation of these proper motions, the speaker adduced that sunspots invariably formed themselves only over luminous surfaces, that is, at spots of the solar surface possessing a higher temperature. In his measurements of temperature, which had not yet been published, having reference to the year 1880, he made use of a thermo-element on which, through a fine opening in a thick pasteboard disk, he caused to fall the position of the sun's image which he wanted to measure. According to these observations, the emission of heat from a spot-umbra stood to the radiation of heat from a luminous surface as 10 : 13, and the radiation of a spot-umbra to the radiation of the usual solar surface as 10 : 15. Seeing that the temperatures on the sun stood probably in the same relation as did the radiations, so in the luminous surfaces which possessed a higher temperature (in the relation of 6 : 5) must an ascending gas-current develop, to which a descent of colder gas-masses must necessarily correspond. These descending colder gases it was which generated the spots, and gave them—seeing they possessed a greater linear speed of rotation than did the solar surface—a displacement towards the west in the sense of the rotation.—Dr. Pernet spoke on the determination of the air in the vacuum of the barometer, in accordance with the Arago method, connecting his observations with a publication by Dr. Schreiber, who, on comparing the barometer of the Saxon station with the normal barometer, found, after taking due account of all corrections in the latter, volumes of air far surpassing the permissible quantities. Dr. Pernet had now found that two very essential corrections were overlooked: first, the determinations of the air in vacuum under the pressures 0.40, and 80 millimetres, were carried out in much too rapid succession, so that compensations of temperature were impossible; second, the effect of the capillarity was not observed, an effect which in the case of syphon barometers played so far a great part, as the lower surface of the quicksilver affected by oxidation and dust had a different surface-tension and different angles of rim from the upper surface of the quicksilver, which was comparatively pure. The registrations were therefore not exact if the menisci were not simultaneously measured. This tension of the surface was in the case of thermometers also very important. In consequence of it, the readings of thermometers with narrow tube and less mass of quicksilver were less exact than the readings of thermometers with wider tube and more quicksilver. It was the cause that thermometers with elliptical tubes were less exact than thermometers with circular ones. The effect of the capillarity, again, was, in the opinion of the speaker, the cause of the "dead point" of Mr. Pickering.

VIENNA

Imperial Academy of Sciences, October 7.—On Hall's phenomenon, by A. von Ettingshausen and W. Nernst.—On the data wanted for proving Avogadro's law, by L. Boltzmann.—On the theory of the electro-magnetic phenomenon discovered by Hall, by the same.—On the density of liquefied methene and liquefied oxygen, by K. Olszewski.—On the comets discovered by Mr. Finlay on September 26, and by Dr. Hartwig on October 6, by E. Weiss.—On colchicine, by S. Zeisel.—Contributions to the knowledge of the Tertiary flora of Australia, second paper, by C. von Ettingshausen.

October 14.—Researches on strychnine, especially on the action of zinc-dust on strychnine, by W. F. Loebisch and P. Schoop.—A preliminary communication on the statistics of comets, by T. Unterweger.

October 21.—To histology and physiology of mucous secretion, by W. Biedermann.—Remarks on L. Hermann's galvanotrophic experiment, by E. Mach.—On hydrocarotin and carotin by F. Reinitzer.—On the anatomy and systematics of gall-mites by A. Nalepa.

BOOKS AND PAMPHLETS RECEIVED

Encyclopædia der Naturwissenschaften, Erste Abtheil., 48-49 Lief.; Zweite Abtheil., 37-38 Lief. (Trewendt, Breslau).—Index Catalogue of the Library of the Surgeon-General's Office, U.S. Army, vol. vii. (Washington).—Proceedings of the Linnean Society of New South Wales, and series, vol. i., part (Cunningham, Sydney).—Quarterly Journal of Microscopical Science, October (Churchill).—Alpine Winter, 3rd edition: Dr. A. T. Wies (Churchill).—Encyclopædia Britannica, vol. xxi. (Black, Edinburgh).—Structure and Life-History of the Cockroach: L. Miall and A. Denny (L. Reeve).—Madagascar, 2 vols.: Capt. S. P. Oliver (Macmillan).—Journal of the Anthropological Institute, November (Tribner).—First Year of Scientific Knowledge, 3rd edition: P. Bert (Relfe).—Nouvel Atlas Céleste: R. A. Proctor; translated into French by P. Gérigny (Gauthier-Villars, Paris).—Ordnance Survey of the United Kingdom: Lieut.-Col. White (Blackwood).—Photographie sans Objectif: R. Colson (Gauthier-Villars, Paris).—L'Aur Boreale: M. S. Lemström (Gauthier-Villars, Paris).—Les Hypothèses Cosmogoniques; Examen des Théories Scientifiques Modernes sur l'Origine des Mondes, suivi de la Traduction de la Théorie du Ciel de Kant: C. W. Gauthier-Villars, Paris).—Hand-book of Jamaica for 1886-87: A. Sinclair and L. R. Fyfe (Stanford).—Quarterly Journal of the Royal Meteorological Society, October (Stanford).—Monthly Results of Observations made at the Stations of the Royal Meteorological Society, vol. No. 22 (Stanford).

CONTENTS

The Zoological Results of the "Challenger" Expedition	PA
Elementary Dynamics	
Our Book Shelf:—	
Church's "Food-Grains of India."—Prof. John Wrightson	
Taylor's "Tobacco a Farmer's Crop."—Prof. John Wrightson	
Marion's "Practical Guide to Photography"	
Bird's "Lecture-Notes and Problems on Sound, Light, and Heat"	
Griffin's "Bicycles and Tricycles for the Year 1886"	
Letters to the Editor:—	
Extension of the Corona.—Prof. S. P. Langley	
The Astronomical Theory of the Great Ice Age.—Sir Robert S. Ball, F.R.S.	
Abnormality in Cats' Paws.—J. Herbert Hodd	
Abnormalities in the Vertebral Column of the Common Frog.—Prof. C. Lloyd Morgan	
Influence of Wind on Barometric Readings.—G. J. Symons, F.R.S.	
Barnard's Comet.—T. W. Backhouse	
Aurora.—Dr. M. A. Veeder	
"Lung Sick."—Philip J. Butler	
Paul Bert	
The Recent Weather. By Rev. W. Clement Ley	
The Work of the United States Fish Commission	
Volcanic Dust from New Zealand. By Prof. T. G. Borney, F.R.S.	
Notes	
Our Astronomical Column:—	
The Influence of Astigmatism in the Eye on Astronomical Observations	5
The Kalaog Observatory	5
Cassiopeia	5
New Minor Planets	5
Comet Finlay	5
Comet Barnard	5
Gould's <i>Astronomical Journal</i> as published in Victoria	5
Astronomical Photographs of Petunias, Week 1886	5
November 21-27, previously neglected by Mr. Stainton, Mr. Vernor Harcourt, F.R.S.; and T. and J. Young	5
Lighthouse Illuminants, in the discussion of the Official Report on the Use of Illuminants for modifying the Effect of Breaking Waves on the Intensity of Reflection from Surfaces. By Lord Rayleigh, F.R.S.	6
On the Nature of Solution	6
Ten Years' Progress in Astronomy, by Prof. C. A. Young	6
University and Educational Intelligence	6
Societies and Academies	6
Books and Pamphlets Received	6

THURSDAY, NOVEMBER 25, 1886

EXPLORATION OF THE NORTH SEA

Die Ergebnisse der Untersuchungsfahrten S.M.Knbt. "Drache" (Kommandant Korvetten-Kapitän Holzhauser) in der Nordsee in den Sommern 1881, 1882, und 1884. Veröffentlicht von dem Hydrographischen Amt der Admiralität. (Berlin: Ernst Siegfried Mittler und Sohn, 1886.)

OUR knowledge of the physical conditions of the North Sea has just been enriched by the publication of the results of the expeditions of the Prussian ship *Drache* during the summer months of the years 1881, 1882, and 1884. The expeditions and the publication have been carried out under the direction and with the authority of the Hydrographic Office of the German Admiralty.

Prof. Möbius, who has examined the organisms collected by the *Drache*, reports that he has found nothing worthy of special mention among the biological collections. It is otherwise with the physical and chemical observations, for the whole of the volume before us is devoted to these observations, their analysis and discussion. The publication is accompanied by synoptic tables showing the positions of the observing stations and the scientific results, as well as by fourteen charts setting forth graphically the currents, the depths, the salinity, specific gravity, and the quantity of oxygen in the surface, intermediate, and bottom water, and sections illustrating the distribution of temperature.

The temperature and salinity are first examined. The observations confirm the view that the salt heavy water of the Atlantic enters the North Sea by the north of Scotland, and, on being cooled, sinks to the bottom, and fills all the deeper parts of the basin, including the Norwegian Gut. The observations of the Norwegians and those on board the *Triton* showed that, in like manner, the deep water of the Norwegian Sea was largely made up of the salt Atlantic water, which sank to the bottom on reaching a colder latitude—probably mixing much with deep colder Polar and fresher water. The *Drache* traced this salt Atlantic water to the centre of the North Sea. It would be a matter of very great interest to have the temperature of the water taken at stated intervals throughout the year in the Norwegian Gut, in a similar manner to the observations now being carried on in the deep lochs of the west of Scotland. The observations on the currents of fresher water running to the north along the coasts of Britain and Jutland—the latter eventually meeting and mixing with that of the Baltic—are very interesting. Indeed, the extensive current and tidal observations are valuable additions to knowledge; but, as the author remarks, both they and the temperature observations are incomplete, being confined to the summer months, and he indicates the regions where observations are much required. Still, combined with the winter observations which we possess at certain points, the *Drache's* observations greatly augment our knowledge of the physical conditions of the North Sea, and of the modifying influences produced by the seasons.

The chemical work has been intrusted to Dr. Neu-

meister, under the direction of Prof. Jacobsen, and the geological part is by Dr. Gümbel. The chemical work includes the determination of the oxygen and nitrogen in water from different depths. Dr. Neumeister found in surface-water (mean of twenty-five analyses) the oxygen to be 33.95 per cent., the volume of the sum of the oxygen and nitrogen equalling 100. In deep water (200 metres) the oxygen descended to 25.20 per cent. of the volume of the two gases.

For carbonic acid combined as neutral salts, he found for surface-waters 52.66 milligrammes per litre (mean of sixty-seven determinations); the partially combined acid was found to be 43.78 milligrammes (mean of thirty-nine determinations).

As appendix to these researches, the results are given of the determinations of the carbonic acid in the waters of the Atlantic, Indian, and Pacific Oceans, collected by the *Gaselle* in 1874-76. The carbonic acid combined as neutral salts in the surface-waters reaches to 52.5 milligrammes per litre (mean of thirty-one observations). At 183 metres of depth, the mean is 53.2. For greater depths, down to 5000 metres, fourteen determinations gave 50.6 to 56.8 milligrammes. Four determinations gave 59 to 70 milligrammes, and one gave 82.7 milligrammes. No attempt is made to compare these with the *Challenger* results.

The author explains the presence of the large quantity of carbonic acid in deep water by the fact that the water dissolves the carbonate of lime, which is found in great quantity on the bottom in all moderate depths. The carbonic acid which effects this dissolution is probably furnished by the oxidation of organic substances. The author refers to the fact that carbonic acid is not necessary in order that carbonate of lime may be dissolved by sea-water, and has, in this respect, confirmed Dittmar's observations. Different waters, however, comport themselves very differently in this respect. The water of great rivers, adds the writer, at their embouchure contains less acid combined as neutral salts than ocean water, and the mixture of salt and river water, along coasts, less carbonic acid than the water in the great oceans; but the difference is not in proportion to the quantity of salts present. It is shown by analyses of Baltic water that while this water contains only about one-half of the salts present in pure ocean water, it contains nearly nine-tenths of the carbonic acid present in the neutral salts of pure ocean water.

Gümbel's work consists in an examination of the deposits collected from depths ranging from 18 to 317 metres. The forty samples, of which an excellent description is given, all belong to littoral, sub-littoral, or terrigenous deposits. None of them present the essential characters of truly deep-sea or pelagic sediments. The author divides them into quartz sands and sandy clays, the latter being of a much darker colour than the former. Gümbel has followed in his descriptions the methods indicated in the preliminary notices of the *Challenger* deposits. Gümbel attributes the absence of Globigerina ooze from the samples to the relatively shallow depths from which they were procured, and he adds that the depth determines the nature of the deposit. This is quite a mistake: it is, rather, distance from land that determines the kind of deposit. Deposits not unlike those

described by Gmbel occur in depths of over 2000 fathoms when near to land, while a Globigerina ooze or Pteropod ooze may occur in very shallow depths, in the tropics, far from land. These deposits of the *Drache*, being near the coast, it is found that quartz predominates. The fragments of plagioclase, orthose, hornblende, augite, bronzite, mica, garnet, tourmaline, diroite (is it not glaucophane?), magnetite, zircon, chlorite, all come from the disintegration of the ancient rocks which form the coast of Norway and Scotland. Gmbel also finds fragments of granitic rocks, dioritic rocks, &c. Fragments of modern volcanic rocks, such as lavas and pumice, are very rare when compared with the particles derived from ancient rocks. Glauconite was found in some of the specimens, and the author believes that these have been transported, which is quite unlikely, as large deposits of glauconite are now in process of formation along the coasts of the north of Scotland. The organisms—mollusks, echinoderms, foraminifera, and diatoms—are all the same as those usually found in partially inclosed seas like the North Sea, and do not present any peculiarities worthy of note.

The author supposes that there is a continuation under the North Sea of the ancient rock-masses of Scandinavia. This may be true, but the supposition can in no way have been suggested by the chemical, microscopic, and mineralogical examinations of the deposits of the North Sea. In conclusion, Gmbel states that the sediments of the North Sea prove that sandy deposits can be formed alongside of clayey and marly deposits, during the same time in the same sea. This conclusion has already been perfectly established, and this confirmation supports an interpretation generally received, which was one of the first results of the examination of the *Challenger* deposits.

The Hydrographic Office of the German Admiralty have done excellent service in taking up the scientific examination of the North Sea. It is a work that we would like to see continued and advanced by our own Hydrographic Office.

J. M.

OUR BOOK SHELF

Chemical Arithmetic. By Sydney Lupton, M.A., F.C.S., F.I.C. Second Edition. (London: Macmillan and Co., 1886.)

WE are pleased to note a new edition of this excellent work, in which several improvements have been made. The hundred pages of introductory matter in the first edition have been reduced by about one-half, much unnecessary pure arithmetic having been cut out. The 1200 examples with answers are, on the whole, well selected, though many of them can scarcely be called chemical. A greater number of typical examples might advantageously have been worked out at full length.

The book is especially to be commended for its clear and concise definitions, which are in many books very loosely expressed. The differences between density and specific gravity, atomic and molecular weights, for instance, are explained in a manner that any student of ordinary ability will readily understand. We feel sure that the book will be appreciated alike by students and teachers, but it will be especially valuable to teachers.

Experimental Chemistry. By C. W. Heaton, F.I.C., F.C.S. New Edition, Revised. (London: George Bell and Sons, 1886.)

ANOTHER edition of this work on experimental chemistry—adapted from the German of Dr. Stckhardt, has

just been issued. To those students of limited means who desire to work at chemistry as well as to read it—and it is for those that the book is intended—it will be found useful. The introduction, however, is much too extensive and theoretical for beginners, and we fear that many would be disheartened before reaching the really experimental work. In our opinion, the book is not sufficiently practical, many experiments lacking detail. We would suggest that in future editions a few pages be devoted to instructions in the manipulation of apparatus and the working of glass.

Part IV., which is devoted to organic chemistry, is very clearly set out. The book is not sufficiently modernised for these days of competitive examinations, but the teacher who is desirous of encouraging his students to perform simple experiments in spare moments would get many valuable ideas from it.

LETTERS TO THE EDITOR

[The Editor does not hold himself responsible for opinions expressed by his correspondents. Neither can he undertake to return, or to correspond with the writers of, rejected manuscripts. No notice is taken of anonymous communications.]

[The Editor urgently requests correspondents to keep their letters as short as possible. The pressure on his space is so great that it is impossible otherwise to insure the appearance even of communications containing interesting and novel facts.]

The Sense of Smell

IN your issue of September 30 (vol. xxxiv. p. 521) your correspondent Dr. Arthur Mitchell is desirous of obtaining some data in regard to the sense of smell. In a paper presented at the Philadelphia meeting of the American Association for the Advancement of Science (1884) we have described a series of experiments designed to test the delicacy of this sense. These experiments, being of a preliminary character, have hitherto been withheld from publication, but the following brief statement of the results obtained may be of interest to Mr. Mitchell and to other readers of NATURE. We made use of the following substances:—(1) oil of cloves, (2) nitrite of amyl, (3) extract of garlic, (4) bromine, (5) cyanide of potassium. A series of solutions of each of these was prepared, such that each member was of half the strength of the preceding one. These series were extended by successive dilutions till it was impossible to detect the substances by smell. The order of the bottles containing these solutions was completely disarranged, and the test consisted in the attempt to properly classify them by the unaided sense of smell. The thirty-four observers who assisted in these experiments were of both sexes; the results are indicated in the following table (I.) :—

Amount detected

	Oil of cloves	Nitrite of amyl	Extract of garlic	Bromine	Cyanide of potassium
Average of 17 males	1 part in 88,218 of water	1 in 783,870	1 in 57,927	1 in 49,254	1 in 109,140
Average of 17 females	1 part in 50,667 of water	1 in 311,330	1 in 43,900	1 in 16,244	1 in 9,008

The same method of investigation has since been followed by one of us¹ in some experiments, the results of which are given in Table II.

Amount detected

	Prussic acid	Oil of lemon	Oil of wintergreen
Average of 27 males	1 part in 112,000 of water	1 in 280,000	1 in 600,000
Average of 21 females	1 part in 18,000 of water	1 in 116,000	1 in 311,000

¹ "Some Special Tests in Regard to the Delicacy of the Sense of Smell," by E. H. S. Bailey and L. M. Powell (*Proc. Kansas Acad. of Science*, vol. ix.).

Many striking individual peculiarities were noticed in the course of the experiments, which these general averages fail to show. Three of the male observers were able to detect one part of prussic acid in about 2,000,000 parts of water. Two of these were persons engaged in occupations favouring the cultivation of this sense. Careful chemical tests failed to show the presence of prussic acid in several of the more dilute solutions, in which it could be detected by the sense of smell. We found some of both sexes who absolutely could not detect prussic acid even in solutions of almost overpowering strength. There were several instances of the same peculiarity as regards bromine. Again, our averages show that the sense of smell is in general much more delicate in the case of male than of female observers.

EDWARD L. NICHOLS
E. H. S. BAILEY

University of Kansas, November 4

Tidal Friction and the Evolution of a Satellite

ADVERTING to the correspondence in NATURE (vol. xxxiv. p. 286), I think that Mr. Darwin has not, so far, fully realised the results that would follow from the circumstance that the Martian satellite's period would be affected many hundred times more than that of the planet's rotation, as explained in the correspondence referred to. He argues that, the moon's mass being great, she should recede to an enormous distance before there will be a reversal of the direction of her tides on the earth; while the satellite of Mars, being very small, need only to recede a short distance before a similar tidal reversal ensues. No mention being made of any other supposed difference in the systems at the starting-point, it must be inferred that other things are supposed about equal. But, as a matter of fact, the present position of the Martian satellite is incompatible with an initial rotation of its planet anything like so great as that ascribed to the earth at a like stage. If Mars be supposed to rotate ten times while the satellite, at its present distance, makes nine revolutions, the satellite's period would still be affected or lengthened much more than would that of the planet's rotation. The difference between the periods of revolution of the planet and satellite would increase quickly at first, but more slowly as the satellite receded a certain distance, till at a certain time there would be no increase, after which there would be a decrease, and finally a reversal. When the satellite would have receded to a short distance, where she would revolve in the same period as Mars now rotates in, the planet would have lost but little of its original rapid rotation. Now, supposing the satellite tide to go round in the same time as the solar one, the period of the satellite would be affected about thirty times as much as that of the planet's rotation. Allowance being made for the comparative slowness of the satellite's tides, the satellite's period would still be changed more than ten times as much as that of the planet. It would be only when the little body got further out, and the planet's rotation slower than it now is, that there could be a reversal of the direction of the satellite's tides. Wherever started, the satellite must either go directly into the planet, or go out a short distance and back into the planet, before the rotation-period can have been much changed by solar tides; or else the satellite must go far out—as when it gets a fair start—and could not possibly turn back until the rotation of Mars be slower than now. Hence it seems that under no conditions could the rotation of Mars, at the birth of her moon, have been twice as rapid as now, and the evidence is very strong that the rotation-period could not have been changed more than a very few hours, if so much. Then, if the rotation of Mars was so slow in the beginning, and so little changed during the whole existence of the satellite, the circumstance does not support the view that the earth's rotation was very rapid in the beginning and so much changed during her past history, but rather inclines the other way.

Respecting the statement that two heavenly bodies cannot revolve about their centre of inertia as parts of a rigid body with their surfaces nearly in contact, unless one be smaller and denser than the other by a certain amount, I can only say, at the present time, that such was the conclusion at which I arrived when investigating the results of the tidal effects of two bodies on one another at close quarters. Without going far into the question, it can be seen that if the rule holds when the two bodies are of the same size and density, it will hold throughout. There will be no difficulty in seeing that the rule holds so far that when the difference in size between the bodies is as great as

between any of the satellites and its primary, the small body must be invariably the denser. Now the argument that was supposed to apply in general would at least apply in the case of the solar system. That argument, as explained in my pamphlet, was that, if a rapidly-rotating body were to separate into two, the small body given off must be denser than the other to withstand the tidal disturbance, and that it would be impossible for the small body to be denser than the primary, since the secondary body must be formed from the surface and therefore lightest part of the other body.

JAMES NOLAN

Dergholm, Victoria, October 5

Seismometry in Japan

I HAVE read, with no small surprise, a paragraph in NATURE of November 11 (p. 36), giving a summary of a letter from Prof. John Milne, with reference to an article by me on the seismographs now manufactured by the Cambridge Scientific Instrument Company. Prof. Milne is represented as saying that, "with the exception of one or two which have been modified, a set of instruments like those recommended by Prof. Ewing are, so far as Japan is concerned, quite obsolete." His letter is not published, and it is possible that the paragraph inadvertently does him an injustice in making him assert what has absolutely no foundation in fact.

In any case the statement cannot be allowed to pass without contradiction. My seismographs have been in regular use at the University of Tokio since they were invented; they are now used for systematic observations by the Japanese Meteorological Bureau; they were sent last year by the Japanese Government to the Inventions Exhibition in London, where they were awarded the highest diploma among Government exhibits: one of them, the comparatively cheap and simple duplex pendulum seismograph, is employed by many private observers in Japan. In a letter received only a few weeks ago, my friend and former assistant, Mr. Sekiya, now Professor of Seismology in the University, says:—

"We are going to start a journal called the *Journal of the Science College of the Imperial University, Japan*. In the first number I will give a paper on 'Comparison of Earthquake Diagrams simultaneously obtained at the same station by two instruments involving the same principle, and thereby proving the trustworthiness of these instruments.' Of course I treat those diagrams recently obtained by two of your seismographs."

Other letters from Prof. Sekiya are full of accounts of the excellent work he is doing with these instruments, and of their continued and extended usefulness in his very able hands. A paper lately received from him describes a rough but effective form of the duplex pendulum, cheaply made in order to bring it within the reach of private observers, and with reference to this the *Japan Mail* of February 2, 1886, says:—

"The duplex pendulum seismograph designed by Prof. J. A. Ewing, has been employed for earthquake observations in the Tokio Daigaku by Mr. S. K. Sekiya, who has improved many of its details during his long use of the instrument. On account of the simplicity and scientific nature of its construction, and its easy management, it has found its way into the hands of many observers."

The *Mail* goes on to mention the name of a native firm by whom the instrument is made and sold. In March last Mr. Sekiya writes:—"The duplex pendulum sells well; some fifty or twenty of them have been sold."

So much for the duplex pendulum seismograph, which is one of those described in my article, and now made with the utmost refinement of construction by the Cambridge Company. The other is a three-component instrument, of which the principal part is the horizontal pendulum seismograph—consisting of a pair of horizontal pendulums for recording separately two rectangular components of the horizontal motion of the ground on a moving surface driven by clockwork. This method of recording earthquakes was introduced by me in 1880 (*Trans. Seis. Soc. Jap.*, 1880; *Proc. Roy. Soc.*, No. 210), and has been in regular use ever since. The instruments made to my designs by native workmen are still doing good service in Prof. Sekiya's hands. Those now made by the Cambridge Company have the advantage of better workmanship and an improved arrangement of parts. As Prof. Sekiya has recently written to me with regard to the purchase of a set of them by the Japanese Government, it is probable that Mr. Milne will before long have

an opportunity of seeing the latest forms of the instruments in Japan.

No one knows better than Prof. Milne that the horizontal pendulum seismograph is not obsolete. He adopted it himself soon after I introduced it, and he has used it freely in his own investigations. His letter will be understood to mean that since I left Japan in 1883 there has been a new departure in seismometric methods which has made my apparatus fall out of date. There has been nothing of the kind. Can Mr. Milne point to any methods involving novel features of importance, and say what their novel features are? It would be odd for instruments to become obsolete when they answer their purpose very well, and when there is nothing better to take their place.

J. A. EWING

University College, Dundee, November 13

Ozone Papers in Towns

I TAKE the opportunity of mentioning that I have experimented with Moffatt's ozone papers in London for the past month, and find that on exposing the papers already previously coloured they all become bleached to their original white. They were previously exposed to the air at Brighton and Hastings, on the sea-coast, and were then coloured, and afterwards preserved closely shut up for trial in the mephitic air of towns.

Some more stained papers were also received from Cheltenham, which also became bleached on open-air exposure in London, though as highly stained as 8 degrees. They were not washed by rain, but kept dry in the usual cage in the open air and out of the sun; and they were of various shades of colour, from 2 to 8, as already marked on them. I should like to know or ask for opinion as to the chemical changes that had taken place, and if these had been due to an antozone causing a recombination of the ingredients (starch and iodide potassium) to their original constitution. It may be likely, therefore, that in Moffatt's papers, coloured previously, we may have the means of testing the impure condition of the air of any locality by exposing them in it for a few hours.

Other papers had already been prepared for testing the sulphurous impregnation of the town air, as by compounds of lead, tin, &c.; but, though they became stained in the laboratory, yet they failed on trial in the open air. As to the influence of the wind, the quickest effect seemed to be produced by easterly winds, while those from the south-westerly direction were slower in action on the papers; but this, I think, may be merely due to the air from the east in London blowing first over a greater expanse of city, carrying with it adulterating emanations.

W. J. BLACK

London, November

The Similarities in the Physical Geography of the Great Oceans

IN the abstract of my paper read at the Royal Geographical Society on the 8th inst., which was published in NATURE of Nov. 11, there is a statement (p. 34) that the weight of the column of water between 20 fathoms and 70 fathoms from the surface under the westerly equatorial current is only 88 per cent. of the weight of the same column under the easterly counter equatorial current. I regret that a serious arithmetical error occurs in the calculations on which this statement was founded. There is no such considerable difference of weight in the two columns of water.

J. Y. BUCHANAN

Edinburgh, November 22

Lung Sick

DR. E. J. DUNGATE, with compliments to the Editor of NATURE, begs to inclose him a letter which he has just received from Prof. Smets, of Hasselt. It refers to the letter on "lung sick," which appeared in NATURE for November 11 (p. 29), and contains most important evidence on the subject. Dr. Dungate is sure, from the genial tone of the letter, that the Editor of NATURE is at liberty to publish it, if he desires.

6, Marchmont Road, Edinburgh, November 17

Hasselt (Belgique), le 14 Novembre, 1886

MONSIEUR DUNGATE, — J'ai lu votre demande dans la NATURE du 11 Novembre.

L'inoculation préventive de la pleuropneumonie exsudative a commencé à Hasselt, et la méthode, suivie déjà chez les

Zoulous, a été préconisée, en premier lieu, par un médecin de Hasselt, M. le Dr. Willems. Je vous communiquerai, avec plaisir, ses travaux si vous les désirez.

On a essayé, à diverses reprises, à Hasselt, les inoculations au fanon, à la poitrine, etc.; elles ont eu des conséquences mortelles.

Je crois que cette pratique permettait au microbe d'envahir rapidement les poumons, et d'étouffer le bœuf. Mais quand on pratique l'inoculation à la queue, le microbe a passé par les divers stades de son existence, et est déjà à son déclin avant d'arriver au poumon. Il est possible aussi que le microbe, que je crois fortement aérobie, a été atténué dans sa virulence par suite de son passage dans des organes où l'oxygène est plus rare.

Plusieurs fois, néanmoins, l'inoculation est encore mortelle, en moyenne 1 cas sur 100 inoculations à Hasselt.

La perte de la queue est due, à mon avis, à ce que l'on fait usage d'un virus impur, obtenu empiriquement, sans culture. La gangrène, qui emporte une partie de la queue, peut être causée par un autre organisme inoculé simultanément avec le microbe de la maladie. Car, parfois, plusieurs bêtes inocuées en même temps, avec le même virus, ne perdent pas la partie inférieure de la queue, tandis que d'autres fois cet accident est fréquent. On prévient partiellement cet accident en faisant des incisions longitudinales dans l'engorgement qui se produit.

Agréez, Monsieur Dungate, l'expression de ma considération distinguée et de mon entier dévouement.

DR. GÉRARD SMETS,

Professeur à Hasselt (Belgique)

Meteor

PASSING along Kensington Gore yesterday at 7.20 p.m., I saw the finest meteor I have ever seen in my life. It descended from near the zenith perpendicularly through the constellation of the Great Bear. It was much larger than any planet. About half-way on its downward course it gave out a second meteor of a red colour, being itself of a pale yellow. The atmosphere was rather foggy at the time, but I could see the stars through the mist. It was, no doubt, the same meteor as is mentioned in to-day's Times as having been seen at Reading.

P. L. SCLATER

3, Hanover Square, London, W., November 18

The Origin of Species

MR. CATCHPOOL, writing in NATURE (vol. xxxiv. p. 657) on this subject, says:—"If B is separated from A by being nearly infertile, and C from B in the same way, C is likely to be still more infertile with A." This is quite a mistake. Suppose B to be the cat species, and A and C two varieties of dogs; A and C are quite fertile with each other, and infertile with B.

It is certain that mutual infertility is not caused by mere visible unlikeness. The horse and the ass, which do not produce fertile offspring, are much less visibly unlike than many of the varieties of dogs or of pigeons, which are mutually quite fertile.

May not mutual infertility be a result of long-continued separation, quite independently of any unlikeness arising? I do not know whether this conjecture is supported by any observations on the mutual relations of kindred species or varieties in lands separated by oceans.

JOSEPH JOHN MURPHY

Belfast, November 8

MR. MURPHY has mistaken my meaning, which I will try to make clear by an example. Suppose one brood of an ancient species of Gallinæ to have exhibited, as a sport, a partial infertility with the rest of the species, while the birds composing the brood remained abundantly fertile among themselves. Suppose the main body of that species to have become, by natural selection, our pheasants, while the isolated brood became the ancestors of our grouse. Suppose one brood of these grouse to have become partially infertile with the main body of grouse and to have been the ancestors of our red grouse, while the main body of the grouse became, by natural selection, our black grouse. If, as I believe, variation does not produce or increase infertility, the black grouse will still be only partially infertile with the pheasant, and the red only partially infertile with the black grouse; but it seems probable, *prima facie*, that the second spontaneous infertility would remove the red grouse

farther from the pheasant, so that these would be quite infertile. But this is merely argument from analogy; there is no evidence of the result of such superposed "sports," and retrogression to greater fertility seems possible.

This instance is not a good one, because the observed partial infertility (*i.e.* only occasional fertility) between pheasant and black grouse may be due to dislike, not partial impotence. But I doubt whether distaste for pairing and impotence when paired are often quite dissociated.

Mr. Murphy asks, as I asked in these pages in 1884, and others have asked since, for one simple fact which would be decisive. Is it, or is it not, the fact that allied species which are confined each to a particular island, prove, when brought together, far less frequently infertile than species, equally dissimilar, which had lived in the same district, might be expected to prove. On the answer to this question depends, as far as I can see, the fate of the theory of physiological selection. Can no one answer it?

EDMUND CATCHPOOL

THE CORAL REEFS OF THE SOLOMON ISLANDS

OUT of a collection of nearly seventy corals which I made in these islands, nearly a quarter are new or undescribed; and from this fact, as I am informed by Mr. S. Ridley, it may be inferred that there is yet much to be learned of the corals of this region. After describing in my paper the characters of a typical reef, I proceeded to refer to the complex relations that exist between the multitudes of creatures that frequent coral reefs. The protective colouring of the small crabs that live among the branching corals often attracted my attention. I recall, in particular, the instance of a small crab that finds its home among the branches of a *Pocillopora*. The light purple colour of its carapace corresponds with the hue of the coral at the base of the branches, where it lives; whilst the light red colour of the big claws, as they are held up in their usual attitude, similarly imitates the colour of the branches. To make the guise more complete, both carapace and claws possess rude hexagonal markings, which correspond exactly in size and appearance with the polyp-cells of the coral. Another species of crab, that climbs about the blue-tipped branches of a *Madrepora*, has the points of its pincer-claws similarly coloured. It is interesting to note that these two crabs are adapted to live each on its own species of coral. Had I caused them to exchange their homes, their borrowed hues and markings would have at once made them conspicuous objects for their enemies.

I paid especial attention to the inter-tidal exposure of living corals, and was much surprised at the number of species which are bared by the ebbing tide. Of all the corals in these islands, those belonging to the genus *Caloria* seem to be the hardiest in this respect. In the paper I have described my observations with some detail.

Coral Reefs and Shoals.—The earliest condition of the coral reefs in this group is to be found in that of the numerous detached submerged reefs or shoals which lie below the limit of the constructive power of the breakers, having been arrested in their upward growth at depths varying between 5 and 10 fathoms according to the exposed or protected character of their situation. This remarkable fact of the arrest of the upward growth of the coral at these depths was utilised by Lieut.-Commander Oldham whilst surveying these submerged reefs in H.M.S. *Lark*. If a shoal was not marked at the surface by a reef-flat or by an islet, we could sail over it with perfect safety. The broken water of the tide-rip that indicated these shoals was no source of danger for a vessel of light draught. In my paper I have given evidence to prove that a shoal which was found by Bougainville in 1768 to be covered by 5 fathoms, remains in the

same condition at the present day. The number of coral shoals possessing these characters led me to the conclusion that isolated submerged reefs are unable without the assistance of a movement of elevation to raise themselves to within the constructive power of the breakers. When they have reached their upward limit, they extend laterally, forming ultimately flat-topped shoals. It may appear bold to suggest that atolls and barrier-reefs owe their appearance at the surface to a movement of elevation; but we know that in the regions occupied by the atolls of the Low Archipelago, of the Fiji Islands, and of the Pelew Group, the last movement experienced has been one of elevation; whilst the observations of Mr. Beete Jukes on the Australian Barrier-Reef go to show that, if there has been a recent change of level in that region, it was one of the same nature. In the atoll of Oima in the Solomon Group I found evidence of an anterior elevation.

In my paper I proceeded to describe at some length the reefs that have reached the surface. In this abstract, however, I can only refer to the fact that all the three classes of reefs are to be found in this group; the atolls, I should add, being comparatively few in number and of small size.

The Formation of Atolls.—My observations go to show that atolls of small size (a mile or two across) do not assume their characteristic form until they have reached the surface. After upheaval has brought a submerged coral shoal within the constructive power of the breakers, it soon appears at the surface as an isolated patch of reef. Extensions or wings grow out on either side, and, guided by the prevailing currents (in the manner described by Semper), they ultimately form the common horse-shoe reef, which presents its convexity against the currents. Large atolls evidently begin to assume their characteristic shape below the surface as described by Murray and A. Agassiz.

The Formation of Barrier-Reefs.—The facts on which my conclusions have been based were obtained by the examination of the weather slopes of reefs. For the first 70 or 80 yards from the weather edge of a reef there is a gradual slope, largely bare of living coral, to a depth of 4 or 5 fathoms. There is then a rapid descent to a depth varying between 12 and 18 fathoms. It is this declivity that constitutes the growing edge of the reef, and the sand and gravel produced by the constant action of the breakers collect at its foot. When the submarine slope is more than 10° or 12° , as is usually the case, the sand and gravel extend far beyond the depths in which reef-corals thrive; but when the slope is gradual, *i.e.* less than 5° , the lower margin of this band of detritus lies within the reef-coral zone, and in consequence a line of barrier-reef is ultimately formed beyond this band with a deep-water channel inside (*vide* diagram). Should the

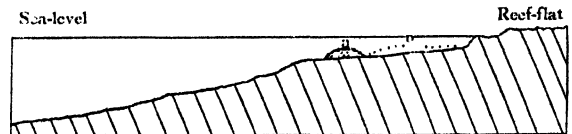

Barrier-reef of Choiseul Bay (drawn on a true scale to the 200-fathom line. *a* = incipient barrier-reef (size purposely exaggerated); *b* = belt of sand and gravel.

area be undergoing elevation, a succession of concentric lines of barrier-reefs will originate, line after line being advanced as fresh portions of the sea bottom are brought towards the surface, each line growing upward along the lower margin of the band of detritus derived from the line of reef inside it. In such a manner have the Shortland Islands been produced. When I arrived at the above conclusion I was not aware that substantially the same explanation had been advanced thirty years before by

Abstract of a Paper by H. B. Guppy, M.B., late Surgeon H.M.S. *Lark*. Communicated by Dr. John Murray to the Royal Society of Edinburgh on July 5, 1886.

Prof. Joseph Le Conte in the instance of the Florida reefs. He then pointed out that since corals will not grow on muddy shores or in water upon the bottom of which sediment is collected, the favourable conditions can only be obtained at some distance from the shore, where a barrier-reef would ultimately be formed *limited on one side by the muddiness and on the other by the depth of the water.*

The foregoing conditions may be described as the determining causes of a barrier-reef. After the reef has been formed, the lagoon-channel will be kept open by such agencies as solution, diminished food-supply, tidal scour, organic degradation, and other influences. The circumstance that barrier reefs are frequently situated at or near the borders of submarine plateaus receives a ready explanation in the view first advanced by Prof. Le Conte, since in such situations the necessary conditions of depth and clearness would be found.

Anomalous Depths of some Atolls and Barrier-Reefs.—

One of the principal arguments in favour of the theory of subsidence lies in the assertion that lagoons and lagoon-channels are sometimes deeper than the reef-coral zone. I will, however, endeavour to show that this assertion is founded on a misconception of the conditions that limit the depth of this zone. The extent to which the depth may vary is demonstrated in the great divergence between the estimates of different observers in every region of coral reefs. Those of Quoy and Gaimard, Ehrenberg, Darwin, Dana, Murray, A. Agassiz, and others, range from 5 to 40 fathoms. But this variation may also be found in the same region of coral reefs. Thus, in the Solomon Islands, I found that the depths at which reef-corals flourished ranged in different localities from 12 to 40 fathoms and beyond, the variation being due to differences of local conditions, such as the degree of inclination of the submarine slope, the presence and position of submarine declivities, the amount of sediment held in suspension, the force of the breakers, and other influences. The main determining condition, as Prof. A. Agassiz points out, is to be found in the injurious effect of sand and sediment rather than in the general influence of depth; and the distribution of these materials is dependent on the local conditions above referred to. Local conditions will usually restrict the reef-coral zone to depths less than 30 fathoms; but, where there is a gradual submarine slope, reef-corals are to be found in depths beyond the sand and gravel. Inasmuch as most observers have regarded these materials as necessarily limiting the zone, they did not push their inquiries beyond. Under favourable conditions, however, reef-corals may thrive in depths of 50 or 60 fathoms; and thus we can readily explain the apparently abnormal depths inside some atolls and barrier-reefs.

An apparent objection here presents itself. If reefs begin to build their foundations in depths greater than those which are generally assigned to them, the thickness of the elevated reef-formations discovered by me in the Solomon Group should have been much greater than 150 feet, the actual limit of their thickness. It will, however, have been gathered from the previous remarks that local conditions will usually confine reef-corals to depths less than 25 or 30 fathoms, and that it will be only under occasional circumstances that reefs will commence to be formed in deeper water. Fringing-reefs themselves are at first restricted to shallow waters around the coast, and their seaward extension in localities where the submarine slope is at all steep, as is generally the case, must be extremely slow. Again, in an area of elevation, such as that in which the Solomon Islands are included, barrier-reefs, which may have begun to grow in depths not less than 50 fathoms, might owe their approach towards the surface as much to the elevating movement as to the very slow upward growth of the corals. It should also be borne in mind that the rapid subaërial denudation, to

which these regions of heavy rainfall are subjected, would be an important agency in the thinning away of the raised coral formations.

In the latter part of my paper I refer, amongst other subjects, to the extensive character of the degradation of coral reefs by multitudes of organisms. I also give proofs of the outward growth of reefs on their own talus (as described by Murray)—(1) in the circumstance that massive corals may be commonly observed to increase in size as one approaches the lagoon from the outer margin of the reef-flat; (2) in the presence of old lines of erosion evidently produced at the existing sea-level, but which have been cut off from the action of the waves by the advancing edge of the reef-flat; (3) in the characters and position of the wooded islets situated on reefs, which in course of time would cover the whole reef-flat, were it not for one counteracting circumstance, the seaward growth of the reef.

Lastly, I refer to the deposits at present forming on the outer slopes of reefs in depths down to 100 fathoms. Reef-debris, foraminiferous tests, especially of *Orbitolites*, joints of the calcareous alga *Halimeda opuntia*, portions of *Nullipora*, and the small detached corals of the genus *Heteropsammia*, enter largely into the composition of these deposits. I should add that a rock of this composition is one of the commonest types of the so-called coral limestones in the Solomon Group.

In this short abstract of a long paper I have not been able to do much more than indicate the general bearing of my conclusions. The facts and data are given at length in the original paper.

THE BRITISH ASSOCIATION AND LOCAL SCIENTIFIC SOCIETIES

THE second annual Conference of Delegates held under the new rules of the British Association met at Birmingham on September 2 and 7, in the library of the Medical Institute. Forty-nine local Societies carrying on work in various parts of the United Kingdom have been enrolled this year as "Corresponding Societies" of the Association, and of these thirty-two were represented by Delegates at the Birmingham meeting. The following report of the proceedings of the Conference, signed by Mr. Francis Galton and Prof. R. Meldola, the Chairman and Secretary of the Committee, has just been circulated among the Corresponding Societies, and it will be seen that this new branch of the work of the Association promises to be of mutual advantage both to the Societies and the Association:—

At the first Conference the chair was taken by Dr A. W. Williamson, F.R.S., General Treasurer of the British Association, the Corresponding Societies Committee being represented by Captain Douglas Galton F.R.S., General Secretary of the Association, Dr. Garson Mr. John Hopkinson, F.L.S., and Prof. R. Meldola, F.R.S. Secretary.

The Secretary read the Report of the Corresponding Societies Committee which had been presented to the Council of the Association.

The Chairman made some remarks explanatory of the objects of the Conference of Delegates, and suggested that among other subjects of investigation in which it might be useful to secure the co-operation of the local Societies was that of injurious insects, already so much studied by Miss E. A. Ormerod.

The Secretary also made some observations in explanation of the constitution of the Corresponding Societies Committee and the relations existing between the Conference of Delegates and the British Association.

Some remarks were made by Mr. J. W. Davis and others with reference to the advisability of securing the co-operation of the local Societies for the purpose of it

investigating British Barrows and other prehistoric remains. This suggestion had been put forward at the Aberdeen Conference last year by Prof. Meldola, and a Committee was about to be formed by Section H for carrying out this object.

Mr. H. Heywood considered that the relationship now existing between the British Association and the Corresponding Societies had already been of great assistance to the Societies themselves. In the case of his own Society (Cardiff) they had been able to assist one of the Committees (Erratic Blocks) brought under the notice of the Aberdeen Conference last year.

Prof. Lebour stated that many of the local Societies, such as the North of England Institute, which he represented, were composed of engineers connected with large works, who might make useful investigations which would be facilitated if backed up by the authority of the British Association. For this reason he hoped that other subjects besides natural history, geology, or anthropology would be recognised at the Conferences.

Captain Galton explained that the object of the Conference of Delegates was to bring the Corresponding Societies into direct communication with *all* the Committees of the British Association, to which the local Societies or individual members of these might render assistance. This could of course be only effected by degrees, but he suggested that as a preliminary step it might be found useful to place the Delegates on the Committees of those Sections in which they or their Societies had the most interest.

Dr. Williamson supported this proposition, and the Secretary took down the names of the Delegates to be attached to the various Sectional Committees.

Prof. Hillhouse and Dr. Garson expressed their willingness, as Secretaries of Sections D and H respectively, to propose Delegates as members of the Sectional Committees.

Mr. Hopkinson suggested that among other methods of promoting work among local Societies it might be found advantageous for the Delegates themselves to make suggestions at the Conference which might lead, through the proper channels, to the formation of new Committees by the British Association. He stated that his own Society (Hertfordshire) had already rendered material assistance to the Erratic Blocks Committee of the Association, and they hoped to render similar service to the Underground Waters Committee.

The following resolution, framed with the object of keeping the Corresponding Societies informed of the work being done by the British Association Committees, was moved by Dr. Garson, seconded by Captain Galton, and passed unanimously:—

"That the Secretary of the British Association be requested to send a list of the several Committees appointed by the Association to each of the Delegates of the Corresponding Societies, or to the Secretaries of these Societies, as soon as possible after the meeting of the Association, together with a copy of the proceedings of the meetings of the Conference of Delegates."

At the second Conference the chair was taken in the absence of Dr. Williamson by Prof. Boyd Dawkins, F.R.S., the Corresponding Societies Committee being represented by Dr. Garson, Mr. John Hopkinson, F.L.S., and the Secretary, Prof. R. Meldola, F.R.S.

The Secretary read the minutes of the proceedings of the first Conference, and it was stated that in accordance with the decision then arrived at the Delegates had been placed on the respective Sectional Committees as "Delegate Members."

The Chairman directed attention to the kind of work which might be done at the Conferences, stating that as a member of the Council of the British Association he knew that the Association was anxious to consolidate the

work of the local Societies. He suggested that the best mode of procedure would be to take the different Sections *seriatim*, and hear the recommendations forwarded by the Committees of these Sections, together with suggestions by the Delegates respecting the lines of investigation in which the local Societies could take part.

SECTIONS A AND B.—No recommendations from the Committees of these Sections having been forwarded to the Secretary of the Conference, the Chairman invited suggestions from the Delegates.

Luminous Meteors.—Mr. F. T. Mott suggested that much useful work might be done if the local Societies would undertake to record systematically the appearance, position, direction, &c., of luminous meteors.

The Secretary stated that a Committee of the British Association was for many years in existence for the purpose of carrying out these observations, but, for some reason unknown to him, the Committee appeared now to have ceased its labours.

Magnetic and Tidal Observations.—Mr. J. Martin White suggested that some of the local Societies which were favourably situated for the purpose might undertake systematic observations of local tidal and magnetic phenomena.

Meteorological and Phenological Observations.—Mr. Heywood stated that many valuable meteorological observations were buried in the log-books of steamships, and suggested that some of the local Societies might render good service to meteorology by examining these books and keeping records of any important entries. Mr. Hopkinson pointed out two ways in which the local Societies might advance meteorological science. In the first place he thought that many observers in different parts of the country might be in the habit of recording the rainfall or other meteorological phenomena without communicating the results to Mr. Symons. Good service would be rendered if the Corresponding Societies would find out such observers and put them into communication with Mr. Symons.¹ In the next place he suggested that observations of the time of flowering of plants, first appearances of birds and insects, &c., might be systematically recorded and forwarded to the Royal Meteorological Society by those observers who had not hitherto been in the habit of communicating their results to that Society.

SECTION C.—Mr. C. E. De Rance, F.G.S., attended the Conference on behalf of the Committee of this Section. The three following recommendations were forwarded by the Secretary of the Section:—

Sea Coasts Erosion.—"That Messrs. R. B. Grantham, C. E. De Rance, J. B. Redman, W. Topley, W. Whitaker, and J. W. Woodall, Major-General Sir A. Clarke, Admiral Sir E. Ommanney, Sir J. N. Douglass, Captain J. Parsons, Captain W. J. L. Wharton, Prof. J. Prestwich, and Messrs. E. Easton, J. S. Valentine, and L. F. Vernon Harcourt be reappointed a Committee for the purpose of inquiring into the Rate of Erosion of the Sea Coasts of England and Wales, and the influence of the Artificial Abstraction of Shingle or other Material in that Action; that Messrs. De Rance and Topley be the Secretaries."

Underground Waters.—"That Prof. E. Hull, Dr. H. W. Crosskey, Captain Douglas Galton, Prof. J. Prestwich, and Messrs. James Glaisher, E. B. Marten, G. H. Morton, James Parker, W. Pengelly, James Plant, J. Roberts, Fox-Strangways, T. S. Stooke, G. J. Symons, W. Topley, Tylden-Wright, E. Wethered, W. Whitaker, and C. E. De Rance be reappointed a Committee for the purpose of investigating the Circulation of the Underground Waters in the Permeable Formations of England, and the Quality and Quantity of the Waters supplied to various towns and districts from these formations; and that Mr. De Rance be the Secretary."

Erratic Blocks.—"That Profs. J. Prestwich, W. Boyd Dawkins, T. McK. Hughes, and T. G. Bonney, Dr. H. W.

¹ G. J. Symons, F.R.S., 62, Camden Square, London, N.W.

Crosskey, and Messrs. C. E. De Rance, H. G. Fordham, J. E. Lee, D. Mackintosh, W. Pengelly, J. Plant, and R. H. Tiddeman be reappointed a Committee for the purpose of recording the position, height above the sea, lithological characters, size, and origin of the Erratic Blocks of England, Wales, and Ireland, reporting other matters of interest connected with the same, and taking measures for their preservation; and that Dr. Crosskey be the Secretary."

Mr. De Rance described the above three inquiries undertaken by Section C, in which it was thought the Corresponding Societies could render valuable assistance. Forms of inquiry had been circulated largely by these Committees, and it was suggested that any work done by the Corresponding Societies should be on these forms printed by the British Association. Mr. De Rance stated that forms would always be supplied to the Secretaries of Corresponding Societies applying for them.

Dr. Crosskey made some remarks explanatory of the work of the Erratic Blocks Committee. He stated that the assistance of the local Societies would be particularly valuable in this inquiry, and that he would be happy to supply the necessary forms to the Corresponding Societies in the hope that they would be filled up. He urged upon the Delegates the necessity for preserving these boulders, which were everywhere being broken up, and were rapidly disappearing from off the face of the country.¹

Earth-Tremors.—Prof. Lebour stated that for some time past the North of England Institute of Mining and Mechanical Engineers had had a Committee actively engaged on the subject of earth-tremors and their possible connection with mine-explosions. This subject was naturally related to those of Sections A, C, and G of the British Association, and its investigation might be powerfully promoted by them. Some of the Corresponding Societies might aid greatly in making and recording observations on earth-tremors in various parts of the country. The more extensive the area over which such observations were made (if by competent observers and with suitable instruments) the more valuable they become; but it was very important that there should be some general understanding between the observers in different parts of the country, in order that some degree of that uniformity which is so desirable in matters of this kind should be attained. The cost of the expensive instruments necessary would be much lessened if large numbers of them were used. The question of earth-tremor observations was only one of many in which the engineering Societies and the British Association could be mutually useful, the former carrying out the work and the latter lending the influence of its official recognition and support.

The Rev. J. M. Mello stated that colliery proprietors were generally unwilling to spend money in investigations unless some very specific form of inquiry was circulated.

Mr. Hopkinson remarked that the Corresponding Societies, if supplied with the necessary forms, would no doubt be willing to circulate them among their members. Mr. Heywood thought the suggestion for observing and recording earth-tremors a most valuable one, and he remarked that the Cardiff Society would be happy to assist in the investigation if the formation of a Committee was sanctioned by the Association.

SECTION D.—The Committee of this Section was represented by Prof. W. Hillhouse, M.A., F.L.S.

Preservation of Native Plants.—In reply to a question by the Secretary, Prof. Hillhouse stated that in response to the inquiries which he had circulated among the Dele-

gates and others likely to furnish information, he had received details from twelve or fourteen localities recording between two and three hundred disappearances of plants. Mr. Stirrup stated that for years past a great destruction of plants had been going on in the Manchester district, and the local Societies had found it necessary to strongly inculcate among their members the necessity of preventing this extermination. Mr. Hopkinson remarked that a similar rule had been always observed by the Hertfordshire Society with respect both to animals and plants, and he thought that all the local Societies should adopt it. Mr. Mott pointed out that one practical result illustrating the benefit of Prof. Hillhouse's resolution had been the omission of the localities of all the rare ferns and orchids from the flora of Leicestershire, which his Society was just about to publish.

Local Museums Committee.—Mr. Mott stated that joint Committee, composed of representatives of Section C and D, had been recommended for appointment for the purpose of reporting upon the provincial museums of the United Kingdom. The work of this Committee would be much facilitated by the co-operation of the local Societies, and he hoped that the Delegates would bring the matter under the notice of their respective Societies. The Committee consists of Mr. V. Ball, Mr. H. G. Fordham, Profs. Haddon and Hillhouse, Dr. Macfarlane, Prof. Milnes Marshall, Mr. Mott (Secretary), Dr. Traquair, and Dr. Henry Woodward.

In reply to a question as to whether the work of this Committee was to be confined to public or to extend to private museums, Mr. Mott stated that it might be found desirable to extend the report to some few private museums.

The Chairman remarked that the Local Museums Committee was one of the most important that had yet been formed. The local museums of this country were generally in a most deplorable state, and one of the first things to be done was to exclude from such collections all extraneous specimens that were not truly local. According to his experience, he had found that it was impossible for local Societies to flourish and at the same time to carry on a large museum successfully. The two organisations should be independent, but at the same time it was most desirable that the objects collected by local Societies should be handed over to the nearest local museum. With reference to this question of local museums, he considered that we in this country were much behind Germany, America, and France.

A short discussion took place with reference to the naming of specimens in local museums, in which Mr. Eve, Mr. Hopkinson, and the Chairman took part.

SECTION H.—The Committee of this Section was represented by Dr. Garson, who stated that one Committee which was about to be formed on the recommendation of their Section had arisen from the suggestion made by Mr. J. W. Davis at the last Conference.

Prehistoric Remains.—The following is the resolution sent up to and adopted by the Committee of Recommendations:—"That Sir John Lubbock, Dr. R. Munro, Mr. Pengelly, Prof. Boyd Dawkins, Dr. Muirhead, and Mr. J. W. Davis be appointed a Committee to ascertain and record the localities in the British Islands in which evidence of the existence of prehistoric inhabitants of the country is found."

Prof. Meldola stated that three years ago he had brought this subject under the notice of the Delegates in a paper which he had read at the Southport meeting of the Association, and which had been published in abstract in the volume of Reports for 1883, and *in extenso* in the *Transactions* of the Essex Field Club.¹ He remarked that the work which the Committee proposed to undertake was of the greatest national importance in view

¹ The addresses of the Secretaries of these three Committees are:—*Underground Waters.*—C. E. De Rance, F.G.S., A.I.C.E., 28, Jermyn Street, London, S.W.

Erratic Blocks.—Rev. H. W. Crosskey, LL.D., F.G.S., 117, Gough Road, Edgbaston, Birmingham.

Sea Coasts Erosion.—Wm. Topley, F.G.S., A.I.C.E., 28, Jermyn Street, London, S.W.

¹ See NATURE, vol. xxix. p. 19.

the great destruction of ancient remains that had been going on for many years.

The Chairman remarked that the subject was undoubtedly one of great importance, and some of the local societies had already commenced to record the position of these remains on the Ordnance maps. He stated that according to his experience the 1-inch map could be used, but the 6-inch map would be found much better. One desideratum in the work was a good system of symbols; such a system had been employed in a map of ancient remains recently published in France, and he stated that he should be happy to place this system at the disposal of the Committee. He added that he was glad to be able to announce that he had succeeded in getting an Act passed for the preservation of the ancient monuments of the Isle of Man.

Preservation of Stonehenge.—Dr. Garson stated that the Committee of Section H had forwarded a resolution to the Committee of Recommendations with reference to the preservation of Stonehenge, and, pending its consideration by this Committee, it had been suggested that should also be brought under the notice of the Corresponding Societies through their Delegates, with the object of these using their influence, as far as possible, for the preservation of this and other monuments throughout the country. The following is the resolution referred to:—"That the attention of the proprietor of Stonehenge be called to the danger in which several of the stones are at the present time from the burrowing of rabbits, and also to the desirability of removing the wooden props which support the horizontal stones of one of the trilithions, and, in view of the great value of Stonehenge as an ancient monument, to express the hope of the Association that some steps will be taken to remedy these sources of danger to the stones."

This resolution had originated last April during a joint meeting of the Geologists' Association and the Hampshire Field Club on Salisbury Plain, when copies were ordered to be forwarded to the proprietor, to the Inspector of Ancient Monuments, and to the Secretary of the Corresponding Societies Committee of the British Association. The proprietor of these valuable remains had hitherto refused to take advantage of the Ancient Monuments Act, though repeatedly requested to do so, neither had he paid attention to their proper preservation, so that it had been thought desirable to move the foregoing resolution which had been sent to the proper quarter for confirmation by the General Committee of the Association.

Election of Corresponding Societies.—At the termination of the Conference, Mr. Davis raised the question whether Corresponding Society when once admitted by the Association should not always be retained on the list.

The Secretary explained that the election of Corresponding Societies took place *annually*, and that each of these Societies would be expected to make an annual application for re-election on the printed forms sent out before June. There was no reason why a Society when once elected should not be re-elected every year as long as it kept up its scientific activity. He was of opinion that a failure on the part of a Corresponding Society to send a Delegate to any meeting of the Association should not disqualify that Society for re-election, although it was expected that when a Delegate did attend the meeting of the Association he should be present at the Conferences. Prof. Meldola further stated that some few of the Societies which had been elected last year did not appear in this year's list, the reason being that the Secretaries had not filled in and returned the printed forms sent out at the beginning of the year, nor had any notice been taken of a second application asking whether it was the wish of their society to be re-elected; so that, as Secretary of the

Corresponding Societies Committee, he had concluded that these Societies desired to withdraw, and they had accordingly been removed from the list.

THE COLONIAL AND INDIAN EXHIBITION

RESUMING our notes on some of the principal exhibits (NATURE, vol. xxxiv. p. 548), the Court running parallel with and between those of Mauritius and Seychelles on the one side and Cyprus and Malta on the other was that which contained the collection from the

WEST INDIES.

Vegetable products, as might be expected, formed the bulk of the exhibits in this attractive Court, which had an air of comfort and finish not excelled in any other part of the building. Entering the Court from the northern end, the first bay on the left hand was devoted to

Trinidad, an island celebrated both for the quantity and quality of the cocoa grown upon it, which indeed is the staple article of produce. The value of cocoa exported from Trinidad in 1885 is stated in the Official Hand-book to have amounted to 421,974*l.*, and in some "Notes on Trinidad Industries," by Mr. John McCarthy, F.C.S., the Assistant Commissioner for Trinidad, recently published, it is stated that the quantity of cocoa imported into England in 1885 amounted to 10,560 tons, against 10,120 tons in 1884, and 9986 in 1881. Numerous specimens of cocoa seeds are exhibited, as well as prepared cocoa and chocolate.

Mr. McCarthy describes the cultivation of the coconut (*Cocos nucifera*) as a very profitable industry, though the tree does not bear much before it is eight years old. Experiments, he tells us, "are now being tried in Trinidad to make it act as a shade tree to the cocoa (*Theobroma*)" instead of planting the quick-growing "Bois immortelle." The idea of this planting is to realise from the same land a double crop, namely, that from the *Theobroma* and that from the *Cocos*. It is estimated that seventy trees planted upon an acre of land would, when in full bearing, yield 5000 nuts per annum, which would net, on an average, from 3*l.* to 4*l.* per thousand in Trinidad. The annual import of nuts into London is said to be about 12,000,000, besides which, New York imports enormous quantities, and they are also used to a very large extent for the expression of oil in Trinidad itself. Coffee has also a prominent place in the products of Trinidad, and the plant is stated to thrive well, although it has not yet produced even sufficient coffee for home consumption. More attention has, however, been directed of late to coffee culture in the island, so that it is largely increasing. The cultivation of tobacco is also an industry that promises to become of some importance, and the tobacco is described as being second only to the finest Havana. There is a good exhibit of cigars, which are said to have met with general favour, so that a demand has arisen for them.

Bahamas.—In the Official Hand-book, Sir Augustus Adderley gives a very readable sketch of the history of these islands, and briefly refers to the natural products, foremost amongst which are corals and sponges. He describes the "sponging and wrecking vessels" as fine models and fast sailers, built by the islanders of native hard wood known as "horseflesh," and planked with yellow pine obtained from North Carolina. Conch shells are exported in large quantities to the value of about 1200*l.* per annum, and the pale pink pearls which are found in them to the extent of 3000*l.* per annum. The sponge exports were estimated at 60,000*l.* for 1885. Mention is made of the abundance of plants valued as medicines, many of which might be further developed by systematic trial of their effects in this country. Perhaps the two best known medicinal plants are the Canella Bark (*Canella alba*, Murr.) and the Sweet Bark or Cascarella

¹ This resolution was adopted by the Committee of Recommendations and affirmed by the General Committee.

(*Croton Eleuteria*, J. J. Benn.). The first has a bitter, acrid, and pungent taste, and a cinnamon-like smell. With us it is used as an aromatic stimulant, and as a condiment in the West Indies. The sweet bark is a bitter aromatic tonic, formerly used as a substitute for Peruvian bark, but now chiefly as an ingredient in pastilles and for mixing with tobacco for the sake of its pleasant musky odour. The cultivation of perfume-yielding plants is recommended as a probable commercial success, the demand for perfumes at the present time being so great that it has even been proposed to cultivate in Australia on a large scale such plants as are now grown at Grasse, Nice, and Cannes.

Jamaica.—The contents of this Court were both numerous and varied. Rum and sugar were fully illustrated by a large number of samples. Coffee was also well represented; of this article the Official Catalogue states that two distinct classes are produced in the island, the total annual export being about 84,000 cwt. per annum, of which about 10,000 cwt. is Blue Mountain coffee, a fine quality, consigned almost entirely to the Liverpool market. Pimento or allspice is a product exclusively of Jamaica, where it is grown in plantations or gardens known as "pimento walks." The commercial article consists of the dried berries, which were exported from Jamaica to the value of 53,867*l.* in 1885. It is very largely used as a spice as well as in medicine, on account of its aromatic and stimulant properties. The fruits contain a quantity of oil, which is obtained by distillation, and is used in perfumery and for similar purposes to which clove-oil is put. Pimento-sticks are amongst the strongest and best for walking-sticks and umbrella-handles, on account of their strength, rigidity, and non-liability to crack. The pimento-tree is of low growth, and is known to botanists as *Pimenta officinalis*.

In this Court were shown some remarkably fine samples of Annatto seeds (*Bixa Orellana*), noted for their plumpness, as well as for their bright colour, the waxy coating of the seeds being highly valued as a red colouring-matter. A large and interesting collection of fruits preserved in a salt-solution were here shown; amongst others the following will attract attention: Star-apple (*Chrysophyllum Cainito*), Cocoa-plum (*Chrysobalanus Icaco*), Blimbing (*Averrhoa Bilimbi*), Akee (*Cupania edulis*, better known, perhaps, as *Blighia sapida*). Many of these are the produce of introduced plants, and the fruits are for the most part fine examples. Amongst a number of specimens of essential oils from well-known plants, most of which are apparently of excellent quality, are some that are but very little known, such, for instance, as those from the Bermuda Cedar (*Juniperus bermudiana*), the Mountain Cigar Bush (*Hedyosmum nutans*), Mountain Thyme (*Micromeria obovata*), Cigar Bush (*Critonea dalea*), and the Sand Box-tree (*Hura crepitans*).

Barbados.—The exhibits from this island consisted largely of similar produce to the islands already referred to. As illustrating the extent of land occupied by sugar cultivation, it is stated in the introductory notice of Barbados in the Official Hand-book, by the Hon. C. C. Knollys, that "out of a total acreage of 106,470 acres, an area of 100,000 acres is devoted to canes." Tobacco is recommended for extended cultivation, and root-crops such as arrowroot and cassava give heavy returns.

British Honduras.—We take this dependency in this order, as it occupied a position in the Exhibition next that of Barbados. The importance of timber in the produce of British Honduras is seen by a simple glance at the exhibits, and to the future development of these timber resources lies in a very great measure the future prosperity of the colony. In the introductory notes to these exhibits the following paragraph occurs:—"To its timber and dye-woods the colony of British Honduras owes its existence, and whatever measure of progress and advancement it may have attained. To the discovery, first of logwood, and subsequently of mahogany, its

original settlement must be ascribed." Notwithstanding the importance of the forest produce, very few of the timbers are yet known either to commerce or to science but many of them are of exceptional hardness and beauty. Mahogany is, of course, the most important wood in the colony, and, next to it, the cedar (*Cedrela odorata*), which is not only exported to a very large extent, but is also used in the colony for light indoor work—cigar boxes, trunks, packing-cases, and for dug-out canoes; several of which were exhibited. Amongst a collection of lianes, or climbing-plants, is a specimen of the chew-stick (*Gouania domingensis*), with the singular information besides that of its use as a tooth-brush and tooth-powder: that "it is used in place of yeast to start fermentation in making ginger- and spruce-beer, &c." Probably the most striking object in this Court is a large and beautiful figured slab of mahogany; the dark wavy cross-marking are extremely beautiful and very remarkable in the wood; the plank is, moreover, without a flaw.

Dominica.—The space occupied by this island, as well as by the remaining colonies, was small; the exhibits of the whole, however, were interesting, and some were worth noting, such, for instance, as the husks or shells of the Liberian coffee, which are said to be worth from 1 to 2 cents. per pound in the United States, the fruits of *Acacia Farnesiana*, stated to be used in tanning and bark of Guava, the *Psidium Guayana*, which is rich in tannin, and is used as an astringent. Raw lime-juice is exported from Dominica in increasing quantities, but the greater part of the juice is boiled down until ten or twelve gallons are reduced to one, and is shipped in the concentrated form to England and the United States for the manufacture of citric acid.

Montserrat.—Sugar and lime-juice are the principal staples of this island, and these were the most prominent exhibits.

St. Kitts and the Virgin Islands.—From these islands the exhibits were but small, and without special interest.

Antigua.—The chief product of this colony is sugar, the average crop of which for the last twenty years is stated to have been about 12,000 hogsheads. Yam potatoes, and Guinea corn are also grown in large quantities for native consumption. The exhibits were for the most part such as were shown in other West India Courts.

Grenada.—Cocoa is the most important article grown here, and some very fine fruits of good colour were shown, as well as nutmegs (*Myristica fragrans*) custard apple or bullock's heart (*Anona reticulata*), papaws (*Carica Papaya*), Kola nuts (*Cola acuminata*). These latter were remarkably fine specimens. A good deal of attention was given to the tree which has recently been paid to its cultivation. The tree exists in all parts of the island, and was introduced in years past by the African slaves, who used it as a specific against intoxication.

Tobago.—The productive resources of this small island are varied, and were well exemplified in the collection of fruits, seeds, fibres, &c. The collection of preserved native fruits in syrup, and jellies prepared from them was a special feature in this Court, a sample of preserved or candied papaw (*Carica Papaya*) being especially good.

St. Lucia.—Sugar, rum, and molasses are the chief products; cocoa and logwood are also produced in quantities, though the latter is stated to be at the present time a drug in the market. Tobacco, it is stated, has been tried in one district with most satisfactory result so that it is purposed to extend its cultivation. Neither the individual exhibits in this Court, nor in the remainder of St. Vincent, call for any special remark. We cannot conclude our notice of the West Indian exhibits without a reference to the series of over 100 water-colour drawings, by Mrs. Blake, illustrative of the flora of the West Indian Islands.

JOHN R. JACKSON
Museum, Royal Gardens, Kew

NOTES

THE President and Council of the Royal Society have this year awarded the Copley Medal to Franz Ernst Neumann, of Königsberg (For. Mem. R.S.), for his researches in theoretical optics and electro-dynamics, and the Davy Medal to Jean Charles Galissard de Marignac, of Geneva (For. Mem. R.S.), for his researches on atomic weights. Prof. S. P. Langley was awarded the Rumford Medal for his researches on the spectrum by means of the bolometer. The Royal Medals have, with the approval of Her Majesty, been awarded to Mr. F. Galton and Prof. Guthrie Tait, the former eminent for his statistical inquiries into biological phenomena, and the latter for his various mathematical and physical researches. The medals will be presented at the anniversary meeting on November 30.

MR. CHARLES WILLIAM PEACH, the eminent scientific observer, died in February last, and, not long afterwards, a memorial was addressed to the First Lord of the Treasury, praying that his daughter, Jemima Mary, might, on account of her very slender provision, be placed on the Civil List. The memorial, subscribed by about 140 eminent persons, resulted in a Treasury grant of 200*l.* being sent to Miss Peach, after the expiry of five months. The grant so made being totally inadequate by way of provision, while it fails to denote the high sense entertained of Mr. Peach's scientific services, it has been determined to secure, by private subscription, the means of providing Miss Peach with a permanent annuity. Of the sum necessary to effect this, the Treasury grant of 200*l.* will of course form the nucleus. The Committee believe it is unnecessary to do more than allude to Mr. Peach's more conspicuous services. For half a century he gratuitously supplied to contemporary inquirers the fruits of his research. When Mr. Hugh Miller was engaged in preparing his work on the "Old Red Sandstone," Mr. Peach conveyed to him those specimens from Caithness which materially availed him in illustrating his subject. By his discovery of Silurian fossils in the rocks of Cornwall, he enabled Sir Henry de la Beche, then at the head of the Geological Survey, to obtain a scientific basis for mapping the rocks of Devon and Cornwall. In connection with this important work, also, by his discovery of Lower Silurian fossils in the north-west of Scotland—thereby affording the key by means of which the structure and age of the rocks of the Scottish Highlands must be determined—it was the opinion of Sir Roderick Murchison that Mr. Peach had rendered service such as merited a special recompense from his country. From the Devonian rocks of Cornwall and the Old Red Sandstone of the north of Scotland he procured the fish fauna which supplied a share of the material used by Sir Philip Egerton, Prof. Huxley, and Prof. E. Ray Lankester in preparing their several descriptions. In their monographs, Mr. Darwin and Dr. Carpenter have acknowledged his valuable contributions to a knowledge of the Balanidæ and the Polyzoa, while many other naturalists were also indebted to him for most important zoological observations made along our coasts. Mr. Peach made a valuable collection of the fossils of Brora, Sutherlandshire (Jurassic), now in the British Museum. His discoveries have largely availed in elucidating the fossil flora of the Old Red Sandstone and the Carboniferous rocks of Scotland. In the department of recent marine animals and plants, he has added hundreds of new species to the British lists. In acknowledgment of his scientific acquirements, he received honours from the leading scientific Societies; and in 1875 he was awarded by the Royal Society of Edinburgh one of their gold medals. After twenty-one years of arduous labour in connection with the Coastguard, Mr. Peach was in 1845 transferred by Sir Robert Peel to the Department of Customs, as suggested by the Council of the British Association; but this change, while adding to his leisure, did not materially enhance

his emoluments. In the public service his highest income was 150*l.*, his retiring allowance being 130*l.* Such remuneration as he received for his scientific services he applied exclusively to the cause of research. He attained his eighty-fifth year, and in his old age it was a source of deep anxiety to him as to how he should be able to provide for the devoted daughter to whose help and affectionate care he was so much indebted. Five hundred pounds are wanted, and this amount there ought not to be much difficulty in procuring. An account is opened in the Bank of Scotland, for the receipt of contributions, under the care of Mr. Robert Gray, Bank of Scotland, Edinburgh, as Treasurer of the fund. Among the members of the Committee are Sir William Turner, F.R.S.; Sir Joseph D. Hooker; Archibald Geikie, F.R.S., Director-General of the Geological Survey of Great Britain and Ireland; Prof. E. Ray Lankester, F.R.S.; Prof. Tait; John Murray, V.P.R.S.E., Director of the *Challenger* Expedition Commission, Edinburgh; William Pengelly, Torquay; and others.

OUR readers must have noticed the recent telegrams concerning the beleaguered position of Dr. Emin Bey at Wadelai, on the Upper Nile, some 50 miles north of Lake Albert Nyanza. Emin Bey was Governor of the old Equatorial Province of Egypt, and his administration of the province was of a model character. Moreover, he did much before the Mahdi insurrection broke out for the promotion of a knowledge of the natural history and geography of the Upper Nile region, as will be seen from his many communications to *Petermann's Mitteilungen*. His last communication is in the current number of the *Mitteilungen*, and is dated January last. In it, notwithstanding his critical position, he speaks of his collections. When the news of Emin Bey's position first reached this country, the Government regarded it as their duty to do what they could to rescue or succour him, and the Intelligence Branch of the War Office made all inquiries as to routes, among other things taking counsel with Mr. Joseph Thomson. There are many difficulties in the way, especially since the death of Mtesa, King of Uganda; but the Government, we believe, have by no means given up the idea of communicating with Emin Bey. Mr. Stanley has expressed his willingness to lead an expedition, and Mr. Thomson shows, in yesterday's *Times*, how the thing can be done. He believes rightly that the route across Masai Land followed by himself is the directest and shortest, and it is really not necessary to pass through Uganda at all; a sweep could be made round by Lake Baringo and the Suk country, and so westwards 300 miles to Wadelai. Moreover, it seems to us that the route by the west side of the Victoria Nyanza on to the Albert Nyanza is worthy of consideration. Certainly, if Mr. Thomson undertakes to lead a relief expedition, he could accomplish it speedily and peacefully. The English Government is bound to do everything in its power to prevent any disaster falling upon so valuable a life; and if they mean to do anything it ought to be quickly, or else it may be too late.

M. PASTEUR, according to the *Times* Paris Correspondent, exhausted by the incessant labours of the last few years, was to leave on Tuesday, by the advice of his family and friends, for Bordighera, where M. Bischoffsheim has placed his villa at his disposal. The *Times* Correspondent, before his departure, ascertained from M. Pasteur the precise state of the Pasteur Institute subscription and of his experiments. The subscription has now nearly reached 1,800,000*fr.*, but contributions still flow in, though rather more slowly, and M. Pasteur has reason to hope that we shall eventually reach the sum required. The Paris Municipality has given a gratuitous lease for 99 years of 2500 metres of ground, the site of the old Collège Rollin. This area being insufficient for the laboratories, not merely for rabies, but for other contagious maladies, he has asked for a lease for 99 years of 2500 metres adjoining, and he expected that this proposal

would be acceded to at Monday's sitting. A subscription is being raised among the brewers in England. M. Pasteur then goes on in his communication to describe the results of his operations much in the same terms as in his paper to the Paris Academy epitomised in a recent number of NATURE.

THE following are among the lectures to be given at the London Institution, during 1886-87:—Sir R. S. Ball, F.R.S., Astronomer Royal of Ireland, two lectures on "The Astronomical Theory of the Great Ice Age," one given last Monday, the other for November 29; Prof. E. Ray Lankester, F.R.S., six lectures on "The Elements of Biology," Thursdays, November 25, December 2, 9, 16, 23, 30; Prof. T. W. Rhys Davids, Ph.D., "Buddhism," Monday, December 13; Henry Seebohm, "Birds' Nests and Eggs," Monday, December 20; Eric S. Bruce, "War and Ballooning," Monday, December 27; Dr. C. Meymott Tidy, F.C.S., three lectures (juvenile) on "Chemical Action," Thursdays, January 6, 13, 20; Prof. W. H. Flower, F.R.S., Director of the Natural History Department, British Museum, "Fins, Wings, and Hands," Monday, January 17; Prof. Silvanus Thompson, Ph.D., two lectures on "Electric Bells," Thursdays, February 10, 17; Harold B. Dixon, F.R.S., "The Lighthouse Experiments at the South Foreland," Thursday, February 24. The Thursday lectures will be given at 6 o'clock, excepting on January 27, February 3, March 3, and March 10, when they will be given at 7 o'clock. The Monday lectures are at 5 p.m.

GENERAL J. F. TENNANT sends us the following additional information on the late Major-General John Theophilus Boileau, whose death we announced last week:—"General Boileau was selected to superintend one of the magnetic observatories established by the Honourable East India Company in 1843 in connection with the general scheme of magnetic observatories, and had charge of the Simla Observatory. Long after it was closed for observing purposes he was employed in reducing and publishing the results. He also published a collection of astronomical, magnetical, and meteorological tables, and a set of traverse tables; and possibly some special tables, which, being published in India, have never come into much use, and have practically been superseded by others more recent. General Boileau has long been annually appointed one of the Scrutators at the anniversary meeting of the Royal Society on St. Andrew's Day, and we shall miss there on Tuesday a familiar face and name. His energies and time have long been absorbed in institutions for helping those in want, especially the daughters of officers of the army and soldiers. And now his, in turn, want aid, which an influential Committee is endeavouring to raise for them. Will you lend the aid of your circulation to make known the want among those who can spare?"

WITH reference to the above note we heartily commend to our readers the proposal to raise by public subscription a testimonial in recognition of the devotion displayed by General Boileau over a long period of years in philanthropic works, especially those so ably and successfully carried out by him on behalf of the Royal School for Daughters of Officers of the Army at Bath, and the Soldiers' Daughters' Home at Hampstead. An influential Committee has been formed for giving effect to the proposal, with Field-Marshal the Lord Napier of Magdala, G.C.B., G.C.S.I., R.E., as Chairman, and Major-General Philip Ravenhill, C.B., as Honorary Secretary. It is contemplated that the amount collected will best be expended in purchasing annuities for certain members of General Boileau's family, who are at his death left in very straitened circumstances. The Committee appeal not only to those who are, or have been, connected with either of the two institutions above named, but also to General Boileau's numerous friends and acquaintances, to aid them in attaining the

object they have in view. Subscriptions will be received by Messrs. Cox and Co., Craig's Court, London, S.W., by the Honorary Secretary, 50, Holland Road, Kensington, W., or they may be paid to any member of the Committee.

THE *Methodist Times* announces the formation of a "Wesley Scientific Society" for the purpose of promoting intercourse among Wesleyan students of science. It will aim at the encouragement of practical scientific work among amateurs, the guidance of beginners in the study of natural history, the interchange of opinions upon scientific questions, and the collection and circulation of useful facts and observations bearing upon the sciences in general. If sufficient support is promised, the first number of a monthly journal will be issued by next March. The President is the Rev. W. H. Dallinger, F.R.S., and the Secretary is the Rev. W. Spiers, M.A., F.G.S. The Vice-President are Rev. G. Bowden, Rev. N. Curnock, A. C. Graham, M.A. C. W. Kimmins, D.Sc., J. Potts, F.G.S., and Rev. G. S. Row. The Rev. Dr. Dallinger, Rev. W. Spiers, and Rev. Hilderi Friend, F.L.S., will edit the Society's journal.

THE great refracting telescope of the Bischoffsheim Observatory is in full operation at Nice. It is second only to the Pulkowa instrument. Observations with it have been conducted most successfully.

ADMIRAL MOUCHEZ, Director of the Paris Observatory, has issued circulars in the name of the Committee for erecting to François Arago a statue on the southern part of the meridian line which passes through that establishment. Subscriptions are received at the Observatory by M. Mouchez. A sum of about 400*l.*, which had been collected for a similar purpose when Arago died thirty-two years ago, is in the hands of the Paris Academy of Sciences, and will be placed at the disposal of the Committee.

It is stated that a subscription will be started at Auxerre, the native place of M. Paul Bert, for erecting a memorial on his behalf.

LAST week a boat containing fourteen persons was successfully worked on the Seine with artificial wings acting on the air, and propelled by a rotating wheel.

DR. FOREL informs us that earthquakes occurred in Switzerland on the following dates:—At Cernetz, Grisons, November 17h. 44m., and at 19h. 59m.; November 7, at 1h. 28m.; over Switzerland, with centre in the Lake of Lucerne, on November 16, 2h. 15m. (all Greenwich times).

WE have received from Mr. J. White, photographer, Littlehampton, a copy of the last portrait (cabinet) taken of the late Prof. Guthrie. It is a very good one.

DR. R. MULLINEUX WALMSLEY, D.Sc., Senior Demonstrator at the Finsbury Technical College, in the department of Applied Physics and Electrical Engineering, has been appointed Principal of the Technical College about to be established at Kurrachee.

THE decline of the Indian silk industry is a subject which has lately attracted some attention. Various causes have been assigned, such as rack-renting by the Zemindars, while the existence of any specific disease among the silkworms has been strenuously denied. The question seems at last to have been settled by the investigations of a skilled entomologist, Mr. Wood Mason, Curator of the Indian Museum, who, on examining a large number of living cocoons, received from various parts of the country, found over 60 per cent. so diseased that no moth emerged, while such moths as emerged were nearly all sick and crippled, and only 6 per cent. lived to couple and lay eggs. A further examination showed that the cells of the silk gland and all other tissues, including even the blood, were in the last stage of disease, and literally crammed with minute corpuscles.

identical with those which have been demonstrated to be the cause of the fibrine disease which, in an epidemic form, from 1849 to 1865 ravaged the silkworm nurseries of France, and reduced them to a state of ruin, but which, thanks to M. Pasteur, is now practically eradicated from Europe.

PROF. GIOVANNI LUVINI has just issued, in pamphlet form, a summary of the results of his important experiments on the electric conductivity of vapours and gases. As the readers of NATURE are already aware, these experiments have finally exploded the old theory that the moist atmosphere and other vapours are good conductors. The pamphlet, which is published in Florence, includes an historical survey of the subject, and a full account of the processes adopted by the author. Electricians are reminded that this essay, together with his previous treatise on atmospheric electricity, are merely preparatory to a comprehensive work on the phenomena connected with the aurora borealis, which is now nearly completed.

LIGHTNING-FLASHES have sometimes been observed which, starting from one point, have ended in several. Some remarkable forms of flash have been lately described by Herr Leyst, of Pawlowsk Observatory. In one case a flash went a certain distance in a north-easterly direction, then divided, the two branches forming an angle of about 75°. When these had reached about 35° from each other, they turned and united again to one line. The path of the lightning thus formed a quadrilateral figure. It was further observed that the lightning flashed back in the same path, as if there were an oscillating discharge. In another interesting flash, the path was not a crooked line but a wavy band, which was lit up four times in succession with equal brilliancy. The time between the second and third and the third and fourth flashes seemed longer than that between the first and second. The thunder which followed lasted about 80 seconds.

THE additions to the Zoological Society's Gardens during the past week include a Patas Monkey (*Cercopithecus patas* ♀) from West Africa, presented by Capt. T. W. Robinson; a Puma (*Felis concolor* ♂) from El Gran Chaco, presented by Mr. Alfred Grenfell, F.Z.S.; a Malayan Bear (*Ursus malayanus*) from Malacca, presented by Miss A. Stewart Saville; a Souslik (*Spermophilus* —) from California, presented by Mr. B. F. Russell; a Gazelle (*Gazella dorcas* ♂) from Barbary, presented by Edward J. Hough; four Chukar Partridges (*Caccabus chukar*) from Persia, presented by Dr. J. Huntley; a Toad (*Bufo* —) from Africa, presented by Mr. E. N. Wroughton; six Roseate Cockatoos (*Cacatua roseicapilla*), seventeen Cockateels (*Calopsitta nove-hollandiæ*), six Swainson's Lorikeets (*Trichoglossus nove-hollandiæ*), two Red-winged Parrakeets (*Aprosmictus erythropterus*), eight Chestnut-eared Finches (*Amadina castanotis*), two Peaceful Doves (*Geopelia tranquilla*) from Australia, a Nutmeg Bird (*Munia punctularia*), two Eastern Turtle Doves (*Turtur meera*) from India, three Magpie Tanagers (*Cissopis leveriana*), two Red-crested Cardinals (*Paroaria cucullata*), a Red Ground-Dove (*Geotrygon montana*), a Yarell's Curassow (*Crax carunculata*), a Crested Curassow (*Crax alector*) from South-East Brazil, two Hawfinches (*Coccothraustes vulgaris*), British, deposited.

OUR ASTRONOMICAL COLUMN

THE MASS OF MERCURY.—In the *Bulletin Astronomique* for October Herr Backlund has published a new determination of the mass of Mercury deduced from the perturbations produced in the motion of Encke's comet arising from its close proximity to the planet in 1878. From the apparitions of the comet in 1871, 1875, 1878, 1881, and 1885, Herr Backlund finds the reciprocal

of the mass of Mercury to be 2,668,700,—thus making the mass of the planet considerably larger than has been found by recent investigators. And Herr Backlund states that, even supposing the acceleration of the comet's mean motion to have been constant during the entire period 1871-85, it is not possible to represent satisfactorily the five apparitions of the comet during that period on the assumption that the reciprocal of the mass of Mercury is greater than 5,000,000.

THE NATAL OBSERVATORY.—Mr. Neison has issued his Report, as Superintendent of the Natal Observatory, for the year 1885. The staff of the Observatory consists of the Government Astronomer, an Astronomical Assistant, and a Meteorological Assistant. Four ladies have also been employed during the year as astronomical computers. The equatorial appears to have been but little used in 1885, all the astronomical observations recorded having been made with the 3-inch transit. The total number of observations made with this instrument was 706, including transits of stars, of the sun, of the moon's limb, of the lunar crater Murchison A, and observations of zenith stars for latitude. With regard to the latter class of observations, it is proposed to determine the latitude of the Observatory with the greatest care, as one of the primary points of the geodetic triangulation of South Africa. Forty pairs of stars have been selected for this purpose, mostly differing in zenith distance by not more than 3' or 4'. Also, with the view of better connecting the fundamental declinations of the star catalogues of northern and southern observatories, arrangements have been made for comparing, by Talcott's method, the zenith distances of a number of southern circumpolar stars with suitably placed northern stars of corresponding zenith distance. A list of thirty-two stars has been prepared for this purpose. Mr. Neison also reports on the state of his own work on the lunar theory, which he appears to consider of an official character.

COMET FINLAY (1886 e).—The following ephemeris of this object is by Dr. A. Krueger (*Astr. Nachr.*, No. 2755):—

For Berlin Midnight							
1886	R.A.		Decl.	log r	log Δ	Brightness	
	h.	m.	s.				
Nov. 28	21	0	50	19 10'7 S.	9'9941	9'9142	3'0
	30	21	10 58	18 20'4			
Dec. 2	21	21	12	17 27'2	9'9971	9'9060	3'1
	4	21	31 30	16 31'0			
	6	21	41 53	15 31'9	0'0016	9'8992	3'1
	8	21	52 20	14 30'0			
	10	22	2 49	13 25'6 S.	0'0074	9'8941	3'1

The brightness at date of discovery is taken as unity.

COMET BARNARD (1886 f).—The following ephemeris of this object for Berlin midnight is by Dr. Oppenheim (*Dun Echt Circular*, No. 130):—

1886	R.A.		Decl.	log r	log Δ	Brightness	
	h.	m.	s.				
Nov. 27	14	34	10	16 50'4 N.	0'0029	9'8864	17'8
	29	14	54 42	17 23'5			
Dec. 1	15	16	12	17 46'0	9'9879	9'8640	21'2
	3	15	38 23	17 56'0			
	5	16	0 54	17 51'8	9'9839	9'8448	23'6
	7	16	23 24	17 33'0			
	9	16	45 27	17 0'1 N.	9'9920	9'8303	24'3

The brightness at date of discovery is taken as unity.

GORE'S NOVA ORIONIS.—It seems to be clearly established that this interesting star is indeed—as was from the first suspected from the character of its spectrum—a simple variable, and not one of the class to which the title "temporary" can be fitly applied. M. Dunér, who had observed the star at intervals from last December to the end of April, found (*Astr. Nachr.*, No. 2755), on renewing his observations at the end of October and the beginning of the present month, that it had unmistakably increased in brightness in the interval, and was continuing to do so. Herr Fr. Schwab and Mr. Espin confirm this conclusion, the former having observed this star early in last July, and found it then fainter than the 12th magnitude. Its period would appear to be not far from one year; Herr Schwab gives it as one or two weeks longer than a year, and as ranging in brightness from 6m. to 12m., whilst M. Dunér assigns a period of 359'5d. to it. It is clearly of importance that it should be carefully watched during the coming winter.

ASTRONOMICAL PHENOMENA FOR THE WEEK 1886 NOVEMBER 28—DECEMBER 4

(FOR the reckoning of time the civil day, commencing at Greenwich mean midnight, counting the hours on to 24, is here employed.)

At Greenwich on November 28

Sun rises, 7h. 42m.; souths, 11h. 48m. 10'4s.; sets, 15h. 55m.; decl. on meridian, 21° 21' S.: Sidereal Time at Sunset, 20h. 25m.

Moon (three days after New) rises, 9h. 52m.; souths, 14h. 15m.; sets, 18h. 39m.; decl. on meridian, 19° 7' S.

Planet	Rises		Souths		Sets		Decl. on meridian
	h.	m.	h.	m.	h.	m.	
Mercury	8	40	12	35	16	30	23 11 S.
Venus ...	7	33	11	43	15	53	20 51 S.
Mars ...	10	27	14	14	18	1	24 15 S.
Jupiter...	3	55	9	12	14	29	9 14 S.
Saturn..	19	5*	3	7	11	9	21 25 N.

Indicates that the rising is that of the preceding evening

Occultation of Star by the Moon (visible at Greenwich)

Dec.	Star	Mag.	Disap.		Reap.	Corresponding angles from vertex to right for inverted image
			h.	m.		
3 ...	♂ Aquarii	5½	17	8	18 30	116 26
3 ...	5		Venus in superior conjunction with the Sun.			
3 ...	12		Mercury in inferior conjunction with the Sun.			
4 ...	4		Mercury at least distance from the Sun.			

Variable Stars

Star	R.A.		Decl.		Date	h.	m.
	h.	m.					
U Cephei ...	0	52.2	81° 16' N.		Nov. 28,	2	27 m
Algol ...	3	0.8	40 31 N.		Dec. 3,	2	6 m
ζ Geminorum ...	6	57.4	20 44 N.		Nov. 29,	0	0 m
U Monocerotis ...	7	25.4	9 32 S.		Nov. 28,		m
S Cancri ...	8	37.4	19 27 N.		" 28,	3	9 m
T Ursæ Majoris ...	12	31.2	60 7 N.		" 29,		M
S Virginis ...	13	27.1	6 37 S.		" 30,		M
β Lyræ... ..	18	45.9	33 14 N.		" 28,	21	30 m
R Lyræ ...	18	51.9	43 48 N.		Dec. 2,	5	0 m
η Aquilæ ...	19	46.7	0 43 N.		Nov. 28,		M
δ Cephei ...	22	24.9	57 50 N.		Dec. 1,	2	30 M
					Nov. 30,	2	0 m

M signifies maximum; m minimum.

Meteor Showers

The chief shower of the week is that of the *Taurids*; R.A. 60°, Decl. 49° N. Other radiants active at this time are as follows:—Near η Persei, R.A. 44°, Decl. 56° N., slow, faint meteors; near α Canum Venaticorum, R.A. 194°, Decl. 43° N., very swift, streak-leaving meteors; from Leo Minor, R.A. 155°, Decl. 36° N.; from near η Ursæ Majoris, R.A. 208°, Decl. 43° N. Fireball dates, November 29 and December 2.

TEN YEARS' PROGRESS IN ASTRONOMY¹

II.

THE Solar Spectrum.—In 1877 Dr. Henry Draper, of New York, by a series of most laborious, time-consuming, and expensive researches, discovered the presence of oxygen in the sun, evidenced in his photographs, not by fine dark lines, as in the case of elements previously recognised, but by bright, hazy bands. It is difficult to assign any reason why this gas should behave so peculiarly and so differently from others, and for this reason many high authorities are indisposed to accept the discovery. But the evidence of the photographs seems fairly to outweigh any such purely negative theoretical objections.

Other advances have been made in the study of the spectrum, due mainly to the great improvements in spectroscopic apparatus. Until recently it has not been easy to decide with certainty as to some lines in the spectrum whether they were of

¹ "Ten Years' Progress in Astronomy, 1876-86," by Prof. C. A. Young. Read May 17, 1886, before the New York Academy of Sciences. Continued from p. 67.

solar or telluric origin; the great bands known as A and B, for instance. It was only in 1883 that the Russian, Egoroff, succeeded in proving that these are produced by the oxygen in the earth's atmosphere. In his experiments, on a scale previously unknown, the light was transmitted through tubes more than 60 feet in length, closed at the end with transparent plates, and filled with condensed gas.

It was quite early pointed out that the sun's rotation ought to produce a shift in the position of lines in the spectrum according as the light is derived from the advancing or receding edge of the solar disk, and Zollner thought he could perceive it. The earliest *measures*, however, were, I believe, those obtained independently by Vogel and the writer in 1876. In the great bisulphide of carbon spectroscope of Thollon the displacement becomes easy of observation; and very recently Cornu, by taking advantage of it, and by an extremely ingenious arrangement for making a small image of the sun to oscillate across the spectroscope slit two or three times a second, has been able to discriminate at a glance between the telluric and solar lines; the former stand firm and fast, while the latter seem to wave back and forth.

In this connection also should be mentioned the great map of the solar spectrum, for which Thollon received the Lalande Prize of the French Academy of Sciences last January, and the still more accurate and important map photographed by Prof. Rowland, by means of his wonderful diffraction-gratings, and now in course of publication. Nor would it be just either to omit the earlier and less accurate maps of Fizeau and Vogel, which, when published, were as far in advance of anything before them as they are behind the new ones; nor the maps just made by Prof. Smyth, of Edinburgh.

It was in connection with the construction of such a map by Mr. Lockyer, that he was led to his theory of the compound nature of the so-called chemical elements, partly as a result of his comparisons of the spectra of different substances with the solar spectrum, and partly in consequence of considerations drawn from certain phenomena observed in the solar and stellar spectra themselves. His first paper on the subject was read late in 1878. This "working hypothesis," as its author calls it, has met with much discussion, favourable and unfavourable. It unquestionably removes many difficulties and explains many puzzling phenomena; at the same time there are very serious objections to it, and some of the arguments upon which Mr. Lockyer originally laid much stress have turned out unsound. For instance, he made a great point of the fact that, after all precautions are taken to remove impurities, several elementary substances show in their spectra common lines—"basic lines," he called them—indicating, as he thought, a common component. He found in the solar spectrum about seventy of these "basic lines." Now, under the high dispersion of our newer spectroscopes, these lines, which were single to his instruments, almost without exception dissolve into pairs and triplets, and withdraw their support from his theory.

I suppose that at present the weight of scientific opinion is against him; but, for one, I do not believe his battle is lost. In view of the law of Dulong and Petit, which establishes a relation between the atomic weight and specific heat of bodies, it seems to be pretty certain that *hydrogen* cannot be the elementary "urstuff" out of which all other elements are made by building up, as he at first seemed disposed to maintain; this element stands apparently on no different footing from the rest. But I see no reason why the elements, as we know them, may not constitute one *class* of bodies by themselves, all built up out of some as yet more elemental substance: or substances. The "periodic law" of Mendelejeff suggests such a relation. And our received theories so stumble, hesitate, and falter in their account of many of the simplest phenomena of the solar and stellar atmospheres, that a strong presumption still remains in favour of the new hypothesis. I am not prepared to accept it yet; but certainly not to reject it.

The Chromosphere.—The study of the chromosphere and prominences has been kept up, very systematically and statistically, by Tacchini in Italy, and with less continuity, but still assiduously, by several other observers. I do not know, however, that any new results of much importance have been arrived at. The list of bright lines visible in their spectra has been a good deal enlarged; and Trouvelot thinks he has observed *dark* prominences—objective forms that show, black but active, upon the background of bright scarlet hydrogen in the surrounding chromospheric clouds. It may be that he is right; but, so far

I can learn, no other observer of the solar atmosphere has seen anything similar. I certainly have not myself. And I think some of his published observations of velocities of two or three thousand miles a second in the motions of the prominences, as evidenced by the displacement of lines in the spectrum, are still more questionable.

In two or three cases, prominences have been observed since 1876 considerably higher than any known previously. In October 1878 I myself observed one which attained an elevation of nearly 400,000 miles (13 $\frac{1}{2}$).

Eclipses and the Corona.—The sun's corona has been, perhaps, more earnestly studied than anything else about the central luminary, especially during the four eclipses which have occurred since 1876. At the eclipse of 1878, in the midst of an epoch of sunspot quiescence, the corona was found less brilliant than ordinary, and especially deficient in the unknown gas that produces the so-called 1474 line—the line which characterises the spectrum of the corona, and first demonstrated conclusively its solar origin in 1869. But while the corona at this time was less brilliant than it had been formerly, it was far more extensive. At least it seemed so; for, at Pike's Peak and Creston, Langley and Newcomb were able to follow its streamers to a distance of 6° from the sun. It is possible, however, that this extension was only due to the superior transparency of the mountain air.

The Egyptian eclipse of 1882 gave us some interesting results respecting the spectrum of the prominences and the corona. It appears that the light of the corona is especially rich in the ultra-violet, and in the photographs of the spectrum a number of bands are found which have been interpreted, with questionable correctness I think, as indicating the presence of carbon. The eclipse of 1883 was observed in the Pacific Ocean by French and American parties, but, I think, added very little real information. Prof. Hastings made an observation which he believed to establish a peculiar theory proposed by himself, viz. that the corona is merely a diffraction effect produced by the moon's limb, and depending on the non-continuity of phase in long stretches of light-vibrations. With a peculiar apparatus prepared expressly for the purpose, he found that at any moment the 1474 line was visible to a much greater distance from the sun on the side least deeply covered by the moon than on the other: as unquestionably would happen if his theory were correct. But the same thing would result from the mere diffusion of light by the air; and, notwithstanding his protests, the French observers who were at the same place, and nearly all others who have discussed the observations, think that this was the true explanation of what he saw. So far as I know, the discussion of the subject which has resulted from his publication has only strengthened the older view—that the corona is a true solar appendage; an intensely luminous but excessively attenuated cloud of mingled gas and fog and dust surrounding the sun, formed and shaped by solar forces.

The diffraction theory has one advantage—that it relieves us from stretching our conceptions as to the possible attenuation of matter to the extent necessary in order to account for the fact that a comet, itself mostly a mere airy nothing, experiences no perceptible retardation in passing through the coronal regions. There can be no question that this has happened several times: the last instance having been the great comet of 1882. But on careful consideration it will be found, I think, that our conceptions will bear the stretching without involving the least absurdity; a single molecule to the cubic foot would answer every necessary condition of the luminous phenomenon observed. And all the rifts and streamers, and all the radiating structure and curved details of form, cry out against the diffraction hypothesis.

The observations of the eclipse of 1885 (observed only by a few amateurs in New Zealand) have not proved important.

At present the most interesting debate upon the subject centres around the attempt of Mr. Huggins (first in 1883) to obtain photographs of the corona in full sunlight. He succeeded in getting a number of plates showing around the sun certain faint and elusive halo forms which certainly look very coronal. Plans were made and have been carried out, for using a similar apparatus on the Riffelberg, in Switzerland, and at the Cape of Good Hope. But so far nothing has been obtained much in advance of Mr. Huggins's own first results. Since September 1883, until very recently, the air has been full, as every one knows, of a fine haze, probably dust and vapour from Krakatōa,

which has greatly interfered with all such operations. It is now fast clearing away, and I for one am somewhat sanguine that a much greater success will be reached next winter at the Cape, and perhaps even in England during the coming summer.

Just about the same time that Huggins was photographing in England, Prof. Wright was experimenting in New Haven in a different way: isolating the blue and ultra-violet rays by the use of coloured media, stopping out the sun's disk, and receiving the image of the coronal regions on a fluorescent screen. He also had obtained what he believed, and still believes, to be a real image of the corona, when the aerial haze intervened to put an end to all such operations; for of course it is evident that whether one operates by this method or by photography, success is possible only under conditions of unusual atmospheric transparency and purity.

I suppose at present the predominant feeling among astronomers is that the case is hopeless, and that Huggins and Wright are mistaken. It may be so. But my own impression is that they are probably correct; although, of course, the matter is still in doubt.

Inferior Planets.—Leaving now the sun, and passing to the planetary system, we come first to the subject of intra-Mercurial planets.

The general opinion among astronomers (in which I fully concur) is that the question has been now fairly decided in the negative, i.e. it is practically certain that within the orbit of Mercury there is no planet of a diameter as large as five hundred miles, probably not one hundred. If such a one existed, it could not have failed to be discovered by the wide-angled photographs taken at the eclipses of 1882 and 1883, to say nothing of the visual observations. Of course, it is well known that at the eclipse of 1878 Prof. Watson supposed he had discovered two such bodies, and his extensive experience and his high authority led, for a time, to a pretty general acceptance of his conclusion. I notice that Dr. Ball, even very lately, in his "Story of the Heavens," is still disposed to credit the discovery. But Dr. Peters, by a masterly discussion of the circumstances of the observations themselves, and a comparison with the star maps, has shown that it is almost certain that Watson really saw only the two stars θ and ζ Cancri. In the same paper also, Peters examined all the observations of small, dark spots crossing the sun's disk which, up to that date (1879), had been made by Leverrier and others; the ground for their belief in "Vulcan"; and he shows that they really afford no sufficient ground for the conclusion. As to Mr. Swift's supposed observation of two objects with large disks "both pointing to the sun," they certainly were not the two seen by Watson, while they were in the region covered by Watson and several other observers. What the precise nature of the mistake or illusion may have been it is perhaps not now possible to discover, but I think no one, unless perhaps Mr. Swift himself, now considers the observation important.

While, however, the question of a "Vulcan" is now pretty definitely settled, it is not at all impossible, or even improbable, that there may be intra-Mercurial asteroids, and that some of them may be picked up as little stars of the sixth magnitude or smaller, by the photographers at the eclipse of next August, or in 1887. The sensitiveness of our present photographic plate is now many times greater than it was even in 1882.

As to the planet Mercury, there is very little to report. It "transited" the sun in May 1878, and again in November 1881, and during the transits numerous measures were made of its diameter, giving results substantially in accord with the older values. I have already alluded, in connection with the earth's rotation, to Newcomb's investigation of former transits of this planet as establishing the sensible uniformity of the earth's rotation.

The planet Venus, by her transit in 1882, has attracted much attention, and much interest is felt as to the final outcome of the whole enormous mass of data, photographic and visual. Just how long we shall have to wait for the publication seems still uncertain. I have already said, however, that probably these transits will never again be considered as important as hitherto.

The most important physical observations upon the planet during the decade seem to be those of Langley, who, during the transit of 1882, observed a peculiar, and so far unexplained, illumination of one point on the edge of the planet's disk, and those of Trouvelot and Denning, who have observed and figured

certain surface-markings of the planet. I think I may fairly mention also our Princeton observation of the spectrum of the planet's atmosphere during the transit, and our confirmation of Gruithuisen's old observation of a white cap (likely enough an ice-cap), at the edge of the planet's disk—probably marking the planet's pole, and showing that the planet's equator has no such anomalous inclination of 50° or 60°, as stated in some of the current text-books. This cap has also been observed by Trouvelot and Denning. But this lovely planet is most refractory and unsatisfactory as a telescopic object, apparently enveloped in dense clouds which mostly hide the real surface of the globe, and mock us with a meaningless glare.

We mention in passing, but without indorsement, the speculations of Houzeau, who has attempted to account for some of the older observations of a satellite to Venus, by supposing another smaller sister planet, "Neith," circling around the sun in an orbit a little larger than that of Venus, and from time to time coming into conjunction with it. But the theory is certainly untenable; a planet large enough to show phases, as the hypothetical satellite is said to have done, in the feeble telescopes with which many of the observations were made 100 years ago or more, would be easily visible to the *naked eye even*. There can be little doubt that all the Venus satellites so far observed are simply *ghosts* due to reflections between the lenses of the telescope, or between the cornea of the eye and the eye lens.

Mars.—But while Venus has gained no moons during the past ten years, Mars has acquired two, and they are both native Americans. There is no need to recount the faithful work of Prof. Hall with the then new great telescope at Washington, and its brilliant result; brilliant in a scientific sense, that is, for, regarded as luminaries, it must be admitted that the Martial satellites, in spite of their formidable names of Phobos and Deimos, do not amount to much. Under the best of circumstances, they are too faint to be seen by any but keen eyes at the end of great telescopes. Small as they are, however, the little creatures punctually pursue the orbits which Hall has computed for them, and, when the planet came to its opposition a few weeks ago, they were found just in their predicted places. They are interesting, too, from the light they throw upon the genesis and evolution of the planetary system, almost compelling the belief that they have come *gradually* into their present relation to the planet. The inner one, Phobos, revolves around the primary in 7h. 39m., which is less than one-third of the planet's day. The theory of "tidal evolution," proposed by Prof. G. H. Darwin in 1878-80, as the result of his investigations upon the necessary mechanical consequence of the tidal reactions between the earth, sun, and moon, will account for Phobos, and I know nothing else that will; though, of course, it would be rash to assert that no other account can ever be given.

Much attention has also been paid to the study of the planet's surface. In 1876 we were already in possession of three elaborate maps, by Proctor, Kaiser, and Terby, agreeing in the main as to all the characteristic formations. In 1877, Schiaparelli, of Milan, detected, or thought he did, on the planet's surface, a numerous system of "canals"—long, straight channels, some of them more than 1000 miles in length, with a pretty uniform width of fifty or sixty miles; and from his observations he constructed a new map, differing from the older ones somewhat seriously, though still accordant in the most essential features. His nomenclature of the seas and continents, derived from ancient geography, is certainly a great improvement on that of his predecessors, who had affixed to them the names of their friends and acquaintances among living astronomers. There has been some scepticism as to the reality of these "canals"; but in 1879 and 1881 they were all recovered by Schiaparelli, and several other observers, notably Burton, also made them out. Moreover, Terby finds, from drawings in his possession, that they had before been seen, though not understood or clearly recognised, by Dawes, Secchi, and other observers. At present the balance of evidence is certainly in their favour, especially as the observers at Nice report seeing them last spring. I do not think the same can be said in respect to another observation of Schiaparelli's on the same object, made in 1881. He then found nearly all of these canals—more than twenty of them—to be *double*, *i.e.* in place of a single canal there were two—parallel, and 200 or 300 miles apart. No one else so far has confirmed this "gemination" of the canals; but the planet does not come to a really favourable opposition again

until 1890 and 1892, when probably the question can be settled.

The time of rotation has during the past year been determined with great accuracy by Bakhuysen, who has corrected some errors of Kaiser and Proctor, and finds it 24h. 37m. 22.66s. In 1876 there still remained some question as to the amount by which the planet is flattened at the poles. The majority of observers had found a difference between equatorial and polar diameters amounting to between 1/100 and 1/30, while, on the other hand, a few of the best observers had found it insensible. The writer, in 1879, made a very careful determination, and found it 1/219, a quantity closely agreeing with the theoretical value deduced by Adams as probable from the motion of the newly-discovered satellites.

The Asteroids.—On May 1, 1876, the number of known asteroids was 163. To-day it stands at 258, 95 of these little bodies having been discovered within the decade, 45 of them by one man, Palisa, of Vienna, while our own Peters is responsible for 20.

None of the new ones are especially remarkable, *i.e.* some of the older ones are always more so; the most inclined and most eccentric orbits, the longest and the shortest periods, none of them belong to any of the late discoveries. One point is noteworthy, that the more recently discovered bodies are much smaller than the earlier ones. The first 25, discovered between May 1876 and October 1878, have an average opposition magnitude of 11.2, while the last 25, discovered since April 1883, average only 12.2; *i.e.* the first 25 average about 2½ times as bright as the last. Out of the whole 95, two are of the 9th magnitude (one of them, No. 234, was discovered as recently as August 1883), 14 are of the 10th, 33 of the 11th, 33 of the 12th, and 13 of the 13th. Of these last 13, 10 have been found within the past two years; and of the 12 others found in the same time, 6 are of the 11th magnitude, and 6 of the 12th.

It is clear that there can remain very few to be discovered as large as the 10th magnitude, but there may be an indefinite number of the smaller sizes.

The Major Planets.—As regards the planet Jupiter, the one interesting feature for the past ten years has been "the great red spot." This is an oval spot, some 30,000 miles in length, by 6000 or 7000 in width, which first attracted attention in 1878. At first, and for three years, it was very conspicuous, but in 1882 it became rather faint, though still remaining otherwise pretty much unchanged. In 1885 it was partly covered with a central whitish cloud, which threatened to obscure it entirely; but this season the veiling cloud has diminished, and the marking is again as plain as it was in 1882 or 1883. How long it will continue, no one can say; nor is there any general and authoritative agreement among astronomers as to its nature and cause.

In connection with observations upon this object, several new determinations have been made of the planet's rotation-period, and they all show that, as in the case of the sun, the equatorial markings complete the circuit more rapidly than in higher latitudes; a white spot near the equator gives 9h. 50m. 6s., as against 9h. 55m. 36s. for the red spot, which is approximately in latitude 30°.

We must not omit to mention Prof. Pickering's new photometric method of observing the eclipses of this planet's satellites. Instead of contenting himself with observing merely the moments of their disappearance and reappearance—an observation not susceptible of much accuracy—he makes a series of rapid comparisons between the brightness of the waning or waxing point of light during the two or three minutes of its change, using, as the standard, one of the neighbouring un-eclipsed satellites. From these comparisons he determines the moment when the satellite under eclipse has just half its normal brightness, and this with a probable error hardly exceeding a single second, while the old-fashioned method gave results doubtful by not less than a quarter of a minute. Cornu and Obrecht have independently introduced the same method at Paris. When we have a complete twelve years' series of such observations, they will give an exceedingly precise determination of the time required by light to traverse the earth's orbit, and so, indirectly, of the solar parallax.

As regards Saturn, there is nothing to report so startling as Jupiter's red spot. A white spot, which appeared in 1877, enabled Hall to make a new determination of the rotation-period, which came out 10h. 14m. 14s. This is in substantial

coörd with an earlier determination of W. Herschel's (vol. 16m. 7s.), but involves a serious correction of the value of 17s. given in most of the text-books. The error probably came from a servile copying of a slip of the pen made by some book-copyist, fifty years ago or more, in accidentally writing Herschel's value of the rotation of the inner ring, instead of that of the planet.

Much time has been spent in observations of the rings, and Prouvelot has reported a number of remarkable phenomena, most of which, however, he alone has seen as yet. The most recent micrometric measures have failed to confirm Struve's suspicion that the rings are contracting on the planet. Extensive series of observations have been made upon the satellites by F. Struve, Meyer, and others in Europe, and by Hall in this country. Hall's observations are especially valuable, and the series is now so nearly completed that we may soon hope to have most accurate tables. In the case of Hyperion, there is found a singular instance of a retrograde motion of the line of apsides of the orbit, produced by the action of an outside body, the effect being due to the near commensurability of the periods of Hyperion and Titan. This most peculiar and paradoxical disturbance first showed itself as an observed fact in Hall's observations; and, soon after, Newcomb gave the mathematical explanation and development. He finds the mass of Titan to be about 1/12,500 that of Saturn. It may be noted, too, that Hall's observations of the motions of Mimas and Enceladus indicate for the rings a mass less than 1/10 that deduced by Cassini: instead of being 1/100 as large as the planet, they cannot be more than 1/1000, and are probably less than 1/10,000.

The satellites of Uranus have also been assiduously observed at Washington, so that at present the Uranian system is probably as accurately determined as the Jovian, perhaps more so. The form of the planet has been shown to be decidedly elliptical (about 1/14) by observations of Schiaparelli and at Princeton; and the same observers have detected faint belts upon the disk, which have also been seen at Nice, and by the Denrys in Paris. Many of the observations appear to indicate a very paradoxical fact—that the belts, and consequently the planet's equator, are inclined to the orbits of the satellites at a considerable angle. The mathematical investigations of Tisserand appear to demonstrate that, in the case of a planet perceptibly flattened at the poles, satellites near enough to be free from much solar disturbance must revolve nearly in the plane of the equator; while those more remote, and disturbed more by the sun than by the protuberant equator of the planet, must revolve nearly in the plane of the planet's orbit. Thus the two satellites of Mars, the four satellites of Jupiter, and the seven inner satellites of Saturn, all move nearly in the equatorial plane, while our moon and Japetus move in ecliptical orbits. It is very difficult to believe that the satellites of Uranus, which are certainly not ecliptical and are very near the planet, do not move equatorially. And yet it is unquestionable that most of the observations with sufficiently powerful telescopes (my own among them) do seem to indicate pretty decidedly that the planet's equator is inclined as much as 15° or 20° to the orbit plane of the satellites.

As to Neptune, there is nothing new. One or two old observations of the planet have turned up in the revision of old star catalogues, and Hall, of Washington, has made a careful and accurate determination of the orbit of its one satellite, and of the planet's mass; while Maxwell Hall, of Jamaica, has deduced a very doubtful value of the planet's rotation from certain photometric observations of its brightness.

There has been some hope that a planet beyond Neptune might be found. Guided by certain slight indications of systematic disturbances in the motion of Neptune, Todd made an extended search for it in 1877-78, using the Washington telescope, and hoping to detect it by its disk, but without results. If such a planet exists, it is likely to appear as a star between the 11th and 13th magnitude, and may be picked up any time by the asteroid-hunters. But its slow motion, and the fact that our present charts give but few stars below the 11½ magnitude, will render the recognition difficult.

The indications I have spoken of, and certain others first noted in 1880 by Prof. G. Forbes, and depending upon the behaviour of certain periodic comets, furnish pretty strong reasons for believing in its existence, though as yet they fall far short of making it certain.

(To be continued.)

A LECTURE EXPERIMENT ON THE EXPANSION OF SOLIDS BY HEAT

I VENTURE to call attention to a simple and effective way of demonstrating the linear expansion of solids when heated, first suggested, I believe, by M. Kapoustine (*Journal de Physique*, December 1883, p. 576). It answers at least as well as the system of levers known as "Ferguson's pyrometer," which is usually employed for the purpose, while the cost of the apparatus is almost nothing, and any one can make it in ten minutes.

The principle is, to magnify the slight extension of a bar by causing the end of it to roll upon a needle, and thus turn the latter round and move a pointer attached to it through a sensible arc.

The figure given below will show the nature of the apparatus.

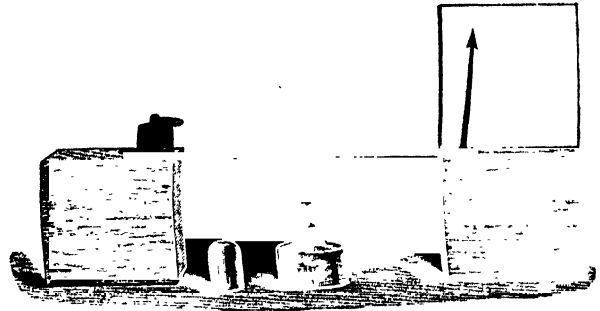

A small flat rod of the material to be examined, such as brass, iron, or glass, about 30 cm. long, 1 cm. broad, and 2 or 3 mm. thick, is laid upon two wooden blocks, placed about 25 cm. apart. A weight is put upon one end of the rod to keep it from moving; under the other end, at right angles to the length of the rod, is laid a fine sewing-needle, to the eye-end of which a light pointer of straw, about 16 or 20 cm. long, is attached by sealing-wax. Behind the pointer (which is painted black) a screen of white cardboard is fixed on the wooden block by drawing-pins.

When the rod is heated by a lamp-flame, the free end of it, as it expands, moves forward upon the needle and rolls it round, its movement being shown by the motion of the pointer. Even the slight expansion of a slip of glass is thus easily rendered evident to a class.

I have constructed for my own use a double apparatus on the same principle, in which the surfaces between which the needle rolls are of brass, ground true and flat. Two bars of different materials lie side by side, each having its own bit of needle and aluminium pointer, ranging over the same scale. They are heated equally by a broad flame (spirits of wine in a wide trough) and the difference of expansibility as well as the fact of expansion by heat is thus shown.

It is advisable to counterpoise the pointer by putting a shot or two into the lower end of the straw which projects below the needle, and cementing them in by sealing-wax. Also, before the experiment is shown to an audience, it is well to make sure that the needle rolls fairly and freely between the bar and the block. Such precautions, however, are not in the slightest degree necessary for school-work; for there is always one thing which gives the typical boy greater pleasure than to see an experiment succeed, and that is—to see it fail.

Eton College

H. G. MADAN

COMPARATIVE STUDIES UPON THE GLACIATION OF NORTH AMERICA, GREAT BRITAIN, AND IRELAND¹

OBSERVATIONS extending over several years upon glacial phenomena on both sides of the Atlantic had convinced the author of the essential identity of these phenomena; and the object of this paper was to show that the glacial deposits of Great Britain and Ireland, like those of America, may be interpreted most satisfactorily by considering them with reference to a series of great terminal moraines, which both define and

¹ Abstract of a Paper read at the Birmingham meeting of the British Association, September 1886, by Prof. H. Carvill Lewis, M.A., F.G.S.

lobes of ice and also often mark the line separating the glaciated from the non-glaciated areas.

The paper began with a sketch of recent investigations upon the glaciation of North America, with special reference to the significance of the terminal moraines discovered within the last few years. The principal characters of these moraines were given, and a map was exhibited showing the extent of the glaciated areas of North America, the course of the interlobate and terminal moraines, and the direction of striation and glacial movement. It was shown that, apart from the great ice sheet of North-Eastern America, an immense lobe of ice descended from Alaska to Vancouver's Island on the western side of the Rocky Mountains, and that from various separate centres in the Cascade, Sierra Nevada, and Rocky Mountains there radiated smaller local glaciers.

The mountains encircling the depression of Hudson Bay seemed to be the principal source of the glaciers which became confluent to form the great ice-sheet. In its advance, this ice-sheet probably met and amalgamated with a number of already existing local glacial systems, and it was suggested that there was no necessity for assuming either an extraordinary thickness of ice at the Pole, or great and unequal elevations and depressions of land.

Detailed studies made by the author in Ireland in 1885 had shown remarkably similar glacial phenomena.

The large ice-sheet which covered the greater part of Ireland was composed of confluent glaciers, while distinct and local glacial systems occurred in the non-glaciated area. The principal ice-sheet resembled that of America in having for its centre a great inland depression surrounded by a rim of mountains.

These appear to have given rise to the first glaciers, which, after uniting, poured outwards in all directions. Great lobes of this ice-sheet flowed westward out of the Shannon and out of Galway, Clew, Sligo, and Donegal Bays, northward out of Loughs Swilly and Foyle, and south-eastward out of Dundalk and Dublin Bays; while to the south the ice-sheet abutted against the Mullaghareirk, Galty, and Wicklow Mountains, or died out in the plains.

Whether it stopped among the mountains or in the lowlands, its edge was approximately outlined by unusual accumulations of drift and boulders, representing the terminal moraines. As in America, this outer moraine was least distinct in the lowlands, and was often bordered by an outer "fringe" of drift several miles in width.

South of an east and west line extending from Tralee to Dunganarvan is a non-glaciated zone free from drift. Several local systems of glaciers occur in the South of Ireland, of which by far the most important is that radiating from the Killarney Mountains, covering an area of 2000 square miles, and entitled to be called a local ice-sheet. Great glaciers from this Killarney ice-sheet flowed out of the fjord-like parallel bays which indent the south-western coast of Ireland. At the same time the Dingle Mountains, the Knockmealdown and Comeragh Mountains, and those of Wexford and Wicklow furnished small separate glaciers, each sharply defined by its own moraine.

No evidence of any great marine submergence was discovered, although the author had explored the greater part of Ireland, and the eskers were held to be phenomena due to the melting of the ice and the circulation of sub-glacial waters. The Irish ice-sheet seemed to have been joined at its north-eastern corner by ice coming from Scotland across the North Channel. All the evidence collected indicates that a mass of Scotch ice, reinforced by that of Ireland and England, filled the Irish Sea, over-riding the Isle of Man and Anglesey, and extending at least as far south as Bray Head, south of Dublin. A map of the glaciation of Ireland was exhibited in which the observations of the Irish geologists and of the author were combined, and in which was shown the central sheet, the five local glacial systems, all the known striae, and the probable lines of movement as indicated by moraines, striae, and the transport of erratics.

The glaciation of Wales was then considered. Wales was shown to have supported three distinct and disconnected local systems of glaciers, while at the same time its extreme northern border was touched by the great ice-lobe filling the Irish Sea. The most extensive local glaciers were those radiating from the Snowdon and Arenig region, while another set of glaciers radiated from the Plinlimmon district and the mountains of Cardiganshire, and a third system originated among the Brecknockshire Beacons. The glaciers from each of these centres transported purely local boulders and formed well-defined

terminal moraines. The northern ice-lobe, bearing granite boulders from Scotland and shells and flints from the bed of the Irish Sea, invaded the northern coast, but did not mingle with the Welsh glaciers. It smothered Anglesey and part of Carnarvonshire on the one side and part of Flintshire on the other, and heaped up a terminal moraine on the outer flanks of the North Welsh mountains. This great moraine, filled with far-travelled northern erratics, is heaped up in hummocks and irregular ridges, and is in many places as characteristically developed as anywhere in America. It has none of the characters of a sea-beach, although often containing broken shells brought from the Irish Sea. It may be followed from the extreme end of the Llyn Peninsula (where it is full of Scotch granite erratics), in a north-easterly direction through Carnarvonshire past Meol Tryfan and along the foot of the mountains east of Menai Strait to Bangor, where it goes out to sea, re-appearing further east at Conway and Colwyn. It turns south-eastward in Denbighshire, going past St. Asaph and Halkin Mountain. In Flintshire it turns southward, and is magnificently developed on the east side of the mountains, at an elevation of over 1000 feet, between Minera and Llangollen, south-west of which place it enters England. There is evidence that, where the ice-sheet abutted against Wales, it was about 1350 feet in thickness. This is analogous to the thickness of the ice-sheet in Pennsylvania, where the author had previously shown that it was about 1000 feet thick at its extreme edge, and 2000 feet thick at points some 8 miles back from its edge. The transport of erratics coincides with the direction of striae in Wales as elsewhere, and is at right angles to the terminal moraine.

The complicated phenomena of the glaciation of England, the subject of a voluminous literature and discordant views, had been of high interest to the author, and had led him to redouble his efforts for its solution. He had found that it was possible to accurately map the glaciated areas, to separate the deposits made by land ice from those due to icebergs or to torrential rivers, and to trace out a series of terminal moraines both at the edge of the ice-sheet and at the edge of its confluent lobes. Perhaps the finest exhibition of a terminal moraine in England is in the vicinity of Ellesmere, in Shropshire. A great mass of drift several miles in width, and full of erratics from Scotland and from Wales, is here heaped up into conical hills which inclose "kettle holes" and lakes, and have all the characters of the "kettle-moraine" of Wisconsin. Like the latter, the Ellesmere moraine here divides two great lobes of ice, one coming from Scotland, the other from Wales. This moraine may be traced continuously from Ellesmere eastward through Madeley, Macclesfield, to and along the western flank of the Pennine Chain, marking throughout the southern edge of the ice-sheet of northern England. From Macclesfield the same moraine was traced northward past Stockport and Staleybridge to Burnley, and thence to Skipton in Yorkshire. North-east of Burnley it is banked against the Bousworth Hills up to a height of 1300 feet in the form of mounds and hummocks. South and east of this long moraine no signs of glaciation were discovered, while north and west of it there is every evidence of a continuous ice-sheet covering land and sea alike. The striae and the transport of boulders agree in proving a southerly and south-easterly direction of ice-movement in Lancashire and Cheshire.

From Skipton northward the phenomena are more complicated. A tongue of ice surmounted the watershed near Skipton, and protruded down the valley of the Aire as far as Bingley, where its terminal moraine is thrown across the valley like a great dam, reminding one of similar moraine dams in several Pennsylvania valleys. A continuous moraine was traced around this Aire glacier. Another great glacier, much larger than this, descended Wensleydale and reached the plain of York. The most complex glacial movements in England occurred in the mountain region about the Nine Standards, where local glaciers met and were overpowered by the greater ice-sheet coming down from Cumberland. The ice-sheet itself was here divided, one portion going southward, the other in company with local glaciers and laden with the well-known boulders of "Shap granite" being forced eastward across Stainmoor Forest into Durham and Yorkshire, finally reaching the North Sea at the mouth of the Tees. The terminal moraine runs eastward through Kirkby Ravensworth, toward Whitby, keeping north of the Cleveland Hills, and all Eastern England south of Holderness appears to be non-glaciated. On the other hand, all England north of Stainmoor Forest and the River Tees, except the very highest points, was smothered in a sea of solid ice.

There is abundant evidence to prove that the ice-lobe filling the Irish Sea was thicker towards its axis than at its edges, and the north than at its southern terminus, and that it was reinforced by smaller tributary ice-streams from both England and Ireland. It may be compared with the glacier of the Hudson River Valley in New York, each having a maximum thickness of something more than 3000 feet. The erosive power of the ice-sheet was found to be extremely slight at its edge, but more powerful farther north, where its action was continued for a longer period. Towards its edge its function was to fill up inequalities rather than to level them down. It was held that most glacial lakes are due to an irregular dumping of drift, rather than to any scooping action, observations in England and in Switzerland coinciding with those in America to confirm this conclusion. Numerous facts on both sides of the Atlantic indicate that the upper portion of the ice-sheet may move in a different direction from its lower portion. It was also shown that a glacier in its advance had the power of raising stones from the bottom to the top of the ice, a fact due to retardation by friction of its lower layers. The author had observed the gradual upward passage of sand and stones in the Grindelwald glacier, and applied the same explanation to the broken shells and flints raised from the bed of the Irish Sea to the top of foel Tryfan, to Macclesfield, and to the Dublin mountains.

The occurrence of stratified deposits connected with un doubted moraines, was shown to be a common phenomenon, and instances of stratified moraines in Switzerland, Italy, America, and Wales, were given. The stratification is due to waters derived from the melting ice, and is not proof of submergence.

It was held that, notwithstanding a general opinion to the contrary, there is no evidence in Great Britain of any marine submergence greater than about 450 feet. It was to be expected that an ice-sheet advancing across a sea-bottom should deposit shell-fragments in its terminal moraine. The broad principle was enunciated that wherever in Great Britain marine shells occur in glacial deposits at high levels, it can be proved both by striæ and the transport of erratics that the ice advanced on to the land from out of the sea. The shells on Three Rock Mountain near Dublin, and in North Wales and Macclesfield, all from the Irish Sea; the shells in Cumberland transported from Solway Firth; those on the coast of Northumberland brought out of the North Sea; those at Airdrie in Scotland, carried eastward from the bottom of the Clyde; and those in Caithness from Moray Firth, were among examples adduced in proof of this principle. The improbability of a great submergence not leaving corresponding deposits in other parts of England was dwelt upon.

It was also held that there was insufficient evidence of more than one advance in the ice-sheet, although halts occurred in its retreat. The idea of successive elevations and submergences with advances and retreats of the ice was disputed, and the author held that much of the supposed inter-glacial drift was due to sub-glacial waters from the melting ice.

The last portion of the paper discussed the distribution of boulders, gravels, and clays south of the glacial area. Much the greater part of England was believed to have been uncovered by sand and ice. The drift deposits in this area were shown to be the result in part of great fresh-water streams issuing from the melting ice-sheet and in part of marine currents bearing icebergs during the submergence of some 450 feet. The supposed glacial drift about Birmingham and the concentration of boulders at Wolverhampton were regarded as due to the former agent, while the deposits at Cromer and the distribution of Lincolnshire chalk across Southern England were due to the latter. The supposed esker at Hunstanton was held to be simply a sea-beach, and the London drift deposits to be of aqueous origin. Thus the rival theories of floating icebergs and of land glaciers were both true, the one for Middle and Southern England, the other for Scotland, Wales, and the North of England; and the line of demarkation was fixed by great terminal moraines. The paper closed with an acknowledgment of indebtedness to the many geologists in England and Ireland who had uniformly rendered generous assistance during the above investigation.

THE CLIMATE OF NORTHERN EUROPE AND THE GULF STREAM

IN view of the reference made by Sir William Dawson, in his inaugural address at the meeting of the British Association, to the effect of the Gulf Stream on the climate of Northern

Europe, particularly that of Norway, and the consequences of a diversion of the stream from its present course, the following contribution to the subject by the well-known Norwegian *savant*, Dr. Karl Hesselberg, which appeared in a recent number of the scientific journal *Naturen*, may be of interest and tend to its further elucidation.

According to the situation of Norway on the globe, the northern part of the country should have a distinct Polar climate, with eternal ice and snow, a home only for the Eskimo and Polar bears. Several circumstances contribute, however, to make it otherwise. The country forms a western promontory of the great Asiatic-European continent, and receives its full share of the advantages of such a situation. Mild south-west winds blow throughout the year, while warm sea-currents wash its extensive shores summer as well as winter. The winter cold is so reduced that only a small portion of the heat of the summer sun is consumed in melting the snow. The length of the summer days, too, which north of the Polar Circle last twenty-four hours, contribute to raise the mean temperature, and accelerate the growth of the flora. Certain other circumstances, as, for instance, the formation of the country and the physico-geographical conditions of the North Atlantic Ocean, contribute equally to make the Norwegian climate one of the most favourable in the world. A brief *résumé* of the circumstances will be of interest.

A chart of the distribution of the atmospheric depression in the North Atlantic Ocean—the Norwegian Sea—shows that all the year round a strong barometric minimum prevails in the middle of the sea between Norway, Iceland, Jan Mayen, and Spitzbergen, the consequence of which is that south-west winds always blow in the eastern part of this area, viz. along the coast of Norway. Warm water is thereby forced up towards Norway and Spitzbergen, even into the East Arctic Ocean. The bottom formation of the sea, too, contributes to preserve the high temperature. If a chart be examined of the depths of the North Atlantic Ocean, such a one, for instance, as is the result of Prof. Mohn's labours after the measurements of the Norwegian North Atlantic Expedition, it will be found that the sea-bottom between Norway, the Faroe Islands, Iceland, and Jan Mayen, forms a basin with a depth of a little over 2000 English fathoms. It will also be seen that the Norwegian coast does not fall abruptly into this abyss, but that the bottom along the whole coast slopes gradually down from the shore seawards to a certain point where it terminates perpendicularly. In other words, Norway is surrounded with a continuous "bank," which in a great measure contributes to preserve the high temperature along the coast. In the great basin, however, the water is icy cold at the bottom, but against this the bank forms a natural barrier, whilst above the bank the warm water is without any bottom layer of cold. It is the warm water which fills the fjords and there preserves a temperature so high that it is sometimes higher than the mean temperature of the air, and under which the fjords do not freeze, a circumstance of great importance. If the temperature of the sea-water in the winter contributes to raise the temperature of the air, it will in the summer have the opposite effect, and cause the climate to be very much tempered along the coast. It is only in the fjords and adjacent valleys that the temperature in the summer rises to a height unusual for the latitude.

In order to show the relatively favourable climate which Norway enjoys, Dr. Hesselberg supplies two diagrams. The first of these shows the mean temperature of the air over Europe and the North Atlantic Ocean in January, when it is lowest. Isotherms are shown for every fifth degree. If now, for instance, the isotherm 0° —the temperature of the air—be followed, it will at once be seen how far it shoots up northwards between Iceland and Norway, in fact, right above lat. 70° N. Instead of running east and west, it goes nearly straight north and south, particularly along the west coast of Norway, which it follows throughout its entire length, from the latitude of Tromsø to that of Christiansand. Hence it deviates towards Denmark, then runs into the Baltic, returns to Hamburg, and thence runs in a south-easterly direction across Europe, nearly down to the Adriatic Sea. Here it first trends eastwards, across Turkey and the Black Sea. Off the Norwegian coast, therefore, in lat. 70° N., the same mean temperature prevails in January as in Southern Europe in lat. 45° , and even there the mean temperature is probably 3° higher than might be expected according to the latitude. The other isotherms have a similar course, as well as the temperature at the surface of the sea. A great wave of warm water rolls up

along the coast of Norway, and may be traced even to Spitzbergen.

Another equally interesting illustration of the mildness of the winter in Norway is shown by two diagrams of the "thermal anomaly" in January. By way of comparison the month of July is included. It may be added that by thermal anomaly is meant the difference which exists between the true mean temperature of a place and the mean temperature actually registered in that latitude.

In January the thermal anomaly is very remarkable. Thus, along the coast of Norway, between the northernmost and westernmost promontories, the North Cape and Stat, it reaches + 20° C., and in the sea outside most probably + 25° C. These are certainly very remarkable. Eastwards, it decreases inland, but even here—where the cold is very great in the winter—it never falls below + 7°. In the Baltic, on the other hand, it again rises, as might be expected.

In the summer, however, the conditions are far from being so favourable. There is, indeed, then a narrow strip of land, on the very verge of the coast, where the thermal anomaly is slightly negative. The line for the 0° C. anomaly then follows the west coast, decreasing gradually seawards, whilst eastwards, across Southern Norway, it rises to + 4° C., and in Finmarken to + 70° C.

For the further elucidation of this, the following comparison of the January mean temperature in various places on the globe in about the same latitude may serve:—

About 60° N. lat.

Hellisö Lighthouse...	0
Bergen	0
Christiania	- 5
Stockholm	- 3
St. Petersburg	- 10
Jakutsk	- 42
North Kamchatka	- 20
South Alaska	- 20
Great Slave Lake	- 25
North Coast of Labrador	- 25
Cape Farewell	- 7
Shetland Islands	4

About 71° N. lat.

North Cape...	- 4
South Novaya Zemlya	- 20
Mouth of the Yenisei	- 34
Mouth of the Lena	- 40
Point Barrow	- 30
Boothia	- 32
Upernivik	- 20
Jan Mayen	- 10

The coldest place on the globe where the mean temperature has been exactly ascertained, viz. Werchojansk, in the interior of Siberia, with - 48° C. in January, lies in the same latitude as Bodö, where it is - 2° C., and Röst, with 0° 5 C.

In order to obtain correct normal values of the temperature in a place, long and continuous series of observations are necessary; and when we consider that the longest we possess for any place only extends over 100 years, and that meteorology is but a science of yesterday, the Norwegian meteorological records can make a fair show. With regard, however, to the changes which take place in the climate in a certain spot during ages— which occurrence is beyond dispute—we have no reliable data. I will only mention here Prof. Blytt's theory,¹ which has attracted many supporters, viz. that the periodical changes in the climate are due to the precession of the equinoxes (with a mean period of about 21,000 years), and to changes in the eccentricity of the earth's orbit.

It is, however, possible to accept a shorter periodical change in the climate than this, and theories on this point have not been wanting; but the only one which has found any support is the eleven-year period, corresponding to that of the sunspots, which again coincides with that of the terrestrial magnetic phenomena. It has even been attempted to bring the fall of rain and snow within a certain law, and, as some maintain, with success; but in my opinion the proofs advanced in support of such a theory are far from being conclusive.

¹ Cf. Prof. Darwin's Address to the British Association, Section A; also NATURE, vol. xxiv. pp. 220 and 230.

TO PROVE THAT ONLY ONE PARALLEL CAN BE DRAWN FROM A GIVEN POINT TO A GIVEN STRAIGHT LINE

(1) LET OP and OQ be two lines at right angles, and let PQ move along them from O, so that OP always = OQ. Then PQ always > OQ or OP. Hence if OQ increase without limit, PQ must also do so. Let ON bisect the angle POQ. Then N bisects PQ. Then if OQ increase without limit, QN does so (QN = 1/2 QP). If OQ' be taken along ON = OQ, QQ' > QN. Hence if OQ increase without limit, QQ' does so. Similarly by bisecting Q'OQ by OM, we can show that QM increases without limit with OQ, and so on by continual bisection. Hence— If two straight lines meet at any angle, the perpendicular from a point of one on the other becomes infinite when that point is at infinity.

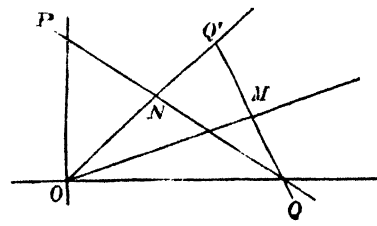

FIG. 1.

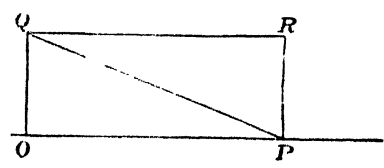

FIG. 2.

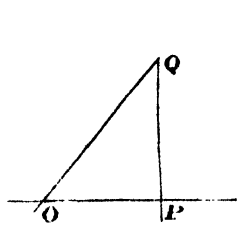

FIG. 3.

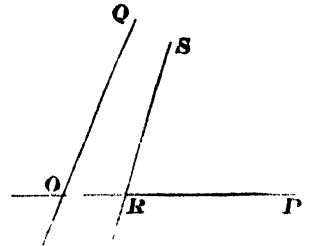

FIG. 4.

(2) Let OQ be some given length taken at right angles to a line OP; Let PR move along OP at right angles to OP, so that PR always = OQ. Join QR, QP. Let OP increase without limit. Then the angle PQR tends to become zero. For the lines QR, PQ never become infinitely separated. Thus there is evidently some definite position for the line QP when OP becomes ∞. (3) Let a line PQ move at right angles to OP, so that PQ = OP. Then if OP increase without limit, OQ increases without limit. Hence, there is some finite angle, QOP, such that the perpendicular QP from Q at ∞ on OP falls at an infinite distance from O. The same thing is evidently true for all angles less than QOP. Then either it is true of all angles less than a right angle, in which case it can be easily shown that only one parallel can be drawn from a given point to a given line; Or, there is some limiting angle, QOP, for which QP falls at ∞, and for any greater angle (< right angle) QP falls at some finite distance from O.

Let QOP be this limiting angle. Take R on OP , and draw RS to Q at ∞ along OQ .

Then if s is at ∞ , the perpendicular SP falls at an infinite distance from R .

Angle PSR not greater than POQ , and it cannot be less. (Eucl., I., 16 and 27).

Hence it must be equal.

Hence RS making the angle $SRP = QOP$ meets OQ at ∞ at both ends.

And any other straight line through R becoming infinitely distant from RS must cut OQ in some finite point.

Thus from R only one parallel, RS , can be drawn to a given line, OQ .

By moving OP along OQ always at the same angle, QOP , we can show that

From a given point only one parallel can be drawn to a given line.

This theorem, therefore, must be true.

E. BUDDEN

SCIENTIFIC SERIALS

American Journal of Science, October.—A dissected volcanic mountain; some of its revelations, by James D. Dana. Here the author returns to the subject of Tahiti, largest of the Society Islands, already described by him in 1850 from materials supplied by the Wilkes Exploring Expedition of 1839. The old cone, some 7000 feet high, is now a dissected mountain, with valleys cut profoundly into its sides, and laying bare the centre to a depth of from 2000 to nearly 4000 feet below the existing summit. As shown on the accompanying map, the valleys, due to erosion, are so crowded on one another, that the dissection is complete, thus disclosing the inner structure of a great volcanic mountain. The interior is shown to be composed, not of lava-beds, there being no horizontal lines, but of imperfect columnar formations, rising vertically in the unstratified mass quite to the summit. The uniform massiveness through so great a height at the volcano's centre is attributed to the cooling of continuously liquid lava in the region of the great central conduit of the cone. A comparative study of Mauna Loa (Hawaii), shows that such a massive central structure is a common feature of the greater volcanic mountains, the extremely slow cooling process under great pressure causing the lava to solidify into a compact crystalline rock, and often into a coarsely crystalline rock.—Origin of the ferruginous schists and iron ores of the Lake Superior region, by R. D. Irving. Rejecting the gneuc theory, now held by few, the writer, after a careful survey of the whole field, concludes that these rocks were once carbonates analogous to those of the coal-measures, which by a process of silicification were transformed into the various kinds of ferruginous formations now occurring in this region.—Further notes on the artificial lead silicate from Bonne Terre, Montana, by H. A. Wheeler. An analysis of this interesting substance, which was found under the hearth of an old reverberatory roasting-furnace, yielded 73.66 PbO, 17.11 SiO₂, NiO 3.06 (coarse crystals), 72.93 PbO, 18.51 SiO₂, and smaller quantities of nickel, cobalt, and other ingredients.—Limonite pseudomorphs after pyrite, by John G. Meem. The paper gives a short account of the pseudomorphs occurring in Rockbridge County, Virginia, where they are associated with Lower Silurian limestones. These crystals, varying in colour from a very light to a very dark brown, and sometimes almost black, are hydrous, and yield a yellow powder, showing them to be limonite, most commonly of octahedral form.—Note on the hydro-electric effect of temper in case of steel, by C. Barus and V. Strouhal. The object of this inquiry is to determine directly the carbon relations of steel as a function of the temperature (0° to 400°, 100° to 1000°) and of the time of annealing, with full reference to the physical occurrences observed in the first and second phases of the phenomenon.—On the crystalline structure of iron meteorites, by Oliver Whipple Huntington. It is shown that the usual classification of these meteorites into octahedral and cubic crystals cannot be natural or fundamental. A careful examination of the large collection belonging to Harvard College, containing types of all the characteristic meteorites of this class, leads to the conclusion that masses of meteoric iron are cleavage crystals, broken off probably by impact with the air, and showing cleavages parallel to the planes of all three fundamental forms of the regular system (octahedron, cube, and dodecahedron); that the Widmanstätten figures and Neumann lines

themselves are sections of planes parallel to these same forms, exhibited in every gradation from the broadest bands to the finest markings, with no natural break, the features of von Widmanstätten's figures being, moreover, due to the elimination of impurities during the process of crystallisation.—A new meteoric iron from Texas, by W. Earl Hidden. The specimen here described and illustrated was discovered by Mr. C. C. Cusick on June 10, 1882, near Fort Duncan, Maverick County, Texas. It weighs over 97 pounds, is quite soft, being easily cut with a knife, and consists of iron 94.90; nickel and cobalt, 4.87; phosphorus, 0.25, with traces of sulphur and carbon; specific gravity, 7.522.—On pseudomorphs of garnet from Lake Superior and Salida, Colorado, by S. L. Penfield and F. L. Sperry. The Lake Superior specimen is essentially an iron alumina garnet, with formula Fe₂Al₂Si₂O₁₂. That of Colorado is higher in protoxides and water, the increase being perhaps due to the presence of ripidolite.—Further notes on the meteoric iron from Glorieta Mount, New Mexico, by George F. Kunz.—On the Brookite from Magnet Cove, Arkansas, by Edward S. Dana. These crystals, first described in 1846 by Shepard under the name of *arkansite*, are especially remarkable for the great variety of their forms, which is most unusual for crystals occurring in the same locality.

SOCIETIES AND ACADEMIES

LONDON

Zoological Society, November 16.—Prof. W. H. Flower, F.R.S., President, in the chair.—An extract was read from a letter addressed to the President by Dr. Emin Bey, dated Wadilai, Eastern Equatorial Africa, January 1, 1886, and containing some notes on the distribution of the Anthropoid Apes in Eastern Africa.—A letter was read, addressed to the Secretary by Dr. Chr. Lütken, of Copenhagen, F.M.Z.S., containing some information as to the locality of *Chiropodomys penicillatus*.—A letter was read from Dr. A. B. Meyer, C.M.Z.S., communicating some remarks by Mr. K. G. Henke on a specimen of a hybrid Grouse in the Dresden Museum.—Prof. Flower, F.R.S., exhibited and made remarks on a specimen of a rare Armadillo (*Tatusia pilosa*) belonging to the Scarborough Museum.—Prof. Bell exhibited, and made remarks on, an object (apparently of the nature of an amulet) made from a portion of the skin of some mammal, and received from Moreton Bay, Australia.—Mr. H. Seeböhm, F.Z.S., exhibited a skin of what he considered to be a young individual of the Lesser White-fronted Goose (*Anser albifrons ninutus*), shot in September last on Holy Island, off the coast of Northumberland, and observed that it was the first recorded example of the small form of the White-fronted Goose which had been obtained on the coasts of our islands.—Mr. Blanford, F.R.S., exhibited, and made remarks on, a mounted specimen of a scarce Paradoxure (*Paradoxurus jerdoni*) from the Neilgherry Hills in Southern India.—A communication was read from Colonel Charles Swinhoe, F.Z.S., containing an account of the species of Lepidopterous insects which he had obtained at Mhow, in Central India.—A communication was read from Dr. R. W. Shufeldt, C.M.Z.S., containing an account of the anatomy of *Geococcyx californianus*.—Mr. Lydekker described three crania and other remains of *Scelidotherium*, two of the former being from the Argentine Republic, and the third from Tarapaca, in Chili. One of the crania from the first locality he referred to the typical *S. leptcephalum* of Owen, while the second, which had been described by Sir R. Owen under the same name, he regarded as distinct, and proposed to call *S. bravardi*. The Tarapaca form, which was characterised by the extremely short nasals, was also regarded as indicating a new species, for which the name of *S. chilense* was proposed. The author concluded that there were not sufficient grounds for separating Lund's proposed genus *Platyonyx* from *Scelidotherium*.—Mr. G. A. Boulenger pointed out that two distinct forms of the Batrachian genus *Bombinator* occur in Central Europe, and read notes on their distinctive characters and geographical distribution.—A communication was read from Dr. R. W. Shufeldt, containing a correction, with additional notes, upon the anatomy of the *Trochili*, *Caprimulgi*, and *Cypselida*.—A communication was read from Dr. R. A. Philippi, C.M.Z.S., containing a preliminary notice of some of the Tortoises and Fishes of the coast of Chili.—Mr. Sclater exhibited the head of, and made remarks upon, an apparently undescribed species of Gazelle from Somali Land.

Geological Society, November 3.—Prof. J. W. Judd, F.R.S., President, in the chair.—Henry Howe Arnold-Bemrose, Richard Assheton, Francis Arthur Bather, Rev. Joseph Campbell, M.A., John Wesley Carr, Thomas J. G. Fleming, Thomas Forster, Edmund Johnstone Garwood, George Samuel Griffiths, Dr. Frederick Henry Hatch, Ph.D., Robert Tuthill Litton, Frederick William Martin, Richard D. Oldham, Forbes Rickard, Albert Charles Seward, Herbert William Vintner, and Charles D. Walcott were proposed as Fellows of the Society.—The following communications were read:—On the skull and dentition of a Triassic Saurian, *Galesaurus planiceps*, Ow., by Sir Richard Owen, K.C.B., F.R.S. The author referred to a fossil skull from the Triassic sandstone of South Africa, which combined dental characters resembling those of a carnivorous mammal with the cranial structure of a Saurian. The structure was described and figured in Owen's "Catalogue of the Fossil Reptilia of South Africa," under the generic title of *Galesaurus*, as belonging to a distinct sub-order of Reptilia termed *Theriodontia*. The characters of the skull and teeth of the original specimen of *Galesaurus* have been brought to light by further development. In both the type-specimen and that lately received, the reptilian nature of the fossil is indicated by the single occipital condyle and other features. The chief difference from a mature male of a placental or marsupial carnivore is the evidence of a primordial "gullet-tract." Further details as to the structure of the skull were given, more especially with reference to the orbits and nasals. The palatal region repeats the same general characters as in previously described Theriodonts. The angle of the jaw is not produced, as in the crocodile, beyond the articular element. In general shape and bony strength the mandible of *Galesaurus* resembles that of a mammal. The dentition is so much better preserved in the new specimen than in the type *Galesaur* as to call for description and illustration. In four of the upper molars the entire crown is preserved; it shows less length and greater breadth than appears in the previous restoration, is moderately curved externally, and triangular; the base is flanked by a short cusp before and behind, and the corresponding margins are finely crenulate, as in the molars of *Cynodracon*. The incisors are eight in number in both upper and lower jaws, four in each premaxillary, opposed or partially interlocking with the same number in each mandibular ramus; they have longish, slender, simple-pointed crowns. The canines, one on each side of both upper and lower jaws, have the same lanianiform shape and size of crown as in the original fossil. In the right maxillary bone the long deeply-planted root is exposed; the corresponding part of the lower canine is similarly exposed in the left mandibular ramus. No trace of successional teeth, as in ordinary Saurians, has been found. Both crocodiles and alligators have two or more teeth of canine proportions; but the author shows how they differ from those of mammalian carnivores and *Galesaurus*. A similar character and disposition of destructive canines is shown by the fossil jaws of the oolitic great extinct carnivorous Saurians, e.g. *Megalosaurus*. In the Triassic Labyrinthodonts the destructive and prehensile lanianaries would, by position, rank as incisors rather than canines. In existing lizards the dental series has more uniformity, and the cement-clad roots contract bony union with the jaw-bone. In *Galesaurus* the teeth, besides being distinguished, as in mammals, by their differential characters, are implanted freely in sockets, the cold-blooded character being chiefly manifested in the greater number of teeth following the canines, and in their want of distinction. Lastly, the author remarked on the earlier reptilian character shown by the oolitic mammal *Amphitherium*, and also by the existing Australian *Myrmecobius*. He speculates on the degree of resemblance manifested by the teeth of the old Triassic reptile of South Africa with the exceptional characters of some of the low Australian forms of mammals.—The Cetacea of the Suffolk Crag, by R. Lydekker, B.A., F.G.S. This paper commenced with notices of previous contributions to the subject by Sir R. Owen, Prof. Ray Lankester, Prof. Huxley, and Prof. Flower. In the preparation of a catalogue of the specimens in the British Museum, the author had had occasion to examine the collection of Cetacea from the Crag, not only in that Museum, but also in the Museum of Practical Geology, that of the Royal College of Surgeons, and in the Ipswich Museum, besides visiting the collections at Brussels. In consequence, several additions to the fauna, and also numerous emendations of specific names, were noticed in the paper now laid before the Society. Prof. Ray Lankester's views as to the Diestian affinities of the English Crag Cetacea were confirmed by this comparison. De-

tailed notes on the specimens examined and the species identified were given.—On a jaw of *Hyotherium* from the Pliocene of India, by R. Lydekker, B.A., F.G.S. Colonel Watson, the Political Resident in Kattiawar, had recently sent to the author a fragment of a left maxilla with the three true molars, from Perim Island, in the Gulf of Cambay. The specimen belonged to *Hyotherium*, and apparently to an undescribed species, the differences between which and the several forms previously known from various European and Asiatic beds were pointed out. The author also called attention to the peculiar association of types found in the beds of Perim Island, and to the affinities of the genus *Hyotherium* with the recent *Sus* and *Dicotyles* on the one hand, and with the Upper Eocene *Charopotamus* on the other.

Physical Society, November 13.—Prof. Balfour Stewart, President, in the chair.—In opening the proceedings, the President referred to the great loss which the Society had recently sustained by the death of Prof. Guthrie, F.R.S., the founder of the Society, and his predecessor in the chair. In the capacity of Demonstrator, Prof. Guthrie contributed materially to the success of the Society's meetings, and his decease is deeply regretted. The President also announced that the Council were considering what steps should be taken to commemorate the late Dr. Guthrie, and that a circular containing their views would be placed before the members in the course of a few days.—The following papers were then read:—On the peculiar sunrise shadows of Adam's Peak, in Ceylon, by the Hon. Ralph Abercromby, F.R.Met.Soc. The author prefaced his description by an extract from a paper on the same subject by the Rev. R. Abbay, read before the Physical Society, May 27, 1876, in which the explanation proposed is that the effects are caused by total internal reflection, as in ordinary mirage, the difference of air-density being, in this case, due to the lower temperature at high altitudes. The author pointed out that Mr. Abbay neglects the difference of density due to elevation, and that his own thermometric observations disprove conclusively any idea of mirage. The chief phenomena observed were: (1) the appearance of a circular rainbow with spectral figures near the top of the shadow of the peak; and (2) a peculiar rising of the bow and shadow, which seem to stand up in front of the observers. Both these effects are traced to the existence of mist-clouds in the vicinity of the shadow. Two dark rays or brushes were seen to shoot outwards and upwards from the circumference of the bow in directions nearly coinciding with the prolongations of the edges of the shadow, when seen projected on the lower mist-clouds, but the author does not attempt to explain this phenomenon. On one occasion a second and outer bow was seen. The times during which the phenomena were visible were too short to permit sextant observations being taken, but the diameter of the inner bow was estimated at 8° to 12°. A totally distinct kind of shadow is sometimes seen from Adam's Peak just before, and at the moment of sunrise, which seems to stand up against the distant sky. The author found a similar effect at Pike's Peak, Colorado, which is visible only at sunset. Mr. G. Griffiths remarked that he had often seen similar appearances in Switzerland. In answer to questions by the President and Prof. S. P. Thompson, the author said the reason why the shadows were seen from Adam's Peak at sunrise, and from Pike's Peak at sunset, was that the configuration of the land on the west side of the former was similar to that on the east side of the latter, both being low, whereas the opposite sides were high, and therefore unsuitable for showing the phenomena. In all cases he believed the appearances were due to the shadows being projected on clouds of suspended matter in the air at various altitudes. He had not noticed whether the colours were reversed in the second bow seen from Adam's Peak, but observed that this bow nearly, but not quite, touched the inner one.—Note on the internal capacity of thermometers, by A. W. Clayden, M.A. (Read by Prof. Reinold, Secretary.) The author proposes to determine the volume, V , of the mercury by measuring the capacity, c , of a detached piece of the same tube of known length, and thence inferring the volume of t degrees of the thermometer tube, the length of which is equal to that of the piece of tube taken. By assuming the value of a (the coefficient of apparent expansion of mercury in the particular kind of glass) to be known, the volume of the mercury in the thermometer can be calculated, since $c = t a V$. Prof. Rücker remarked that there were often considerable differences in the sectional area of different parts of the same tube, and hence the

on some New South Wales fishes, by Dr. Ramsay, F.R.S.E., and J. Douglas-Ogilby. The common Jew Fish of Port Jackson is here described under the name of *Sciæna neglecta*, the authors pointing out the marked differences between it and *S. antarctica*, Castelnau, and *S. aquila*, Lacep., the species to which it has been hitherto referred. Evidence is also given that *Callionymus roosei*, Rich., is not, as has been stated, the female of *C. curvicornis*, C. and V.

PARIS

Academy of Sciences, November 15.—M. Jurien de la Gravière, in the chair.—Letters having been read from M. de Freycinet announcing the death of M. Paul Bert, Resident-General in Annam and Tonquin, and Member of the Academy, the President and M. Vulpian followed with some remarks on the great services rendered to science by this distinguished physiologist. Reference was made more especially to his researches on the action of light on living organisms; on the physiology of respiration; and on the influence exercised on man, animals, plants, and ferments, by increased or diminished pressure of atmospheric air, of carbonic acid, and of oxygen.—Observations of the small planets made with the large meridian instrument of the Paris Observatory during the second quarter of the year 1886, communicated by M. Mouchez. Numerous observations made by M. P. Puiseux on Pallas, Juno, Olympia, Electra, Urania, Europa, and several other minor planets, are here brought into relation with the ephemerides either of the *Nautical Almanac*, the *Bulletin Astronomique*, or the Berlin *Fahrbuch*.—Researches on the phosphates, by M. Berthelot. Fresh researches are here reported on the double decompositions which reveal in the insoluble tribasic phosphates the existence of two distinct states: one colloidal, amorphous, unstable, answering to the manifold constitution of the soluble phosphates; the other crystallised and stable, in which the three basic equivalents seem on the contrary to play the same part. The phosphates of soda, magnesia, baryta, lime, manganese, and the tribasic phosphates of strontian are specially considered.—Observations of Winnecke's comet, by M. L. Cruls. As observed during last September at the Observatory of Rio de Janeiro, this comet presented the appearance of a nebulosity about 2' in diameter, without clearly-defined nucleus, of somewhat circular form and slight luminous intensity.—Note on Abel's theorem, by M. G. Humbert.—On the flow of a gas penetrating into a receptacle of limited capacity, by M. Hugoniot. The question here dealt with is to determine the time required to fill a receptacle containing air at an initial pressure p_0 , and placed in communication with a reservoir maintained by compressing-engines at a constant pressure $p_1 > p_0$. The reading of the paper was followed by some remarks by M. Haton de la Goupillière on this fresh confirmation of his own theories on the flow of gases.—On the variation of the magnetic field produced by an electromagnet, by M. Leduc. Reference is made to M. Marcel Deprez's communication of October 26, which partly confirmed the conclusions already arrived at by the author, and announced to the Société de Physique on February 19, 1886. But the results obtained present considerable numerical differences, which may be due to the different conditions under which the experiments were made.—On the specific inductive power and conductivity of dielectrics: relation between conductivity and absorbing power, by M. J. Curie.—On the velocity of dissociation, by M. H. Lescoeur. It is shown that the results drawn from the velocity of dissociation may supply valuable data regarding the presence of the hydrates and analogous compounds; but they can give no absolute or relative indications respecting the tensions of dissociation.—On some laws of chemical combination, by MM. de Landero and Raoul Prieto. In these studies, of which a few preliminary essays are here communicated, chemical combination is regarded as resulting from the shock of a collision between the particles of the elements forming any given compound. The velocity of the particles in motion being considered as a characteristic constant of each body, the loss of energy or of vital force due to the shock between non-elastic particles is regarded as the equivalent of the quantity of heat liberated by the fusion.—On some histological peculiarities of the acephalous mollusks, by M. Louis Roule.—On the typical nervous system of the ctenobranch mollusks, by M. E. L. Bouvier.—On platyrrhinism in a group of African apes, by M. A. T. de Rochebrune. It is shown that the family of the Colobi forms a marked exception to the general rule that the apes of the Old World are all catarrhines. As already anticipated by Dahl-

bom and Gray, they prove to be distinctly platyrrhines, like the American Simiæ.—Experimental researches on the thesis of the lichens in a medium destitute of germs, by Gaston Bonnier. The researches carried out by the author since 1882 have resulted in the complete reproduction by a thesis of a certain number of species of lichens under conditions fully confirming the views generally held regarding the complex nature of these vegetable organisms. The results clearly show that a lichen is formed by the association of an Alga and fungus.—The avifauna of the Mentone caves, by M. Ét. Rivière. Of the forty-two species found in these caves, all survive except *Pyrrhocorax primigenius*, but their present distribution mostly differs from that of Quaternary times, many having disappeared from the Mentone district, owing to climatic changes, the destruction of forests, and the chase.—On the Jurassic Echinidæ of Lorraine, by M. G. Cotteau. The researches made by the author in this branch of palæontology show that in Lorraine the Echinidæ followed the same line of development as in other Jurassic regions.—A physiological study of the respiratory function in singers, by M. Anatole Piltan. Observations made in various institutes show that the quality of the voice is inherent to the expiratory type adopted by the subject whether unconsciously or acquired by special training. Bacteriological studies on the Arthropods, by M. Balbiani.

CONTENTS

PA

Exploration of the North Sea	PA
Our Book Shelf:—	
Lupton's "Chemical Arithmetic"	
Heaton's "Experimental Chemistry"	
Letters to the Editor:—	
The Sense of Smell.—Edward L. Nichols and E. H. S. Bailey	
Tidal Friction and the Evolution of a Satellite.—James Nolan	
Seismometry in Japan.—Prof. J. A. Ewing	
Ozone Papers in Towns.—Dr. W. J. Black	
The Similarities in the Physical Geography of the Great Oceans.—J. Y. Buchanan	
Lung Sick.—Dr. Gérard Smets	
Meteor.—P. L. Sclater, F.R.S.	
The Origin of Species.—Joseph John Murphy; Edmund Catchpool	
The Coral Reefs of the Solomon Islands. By Dr. H. B. Guppy. (Illustrated)	
The British Association and Local Scientific Societies	
The Colonial and Indian Exhibition. By John R. Jackson	
Notes	
Our Astronomical Column:—	
The Mass of Mercury	
The Naval Observatory	
Comet Finlay (1886 e)	
Comet Barnard (1886 f)	
Gore's Nova Orionis	
Astronomical Phenomena for the Week 1886 November 28—December 4	
Ten Years' Progress in Astronomy, II. By Prof. C. A. Young	
A Lecture Experiment on the Expansion of Solids by Heat. By H. G. Madan. (Illustrated)	
Comparative Studies upon the Glaciation of North America, Great Britain, and Ireland. By Prof. H. Carvill Lewis	
The Climate of Northern Europe and the Gulf Stream	
To Prove that only One Parallel can be drawn from a Given Point to a Given Straight Line. By Dr. E. Budden. (Illustrated)	
Scientific Serials	
Societies and Academies	

THURSDAY, DECEMBER 2, 1886

INDUSTRIAL EDUCATION IN AMERICA

Industrial and High Art Education in the United States.
Part I. "Drawing in Public Schools." By J. Edwards Clarke, A.M. (Washington: Government Printing Office, 1885.)

CHANGES required in school training, in the substance as well as in the method of it, are now felt to be a vital question to the political economist and the law-maker, as well as to the moralist. While the old apprenticeship system was in its vigour, the youth was taught at school the three R's and whatever other branches of a liberal education his parents could afford, and for seven years after that technical instruction was given to him in all the branches of the trade he had chosen by his master, the best teacher that could be found in those days. But under the influence of machinery that system has completely collapsed, and the feeling is rising everywhere that something must be done at school to replace instruction given of old by the master. Theorists insist that nothing short of a technical school, where each trade is taught from beginning to end, will sufficiently replace the care and the interest of the latter, and they hold up the Russian Strogonoff school as an example of their being taught in this complete way and triumphantly compare its work with that of the best manufacturing countries. They urge that in a system of public education like that of the United States it is a serious fault that, while a classical or professional education is provided free for the youth who desires it, technical instruction is denied to a far larger body of mechanics who have as perfect a claim to the education they require. In Stockholm the experiment of every elementary school having a carpenter's and joiner's shop attached is being tried, but the impracticability of carrying on in every town schools where instruction in each art can be efficiently given to the labouring classes has left the teaching of theorists little else but theory, and a technical school giving instruction in the one or two principal trades of a district is all that can be looked for.

One item of education, however, has made its way in most European countries, as being a help to all technical work, encouraging observation and correctness, and enabling such observation to be registered and expressed. It is here asserted to be a qualification for nine-tenths of occupations into which all labour is divided, and is welcomed by the most advanced supporters of technical schools as the first step. Reading, writing, arithmetic, and drawing are now to be the four fundamental studies. Knowledge of it is essential in many of the studies in the schools of science, and especially useful to all engaged in the profession of teaching. More doubtful assertions are that like other technical teaching it does not necessarily interfere with or hinder other work, and that it positively assists in learning to write; this latter having the authority of the London School Board, as well as that of an American writer quoted in this volume. The rise in value also in the labour-market of each mechanic who has the power to draw or even understand a drawing of a technical arrangement is often insisted upon; but when

such an accomplishment has become common to all, and therefore gives its possessor no superiority, this is rather doubtful, though the raising of a whole class to the capacities of artists and engineers will very likely add to republican equality.

While England has for years encouraged the teaching of drawing, and, the year before last, made it a part of the education of all boys in elementary schools, in the United States a sense of its importance has been only slowly making its way. Recently, however, the Senate requested all information on the subject of industrial and high art education in the United States to be laid before it by the Education Bureau. This work was committed to Mr. J. Edwards Clarke, already the author of a Circular on the subject published in 1874, which excited so much interest and drew so much further information that it is reproduced at p. 487 of this volume, having now, the author claims, some little historical interest, the meagre list which it contains of art institutions in the country at that date contrasting with the changes already brought about. The Bureau had already decided to prepare a much more comprehensive work, which should combine a history of the earliest efforts of writers of all views in all parts of the United States and in England; an account of their failures and successes, and especially of the Massachusetts success; with information as to planning schools of high art and public art-museums; lists of art-publications and materials; extracts from foreign official reports as well as from other foreign material. This, even before the Senate's Commission enlarged its scope, was sufficient to make a tolerably voluminous work. But a source of disorder and much repetition has been a series of delays in its publication. It was complete for publication in 1877, and while in one article of that date criticising the few artistic buildings which New York could show in 1875, it rejoices in a later one at the improvement there in 1883, and the artistic taste displayed by its architects; it was ready again in 1880; corrected again for 1882, and statistical tables down to 1881-82 printed, which again it is promised shall be supplemented by tables reaching down to June 30, 1885, at the end of the fourth volume to which this work is to reach. It was printed in 1885, and inserts publications of that year, yet quotes from an "unpublished" report of the National Educational Association held in 1884; and it is still only promised to the public at this year's end. Since this one volume extends to 1100 pages of, for the most part, small-printed matter, the whole work may be looked upon as an encyclopædia of information bearing upon the drawing question, of value chiefly to two classes of men, viz. school teachers, who will find nothing wanting, and earnest advancers of art education. For unless the general public in America be far different from our own they will not be led into the study of the subject by such a publication as this, and in its present form it must quite fail of the general effect upon them aspired to on p. xxx. The fourteen papers by the compiler with which the work opens would be appropriate for rousing attention if dispersed over the country in the most handy form; in their present position their inflated and impetuous style is inconsistent with the idea of exactness to be expected in this class of publication.

As late as 1876 the introduction of drawing into the

public schools was looked upon as a novel project in the United States; for while Mr. Clarke considers that England has spent "an enormous aggregate of money in the work" the Americans, so profuse in other educational expenditure, have been strangely apathetic in the matter. One explanation given is that during the Middle Ages the Church and the aristocracy were the great patrons of high art, and this bred an instinctive dislike to its pursuit in the minds of New England emigrants. But besides the delineation of Nature and of all her forms of beauty, the minister of cultivated wealth and luxury, there is another branch of drawing of the highest importance to nearly every mechanic in these days, viz. geometrical drawing, the foundation of all industrial art, leading up to the elaborate perspective of a complicated machine. Both branches are of course required in many manufactures. Which shall be pursued with most energy in any town must depend upon its staple trades; in some few businesses, as in watches and woven fabrics, the mechanical and the ornamental have about equal claims. The same idea, that drawing meant ornamental art alone, and that its chief results would be the sort of things that accomplished young ladies bring home after a few terms of learning drawing, established itself in the minds of the ratepayers. To meet this the general tone of quotations through this report is that "industrial drawing is of the most practical nature, and has nothing to do with pictures of old ruins, landscapes, &c." Yet elsewhere Mr. Clarke is most contemptuous towards any who wish to confine the drawing taught in any school to "that part of it directly related to industrial interests"; and the teaching of the self-willed Haydon, of whom he gives a long account as the victim of cruel and ignorant persecution of "aristocratic connoisseurs" but as an apostle of art to the common people, is just as confidently quoted with no qualification. Haydon's teaching is that the study of the nude human figure is the best qualification of an artist for any manufacturing business, and every one holding a different opinion is dismissed by Mr. Clarke with contempt. This necessity for high art teaching is a hard doctrine, and certainly discouraging to those who hope to qualify a majority of the working classes for artistic producers or intelligent machinists. Perhaps it only resolves itself into the explanation given on p. 482 by Mr. Sparkes, and supported also by the quotation from Mr. William Morris, that the greater includes the less, and that if an artist is well able to delineate the "subtle lines" of the human figure in a complex attitude, he is not likely to fail in working up a lily or a rose; and this is only in accordance with Mr. Stetson's teaching quoted on p. 649. Still a superiority of French over German art designs is attributed to the former making the human figure their first study and then proceeding to flowers and ornament, while the latter take what seems to us the more natural course of the reverse order.

In 1870 the State of Massachusetts after inviting various experts to express their opinions (here reported) decided that drawing should be taught in all its schools. The larger part of this bulky volume is directly or indirectly the history of the call of Mr. Walter Smith, head master of the School of Art at Leeds, who was recommended by Sir Henry Cole to be intrusted with the management of the whole matter. There are 120 closely-printed pages

devoted to his work in Massachusetts as Art Director from 1871. Every part of the subject was under his guidance, and to impress upon the reader the amount of work entailed upon him an additional chapter is added to describe the unsatisfactory state of things in Boston before his arrival. The whole of his first report for 1871 is given, and long extracts from each yearly report on normal schools and every other department afterwards. Plans of instruction for evening classes which he superintended, as well as of teaching in school hours, are quoted in full. To advance his subject he took to the principal towns in the State a travelling museum of models and examples for study, many supplied from South Kensington. In one appendix are given copious extracts from an address delivered by him to the Pennsylvania Legislature in 1877 on behalf of the Museum and School of Industrial Art of that State; in another practical papers on drawing, chiefly by him, of value of course to managers who have just succeeded in introducing the teaching of drawing; three lectures delivered respectively to the teachers of the three grades of elementary, grammar, and high schools; followed by extracts from similar addresses delivered, after his connection with Massachusetts had ceased, at Montreal and Quebec.

The chief difficulty of course in setting such a work going was the scarcity of teachers, and this remained a difficulty up to the last. A paper accordingly by General Francis A. Walker, describing drawing as the foundation of all technical education, urges that the normal school should in truth precede, not follow, the elementary school. Another difficulty which an Association of Teachers found and which showed the state of things at that time, was that there was so great a scarcity of art-books in the country that the Association set itself to encourage the reprinting, translation, and publication of such books.

On the whole, the energy inspired and the method introduced were so successful in Massachusetts that we are told that its history will form a lasting monument alike to the genius of Walter Smith and to the far-reaching foresight of the school authorities and State Legislature in 1872-73.

Appendix D is an account of the differences which arose between the Committee of Education in Massachusetts and Prof. W. Smith. The latter has now returned to England and taken the head mastership of the Art Department of the Technical College at Bradford. Great regrets are expressed at the, to them, untimely event of his resignation, and it is lamented that he should return from leading the industrial education of a continent to an English provincial college! The work now (1883) is reported as in too few hands, though still progressing from the impetus it had received.

No other States have gone into art education with the energy which Massachusetts displayed in 1872. Two others only, New York and Maine, have required that it should be taught in all schools. In the latter it is urged as the more important, because every natural feature of the country points it out as the seat of manufactures and not of agriculture. But neither Maine nor New York has provided a normal school for the training of teachers. In various other States, however, individual cities have adopted drawing and made it a regular part of the course

Syracuse, in the State of New York, can boast a priority in this good work even over Boston.

Though speaking everywhere most bitterly of England, —an Americanism so out of date now that happily it is more comical than irritating, especially when he goes so far as to call the great works on political economy which have made their way over the whole civilised world “emissaries of English policy which she has succeeded in introducing,”—the writer everywhere holds up England as an example in art education. The whole of the work is credited to Sir Henry Cole and South Kensington, although there were twenty Government-supported Schools of Design in England in 1847. Still the writer cannot resist the sneer that there would have been no art-teaching in England if a Royal Prince had not urged it! But many times over he relates how visitors were struck with the clumsy inartistic style of all English art-work at the Exhibition of 1851 compared with that of many foreign nations, and the good result of an energetic and most successful effort by the nation to remedy it is constantly urged as appearing at the Philadelphia Exposition of 1876. There the Americans found themselves as far behind England as England had been behind other European countries in 1851, through the inartistic ignorance of their manufacturing classes. Many practical lessons and suggestions were there supplied to them, and much of this volume is a record of their influence. Appendix E gives a lengthy paper by Mr. Stetson reviewing the work exhibited there by all the various foreign nations and by each of the American towns, and it records the influence of this Exhibition upon industrial art. We should like to have heard something, however, of the result of the New Orleans Exhibition, no report of which has reached us, although so much was promised.

While anxious by making drawing general to “utilise all the pleasure which a slate and pencil give a child,” Mr. Clarke’s unqualified love of liberty makes him object to infringing on even a child’s freedom, and actually trusts to the extra interest that many gutter children would take in gaining technical skill to render compulsion unnecessary. He urges with good reason that nowhere would artistic skill be so well rewarded as in the United States during its present rapid rise in wealth as well as in population, and that skilled art labour is far more valuable than the labour bestowed upon plainer, rougher work. He does not however, in his promises held forth to all alike who learn to draw, appear to realise the division of labour between the designer and the numerous mechanics who carry out the artist’s ideas on the machine, but seems to look upon all artistic work as carried out single-handed from the design to the article ready for sale. No doubt it is here, as General Walker (already quoted) remarks, that there are boys that have genius in their eyes and fingers instead of a memory and quickness at book-training, who would profit by artistic training. Many such specially gifted artists have already made their mark in America both in architecture and in engraving; the standard of magazine illustrations having been raised even in England by competition with American productions. A larger class whose labour art-education makes valuable are women who are anxious to secure to themselves an independence. They are the principal teachers of drawing in all its branches, and find an excellent outlet

for talent. Many artistic trades are also now carried on successfully by them; an account is especially given in Appendix E of the wood-carving taught at a women’s school in Cincinnati introduced there by an English workman of the name of Fry. Ladies there, among others, make it a pursuit with great success.

Besides other papers incidentally referred to in our above remarks, various writings of considerable length and of dates from 1845 to 1884 are given in Appendixes A, C, and E, all urging the importance of art education, and instructing those engaged in teaching it.

Appendix F consists of 70 closely-printed pages giving an account of South Kensington, its officials, history, Art Training School, Museum, Art Library, art examples, books, and casts; with the reports for 1882 and 1884, and copious extracts from the Art Directory to show in detail the conditions and regulations under which “aid” is granted in England. Some of the quotations in this appendix are taken from the Directory of 1885. Mr. Clarke assures his countrymen that “in its appointments, and influence on art industrial education, South Kensington Museum stands without a rival. It is a wonderful centre of educational energy.” “Other countries, even France, are giving it their official indorsement by modifying their art industrial instruction as rapidly as may be, and bringing it more into harmony with that of the English.”

The final Appendix, H, claims to be a fitting end to this volume, and a foreshadowing of the contents of the future volumes. It is Lord Reay’s address to the International Educational Conference at the Health Exhibition in 1884.

The printing of this volume is far from so correct as might be expected in a Government publication on Education.

W. ODELL

OUR BOOK SHELF

American Journal of Mathematics. Vol. IX. No. 1. (Baltimore, October 1886.)

WE are glad to note that the successive parts now appear with praiseworthy regularity, and the arrival of our number can be predicted to a very close order of approximation. The volume opens with a continuation of Prof. Sylvester’s lectures at Oxford on “The Theory of Reciprocants.” The story is resumed with the eleventh and proceeds to the close of the sixteenth lecture. For the cumbrous terminology “projective reciprocants” or “differential invariants” the lecturer now suggests “pricipiants.” From Lecture xiv. the abstract is devoted to the theory of pure and projective reciprocants, or rather principiants, and here we are introduced to the existence and properties of the protomorphs of invariants and reciprocants with which Mr. L. J. Rogers, one of the lecturer’s audience, has made us elsewhere familiar. For an account of Dr. Story’s new method in analytic geometry, we refer our readers to the author’s own description. Dr. F. N. Cole gives a full review in Klein’s *Ikosaeder of what that eminent mathematician has done in his “Vorlesungen über das Ikosaeder und die Auflösung der Gleichungen vom fünften Grade”* (1884), and in his “*Vergleichende Betrachtungen über neuere geometrische Forschungen*” (1872). In Prof. Greenhill’s paper on wave-motion in hydrodynamics the writer states that “one of the most important applications of the theory of hydrodynamics is to the question of the motion of waves under gravity and other causes,” and his object is “to collect together the chief results hitherto obtained, and to give also a general connected account of the mathematical theory, at the same time attempting to develop it in some directions.”

LETTERS TO THE EDITOR

[The Editor does not hold himself responsible for opinions expressed by his correspondents. Neither can he undertake to return, or to correspond with the writers of, rejected manuscripts. No notice is taken of anonymous communications.]

[The Editor urgently requests correspondents to keep their letters as short as possible. The pressure on his space is so great that it is impossible otherwise to insure the appearance even of communications containing interesting and novel facts.]

Longitudes in Brazil

LE numéro du 18 novembre de NATURE publie un article du professeur Young sur les progrès de l'astronomie depuis dix ans, dans lequel il est dit que les observations de longitude télégraphiques des officiers américains ont corrigé une erreur de 8'54s. sur Lisbonne, et une bien plus étonnante encore de 35s. sur Rio.

Il y a là une grosse erreur inexplicable de la part du professeur Young, contre laquelle je dois protester comme auteur des cartes hydrographiques du Brésil encore employés aujourd'hui, et auteur de toutes les déterminations géographiques relatives et absolues faites douze ou quinze ans avant la mission américaine de MM. Green et Davis pour les longitudes télégraphiques entre le Brésil et l'Europe.

Sur les mille lieues de côte du Brésil la mission américaine a déterminé six longitudes entre le Para et Buenos Ayres. Voici la comparaison des résultats obtenus par MM. Davis et Green, à l'aide du télégraphe, et par moi, à l'aide de chronomètres et d'observations astronomiques directes. Les observations américaines sont publiées dans le numéro 59 (1880, je crois) "Hydrographic Notice," et les miennes dans les "Annales hydrographiques, 1866."

	Para		Pernambouco		Bahia	
	h.	m. s.	h.	m. s.	h.	m. s.
Long. télégraphique.	3	23 20'94	2	24 48'6	2	43 29'6
Long. Mouchez ...	3	23 18'67	2	28 47'5	2	43 26'9
Erreur ...		- 2'27s.		- 1'1s.		- 2'7s.

	Rio		Montevideo		Buenos Ayres	
	h.	m. s.	h.	m. s.	h.	m. s.
Long. télégraphique.	3	2 2'3	3	54 9'9	4	2 49'9
Long. Mouchez ...	3	2 0'1	3	54 9'4	4	2 49'9
Erreur ...		- 2'2s.		- 0'5s.		0'0s.

Il résulte de ce tableau que la plus grande erreur que j'ai commise est - 2'7s. sur Bahia. A Rio l'erreur est de - 2'2s., et non de 35s. comme le prétend M. Young. Dans le Rio de la Plata l'erreur a été trouvée nulle.

Je ne crois pas qu'aucune étendue de côte de mille lieues eût jamais présenté moins d'erreur absolue ou relative que la côte du Brésil après la publication de mes cartes et de mes observations.

Quant à l'erreur sur Lisbonne je l'avais signalée depuis plus de trente ans, elle était connue.

Je vous serais très obligé de vouloir bien publier au moins le tableau comparatif des longitudes que j'ai l'honneur de vous envoyer aujourd'hui, pour protester contre l'erreur qui m'est indirectement imputée.

Veillez agréer l'assurance de ma parfaite considération.

E. MOUCHEZ

Cooke's "Chemical Physics"

I AM told that I have been the object of severe strictures in your journal for republishing my old "Chemical Physics" as if it were a new book. It is a sufficient answer to say that the book was stereotyped when first issued in 1860, and that there has never been any pretence on my part that it has been revised since. I find, on inquiry, that the American publishers have made, since the first edition, three reprints from the plates, and have called these reprints second, third, and fourth editions, changing, with each issue, the date on the title-page; a usage which I regard myself as reprehensible, but which must be sanctioned by the trade since it is so universally followed. All this time, however, the date accompanying my signature after the preface, and the date of the copyright, have remained unaltered. I had supposed the book entirely out of print; and the last reprint of a very few copies to meet a small demand still existing, chiefly in England, was made entirely without my knowledge or consent. On its very face the whole aspect of the

book is antiquated; but in it there was brought together certain positive knowledge in connection with the weighing and measuring of aeriform matter, derived chiefly from the classical research of Regnault, which is still of great importance and not readily found elsewhere; and this is, unquestionably, the reason of its continued demand for a compilation made more than twenty-five years ago. I have, until within a few years, had the expectation of revising the book and presenting the old facts in the new dress, but the failure of my sight has obliged me to give up the plan, and younger men must do the work.

JOSIAH PARSONS COOKE

Cambridge, U.S.A., November 16

Note on Mr. Budden's Proof that only One Parallel can be drawn from a Given Point to a Given Straight Line

MR. BUDDEN's paper in the last number of NATURE (p. 9) is full of inaccuracies of a more or less serious character. With out pointing out these, I wish to show that the essential idea which underlies his reasoning is altogether wrong, as it is based on the "infinite," which he introduces in the most innocent manner by letting his figure grow without limit, and about which he then calmly reasons as if he still dealt with a finite figure. If we let a quantity "increase without limit," we get a quantity which has increased beyond our comprehension, and no one's senses will wittingly and seriously draw conclusions from what he does not comprehend. Here we might stop, were not that the constant use in modern mathematics of the infinite (both the small and the great) has made us so familiar with that an attempt to base an elementary proof on it might seem to many a very natural thing.

In algebra, the infinite number is shown to have one property which we can comprehend, viz. that its reciprocal is zero; and with this property alone we work safely.

In modern geometry, on the other hand, the infinite is used as a kind of shorthand, which enables us to make long statements short, and, at the same time, general. Taking the axiom about parallels for granted, it is shown that all points at an infinite distance in a line may be taken to be one point as far as constructions at a finite distance are concerned. For all lines joining a fixed point, P, to any point at infinity in a line may be taken as parallel to this line, and therefore as coincident. I express this more shortly, it is said that the whole indefinite an infinite part of a line which is out of the reach of our comprehension plays for us only the part of a single point, and accordingly it is called a "point," viz. the point at infinity of the line. Similarly it is shown that all points in a plane which are at an infinite distance may be considered as lying in one line, which is then spoken of as the line at infinity in the plane, and which is freely and safely used in deducing theorems and solving problems.

If, then, a line in a plane be moved to infinity, making always a given angle with a fixed line, it will ultimately become coincident with—which here means indistinguishable from—the line at infinity. The latter then makes with the fixed line a given angle. But this angle may be anything. Hence the "line at infinity" makes any angle we like with any given finite line in other words, it makes no definite angle at all with it.

It follows, if we take a property of a figure which depends upon the magnitude of an angle, that this property will not necessarily any longer hold if one of the limits of the angle be moved to an infinite distance; for then this angle has not any longer definite magnitude. To base any reasoning on that property after the figure has been indefinitely increased must therefore necessarily be fallacious. But this is exactly what Mr. Budden does. His proof is based on the implied assumption that if a figure in a plane be increased indefinitely, we can still reason upon it as if it were finite. He may take this as an axiom, but then he has replaced Euclid's axiom by another, and has not proved it; and the question would arise, Which form of the axiom is preferable? I prefer Euclid's.

O. HENRICI

Lunar Glaciation

I TRUST you will allow me a small space to explain regarding this theory of lunar glaciation, referred to by Mr. Darwin NATURE (vol. xxxiv. p. 264).

First, I must thank him for the remarks made, and say that certainly was not aware that Capt. Ericsson had been at work in the same direction some ten years or more before me.

I laid the theory before the late Prebendary Webb a few years ago, and some selections from it were published in the *Journal of the Liverpool Astronomical Society*, and, being necessarily incomplete, the extracts were not very intelligible. I have never attempted the settlement of the lunar surface temperature, which is quite beyond me, leaving the same in the hands of Prof. Langley, and have confined myself to the solution of the peculiar and unearthly surfacing we see. This I find best explained by glaciation, under conditions of intense cold, say -60° or 80° C., and absence of all gaseous atmosphere.

I quite indorse Capt. Ericsson's conclusions as to the extreme unlikelihood of such a small globe being finally surfaced by igneous agencies, after it had seas of water, atmosphere, and probably polar caps.

Neison, in his "Moon," page 41, line 7, distinctly implies that this took place, *i.e.* "that this high temperature could only arise after the practical disappearance of bodies of water from the lunar surface," the rise in lunar temperature being due to solar heat.

I cannot follow Neison in this, and, on the contrary, believe that the temperature has steadily, if slowly, declined, from a period when there was erosion, with air and water. Polar caps then formed, as on our earth and Mars, and extended as the temperature fell, until at last the entire globe was cased in ice, the last portions to glaciare being what we call the equatorial seas.

Like Capt. Ericsson, I look on the craters and walled plains as having been lagoons of water, left here and there as glaciation extended, at places of greater depth, or more likely as submarine volcanic vents, for we see their sites as craterlets and cones after final glaciation.

The aqueous vapour given off from these lagoons would form a local dome-shaped atmosphere that would retard explosive ebullition, and on its reaching the outer limit of critical temperature, would condense and fall as snow; what fell beyond the lagoon margin would pile to form the ring, and the lagoon surface or flow be gradually lowered by its removal.

But I cannot follow Capt. Ericsson in supposing that the water had a centrifugal motion, and acted as a gigantic carving-tool, that sculptured the enormous terraces in Tycho, Theophilus, &c. On the contrary, I look on it as a quiet process, and that all the circular forms, from small craterlets to even such forms as Mare Crisium or Imbrium, with its huge maritime ranges, are due to one cause. The series is complete.

I quite agree with Mr. Darwin that a layer of water vapour would exist (and be visible) over the ice on the moon if only the temperature be high enough; but, at very low temperatures, ice practically does not vaporise even *in vacuo* (see Ganot's "Physics"). Aqueous vapour not being seen, I conclude the temperature is below (say) -80° C. But the most potent argument in favour of my theory is that it reasonably and consistently explains *all* the peculiar features of lunar surfacing, *i.e.* :—

- The absence of distinct Polar caps;
 - The absence of water and aqueous vapour (now);
 - The absence of distinct colour in details;
 - The brightness of all raised, rugged surfaces, mountains, cliffs, peaks;
 - The relative darkness of levels whereon meteoric dust can lie;
 - The extraordinary circularity of forms, large and small, incomplete, or overlapped;
 - The cones, whether central or isolated;
 - The clefts or rills, also strings of craterlets;
 - The maritime zones, ridges, and banks;
 - The haze or cloud, and nimbus or rayed brightness;
 - The dark points seen by Dr. Klein;
 - Lastly, if not least, the long bright rays.
- I do not think I overstate the case when I say that selenographers will find these features consistently solved by the one hypothesis, and no enigmas left.

I cannot ask for space to go into details here, but will forward a short synopsis of the leading features, in case they may be required, arranging them as nearly as may be as in the preceding list.

S. E. PEAL

Sibsagar, Assam, October 13

The Astronomical Theory of the Great Ice Age

THE lecture and the letter of Sir Robert Ball, however lucid, do not appear to carry this question further than where Dr. Croall left it. It is easy to understand that when the shape of the

earth's orbit was different, winter days might be colder and summer days hotter than now. What the theory at present wants is an exposition of the successive series of effects by which this state of climates would transform the Emerald Isle into a mere Greenland. It is scarcely an explanation to say that "vast fluctuations like these must correspond to vast climatic changes of the kind postulated." We desire to be shown that they will correspond, and that the correspondence will be of the kind required. Taking Sir Robert Ball's own illustration, I am quite ready to admit that his horse alternately starved and crammed will not run a dead heat with one uniformly fed; but in default of experience I should not feel certain that his animal would die of accumulated fat.

We know that there have been past periods of heat-supply more uniform than at present, and periods of wider fluctuation. We see also in geological records ages of vast snow accumulation and ages of rich vegetation near the Pole. We need a demonstration that such wider fluctuations do tend to the one and not to the other; towards snow-accumulation and not towards snow-dissipation. Attempts in this direction have been made, but much seems needed yet.

E. HILL

St. John's College, Cambridge, November 23

Meteor

THE large meteor described in NATURE by Mr. P. L. Sclater, was observed here as follows:—

Nov. 17, 7h. 18m.—Fireball many times brighter than Venus. Path from $32\frac{1}{2}^{\circ} + 45^{\circ}$ to $158^{\circ} + 55^{\circ}$. Motion very slow, duration 7 seconds. Train, but no enduring streak. The fireball, as it gradually descended to the northern horizon, varied greatly in brilliancy, and gave a series of flashes lighting up the sky with great effect. I have occasionally seen larger fireballs, but never observed one more satisfactorily. This meteor was observed at Handsworth, Birmingham; at Crawshaw Booth, Lancashire; and at many other parts of the country. Its unusual brightness seems to have attracted wide notice.

Fireballs from Taurus are often seen at about this epoch; but that of November 17 appears to have belonged to a radiant-point in Arias.

W. F. DENNING

Bristol

Freshwater Diatoms in the Bagshot Beds

WILL you kindly favour me with space to ask any of your numerous readers, who may be specially interested, if they can furnish me with any references to published records of freshwater Diatoms being observed in the carbonaceous earthy sands of the Middle and Lower Bagshot Beds of the London Basin? In conjunction with one of my pupils, I have lately subjected many of these green and dark-grey sands and earths to microscopic examination; and our labours have been rewarded by the discovery of a rather extensive unicellular flora, particulars of which will be shortly laid before the Geological Society. Meanwhile, I shall be happy to have the co-operation of other workers in the same field.

A. IRVING

Wellington College, Berks, November 28

THE MATHEMATICAL TRIPOS¹

I.

IT is with the greatest pleasure that I avail myself this evening of the already well-established custom which permits one of our members, once in two years, to address to his colleagues a few general remarks connected with the science that forms our common bond of union. It is not often that a mathematician has an opportunity of laying before his fellow workers, by word of mouth, any views of his except such as relate to the actual mathematical investigations upon which he is engaged, which, from their very nature, can appeal directly only to the few who have laboured in the same field; and I feel it to be a high privilege to be permitted, in this room, and surrounded by familiar faces, to give expression to my thoughts and hopes upon subjects that are of common interest to us all as mathematicians.

¹ Address delivered before the London Mathematical Society by the President, Mr. J. W. L. Glaisher, M.A., F.R.S., on vacating the chair November 11, 1886.

I have not ventured to attempt any remarks upon the wide region of pure mathematics, or even upon the progress of such portions of it as have attracted the greatest share of interest among ourselves. I have felt that, as one who has resided and lectured in Cambridge for the past fifteen years, the most appropriate subjects for my address would be those upon which my residence in the University during an eventful period, or my experience as a lecturer, might to some extent qualify me to speak. Still, even when so restricted, I have found it no easy matter to decide upon the subjects to which I was most desirous of drawing your attention to-night.

I should like to have spoken at length upon the theory of elliptic functions. For fourteen years I have lectured regularly, each year, upon this subject, and no lectures of mine have been of so much interest to me. I believe that the time is rapidly approaching when the elementary portions of the theory will be regarded as necessarily forming part of the common course of reading of all students of mathematics, so that a familiarity with sn's, cn's, dn's, and their properties will become as essential as the differential calculus to the mathematical equipment of every person who has made mathematics one of his subjects of study.

Quite apart from its far-reaching influence in all branches of pure mathematics and its widespread applications in mathematical physics, there are special reasons which make the theory of elliptic functions a subject of peculiar interest in a course of mathematical studies, and one to which it is important that the student should be introduced as early as possible in his career, whether he be reading mathematics for its own sake, or for the sake of its applications, or for its advantages as a mental training. It is the first mathematical "theory" that he meets with in his reading—meaning by a "theory" a body of theorems and properties of functions so related to each other that the student cannot fail to see from the equations themselves that they form a consistent and remarkable system of facts, worthy of study on their own account, irrespective of any applications of which they may be susceptible. It is true that trigonometry, if regarded as the theory of singly periodic functions, is a theory in this sense, but it is reached by the student at too early a stage for him to be enabled to appreciate the nature and importance of facts that are expressed in the mathematical language of formulæ, and even if it were not so, the manner in which the subject is treated in text-books (the functions being derived from the circle and applied to the solution of triangles, &c., before they are considered analytically) makes it difficult to separate the mathematical theory from its various applications. In analytical geometry, which the student next meets with in his reading, a method of representing curves by equations is explained, and applied to the investigation and proof of properties of conics. In his next subject, differential calculus, he is introduced to new conceptions and processes of the very highest importance and the most fundamental character, and is taught to apply them to the investigation of maxima and minima, tangents and asymptotes to curves, envelopes, &c. Then come the elements of the integral calculus and of differential equations: the former consisting of a few chapters giving methods of integrating various classes of functions, followed by applications to curves and surfaces; and the latter of rules and methods for treating such equations as admit of finite solution.

Not one of these subjects, in the form in which they are necessarily presented to students, is an end in itself or exists for itself: they consist of ideas, methods, processes, and rules, which the student is taught to apply and to understand; they contain the conceptions with which he has to make himself as familiar as with the commonest facts of life, the tools which he is to have ever ready to his hand for use. And in the course of acquiring this knowledge he is made acquainted with numerous connected series of

propositions—such as the properties of conics—besides various important results of more purely analytical interest. But all of these developments are presented to him in a form which throws no light upon the manner in which they were originally discovered, and, though the propositions are made to follow one another in clear logical order, the student cannot but be sensible that he is travelling, not along a natural highway, but upon a well-worn road, artificially constructed for his convenience. It is not till he reaches the subject of elliptic functions that he has the opportunity of seeing how, by means of the principles and processes that he has learned, a theory can be developed in which one result leads on of itself to another, in which every system of formulæ suggests ideas and inquiries about which the mind is eager to satisfy itself, and opens to the view fresh formulæ connected by unsuspected relations with others already obtained, so that he cannot resist the feeling that the subject is taking its own course, and that he is merely a bewildered spectator, delighted with the results which unfold themselves before him. He feels that the formulæ are, as it were, developing the subject of themselves, and that his part is passive: it is for him to follow where the formulæ point the way, and be amazed by the new wonders to which they lead him.

It may be that in using this language I am expressing the feelings of a mathematician, rather than those of a student on reading the elements of the subject for the first time; still I am convinced that the attributes I have just referred to are those which distinguish a genuine mathematical theory from a mere collection of useful principles and facts, and that no one can have studied elliptic functions without realising that mathematics is not only a weapon of research but a real living language—a language that can reveal wonderful and mysterious worlds of truths, of which, without its help, the mind could have gained not the least conception. It seems to me, therefore, of the highest importance that the student should be introduced to a real mathematical theory at the earliest stage at which his knowledge will permit of his deriving from it the peculiar advantages which I have mentioned. Thus only can he obtain expanded views or a true understanding of the science he is studying. Higher algebra and theory of numbers afford other conspicuous examples of the perfection that a pure mathematical theory can exhibit, but they do not lie so directly in the line of a general mathematical course of studies. Regarded from this latter point of view, elliptic functions has the additional merit of being a subject whose importance is recognised, on account of its physical applications, even by those to whom the gift of duly appreciating the wonders of pure mathematics seems to have been partially denied.

I should have liked also to have spoken at some length upon another subject that is constantly in my thoughts. I mean the pressing need of text-books upon the higher branches of mathematics. Of text-books for use in schools we have an abundance, and each month produces a fresh supply; but it is only occasionally that we have to welcome a work intended for the use of the higher University student or the mathematician. Every one of us must sometimes have felt the want of an introductory treatise that would give the reader the fundamental propositions in some branch of mathematics which exist only in memoirs and papers scattered throughout the wilderness of *Journals* and *Transactions* of Societies. We can scarcely expect to have provided for us, in many high subjects, text-books so admirable and thorough as Dr Salmon's; still I cannot refrain from expressing the hope that in the future the number of advanced mathematical treatises may not be so infinitesimal compared with the number of memoirs as at present. I could mention several subjects that are almost at a standstill, because advanced is impracticable for want of avenues by which new worker

can approach them. Of necessity the literature of mathematics must always be in the main a journal literature, for the audience addressed is small; but I cannot help feeling that the disproportion between the amount of exploration effected and the attempts made to render accessible the territories explored and conquered might be greater than it is. No one can realise more vividly than I do how vastly more difficult it is to write a book than a collection of memoirs, and how beset with anxieties, for any one who is at all fastidious, is the task of arranging the fundamental properties of any comparatively new subject in clear and logical form. The sustained struggle to attain clearness, exactitude, and thoroughness in the orderly development of a complicated and mutually-connected system of propositions wears out the worker more than thrice the same amount of labour devoted to new investigations with all the fascinating excitement of successes and failures, rewards and disappointments. In writing a memoir, the mathematician begins where he pleases, and confines himself to what has interested him and what he knows he has done well. In composing a book, the author has not only to marshal into order an array of theorems of various kinds, assigning to each its due place and importance, but he has—hardest task of all, perhaps—to confine his treatise within bounds, to keep it from growing to gigantic proportions as his increased study of the subject opens up to him fresh vistas. On the other hand, however, is to be considered the great service he can thus render to his favourite study: an introductory treatise on a subject not otherwise approachable by any direct route, even if it be not of the highest class, may have done far more for its advance than could have been effected by the most brilliant memoir. Time, care, and thought are essential for the preparation of any valuable treatise, and full references to the original memoirs should be always given; if these conditions have been fulfilled, the writer has deserved well of mathematical science.

I have not been able to forbear from making the few preceding remarks upon two subjects on which I have long felt strongly; but I pass now without further delay to the main subject of my address—the Mathematical Tripos. I have thought that, in view of the importance of this examination to our science, and the frequent changes that have taken place recently, this might be a subject of no ordinary interest to our members as well as to myself. Since 1872 change has succeeded change with great rapidity, and there are probably not many outside the mathematical portion of the resident body at Cambridge who are fully aware of the present mode of conducting the examination or of the further changes already sanctioned by the Senate and which take effect next June. It is, indeed, generally known that the list of wranglers, senior optimes, and junior optimes is published in June, at about the same time as many other Tripos lists, instead of by itself in January, and that the senior wrangler is displaced from his throne, and no longer owes his position to the results of the whole examination, so that he is not necessarily—even from an examination standpoint—the first mathematician of his year. So much only is generally known; and it has seemed to me that it might be of interest, considering the influence for good that it is hoped the examination in its new form will have upon the progress of mathematics, to give some account of the successive developments that have taken place in this time-honoured examination, and the causes and efforts that have led to them. The difficulties connected with the placing of all the mathematical candidates of the year in one order of merit, the extension or limitation of the subjects of examination, and various other questions connected with the Tripos, are matters that have been continually discussed and re-discussed in the light of fresh experience by those concerned with the mathematical course of studies at Cambridge, but I may, nevertheless, perhaps be permitted to-night very briefly to refer to some of the familiar

arguments in the presence of a more extended audience of mathematicians.

It is convenient to preface the principal remarks I have to make by an outline of the history of the Tripos. In doing so, I must pass very lightly over its origin and early development, as anything approaching to a complete history of its origin and rise in the last century would amount almost to a history of the studies of the University.

At the beginning of the last century, besides certain merely formal disputations, the only exercises required from candidates for degrees were the keeping of acts and opponencies. Each candidate for honours in the course of his third year had to maintain publicly a thesis, the subject of which was chosen by himself, against three opponents, in the presence of one of the Moderators, who acted as umpire. The subjects selected were philosophical or mathematical; the discussion took place in Latin and in logical form. After hearing the discussions, the Proctors and Moderators prepared a final list of candidates qualified to receive degrees. This can scarcely be considered to have been an order of merit, for each of the Proctors and Moderators, and also the Vice-Chancellor, had the right to introduce the name of one candidate into the list whenever he pleased; still, except in the case of the recipients of these honorary degrees, it is probable that the list in the main fairly represented the merits of the candidates. It was divided into three classes, consisting of (1) the wranglers and senior optimes; (2) the senior optimes who had done fairly well but had not distinguished themselves; and (3) *οἱ πολλοί*, or the poll-men. The first class received their degrees on Ash Wednesday, taking seniority according to their order on the list, and the two other classes received their degrees later.

With regard to the origin of the Tripos, Mr. W. W. Rouse Ball, in his interesting sketch of its history, writes:—

“The impressions gathered from these disputations in the schools were necessarily rather vague, and when they became the sole University exercise for a degree they hardly afforded a sufficient basis for an accurate arrangement of the men in order of merit. It was, I believe, to correct this fault that the Senate House examination was introduced, and I am inclined to think that it had its origin about the year 1730. At first it probably consisted only of a few *vivâ voce* questions addressed by the Proctors and Moderators in the week after the schools to those candidates about whose abilities and position some doubt was felt; but its advantages were so patent that within ten or twelve years it had become systematised into a regular examination to which all questionists were liable, although technically it was still regarded as only supplementary to the exercises in the schools. From the beginning it was conducted in English, and accurate lists were made of the order of merit of the candidates; two advantages to which, I think, its final and definite establishment must be largely attributed.”

Mr. Ball divides the time during which the exercises in the schools and the Tripos were concurrent into five periods: (1) from 1730 to about 1750, during which time it was probably unauthorised and regarded as an experiment; (2) from 1750 to 1763, during which it was gradually establishing itself,—in the last year of this period it was officially decided that when a candidate's position in the class-list was doubtful the Senate House examination and not the disputation was to be taken as the final test; (3) from 1763 to 1779, during which definite rules were framed and laid down for conducting it; (4) from 1779 to 1827, during which it practically superseded the disputations; (5) from 1827 to 1841, the year in which the disputations were abolished.

The lists published in the Cambridge University Calendars begin with the year 1747, because in that year

* “The Origin and History of the Mathematical Tripos,” Cambridge, 1880. (Reprinted from the *Cambridge Review*.)

the final lists were first printed and distributed, the names of those who had received honorary degrees being specially marked, so that by simply erasing them the true order of merit of the other candidates could be obtained. The division of the first class into wranglers and senior optimes was first made in 1753.

It was in the third of the above periods, that is, between 1763 and 1779, that the Senate House examination was gradually gaining ground upon the schools in determining a candidate's final place on the list. By means of their acts and opponencies the candidates were divided by the Moderators into eight classes, each class being arranged in alphabetical order; their subsequent position in the class was then determined by the Senate House examination. The first two classes comprised those who were expected to be wranglers, the next four included the other candidates for honours, and the last two consisted of poll-men only. The classes were examined separately and *viva voce*. During this period it became the custom to require written answers to the questions. The examiner gave out the questions to the class one by one, giving out a fresh question as soon as he saw that any one had finished the last. The problem papers, which were confined to the first two classes, were given to the candidates in writing, so that they had the whole paper before them at once.

It may be of interest to give a more detailed account of the exercises in the schools during this period, when both the exercises and the examination were in full operation and vigour. The Moderators, having received from the tutors of the Colleges a list of the students who were candidates for honours at the next examination, fixed a day in the Lent term on which each was to keep his act, and assigned to him three opponents. The Respondent, or "Act" as he was then called, selected three subjects which he proposed to maintain, and submitted them to the Moderator, who communicated them to his three opponents, designating them *opponentium primus, secundus, or tertius*. On the day fixed for the Act the respondent read his thesis in the schools in the presence of the Moderator. The first opponent then mounted the box opposite to that of the respondent and below that of the Moderator, and joined issue with him, opposing the thesis by eight arguments of syllogistic form. The respondent replied to each in turn, and when an argument had been disposed of, the Moderator called for the next in the words *Probes aliter*. When the disputation had continued long enough, the Moderator dismissed the opponent with such words as "*Bene disputasti*," or "*Optime disputasti*," or "*Optime quidem disputasti*," as the case might be. The second and third opponents (who had to oppose the thesis by five and three arguments respectively) entered the box successively, and after disputing were dismissed in the same manner, the whole performance lasting between one hour and two hours. The respondent himself was dismissed with some such phrase as "*Satis et optime quidem tuo officio functus es*." Such compliments gave rise to the classification into senior and junior optimes. In general, "*Optime quidem*" was the highest praise expected even by future wranglers. The distinguished men of the year appeared eight times in the schools, twice as Respondents and twice in each grade of opponency.¹

¹ Wordsworth, *Scholæ Academicæ* (1877), p. 37. A specimen of an argument, expressed in scholastic form, on the question, "Recte statuit Palejus de Virtute," is given by Wordsworth on p. 39, and the full system of eight arguments (in a disputation of 1784) on the question, "Solis parallaxis ope Veneris intra solem conspiciendæ a methodo Hallei recte determinari potest," is reproduced in detail by Mr. Ball in the appendix to the sketch already referred to. In the latter part of the last century it seems to have been usual for two of the questions to relate to mathematic, and the third to moral philosophy. Wordsworth mentions that in 1770-11 it needed all the influence of an enthusiastic Proctor and Moderator to induce a student to keep his act in mathematical questions, but that by the middle of the century the examination was so far crystallising into the *Mathematical Tripos* that a questionist was enabled by academical authority in 1750 to resist the demands of a Moderator to produce one metaphysical question, he having already distinguished himself in mathematical argument. In the early Cambridge University Calendar the three questions given as specimens are: (1) "Recte statuit Newtonus in septima sua sectione Libri primi"; (2) "Iridis primariæ et secundariæ Phænomena solvi possunt ex Principiis Opticis"; (3) "Recte statuit Lockius de Qualitatibus Corporum."

The final establishment of the Mathematical Tripos dates, as remarked by Mr. Ball, from 1779. By the regulations agreed to by the Senate in that year, the Moderators of the previous year were added to the regular staff of examiners, and the system of brackets was introduced. The examination lasted three days (the last of which was devoted to moral philosophy), and on the fourth day a class-list, called "the Brackets," was issued, in which those candidates who were nearly equal were bracketed together. One day was devoted to the "examination of the brackets," by the result of which the names in each bracket were placed in order of merit. There was also a power of challenging, by which a candidate who was dissatisfied with his bracket might challenge any other candidate he pleased to a fresh examination;¹ but it seldom happened that any one rose above or fell below his bracket. From 1779 onwards the examination slowly and surely grew in importance, and the exercises became of less account each year, till they were finally discontinued by the Moderators in 1839. Two years later they were formally abolished by the Senate.

The following account of the Senate House examination in 1802 is abridged from the Cambridge University Calendar of that year:—"On the Monday morning, a little before eight o'clock, the students, generally about a hundred, enter the Senate House, preceded by a Master of Arts, who on this occasion is styled the father of the College to which he belongs. On two pillars at the entrance of the Senate House are hung the Classes [*i.e.* the eight classes into which the candidates have been divided by the exercises in the schools; and a paper denoting the hours of examination of those who are thought most competent to contend for Honours.

"Immediately after the University clock has struck eight, the names are called over, and the absentees being marked, are subject to certain fines. The classes to be examined are called out, and proceed to their appointed tables, where they find pens, ink, and paper provided in great abundance. In this manner, with the utmost order and regularity, two-thirds of the young men are set to work within less than five minutes after the clock has struck eight. There are three chief tables, at which six examiners preside. At the first, the senior Moderator of the present year and the junior Moderator of the preceding year. At the second, the junior Moderator of the present and the senior Moderator of the preceding year. At the third, two Moderators of the year previous to the two last, or two examiners appointed by the Senate. The two first tables are chiefly allotted to the six first classes; the third or largest to the *ol πολλοί*." After describing the manner of reading out the questions, the account proceeds:—"The examiners are not seated, but keep moving round the tables, both to judge how matters proceed and to deliver their questions at proper intervals. The examination, which embraces arithmetic, algebra, fluxions, the doctrine of infinitesimals and increments, geometry, trigonometry, mechanics, hydrostatics, optics, and astronomy, in all their various gradations, is varied according to circumstances: no one can anticipate a question, for in the course of five minutes he may be dragged from Euclid to Newton, from the humble arithmetic of Bonycastle to the abstruse analytics of Waring. While this examination is proceeding at the three tables between the hours of eight and nine, printed problems are delivered to each person of the first and second classes; these he takes with him to any window he pleases, where there are pens, ink, and paper prepared for his operations." At nine o'clock the papers had to be given up, and half an hour was allowed for breakfast. At 9.30 all returned and were examined in the same way till eleven, when the Senate House was again cleared. An interval of two hours then took place. At

¹ In such cases the Moderators called to their assistance the Proctors or other Masters of Arts. About 1770 any Master of Arts was at liberty to examine any of the candidates. Mr. Ball is of opinion that this right was not insisted on after 1785.

one o'clock all returned again and were examined. At three o'clock the Senate House was again cleared for half an hour, and on the return of the candidates the examination was continued till five o'clock. This ended the Senate House examination for the day, but at seven in the evening the first four classes went to the senior Moderator's rooms to solve problems. They were finally dismissed for the day at nine, after eight hours of examination.¹ The work on the next day (Tuesday) was similar to that of the Monday; Wednesday was devoted to logic, moral philosophy, &c. "On Thursday the examinations are resumed, and continued nearly as usual, as on the Monday and Tuesday. At eight o'clock the new classifications, or brackets, which are arranged according to the order of merit, each containing the names of the candidates placed alphabetically, are hung upon the pillars." Fresh editions and revisions of the brackets were published at 9 and 11 a.m. and at 3 and 5 p.m., according to the course of the examination, liberty being given to any man to challenge the bracket immediately above his own. At five the whole examination ended. The Proctors, Moderators, and examiners then retired to a room under the public library to prepare the list of Honours, which was sometimes settled without much difficulty in a few hours, but sometimes not before two or three the next morning. The name of the senior wrangler was generally published at midnight. In 1802 there were eighty-six candidates for honours, and they were divided into fifteen brackets, the first and second brackets containing each one name only, and the third bracket four names.

The examination seems to have been a time of great excitement, and the list was most anxiously awaited. This was the case also before 1779, as appears from the account of the contest between Paley and Frere for the senior wranglership in 1763 and Jebb's account of the examination in 1772.²

Various changes took place in the examination in 1808, 1828, 1833, and 1839. In 1808 another day was added: three days were devoted to mathematics, exclusive of the day of examination of the brackets. Each candidate was employed eighteen hours in the course of the three days, of which eleven were devoted to book-work and the remaining seven to problems. By regulations which were confirmed by the Senate on November 13, 1827, and came into operation in January 1828, another day was added, so that the examination extended over four days, exclusive of the day of examining the brackets; the number of hours of examination was twenty-three, the time assigned to problems being the same as in 1808. On the first two days all the candidates had the same questions proposed to them, inclusive of the evening problems, and the examination on those days excluded the higher and more difficult parts of mathematics, in order, in the words of the report, "that the candidates for Honours may not be induced to pursue the more abstruse and profound mathematics to the neglect of more elementary knowledge." Accordingly, only such questions as could be solved without the aid of the differential calculus were set on the first day, and those set on the second day involved only its elementary applications. The classes were reduced to four, determined as before by the exercises in the schools. The regulations of 1827 are specially important, because they first prescribed that all the papers should be printed.³ They are also noticeable as being the

last which gave the examiners power to ask *viva voce* questions; after recommending that there be not contained in any paper more questions than well-prepared students have been generally found able to answer within the time allowed for the paper, the Report proceeds: "But if any candidate shall, before the end of the time, have answered all the questions in the paper, the examiners may at their discretion propose additional questions *viva voce*."

New regulations were confirmed by the Senate on April 6, 1832, and took effect in 1833. The commencement of the examination was placed a day earlier, the duration was five days, and the hours of examination on each day were five and a half. Thus four and a half hours were added to the whole time of examination, four of which were assigned to book-work and the remaining half-hour to problems. The examination on the first day was confined to subjects that did not require the differential calculus, and on the second and third days only the simple applications of the calculus were included. During the first four days of the examination the papers were set to all the candidates alike, but on the fifth day the examination was conducted according to classes. No reference is made to *viva voce* questions, and the examination of the brackets only survives in the permissive form: "That the result of the examination be published in the Senate House on the morning of the Friday succeeding the first Monday in Lent term, at nine o'clock; but if it should happen that the relative merits of any of the candidates are not then determined to the satisfaction of the Moderators and Examiners, that such candidates be re-examined on that day."

Only six years later these regulations were superseded by a new system, which passed the Senate on June 2, 1838, and came into operation in January 1839. By these new regulations another day was added to the examination, which thus lasted six days. The total number of hours of examination was thirty-three, of which eight and a half were given to problems. Throughout the whole examination the same papers were set to all the candidates. The regulations contain no mention of classes, and accordingly the exercises in the schools were discontinued by the Moderators. The permissive rule relating to the re-examination of the candidates (the survival from the brackets) was retained in these regulations in the same form as in those of 1832.

It is very interesting to notice, in the successive regulations, how the *viva voce* examination gradually merged into an examination by printed papers, and how, as the examination became more elaborate and exacting, it rendered unnecessary, not only the preliminary exercises in the schools, but also the final examination of the brackets.

Besides the development of the Senate House examination itself, other changes had taken place in the University system during this period of renewed activity. In 1824 the first Classical Tripos examination took place; only those who had already passed the mathematical examination being admissible as candidates. The name "Mathematical Tripos"¹ dates from after this year.

An opportunity will also be afforded of ascertaining by an inspection of these papers that the examination embraces a due proportion of each of the ordinary subjects of mathematical study.

¹ As, however, in proposing this alteration, the intention of the Syndicate is to avoid making any change in the substance of the examination, it is recommended that the examiners be strictly enjoined to insert in these papers such questions only as are at present proposed *viva voce*; namely, propositions contained in the mathematical works commonly in use in the University, or simple examples and explanations of such propositions.

² There are few matters in the history of the University more curious and interesting than the manner in which the word *Tripos* came to be applied to the Senate House examination, and consequently also to the other final Honour examinations. It is natural to suppose that it is connected with the three classes into which the Honour list was divided, but there is no connection whatever. The history of the name may be given briefly as follows:—In the ceremonies which were performed on Ash Wednesday in the middle of the sixteenth century, at the admission of questionists to be Bachelors of Arts, an important function was executed by a certain "ould bachelour," who was appointed as champion on the side of the University. He had to "sit upon

¹ In 1828 the hours for the evening problem paper were 6-10, so that the candidates had ten hours' examination in the day. Originally, as mentioned above, the problems were only set to the first two classes; in 1802 they were open to four classes, and in 1818 to all six classes, *i.e.* to all the candidates for Honours.

² Wordsworth (pp. 47 *et seq.*). See also the letters of Gooch, who was second wrangler in 1771 (p. 322).

³ The words of the report are:—"It is further recommended that the questions from books, which have hitherto been proposed to the classes *viva voce*, should, for the future, be printed. And it is hoped that, as by this means the questions proposed in each year will be more generally known, the students may thus be better directed in their reading than they now are, and the mathematical studies of the University become more fixed and definite.

Previously it had been known as the Senate House Examination, and this name continued long afterwards and for more than thirty years was still printed as a heading to the papers set. It was only as a means of distinguishing it from the Classical and other newer Triposes that the name Mathematical Tripos gradually came into use. By the regulations which took effect in 1828 a totally distinct series of papers were set to the poll-men, who then formed the fifth and sixth classes. The fiction of regarding the poll-list as a continuation of the list of mathematical honours still lingered till 1858, the names being arranged in order of merit in four classes called the fourth, fifth, sixth, and seventh; the fourth class being in theory supposed to be the next class to that of the junior optimes.

(To be continued.)

THE COLOURS OF METALS AND ALLOYS¹

THIS lecture is published by request, but the author fears that, dealing as it does with the colours of metals, such interest as it may have possessed when delivered will be greatly diminished in the absence of the experiments and diagrams by which it was illustrated.

I begin with no ordinary pleasure the work which has been intrusted to me by the Council of the British Association. It is nearly twenty years since this series of lectures was established. The first, on "Matter and Force," was delivered at Dundee by a brilliant experimenter and one of the most eloquent living exponents of science: it was followed, at Norwich, by a lecture by Prof. Huxley, to whom the nation owes a deep debt of gratitude for his intense sympathy with all who are seeking to widen the bounds of scientific knowledge—to be whose colleague in one of the most important scientific schools of the country is my great good fortune. These lecturers were succeeded by other eminent men, among whom may be mentioned Spottiswoode, Bramwell, and Lubbock. The object of the lectures is to diffuse a knowledge of the operations of Nature, and to add to the number of those who rejoice in her works. Many, therefore, who have spoken to audiences similar to this, have appealed to natural phenomena; and instead of talking to you about the colour of metals, I also should have liked to dwell on the colour of the sea and sky, but Ruskin's works are, I know, often in your hands, and he has told you once for all of the colour of clouds that "there is not a moment of any day of our lives when Nature is not producing scene after scene, picture after picture, glory after glory, and working still upon such exquisite and constant principles of the most perfect beauty that it is quite certain it is all

a stool before Mr. Proctors" and to dispute with the "eldest son" (the foremost of the questionists), and afterwards with "the father" (a graduate of the College to which the "eldest son" belonged, representing the paternal character of the College). At this time the only "Tripos" was the three-legged stool on which the Bachelor sat. A century later this Bachelor seems to have become a sort of licensed buffoon, and to have been called "Mr. Tripos," just as a president is sometimes referred to as "the Chair," or a judge as "the Bench." During the 120 years in which the name Tripos or Tripos indicated a personage there are frequent allusions to the humorous orations delivered in the schools by those who filled this office. These were known as Tripos speeches. It is probable that Mr. Tripos ceased to take part in the arguments in the schools between 1730 and 1750, just about the time when the Senate House examination was originating. The Tripos speeches were then replaced by copies of Latin verses, which were circulated on the admission days. These were called Tripos verses. About 1747 the Moderators began the custom of printing Honour lists on the back of the Tripos verses. Thus the list of Honours in the Senate House examination came to be called the Tripos list, so that a man's name was said to stand in such a place in the Tripos of his year, i.e. up on the back of the Tripos verses. And, lastly, the name was transferred from the list to the examination, the results of which were published in the list. This account is abridged from Wordsworth's *Scholia Academica*, chap. ii. Wordsworth concludes: "Thus, step by step, we have traced the word Tripos, passing in signification, Proteus-like, from a thing of wood (*olim truncus*) to a man, from a man to a speech, from a speech to two sets of verses, from verses to a sheet of coarse folio paper, from a paper to a list of names, and from a list of names to a system of examination."

A Lecture delivered on September 3 by Prof. W. Chandler Roberts-Austen, F.R.S., to the Operative Classes in the Town Hall of Birmingham, in connection with the meeting of the British Association.

done for us, and intended for our perpetual pleasure."¹ The metallurgist, however, cannot speak with authority on themes such as these; and I have therefore selected a subject which will, I believe, enable me to bring before you important truths affecting a wide range of industrial operations, and at the same time to sustain the true function of art by pointing to the direction in which we may have increased pleasure in things that constitute our most ordinary possessions, and which we use in daily life. First permit me to explain that I intend to include under the title of the lecture any facts which are, in my opinion, connected with the colours of metals and alloys, whether natural to them or produced by artifice, as well as a brief examination of the influence which the colours of metals appear to have exerted on the history of science.

I propose to begin at what will appear to be a somewhat remote starting-point. We say that copper is red, gold yellow, and silver white, but it is by no means certain that the early races of the world had any very clear perception of the difference between these several metallic colours. With regard to early Hebrew and Greek civilisation, Mr. Gladstone has expressed his belief that colour-sense—that is the power of recognising colour—distinguishing it from mere brightness or darkness—was imperfectly developed, and he considers that "the starting-point is absolute blindness to colour in the primitive man," and he urges that the sense of colour has been gradually developed "until it has now become a familiar and unquestioned part of our inheritance." He adds: "Perhaps one of the most significant relics of the older state of things is to be found in the preference (known to the manufacturing world) of the uncivilised nations for strong and, what is called in the spontaneous poetry of trading phrases, loud colour."²

Dr. Magnus holds the view that the colour-sense in man has undergone a great improvement within the last 2000 years, and Prof. Haeckel supports this speculation, but it is opposed by Romanes, who has favoured me with some observations on the subject, in view of this lecture; and it seems to me strange, if savage nations are really deficient in the sense of colour, that the use of such colours as they can get in metals and fabrics, blended, for instance, in a war-club or a pipe-stem, should be so thoroughly "understood" and so discriminatingly employed as we sometimes find them to be. It may further be observed that primitive man may even have derived from his more remote ancestry some power of being influenced by colour, and we are told that the attraction which gorgeous colouring in flowers has for birds and insects, and which colour generally possesses for our nearer ancestors, has been of great importance in the origin of species, and in the maintenance of organic life.

No doubt, in ancient times, there was much confusion between mere brightness and colour, such as is evident in the beautiful sentence in which St. Augustine³ says: "For this queen of colours, the light, bathing all which we behold, wherever I am through the day, gliding by me in varied forms, soothes me when engaged on other things and not observing her." If, however, it were proved that the power of distinguishing the colour of metals was not widely diffused among the Egyptians, Hebrews, and Greeks, it is at least certain that there were individuals of these nations to whom, in very early times, the colour of metals was all-important; and although they may have confused different precious stones under generic names, they certainly appreciated their various colours, and knew, moreover, that by fusing sand with the addition of a small quantity of certain minerals, they could produce artificial gems of varied tints.

¹ "Modern Painters," vol. i. part 2, p. 202, 1851.

² *Nineteenth Century*, p. 367, 1877.

³ "Confessions of St. Augustine." Edition edited by E. B. Pusey, D.D. (p. 212).

My object in leading you so far back—in discussing what appears to be a very matter-of-fact subject—is to point to the close connection between the early recognition and appreciation of colour in metals or minerals, and the foundation of the science of chemistry.

In early scientific history the seven metals known to the ancients were supposed to be specially connected with the seven principal planets whose names they originally bore, and whose colours were reflected in the metals; thus gold resembled the sun, silver the moon, while copper borrowed its red tint from the ruddy planet Mars. The belief in the intimate relation between colours and metals, the occult nature of which they shared, was very persistent, and we find a seventeenth-century writer, Sir John Pettus, saying¹ that "painters" derive "their best and most proper colours from metals whereof seven are accounted the chief, produced from the seven chief metals, which are influenced by the seven planets." A survival of this feeling is suggested by a modern writer, Leslie, who supposed that "when Newton attempted to reckon up the rays of light decomposed by the prism, and ventured to assign to them the famous number seven, he was apparently influenced by some lurking disposition towards mysticism."²

It would be impossible for me to overrate the importance of the colour of metals in relation to scientific history, for the attempt to produce a metal with the colour and properties of gold involved the most intense devotion to arduous research sustained by feverish hope, attended by self-deception and elaborate fraud, such as hardly any other object of human desire has developed. It led to despair, to madness, and to death; but finally, through all, alchemy prepared the way for the birth of chemistry, and for the true advancement of science.

In early times, as now, gold was an extremely desirable form of portable property, and its colour was, perhaps, held to be the most distinctive and remarkable fact about it. I may incidentally observe that the dominant idea of colour in connection with the metallic currency survives in the familiar phrase, "I should like to see the *colour* of his money," which curiously expresses a desire, tempered by doubt as to its fulfilment. On looking back, we find that, at least from the third to the seventeenth century, the colour of gold haunted the early experimenters, and induced them to make the strangest sacrifices, even of life itself, in the attempt to imitate, and even actually to produce, the precious metal. Let us see what kind of facts were known within the period I have indicated. In barbaric times, hammered pieces of gold, or gold beaten into thin sheets and plates, were used with coloured stones and coral for personal adornment. The next step was to make gold go further by gilding base metals with it, and, in order to do this, the colour was for the moment sacrificed by combining the gold with quicksilver. This was done at least in the time of Vitruvius, B.C. 80, heat being used to drive away, as vapour, the quicksilver which had been united to the gold, leaving a thin film of precious metal on the surface to be gilded. But this was possibly not the first method of gilding, for we now know, from a papyrus of about the third century³ of our era, that lead was used for this purpose. Gold, when fused with lead, entirely loses its golden colour, and yet, by the application of heat in air, the lead may be made to flow away as a fusible oxide, leaving the precious metal on the metallic object to be gilt, the base metal being as it were transmuted, superficially at least, into gold. The point I want to insist upon is that the metallic colour of the gold vanished during the process as carried on by the craftsman, only to

re-appear at the end of the operation; and I am satisfied that it was from such simple technical work as this that the early chemists were led to think that the actual production of gold—the transformation of base metals into gold—was possible. The more observant of them, from Geber, the great Arabian chemist of the seventh century, to our own countryman, Roger Bacon, in the thirteenth, saw how minute a quantity of certain substances would destroy the red colour of copper, or the yellow colour of gold. A trace of arsenic will cause the red colour of copper to disappear; therefore, the alchemists very generally argued, some small quantity of the right agent, if only they could find it, will turn a base metal to the colour of gold. Look, they said, how small a quantity of quicksilver will change the appearance of metallic tin. Here is a bar of tin 2 feet long and 1 inch thick, which it would be most difficult to break, though it will readily bend double. If only I rub a little quicksilver on its surface a remarkable effect will be produced, the fluid metal will penetrate the solid one,⁴ and in a few seconds the bar will, as you see, break readily, the fractured surface being white, like silver. It was by such facts as this that men were led to believe that the white metal, silver, could be made.

Successive workers at different periods held divergent views as to the efficacy of the transmuting agent. Roger Bacon, in the thirteenth century, held that one part of the precious substance would suffice to turn a million parts of base metal into gold. Basil Valentine, in the fourteenth century, would have been content with the transmutation of seventy parts of base metal by one part of the agent. While, coming to the end of the eighteenth century, Dr. J. Price, F.R.S., of Guildford, only claimed that the substance he possessed would transmute from thirty to sixty parts of base metal.⁵

It is a curious fact that no one seems to have actually prepared the transmuting agent for himself, but to have received it in a mysterious way from "a stranger"; but I must not dwell on this. I will merely point out how persistent was the view as to the singular efficacy of the transmuting agent, and I will content myself with a reference to Robert Boyle, our great countryman, an accurate chemist of the seventeenth century, who did more than any one else to refute the errors of alchemy. He nevertheless characteristically records⁶ the following experiment, in which, instead of ennobling a base metal, he apparently degraded gold to a base one. He first purified a small quantity of gold, about "two drachms," with great care, and, he states, "I put to it a small quantity of powder communicated to me by a stranger,"—it is singular that even he should have received the transmuting agent in the usual way,—"and," he adds, "continuing the metal a quarter of an hour on the fire, that the powder might diffuse itself through it, . . . the metal when cold appeared to be a lump of *dirty colour*; . . . 'twas brittle, and, being worked with a hammer, it flew into several pieces. From hence," he adds, "it appears that an operation almost as strange as that called 'projection'" (or transmutation) "may safely be admitted, since this experiment shows that gold, . . . the least mutable of metals, may in a short time be exceedingly changed. . . by so small a portion of matter that the powder transmuted a thousand times its weight of gold." He elsewhere observes of a similar experiment, "transmutation is nevertheless real for not being gainful, and it is no small matter to remove the bounds which Nature seems very industriously to have set to the alterations of bodies."⁴ The change in the

Homburg, *Mém. de l'Acad. Royale des Sciences*, 1713 (vol. published 1730), p. 206.

² "An Account of some Experiments on Mercury, Silver, and Gold made at Guildford, in the Laboratory of James Price, M.D., F.R.S.," Oxford, 1782.

³ "The Philosophical Works of the Hon. Robert Boyle" (Shaw's edition), 1738, vol. i. p. 78.

⁴ *Ibid.* p. 262.

¹ "Les Origines de l'Alchimie," par M. Berthelot, 1885, pp. 82, 89. It is interesting to compare the account of this method of gilding by lead with the expression used by Homer, who says: "As when gold is fused around the silver by an experienced man."—"Odyssey," vi. 232-35, quoted by Schliemann, "Ilios," p. 258, in relation to a gilded knife of copper which he permitted me to analyse in 1878.

colour of the gold was remarkable, but Boyle had only produced one of the series of alloys most dreaded by every jeweller—"brittle gold"—for the way in which an alloy of gold and copper is affected by a small quantity of impurity presents one of the most serious difficulties in working gold. It has been known since the seventh century, that minute quantities of certain metals render gold brittle, and it may be well to demonstrate the fact.

Here are two hundred sovereigns: I will melt them and will add in the form of a tiny shot a minute portion of lead amounting to only the 2000th part of the mass, first, however, pouring a little of the gold into a small ingot, which we can bend and flatten, thus proving to you that it is perfectly soft, ductile, and workable. The rest of the mass we will pour into a bar, and now that it is sufficiently cold to handle, you see that I am able to break it with my fingers, or at least with a light tap of a hammer. The colour of the gold is quite altered, and has become orange-brown, and experiments have shown that the tenacity of the metal, that is, the resistance of the gold to being pulled asunder, has been reduced from 18 tons per square inch to only 5 tons. These essential changes in the property of the metal have been produced by the addition of a minute quantity of lead. I have cited these facts mainly to show that the changes produced in the colour and properties of metals by small variations of composition were such as to lead the alchemists on in their belief that it was possible to change lead or tin into gold, and the hope in which they worked enabled them to gather facts out of which chemical science was gradually constructed. We shall see presently that changes in the colour of metals and alloys produced by the addition of small quantities of foreign matter, are of great importance in the application of metals to artistic purposes, but we must first try to examine more closely some of the prominent facts connected with the colour of metals, that is, the effect metals have on light so as to produce the effect of colour in our eyes. We are apt to think of gold as being essentially and distinctively golden-yellow; it may, however, possess a wide range of colours without in any way losing the condition of absolute metallic purity, its relations to light depending entirely on the nature of its surface, and especially on whether the metal is in mass or in a more or less fine state of division. Interesting as gold is to us in mass (and I may incidentally mention that during my official connection with the Mint I have been responsible for the quality of 462 tons of it) it is perhaps still more interesting to us when beaten so fine that a single grain, of the value of 2*d.*, would cover a space of 48 square inches, or when it is so finely divided that the dimensions of a single particle may closely approximate to those of the ultimate atom.

This aspect of the question was investigated by Faraday, and the experimental part of the subject remains practically unaltered to this time. It is well known that a leaf of gold when seen by transmitted light is either green or blue, according to its thickness. Here is such a leaf of green gold, as seen when light is actually sent through it (Fig. 1), so as to project a green disk on the screen. A portion of the light will be reflected from its surface, and this reflected ray may be caught in a mirror and thrown on the screen so that you have, shown side by side, the green disk of transmitted light and the golden one of reflected light from the same leaf of gold.

Gold may readily be converted into a soluble chloride which produces a beautiful golden solution. If such a solution contains very little gold, not more than 2 grains in a gallon, and if certain chemical methods be adopted to precipitate the gold, that is, to throw it out of solution in a solid, though in a very fine state of division, the metal may exhibit a wide range of tint, from ruby to black.

[A few drops of phosphorus dissolved in bisulphide of carbon had been added to about a gallon of a very dilute solution of chloride of gold contained in a tall glass

cylinder, as shown in the sketch (Fig. 2). The beam from an electric light, thrown through the vessel, revealed in the lower part the presence of finely-divided metal of the natural golden colour, while the more finely-divided gold in suspension imparted a brilliant ruby colour to the liquid, and a glowing ruby disk was projected on a white screen.]

When gold is in the "ruby" state, it is so finely divided that each particle probably approximates to the dimensions of the gold atom.

[The solar spectrum was then thrown upon the screen, and the audience was invited to compare it with a diagram which, while closely resembling the solar spectrum,

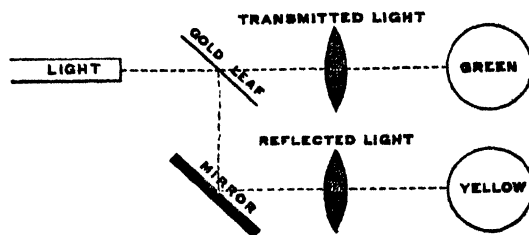

FIG. 1.

really represented the way in which pure metallic gold, prepared by various methods, is capable of behaving in relation to light so as to produce the sensation of a wide range of colours.]

It would be easy to show that light is similarly affected by other metals; but I have selected gold for the purpose of illustration because it is easy to maintain it in a state of purity, however finely divided it may be. We must therefore modify any views we may have formed as to a metal having exclusively a special colour of its own, because it

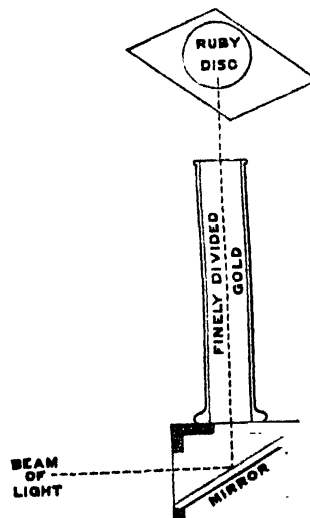

FIG. 2

will be evident that a particular colour is only due to a definite state of arrangement of its particles. The intimate relation between the state of the surface of a metal and its colour is well shown by the beautiful buttons devised by Sir John Barton. He proved that if very fine lines be drawn close together, so that about 2000 would be ruled in the space of an inch, a beautiful iridescent effect is produced, the tints being quite independent of the metal itself due to an optical effect of the lines.

[The image of such a button was then thrown upon the screen.]

et us now examine some effects of uniting metals by joining them together into what are called alloys; and second, the direct influence of a minute quantity of one metal in changing the mass of another in which it is added, and causing it to behave in a different way in relation to light, and consequently to possess a colour different from that which is natural to it; or the added metal may so change the chemical nature of the metallic mass that varied effects of colour may be produced by the chemical combinations which result from the action of certain "pickling" solutions. This portion of the subject is so large that I can only hope to set before you certain prominent facts.¹

First, with reference to the colour produced by the union of metals. Here is a mass of red copper, and here one of gray antimony: the union of the two by fusion produces a beautiful violet alloy when the proportions are so arranged that there is 51 per cent. of copper and 49 per cent. of antimony in the mixture. This alloy was well known to the early chemists, but unfortunately it is brittle and difficult to work, so that its beautiful colour can hardly be utilised in art. The addition of a small quantity of tin to copper hardens it, and converts it, from a physical and mechanical point of view, into a different metal. The addition of zinc and a certain amount of lead to tin and copper confers upon the metal copper the property of receiving, when exposed to the atmosphere, varying shades of deep velvety brown, characteristic of the bronze which has from remote antiquity been used for artistic purposes. But by far the most interesting copper alloys, from the point of view of colour, are those produced by its union with zinc, namely brass. Their preparation demands much care in the selection of the materials, and I might have borrowed from the manufacture of brass instance after instance of the influence of traces of impurity in affecting the properties of the alloy, but it is unnecessary to dwell upon this alloy in Birmingham, or in all that relates to the mechanical manipulation of the alloys of copper with tin and with zinc, you are masters.

I have many inducements in this place to speak about his beautiful alloy. I am proud to be a namesake of the craftsman, William Austen, who, in 1460, made that magnificent monument in brass which covers the remains and commemorates the greatness of Richard Beauchamp, Earl of Warwick, and I am glad to remember that Queen Elizabeth granted the first patent for the manufacture of brass in England to William Humfrey, Assay Master of the Mint, a predecessor in the office it is my privilege to hold.

I want, however, to direct your attention to-night to some alloys of copper with which you are probably less familiar than with brass. In this direction Japanese art affords a richer source of information than any other. Of the very varied series of alloys the Japanese employ for art metal-work, the following may be considered to be the most important and typical. The first is called "shaku-dō"; it contains, as you will observe from Analyses I. and II.,² in

Shaku-dō.			
I.		II.	
Copper	94.50	Copper	95.77
Silver	1.55	Silver	0.08
Gold	3.73	Gold	4.16
Lead11		
Iron and Arsenic ...	traces		100.01
	99.89		

addition to about 95 per cent. of copper, as much as 1 per cent. of gold. It has been used for very large

¹ A list of books and papers dealing with the colours of metals and alloys, and with the production of coloured patina, is given by Prof. Ledebur in his work "Die Metallverarbeitung," p. 285, 1882, published in Bolley's Technologie.

² Analyses Nos. I. and III. are by Mr. Gowland, of the Imperial Japanese Mint at Osaka; Nos. II. and IV. by Prof. Kalischer, Dingler's Journ., ccxv. 93.

works. Colossal statues are made of it; one cast at Nara in the seventh century being specially remarkable. The quantity of gold is, however, very variable; specimens I have analysed contained only 1.5 per cent. of the precious metal. The next alloy to which I would direct your attention is called "shibu-ichi." There are numerous

Shibu-ichi.			
III.		IV.	
Copper	67.31	Copper	51.10
Silver	32.07	Silver	48.93
Gold	traces	Gold12
Iron52		
	99.90		100.15

varieties of it, but in both these alloys, shaku-dō and shibu-ichi, the point of interest is that the precious metals are, as it were, sacrificed in order to produce definite results; gold and silver, when used pure, being employed very sparingly to heighten the general effect. In the case of the shaku-dō, we shall see presently the gold appears to enable the metal to receive a beautiful rich purple coat or patina, as it is called, when treated with certain pickling solutions; while shibu-ichi possesses a peculiar silver-gray tint of its own, which, under ordinary atmospheric influences, becomes very beautiful, and to which the Japanese artists are very partial. These are the principal alloys, but there are several varieties of them, as well as combinations of shaku-dō and shibu-ichi in various proportions, as, for instance, in the case of kiu-shibu-ichi, the composition of which would correspond to one part of shaku dō rich in gold, and two parts of shibu-ichi rich in silver. Interesting effects are produced by pouring two alloys of different tints together just at the solidifying point of the less fusible of the two, so that the alloys unite but do not blend, and a mottled surface is the result. These alloys are introduced into almost every good piece of metal-work.

Now as to the action of pickling solutions. Many of you will be familiar with the mysteries of the treatment of brass by "dipping" and "dead dipping," so as to produce certain definite surfaces, but the Japanese art metal-workers are far ahead of their European brothers in the use of such solutions.

The South Kensington Museum contains a very valuable series of fifty-seven oblong plates, some plain and others richly ornamented, which were specially prepared as samples of the various metals and alloys used by the Japanese. The Geological Museum in Jermyn Street has a smaller, but very instructive, series, of twenty-four plates presented by an eminent metallurgist, the late M. Hochstätter-Godfrey. From descriptions accompanying the latter, and from information I have gathered from certain Japanese artificers now in London, it would appear that there are three solutions generally in use. They are made up respectively in the following proportions, and are used boiling.

	I.	II.	III.
Verdigris	438 grains	87 grains	220 grains
Sulphate of copper	292 "	437 "	540 "
Nitre	—	87 "	—
Common salt	—	146 "	—
Sulphur	—	233 "	—
Water	1 gallon	—	1 gallon
Vinegar	—	1 gallon	5 fluid drachms

That most widely employed is No. I. When boiled in No. I. solution, pure copper will turn a brownish red; and shaku-dō, which, you will remember, contains a little gold, becomes purple; and now you will be able to appreciate the effect of small quantities of metallic impurity as affecting the colour resulting from the action of the pickle. Copper containing a small quantity of antimony gives a shade very different from that resulting from the pickling of pure copper. But the copper produced in Japan is the result of smelting complex ores, and the

methods of purification are not so perfectly understood as in the West. The result is that the so-called "antimony" of the Japanese art metal-workers, which is present in the variety of copper called "kuromi," is really a complex mixture containing tin, cobalt, and many other metals, so that a metal-worker has an infinite series of materials at command with which to secure any particular shade; and these are used with much judgment, although the scientific reasons for the adoption of any particular sample may be hidden from him. It is strictly accurate to say that each particular shade of colour is the result of minute quantities of metallic impurity, and these specimens and diagrams will, I trust, make this clear, and will prove that the Japanese arrange true pictures in coloured metals and alloys.

[This portion of the subject was illustrated with much care by coloured diagrams representing specimens of Japanese art metal-work, by photographs projected on the screen, as well as by the reflected images of small ornaments made of the alloys which had been specially referred to. There was also a trophy of leaves of copper of varying degrees of purity coloured brilliantly by one or other of the "pickles" above described.]

There is one other art material to the production of which I hope art workmen in Birmingham will soon direct their attention, as its applications are endless. It is called in Japanese "mokume," which signifies "wood-grain." It is now very rare even in Japan, but formerly the best specimens appear to have been made in Nagoya by retainers of the Daimio of Owari. I have only seen six examples, and only possess a single specimen of native work, and have therefore had to prepare a few illustrations for you in soldered layers of gold, silver, shibu-ichi, shaku-dō, and kuromi.

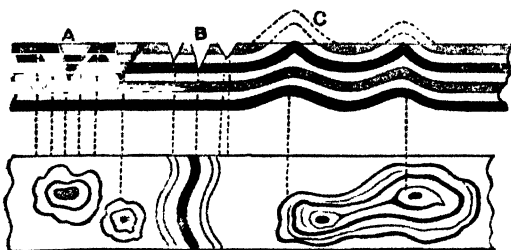

FIG. 3.

This diagram (Fig. 3) shows the method of manufacture. Take thin sheets of almost any of the alloys I have mentioned, and solder¹ them together layer upon layer, care being taken that the metals which will present diversity of colour come together. Then drill conical holes of varying depth, A, in the mass, or devices in trench-like cuts of V section, B, and hammer the mass until the holes disappear; the holes will thus be replaced by banded circles and the trenches by banded lines. A Japanese artificer taught me to produce similar effects by taking the soldered layers of the alloy, and by the aid of blunted tools making depressions on the back of the mass so as to produce prominences on the front, C. These prominences are filed down until the sheet is again flat; the banded alloys will then appear on the surface in complicated sections, and a very remarkable effect is produced, especially when the colours of the alloys are developed by suitable "pickles." In this way any device may be produced. In principle the method is the same as that which produces the *damascening* of a sword-blade or gun-barrel, and depends on the fact that under certain

conditions metals behave like viscous solids, and as truly "flow" as pitch or honey does, only in the case of mokume the art workman has a wide range of tinted metals at command.

Throughout Japanese art metal-work, in which I hope you will take increasing interest, there is the one principle of extreme simplicity and absolute fidelity to nature. The brilliant metals, gold and silver, are used most sparingly, only for enrichment, and to heighten the general effect; these precious metals are never allowed to assert themselves unduly, and are only employed where their presence will serve some definite end in relation to the design as a whole. A Japanese proverb asserts that "He who works in gold puts his brains into the melting-pot," meaning, I suppose, that this metal, so precious from an artistic point of view, demands for its successful application the utmost effort of the workman, and suggesting that gold should not be employed in massive forms such as would result from melting and casting, but should be daintily handled, beaten on to the work, or embedded with the hammer.

Bear in mind that in Birmingham, when a really fine work is produced in silver, the surface is often made gray by chemical means, "oxidised," as it is termed, and this subordination of the brilliancy of silver to artistic effect, is well understood by the celebrated American firm, Messrs. Tiffany, of New York, who are doing so much to catch the spirit of Japanese art metal-work. All I ask you to do is to carry this still further—to cover base metals with these glowing coloured oxides, and thus to add to the permanence of art work, by producing surfaces which will resist the unfavourable atmospheric influences of our cities.

Hitherto we have considered the union of metals by fusion, but fire is not the only agent which can be employed for this purpose. Two or more metals may be deposited side by side by the aid of the electric battery. Birmingham was, as you well know, the early home of electro-metallurgy, an industry to the development of which the great firm of Elkington has so materially contributed. I have no statistics as to the amount of precious metals annually employed for electro-deposition in Birmingham, but it is known that a single works in Paris, belonging to M. Christoffe, deposits annually six tons of silver, and it has been estimated that the layer of silver of the thickness actually deposited on various articles would, if spread out continuously, cover an area of 140 acres.¹ I will not, however, dwell upon the deposition of gold and silver in their normal colours. I would remind you that copper and zinc may be deposited by electrolysis so as to form brass, and that all the beautiful bronzes and alloys of the Japanese can be obtained by galvanic agency; and further, by suitable admixtures of gold, silver, and copper, red-gold, rose-coloured gold, or green gold may be deposited, so that the electro-metallurgist has at his command the varied palette of the decorative artist.

[The images of beautiful deposits of coloured gold, specially prepared by Messrs. Elkington, were then projected on the screen.]

I ought to allude to what has been called the moral aspect of colour, and although I cannot follow Goethe² in his attributes of colour, which seem to me to be fantastic and over-strained, I quite recognise the poetic sympathy of Shakespeare in making Bassanio select the casket of lead, which contained the warrant for his earthly happiness, because "its paleness moved him more than eloquence." I ask you to remember Ruskin's words, that "all men completely organised and justly tempered enjoy colour; it is meant for the perpetual comfort and delight of the human heart; it is richly bestowed on the highest works of creation, and the eminent sign and seal of perfection in them being associated with life in the

¹ The following solder was found to answer well:—

Silver	55'5
Zinc...	26'0
Copper	18'5

² H. Bouilhet, *Ann. de Chim. et de Phys.* t. xxiv. p. 549, 1861.

³ Farbenlehre.

human body, with light in the sky, with purity and hardness in the earth; death, night, and pollution of all kinds being colourless."

I must briefly turn to the concluding part of our subject. It has long been known that thin films of certain metals and certain metallic oxides act on light in the same way as thin films of other translucent substances. I have here such thin films of oxide of lead, which, many years ago, Nobili, Becquerel, and Gassiot taught us to deposit, and such films have since been used in decorative metal-work.

[Beautiful examples of such films were projected on the screen.]

I wish I had time to point to the great interest and importance of films of coloured oxide of iron in the tempering of steel, for it is well known that, apart from the scientific interest of the subject, the shades from straw-colour to blue which pass over the surface of hardened steel when it is heated in air, afford precious indications as to the degree of temper the metal has attained, and in no industry is this better shown than in the manufacture of steel pens. I must pass this over, and turn to one other instance of the formation of coloured films on metals. Here is an ordinary plumber's ladle filled with lead, which will soon be molten when it is placed over his flame. The air will play freely on the surface of the melted lead, and, as a certain temperature is reached, very beautiful films will pass over the surface of the metal. If the lead contains very minute quantities of cadmium or of antimony, the effect will be greatly heightened. If the light from the electric lamp be allowed to fall on the surface of the bath of lead, it will be easy to throw the image of the metallic surface on the screen, and you will see how beautiful the films are and how rapidly they succeed each other when the metal is skimmed. What, then, is the special significance of the experiment from our point of view? It represents in a singularly refined way the one experiment which stands out prominently in the whole history of chemistry; for the formation of a coloured scum on lead when heated in air has been appealed to, more than any other fact, in support of particular sets of views from the time of Geber in the seventh century to that of Lavoisier in the eighteenth. It was the increase in weight of the lead when heated in air that so profoundly astonished the early chemists; and, finally, the formation of a coloured oxide by heating lead in air was the important step which led on your great townsman, Priestley,¹ to the discovery of oxygen; and, as the fact of his residence among you will never be forgotten, Birmingham may claim to have been connected, through him, with one of the most splendid contributions ever offered to Chemical Science.

NOTES

PROF. RÜCKER, F.R.S., has been appointed by the Lord President of the Council to the Professorship of Physics in the Normal School of Science and Royal School of Mines, rendered vacant by the death of Prof. Guthrie, F.R.S.

AT the Royal Society on Thursday last (November 25) a paper was read by Sir Richard Owen, containing some further evidence on the structure of the very remarkable extinct marsupial, *Thylacoleo carnifex*. The author re-affirmed his previous statements that it was a carnivorous beast of the size of a lion, the probable prey of which had been the larger herbivorous marsupials, also now extinct. Prof. Flower, after reviewing the additional evidence that had been adduced, repeated his conviction expressed eighteen years ago in a paper read before the Geological Society, that the dentition of *Thylacoleo* found no parallel in any existing predaceous carnivore, but was formed on

¹ He pointed out that the experiment with minium confirmed his view that mercury calcined in air derived oxygen from the air.

a totally different type, and that there was therefore no justification for assigning to it habits for which it did not seem particularly well adapted. The essential conditions in a dentition which would enable an animal to seize and overcome large and struggling prey, as seen in both lions, tigers, wolves, and the existing carnivorous marsupials, are large canines set well apart, with incisors so small as not to interfere with their piercing action; whereas in *Thylacoleo* the canines are rudimentary, and the central incisors greatly developed. The alternative, sometimes suggested, that the animal was herbivorous, was equally improbable. In fact, it would not be safe to do more than speculate on the habits or food of an animal the dentition of which was so highly specialised, and without any analogy in the existing state of things. Prof. Huxley said that he agreed with the conclusions of the last speaker.

A COURSE of six lectures, adapted to a juvenile auditory, on "The Chemistry of Light and Photography" (with experimental illustrations), will be given at the Royal Institution by Prof. Dewar, M.A., F.R.S., on the following days, at three o'clock:—Tuesday, December 28, 1886; Thursday, December 30; Saturday, January 1, 1887; Tuesday, January 4; Thursday, January 6; Saturday, January 8.

THE Royal Society have just received from Egypt a consignment of specimens of the different strata of soil in the Delta. The borings have been carried out to a depth of nearly 200 feet, and the solid bottom has not yet been reached. The Royal Engineers in Egypt have been intrusted with the work. The specimens, which are chiefly of sand and clay strata, are deemed of great importance, and the Society has granted money for the continuance of the work, which will be carried out by the detachment of Engineers as hitherto.

THE Secretary of State for War has given permission for Sir Frederick Abel, C.B., the Chemist of the War Department, to accept the post of organising secretary to the Imperial Institute, provided that the duties do not interfere with those of his appointment under the War Office; and Sir Frederick Abel has been desired by the Prince of Wales, President of the Imperial Institute, to enter upon his work as soon as possible. The new secretary has just completed his work in connection with the electric lighting of the Indian and Colonial Exhibition, and is also retiring from his duties in connection with the Society of Arts.

ON November 17, at 7h. 18m. p.m., a fine fireball was seen at Stonyhurst College, Blackburn. It appeared to be several times as bright as Venus. In colour it was violet, and of a distinct pear shape. The part of its path observed, as far as could be judged from the stars seen through detached clouds, was from near ι Ceti to the small stars above Fomalhaut, about 88 Aquarii. Its path was slightly curved. So brightly did it shine that attention was first called to it by the illumination of the sky, although seen from a room in which the gas was lighted.

THE *Morning Star* of Jaffna, in Ceylon, reports the death of the taxidermist of the Victoria Museum in that town from the bite of a cobra, under very curious circumstances. While feeding a cobra, which he had supposed was harmless from previous extraction of the poison-bag, it suddenly bit his hand. For a few minutes he took no notice, thinking the bite harmless, but pain and nausea soon began. Carbolic acid was applied, ligatures were bound round the arm, an incision was made at the bite, and the blood of the arm was wholly removed. Various antidotes were used, but the unfortunate man lost the power of speech, and soon after every muscle seemed to have become paralysed, and breathing entirely ceased.

Artificial respiration was therefore resorted to, and this operation was unceasingly continued for nine hours, when at last the patient made an attempt to breathe, and soon regained consciousness enough to make his wants known. He steadily improved until the Friday, the accident having taken place on a Wednesday, and then astonished those around him by stating that during the severe operation of Wednesday night he was conscious of all that was taking place, but was unable to make his feelings known, not having power over a single muscle. It would seem that the poison paralysed the nerves of motion, but not those of feeling, for he could see, and hear, and feel, although the physicians, even by touching the eyeball, could get no response either of feeling or consciousness. His partial recovery was, however, followed by a high fever and inflammation of the lungs, and he died, perfectly conscious, on the following Sunday.

THE New Zealand Government are about to collect salmon ova in Scotland and transfer them to that colony for incubation. It will be remembered that the Royal Commissioner for New Zealand has previously carried out similar work successfully, and it has been found that the *S. salar* thrives well in the waters of that possession. Last year a large number of salmon ova were collected from Scotland, and hatched out and reared in New Zealand.

COMMENCING on January 1, 1887, a journal is to be published by the National Fish-Culture Association, comprising not only information regarding its transactions from time to time, but also articles relative to the subjects of fish-culture, fish, and fisheries. A record will also be given of what takes place in connection with these subjects throughout the whole of the United Kingdom, the colonies, and abroad.

A STRONG shock of earthquake, lasting several seconds, was felt at Smyrna and in the adjacent districts early on the morning of November 27, and news has been received of Tchesme and Chios having been similarly visited. A strong shock was felt at Tashkend on the morning of November 29, causing damage to many houses in the Russian quarter. Two shocks were felt on Sunday at Somerville and at Charleston. A slight shock was felt in Cairo at half-past four o'clock on the afternoon of the 17th. The vibration lasted several seconds.

DURING the past summer, Dr. Fr. Svenonius, the well-known Swedish geologist, has been prosecuting geological, ethnographical, and glacial studies in Swedish Lapland.

ON the evening of November 4 a splendid display of the aurora borealis was seen at Thronhjelm, in Norway. Not only the northern, but also the eastern and part of the southern, sky were covered with aurora. The radiation was particularly brilliant from south-west to north-east, forming a wreath in all the colours of the rainbow. During October, several splendid displays of aurora occurred, but none as brilliant as this one.

ON the evening of October 30 a brilliant meteor was seen from the Faloterbo lightship, on the south-west coast of Sweden. It went in a direction south-south-west to north-north-east, exploding, as it seemed, from time to time, and displaying the most brilliant yellow, red, and green light. At times the sky was illuminated as in full moonlight. About a couple of minutes after the last explosion, reports as of guns were heard. At about 2 a.m. of November 5 another splendid meteor was seen at Hamar, in Norway. It went in a southerly direction across Lake Mjösen, and disappeared from view, leaving a long, broad, variegated trail behind.

PROF. COLLETT, the well-known Norwegian zoologist, announces that the beaver is now extinct in Northern Norway,

but estimates that about 100 are still in existence in the south, chiefly in the province of Nedenæs.

A KITCHEN-MIDDEN has just been discovered at Ginnerup, in Denmark, at the foot of a cliff near a dried-up sound. It is about a yard in depth and of considerable extent, and contains quantities of shells of oysters, mussels, &c.

THE last numbers of the *Journal* of the China Branch of the Royal Asiatic Society (vol. xxi. Nos. 1 and 2) contain a "Symposium" on the question whether Western knowledge, and especially, of course, Western science, should be conveyed to the Chinese through the medium of their own or of a Western language. Fourteen of the leading European scholars in China took part in the discussion. Their views will not bear classification under the heads affirmative or negative, as some hold a middle place, exhibiting a leaning in one direction or another. The general tendency, however, is in favour of exciting the curiosity and interest of intelligent Chinese in the matter of Western knowledge by popular exposition in the native tongue, while reserving a more adequate representation for a time when a sufficient number of Chinese shall have acquired foreign languages to constitute a learned class in our sense of the expression. A further and final stage will be reached when the members of this class, themselves impregnated with foreign knowledge, shall convey it to their fellow-countrymen in their own tongue, gradually modified to suit the exigencies of doctrines now absolutely foreign to the genius of the Chinese language and beyond its capabilities.

IN the course of the discussion, some interesting facts with regard to the translation of scientific terminology into Chinese were mentioned. Dr. Martin, of Peking, referred to Ricci's old translation of Euclid, which he entitled "The Fundamental Principle of the Science of Quantity." Oxygen, hydrogen, and nitrogen are translated so as to express their characteristics of supporting life, of lightness, and of derivation from nitre. On the other hand, Dr. Macgowan mentions that a translator's difficulties in dealing with natural history terms are really enormous. He undertook the translation of Dana's "Mineralogy" and Lyell's "Elements of Geology" into Chinese for the Government, and a scientific native scholar was detailed to assist him. When they came to the plants that have the names of foreign botanists, most of them polysyllabic, they were appalled, and as they could only be rendered phonetically, the native scholar decided against translating any portion of the plant's name, transferring it bodily, according to sound, into Chinese. Similarly, the complex nomenclature of organic chemistry presents a formidable difficulty. A Chinese clergyman, who took part in the discussion, delivered a particularly interesting address, urging that the phonetic method should, as a rule, be employed, on the ground that the characters used in the translation of scientific terms have traditional meanings to the Chinese mind, and thus great confusion is created. The "term"-controversy which has agitated theologians in China for the past half-century, and has divided them into two hostile camps, appears likely to revive in the domain of science, the question lying between translation or phonetic reproduction.

FROM a study of thirty-two years' observations of thunderstorms in the Vienna region, Dr. Hann finds that there is a double maximum of frequency. The greatest number occur in the first half of June, the second smaller maximum is in the end of July; between these is a secondary minimum. (Thunderstorms hardly ever occur in winter.) This agrees with observations in Munich. In Brussels most thunderstorms occur in the second halves of June and July. The daily period in Vienna shows a chief maximum about 3.20 p.m., and a secondary one at 1.2 a.m. The spring and summer storms come mostly from the east or south-east, and seem to belong to Mediterranean

depressions, coming up from the Adriatic, as those of late summer seem to be on the south or south-east border of Atlantic depressions.

BETHNAL GREEN FREE LIBRARY has been doing a large amount of good work in the thickly-populated district in which it is situated, not only by giving facilities for reading books, but by science lectures and science "talks." It is much in want of funds for the extension of operations, and we commend it to the consideration of our readers. The librarian is G. F. Hilcken.

THE additions to the Zoological Society's Gardens during the past week include a Bonnet Monkey (*Macacus sinicus*) from India, presented by Miss G. M. Fisher; a Hedgehog (*Erinaceus* —) from Madras, presented by Mr. H. R. P. Carter; two Mute Swans (*Cygnus oler*), European, a Common Peafowl (*Pavo cristatus*) from India, presented by Lady Siemens; a Red and Yellow Macaw (*Ara chloroptera*) from South America, presented by Mr. Arthur Daunt; a Grey Parrot (*Psittacus erithacus*) from West Africa, presented by Mrs. Greenwood; five Great Eagle Owls (*Bubo maximus*), European, presented by Mr. Philip Crowley, F.Z.S.; a Common Guillemot (*Lomvia boile*), British Islands, presented by Mr. J. H. Gurney, F.Z.S.; two Gambel's Partridges (*Callipepla gambelli*) from California, presented by Mr. W. A. Conklin, C.M.Z.S.; a Malabar Green Bulbul (*Phyllornis aurifrons*) from India, received in exchange; five Great Titmice (*Parus major*), four Blue Titmice (*Parus ceruleus*), two Bullfinches (*Pyrrhula europæa*), European, purchased.

OUR ASTRONOMICAL COLUMN

THE ARGENTINE GENERAL CATALOGUE OF STARS.—This Catalogue, containing the mean positions of 32,448 southern stars determined at the National Observatory of Cordoba, has recently been published by Dr. Gould. The observations from which the Catalogue positions are deduced were made with the meridian-circle of the Cordoba Observatory during the years 1872-80. During these years the zone-observations were the chief object of attention, and the present Catalogue contains the places of those stars whose positions were more elaborately determined during the progress of that great work, and constitute an addition to our knowledge of southern stellar positions of perhaps not less importance than the Cordoba Zone-Catalogue. The General Catalogue gives the positions, for the epoch 1875.0, of most of the southern stars brighter than magnitude 3½, the deficiencies in this respect being chiefly found north of the parallel of 23°, at which the zones begin. These omissions will be of comparatively small importance, inasmuch as the new *Durchmusterung* of Prof. Schöufeld comprises all the southern stars within this region, while accurate determinations of the brighter ones will have been made in the re-observation of Lalande's stars now nearly completed at the Paris Observatory.

ASTRONOMICAL PHENOMENA FOR THE WEEK 1886 DECEMBER 5-11

(FOR the reckoning of time the civil day, commencing at Greenwich mean midnight, counting the hours on to 24, as here employed.)

At Greenwich on December 5

Sun rises, 7h. 51m.; souths, 11h. 50m. 51'4s.; sets, 15h. 50m.; decl. on meridian, 22° 25' S.; Sidereal Time at Sunset, 20h. 47m.

Moon (two days after First Quarter) rises, 13h. 30m.; souths, 19h. 35m.; sets, 1h. 51m.*; decl. on meridian, 0° 19' N.

Planet	Rises		Souths		Sets		Decl. on meridian
	h. m.	h. m.	h. m.	h. m.	h. m.	h. m.	
Mercury	7 16	11 32	15 48	19 53	S.		
Venus	7 54	11 53	15 52	22 27	S.		
Mars	10 19	14 10	18 1	23 45	S.		
Jupiter	3 34	8 49	14 4	9 41	S.		
Saturn	18 35*	2 38	10 41	21 29	N.		

* Indicates that the rising is that of the preceding evening and the setting that of the following morning.

Occultations of Stars by the Moon (visible at Greenwich)

Dec.	Star	Mag.	Disap.	Reap.	Corresponding angles from vertex to right for inverted image	
					h. m.	h. m.
5 ...	14 Ceti ...	6½	16 52	near approach	358	—
10 ...	48 Tauri ...	6	5 52	...	6 38	105 339
10 ...	B.A.C. 1526 ...	6	22 29	...	23 44	78 292

Saturn, December 5.—Outer major axis of outer ring = 45"·4; outer minor axis of outer ring = 17"·7; southern surface visible.

Variable Stars

Star	R.A.		Decl.	h. m.
	h. m.	h. m.		
U Cephei ...	0 52·2	81 16	N. ...	Dec. 8, 1 46 m
Algol ...	3 0·8	40 31	N. ...	6, 23 15 m
ζ Geminorum ...	6 57·4	20 44	N. ...	9, 20 5 m
V Geminorum ...	7 16·8	13 19	N. ...	9, 5 0 m
U Coronæ ...	15 13·6	32 4	N. ...	7, 0 32 m
β Lyrae ...	18 45·9	33 14	N. ...	11, 19 0 M
S Vulpeculæ ...	19 43·7	27 0	N. ...	6, m
T Aquarii ...	20 43·9	5 34	S. ...	5, M
δ Cephei ...	22 24·9	57 50	N. ...	7, 0 0 M
				10, 19 0 m

M signifies maximum; m minimum.

Meteor-Showers

The principal shower of the week is that of the *Geminids*; R.A. 105°, Decl. 32° N., but moonlight will interfere with its observation at the time of its maximum, December 10-11.

Stars with Remarkable Spectra

Star	R.A. 1886·0			Decl. 1886·0	Type of spectrum
	h. m.	s.	h. m.		
20 Leporis ...	5 6	3	11 59·4	S.	III.
119 Tauri ...	5 25	32	18 30·5	N.	III.
64a Schjellerup ...	5 38	52	20 38·8	N.	IV.
α Orionis ...	5 48	59	7 23·1	N.	III.
π Aurigæ ...	5 51	27	45 55·5	N.	III.

THE ROYAL SOCIETY¹

FOR many years it has been my duty as senior secretary to read at each anniversary the death-roll of the year. The names this year are perhaps slightly fewer than usual, but many recall to us faces once familiar that we shall never see here again. Earliest among them comes Sir Frederick Evans, whose death took place only very shortly after our last anniversary. In the course of the preceding summer he crossed the Atlantic to take part in that International Conference which assembled at Washington, to deliberate among other things on the choice of a common prime meridian for all civilised nations. On his return he was looking ill, and the illness increased until it carried him away. Yet even through his illness he kept on working at science, at a task he had undertaken, and which was almost completed when he died. To this I shall have occasion to refer again. In Mr. Busk we have lost one who has long been among us, and who took an active part in the scientific business of the Society. He repeatedly served on our Council, and both then and subsequently gave us the benefit of his extensive knowledge and sound judgment in the important but laborious task of advising the Committee of Papers as to the proper mode of dealing with papers which they referred to him. In Lord Cardwell we have lost a statesman whose political duties did not prevent him from coming among us and serving on our Council. The public services and singular honesty and straightforwardness of Mr. Forster are appreciated by the nation at large. Quite recently, at no advanced age, we have lost Prof. Guthrie, the occupant of a chair which a great many years ago I held for a time; a man whose genial character drew around him a close circle of friends. Still more recently we have lost the Earl of Enniskillen, whose fine palæontological collections are well known to geologists. Only the other day one passed away whom we seldom missed at our anniversary meeting, and who was frequently with us on other occasions: I allude to General Boileau, whose philanthropic labours will not soon be forgotten, and may, I trust, be recognised in a much needed form.

¹ The Fellows will have noticed with satisfaction a very convenient Anniversary Address by Prof. G. G. Stokes, President, on Tuesday, November 30, 1886.

siderable excess of income over expenditure in the balance sheet for the year. At first sight it might be supposed that as the *Transactions* come out at irregular intervals there might have been fewer parts published than usual; but it will be found on examination that the past year has borne its proper share of printing expenses. The excess is really due to a substantial improvement in the Society's property, under the careful and judicious management of our Treasurer.

Last year our President informed the Fellows of the munificent offer made to the Society by Sir William Armstrong to give to the Scientific Relief Fund the sum of 6500*l.*, provided an equal sum were raised by subscription from the Fellows, and, if need be, other friends of science who might not belong to the Society. As the Fellows are aware, a circular was sent round by the Treasurer mentioning Sir William Armstrong's generous offer, and inviting subscriptions; and the Treasurer has also written privately to a number of persons, Fellows and others. The sum subscribed or promised in response to this invitation amounts to about 4200*l.*; and though the sum thus raised does not amount to what Sir William promised to duplicate if it could be raised, he has most generously not only waived the non-fulfilment of the condition subject to which the former offer was made, but has still further augmented it; and he now promises not only to duplicate the sum raised in answer to the Treasurer's appeal, but to give the further sum of 3600*l.*, thus raising the capital from the present sum of about 8000*l.* to 20,000*l.* He will be ready to pay the whole sum of 7800*l.* as soon as the subscriptions promised to the Treasurer have been collected. The only condition attached to this princely gift is, that, besides meeting the ordinary objects for which the Fund was instituted, the Council should feel themselves at liberty to apply a portion of the income to defraying the annual subscriptions of Fellows in special cases where such a course might seem desirable.

The path of the total eclipse of September 9 of last year, in any place where it fell on land, was so remote from this country that no expedition went out to observe it. It was visible in New Zealand, and in anticipation of it our Eclipse Committee sent out a memorandum to the colony indicating the points of special interest to look out for. We have received accounts, drawings, and photographs of the eclipse from Dr. Hector and others. One of the most remarkable features of this particular eclipse was the appearance of two white and unusually bright prominences which attracted general notice, and were compared to electric lamps, and which, situated on opposite sides of the sun, were just over the places of two large spots, one close to the limb, and on the point of disappearing, the other not seen before the eclipse but visible next day, having in the meantime come round the limb.

The present year afforded another of those rather rare occasions, always of brief duration, which are afforded for the study of solar physics by a total eclipse of the sun. Calculations made long beforehand showed that a total eclipse was to be expected on August 29. The path of the total phase on the earth's surface is always narrow, say 100 miles or so across, and on this occasion it swept obliquely across the Atlantic Ocean, cutting the Western Coast of Africa about Benguela, and sweeping across some of the West India Islands to a part of the mainland of South America, where it ended.

Though there was a long belt of ocean over which the totality would be visible, and where the imposing spectacle of a total eclipse might be witnessed, this was not available for regular scientific observations, which require land on which to fix the instruments. On the mainland of America the total phase would come on so shortly after sunrise that the sun would be too low for good observations, and therefore the Island of Grenada, which lay within the belt of totality, was much to be preferred.

Of the two available stations, one lay in the British dominions, and was pretty easy of access from England, and accordingly it seemed to be the duty of our country to take a foremost place in the observations, the results of which would be available to the whole scientific world. It was contemplated first to send expeditions to both places—to Benguela as well as Grenada. The cost of this would, however, exceed what could be spared from the Government Grant without unduly curtailing what was available for other objects. Accordingly application was made to the Lords of the Treasury for a grant of 1000*l.* towards the cost of the expeditions. Inquiries were also made as to the probable climate at the two places; and here I have to express our thanks to the Governor-General of the Windward Islands, who put us in communication with Dr. Wells of Grenada, from

whom we obtained valuable information regarding the climate of that island, and to the Consul-General for Portugal, who obtained information for us from the Polytechnic Institution at Lisbon as to the amount of sunshine about the end of August at Loanda, which may be taken pretty well as representing Benguela.

The information we obtained from various sources as to Benguela was rather conflicting, but there seemed a pretty general agreement that even if the sun should be shining at the time of the eclipse the sky was likely to be hazy. This would much interfere with good observations, especially as regards the corona; and as the expense of the expedition to Benguela would be considerable, and the success very doubtful, we thought it better to give up that part of the project and confine ourselves to Grenada. Being anxious to trench as little as possible on the national expenditure, and finding that a little more could be taken from the Government Grant than we had expected, we wrote to the Treasury reducing our application to 500*l.*, which, with assistance from the Admiralty in the shape of the use of a ship-of-war on the West India station, and supplemented by some money from the Government Grant and from our own Donation Fund, might enable us to meet the expenditure.

The result was that a sum not exceeding 500*l.*, to supplement what could be spared from the Government Grant, was granted, and the expedition, as the Fellows are aware, has sailed and returned. It was fairly successful, the observations having been prevented by clouds at only one of the stations occupied.

There has not yet been time to discuss the observations in full, but two points already appear to have come out pretty clearly. One is that the brightness of the corona, which on this occasion was actually measured, was much less than had been expected, and less apparently than it had been on former occasions. This seems to show that the brightness is liable to great changes in comparing different years, as we know is the case with the form. The other point touches on the question of the possibility of photographing the corona independently of an eclipse. If the photographic brightness of the corona be not overpowered by that of the atmospheric glare immediately around the sun when there is no eclipse, then when the sun is partially eclipsed we might expect to be able to trace the outline of the limb of the moon for some way outside the sun, since the moon would be projected on the background of the corona. The experiment was tried both by Capt. Darwin at Grenada, and by Dr. Gill at the Cape, but in neither case was the limb traceable outside the sun. This throws doubt on, but does not disprove, the validity of the method; for Dr. Huggins himself has never obtained photographic appearances apparently referable to the corona since the Krakat o eruption. It may be that the finely suspended particles, whether connected with the Krakat o eruption or not, which produced those gorgeous sunsets that were so remarkable, have not yet wholly subsided, and cause a considerably increased atmospheric glare. It may be that the corona has actually been much less bright than usual for the last few years.

The present year has been signalised by that remarkable volcanic explosion in New Zealand, of which we have read accounts in the newspapers. We have received from Dr. Hector a series of photographs of the district, taken at no great length of time after the explosion.

The Krakat o Committee, which was appointed at the suggestion of our late President to collect information relative to the great eruption, have now I may say completed their work. The Royal Meteorological Society had appointed a Committee to get together information respecting the remarkable atmospheric phenomena witnessed after the eruption. It was thought desirable that the two Committees should work in concert, and accordingly our Committee was enlarged by the addition of two members of the Royal Meteorological Society, even though they did not happen to be members of the Royal Society, who undertook that share of the work. The information collected under this head is naturally voluminous, since it requires no special training to describe the atmospheric appearances. Our late Fellow, Sir Frederick Evans, undertook the sea-disturbance, and continued to work at it even in an advanced stage of the disease which carried him off. Another fortnight, it was estimated, would have enabled him to complete it. His account was found to have been written in pencil on separate sheets of note-paper, but his successor in the office of Hydrographer, Captain Wharton, our Fellow, was so good as to take up the work; and partly by the use of materials left by Sir F. Evans, partly by his own independent labour, he has now completed it. The report on air-

disturbance was undertaken by General Strachey, and is ready. Prof. Judd undertook geology; the materials are ready, and though the actual report is not yet written, the writing would take but very little time. Mr. Scott undertook to collect information as to floating pumice; but as it has been found that the Krakatão pumice does not possess distinctive features whereby it could be recognised, and therefore the origin of the pumice that ships have encountered at a distance from Krakatão remains unknown, little trustworthy information could be obtained under his head, and the report has been handed over to Prof. Judd to embody with the geology. The heaviest part of the report, that relating to sunsets and atmospheric phenomena, has been prepared by the Hon. Rollo Russell and Prof. Archibald, the two Fellows of the Royal Meteorological Society who have been mentioned as having been added to the Committee, and is ready, with the exception of a little revision, and it remains only to prepare an introduction, index, &c. The whole report may herefore be regarded as all but complete in manuscript, and it will be for the new Council to deal with it.

The Circum-polar Committee have now brought their labours to a close, the report on the observations taken by Capt. Dawson at Fort Rae being printed and published. The reports of the expeditions undertaken by Austria, the United States of America, Germany, and Holland are, I understand, complete, and those by France and Russia are in a forward state. Before the accounts of the observations taken at different stations by the observers of different nations shall have been for some time before the public, it would be premature to expect general conclusions to be deduced from this great undertaking.

Very satisfactory progress has been made during the past year with the publication of the Report of the *Challenger* Expedition. The volumes already published and in the Society's Library now amount to sixteen on Zoology, and three introductory on other subjects. Others are in a very forward state, and it is expected that the whole will be published very nearly within the time mentioned by the Committee, probably at the end of the next financial year.

As mentioned in the Presidential Address last year, advantage has been taken of the British occupation of Egypt to make some explorations by way of boring in the Delta of the Nile, to the results of which geologists attach great importance. The War Department has allowed some of the staff of the Royal Engineers, when their services were not otherwise required, to take part in the operations, and has lent the boring apparatus, and the Royal Society voted the sum of 350*l.* out of its own Donation Fund to defray the cost of labour and other incidental expenses. It was contemplated originally to make a chain of borings, but the depth to which it has been found necessary to proceed in order to get through the ordinary deposit has turned out to be so great that it was thought better, instead of attempting many, to try and get if possible down to rock, or to something else which might afford evidence that what could be referred to alluvium from the Nile or drifted sand had really been got through. A deep boring has accordingly been made at Zagazig, under the direction of Capt. Dickenson, R.E. This has now been carried to a depth of 190 feet 6 inches below the surface, or 164 feet 5 inches below the mean sea-level at Alexandria, and yet nothing has been reached but sand and clay with small pebbles. Prof. Judd is now engaged in the examination of the matter brought up. A derangement of the boring apparatus prevented for the present further progress, and the use of a narrower pipe than any at hand would be required for carrying the boring deeper. The Committee considered that it would be more important to extend this boring, so as if possible to get down to rock, or else to Miocene fossils, than to make a fresh boring in a different place, and arrangements are being made accordingly. The inquiry was deemed a proper one to be assisted out of the Government Grant, and the sum of 200*l.* has been voted from this source to supplement the Royal Society's grant already mentioned.

The ordinary meetings of the Society are well known, and are frequently attended by strangers by permission of the Fellows present; and the papers brought before us are known to the world through our publications. But a great deal of scientific work is done of which the outside public knows nothing. There have been thirteen meetings of the Council during the year, and the attendance at our council meetings is remarkably good. There have been more than seventy meetings of committees and sub-committees.

There is further another task on which a great deal of gratui-

tous and conscientious labour of the highest kind is bestowed. I allude to the examination of papers with a view to advising the Committee of Papers as to their publication. The past year has shown no flagging in scientific activity in relation to papers brought before us.

The preparation of the manuscript for another decade, 1874 to 1883, of the Royal Society's catalogue of scientific papers, is now almost complete. This great work has been extremely useful to men of science in enabling them at once to find where a memoir on a particular subject, written by an author whose name they know, as is usually the case, is to be found. To some extent it enables them also to find what has been written on a particular subject, for there are usually one or two authors, whose names they know, who have made it a special study, and on consulting their papers references are frequently found to the writings of others who have written on the same subject. Nevertheless, it must be confessed that the value of the catalogue would be greatly increased if it could be accompanied by a key, of the nature of an *index rerum*. It was originally contemplated that this should be added, but the magnitude of the undertaking has hitherto prevented the Committee from attempting it. To be well done it would require the long-continued labour of a scientific staff representing different branches of science, and they could not be expected to engage in so heavy a work without adequate remuneration.

A great deal of work has been done during the past year in relation to the library. More than 5000 volumes have been removed to other rooms to make space for the more important works constantly accruing. A list of duplicates and deficiencies has been printed and circulated among corresponding societies. A shelf catalogue is in progress, and is about a third of the way towards completion. Some work has also been done upon a catalogue of miscellaneous literature.

The electric lighting of the Society's apartments, which is now complete, seems to have given general satisfaction.

On August 31 of this year, our distinguished Foreign Member, M. Chevreul, attained his hundredth year. Rarely indeed is it given to any one to see right through a century, more rarely still to retain his powers to such an age, yet both, I am happy to say, have been granted to M. Chevreul. In anticipation of this event, preparations were made for its due celebration. I received an invitation for our Fellows to assist at the celebration; but unfortunately it was at a time of year when most of us were scattered, and moreover time did not permit of making it generally known. I am afraid we had no representative at the actual ceremonial, but I am sure that none the less our hearts were with the veteran *savant*.

This year has also witnessed the celebration of the 250th anniversary of the University of Heidelberg. The Council had appointed our Foreign Secretary as a deputation to represent the Society on the occasion. Unfortunately when the time was close at hand, Dr. Williamson was prevented by the condition of his health from taking part in the celebration; but acting on the emergency on behalf of the Society, I requested our Fellow, Sir Henry Roscoe, to take his place, which he was so good as to do.

In his Presidential Address last year, Prof. Huxley suggested the idea, I may say expressed the hope, that the Royal Society might associate itself in some special way with all English-speaking men of science; that it might recognise their work in other ways than those afforded by the rare opportunities of election to our foreign membership, or the award of those medals which are open to persons of all nationalities alike. This suggestion has been taken up in one of our colonies. We have received a letter from the Royal Society of Victoria, referring to this passage in the Address, and expressing a hope that in some way means might be found for establishing some kind of connection between our own oldest scientific Society and those of the colonies.

The Council have appointed a Committee to take this letter into consideration, and try if they could devise some suitable plan for carrying out the object sought. The Committee endeavoured at first to frame a scheme which should not be confined to the colonies and dependencies of the British Empire, but should embrace all English-speaking communities. But closely connected as we are with the United States by blood and language, they are of course politically a foreign nation, and this fact threw difficulties in the way of framing at once a more extended scheme, so that the Committee confined themselves to the colonies and dependencies of our own country, leaving the wider object for

some future endeavour, should the country concerned seem to desire it. The scheme suggested was laid before the members of the present Council, but there was not an adequate opportunity of discussing it, and it will of course come before the new Council. Should they approve of some such measures as those recommended by the Committee, they will doubtless assure themselves in some way or other that those measures are in accordance with the wishes of the Fellows at large before they are incorporated into the Statutes.

But in connection with this subject there is another suggestion which I would venture to offer, and which I know has been thought of by others.

A good many years ago it was not unusual to elect to the Fellowship men of distinguished eminence in departments other than scientific. More recently a change was made in the Statutes where y Privy Councillors are enabled to become Fellows by a special method, without interfering with the selection by the Council of fifteen from among the candidates whom they recommend to the Society for election. This to a certain extent superseded the necessity of appealing to other than scientific claims, and in some respects the method had special advantages. Those who attained to a place on Her Majesty's Privy Council were sure to be distinguished men, whom we should be glad to welcome among us; and by confining the privilege of special election to these, with whose appointment the Council had nothing to do, all invidious distinctions were prevented. But the method has the disadvantage that it applies only to a particular class of merit. A man, for instance, might be of quite first-rate eminence in poetry or literature, but that would not lead to a seat on the Privy Council. Such a man could only be elected by being placed on the selected list of fifteen. But it seems to me that there is something not quite courteous either to the eminent man himself, or to the scientific man who would have to be passed over to make room for him, in thus putting him in competition with those who seek admission on purely scientific grounds. I cannot help thinking that it might be well if the Council had the power of recommending for special election men of high distinction on other than scientific grounds, whose connection with us would on both sides be felt to be an honour, and who, though not, it may be, themselves scientific, might usefully assist us by their counsel. I do not think it would be difficult to devise means for providing that such a privilege should be accorded only in case of very high eminence.

The application of photography to the delineation of celestial objects has of late years made rapid strides; and, partly owing to the improved sensitiveness of the plates, partly to greater exactness in regulating the motions of equatorially-mounted telescopes, it has been found possible to photograph even minute stars. The question is accordingly now seriously entertained whether we may not trust to photography for the formation of star maps and star catalogues, taking eye-observations on a sufficient number of stars here and there for reference, and trusting to differential measurements taken on the plates for determining the positions of the other stars. Indeed, I think the practicability of this application may now be considered as established, and there only remains the question of the best mode of carrying it out on a uniform plan. In the course of the autumn I had a letter from Admiral Mouchez, Director of the Paris Observatory, in which he informed me that in response to the presentation of specimens of the admirable star photographs taken by the MM. Henry, several of the astronomers to whom they had been sent suggested that it would be well that a conference of astronomers of various nations should be held, with a view to taking concerted action for obtaining on a uniform plan a complete map of the whole starry heavens. He wished accordingly to obtain an expression of opinion on the part of the Royal Society as to the desirableness of holding such a conference; and as it was contemplated, in case the proposal should be favourably entertained by those consulted, that the conference should be held at Paris in the spring, and it would be necessary to give timely notice to the astronomers who live in the southern hemisphere, an early reply was requested.

As it would have defeated Admiral Mouchez's object to wait till the Council should re-assemble after the recess, I wrote at once to consult four of our Fellows specially named by Admiral Mouchez; and on receiving their replies I wrote to Admiral Mouchez, saying that under the circumstances I took it upon me to express in the name of the Royal Society our approval of the suggestion, explaining at the same time that I did so on the understanding, which I fully believed to be in accordance with his

intention, that the astronomers who might attend the conference should not be considered as pledged to the adoption of the methods or scale of the MM. Henry, but that the whole subject should be open to discussion. On reporting what I had done to the Council when they met after the recess, I obtained an expression of their approval.

In these photographs a remarkable instance was exhibited of the power of photography to reveal the existence of objects wholly invisible to the eye. One of the stars of the Pleiades was found to be surrounded by a nebula which cannot be seen with telescopes. The reason of the difference of power of the plate and eye is very obvious: with the eye an object is either seen or not seen at once, whereas with the plate, provided there be an absence of stray light, feebleness of intensity can be made up for by length of exposure.

But the MM. Henry are by no means the only persons who have applied photography to the delineation of the stars. Among others, our Fellow, Dr. Gill, who has sent us some excellent specimens of the photographs obtained by his instrument, proposes to take at the Cape Observatory photographs of the whole starry heavens of the southern hemisphere, under such conditions as to include the magnitudes contained in Argelander's "Durchmusterung" of the northern hemisphere, and to subsequently reduce the observations so as to complete Argelander's great work by extending it to the southern hemisphere. Prof. Kapteyn, in Holland, has nobly undertaken to devote his spare time for seven years to superintending the reduction. Dr. Gill has laid the proposal before the Government Grant Committee. Having regard to the magnitude of the undertaking, and the probability of a conference of astronomers being shortly held in Paris to discuss the whole question, the Government Grant Committee suggested to the Council of the Royal Society that they should appoint a committee to take the subject into consideration, and the Council have acted on this suggestion. Dr. Gill intends to come to Europe in the spring, so that the committee will be able to consult him personally.

This morning I received through the Foreign Office an invitation from the Académie des Sciences for myself and some other delegate of the Royal Society to attend the conference to which I have already referred, which is fixed for April 16. I shall take the first opportunity of consulting the new Council as to their wishes.

The Copley Medal for this year has been awarded to the veteran in science, our Foreign Member, Prof. Franz Ernst Neumann, for his researches in theoretical optics and electro-dynamics.

Having in his earlier years treated of crystallographic subjects almost half a century ago, he turned his attention to the theory of light. Fresnel had, with his wonderful sagacity, arrived at his celebrated laws of double refraction from the theory of transverse vibrations, aided by conceptions derived from a dynamical theory which was only in part rigorous. Cauchy and Neumann, independently of each other, were the first to deduce from a rigorous dynamical calculation, applied to a particular hypothesis as to the constitution of the ether, laws of double refraction, not indeed absolutely identical with those of Fresnel, but closely resembling them. In this case the laws were known beforehand. But in a very elaborate later paper, Prof. Neumann deduced from theory the laws of crystalline reflection, laws which appear to agree with the observations of Seebeck, and which had not been discovered by Fresnel, though some of them were independently and about simultaneously obtained by MacCullagh.

Prof. Neumann is perhaps still better known in connection with the theory of electro-dynamics, and the mathematical deduction of the laws of induced currents due to the motion of the primary and secondary conductor. He may be said to have completed for the induction of currents the mathematical treatment which Ampère had applied to their mechanical action.

Of the two Royal Medals, it is the usual, though not invariable, practice to award one for the mathematical and physical, and the other for the biological sciences.

One of these medals has this year been awarded to Prof. Peter Guthrie Tait, for his various mathematical and physical researches.

Prof. Tait is well known for his numerous and important papers in both pure mathematics and physics. The late Sir William Hamilton regarded him as his own successor in carrying on and completing the newly-invented calculus of quaternions, of which Prof. Tait is continually making new applications. Among his investigations in the domain of experimental physics

may be mentioned his determination of the conducting powers of metals for heat by a method which appears to possess special advantages, and his investigation of the effect of extremely great pressures on thermometers, undertaken with a view to deducing correct results for the temperatures at great depths in the ocean from the observations made in the *Challenger* expedition. This latter subject has led him to investigate the behaviour, as to compressibility and development of heat, of liquids and solids under enormous pressures, a subject in which he is still engaged. Before concluding, I must mention his elaborate papers on systems of knots, recently printed in the *Transactions* of the Royal Society of Edinburgh.

The other Royal Medal has been awarded to our Fellow, Mr. Francis Galton, for his statistical inquiries into biological phenomena.

Mr. Galton is well known as an explorer and geographer, and his mind is singularly fertile in the devising of ingenious instruments for various objects. Many years ago he brought before us some remarkable experiments instituted with a view to test a particular biological theory, in which rabbits of a pure variety were so connected with others of a different variety that the same blood circulated through both individuals, and the point to determine was whether this blood-relationship, in the most literal sense of the term, had any effect on the offspring. Contrary to what the theory in question led us to regard as the more probable, the result proved to be negative. It is, however, in accordance with the rules for the award of the Royal Medals, more especially the later investigations of Mr. Galton, in relation to vital statistics, that have been taken as the ground of the award. He has shown that by taking the average of a number of individuals having some condition in common, individual peculiarities apart from that condition are eliminated in the mean, and results are obtained which may be regarded as typical of that condition. One way of doing this is by his method of compound photographs. Thus we may obtain typical features of criminals of a particular kind, of consumptive persons, and so forth. By adhering to the method of averages, he has even succeeded in obtaining a mathematical expression, very closely verified in observation, connecting the mean deviation of some condition (such for example as stature) in a series of individuals, from the general mean of the same condition, with the mean deviations of the same condition in the relatives of those same individuals of different kinds, such as fathers, brothers, &c. Nor is the statistical method applicable to bodily characteristics alone. Mr. Galton has even extended it with remarkable ingenuity and originality to mental phenomena also.

The Rumford Medal has been awarded to Prof. Samuel P. Langley, for his researches on the spectrum by means of the bolometer.

A better knowledge of the ultra-red region of the spectrum, which includes the larger part of the energy of solar radiation, had long been a desideratum when Prof. Langley commenced his work upon this subject. Finding the thermopile insufficiently sensitive for his purpose, he contrived the "bolometer." This instrument depends upon the effect of temperature upon the electrical resistance of metals, a quantity susceptible of very accurate measurement; and, with its aid, Prof. Langley has been able to explore a part of the spectrum previously almost inaccessible to observation.

A result of Prof. Langley's work, very important from the point of view of optical theory and of the ultimate constitution of matter, relates to the law of dispersion, or the dependence of refrangibility on wave-length. Cauchy's formula, which corresponds well with observation over most of the visible spectrum, is found to break down entirely when applied to the extreme ultra-red.

Prof. Langley has given much attention to the important question of the influence of the atmosphere on solar radiation. The expedition to Mount Whitney, successfully conducted by him in face of many difficulties, has given results of the utmost value, pointing to conclusions of great interest and novelty.

The Davy Medal has been awarded to our Foreign Member, M. Jean Charles Galissard de Marignac, for his researches on atomic weights.

M. Marignac's numerous researches on atomic weights, which have been continued for a great number of years, have played an exceedingly important part in establishing and consolidating that ground-work of chemistry. They are remarkable for originality in devising methods appropriate to the respective cases, and the most conscientious care in discovering errors which occurred

in the respective operations, and indefatigable perseverance in finding means to eliminate the disturbing influences. His labours are all the more valuable because he chose for their field chiefly those elements which are most generally used in chemistry, and are most important to chemists, and on which the determination of new atomic weights is most generally made to depend.

TEN YEARS' PROGRESS IN ASTRONOMY¹

III.

COMETS.—During the past ten years we have been favoured with an extraordinary number of comets, and while perhaps no single great step has been made, yet it is certain, I think, that our knowledge of these mysterious objects has gained a real and considerable advance.

In 1876, curiously enough, not a single comet appeared; but in 1877 there were 6; in 1878, 3; in 1879, 5; in 1880, 5; in 1881, 8; in 1882, 3; in 1883, 2; in 1884, 3; and in 1885, 6; and so far this year, 3. Forty-four comets in all have been observed during the ten years, six of which were conspicuous objects to the naked eye, and two of them, the great comet of 1881, and the still greater one of 1882, were very remarkable ones.

The first of these will always be memorable as the first comet ever photographed. Dr. Henry Draper photographed both the comet itself and its spectrum; Janssen obtained a picture of the comet, and Huggins of its spectrum.

A number of excellent photographs were obtained of the great comet of 1882, especially by Gill, at the Cape. And it is worth mentioning that in May 1882 a little comet (not included in the preceding list, because no observations were obtained of it) was caught upon the photographs of the Egyptian eclipse.

Two of the bright comets, Wells's comet of 1881 and the great comet of 1882, approached very close to the sun, and their spectra, as a consequence, became very complex and interesting. A great number of bright lines made their appearance. Sodium was readily and certainly recognised; iron and calcium probably, but not so surely. The evidence as to the nature of the sun's corona, derived from the swift passage of the 1881 comet through the coronal regions, has already been alluded to.

The Pons-Brooks comet of 1883-84 is extremely interesting as presenting the first instance (excepting Halley's comet, of course) of one of the Neptunian family of comets returning to perihelion. There are six of these bodies with periods ranging from sixty-eight to seventy years. Halley's comet, the only large one of the group, has made many returns, and is due in 1910. Pons's comet, first observed in 1812, has now returned; Olbers's comet of 1815 is due in 1889, and the three others, all of them small, in 1919, 20 and 1922.

I have spoken of them as Neptunian comets, *i.e.* their presence in our system is known to be due in some way to this planet. The now generally received theory is that they had their orbits changed from parabolas into their present shape by the disturbing action of Neptune. Mr. Proctor has pointed out certain unquestionable, though, I think, inconclusive, objections to this view, and he proposes, as an alternative, the startling and apparently improbable hypothesis, that they have been ejected from the planet at some past time by something like volcanic action.

On the whole, however, the most important work relating to comets has been that of the Russian astronomer Bredichin. He has brought the mechanical and mathematical portion of the theory of comet's tails to a high degree of perfection; following out the lines laid down by Bessel, but improving and correcting Bessel's formulæ, and determining their constants by a most thorough discussion of all the accurate observations available.

It is hardly possible to doubt any longer that all the facts can be represented on the hypothesis that the tails are composed of minute particles of matter, first driven off by the comet, and then repelled by the sun. Bredichin's most interesting result, arrived at in 1878, is that the tails appear to be of three, and only three distinct types—the long straight streamers which are due to repulsive acceleration about twelve times as great as the sun's attraction; the second and most ordinary class of broad-curve tails for which the repulsive force ranges between one and two and a half times that of the attraction; and, finally, the short

¹ "Ten Years' Progress in Astronomy, 1876-86," by Prof. C. A. Young, Read May 17, 1886, before the New York Academy of Sciences. Continued from p. 98.

stubby brushes which are found in a few cases, and correspond to a repulsive force not more than one-fourth the sun's attraction. Supposing, as he does, that the *real* repulsion is the same for each atom, the *apparent* repulsion, or repulsive *acceleration*, would be greater for the lighter atoms, and nearly inversely proportional to their molecular weights; and so he concludes that probably tails of the first type are composed of hydrogen, those of the second type of hydrocarbons, like coal-gas, and those of the third of iron, and its kindred metals. As to the second type, the spectroscope speaks distinctly in confirmation. Tails of the first and third types are not common, and are usually faint, and since Br. dichin's result was announced there has been no opportunity for spectroscopic verification in their case.

I said his investigations had given a mathematical and mechanical explanation of comets' tails; but the *physical* question, as to the nature of the force which causes the observed repulsion, remains unsettled, though I think there is no doubt that general opinion is crystallising into a settled belief that it is electrical; that the sun is not at the same electric potential as surrounding space, and that, in consequence, semi-conducting masses of pulverulent matter, such as comets seem to be, are subject to powerful electric forces as they approach and recede from the central body. At the same time there are those—Mr. Ranyard, for instance—who forcibly urge that the direct action of the solar *heat* might produce a similar repulsive effect by causing rapid evaporation from the front surface of minute particles, charged with gases and vapours, *frozen* by the cold of outer space.

I ought not to dismiss the subject of comets without at least alluding to the numerous unprecedented and interesting phenomena presented by the great comet of 1832: first, its unquestionable relation to, but distinctness from, its predecessors of 1880, 1843, and 1668, the three belonging to one brotherhood, of common origin, and all following nearly the same path around the sun. I call special attention to this point, because Miss Clerke, in her new and admirable "History of Astronomy in the Nineteenth Century" (which I hope every one interested in astronomy will read as soon as may be), has, I think, made a mistake regarding it, assigning to the difference between the computed periods of these comets much too great an importance.

The strange elongation of the nucleus of this comet into a string of luminous pearls; the faint straight-edged beam of light that enveloped and accompanied the comet for some time; and the several detached wisps of attendant nebulosity that were seen by several observers, are all important and novel items of cometary history.

Meteors—Time will not allow any full discussion of the progress of meteoric astronomy. It must suffice to say that the whole course of things has been to give increased certainty to our newly-acquired knowledge of the connection between meteor-swarms and comets, and to make it more than probable that a meteor-swarm is the result of the disintegration and breaking-up of a comet. This seems to be the special lesson of the Bielids, the re-appearance of which, as a brilliant star-shower last November, attracted so much attention. In an important paper read before the National Academy of Sciences, last April, Prof. Newton pointed out how all the facts connected with the division into two of Biela's comet forty years ago, its subsequent movements and disappearance, and the meteoric showers of 1872 and 1885, and especially the peculiar features of this last shower, all conspire to enforce this doctrine.

I mention, doubtfully, in this same connection the recent supposed discovery by Denning of what are generally alluded to as "long radiants": systems of meteors, *i.e.*, which for weeks, and even months, together, seem nightly to emanate from the same point in the sky. One of these radiants, for instance, the first of half a dozen described by Mr. Denning, is about $1\frac{1}{2}^{\circ}$ north of β Trianguli, and the shower appears to last from July to November, at the rate of perhaps one or two an hour.

If the fact is *real*, it follows inevitably that, disseminated through all the space in which the earth is moving, and has been moving for several years—not less than 1,000,000,000 miles—there are countless meteoroids moving in parallel lines, and with a velocity so great that the earth's orbital motion of 19 miles a second is absolutely insignificant as compared with theirs. Their speed must be many hundreds of miles per second. This may be true, but I own I am not ready to accept it yet. The observations indicate directly no extraordinary swiftness. Mr. Proctor, whose mind appears at present to be chiefly occupied by the idea that suns and planets are continually bombarding their neighbours (or at least do so at some stage of their existence), ascribes such meteors to the projectile energies of

some of the "great" stars. But there is not time to discuss his notion, and it is hardly necessary, until it has begun to receive somewhat more extensive acceptance. I am not aware that, so far, he has any converts to his theory of comets and meteors.

Stars.—Want of time will also prevent any adequate treatment of the recent progress of stellar astronomy.

Two great works in the determination of star places must, however, be mentioned. One is the nearly completed catalogue of all the northern stars, down to the ninth magnitude, begun almost twenty years ago, under the auspices of the *Astronomische Gesellschaft*, by the co-operation of some fifteen different observatories. The observations are now nearly finished, and several of the observatories have already reduced and published their work. A very few years more ought to bring the undertaking to a successful end.

Another similar work, almost, though not quite, as extensive, is the great catalogue of southern stars, made at the Observatory of Cordova by our own Dr. Gould and his assistants. He himself, with his own eyes, observed every star of the whole number—nearly 80,000—his assistants reading the circle and making the records; and the whole has been reduced, printed, and published within the space of twelve years—a veritable labour of Hercules, for which, most justly, our National Academy has awarded him the Watson Medal. He had already, some years ago, received the gold medal of the English Royal Astronomical Society, for the "Uranometria Argentina," an enumeration of all the naked-eye stars of the southern hemisphere, with their approximate positions and estimated magnitudes. This, however, was only a sort of preliminary by-play, to pass the time while waiting for the completion of his observatory and meridian-circle.

We must mention also the remarkable star-charts made by Dr. Peters, of Hamilton College, of which he has already published and distributed at his own expense about twenty, and more are soon to follow.

But the old-fashioned way of cataloguing and charting the stars is obviously inadequate to the present needs of astronomy, and a new era has begun. While, hereafter, as hitherto, the principal stars, several hundred of them, will be observed even more assiduously and carefully than ever before, with the meridian-circle or similar instruments, the photographic plate will supersede the eye for all the rest. It is now easily possible to photograph stars down to the thirteenth or fourteenth magnitude, and to cover a space of $2\frac{1}{2}^{\circ}$ square on a single plate. The remarkable thirteen-and-a-half-inch instrument constructed by the Henry Brothers, for the Paris Observatory, and first brought into use last August, does this perfectly. Instruments similar, but smaller, lately set up at Harvard College, at the Cape of Good Hope, and at Liverpool, while they do not reach so faint stars, cover more ground at a time.

Negotiations are already under way to secure the co-operation of a number of observatories for a photographic survey of the heavens; and it is probable that, after some preliminary consultation and before very long, it will be actually in progress. According to Struve's estimates, it could be accomplished in about ten or twelve years, even on the Paris scale, by the combined efforts of fourteen or fifteen establishments. Orders have already been given to the Henry Brothers, by Dom Pedro, of Brazil, and Mr. Common, of England, for instruments precisely like the one at Paris. Americans, and New Yorkers especially, may well take a peculiar interest in astronomical photography, since it was at Cambridge, in 1861, that the first star-photographs were ever made, and here, in New York, Rutherford and Draper were among the earliest and most successful workers: in the observatory above us is now mounted the instrument with which Rutherford made his unrivalled pictures of the moon and his plates of the Pleiades, more than twenty years ago.

During the past ten years, stellar photometry has become almost a new science. Its foundations, indeed, were laid by J. Herschel, Seidel, Wolff, and Zollner, before 1870, and the magnitudes of some two hundred stars had been measured, and the law of atmospheric absorption determined. But the great work of Pickering, at Harvard, in the invention and perfecting of new instruments, and his "Harvard Photometry," which gives us a careful measurement of the brightness of all the naked-eye stars of the northern hemisphere, marks an epoch. And he is pushing on, and has already well under way the measurement of the 300,000 stars of Argelander's "Durchmusterung." Nor must we omit to mention Fritchard, of England, whose name has just been joined with Pickering's by the Royal Astronomical Society, in the bestowal of their gold medal for his wedge-photometer and

photometric work done with it. The "Harvard Photometry," and the "Uranometria Oxoniensis" together will carry down to all the record of the present brightness of the stars. They will be especially valuable as data for determining changes in stellar brilliancy.

During the past ten years the number of variable stars has risen from about 100 to nearly 150; and our knowledge of their periods and light-curves has been greatly improved. In America, Chandler and Sawyer, of Boston, and Parkhurst, of this city, have done especially faithful work. During the ten years we have had two remarkable "temporary stars," as they are called—first the one which, in November 1876, in the constellation of *Lygnus*, blazed up from the ninth magnitude to the second, and then slowly faded back to its former brightness, but to a *nebulous* condition, as shown by its spectrum; then also the one which, last autumn, appeared in the heart of the nebula of *Andromeda* of the sixth magnitude (where no star had ever been seen before), slowly dwindled away, and is now beyond the reach of any existing telescope. Perhaps, too, we ought to mention another little ninth-magnitude star in *Orion's* club, which last December rose to the sixth magnitude, and is now fading; it seems likely, however, from its spectrum, that this is only a new variable of long period.

As to star-spectra, a good deal of work has been done in their investigation with the ordinary stellar spectroscopes by the Greenwich Observatory, by Vogel at Potsdam, and by a number of other observers,—work well deserving extended notice if time permitted. But the application of photography to their study, first by Henry Draper in this city, and by Huggins in England, is the important new step. By the liberality of Mrs. Draper, and as a memorial of her husband, his work is to be carried on with the new photographic instrument and method just introduced by Prof. Pickering at Cambridge. He is able to obtain on a single plate the spectra of all the stars down to the eighth magnitude in the group of the *Hyades*, each spectrum showing under the microscope the characteristic lines quite sufficiently for classification. A different instrument is also to be built with the Draper Fund, which will give single star-spectra on a much larger scale and in fuller detail.

During the decade, the stellar parallax has been worked out by a number of observers. Old results have been confirmed or corrected, and the number of stars whose parallax is fairly determined has been more than doubled. The work of Brunnow and Ball in Ireland, of Gill and Elkins at the Cape of Good Hope, and of Hall, at Washington, deserves especial mention. A new heliometer of seven inches aperture has been ordered for the Cape Observatory, and when it is received, a vigorous attack is planned by co-operation between that observatory and that of Yale College, which possesses the only heliometer in America.

During the ten years, our knowledge of double stars has been greatly extended; several observers, and most eminent among them Burnham, of Chicago, have spent much time as hunters of these objects, and have bagged between one and two thousand of them. Several others, especially Doberck in England, and Flammarion in France, have devoted attention to the calculation of the orbits of the binaries, so that we have now probably about seventy-five fairly well defined.

In the study of the nebulae, less has been done. Stephan at Marseilles and Swift at Rochester have discovered many new ones, mostly faint, and Dreyer, of Dublin, has published a supplementary catalogue, which brings Sir J. Herschel's invaluable catalogue pretty well down to date. The studies of Huggins upon the great *Orion* nebula and the so-called "trifid nebula" deserve special mention, as securely establishing the fact that these objects are by no means changeless, even for so short a time as twenty or thirty years; also the discovery of a new nebula in the *Pleiades* by means of photography.

Observatories.—During the ten years, a considerable number of new observatories have been founded. Abroad, we mention as most important the observatories for astronomical physics at Potsdam, in Prussia, and at Meudon, in France, also the Bischoffsheim Observatory at Nice and its succursal in Algiers. The great observatory at Strasburg can hardly be said to have been founded within the period indicated, but the new buildings and new instruments and new efficiency date since 1880. We ought not to pass unnoticed the smaller observatory at Natal, in South Africa, and the private establishments of von Konkoly at O-Gyalla, of Gothard at Hereny (both in Hungary), and of the unpronounceable gentleman Jedrzejewicz at Plonsk, in Poland, and the

observatory at Mount Etna, from which, however, we have no results as yet.

In the United States, we have the public observatories at Madison, Wis., at Rochester, N.Y., and at the University of Virginia, and the, as yet, unfinished Lick Observatory in California: also a host of minor observatories connected with institutions of learning, and mainly designed for purposes of instruction; such establishments have been founded within ten years at Princeton, at Northfield, Minn., at South Hadley, Ms., at Beloit, at Marietta, at Depauw, at Nashville, and at St. Louis, also at Franklin and Marshall College, and at Doane College, in Nebraska, at Columbia College, Ann Arbor, and Madison, Wis., and at one or two other institutions which escape me for the moment. Several others are also at this moment in process of erection. Every one of them has a telescope from six to thirteen inches aperture, with accessory apparatus sufficient, in the hands of an astronomer, for useful scientific work.

Instruments.—A large number of new instruments of great power have been constructed. We mention the great thirty-inch refractor of Pulkowa, the twenty-six-inch of Charlottesville, and the twenty-three inch at Princeton, for all which the lenses were made by our own Clark. We add the great Vienna twenty-seven-inch telescope by Grubb, and the twenty-nine-inch object-glass by the Henrys, made for the Nice Observatory, but not yet mounted; also the nineteen-inch telescope at Strasburg by Merz. Grubb has also at present a twenty-eight-inch object-glass under way for the Greenwich Observatory, and Clark has nearly completed the monstrous thirty-six-inch lens for the Lick Observatory. There never was a decade before when such an advance in optical power has been made.

Great *reflectors* have been scarce, the only ones of much importance constructed during the time being the twenty-inch instrument at Algiers, and Mr. Common's exquisite three-foot telescope, which he has lately sold to Mr. Crossley in order to make way for one of five feet diameter, now, I believe, under construction. The old three-foot and six-foot instruments of Lord Rose have been improved in various ways, and are still in use,—especially in work upon lunar heat. Among newly-invented instruments, we mention the meridian-photometer of Pickering, the wedge-photometer of Pritchard, the almicantar of Chandler, the concave diffraction-grating of Rowland, and the bolometer of Langley—all, but one, American. Repsold's improvements in the micrometer, in the heliometer, and in the mounting of equatorials should also be mentioned here.

As to new astronomical methods, enough has been already said about photometry and astronomical photography. It is plain that we are entering upon a new era.

UNIVERSITY AND EDUCATIONAL INTELLIGENCE

The examination for the Sheridan Muspratt Chemical Scholarship at University College, Liverpool, will begin on December 9. The Scholarship is of the value of 50*l.* per annum, tenable for two years. Candidates should apply to the Registrar before December 6.

SOCIETIES AND ACADEMIES

PARIS

Academy of Sciences, November 22.—M. Jurien de la Gravière, President, in the chair.—On the life and work of L. R. Tulasne, by M. Ed. Bornet. The paper contains a somewhat detailed account of the labours of this eminent botanist, who was born at Azay-le-Rideau (Indre-et-Loire) on September 12, 1815, and died on December 2, 1885. Appended is a list of the scientific publications of MM. Louis-René and Charles Tulasne.—On ammoniac-magnesian phosphate, by M. Berthelot. In continuation of his previous researches on the colloidal and crystallised states of the earthy phosphates, and especially of the phosphate of magnesia, the author here studies the double ammoniac-magnesian phosphate, determining the conditions of formation of this compound in chemical analysis.—The Montgaudier Cave, by M. Albert Gaudry. The author describes a visit he recently paid to this cave, which is situated in the Charente district, and which has revealed several objects of an artistic character, dating from the close of the Quaternary epoch, when the large fauna of extinct species had already mostly disappeared. But some remains,

such as pieces of ivory embellished with carvings of the aurochs and other animals, seem to have been executed at an earlier period, while the cave-dwellers were still struggling for existence with the mammoth, with *Rhinoceros tichorhinus*, the cave-bear, cave-lion, and large hyæna.—On glycose, glycogene, and glycoyeni, in their relation to the production of heat and of mechanical labour in the animal system, by M. A. Chauveau. In this first physiological study of these elements, the author deals more especially with the generation of heat in the organism while in a state of repose. The reasons are set forth which lead to his broad generalisation regarding the preponderating part played by the glycose of the blood in organic combustions, source of animal heat and of muscular energy. It is now fully established that the absorption of glycose in the capillaries during the transformation of arterial into venous blood is connected with the respective activity of the attendant combustions in the several organs.—Some remarks on the determination of mean values, by Leopold Kronecker. It is shown that in a converging series of real terms $\phi_1 + \phi_2 + \phi_3 + \dots$ with positive real quantities $\psi_1, \psi_2, \psi_3, \dots$ increasing with n beyond all limit, the limit of the expression—

$$\frac{1}{\psi_n} (\phi_1 \psi_1 + \phi_2 \psi_2 + \phi_3 \psi_3 + \dots + \phi_n \psi_n)$$

for increasing values of n is equal to zero.—On the movement of an indefinite and perfectly elastic fluid, by M. N. Marin. The object of this study is to complete the law of Mariotte by another described as the law of elasticity for perfectly elastic and completely free fluids. In a fluid so constituted, it is laid down that all contraction determined by any cause whatsoever acting in a single direction, is instantaneously propagated in all other directions.—On the movement of a cord in a fixed plane, by M. Appell.—On the algebraic integrals of Kummer's equation, by M. E. Goursat.—Analytical demonstration of a theorem relating to orthogonal surfaces, by M. Paul Adam. The theorem here dealt with is that of M. Maurice Lévy regarding a group of surfaces in an orthogonal system, and by him demonstrated on purely geometrical considerations.—On the unequal movement of a compressed gas in a reservoir freely discharging into the atmosphere, by M. Hugoniot.—On an apparatus by which the time may be communicated to the performers out of the conductor's sight, by M. J. Carpentier. The apparatus here described has been constructed at the request of the directors of the Paris Opera. It is based on the principle of visible signs, depending on a purely optical illusion, and producing the impression of an ordinary conductor's hand beating time. It is thus free from the defects inherent to the various electric appliances hitherto devised for the same purpose.—On a means of increasing the power of fluid and electric agencies, by M. Charles Cros. In this process a return is made to the old idea involved in the expression "electric fluid," and the wires are regarded as analogous to elongated tubes through which pressure is transmitted. The experiment was suggested by the author's researches on transmissions through more or less elastic tubes containing air or water.—On the tension of saturated vapour, by M. P. Duhem.—On the physical properties of mercury, by M. Marcellin Langlois. On the assumption of a mono-atomic molecule of mercury, the author determines its heat of evaporation, its specific heat, compressibility, and heat of fusion.—Actinometric studies, by M. E. Duclaux.—A new process of volumetric analysis for powdery zinc (*gris d'ardoise* of la Vieille Montagne), by M. Frédéric Weil. By the process here described, 100 gr. of this substance yield 65.3 gr. of pure zinc.—Action of the alcohols on the protochloride of gold and phosphorus, by M. L. Lindet. Here are described the preparation and properties of two chloruro-phosphorous ethers—ethylic and methylic ether.—On the Russian petroleum, by M. J. A. Le Bel. The chief element of the petroleum of Baku, at the eastern extremity of the Caucasus, are naphthenes, $C_n H_{2n}$, and naphthylenes, $C_n H_{2n-2}$; and their salient characteristic is that they do not fix bromine.—On the heats of neutralisation of malic and citric acids and of their pyrogenated derivatives: remarks on the numbers obtained, by MM. H. Gal and E. Werner.—On certain correlations between the modifications experienced by species of different genera subjected to the same influences, by M. Fontannes. Several analogous modifications are noted pervading many species of different genera throughout the geological record; but no theory is advanced to explain the coincidences.—On a new genus of parasitic Copepod, by M. Eugene Canu. This new genus is a parasite of the Synascidians, and abounds on the *Morchellium argus* (Milne-Edwards) frequenting the Wamereux district.—

On the anomalous formations of the Menispermæ, by M. Gérard.—Observations on the plaster added to new wines in the South of France and other parts of Europe, by M. A. Audouy.—Note on the coarse marine limestone formation of the Provins district (Seine-et-Marne), by M. Stanislas Meunier.—On the Devonian system of the Eastern Pyrenees range, by M. Ch. Depéret.—On the pleromorphoses of the quartz of Saint-Clément (Puy-de-Dôme), by M. Ferdinand Gonnard.—Description of a variety of Carphosiderite, by M. A. Lacroix. The optical properties of this mineral, which was found in the neighbourhood of Mâcon (Saône-et-Loire), are described.—On the conditions of form and density of the terrestrial crust, by M. A. de Lapparent. It is argued that the generally-accepted views regarding the symmetrical flattening of the globe at the poles, is far from proved, and it is suggested that in the southern hemisphere there exists an inaccessible anti-arctic continent presenting a different conformation in this respect from that of the northern hemisphere.—On the mode of formation of the Newfoundland banks, by M. J. Thoulet.—On the progressive desiccation of lacustrine basins in dry climates, by M. Venukoff.

BOOKS AND PAMPHLETS RECEIVED

Die Schiffsmaschine; Atlas: Bushey (Lipsius and Fischer, Kiel).—Second Armagh Catalogue of 3300 Stars: Robinson and Dreyer (Thom Dublin).—An Arctic Province; Alaska and the Seal Islands: H. W. Elliot (Low).—Wild Animals Photographed and Described: J. F. Not (Low).—Quarterly Journal of the Geological Society, vol. xlii, part 4, No. 268 (Longmans).—Studies from the Biological Laboratory, Johns Hopkins University, vol. iii, No. 8.—Calendar of University College of South Wales, 1886-87 (Jwen, Cardiff).—Géologie de Jersey: Le P. C. Noury (Sary, Paris).—Memoirs of the Geological Survey of India—Palæontologia Indica, ser. x; Indian Tertiary and Post-Tertiary Vertebrata, vol. iv, part 2, The Fauna of the Karnul Caves: R. Lydekker (Trübner).—Descriptive Catalogue of a Collection of the Economic Minerals of Canada: A. R. C. Selwyn (Albaster).—L'Égalité des Sexes en Angleterre: F. Remo (Nouvelle Revue, Paris).—Theory of Magnetic Measurements: F. E. Nipher (Van Nostrand, New York).—Outlines of the Geology of Northumberland and Durham: G. A. Lebour (Lambert, Newcastle-on-Tyne).—Lehrbuch der Histologie: Dr. P. Stöhr (Fischer, Jena).—Lehrbuch der Entwicklungsgeschichte, Erste Abth.: Dr. O. Hertwig (Fischer, Jena).—Lunar Science, Ancient and Modern: Rev. T. Harley (Somnenschein).—Hourly Readings 1884, part 1, January to March.—The Auk, October, vol. iii., No. 4 (New York).—Journal of Physiology, vol. viii., Nos. 5 and 6 (Cambridge).—Notes from the Leyden Museum, Nos. 1 to 4, 1886 (Drill, Leyden).—Observations Nouvelles sur le Tufeau de Cipeley: A. Kutoi and E. van den Broeck (Liège).—Proceedings of the Academy of Natural Sciences of Philadelphia, April to September 1886 (Philadelphia).—The Washoe Rocks: G. F. Becker.—On the Origin of Agriculture: H. Ling Roth (Harrison).

CONTENTS

PAGE

Industrial Education in America. By W. Odell	97
Our Book Shelf:—	
"American Journal of Mathematics"	95
Letters to the Editor:—	
Longitude in Brazil.—Admiral E. Mouchez, Director of the Paris Observatory	100
Cooke's "Chemical Physics."—Prof. Josiah Parsons Cooke	100
Note on Mr. Budden's Proof that only One Parallel can be drawn from a Given Point to a Given Straight Line.—Prof. O. Henrici, F.R.S.	100
Lunar Glaciation.—S. E. Peal	100
The Astronomical Theory of the Great Ice Age.—Rev. E. Hill	10
Meteor.—W. F. Denning	10
Freshwater Diatoms in the Bagshot Beds.—Rev. A. Irving	10
The Mathematical Tripos, I. By Prof. J. W. L. Glaisher, F.R.S.	10
The Colours of Metals and Alloys. By Prof. W. Chandler Roberts-Austen, F.R.S. (Illustrated)	11
Notes	
Our Astronomical Column:—	
The Argentine General Catalogue of Stars	11
Astronomical Phenomena for the Week 1886 December 5-11	11
The Royal Society. Anniversary Address by Prof. G. G. Stokes, President	11
Ten Years' Progress in Astronomy, III. By Prof. C. A. Young	11
University and Educational Intelligence	11
Societies and Academies	11
Books and Pamphlets Received	11

THURSDAY, DECEMBER 9, 1886

COMPARATIVE ANATOMY OF VERTEBRATES*Elements of Comparative Anatomy of Vertebrates.*

Adapted from the German of Robert Wiedersheim, by W. Newton Parker. (London: Macmillan and Co., 1886.)

IN examinations for the higher degrees and diplomas in science and medicine, candidates are required to show that they possess not only a knowledge of the anatomy of the chief types of the animal kingdom, but also of comparative morphology. Indeed, with respect to medicine, this latter is the more important, especially the morphology of vertebrates. For some time past English students have found themselves considerably handicapped by the want of a short and concise text-book on this subject, to enable them to meet the requirements of Examination Boards; the text-books available for their perusal being generally of too advanced a character, and better suited for the use of those wishing to make comparative anatomy a lifelong study, than for students whose ulterior aim is the practice of medicine or some of its branches. German students, notwithstanding the numerous works on comparative anatomy published in that country, seem to have been equally as ill off for a suitable text-book as their English *confrères*. So impressed was Prof. Wiedersheim that his "*Lehrbuch der Vergleichenden Anatomie*," a work well known and appreciated by comparative anatomists in this country, and one of the leading works on the subject in Germany, was not a suitable book for ordinary students of medicine, that before bringing out a new edition of it he published a smaller one, entitled "*Grundriss der Vergleichenden Anatomie der Wirbelthiere*," expressly to meet their requirements. The number of English students sufficiently acquainted with German to be able to take advantage of this work in the original is unfortunately very small, but to those who could do so it has proved to be of great assistance. So well has the German edition fulfilled the object of its author, that the idea occurred to others besides Mr. Parker, that the translation of so useful a work into English was very desirable in the interests of English-speaking students, though it cannot but be a matter of regret that this should be necessary, and probably would not have been so, were English students as well acquainted with the German language as its importance demands they should be.

Throughout the work before us Mr. Parker has retained the original plan of Prof. Wiedersheim's "*Grundriss*," but a considerable number of additions to and modifications of the original text have been introduced. For some of these he acknowledges that he is responsible, while others have been inserted on the suggestion of Prof. Wiedersheim, who has also revised the whole work previously to its publication.

The work begins with a general introduction, in which the nature and meaning of comparative anatomy is explained, a short outline of the embryological development and structural plan of the vertebrate body is sketched out, and a table is given containing the general classification adopted by the authors throughout the work, of the

principal existing vertebrate groups; there is likewise a second table from H. Credner, showing the gradual development of the Vertebrata in time. This part of the work occupies only 15 pages, and is well illustrated by means of nine woodcuts. It is preceded by a list of general works on comparative anatomy and embryology.

The comparative anatomy of vertebrates, constituting the special part of the work, and occupying 315 pages—the remainder of the book—is dealt with under nine sections, arranged according to the different organs of the body. These are treated of in the following consecutive order: integument, skeleton, muscular system, electrical organs, nervous system, organs of nutrition, organs of respiration, organs of circulation, and urogenital organs. This part of the work is illustrated by 320 woodcuts, most of which are taken from the German edition, but some are new. After each section is appended a short bibliographical list of the more important and recent works relating to the subject under consideration in the chapter.

In treating each section the plan adopted is to begin with a few general introductory remarks, applicable to the whole of the Vertebrata, on the anatomy of the organ or set of organs to be dealt with in the section, and then to proceed to the consideration of its special characters in the different groups of vertebrates. By two kinds of type being used, one larger than the other, the more essential characters of organs or structures are readily distinguishable by the elementary student from the more theoretical and detailed information regarding them printed in the smaller type. The more important words and passages are further indicated by the use of heavy black and spaced types. The former we think might well have been dispensed with, as the use of so many kinds of types tends rather to confuse than render clear. The use of spaced type for important passages and words, though extensively used in German text-books, is only just beginning to be adopted by English authors and printers in place of italics, on which it is a very great improvement. We must, however, enter a decided protest against the use of clarendon type for any purpose except headings, on account of the blotted and disfigured appearance it gives to the pages and on account of the distraction it produces on the reader. Notes explanatory of the text are frequently added at the foot of the page throughout the whole work; that this should have been done is, we consider, a mistake. The introduction of footnotes into any work, and particularly such a work as the present, is extremely objectionable, and should be resorted to as seldom as possible except for references to other publications, where its use may be permissible. Nor is there any excuse in the present instance why so many footnotes should have been introduced, when by the use of a few lines of the smaller type in the body of the page it could have been avoided.

Throughout the text there is a want of uniformity in the manner in which the different kinds of type are used, which will probably be corrected in a new edition; thus, for example, on p. 49 the word "Snakes" is printed in spaced type, whereas three lines lower down "Lizards," another group of Reptiles, is printed in ordinary type, as are also the words "Birds" and "Mammals" on the next page. There are also some

descriptions of structures which might be improved in another edition, so as to make the meaning clearer to the student; as an example of this, the history of the development of hair may be mentioned. The brevity of some of the descriptions is, as the authors state, to some extent made up for by the number of woodcuts, but in some cases we think it would have been well had a few lines more been added, even had it been necessary to curtail some of the small print; thus on the first page surely it would have been well to have devoted a little more space to explaining what is meant by the words "ontogeny" and "phylogeny," terms which are constantly referred to throughout the work. It is true that this is also a fault of the original German edition, but as the translator has not professed to adhere strictly to the German text this is a liberty which he might have taken.

We regret to see the words ecto-, meso-, and endoderm used by Prof. Wiedersheim in the original German changed to epi-, meso-, and hypoblast in the English edition, as we consider the terms used by German and other Continental morphologists preferable to those employed by many English writers. We also traverse the statement in the footnote, presumably Mr. Parker's, that the former terms "are applied to the corresponding layers in the adult animal." The terms are respectively synonymous when applied to vertebrates; the skeleton or muscular system of a rabbit is not spoken of as its mesoderm, but as being of mesodermic or mesoblastic origin.

In describing the homologies of the carpus and tarsus, we quite approve of the position the authors have taken with regard to a subject of much controversy on which further investigations may throw more light, but we think in the general considerations regarding the derivation of limbs from fins the history of the evolutionary changes which have taken place is stated much more definitely than the state of our knowledge justifies. That the theory with which Prof. Wiedersheim's name is connected should be brought prominently forward was to have been expected, but no reference is made to other views, such as those of Gegenbaur and Götze, which, in the uncertain state of our knowledge of the subject, might have been expected. We notice that the pentadactyle form of *Equus* found by Marsh has been omitted in the illustrations of the ancestral forms of the horse's foot, and referred to only doubtfully in the text.

In the section on organs of circulation, the heart and its vessels are excellently described, and the introduction occasionally of coloured illustrations makes the subject as clear as could be desired, but the description of the formation of the circulation in the liver and the modifications of the trunk vessels which have occurred in the evolution of the higher from the lower vertebrates, is very short and meagre.

The criticisms which we have passed, however, are not made with the view of finding fault with an excellent and creditable work, but are expressed in the hope that in future editions it may be made more useful for the purpose for which it is intended.

In conclusion, we heartily thank Mr. Parker for introducing to English students a work which we are confident will prove a great assistance to them in their studies, and by perusal of which they will be enabled to understand

the anatomy of man in a much more comprehensive manner than they could from a study of human anatomy alone.

J. G. G.

SCIENCE IN NORWAY

Nyt Magazin for Naturvidenskaberne. "New Journal of Natural Science." (Christiania, 1886.)

THE four volumes of this admirable publication which have been sent to us by the Norwegian publishers, include the twelve numbers printed since 1882, and thus complete the third series of the magazine, which, notwithstanding its title of "New," is the oldest Norwegian publication of its kind.

The subjects treated of in its pages belong, with few exceptions, to the general natural history of Norway, in which department special attention is due to Herr Leonard Stejneger's paper on the "Ornithology of Western Norway," as well as to the various interesting contributions of Dr. Robert Collett. To the latter eminent naturalist, well known for his able work "On the Fishes of Norway" (1874), the magazine is indebted for several communications regarding the number and distribution of various species of fishes, first observed in Norway between 1879 and 1883, while in his papers on the character and species of mammals indigenous to Norway, he has contributed much useful information in reference to the Norwegian beaver (*Castor fiber*). From the author's observations, it would appear that the injury done to the forests by these animals in bringing down trees for the construction of their huts in no way justifies the indiscriminate destruction of the beaver, which had long been allowed to go on unchecked in Norway. This view has of late been so generally accepted that the Norwegian Government have been induced to appoint a close time of nine months in the year, during which the shooting or trapping of the beaver is legally prohibited. In special cases, and in certain districts, the local magistrates may even extend this period to ten years if they see reason to apprehend the extermination of the animal.

Norwegian geology and mineralogy are well represented in these volumes, Dr. Kjerulf having added to his labours of an editor those of a diligent contributor, and besides several short papers on the finer mineralogical specimens derived from the Storvarts and other important Norwegian mines—a subject which is also well treated by Herr Olsen, Münster, and Knudsen—he has enriched the journal with interesting monographs on the local geology of the country, including notices of the dislocations observable in the Christiania valley; the character of the formations at Mjösen-lake which have been brought to light through recent railway-cuttings; and the inclination of the principal lodes on Ekersund. Dr. Han Reusch describes at length the fall of meteors observed at Vaage in Tysne Island on May 20, 1884, giving useful tables of meteoric falls, whose dates are well attested between 1784 and 1884. Besides various other papers Dr. Reusch contributes some interesting geological notices of the districts of Christiania, Valdres, and Viksnes, and considers at some length the evidence afforded by the fields of Western Norway, of the duration of the Ice age, and the local extension of glacial action in Norway.

The marine zoologist will find much valuable matter in the interesting reports by Messrs. Daniellssen and Koren of the Asteridea, collected in the Norwegian North Atlantic Expedition. These papers are a *résumé* of the complete volume, which will appear later on as part of the Collective Report of the Expedition. Of the 20 genera and 40 species collected, 4 genera and 11 species are new to science. Numerous specimens of the Pedicellaster found in West Greenland, and described by Dr. Sladen as new, to which he gave the specific name of *Palæocrystallus*, is identified by Dr. Daniellssen as *P. typicus* of Sars. Extreme importance attaches to the discovery and careful examination of a specimen of an asteroid—unfortunately the only one secured—which differs from others of the family by having a central dorsal appendage, generally erect, but capable of motion. This curious Echinoderm, to which Messrs. Daniellssen and Koren give the name *Hyaster mirabilis*, is conjectured by them to represent a larval or developmental stage of the Crinoidea, and after a careful study of this stalk-like appendage they hazard the conjecture that further investigations may lead to the discovery that the Asteridea are in fact developed from the Crinoidea. Equally interesting, if less important, is the re-discovery of the Greenland "Cluster-polyp" of Ellis, the "*Zoophytum grønlandicum*" of Mylius. The specimens examined by these earlier naturalists have long disappeared, and for more than a hundred years no others were found. The *Challenger* Expedition brought back several forms of an Umbellula, one of which Prof. Kölliker considered to be of the same species as the lost specimens of Ellis and Mylius; the Norwegian naturalists are of opinion, however, that all the specimens found are mere varieties of *Umbellula encrinurus*, to which they ascribe a wide geographical range.

In conclusion, while we desire strongly to recommend the *Nyt Magazin*, it may not be out of place to mention that several of the most interesting papers on local Norwegian geology are written in German, and that the highly important results of the recent Norwegian North Atlantic dredgings are given by Dr. Daniellssen in English, under the title of a "Preliminary Report" of the Expedition. The magazine, which is under the joint editorship of Professors Kjerulf, Daniellssen, Mohn, and Hiortdahl, is printed in the Latin type now so generally used in the Norwegian press, and is copiously illustrated by well-drawn woodcuts, and excellent plates of the animals described.

OUR BOOK SHELF

Acta Mathematica. (Stockholm. Various dates.)

THIS journal, which has already won for itself the reputation of being one of the leading mathematical journals, not of the North merely, but of the world, sprang into life at the end of 1882, is published at Stockholm, and has all along been under the able editorship of Prof. G. Mittag-Leffler, assisted by all the foremost mathematicians of Sweden, Norway, Denmark, and Finland. Its object is stated to be to gather and publish such mathematical works as contribute to the development of the science by the novelty either of the results obtained or of the methods employed.

The seven volumes which have been issued contain papers by some of the foremost Continental mathemati-

cians: the sole contribution, we believe, in English is furnished by an American writer, Mr. G. W. Hill, and is entitled "On the Part of the Motion of the Lunar Perigee which is a Function of the Mean Motion of the Sun and Moon" (this paper occurs in vol. viii., which is in course of publication). There are in all, in the complete volumes, 107 papers, in almost every department of the science.

It may be in the recollection of our readers that Oscar II., King of Sweden and Norway, who is styled "Special Protector of the Journal," has instituted a great mathematical prize for an important discovery in higher analysis, the particulars of which have appeared in full detail in our columns (vol. xxxii. p. 302); the prize works are to be published in the *Acta*.

The Methods of Glass-Blowing. By W. A. Shenstone. (Rivingtons, 1836.)

NOT only the student who is entering, or has just entered, that mystic land of chemical research, but also the ordinary student of chemistry who wishes to be more than a mere beginner, or a book-chemist, will hail with great joy the appearance of this little book on glass-blowing. We have not many good professional glass-blowers in this country, and, as the author says, it is a difficult if not impossible thing to get any instruction in glass-blowing; and, as a result, the great bulk of chemical students are as dependent on the dealers in glass ware as the bulk of amateur photographers are on dry plates and other things in that connection.

Most students even in our hardest working laboratories have some time to spare in which they might practise some of the more useful and simple methods of making glass apparatus mentioned and described in this little book.

Apart from the immediate utility of being able to make one's glass apparatus in the laboratory, and the help it is in almost any form of chemical or physical research, it cannot fail to be also indirectly useful to a student on his transplantation to a works or the superintendence of some technical operation, and will give him what is so very desirable, in addition to that of the purely chemical manipulation of analysis, a feeling of confidence in overcoming mechanical difficulties.

In the introduction is a description of a suitable working-place, blow-pipe, and bellows—things which are seldom to be found fit to use in our laboratories—and the blow-pipe flames; after which the varieties of glass mostly used, and the actual operations involved in the construction of most glass apparatus, in which glass tubes are the main parts, are very plainly described, being also in many cases illustrated with diagrams of the different stages. The last chapter is devoted to "calibrating and graduating glass apparatus," operations we think every student who gets as far as quantitative analysis should be able to perform in a decent manner.

We most thoroughly recommend this little book to students who intend to become chemists, and hope the proportion of those who can blow a respectable bulb will soon be increased. At present it is about 1 per cent.

LETTERS TO THE EDITOR

[The Editor does not hold himself responsible for opinions expressed by his correspondents. Neither can he undertake to return, or to correspond with the writers of, rejected manuscripts. No notice is taken of anonymous communications. The Editor urgently requests correspondents to keep their letters as short as possible. The pressure on his space is so great that it is impossible otherwise to insure the appearance even of communications containing interesting and novel facts.]

Two Hours with a "Subject Index"

THERE has appeared within the year, under the title of "A Subject-Index to the Modern Works added to the

Library of the British Museum in the Years 1880-85," the latest of the series of indexes published under the auspices of our great national library. Having recently had occasion to consult the same with reference to certain biological works, I experienced so much difficulty in finding what I wanted, that I thought it worth while to inquire more fully into the trustworthiness of the volume as an aid to the working naturalist. I append my notes, in the interest of workers in a field the literature of which is already overburdened.

The book is printed in unnecessarily large type, whence there results a ponderous volume of 1044 pages quarto. Upon the immensity of the task before the bibliographer set to compile such a work I need not comment. If the duty be well performed, there can only result a product useful to all, and helpful to the specialist; if otherwise, confusion becomes confounded, and there ensues to the worker loss of time, if not actual disaster.

Printers' errors and minor inaccuracies are to be expected in a work of the kind, and any such compilation must of necessity be faulty. It is not surprising, therefore, to find "travel" for "translation" in recording the title of Scott Russell's work, on p. 1016. Other similar defects could be quoted, but why are the press-marks occasionally omitted? surely they are next in importance to the titles themselves? The compositor cannot be at fault here.

The compiler sets forth his scheme in a short preface, by no means a bad one if followed. One of the chief provisions reads thus: "Headings and sub-headings are in strictly alphabetical order; precedence being given under each to the larger and more important works." It is in the execution of this self-imposed dictum that the compiler is seen at his best. Who is to be the judge of the relative merits of the collected works, and what is to be the standard of comparison? Presumably, the compiler performs the difficult task in person, but it is indeed well that his method is not revealed, for Huxley's "Crayfish" heads the list of general works upon Mollusca (p. 653), and Miss Buckley's "Life and her Children" that upon Micro-organisms. The thing must be a joke! Nothing of the kind!! "Corallinen Algen" brings up the rear of Corals (p. 212), while "Les Batrachospermes" are exalted to an equality with the Batrachians—a truly novel means this of demonstrating the unity of the biological sciences. The aforementioned inaccuracies amount almost to incredibilities, and it is difficult to realise that they are perpetrated in earnest. It is inconceivable that they can have resulted from mere carelessness; but, even were that so, the fact that they exist at all would be sufficient in itself to disqualify the compiler. We can only regard them as the natural outcome of giving to one man the work of half a dozen; they disfigure the work, and shake our confidence in much that remains. A little less pardonable, perhaps, is the relegation of "Der Tasman-Gletscher" to the Column Tasmania.

The choice of headings is often ill-advised. Four works are recorded upon the Polyzoa; these are equally divided between Polyzoa and Bryozoa, to neither of which headings is there a cross-reference. Writings upon organisms in air generally are distributed between sections Air and Atmosphere, Micro-organisms, and Bacilli and Bacteria, with no cross-references. Papers dealing with the broadest generalisations and the subtlest of details are muddled together regardless of system; while under Micro-organisms there is a cross-reference to Infusoria, sole possessor of which department is Kent's well-known Manual. Section Palæontology is especially introspective. It is divided into the sub-heads General, Bibliographical, Collections of Fossils &c., Fossil Fauna, and Flora—a sufficiently inconsistent arrangement in itself. Conspicuous among the general works is Brongniart's "Recherches sur les graines fossiles silicifées." A knowledge of the publications of his own department ought certainly to be expected of the compiler, through whose hands the covers of the said works must surely pass. But no; for while there has been recorded under the last-named heading Rupert Jones's "Catalogue of Fossil Foraminifera," we look in vain for the companion volumes of Hinde and Lydekker, both of which were published within the period embraced. There is here something akin to contempt for authority! Marsh's "Odontornithes," divorced from Palæontology, finds a home among the Birds.

Having found that the leading tenet of the scheme was violated—that relating to the precedence of important works—I turned next to the second one. It reads: "All books are, so far as possible, grouped together according to their language, in

the following order—English, French, German, Italian. . . There are, however, some deviations from this system—for example, in the history of each country the titles follow each other in chronological sequence, irrespective of language." How the two methods of arrangement thus vaguely formulated are to be simultaneously adopted, we are not informed; and in the ingenious attempt to combine two schemes into one neither has been adhered to—both have suffered. A cursory glance at some of the more important sections, e.g. Birds, shows that the conditions have not been in the least fulfilled, so far as pertains to precedence of language; while, to go afield, we find under Clergy Priesthood, &c., a unique arrangement in which the language run thus—Spanish, English, German, French, Italian, English *ad finem*. Where, here, is the professed patriotism? It desert the author under the inspiration of Clergy, Priesthood, &c., and leaves him reckless. What now of the chronological sequence? One turns instinctively to various historic headings. In none of those examined did I find the exception to be the rule.

The major scheme nullified, the preface becomes a blank; but the details of the superstructure are no more to be relied upon than is the foundation itself. Under Insects, to which the reader is referred from Entomology, there are titles in abundance in which the two catchwords occur; but he looks in vain for references to the fact that the majority of entomological papers are scattered among Coleoptera, Diptera, Hymenoptera, Lepidoptera, Ants, Wasps, Bees and Bee-keeping, and other headings. The Colorado Beetle figures under that heading and under Potato, but not under Coleoptera; while, to complicate matters, a German and an English work upon the subject appear under Potato, the place of the former being, under Colorado Beetle, usurped by a Spanish rival. Fish and Fisheries embraces all branches down to Oyster-Culture, but why no Salmon Fisheries? It appears to suffice that they should take shelter under Salmon, with no cross-references. A special heading is set up for Angling, but several definite works thereof are to be found only under Fish and Fisheries, no reference being given under Angling.

Titles of works are not unfrequently repeated, and that unnecessarily. For example: Morris's "Letters about Birds" occurs under Birds (sub-headings—General, and Great Britain and Ireland); Dixon's, Swaysland's, and Watkins's books are not under their appropriate headings; while Patterson's "Birds, Fishes, and Cetacea frequenting Belfast Lough," which should be under Fauna, Local, is misplaced. Under the last-named heading Canon Tristram's "Fauna of Palestine" appears beneath sub-section Italy—the compiler seems doomed to disaster in his relations with the clergy. In one or two cases where comprehensive titles occur, a process of dismemberment has crept in. For example: Romanes' "Jelly-Fish, Star-Fish and Sea-Urchins" is to be found under Star-Fish and Sea-Urchins, with the title mutilated beyond recognition, but not at all under either Jelly-Fish, Medusa, or Echinoderm; Scot Russell's "Wave of Translation in the Oceans of Water, Air and Ether," to which allusion has already been made, occurs also with a misquoted title, under Water, but under neither Ether nor Air and Atmosphere.

Such are the results of an attempt to gauge the working capacity of the "Index" mainly from a single stand-point. I leave other specialists to inquire for themselves. It has been said that this "work proves the ability and industry of its compiler, and that the Trustees are anxious to make the treasures of the great library a success." Granted the good intentions of the governing body and the industry of the compiler; of the rest the reader must judge for himself—I refrain from further comment thereon. It cannot, however, be admitted that the compiler has done his best; errors cannot be avoided when non-technical hands are applied to technical work, but slovenliness is ever intolerable. I submit that a distribution of labour is demanded for the success of the next essay of the kind.

JUSTITIA

The Origin of Species

IN a recent issue of NATURE (Nov. 25, p. 77) Mr. Catchpole writes:—"Is it, or is it not, the fact that allied species, which are confined each to a particular island, prove, when brought together, far less frequently infertile than species, equally dissimilar, which had lived in the same district, might be expected to prove? On the answer to this question depends, as far as

can see, the fate of the theory of physiological selection. Can no one answer it?"

This is a question which has arisen out of the theory of physiological selection itself, and, as Mr. Catchpool was the first to propound that theory, I am afraid he will find that no one as yet is able to answer his question. But it may interest some of your readers to know that I have collected a considerable body of facts tending to show that there is a correlation between fertility of allied species and the fact of their living on isolated areas, as well as another correlation between sterility of allied species and the fact of their living on continuous areas. But it seemed to me undesirable to publish these facts until very largely augmented; and, finding that no observations had been expressly made upon the subject, I read my paper before the Linnean Society for the purpose of inducing naturalists in different parts of the world to try experiments on the fertility of nearly allied species inhabiting isolated areas, as well as to test for degrees of sterility between natural varieties and parent forms on continuous areas. Meanwhile I am myself trying experiments on the mutual fertility of isolated species, as well as upon the sterility of natural varieties with parent forms. Where birds and mammals are concerned, I am using the numberless islands of all sizes on the west coast of Scotland, which are admirably suited to the purpose. Any of your readers in any parts of the world who are acquainted with well-marked natural varieties of birds or mammals which (together with their parent forms) would be likely to thrive on these islands, would greatly oblige me by communicating suggestions.

I may take this opportunity of also requesting any of your readers who may have further remarks or criticisms to make on the theory of physiological selection not to delay their publication. For it is surely desirable that discussion of the subject "on the high *priori* road" should come to an end. Until a large number of experiments shall have been made, any definite judgment upon the theory must be either biased or premature; and therefore the only influence that can now be exercised by adverse criticism is that of discouraging the work of verification. On this account, and on this account alone, is it worth one's while to answer such criticism. Hitherto I have waited till it should come to an end, and withdrawn the answer previously referred to in these columns as having been in type for the *Fortnightly Review*. When it has come to an end, I will furnish a general reply in the *Nineteenth Century*, and shall then hope to show that whatever "fate" may be in store for the theory at the hands of Nature, at all events it is certain that it has been in no way affected by the assault of naturalists.

GEORGE J. ROMANES

Heredity in Abnormal-Toed Cats

THE calculation made by Mr. J. H. Hodd in last week's *NATURE* (p. 53) of the numerical proportion of the sexes of Mr. Poulton's race of extra-toed cats, in relation to the recurrence of the abnormality, is very interesting as an inferable deduction from the premises of Mr. Poulton's elaborate tabulation of his observations; but it is, I think, doubtful whether it is not misleading as a generalisation from the facts collected by him. A conclusion arrived at by means of a mathematical method is too absolute an inference, and not necessarily reliable, when applied to biological cases, on account of the numerous intervening factors (perhaps mostly unknown, but yet of importance) which are incapable of being appreciated within such an estimate, and which may, in consequence, invalidate the main point under consideration. This appears to be the case on the present occasion; for Mr. Poulton mentions, in describing the kittens of VIII⁵ (p. 39), that by far the most highly specialised development of the abnormality he has observed, throughout the entire race, was attained in a *male*—VIII⁵ iv. Considering that the large majority of individuals possessing the character are of the ♀ sex, as pointed out by Mr. Hodd, this fact is really very striking. But, at the same time, if the point alluded to by Mr. Hodd were considered as amounting to a principle, we should naturally be led to infer that the abnormality might become equivalent to a secondary sexual character, which is so improbable that it scarcely bears suggestion. Besides, it is necessary to bear in mind that all the observations carried on as yet by Mr. Poulton have dealt with the ♂ influence alone; and it may be accounted for by the very reason that all the ♂s have been carefully eliminated from exercising any influence on the race, that the predominant effect, numerically, is on the ♀ side; while it is most probable

that if an abnormal ♂ were selected (say, the individual just referred to) as a starting-point for experiment with normal ♀s, the result would exhibit a general tendency towards superior persistence of the character operating with greater potency amongst the males than the females. It would be very interesting to experiment in this manner under the isolation happily promised in the Madeiran Islands.

Mr. Hodd's statistical statement is, doubtless, correct in the main, under the restricted provision just suggested, only one must not attach too great importance to it. The preponderance in number of the ♀s over ♂s is, indeed, still more noticeable when the ratio of each sex to the total number of the thirty-six cats is considered. Thus it appears that of twelve ♂s 13 $\frac{3}{4}$ per cent. are normal, and only 19 $\frac{3}{4}$ per cent. abnormal; whilst of the twenty-four ♀s 19 $\frac{1}{2}$ per cent. are normal, as many as 47 $\frac{1}{2}$ per cent. are abnormal. It is perhaps a little premature to place entire reliance upon so small a number, but it will prove interesting to compare the statistics brought out in Mr. Hodd's letter with a larger number in time to come.

In considering such a close and carefully detailed analysis as that presented by Mr. Poulton, it is of no little interest to find, on referring to that wealth of facts and principles, "The Descent of Man," that these results are in complete accord with, and confirm the laws of inheritance formulated by Darwin, if the strictures imposed by him, as if in anticipation of future observations, are duly regarded; and as his remarks apply to the present subject very directly,—although bearing more especially upon sexual selection in general.—I cannot do better than quote some of the more pithy:—"Why certain characters should be inherited by both sexes, and other characters by one sex alone, namely by that sex in which the character first appeared, is in most cases quite unknown. We cannot even conjecture why with certain sub-breeds of the pigeon, black stræ, though transmitted through the female, should be developed in the male alone, whilst every other character is equally transferred to both sexes; why, again, with cats, the tortoiseshell colour should, with rare exceptions, be developed in the female alone" ("Descent," 2nd ed., p. 232). It is curious that the cats under observation happen to be tabby-tortoiseshell, and the remark made by Darwin (p. 230), that "as a rule it is the females alone in cats which are tortoiseshell, the corresponding colour in the males being rusty red," fully obtains in the present case, since the ♂s are, unless tabby, sandy-coloured, but never tortoiseshell. It is furthermore important to notice that the sandy individuals have the supernumerary digits as fully developed as any of the ♀s in the same litter.

Darwin's explanation of the persistence of abnormal characters is on the lines of the theory of pangenesis, as follows:—

"It is in itself probable that any character appearing at an early age would tend to be inherited equally by both sexes, for the sexes do not differ much in constitution before the power of reproduction is gained. On the other hand, after this power has been gained, and the sexes have come to differ in constitution, the gemmules (if I may again use the language of pangenesis), which are cast off from each varying part of the one sex, would be much more likely to possess the proper affinities for uniting with the tissues of the same sex, and thus becoming developed, than in the other sex" (p. 232). On p. 237 we find the further remark:—"The presence of supernumerary digits, and the absence of certain phalanges, must be determined at an early embryonic period, . . . yet these peculiarities, and other similar ones, are often limited in their transmission to one sex: so that the rule that characters developed at an early period tend to be transmitted to both sexes here wholly fails."¹

And, in conclusion:—"Characters of the parents often, or even generally, tend to become developed in the offspring of the same sex, at the same age, . . . in which they first appeared in the parents. But these rules, owing to unknown causes, are far from being fixed. Hence, during the modification of a species, the successive changes may readily be transmitted in different ways; some to one sex, and some to both; some to the offspring at one age, and some to the offspring at all ages. Not only are the laws of inheritance extremely complex, but so are the causes which induce and govern variability" (p. 240).

It is quite remarkable, though it is not at all surprising, how closely Mr. Poulton's facts fit into these deductions of Darwin's, drawn, as they were, from such few instances that they seem to be little less than preconceived ideas.

But, as it may be due to a one-sided influence in special

¹ This is a point which perhaps requires further evidence.

cases that an effect is found to have clung with so much persistence to one sex, I am inclined to believe that, upon the experiment being made as I have suggested, that the other sex will produce similar results in regard to the numerical proportion of the sexes, and a strong point in favour of this opinion lies in the fact that, as I have myself seen, a sandy coloured kitten, apparently bearing the stamp of the normal parent, was found to bear the development of the supernumerary digits in a marked degree.

WILLIAM WHITE

55, Highbury Hill, N., November 22

Algebraic Notation of Kinship

WITH reference to Mr. Davison's letter in NATURE (vol. xxxiv. p. 571), I wish to point out that the subject of algebraic notation, not only for kinship, but for kinship and affinity, has been pretty fully discussed in several papers which I contributed to the Royal Society of Edinburgh, and especially in a paper entitled "Analysis of Relationships of Consanguinity and Affinity," which, at the request of Mr. Galton and Dr. Tylor, I contributed to the Anthropological Institute (*Journal of the Anthropological Institute*, August 1882). Some idea of the nature of that paper may be got from a statement of the several tables which are appended to it. Table I. gives the notation for the general relations of the first five orders, states the general and singular meaning of each, and classifies them according to index, sign, and grade. Table II. shows how these general relationships are divided into ultimate species. Table III. gives all the possible relationships of a man to a woman, and of a woman to a man, within the first five orders; and such relationships as exclude marriage according to the laws of England are marked with an asterisk. Table IV. gives the consanguineous relationships of the first five orders grouped in lines and species, the agnatic system being formed by the extreme terms on the left, and the uterine system by the extreme terms on the right. Table V. gives strict definitions of the English terms of relationship.

Besides the algebraic notation, I also developed a graphical notation. In the paper referred to, I apply the graphical notation to show the descent of property according to the English law.

Prof. Jevons took much interest in these papers, and it was his intention to give the elements of the analysis in a new chapter of his "Studies in Deductive Logic," but death snatched him from us in the midst of his scientific labours.

ALEXANDER MACFARLANE

University of Texas, Rustin, Texas, November 15

Seismometry

IN the last number of NATURE (p. 75) there appears a letter by Prof. J. A. Ewing, referring to a note in a previous number (p. 36), apparently a summary of a communication from Prof. Milne. As I have some interest in this question, and have reason to believe from remarks made in a letter lately received from Prof. Milne that the matters referred to by Prof. Ewing cannot be those to which Prof. Milne referred, I should be glad if the original communication could be published.

Prof. Ewing's letter and indeed several of his recent publications, including the description of his instruments in NATURE, are decidedly calculated to mislead those not familiar with the seismological work which has been done in Japan. For example, he says, or leads one to infer, that he introduced horizontal pendulums in seismology; now that is not the case. It is needless for me to say that horizontal pendulums have long been known as a means of obtaining nearly neutral equilibrium; and in particular, with reference to Japan, they are referred to by Prof. Milne on page 25 of vol. i. part 1 of the *Trans. Scis. Soc. Japan*, in a paper which was read in Prof. Ewing's presence several months before Prof. Ewing's instrument was heard of. What Prof. Ewing did introduce was a particular form of horizontal pendulum, very particularly described by him in some of his early papers, as involving a "new principle" (now apparently abandoned by him), and he used two such pendulums to write two components of the earth's motion on a *continuous* moving plate. Records on moving surfaces were not new then, even in Japan, as they are referred to in papers published by other investigators before Prof. Ewing arrived in the country, but there was this difference in these older methods, that the plates were automatically started by the earthquake; and Prof. Ewing, after his experience, has now adopted this plan.

Prof. Ewing mentions also in his letter that his apparatus writes three components of the motion, but he does not say that the most difficult of the three—namely, the vertical component—is written by an instrument which I introduced and described before the Seismological Society of Japan, first in May 1880, and afterwards in a modified form in April 1881. Prof. Ewing's instrument is professedly, as his first description (*Trans. Scis. Soc. Japan*, vol. iii.) clearly shows, a modification of my second form, and is, what he seems persistently to have shut his eyes to, almost identical with my early form.

As to Prof. Ewing's statement in the last sentence of his letter that "there is nothing better to take their place," we can hardly be expected to take *his* judgment on this point.

THOMAS GRAY

7, Broomhill Avenue, Partick, Glasgow, November 30

[Nothing essential was omitted from Prof. Milne's letter.—ED.]

Botanical Lecture Experiment

THE following simple lecture-experiment may interest teachers of botany. It is described by Georg Klebs in his paper "Ueber d. Organisation d. Gallerte bei einigen Algen u. Flagellaten," published in the most recent part of *Unters. a. d. bot. Inst. zu Tubingen*. A description of the experiment I give in Klebs' words, translated:—"It is easy to demonstrate, by addition of a watery solution of phenolphthalein, that Algae make the water in which they live alkaline when they are fixing carbon in light. In proportion as the fixation of carbon proceeds, the water gradually assumes a deep red tinge, which gradually disappears when light is excluded." The explanation given is:—"The Alga takes up not only the CO₂ absorbed in the water, but also in part that which is in combination in acid carbonates, in consequence of which alkaline combinations arise; in darkness, owing to respiration, the reverse process takes place."

I have a vessel with water containing phenolphthalein in which *Cladophora* has grown for nearly three weeks, and there is daily a reddening of the water, its rapidity being determined by the brightness of the day; during the night the colour disappears

BAYLEY BALFOUR

A Lecture Experiment on the Expansion of Solids by Heat

MR. MADAN's description of a device for showing that metal and solids expand when exposed to heat is very interesting especially as such an arrangement, but with important modifications, is capable of giving very excellent scientific results, result which are only surpassed by M. Fizeau's method. One necessary alteration is the substitution of a spring-pressure for the weight on the strip of metal. This and other points will be made quite clear by a perusal of a short description contained in my paper "A Strain-Indicator for Use at Sea," read before the Institution of Naval Architects. The numerous tables and diagrams there given would, I am afraid, hardly interest your readers, but the repeated experiments in Table I. would be a subject of interest, as they show how well the experiments agree among themselves. The errors, though small, are due, in my opinion not only to the difficulty of reading the dial (each unit being equal to about half an inch, and the second decimal therefore about 1/200 inch), but also to the difficulty of reading the exact position of the weight on the steel-yard of the testing-machine. Far more accurate results are obtained when, instead of a jockey weight being run out, small weights are added one by one.

You will also notice that the instrument gives very good records on paper (see launching strain diagrams and railway bridge diagrams), and in this shape it could, I think, be used with advantage for recording changes of temperature.

C. E. STROMEYER

Strawberry Hill, Middlesex, December 2

Meteors and Auroras

IN the *Proceedings* of the Paris Academy of Sciences published in NATURE for November 4, at p. 23, a relation between showers of shooting-stars and auroras is noted. In this vicinity (April 14, May 8, July 27, and November 2, very fine aurora were visible, and upon each occasion shooting-stars of unusual brilliancy were observed in the northern heavens whilst the aurora was at its height.

M. A. VEEDER

Lyons, New York, November 24

THE GUTHRIE MEMORIAL FUND

A COMMITTEE has been formed, under the presidency of Prof. Huxley, to raise a memorial fund in honour of the late Prof. Guthrie, F.R.S. Prof. Guthrie endeared himself to a large circle of friends by his simple character and wide sympathies. Unfortunately, as his time was exclusively devoted to teaching and to scientific research, the provision for his family is far from adequate. A slender income is furnished for his widow by a policy of insurance settled upon herself, but this will not enable her to provide for the education and maintenance of her step-children. The ages of the children dependent upon her are twelve, fourteen, and seventeen years respectively, and their case is the more sad because, until a late period of his life, Dr. Guthrie had every reason to be satisfied that they were sufficiently provided for.

Under these circumstances it will be felt by all who value his memory, as well as by those who only knew him through his scientific labours, that any sum which is gathered as a memorial of his life must necessarily be devoted to placing his children as nearly as may be possible in the position they would have occupied but for his untimely death.

Subscriptions may be sent to the Honorary Treasurer, Major Macgregor, R.E., Science Schools, South Kensington Museum, London, S.W.; or to the Honorary Secretary of the fund, Mr. C. Vernon Boys, at the same address. Cheques to be crossed "Messrs. Cox and Co."

In addition to the gentlemen named above, the Executive Committee consists of Capt. Abney, Prof. W. G. Adams, Prof. Roberts Austen, Walter Besant, Prof. G. Carey Foster, Dr. J. H. Gladstone, W. J. Harrison, J. Power Hicks, Prof. J. W. Judd, Prof. A. W. Reinold, and Prof. Balfour Stewart; besides whom there is a General Committee, comprising Prof. W. E. Ayton, Shelford Bidwell, Walter Bailey, T. Lauder Brunton, W. H. M. Christie, Prof. Clifton, Conrad Cooke, Prof. Crookes, Warren De La Rue, Prof. Dewar, Colonel Donnelly, General Festing, Prof. G. Forbes, Prof. Fuller, R. T. Glazebrook, Prof. Goodeve, Dr. Hopkinson, J. Norman Lockyer, Sir John Lubbock, Bart., Prof. MacLeod, Prof. J. Perry, Prof. Poynting, Prof. Rücker, Dr. W. J. Russell, Prof. W. A. Tilden, Prof. S. P. Thompson, Prof. Thorpe, and Dr. Alder Wright.

It is satisfactory to hear that already a considerable number of subscriptions have been received, but it is hoped that when the necessity for the existence of such a fund shall become better known there may be a large increase in the number.

VOLCANIC ERUPTION IN NIUA-FU, FRIENDLY ISLANDS

SIR J. H. LEFROY has forwarded to me a small packet of volcanic dust, together with an extract from a letter written by Mr. Coutts Trotter, F.R.G.S., and has requested me to examine the former and append my remarks upon it to the more important parts of Mr. Trotter's letter. This document is dated on September 24, 1886, "on board the ss. *Suva*, a few miles south of the Island of Niua-foou" (or Niua-fu, one of the Friendly Islands). After speaking of an expedition to Fiji, Mr. Trotter proceeds:—

"Meanwhile I got into a little steamer to visit the windward island of the group, and was persuaded to come on in her to Tonga. There I found that news had just come of an awful volcanic eruption in the Island of Niua-foou above mentioned, and my steamer was chartered to go and make inquiries and give relief. . . . We started at once, and arrived off the island before dark yesterday. No trace of fire or smoke, and I was much chafed for my 'disappointment.' But on landing this morning we found the damage done was substantial enough, an erup-

tion of dust and stones and water having gone on for eighteen days, and two-thirds of the island smothered or greatly injured. The island is some forty or fifty miles round, all volcanic, no beach anywhere, and landing difficult, and a lake of brackish-bitter water occupying perhaps a fourth or more of its extent. There are at all events three small islands in the lake, one with a lake in its centre. I suspect this lake is the remains of the crater and eruption to which the existence of the island is due, later eruptions being cause for the small island craters. The present eruption began apparently near one end of the lake. I saw three or four craters there—one covered with a green sulphurous scum; and another, just beyond it, which I could not in the time I had actually visit, very deep, and full (a friend tells me) of mud and water. Near it is a little rounded mountain of 'earth,' some 200 feet high, formed by the present eruption, and projecting far into the lake; at the other end of the lake is a fresh accumulation, as I was told, of pumice, but it looked to me from where I stood more like an accumulation of black sand. The whole island has been in a disturbed state for some three months and a half, the dates of the principal disturbances coinciding remarkably with those which are going on in other parts of the world—earthquakes on June 8 and 11, which I think are the dates of the first New Zealand outbreaks,¹ again on August 12, ditto. This of course is not wonderful, but the final catastrophe here took place on August 31, which we understand was the exact date of the recent American earthquake.² It was preceded for twenty-four hours by earthquakes, . . . and went on for ten days, I am told, without intermission, then two days quiet interval, then going on again for nearly a week—terrific thunder and lightning for twenty four hours incessantly. The column of steam rose, they say, several thousand feet, anyhow immensely higher than a hill 7600 feet high, which I ascended, and whence I had a bird's-eye view of the lake and crater. Showers of stone accompanied it; these fortunately fell straight, or nearly straight, back. They were red-hot, with masses of dust attached, and as they fell left the dust behind, which produced the effect of a fiery tail. The great mischief was done by the dust, which, as the wind shifted, carried destruction in every direction. In one village which I entered, the shower only lasted an hour and a half, but the ground was deeply covered, the blades of grass even now only beginning to peep through, and every coco-palm ruined for the present, the branches hanging withered and almost perpendicular, and the young central shoot sticking out by itself. If they get rain, the trees will recover and bear again in three years, but otherwise are likely to die. But in other districts the houses are buried, and along the coast large extents of forest, scrub, or bush, and, what is more immediately serious, the yam beds. They have just been planted, and any that were above ground will be killed, even if the latest planted may push through and flourish. Wonderful to say, no one was killed, although many very old people have died since from fear and exhaustion. They all betook themselves to the upper parts of the island for safety, and perhaps with reason, for the last two volcanic outbursts both took place on the coast-country near the shore. These (respectively nineteen and forty years ago) were both lava eruptions. I saw the craters and the lava-streams from them down to the sea on the west coast as we steamed along to-day; the lava of the earliest being hardly invaded yet by vegetation—not a blade of green on the later, which runs far out into the sea, like the rough substratum for a big embankment or breakwater. According to native tradition, the last eruption of a kind similar to the present took place from very nearly the same spot in the lake seventy-two years ago, the old people having childish recollections yet. The

¹ The first outbreak was early on the morning of June 10. See NATURE, vol. xxiv. p. 302.

² The principal shock was on Tuesday night, August 31. See NATURE, vol. xxiv. p. 470, and vol. xxv. p. 31.

lake is a great depth, so that this hill of 200 feet or more rising from the bottom represents a vast amount of solid matter, to say nothing of the thick deposits of dust all over the island. The lake was still bubbling in places, and things are by no means settled down yet. At Vavau, where we touched two days ago, they had just had a very severe earthquake, and shocks are still going on at Niua-foou (vertical, *I was told*, but my informant's wits were much shaken by recent events) daily on the level ground near our landing-place, from which it is inferred that the danger is not over. Strong gases too are perceptible rising from the ground near the coast, which is always where they apprehend most danger, and an outburst of lava. I suppose the solid matter coming up through the deep lake is pulverised into the (to life) comparatively harmless dust. During the earthquake of August 12, the captain of a ship at anchor found that, whereas he had paid out twenty fathoms of chain over-night, he had only eight fathoms under him in the morning. I never saw such big coco-nuts anywhere, though the trees are not exceptionally big, indeed there seem to be no very fine or old trees of any kind on the island, which favours the theory of a modern origin, for the soil is very fertile. The name means New Niua, the Old Niua being probably the neighbouring Keppel Island or Niua-tobu-dabu. I wish I could give you a better or fuller and more interesting account of the whole affair, but the visit was a very hurried one, and, in fact, I had not more than two hours on shore. Still it may interest you, as it is written on the very spot: no other account is likely to reach England. I send a pinch of 'sand' from the crater. "C. T."

This "sand" or "dust" is a very dark-brown—almost black—colour. When examined with a lens it seems composed mainly of fragments of glass, and has a slightly speckled aspect, owing to the mixture of lighter and darker fragments; one or two glassy-white fragments may also be noted. When some of the dust is placed under the microscope, it is seen to consist almost wholly of fragments—some rudely polygonal in shape, others flatterish chips—of a brown glass; the former being the commoner. The majority of the bits vary from about .01 inch to .03 inch in diameter, and the latter measurement is but rarely exceeded. Minute chips are also present, but they do not form at all an important constituent in the mass. A conspicuous characteristic is the (apparently) entire absence of the tiny pellets of "cindery" scoria, so frequent a constituent of volcanic dust, and of the fine pulverulent material, the presence of which commonly makes it needful to mount the dust on a slide before it can be properly studied. I have found no difficulty in examining this Niua-fu dust, and even the finer chips—often less than .001 inch in diameter—by simply spreading it over a sheet of glass. The glass fragments, even when very minute, have a tinge of brown: when about .01 inch in thickness, they are fairly translucent, and a rich olive-brown in colour; but as they approach .03 inch in thickness they become opaque, light only passing through the thinner edges. Small cavities, spherical, or egg-shaped, are not infrequent, but the glass is remarkably free from microlithic inclosures. No granulation of the colouring-matter is perceptible, as a rule, with a magnification of 150 diameters; opacite dust and trichites (especially the latter) are very rare; and of other microlithic inclosures I have only seen an occasional lath-shaped crystallite (? feldspar). I have not identified among the fragments either biotite, augite, or hornblende; so that if any of these minerals are present they must be very rare. The clear glassy fragments mentioned above are feldspar—probably labradorite. They do not in number exceed about 2 or 3 per cent. of the whole. Many of the flatter brown-glass fragments exhibit rosy folds or the remains of a cellular structure, evidencing that they are due to the destruction of a very vesicular glass, while the more solid polygonal

fragments may be the detritus of the thicker parts of the same or of a more uniform glass. The strong brown colour of the fragments reminds me of specimens of the more glassy lavas of the Sandwich Islands in my collection; and like them I should, from microscopic examination, consider the rock a basalt-glass (tachylyte) with a silica percentage, which was probably above rather than below 50. This view accords, I find, with Cohen's statement concerning the lava of Niua-fu, which, judging from his description, is very similar to that above described (*Neues Jahrb. für Min.* 1880, vol. ii. pp. 36 and 41); he says that it is almost identical in composition with the "basalt-obsidians" (*i.e.* tachylytes) of the Sandwich Islands. It contains 50.74 of silica; their analyses show from 50.82 to 53.81.

While the above was passing through the press, received from my friend Dr. S. Rideal a determination of the specific gravity of the volcanic material (powdered to get rid of cavities). The specific gravity is 2.726. As the feldspar is included, and it is slightly the lighter, the specific gravity of the glass itself must be a little higher about 2.73. Hence we need not hesitate to call it tachylyte. The average of six Sandwich Island glasses is 2.71 (see Judd, *Q. J. G. S.*, xxxix. 444).

T. G. BONNEY

FOURTH ANNUAL REPORT OF THE FISHERY BOARD FOR SCOTLAND

THE Report of the Fishery Board for Scotland increases each year, not only in size, but in interest for the general public, as well as for those readers whom it specially concerns; and, unlike ordinary Blue-books, its pages are to a large extent devoted to scientific papers which appeal to many not directly concerned with the fishery industry.

The herring-fisheries continue to be most productive. A very striking feature of the summer herring-fishery of 1885 is, that many in-shore grounds, where herring were previously found in great abundance, but which had recently been all but deserted, were restored to their former fertility. The increase of the herring-fishery in the Shetland district, which now ranks as the most important in the country, still continues, greatly to the improvement of the condition both of the people and of their boats. The fish are of finer quality than those taken on other parts of the east coast. The takes of other sea fish and salmon were also very large. The gross total estimated value of the sea and salmon-fishery for Scotland was 2,859,822*l.* 15*s.* The Board have already expressed their regret that so many tons of sprats are annually used as manure. Could they be transmitted to populous districts at a reasonable rate, they would be a cheap and valuable addition to the food-supply, or, where this was impracticable, preserved as anchovies as in Norway, or as sardines as in Canada. The importance of utilising the by-products of the fisheries is now widely recognised. Papers by Dr. Stirling and Mr. Haliburton give an account of certain economical products obtained from fish, and experiments are being made on a fairly large scale by Mr. Sahlström at Aberdeen, which may, it is hoped, lead to some practical results. Investigations on whitebait by Prof. Ewart and Mr. Matthews showed it to consist almost entirely, and at all seasons, of young sprats and young herrings, varying according to the season of the year and the place of capture. It might, therefore, be advantageous for the Firth of Forth and other in-shore waters to send supplies of whitebait to the English markets.

The Scientific Committee of the Board had the assistance of Mr. Brook, Prof. Stirling, and Mr. Duncan Matthews, of Aberdeen; Prof. McIntosh, of St. Andrews; Prof. Greenfield and Dr. Gibson, University of Edin-

burgh; the Rev. A. M. Norman, D.C.L. of Durham; and Mr. Haliburton, of University College, London. Though the Marine Laboratories at Tarbert and St. Andrews admitted of several important inquiries being initiated, the Board is still greatly hampered for want of proper boats, and throughout the year the limited amount of dredging and field-work done was rendered possible by boats supplied by Prof. Ewart. It is to be hoped that arrangements will be made by the Admiralty, which will admit of the superintending vessels undertaking a complete survey of the spawning-banks and assisting in work of a like nature when required. A small steamer has already been provided for trawling experiments and other work on the east coast. At the Rothsay Aquarium the spawning of the cod was studied by Prof. Ewart and Mr. Brook, who generally confirmed the observations of Sars, and gained further information as to the natural and artificial fertilisation of the eggs, and their buoyancy before and after fertilisation in different kinds of water. The appendix contains part ii. of a paper by Mr. Brook on the development of the herring. Experiments made in artificial fertilisation of herring eggs appear to justify the following conclusions:—

(1) The ova retain their vitality, and are capable of being fertilised from forty to forty-eight hours after the female is dead. In the experiments performed, forty-eight hours seems to be a little outside the limit at which the eggs are capable of being fertilised, but it is probable that temperature may have an influence on the vitality of the ova. (2) The spermatozoa do not retain their vitality for nearly so long a period. Three hours appears to be the limit indicated by the above experiments. (3) The egg capsule never separates from the yolk excepting under the influence of spermatozoa. It would appear that when the ova and spermatozoa have partly lost their vitality a partial separation of the egg membrane from the yolk may take place, although the ovum is not truly fertilised. Experiments proved conclusively that the egg capsule is not permeable to water until after it has been penetrated by spermatozoa. (4) The egg membrane is covered with a viscous secretion when the ovum leaves the oviduct, which serves for the attachment of the ovum. This viscous layer gradually hardens in sea-water. Active spermatozoa are able to penetrate this layer some hours after it has set, but this power appears to be confined to the first twenty-four hours after deposition. (5) There is no collection of germinal protoplasm at the surface of the yolk in the ripe ovarian ovum, nor is a germinal disk ever found so long as an ovum remains unfertilised. The formation of the germinal disk cannot be made out in living ova, and its true nature can only be determined from a study of sections. Investigations on the formation of the blastoderm, and examination of a large number of sections, lead to the conclusion that the animal pole of the ovum gives rise to the ectoderm. In many forms the animal pole at the time of the formation of the segmentation cavity consists only of true archeblast cells. In the herring, and probably some other forms, the animal pole receives an addition of cells from the parablast prior to the formation of the segmentation cavity. The primitive hypoblast, which is almost entirely derived from the parablast (*i.e.* from the vegetative pole), gives rise to the mesoderm, and the secondary hypoblast (endoderm) remains as a single row of cells in connection with the parablast.

If these conclusions are correct, the similarity between the development of teleosts and amphibians (*Rana*) cannot fail to be noted. The derivatives of the animal and vegetative poles are in both cases practically identical. The secondary segmentation (budding) in the parablast of teleosts must then be regarded as the necessary consequence of the relative distribution of protoplasm and yolk in the vegetative pole. The primitive hypoblast, as here described for the herring, is precisely homologous

with that of Amphioxus. In both cases the primitive layer gives rise to mesoderm, notochord, and true endoderm. The position here brought forward is one advocated by Mr. Brook over a year ago, but from the nature of the material then at his disposal he failed to observe the details of the process. Quite recently, Dr. Ruckert, who has been studying the behaviour of the parablast in Elasmobranchs, has come to conclusions practically identical with those here advocated for Teleosts.

The question, "Are herring ova likely to develop normally on the deep off-shore fishing-banks?" is discussed by Prof. Ewart in a way which shows that the Board aims at practical results as much as mere scientific investigations.

Until comparatively recent years nearly all the herring taken in summer were captured by small boats within a few miles from the shore. In 1852, *e.g.*, immense herring shoals reached the Moray Firth to spawn on the Guillam and other in-shore banks. Since 1852 the fishing boats have greatly increased in size, and owing to the introduction of cotton nets, each boat has added greatly to its catching power.

As the boats have increased in size and sea-worthiness, the fishermen have proceeded farther and farther to sea in search of the herring shoals, and now the greater number of the herring are taken from forty to sixty miles from the coast. It is often alleged that it was owing to the herring deserting the in-shore grounds that the fishermen proceeded to sea in search of the shoals, and also that it is because the fishermen disturb and break up the shoals early in the season that they no longer or seldom visit their old spawning-grounds. There is no doubt that during the last fifteen years comparatively few herring have been captured during the summer over the in-shore banks of the Moray Firth; but whether this is the result (as is alleged) of the fishermen intercepting and breaking up the shoals before they have had time to reach the in-shore ground it is impossible to say. It is, however, a question of great interest, and one which could in all probability be easily settled. If the fishermen were to refrain from fishing for one year in the various districts along the east coast until the fish had reached maturity, this problem would most likely be solved. In all probability the herring would be found as abundantly as in former years in the in-shore waters, and the fish captured would be larger and riper than those taken early in the fishing-season of former years from the corresponding shoals.

That the takes during recent years have consisted chiefly of small fish (so-called maties), will be evident by a reference to Reports of the Fishery Board. It is generally admitted that the great depression of the fishery industry which now prevails would, to a great extent, have been prevented if half of the small herring (the maties) had been left in the sea. Many of those who account for fewer herring being captured in-shore, by saying it is impossible for them to run the gauntlet of the thousands of nets that are night after night drifting across their path, assert that the eggs are incapable of developing in deep water, and that in course of time the off-shore shoals will diminish or disappear. Of this there is in the meantime no evidence. As a matter of fact, for all we know there may have been immense shoals of herring spawning on the banks which lie at a distance of from thirty to sixty miles off the Scottish coast for centuries.

The existence and continuance of off-shore shoals will, to a great extent, depend on whether the herring are able to reproduce themselves without visiting the in-shore spawning-banks, and the success of the herring industry will depend on whether the herring shoals, which are invaded annually by our fishing fleet, continue to spawn sufficiently near the coast to render their capture a profitable enterprise for our fishermen. For this it is necessary to have large shoals moving in limited areas, and these are only found on the east coast during the

winter and summer spawning-seasons. If herring ova are capable of hatching in deep water (say from 60 to 100 fathoms) it may be taken for granted that any of the many gravel-coated banks of the North Sea may serve as spawning-beds. The North Sea is remarkably shallow, there being only one small area near our shores (generally known as the "Pot," and lying two to five miles off Fraserburgh), where a depth of 100 fathoms is reached. The most certain way of proving whether herring ova hatch or not in deep water would be to dredge herring spawn from one of the off-shore banks in an advanced stage of development; but, after several unsuccessful attempts to do this, it occurred to Prof. Ewart that the question might be practically settled by depositing fertilised eggs in specially constructed hatching-boxes in deep water. This was done in the "Pot," but without result, as a storm swept away all traces either of buoys or boxes. The Moray Firth being in many respects unsuitable for this experiment, Prof. Ewart turned his attention to the West Coast, and found a comparatively sheltered spot in Loch Fyne, with a depth of 104 fathoms. To insure success, a small tank was constructed of thick slate slabs firmly bound together by iron rods. The tank, though only about 20 inches square, weighed nearly 2 cwt. In the top and in two sides of this tank small windows were made about 6 inches square. Each window was carefully fitted with a teak frame, across which a single layer of horsehair cloth was stretched. These windows admitted a sufficient current of water to pass through the tank. All the necessary preparations having been made for depositing the tank during last autumn. Mr. Brook, who was engaged at the Fishery Board Tarbert Station during the autumn, undertook to obtain eggs and superintend the sinking of the tank in the 100-fathom water. Eggs were obtained on September 11 from herring caught in Kilbrannan Sound in water varying from 8 to 12 fathoms. All the eggs were placed at first in the laboratory in water which had an average temperature of 54° F. Most of the eggs kept in the laboratory hatched out on the 19th, while others only hatched on the 24th, thirteen days after fertilisation. On the 16th, one of the glass plates, coated with eggs, was introduced into the tank above mentioned, which was immediately conveyed to the middle of the channel, and deposited in 98 fathoms water, about three miles off Tarbert. The surface temperature was 54° F., the bottom temperature was 49° F. The bottom around the tank was chiefly composed of mud. On the 24th—i.e. thirteen days after fertilisation, and eight days after the eggs were deposited in 98 fathoms water—the tank was raised. On examining the glass plate, it was found a number of the eggs in the centre had been destroyed by a fine coating of mud, which had entered through the hair-cloth screen, while those near the margins contained vigorous embryos almost ready to hatch; in a few cases hatching had taken place. The average bottom temperature while the eggs were deposited was 49°·3 F.; the average surface temperature, 54° F.,—the difference being 4°·7. The difference of 4°·7 during the eight days which the eggs were deposited delayed hatching for about five days. This experiment clearly shows that the only difference between the hatching of herring ova in deep and shallow water is one of time; hence we are safe in concluding that if herring deposit their eggs on suitable ground, in any depth of water not exceeding 100 fathoms, they will undergo development. It is conceivable, however, that the depth of the water in which the eggs are deposited may have some influence on the time of spawning—in other words, on the fishing-season; and the immature condition of the fish caught in August during recent years may to some extent be accounted for in this way. If the herring which formerly spawned on the in-shore banks of the Moray Firth in from 10 to 20 fathoms water now spawn off-shore in from 40 to 60 fathoms water, the hatching will be delayed for

several days, and maturity will not be reached as early as formerly. This is an argument in favour of beginning the herring-fishing later in the season than at present. It may be objected that the fry, if hatched out in deep water, would never succeed in reaching the surface; and supposing that they could, the necessary food might not be found forty to sixty miles from shore. Observations, however, show that the young herring are likely to have little difficulty in ascending 200 fathoms before the yolk-sac is exhausted, and that though no one is yet well acquainted with the food of the fry, there can be no doubt about the richness of the surface fauna beyond even the fifty-mile line.

In the Report for 1883, Prof. Ewart called attention to the fact that the German Commission had arrived at the conclusion that the Baltic herring differed sufficiently from the North Sea herring to be worthy of being considered a special variety. It has long been held by fishermen and others that each district has its own peculiar variety. From some 500 specimens examined in 1883, no evidence of the existence of such varieties was found. In order to settle this question finally, Mr. Duncan Matthews has been examining, for a considerable time, samples of the herring captured around the Scottish coast, and now communicates an important paper on this subject. The method of investigation adopted was to take accurate measurements of the length of the head, and of the caudal, dorsal, and anal fins, to note the position of the fins on the body, &c., and, by a comparison of these data with the length of the body, to ascertain the amount of their actual variation, and especially whether these variations were so constant in the herrings of any one or more localities or seasons as to indicate a distinction of races. From this inquiry it seems that there are as large herring now as there were some generations ago, and that, although each district yields large herring, the north-east coast has a slight advantage in this respect over the south-east and west coasts. A table giving the size, &c., of the largest fish examined includes representatives from every fishery district, and shows that there is no practical difference in size between the male and female, nor in the numbers of each of these which were taken. The winter fish are found to be rather larger than those taken in summer, while among the fish commercially termed "maties" there are (1) immature herring, i.e. herring which, in addition to being small in size, have undeveloped milts or roes; (2) small herring in all degrees of ripeness up to maturity; (3) small herring which have spawned—small "spent" herring. Hitherto, the size of the fish, rather than the sexual condition, has apparently determined whether the term "matie" should be applied. In the same districts, and even in the same shoals, large sexually immature herrings are often found along with small ripe, or nearly ripe, herring; hence herring appear not only to vary in size in their fully adult condition, but also to vary in the size at which they reach sexual maturity. It is pointed out that these results, as well as the fact that the undivided ova vary in size in ratio to the size of the fish, are likely to cause considerable variation in the progeny which result from the interbreeding of fish of varying size and age. Of the fish caught in the early part of the season, a much larger proportion are immature and small, and probably also younger than is the case later on. The adult fish appear to reach a more advanced stage of ripeness before they approach the spawning-banks. From the measurements made, it is shown that the length of the head varies considerably the extremes being found in herrings of all localities and both seasons, the percentage with the larger size of head being rather greater among the winter than the summer herring; but this difference, like that of the total length, is considered insufficient to prove a racial distinction. The position of the centre of the dorsal fin in a majority of the winter herrings is anterior to the centre of the

body, whereas among the summer herrings a large percentage have it behind the centre. In the immature fish, however, the fin-centre is generally anterior to the body-centre. The anal and pelvic fins show a corresponding difference in position. As regards the pelvic fin, however, this condition is limited to the adult and larger young herring, the pelvic fin being found, like that of the sprat, anterior to the dorsal fin in young herring below 60 millimetres in length. The pectoral fin varies very slightly in its relative position on the winter and summer herring. The relative basal length of both the dorsal and anal fins conveys no indication of racial distinction between the summer and winter fish. The dorsal fin is in all the herrings generally longer than the anal; only about $1\frac{1}{2}$ per cent. of the summer herrings, and $7\frac{1}{2}$ per cent. of the winter, having the anal fin longer than the dorsal. Further details are given respecting the number of fin-rays, keeled scales, circumstances of spawning, &c., but which scarcely affect the question of racial distinction. The inquiry, so far as it has gone, tends to prove that there is no racial distinction between the herrings found in the various localities around the Scottish coast. Judging, however, from the more backward position of the dorsal pelvic and anal fins, the doubtfully smaller head, and the slightly lesser size of the summer herrings, more minute inquiries may indicate a slight difference between the winter and summer herrings.

Mr. Brook reports on the herring-fishery of Loch Fyne and the adjacent districts during 1885, and under his "Ichthyological Notes" gives a short account of the rare fishes met with during the year.

Naturalists and fishermen alike have long felt the absence of accurate information as to the spawning period of fishes. In order to have a basis on which to found further investigations, Mr. Brook has prepared a provisional list of the spawning period of various food-fishes. This list brings out the great lack of accurate information on the subject, but gives an idea of the opinions as to the spawning periods held by fishermen and others around our coast. These opinions are in many cases conflicting, and in most cases they will require to be altered. Prof. McIntosh contributes an account of the work undertaken at St. Andrews since the last Report, including notes on the eggs and young of fishes studied during the past year. Recently considerable attention has been devoted by Mr. Wilson to the development of the common mussel, and an account of his investigations up to the present time will be found in the appendix. During the summer and early autumn several attempts were made to fertilise the eggs artificially at St. Andrews. The early stages of development were studied from ova obtained in this manner, while the free-swimming embryos were frequently obtained in pools amongst the mussel beds in the Eden and in other localities. In the Board's last Report it was mentioned that Prof. Greenfield had undertaken to investigate the lower organisms met with in some of our more important salmon-rivers. This investigation has been advanced a step, and numerous forms have been isolated and cultivated by the methods previously described.

Mr. Brook and Mr. Calderwood give the further results of examination of the food of these "useful" fishes, the herring, the cod, and the haddock. Mr. Calderwood also sends notes on the Copepods of Loch Fyne, and on the Greenland shark; Canon Norman reports on a Crangon, some Schizopoda, a member of the order Cumacea, new to, or rare in, the British seas; Dr. Stirling, on red and pale muscles in fishes, and on economic products from fish and corresponding vegetable products; Mr. Haliburton, on the blood of *Nephrops norwegicus*; Dr. John Gibson, on physical observations made for the Fishery Board in the Moray Firth during the autumn of 1883.

Ten plates accompany the appendix. It is greatly to

be regretted that the Board has not yet been able to survey some of the fishing-banks, more especially those which are supposed to extend along the western shores of the Hebrides, and that the part of the Report dealing with scientific work is not published separately.

THE ELECTRIC CHARGE ON THE ATOM

ALTHOUGH considerable attention has been given of late to electrolysis and the subjects connected therewith by English chemists, more especially since the Helmholtz Faraday Lecture of 1881, yet some of Prof. Helmholtz's deductions from Faraday's experiments have been curiously neglected.

I refer more especially to the bearing of the facts on the true nature of valency, and I purpose in this paper to point out one or two fairly obvious consequences which follow from the results of Faraday's researches, but which have not, I believe, been stated before.

Prof. Helmholtz has shown that it follows from Faraday's experiments on electrolysis that while a monovalent atom carries to the electrode one charge of electricity a divalent atom carries two charges of electricity. For instance, when we electrolyse potassium chloride, we have each potassium atom delivering a charge of electricity at the one electrode, and each chlorine atom delivering an equal charge of electricity at the other electrode, all monovalent atoms, carrying with them an equal charge of electricity, which we may call the unit charge.

When, however, we electrolyse magnesium chloride, we have two atoms of chlorine set free for one of magnesium, and consequently while each chlorine atom carries its unit charge with it, the magnesium atom carries two units of electricity to the electrode. In fact electrolysis proves that differences of valency mean differences in the electrical charge on the atom. All this is so familiar to us now that I have perhaps repeated it at unnecessary length.

But we have many elements which vary in valency. For instance, copper is capable of forming two series of compounds, in one of which it is monovalent, and in the other divalent, that is, in one of which the copper atom carries one unit charge of electricity, and in the other carries two units of electricity.

We are able, then, under certain conditions to alter the electrical charge on an atom, increasing it by some simple multiple.

There are therefore a special group of chemical reactions, such as the oxidation of the cuprous salts, in which we have not merely combinations between two or more substances, or ordinary double decomposition, but in which, besides such changes, an additional electrical charge is given to, or removed from, an atom. I think it follows from this that all such reactions are of very special interest, and deserve careful study.

For instance, take the case of the saturation of an olefine by chlorine. We must look on this reaction from one of two points of view. Either on the addition of chlorine an additional charge is supplied to the carbon atom, in which case by-products of less saturation are probably formed; or the carbon atom is already fully charged, in which case the double bond is not merely a shorthand statement of a possible reaction, but expresses a physical fact.

There is also another point worthy of note in connection with this addition of electricity to the atom. If we take the case of the two copper chlorides—cuprous and cupric chloride—we find that their heat of formation per chlorine atom is not very different. Now it is well known that the heat of formation of a salt approximates to the heat of formation as calculated from the electromotive force developed when that salt is formed in a voltaic cell.

To put this in other words, we can obtain from the heat of formation of cuprous chloride, or of cupric chloride, an approximate calculation of the difference of electric potential between the copper atom and the chlorine atom in the two salts.

Now, as already stated, the heat of formation per chlorine atom is nearly the same; that is, the difference of potential between the copper and chlorine is nearly the same in both salts. What follows from this?

It follows that, in doubling the electric charge on the copper atom, the potential is not also doubled. This means, therefore, that the capacity for electricity of the atom is increased at the same time. This conclusion is not quite certain, as our information is still too scanty on the actual differences of potential in the case of these two salts; and, further, we do not know what fraction of it belongs to the chlorine atom; but, on the whole, the facts we have point to the above conclusion, and it is at any rate a subject well worthy of study to determine whether the capacity of the atom for electricity can vary or not.

Passing from this, I wish to point out another very obvious but nevertheless important deduction to be made from the facts of electrolysis.

We have recognised that the difference between monovalent and divalent copper consists in the doubling of the charge upon the atom. This again may be due to some profound change in the atom itself, but it is at any rate the obvious and marked distinction; we have copper in both cases, but double the electrical charge in one case over that in the other.

If we searched among the elements, could we find two series of salts more completely different in their nature and properties than the cuprous and cupric salts?

I venture to say that, if we did not know we could derive the same element from both, we should assume them to be derived from two different elements, and assign them very different places in Mendelejeff's table. Many other examples of the same thing will occur to everybody, namely, that alteration of the electrical charge on the atom is accompanied by profound alteration in the nature of its compounds, and is therefore probably the cause of this alteration.

Up to this point I think my deductions are fair and obvious deductions from the facts of electrolysis. I wish now to suggest a possibility, I can call it no more, which if true will considerably alter our views of the facts of chemistry. We have found the importance of alterations of electrical charge in altering the properties of an atom as shown in its compounds.

We already believe that variations in atomic weight are closely allied with the variations in the properties of the atom as shown in its compounds.

Are there, then, two things which condition the chemical properties of an atom, or is there only one?

Let us look again for an instant at the facts of electrolysis, and let us take the electrolysis of hydrochloric acid as our example.

At present we state the facts thus:—Every molecule of hydrochloric acid consists of one atom of chlorine and one atom of hydrogen, the chlorine atom weighing 35.5, the hydrogen atom weighing 1. On passing a current, each molecule is split into these two atoms, each atom carrying a unit charge of electricity.

Is it not just possible that we may some day state the facts thus:—A molecule of hydrochloric acid consists of one molecule of hydrogen weighing 1 combined with 35.5 molecules of chlorine each weighing 1. On electrolysis, the chlorine atoms are split from the hydrogen atom, the chlorine atoms each carrying unit charge of electricity, and the hydrogen atom carrying 35.5 charges of electricity.¹

If this is the truth, then all the atoms of the elements are of the same weight, and probably are made of

¹ No one need quibble about the 35.5.

the same "stuff," and we have two, and only two, things which condition the properties of the atom—namely, its electrical charge and its electric potential, and Mendelejeff's table becomes a statement of the periodic relationship between these.

In suggesting this vague possibility, I do not wish to obscure the first part of the paper, which consists, I believe, of perfectly legitimate deductions from the facts of electrolysis.

I have purposely avoided giving many examples, as I have been dealing with such familiar and common-place chemical reactions that plenty of examples will at once occur to every reader; and sufficient has, I think, been said to show at any rate the importance of experimental inquiry into this subject, and the probability of considerable modifications of our views of chemical facts in the near future.

The new way of looking on valency, which we owe to Prof. Helmholtz, may, as I have already pointed out, completely alter our conception of the nature of an unsaturated carbon compound, and of the process by which saturation takes place; and probably as investigation proceeds in this department it will become necessary to re-dissolve our chemical facts and crystallise them out in completely new mental concepts, while doubtless the ideas associated with the graphic formula pass away and leave not a wrack behind.

A. P. LAURIE

MUSIC AND MATHEMATICS

YESTERDAY afternoon meeting at a friend's house a lady visitor to Oxford who was to sing that evening at one of the hebdomadal concerts in Balliol College, and the conversation happening to turn on the gifted mathematical lady Professor in the University of Stockholm, my thoughts shaped themselves, as I was walking home, into the following lines, which, if likely to interest any of your readers, I shall be happy to see appear in the world-wide-diffused columns of NATURE.

New College, November 15 J. J. SYLVESTER

SONNET

To a Young Lady about to sing at a Sunday Evening Concert in Balliol College

Fair maid! whose voice calls Music from the skies
Weaving amidst pale glimpses of the moon
Tones with fresh hues of glowing fancy strewn
And soft as dew that falls from pitying eyes—
Let from their virgin fount those accents rise
That bid sad Philomel suspend her tune,
Thinking the lark doth chant his lay too soon—
Whose else that trill which with her own note vies!
To her whose star shines bright o'er Maelar lake
And thee who beautif'ist glad Isis' shore
Grant! I one joint harmonious garland bind:
Thou canst with sounds our senses captive take—
She the true Muse, fond poets feigned of yore,
Strike Heaven's own lyre, Nature's o'er-ruling mind.

NOTES

MR. HAROLD B. DIXON has been appointed Professor of Chemistry and Director of the Chemical Laboratories at Owens College, Manchester.

THE *Oxford Magazine* announces that Prof. Burdon Sanderson and Mr. Gotch are going to spend their Christmas vacation at Arcachon, where there is awaiting them a large tank full of torpedoes. It looks forward with interest to the publication of the results of the Oxford physiologists' holiday, remarking that "to the research will be added the pleasing excitement of danger; for if incautiously handled these torpedoes will give the physiologist a shock, compared with which the agonies of scores of vivisected rabbits are as nothing." Of course this is not true.

WILLIAM FAWCETT, one of the assistants in the Department of Botany in the British Museum, has been appointed the Secretary of State for the Colonies to the post of Director of the Public Gardens and Plantations in Jamaica.

THE Uralian Society of Natural Sciences is arranging to hold a Scientific and Industrial Exhibition of Siberia and the Ural Mountains in 1887, at Ekaterinburg. The Exhibition promises to be of great scientific interest, including sections of geology, botany, zoology, anthropology, and archaeology. The anthropology especially will be of the most comprehensive character. It will include a certain number of families of khirs, Kirghizes, Vogones, Ostiaks, Samoiedes, and other half-civilised peoples of Siberia, with their dwellings, and appliances for hunting and fishing, besides models, figures, costumes, &c. There will also be a large collection of prehistoric

The grounds around the Exhibition building will be utilised to give a fairly accurate idea of the arborescent vegetation of the countries represented. Delegates from foreign Societies intending to visit the Exhibition will be accorded travelling privileges, and be received with the greatest hospitality. The Exhibition will be open from May 27 to September 27. The President of the Society is General Ivanoff, and the President of the Exhibition Committee M. A. Niclowsky.

MR. ARTHUR GROTE died on the 4th inst. at his residence in Dvignon Square. He was born in 1814. He was a Fellow of the Royal Society and also of the Linnean Society. Mr. Grote wrote a number of papers on subjects connected with geology and natural history, and contributed an introduction to Hewitson's "Descriptions of New Indian Lepidopterous Insects the Atkinson Collection." He was engaged for many years Her Majesty's Indian Civil Service.

MR. W. GALLOWAY writes with reference to the recent explosion at Elemore Pit:—"Elemore Pit is one of the Heeltan group of collieries near Newcastle-on-Tyne, which are accounted to be amongst the best and most carefully managed mines in this or any other country. It is under the direct supervision of Mr. Lindsay Wood—a member of the late Royal Commission on Accidents in Mines. The workings are dry and dusty; no accumulation of gas was known to exist anywhere; a shot is supposed to have been fired at the moment the explosion took place, for shot-firing was going on. The explosion appears to

have ascended up the downcast shaft, or, in other words, to have traversed a region filled with fresh air without any admixture of fire-damp. These features of this and other similar explosions of late appear to militate somewhat against the views expressed in the Report of the Royal Commission on Accidents in Mines, to the effect that coal-dust alone was a comparatively harmless agent in the presence of fire-damp."

THE following are the arrangements for the lectures before to be given at the Royal Institution:—Prof. Dewar, six lectures (adapted to a juvenile auditory) on "The Chemistry of Light Photography"; Prof. Gamgee, eleven lectures on "The Function of Respiration"; Prof. Rücker, five lectures on "Molecular Forces"; Prof. Max Müller, three lectures on "The Science of Thought"; Mr. Carl Armbruster, five lectures on "Modern Composers of Classical Song"; and Lord Rayleigh, six lectures on "Sound." The following are the probable arrangements for the Friday evening meetings before Easter:—Mr. William Thomson, on "The Probable Origin, the Total Amount, and the Possible Duration of the Sun's Heat"; Mr. Baldwin Spencer, on "The Pineal Eye in Lizards"; Mr. John H. P. Freshfield, on "Some Unpublished Records of the City of London"; Mr. E. B. Poulton, on "Gilded Chrysalides"; Mr. W. Crookes, on "Genesis of Elements"; Capt. Abney,

on "Sunlight Colours"; Mr. V. Horsley, on "Brain Surgery in the Stone Ages"; Archdeacon Farrar, on "Society in the Fourth Century A.D."; Mr. G. J. Romanes, on "Mental Differences between Men and Women"; and Lord Rayleigh, on "Colours of Thin Plates."

AN Edinburgh Correspondent writes:—"Mr. Romanes has just delivered his first course of lectures on the Philosophy of Natural History to a large and appreciative audience, including students from all the Faculties in the University of Edinburgh."

THE Minister of French Postal Telegraphy has sent to Brussels a delegate to arrange for establishing a telephonic line between Paris and that city. The price for the use of the telephone will be five francs for a period of five minutes. It is the first step on record towards an international telephonic system.

A REMARKABLE fire-ball was seen at Stonyhurst College, Blackburn, on December 4, at 9.16 p.m. Although the moon was shining brightly, it lit up the sky like a brilliant rocket. Its course was from 27 Lyncis to θ Gemini, and as it advanced it left a fine streak behind it. Its colour was a bluish-white. At first it moved swiftly, then more slowly, and, before vanishing, burst into several fragments. There was no streak left where the meteor burst, but only in the first part of its course. It was like a horse-tail cirrus, the bushy portion surrounding the star 27 Lyncis, and thence extending in a narrower streak about 3°. It remained visible for one minute and a half, the part last to fade being that about 27 Lyncis.

WE have received the last number (part 2, vol. iv.) of the *Proceedings* of the Liverpool Geological Society. The presidential address by Mr. Mellard Reade, "On the North Atlantic as a Geological Magazine," is a continuation of the line of investigation sketched out by him in his previous address, which was entitled "Denudation of the two Americas." The papers deal mainly with the geology of Liverpool and the neighbourhood, especially North Wales. A paper by the Secretary, Mr. W. Hewitt, "On the Topography of Liverpool," must be specially interesting and instructive to those acquainted with the present geography of that great city.

THE active volcano, Asamayama, appears to be attracting particular attention just now in Japan, probably because it is the loftiest mountain in the country which is in a constant state of activity, and also because it is the nearest to the capital, and is situated in a district long famous for its health resorts. A few weeks since we referred to an anonymous account of the crater, published in the *Japan Weekly Mail*, but a much more careful sketch of it is given by the Japan Correspondent of the *Times* in a letter published recently in that journal. The roar of the volcano, on approaching the edge of the crater, he describes as not unlike the noise produced by the passage of a train across a bridge under which one is standing. There was no shaking, however, but loud hissing and bubbling constantly proceeded from numberless vapour-jets in the inner face of the crater-wall, from its rim downwards. The crater is a rough oval in shape, but the estimates of its size are most conflicting. The Japanese give the circumference as four miles, but this is simply a wild guess. A German explorer set down the diameter at 1100 yards, and an English mathematical professor put it at only 200 yards, "divergences that will illustrate the mental confusion to which some men are liable when in the presence of dread natural phenomena." The writer himself estimated the circumference at 1056 yards, by walking round the windward half of it—it was impossible to pass through the vapours on the lee side—which was accomplished in six minutes, at the rate of about three miles an hour.

ON the very interesting question of the depth of the crater—that is, the depth from the mouth to the surface of the molten

matter—opinions vary almost as hopelessly as on the size. No doubt the "vast clouds of the most pungent sulphurous steam," which are described as rising swiftly out of the caldron, render exact observation difficult. The *Times* Correspondent speaks of catching glimpses of the crater-wall at depths which a very moderate estimate would place at 300 feet. But the gradual convergence of the cavity apparent at this depth forbids the acceptance of the enormous profundity for which some visitors have contended, and suggests that the depth can hardly much exceed 500 feet. After a weird description of the appearance presented to the spectator by the volcano at work, the writer concludes by remarking that the present crater is apparently the youngest and innermost of three. Further down on the south west side are to be seen, along with numerous fissures of unfathomable depth, remains which point to the existence of two former craters, concentric and of large dimensions, and separated from one another by a considerable interval. Possibly the existing cone was formed by the great eruption of 1783.

A TELEGRAM from New York of December 2, states that eight slight shocks of earthquake are reported from Sammerville, one severe shock from Columbia, and two slight ones from Charleston. No damage was caused. Dr. Forel writes that earthquakes were felt in Switzerland on November 25 at 3h. at Pontresina and Bernina (Grisons), and again at 3h. 53m. (both Greenwich times) at Pontresina.

ACCORDING to the *Ceylon Observer*, Mr. C. Stevens, a naturalist, has returned to Colombo from a most successful and interesting sojourn amongst the Veddahs, whose district he has thoroughly explored, and with whom he was enabled to establish a closer intimacy than any European ever did before. He has been able to clear up a good many dubious points relating to the manners, customs, and religious beliefs of these veritable wild men of the woods. He has succeeded in obtaining several perfect skeletons, and a number of skulls.

THE *London and China Telegraph* states that a Folk-Lore Society has been established in the Philippines, at the prompting of a Society for the study of folk-lore in Spain. The archipelago certainly presents a wide field for investigation and inquiry in this respect, on account of the diversity of native races inhabiting it. The survivals in the shape of traditions, customs, and observances amongst the primitive tribes still to be found in the inaccessible interior of many of the islands may be expected to throw much light on the early history of the people, and on the origin of many superstitious practices common in more civilised lands.

THE Report of the Public Free Libraries of the City of Manchester, while expressing the deep regret of the Committee at the loss of Sir Thomas Baker, their chairman for nearly twenty-five years, is at the same time a testimonial to the ability and judgment with which the work under his care has been carried on. Additional libraries, a tenfold increase in circulation since the two first of them were opened, and over 4000 volumes withdrawn this year as worn out, are proofs of the earnestness of this work. Nor does the increase seem likely to cease, for the extension of the time of keeping open the reading-rooms till 10 o'clock, although it adds to the already long hours of those engaged in their management, is sure, we think, to increase their counter-attraction to the public-houses, and to bring up the number of visitors annually to the libraries to three millions. Two recently incorporated districts also have requested that equal advantages may be extended to them, and help in carrying this out has been liberally supplied by independent public bodies. A remarkably large proportion of books are taken out to be read in the reading-rooms. Boys especially avail themselves of these rooms on a Sunday, nearly twice as many of

them attending then as on a week-day; a direct reversal of the practice of other classes. The success of Manchester is the more marked that so moderate a proportion of fiction is supplied to its readers.

THE additions to the Zoological Society's Gardens during the past week include two Macaque Monkeys (*Macacus cynomolgus* ♂ ♀) from India, presented by the Countess Dowager of Lonsdale; a Mona Monkey (*Cercopithecus mona* ♀) from West Africa, presented by Miss Bashall; a Domestic Sheep (*Ovis aries*, var.) from West Africa, presented by Sir Albert Kaye Rollitt, F.Z.S.; a Grey-striped Mouse (*Smithus vagus*) from the Tatra Mountain, presented by Dr. A. Wryesniowski; a Poë Honey-eater (*Prothemadira nove-zealandie*) from New Zealand, presented by Capt. B. J. Barlow, s.s. *Taimu*; a Blue-fronted Amazon (*Chrysotis astiva*) from Brazil, presented by Miss Joachim; two Tuatera Lizards (*Sphenodon punctatus*) from New Zealand, presented by Dr. E. B. Parfitt; a Cerastes Viper (*Vipera cerastes*) from Egypt, presented by Mr. J. H. Leech, F.Z.S.; a Beisa Antelope (*Oryx beisa* ♂) from North-East Africa, a Rough Fox (*Canis rufidis*) from Guiana, purchased; and a Red Kangaroo (*Macropus rufus*), born in the Gardens.

OUR ASTRONOMICAL COLUMN

CORRECTIONS TO REFRACTION TABLES.—Prof. Cleveland Abbe, in a short note to the *Astronomische Nachrichten*, calls attention to the fact that the reading of the mercurial barometer which is used in the refraction-formula as an index to the density of the air is not a true index to the pressure controlling that density until it is corrected for the effect of the variations in gravity. The correction is accomplished by adding one more factor, g , for gravity, when the formula becomes—

$$R = a \tan z \left(\frac{1 - 0.00259 \cos 2\phi}{1 - 0.00259 \cos 2\phi_0} \text{BT} \right)^{A, \lambda},$$

where ϕ is the latitude of the observer, and ϕ_0 of the station for which the tables were computed. Prof. Cleveland Abbe considers that the omission of this correction for gravity may partly explain the origin of small systematic differences in the declinations of different star-catalogues, though such differences, so far as they are due to refraction, must also be caused by local irregularities in the distribution of pressure and temperature, which produce effects equivalent to slight inclinations of the horizontal planes of equal density. The systematic changes in his distribution, due to change of season, must introduce an annual variation in refraction similar to the effect of parallax, and it will occasion a difference in the refractions north and south of the zenith, which may often attain an appreciable amount.

COMET FINLAY (1886 e).—The following ephemeris by Dr Krueger, for Berlin midnight, is in continuation of that given in NATURE of November 25 (p. 85):—

1886	R.A.			Decl.	log r	log Δ	Brightness
	h.	m.	s.				
Dec. 10	22	24	49	13 25.6 S.	0.0074	9.8941	3.1
14	22	23	51	11 9.7	0.0142	9.8909	3.0
18	22	44	58	8 46.0	0.0221	9.8901	2.9
22	23	6	0	6 16.7	0.0309	9.8917	2.8
26	23	26	49	3 44.6 S.	0.0404	9.8958	2.6

The brightness at date of discovery is taken as unity.

COMET BARNARD (1886 f).—This object is now visible to the naked eye, and is at its brightest. As it is now visible in the early evening, it should be frequently observed. The following ephemeris by Dr. Aug. Svedstrup, for Berlin midnight (*Astr. Nachr.*, No. 2756), is in continuation of that given in NATURE of November 25 (p. 85):—

1886	R.A.			Decl.	log r	log Δ	Brightness
	h.	m.	s.				
Dec. 11	17	6	7	16 20.9 N.	9.8266	0.0004	24.7
16	17	54	19	13 43.9	9.8212	0.0300	22.1
21	18	34	18	10 32.2	9.8266	0.0679	18.0
26	19	6	32	7 13.7	9.8421	0.1084	14.0
31	19	32	32	4 5.2 N.	9.8652	0.1478	10.5

The brightness at date of discovery is taken as unity.

ASTRONOMICAL PHENOMENA FOR THE WEEK 1886 DECEMBER 12-18

FOR the reckoning of time the civil day, commencing at Greenwich mean midnight, counting the hours on to 24, here employed.)

At Greenwich on December 12

in rises, 7h. 59m.; souths, 11h. 53m. 58'.os.; sets, 15h. 49m.; decl. on meridian, 23° 6' S.: Sidereal Time at Sunset, 21h. 14m.

moon (one day past Full) rises, 16h. 34m.*; souths, oh. 29m.; sets, 8h. 27m.; decl. on meridian, 18° 57' N.

Planet	Rises		Souths		Sets		Decl. on meridian
	h. m.	h. m.	h. m.	h. m.	h. m.	h. m.	
Mercury	6 15	10 43	15 11	18 3	18	3	S.
Venus	8 12	12 4	15 56	23 30	23	30	S.
Mars	10 10	14 6	18 2	23 1	23	1	S.
Jupiter	3 14	8 26	13 38	10 7	10	7	S.
Saturn	18 6*	2 9	10 12	21 33	21	33	N.

* Indicates that the rising is that of the preceding evening.

Oculations of Stars by the Moon (visible at Greenwich)

ec.	Star	Mag.	Disap.	Reap.	Corresponding angles from vertex to right for inverted image
13	3 Cancr	6	1 42	2 46	100 237
13	B.A.C. 2731	6½	6 54	near approach	207 —
13	54 Cancr	6½	21 26	22 9	85 181

ec.	h.	Star	Mag.	Disap.	Reap.
13	6	Mercury	stationary.		
13	17	Saturn	in conjunction with and 2° 59' north of the Moon.		

Variable Stars

Star	R.A.		Decl.		h. m.
	h. m.	h. m.	h. m.	h. m.	
Cephei	0 52.2	81 16 N.	Dec. 13,	1 25	m
Arietis	2 42.0	17 2 N.	18,	1 5	m
Tauri	4 23.0	9 42 N.	12,		M
Leporis	4 54.4	14 59 S.	17,	2 24	M
Cancr	8 37.4	19 27 N.	15,	21 0	M
Virginis	13 20.2	2 47 S.	16,	4 50	m
Librae	14 54.9	8 4 S.	13,	22 15	m
Coronae	15 13.6	32 4 N.	15,	2 30	m ₂
Lyrae	18 45.9	33 14 N.	16,	4 50	m
Cephei	22 24.9	57 50 N.	17,	19 20	M

M signifies maximum; m minimum; m₂ secondary minimum.

Meteor-Showers

Moonlight interferes with meteor observation during the early part of the week, which is also less fruitful of meteors than are the first few days of the month. Amongst the radiants which we supplied meteors at this season are one in the constellation the Lynx, R.A. 108°, Decl. 63° N., and one in Quadrans, R.A. 221°, Decl. + 53° N.

THE LAW OF STORMS IN THE EASTERN SEAS¹

IN the Eastern seas the earliest signs of a typhoon are clouds of the cirrus type—looking like fine hair, feathers small pale white tufts of wool—travelling from the east or ereabout, their direction backing towards the north, a slight rise in the barometer, clear and dry but hot weather, and light winds. This fine weather lasts for days, and the existence of a typhoon at a great distance contributes therefore to the safety of ships at sea,—a fact that is not sufficiently appreciated by seafarers.

The cirrus clouds, which frequently assume fantastic shapes, make their appearance within 1500 miles of the centre of a typhoon, the barometer is generally rising beyond from 600 to 800 miles of the centre, and the mean of the twenty-four hours' temperature rises in Hong Kong above 81°.

A swell in the sea is noticed within from 300 to 500 miles of the centre, but this depends greatly upon the situation of the

¹ By Dr. W. Debarck, Hong Kong Government Astronomer. Reprinted from the Hong Kong Telegraph.

nearest land. Halos round the sun and the moon, phosphorescence of the water, and also glorious sunsets appear to be frequently noticed before typhoons.

Within about 800 miles of the centre the sky is generally half covered with cumulus clouds, above which cirro-cumulus are usually seen. South and south-west of the centre, thunderstorms and cumulo-stratus clouds are observed. On approaching nearer to the centre the cloudiness increases, the temperature falls in consequence, and the mercury begins to descend in the barometer. Then the air becomes oppressive from the increasing dampness, a slight haze is observed during the morning hours, and the sky presents a threatening and vaporous appearance. Within 300 miles of the centre the temperature falls quickly owing to the cumulus, roll-cumulus, or nimbus clouds, with which the sky is nearly completely overcast. And meantime the wind has risen and blows generally with the force of a strong breeze about 300 miles from the centre. But this depends also upon the bearing of the centre, the wind being usually strongest in the right hand semicircle. Within 150 miles of the centre the sky is densely overcast with nimbus clouds accompanied by heavy rain, and within 60 miles it generally pours down in torrents, while the wind blows so hard that no canvas can withstand it; but there is no thunder and lightning. The temperature at sea is frequently about 76°, and on shore about 78°.

Within from 2 to 15 miles of the centre the wind either calms down or blow only moderate breezes, and the sky clears, being now covered only by very light clouds. The sea is as a rule mountainous, but in some reports it is stated that the sea had calmed down to some extent when the wind fell. Quantities of sea-birds, and near land also butterflies and other insects, cover a ship situated in the bull's eye of a typhoon. It is possible that the central calm does not quite accurately coincide with the centre of the typhoon.

The angle between the direction of the wind and the direction of the radius (the straight line between the observer and the centre of the typhoon) is, on an average, between 10° and 25° latitude, 43° in front of the centre and 53° behind the centre; between 33° and 35° latitude, 65° in front and 85° behind; and between 10° and 35° it is about 49° in front and 62° behind the centre. The angle appears to be smaller near the shore for off-shore winds, and far out at sea the difference between the angle in front of and behind the centre appears to be small. The following rule for finding, on board ship in the China seas, the bearing of the centre of a typhoon is, therefore, approximately correct: Stand with your back to the wind, and you will have the centre on your left side, but 3 points in front of your left hand; i.e. the centre bears about 11 points from the wind. If your ship is in a very low latitude the centre may lie as much as 4 points in front of your left hand, i.e. bear 12 points from the wind, and if you are in a high latitude it may bear only 9 points from the wind. Once the wind has reached the force of a strong breeze, the average angle between the wind and the direction of the centre does not appear to change at all, but the wind, which blows in great gusts in a typhoon, may oscillate to both sides of the true value. There does not appear to be any foundation at all for the belief that the wind near the centre blows in circles round the centre. To act according to this rule might prove disastrous to a ship experiencing a typhoon.

Very low clouds in a typhoon move with the wind, but if the clouds are high they are frequently seen to move in a different manner, and the following rule may then occasionally be of use: If right in front of the centre, stand with your back towards the direction whence the clouds are coming, and you will have the centre from 1 to 2 points in front of your left hand; and if straight behind the centre you may have it a point or two to the left of the direction in which you are looking.

Once the bearing of the centre has been ascertained, the master of a vessel in a typhoon requires to know in which semicircle, looking in the direction towards which the typhoon is moving, he is situated: If in the right hand semicircle, the wind will veer, i.e. shift with the sun; and if in the left hand semicircle, it will back, i.e. shift in the opposite direction. But this rule is strictly applicable on board of a vessel only when heaving to, or at any rate proceeding at a slower rate than the typhoon. For a vessel moving at a faster rate than and in the same direction as a typhoon, the rule may be reversed. In case of doubt it may therefore become advisable to heave-to in order to be quite sure of the semicircle in which you are situated. But we have seen that the wind moves in spirals towards the centre, and

it is therefore dangerous to lie-to in a typhoon, particularly before you are sure that the centre is past. Vessels near the coast of China, or in the Formosa Channel, generally seek refuge in the nearest typhoon harbour indicated in the Directory.

The wind shifts faster the nearer the centre you are. If the barometer falls rapidly and the wind does not change its direction, and when the gusts continue to increase in force, your ship is in danger of entering into the central calm of the depression with its mountainous and confused seas, which is by all means to be avoided, as it is the high cross seas that do the most damage, and not the force of the wind. When once you are caught in a typhoon you should make no sail, except what may be necessary to steady the ship, till the gusts continue to decrease in force and the barometer has risen for some time. Very deceitful lulls are reported to occur during the raging of a typhoon. The master of a sailing-vessel is said to have put up topgallant sails after getting into the central calm. Of course he could have had no reliable barometer on board.

In storms encountered in higher latitudes, where the incurvature of the wind is not so great as in a tropical hurricane, the right-hand semicircle is termed the dangerous semicircle, as a ship running before the wind is in more danger of crossing the path of the storm in front of the centre and perhaps be overtaken by it: but in a typhoon there is not much to choose between the semicircles. A dismayed ship is in danger of being carried into the centre from any quarter.

However, the right-hand semicircle is also in a typhoon generally more dangerous than the other, both with regard to the risk of crossing the path in front of the centre, and also, as remarked above, with regard to the force of the wind and consequent greater sea disturbance. A ship experiencing a northerly gale and a falling barometer in the China Sea in the typhoon season is generally in greater danger than another experiencing a south-westerly gale.

When you have ascertained in which semicircle your vessel is situated, you should, if in the right-hand semicircle, keep the wind as long as possible on the starboard tack; and if in the left-hand semicircle, you should run on the starboard tack, or heave-to on the port tack, so as to let the ship come up as the wind backs and run no risk of being taken aback. As explained further on, a typhoon encountered in a low latitude moves so slowly that a steamer or fast sailing-ship has a fair chance of running away from it, but farther north, when the centre proceeds at the rate of thirty or forty miles an hour, it requires careful management even supposing you have ample sea-room.

Typhoons are dangerous on the open sea, but they are still more to be feared in open anchorages or near lee shores. Along the south-west coast of Formosa and elsewhere, a ship must in the south-west monsoon be prepared to run to sea at very short notice, as in some of the harbours you could not lie with any chance of riding out a typhoon. A steamer at anchor should get up steam as soon as the wind rises above the force of a strong breeze, and a sailing-vessel should take down the top-masts. The direction in which the wind is going to shift must early be determined so as to select a sheltered anchorage. If the centre passes very near the anchorage, the berth may have to be changed to the other shore during the lull, before the wind shifts to the opposite quarter.

A ship moored by a single anchor with her head to the wind, will swing with the sun in the right-hand semicircle and against the sun in the left-hand semicircle. If two anchors are dropped, the anchor on the advancing bow should be let go first, therefore a ship in the right-hand semicircle of a typhoon should first drop the port anchor and afterwards the starboard, in order that she may ride with open hawse. And a ship in the left-hand semicircle should first drop the starboard anchor. But ships have to ride with a long scope in a typhoon, and as they are liable to drag the anchors, some prefer to drop the second anchor to veer upon if the first should not hold.

11. The force of the wind and the appearance of the sky do not always furnish a reliable guide to determine how far you are from the centre of a typhoon. The dimensions are different in different typhoons, and near land the strong winds are often so irregularly distributed that in a place near the centre less wind may actually be experienced than at some distance farther away from it. Also the 11-point rule for ascertaining the bearing of the centre fails near some shores if the centre is not near at hand; thus there often blows a steady easterly gale along the southern coast of China when a typhoon is crossing the China

Sea, and the gale blows often steady from north-east about the northern entrance to the Formosa Channel when there is a typhoon in a more southern latitude.

The surest of all warnings is furnished by the standard barometer on shore and the compensated aneroid on board ship; you are all right if you can put your vessel on the tack that will keep your barometer rising. But in order to understand the indications of the barometer you will have to keep a regular meteorological register. The master of a vessel who does not look at his aneroid till he is in a typhoon, does not derive half the benefits from his observations that he would have enjoyed had he watched it beforehand. He might perhaps have avoided the weather he is now experiencing, or even have benefited by the favourable winds and sailed round the typhoon. No doubt the time is approaching when underwriters will stipulate that the indications of an aneroid or a marine barometer must be regularly registered on board a vessel insured by them.

On the other hand, it would not be fair to ask the mariners to keep complete meteorological records, such as are kept in the lighthouses out here. Some seamen have a taste for this kind of work and make very useful and fairly accurate observations, but, for instance, the readings of dry and damp bulb thermometers taken on many vessels are of very little use.

The tube of the marine barometer has to be so much contracted to stand the incessant pumping and danger of breakage, that the instrument is sluggish and often reads half an inch or more too high near the centre of a typhoon. Some cheap woollen barometers cannot be registered below a certain height, the cistern being too small to hold the mercury that comes out of the tube. Of course some cheap aneroids are no better, and even a first-class compensated instrument requires to be thoroughly verified, as the scale is never quite correct, but they act nearly as quickly as first-class standard barometers, and for use on board ship the instrument that is quickest in its indications must be preferred. The objection to the use of the aneroid is founded on the fact that its index-correction changes gradually; but then this can be determined and allowed for by reading it off as often as the vessel enters a port, such as Hong Kong, where correct meteorological observations are constantly being made.

The best hours for making observations are 4 a.m., 8 a.m., &c., up to midnight inclusive. The observations should consist in readings of the aneroid, temperature (this is no use except when the thermometer is placed well forward so as to be exposed to the wind, though in a position sheltered from the sun and the rain), direction and force (0-12) of the wind, direction whence coming of the clouds, amount (0-9) of sea-disturbance, and weather (Beaufort's notation). For further particulars the "Instructions for making Meteorological Observations, prepared for use in China," published in 1883 by the writer, may be consulted.

From 4 a.m. to 10 a.m. the barometer is rising, falling from 10 a.m. to 4 p.m., rising from 4 p.m. to 10 p.m., and falling from 10 p.m. to 4 a.m. It reads highest at 10 a.m. and lowest at 4 p.m. During the approach of a typhoon this regular daily variation may be masked, but it goes on all the same, and must be taken into account when the barometer begins to fall before a typhoon. Thus if it has fallen a certain amount between 10 a.m. and 4 p.m. you must subtract the normal descent between these hours in order to know how much of the fall is due to the approach of the typhoon, and if it were between 4 p.m. and 10 p.m. that it fell, you must add the normal rise for the same purpose.

In many typhoons, the barometer, reduced to 32° Fahrenheit, and to sea-level, does not fall below 28.80 inches. In others it falls as low as 28.50. Lower readings of the barometer appear to be rare, but it has been stated to have fallen much lower. The rate at which your barometer is falling depends upon your approach to the centre, and in consequence upon the rate at which this is travelling. For this reason it is not safe to draw conclusions concerning the amount of wind to be expected from the rate at which the barometer is falling, but to some extent, of course, this may be done. Remember, that, when the barometer has fallen to its lowest reading and begins to rise, you may expect to experience as much bad weather as you have already gone through.

The wind blows from a region where the barometric pressure is higher, towards one where it is lower, being, however, deflected towards the right in a typhoon, and the force of the wind depends upon the difference of pressure between one place and

another situated in the direction of the greatest barometric slope or gradient. This is expressed in hundredths of an inch per fifteen nautical miles. Now, the gradient corresponding to a certain force of the wind is somewhat uncertain, particularly when the force of the wind exceeds a whole gale, but on an average a gradient of 0.02 inches in 15 miles corresponds to a force of wind equal to 6 on Beaufort's scale, 0.03 to 7, 0.04 to 8, 0.05 to 9, 0.07 to 10, 0.10 to 11, and where the gradient is above a tenth of an inch in fifteen miles it generally blows with full typhoon force. In low latitudes the gradient occasionally exceeds one inch in fifteen miles.

Curved lines drawn on a map through the places from which

the same height of the barometer (reduced) is reported, or between those that report a higher and a lower barometer, are called isobars. The gradient lies at a right angle to the isobar. These are the most important elements in forecasting the weather. Thus during the south-west monsoon the barometer as a rule reads higher over Luzon than along the China coast, the gradient being directed from about south-east towards north-west, indicating southerly winds as prevailing over the China Sea according to the 12-point rule. But when, as occasionally happens in the typhoon season during the south-west monsoon, readings reported from stations along the south-eastern coast of China are higher than those reported from Luzon, the gradient is found to be

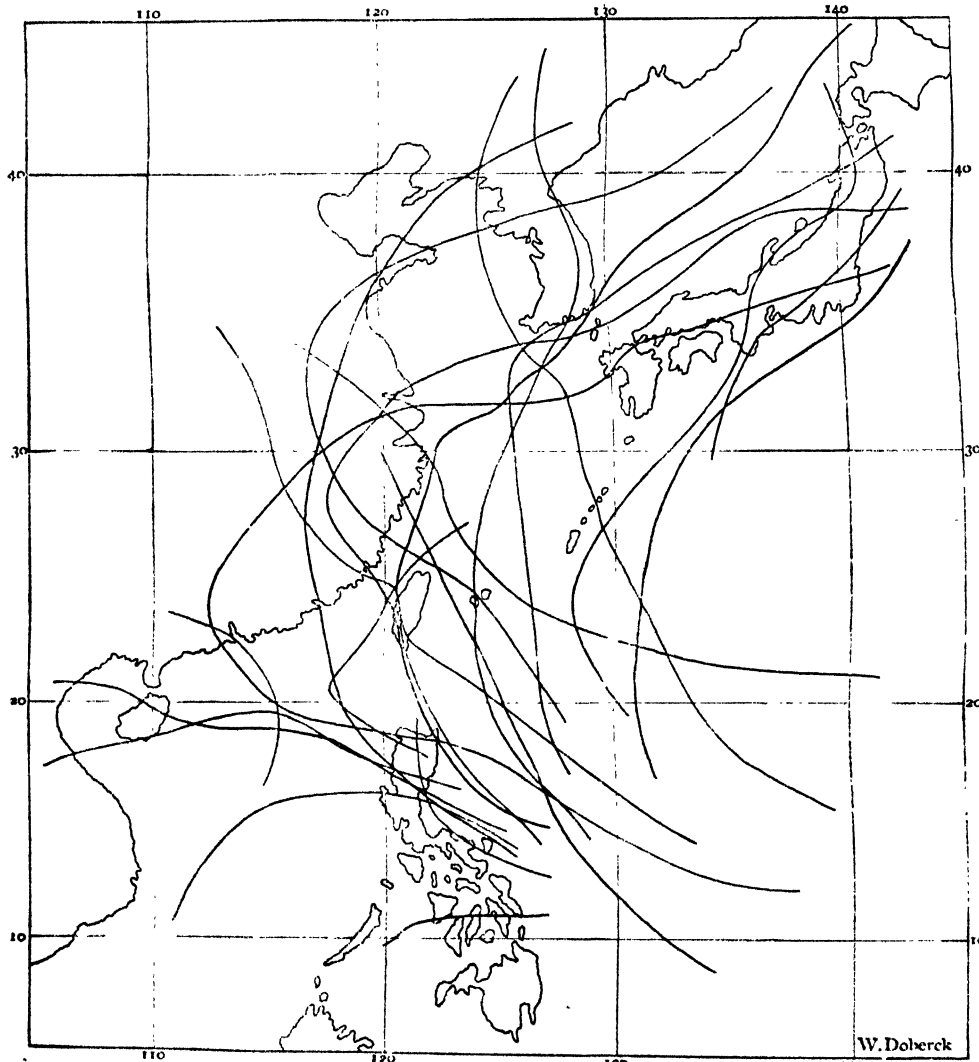

Principal Typhoons of 1884 and 1885.

reversed, being directed towards south-east, thus indicating northerly winds. At such times a typhoon may be expected, the probability is increased if the barometer is falling in Luzon rising slowly in Northern China and Japan, and if cirrus clouds have previously been observed to come up from east or north.

III. Nearly all the typhoons appear to have their origin east or south-east of the Philippine Archipelago, in a part of the ocean south of the high-pressure area that covers the Northern Pacific in the summer season, which part of the ocean is characterised by high sea-surface temperature. Typhoons are sometimes formed in the China Sea, but then they seldom develop energy, as they usually move quickly northwards and enter

the mainland of China or Formosa. Owing to their small dimensions they are easily avoided by such ships as may fall in with them. The sea-disturbance is nothing terrible, and only whole gales of wind were reported in those cases that have been investigated here. If, however, a typhoon of this kind passes northwards up through the Formosa Channel, it soon becomes as formidable as any of those that originate in the tropical Pacific. We have not traced typhoons nearer to the equator than about 9°. But it appears that they may possibly in some cases originate nearer than that to the equator, as hurricanes have been encountered in a lower latitude.

It frequently happens that a vessel encountering a typhoon in, say, 12° north latitude and 135° longitude east of Greenwich,

does not experience any strong wind or bad weather till within a hundred miles or so of the centre, and as the typhoons are most violent in that locality, it is very important to look out for the premonitory signs referred to in the first section of this article, taking into account that the dimensions of a typhoon are so small there. On the other hand, they move at so slow a rate that you may run away from them if you are aware of the danger in time, so much more as you may be sure that a typhoon in that locality is directing its course to somewhere about west-north-west or north-west, and most likely in the first-named direction. So it is better to get to the eastward of it. Nearer the Philippine Archipelago the typhoons usually take a more northerly course, moving north-west or north-north-westward. But frequently they continue their course west-north-westward and cross the islands to enter the China Sea. In spring and autumn they have even been found to move westward and turn south-westward after entering the China Sea. But when you are east of the Philippines you should try to get your ship south-east of the typhoon by crossing the path behind the centre, if possible. If you are going northwards, you will then benefit by the fresh south or south-west breezes, taking care not to approach too near to the typhoon, whose progressive motion may not be more than six miles an hour. You will probably have squally and wet weather.

When all the paths of the typhoons that have been investigated by the writer in the course of the last three years are laid down on a map of the Far East, the picture looks much like a fan, the paths, with a few stray exceptions, radiating from the locality referred to above, and running in all directions between west and north, but most of them at first westward and then north-westward. In a higher latitude they generally recurve and pass off to the north-east, after first, of course, having turned northwards. Every typhoon does not recurve; in fact, as stated above, some of them finally disappear in the China Sea after turning to the south-west. The others recurve between 20° and 40° latitude, and 115° and 130° longitude. The Middle Dog Lighthouse is situated in the centre of the region of recurvature.

The normal path is therefore, roughly speaking, a parabola, whose axis lies from east to west, and whose apex is turned westward and lies within the region indicated above. But each path individually is anything but a regular parabola, and the deviations are evidently due to the influence of the coast-line of the mainland of Asia and to the mountainous islands (especially the high mountains of Formosa) as well as to the prevailing winds. For there is no doubt that the progression of a typhoon is the effect of the wind prevailing at the time, not necessarily at the surface of the earth, but at a somewhat higher level in the atmosphere, which agrees with the direction of the clouds, that have, as explained in the first section of this article, been found to move nearly straight towards the centre in the posterior semicircle. If, however, the wind at the surface of the earth is strong, it is at times plainly seen to blow the typhoon before it. The typhoons do not appear to move south-westward in the China Sea except when the north-east monsoon is strong, and in the summer of 1885, when the south-west monsoon was strong, most of the typhoons moved northwards while yet to the east of Formosa. This is then the reason why the typhoons depend upon the season of the year. They are likewise deflected from their previous path when exposed to strong winds blowing out of open channels, such as the Formosa or Corea Channels, in which case the speed of their progress is sometimes abruptly increased.

The average rate of progress of the centre of a typhoon in 11° latitude is 5 miles an hour. In 13° it is $6\frac{1}{2}$, in 15° it is 8, in 20° it is 9, in 25° it is 11, in 30° it is 14, and in $32\frac{1}{2}^\circ$ latitude it is 17 miles an hour. The rate of progress does not vary perceptibly in case of typhoons south of 13° latitude, so it is well for masters of vessels to know this, but it is more variable the farther north you go. In $32\frac{1}{2}^\circ$ latitude it ranges between 6 and 36 miles an hour, so that you cannot at all be sure that a typhoon, which you may happen to be near, will travel at anything like the average rate of progress in that latitude.

In "Observations and Researches made at the Hong Kong Observatory in the year 1884," the writer suggested the division of typhoons into four classes according to the paths which they usually follow. Of course abnormal instances, such as for instance are presented by the typhoons that originate in the China Sea, occur occasionally in China as well as elsewhere, but they are comparatively rare.

Typhoons of the first class occur at the beginning and the end

of the typhoon season. They cross the China Sea and travel either in a west-north-westerly direction from the neighbourhood of Luzon towards Tonquin, passing south of or crossing the Island of Hainan, or, if pressure is high over Annam, they travel first westward and subsequently south-westward. They can generally be followed for between five and six days.

Typhoons of the second class are the most frequently encountered, and their paths can be traced farthest. They generally travel north-westward while in the neighbourhood of Luzon, and either strike the coast of China south of the Formosa Channel, in which case they as a rule abruptly lose the character of a tropical hurricane, recurve in the interior of China, re-enter the sea somewhere between Shanghai and Chefoo (thereby regaining some of their past violence), pass across or near to Corea, and are finally lost sight of in their motion towards about east-north-east; or they pass up through the Formosa Channel, recurve towards north-east, and pass along the coasts of Japan; or they may strike the coast of China north of Formosa. Typhoons following the latter path originate further east of the Philippines than the others. They either continue their motion north-westward, in which case they are soon lost, or recurve and pass north-eastward near Corea. Typhoons of the second class occur from June to September inclusive, but are most common in August and September. It appears that a third of the typhoons belong to this class. They can be followed on an average 7 days, or rather between 5 and 12 days.

Typhoons of the third class are probably the most numerous of all, but are not encountered so frequently as the typhoons of the second class, and therefore the existence of a typhoon of this class is sometimes only suspected, although it of course influences the weather along the eastern coast of China through the fine weather area with which it is surrounded. They pass to the east of Formosa, travelling northwards. After recurving, they generally pass near Japan, but sometimes a typhoon of this class continues to move north-north-westward and does not recurve till west of Corea. They prevail in the same season as typhoons of the second class, and may be traced on an average during 7 days, or more correctly between 3 and 12 days. A typhoon of this class frequently follows after one of the second class. It is a well-known fact that depressions are attracted towards places which have just been traversed by a depression.

Typhoons of the fourth class pass south of Luzon, travelling westward, or first in this direction and then south-westward. They occur at the beginning and the end of the typhoon season, while the north-east monsoon is strong, namely in April and late in autumn, but are very rare. They are said to be more violent in autumn than in spring. Existing in so low a latitude, their dimensions are, of course, very limited. The writer has not been able to follow them for more than a day or two.

The number of typhoons that are known to have occurred in each month of the year, expressed in percentages of the total number of typhoons, is as follows:—January 2, February 0, March 2, April 2, May 5, June 5, July 10, August 19, September 27, October 16, November 8, and December 3. These figures prove that typhoons are most frequent during the month of September, but they also show that, strictly speaking, there scarcely exists a well-marked typhoon season. On an average there are 15 typhoons every year, but typhoons in different years exhibit some variations.

IV. The writer on his arrival in the colony in 1883 found that meteorological observations were received from a few of the Treaty ports, &c., and were published in the local papers; and seeing that these returns would only have to be corrected and reduced, as well as slightly extended, in order to be of great value to the shipping, he took upon himself to effect this. Subsequently, as the official work of the Observatory was fully started, he would have had to give up this purpose had not the Government decided to support it. Thus originated the *China Coast Meteorological Register*, which is published daily from here. It contains, at present, observations of the principal meteorological elements, which are received through the co-operation of the great telegraph companies from Manila, Bolinao (Luzon), Haiphong, Hong Kong, Amoy, Foochow, Shanghai, Nagasaki, and Vladivostock, but the number of the stations might with advantage be extended. It gives also information about the weather prevailing in the Far East, and more or less rough intimations concerning such typhoons as happen to be indicated by the telegraphic returns, as well as by local observations. Subsequently more or less extensive monthly meteorological

logical returns are received from about fifty land stations in the Far East, and the examination of the log-books of ships calling at this port, as well as observations received from commanders of men-of-war and masters of vessels trading in these seas, furnish a perhaps unequalled amount of material for scientific discussion, the results of which, as far as they go, are from time to time published in the *Government Gazette*. But no funds are available for this work, the Observatory being supposed to make and investigate only local observations, and with reference to weather-intelligence to warn the colony of storms by which it may be threatened, as far as may be possible through local observations. Some distinguished individuals having the welfare of the colony at heart would gladly see the little Observatory extended into a Meteorological Office for the Far East, for which it would be so peculiarly adapted owing to its central position, extensive telegraphic connections, &c.; but where the money is to come from has not yet been suggested. The Meteorological Office in London is allowed over ninety thousand dollars a year. The area in question is considerably larger than the area covered by the United Kingdom. The annual cost of the local Observatory was estimated to begin at ten thousand dollars, and it was remarked that additional clerical help would certainly be needed if it were resolved to undertake a thorough investigation of the monsoons of the China Sea. But actually only about six thousand dollars a year are expended in connection with the Hong Kong Observatory.

The Colony itself is warned by means of the *typhoon gun*, placed at the foot of the mast for hoisting signals beside the time-ball tower. It is fired one round whenever a strong gale of wind is expected here, and two rounds whenever the wind is expected to blow with typhoon force. It will be fired again, if possible, when the wind is likely to suddenly shift round. In 1885 it was fired also as a mail gun, but this practice has been discontinued, and as long as the typhoon gun is not fired in future, one may be sure that no typhoon is expected here. During the approach of a typhoon, and at other times when it appears desirable, special messages are telegraphed from the Observatory to be distributed in Hong Kong in such manner as the Government may from time to time see fit to direct, but as soon as they are issued from here the writer's responsibility in the matter ceases. This arrangement will, however, be found to be of very little use until the Observatory is placed in direct communication with the telegraph offices in Hong Kong, as the connections between the police stations generally break down in bad weather, when there is no boat-communication with the other side of the harbour, and thus the colony may expect that communication with the Observatory will sometimes be interrupted just at such times when the intelligence issued from here would be particularly useful. As soon as direct communication with the telegraph offices is established, the daily returns from the Treaty ports will be telegraphed across the harbour, and the *China Coast Meteorological Register* can then be issued at an early hour, by which its utility will be very much increased.

In the course of the summer of 1884 the writer invented and started a system of *meteorological signals*, which continue to be hoisted on the mast beside the time-ball tower at Tsim-sha-tsui. As these signals could not be hoisted without friendly co-operation with the officials of foreign Governments, they are, of course, unofficial, using this word in the sense in which it is understood by scientific men. The utility of these signals is confined to the shipping and to those interested in ships about to leave the harbour, or out in the China Sea. *The colony itself is warned by means of the typhoon gun.*

A *red drum* is hoisted to indicate the existence of a typhoon east in the China Sea in a longitude more easterly than the colony. Steamers, if bound for northern, western, or southern ports, should use no time in starting, and may then expect more or less fine weather. Those bound for the Philippines should take precautions to avoid the typhoon, and observe the rules set forth in the first section of this article. Sailing-vessels bound for western or southern ports should lose no time in starting, but those that are bound for northern or eastern ports ought to remain in the harbour awaiting further information, as they may expect to fall in with calms or contrary breezes after starting, even should the wind be westerly here at the time. The day after the drum has been hoisted the *China Coast Meteorological Register* should be consulted, taking into account that typhoons east and south-east of Hong Kong generally travel at the rate of from six to fourteen miles an hour.

A *red cone pointing upwards* indicates that a typhoon exists in

a latitude more northern than the colony, or that it is progressing towards the north. More or less persistent south-west winds, at times accompanied by thunderstorms, may then be expected, and ships leaving the harbour are not at all likely to run any risk from the typhoon. Sailing-vessels bound for the north should start as soon as convenient, so as to benefit by the favourable breeze to run through the Formosa Channel and avoid the way round Formosa. By following the latter route a sailing-vessel, moreover, runs the risk of encountering the next typhoon east of Formosa, particularly during the months of August and September.

A *red cone pointing downwards* indicates that a typhoon exists in a latitude more southern than the colony, or that it is progressing towards the south. As such a typhoon is likely to travel in a northerly direction, ships desirous of avoiding bad weather should await further instructions, or remain in port till the barometer begins to rise. Then the danger is past.

A *red ball* indicates that the typhoon exists in a longitude more westerly than the colony. Ships starting for northern, eastern, or southern ports may expect breezes from east round by south to south-west. Those starting for western ports run no risk as long as the barometer is rising. If it should happen to fall, they may heave-to, and subsequently, if necessary, take refuge in some typhoon anchorage, such as St. John's harbour, but this will rarely occur. If a vessel in the Formosa Channel experiences an increasing south-westerly gale and a falling barometer, the typhoon has very likely recurved. All you have to do in that case is to lie-to, when the weather will quickly improve, and you may expect a pleasant voyage.

V. As the typhoons during their entire course are nearly always moving northwards, or rather into a higher latitude, a ship situated in the southern semicircle is on the whole in a safer position than north of the centre. East of Luzon typhoons move west-north-westward, or thereabout, and a ship must shape its course so as to reach the quadrant south-east of the centre. As a general rule, they move north-westward in that part of the China Sea between Hong Kong, Luzon, and Formosa, and east of the latter island they generally travel in some direction between north-west and north. So your vessel is safe when south of the centre, where you must heave-to till the weather improves, particularly if bound for one of the northern ports. If bound for the south, you may run across the path in front of the centre with the north-westerly breeze, but if you are not in time you may lose your boats and sustain other damage.

About 30° latitude, between China and Japan, you are liable to fall in with a typhoon travelling in any direction between west-north-west, north, and east-north-east. Here you are as a rule safest when south of the centre, but if the typhoon is travelling north-eastward this is in the dangerous semicircle. However, the investigations of the writer, though he has paid less attention to typhoons near Japan than elsewhere, nevertheless indicate with some degree of probability that the wind is less incuring behind the centre in that locality than elsewhere. North of this latitude you would of course prefer to be west of the centre.

Suppose that after leaving Singapore bound for Hong Kong the south-west monsoon begins to blow fresher and the barometer to fall, and you suspect that a typhoon is raging in a latitude more northern than where you are at present (the phenomena mentioned would not necessarily indicate the existence of a typhoon, if they were not accompanied with some of the other signs enumerated in the first section of this article), you will, of course, set your course to the east in order to sail round the typhoon and benefit by the south-easterly backing to east winds which you may expect to fall in with; but if the season is late in the year, you had better assure yourself that the typhoon is not travelling south-westward, in which case you might possibly be overtaken by the centre. These typhoons are often the cause of high seas even in the Gulf of Siam; but as their progressive motion is usually rather slow, you may heave-to in order to make observations without losing ground perceptibly. Supposing a typhoon in the China Sea does not make itself felt till you have reached a higher latitude, and that it is passing westward in a latitude south of your ship; being in the dangerous semicircle, where the wind is, moreover, stronger than south of the centre, you may have to cross the path in front of the centre to arrive in the anterior left-hand quadrant; or, if the typhoon is yet distant, the wind light, and your ship thoroughly sea-worthy and in good trim, you may possibly put her on the port tack and run north-eastward, but be ready to change the tack as soon as it becomes advisable.

Many of the anchorages along the south-eastern coast of China and the south-western coast of Formosa afford excellent shelter against north-east winds, but would prove to be much worse than the open sea during a heavy southerly gale. If you observe a northerly gale and a falling barometer, by far the surest signs of an approaching typhoon, and appearances are rapidly getting worse, then occasions may possibly occur when you may be under the dire necessity of running southwards with the northerly gale, against the rules laid down by meteorologists, and bring your ship into a most dangerous position in front of the centre. But you may happen to be better off there after gaining ample sea-room, than in the snug anchorage, where your vessel would be smashed against the rocks as soon as she began to drag her anchors when the storm burst upon her from the south, although the south-west storms experienced along the south eastern coast of China during a typhoon that enters the mainland are as a rule less violent or protracted than the preceding storm from the north.

Suppose that after leaving Hong Kong bound for a northern port you were to ascertain the existence of a typhoon about to cross your course in front of your vessel, and you experience, say, a strong breeze from the west-north-west. If you do not alter your course, you may, from the fact of its subsequently appearing to be a hanging gale and seeing the mercury falling in the barometer, draw the erroneous conclusion that you are on the path of the centre of a typhoon coming down on you from the east-north-east. In such a case it does not appear to be advisable to scud before the wind, it being decidedly wiser to heave-to. Then if the gale is observed to begin to back towards south-west, you may run southwards and shape your course so as to sail round the typhoon. Masters of steamers leaving Hong Kong while the red drum is hoisted generally lose no time in running southwards as soon as the typhoon is observed to have taken a north-western course, and suffer very little delay in consequence.

Steamers bound for Shanghai are, while between Foochow and Ningpo, liable to experience the northerly gales that precede a typhoon of the second class travelling north-westward and about to strike the coast in that locality. Not wishing to expose their ships to the high cross seas round northern Formosa, the masters generally take them into the nearest typhoon harbour in order to wait till the centre has entered the mainland, and then run northwards with the southerly gale.

These few examples will be sufficient, the more so as the further consideration of the subject would lead into details with which the writer is not familiar, being possessed of no further knowledge of navigation than the little that can be gleaned from the inspection of log-books and from occasional conversations with masters of vessels of many years' standing. The writer has invariably found these gentlemen ready to recount their experiences and to communicate any information, as soon as they found that it was required for scientific purposes exclusively. The master of a vessel, after encountering a severe typhoon, has often to undergo the vexation of seeing every manœuvre of his subjected to the comments of those unaware of the hundreds of things he has to take into consideration besides the law of storms, and who were comfortably ensconced in their houses while he was experiencing the typhoon with its fierce gusts, interrupted by the, if possible, more ominous lulls, during which he cannot see three ship's lengths before him, the mountainous waves in which his good ship is but a "cock-boat," the loudest shouting inaudible, drowned in the roar of the tempest, boats and everything movable having been washed overboard, rudder gone, and perhaps one of the masts thumping at her bottom, while the seas threaten at every moment to swamp the ship.

VI. The origin of a typhoon is not quite understood, but appears to be connected with an abnormally high temperature and humidity in some place in comparison with the neighbourhood. Over such a place the hot air expands, ascends, and is thereby cooled. But the heat liberated by the consequent condensation of water-vapour retards the rate at which it cools on rising in the atmosphere, and enables it to rise still further. When the air has risen to a high level, it effects there an increase of barometric pressure, in consequence of which the upper air is set in motion out towards the circumference of the area in question. Thus a fall in the barometer at the surface of the sea in the middle of the hot and damp region is effected, and the surrounding air is impelled in towards the centre. The motions inwards at the surface of the sea, and outwards at a high atmospheric level, are, of course, contemporaneous, and one is assisted

by the other. But air in motion is deflected towards the right in the northern hemisphere, owing to the rotation of the earth, except at or very near the equator; whence typhoons do not exist in that locality, for if the wind continues to blow into the depression it is soon filled up. Owing to its deflection towards the right, the wind is caused to move in a curved path in towards the centre, and the centrifugal force, developed in the curvilinear motion, deflects it still further from the straight line leading into the centre. The friction between the wind and the greatly disturbed sea-surface likewise retards the entrance of the air at the sea-surface into the central parts of the depression. But the air at a higher level in the atmosphere is subject to little friction, and escapes therefore at a greater speed from the central high-pressure area at that level. It is, therefore, apparent that once a cyclonal motion is started under circumstances favourable for its continuation, it tends to increase and to spread outwards.

There is, however, this important difference between a typhoon and a tornado, that the latter is taller than it is broad, whereas a typhoon perhaps does not reach above an altitude of four miles, while its horizontal diameter may amount to upwards of a thousand miles. Moreover, it is not at all likely that the centre at a higher level lies vertically above the central calm at the earth's surface, or even that the centres at different altitudes are situated in a straight line. We are, therefore, scarcely entitled to speak of an axis in a typhoon.

The spirals described by the air particles approaching the centre in a typhoon are known as logarithmic spirals, but unless a typhoon is stationary, which is perhaps never the case in Nature, new portions of air are constantly set in motion in front of the centre and others left behind by the typhoon.

As already remarked, the progressive motion of typhoons is evidently caused by the wind prevailing, if not at the surface of the earth, at any rate at a higher level. That the principal part of the disturbance is situated high above the surface of the earth is proved by the fact that the centres of typhoons pass across mountains several thousand feet high, and also by the circumstance that the difference between the temperature at the Hong Kong Observatory and at Victoria Peak is not perceptibly affected by the approach of a typhoon, for we cannot very well assume that the temperature of a vertical column of air is lower near the centre than outside the cyclone. The mountains referred to are situated on islands, and while crossing them the typhoon derives its store of water-vapour from the surrounding sea, for as soon as the centre has entered the coast, and is on all sides surrounded by dry land, it ceases to exist as a tropical storm, and can only be traced in the registers through a slight fall in the barometer, a freshening of the wind, perhaps amounting to a moderate gale at stations crossed by the centre, and wet weather. Inland in China the bull's eye of a typhoon does not appear to be observed.

As the wind blows more straight into the centre the nearer the equator you are, it follows that more air enters the typhoon from the southern semicircle than from the northern, and this is one of the reasons why typhoons nearly always move in a northerly direction. Moreover, the difference increases together with the dimension of the typhoons, which explains why they expand and accelerate their progressive motion at the same time.

The foregoing observations contain the principal practical results of investigations of about forty typhoons, continued during a period of three years. The mariner into whose hands this article may fall is advised to determine for himself the direction in which the centre of a typhoon, which he is experiencing, is travelling; for although typhoons of the classes enumerated are by far the most common, he never can be quite sure that he has not to do with an exceptional case, and quite possibly a case that is not found among the forty typhoons referred to above. By the time that we shall be in possession of full and trustworthy investigations of a couple of hundred typhoons, we may expect to have complete lists of the sub-classes of the four classes of typhoons, and to be better acquainted with cases of rare occurrence, for, after all, the typhoons are of a simpler construction and their paths more regular than is the case with storms in Europe. Typhoons are so violent near their centre that the whole disturbance is evidently ruled thereby, whereas storms in the North Atlantic and in Europe appear to be made up of a lot of local eddies, some of which are by degrees detached from the chief disturbance and form subsidiary depressions. The writer has not been able to ascertain the existence of a subsidiary depression in the China Seas during the last three years, and it is therefore doubtful whether such ever occur.

A great advance in our knowledge of typhoons in the China sea will no doubt follow on the construction of a lighthouse on the dangerous Pratas Shoal, such as has for many years been talked about. Our storm-warnings would gain still more value, and the cost of construction need not exceed the loss caused by a single disastrous typhoon.

EARTHQUAKE IN SIERRA LEONE

THE following correspondence has been forwarded for publication by Mr. R. H. Scott, F.R.S., Secretary, Meteorological Office:—

Government House, Sierra Leone, October 29, 1886

SIR,—I have the honour to transmit a copy of a communication received from Mr. J. M. Metzger, Manager of the Western District, in which he reports that an earthquake was felt at Sennehoo, in the Bompeh River, about the middle of last month.

(2) In the third and fourth paragraphs of his letter, Mr. Metzger draws attention to the fact that the shock in question was almost simultaneous with those experienced in other quarters of the globe, and that the latitude of the Bompeh District is within a few degrees of Charleston, America, where their effects lately proved so disastrous.

I have, &c.,

(Signed)

J. S. HAY,
Administrator-in-Chief

The Right Hon. Edward Stanhope, M.P.,
&c., &c., &c.

I HAVE the honour to state, for the information of His Excellency the Administrator-in-Chief, that on the return of the District boat from the Bompeh River on the 16th inst., the coxswain reported that he had been informed at Sennehoo that about the middle of last month an earthquake was felt at that place and in the upper parts of the country; in consequence of which, many of the natives, who interpreted the event as prognostic of coming war, hastened down to the water-side to procure arms and powder in preparation for hostilities, which they regarded as imminent.

(2) The shock is said to have been continuous, accompanied with a rumbling noise as of some heavy-laden cart being moved along, resulting in the cracking and falling down of the mud plaster on the walls of the houses at Sennehoo. What happened in the upper parts of the country is, of course, not known, but the force must have been sufficiently severe to impress the people and influence them as they appeared to have been.

(3) It is remarkable that these vibrations, which seemed to have been extensive throughout the Bompeh District, and which seemed to have been so distinct, are almost simultaneous with those experienced in some places in the Mediterranean Sea, in Greece, and notably at Charleston, on the Atlantic coast of America, where their effects were so disastrous.

(4) The Bompeh, like the Ribbee and Cockborough Rivers, runs into Yawry Bay, which is an arm of the Atlantic, and the Bompeh District, on the eastern side of this ocean, is opposite to, and not many degrees of latitude below, the scene of the late disasters in America.

(5) I think it my duty to make this communication, as the information might possibly be of use to scientists engaged in the study of the facts connected with the range and transmission of these seismic disturbances.

(Signed) JOS. M. METZGER, Manager

Kent, Western District, October 20, 1886

SCIENTIFIC SERIALS

American Journal of Science, November.—The higher oxides of copper, by Thomas B. Osborne. The oxides here dealt with are copper dioxide and copper sesquioxide; but being unable to continue the subject, at least for some time, the author publishes the incomplete results so far obtained, in the hope that they may be of use to others wishing to continue this line of investigation.—The structure of the Triassic formation of the Connecticut Valley, by William Morris Davis. It is shown that disturbance

has taken place after the period of deposition; that it was not caused by overflow or intrusion of trap-sheets; that it was not a simple monoclinical tilting; and that there is evidence for occurrence of unseen faults. The probable character of the disturbing force, its action on the fundamental schists, with consequent monoclinical faulting of overlying Triassic strata, and generally the area and depth of the disturbance, are questions also discussed in this elaborate paper.—Researches on the lithia micas, by F. W. Clarke. Descriptions and exhaustive analyses are given of the lepidolites of Rumford, Hebron, Auburn, and other parts of Maine, and of the iron-lithia micas of Rockfort granite-quarries near Cape Ann, Massachusetts.—The thickness of the ice in North-Eastern Pennsylvania during the Glacial epoch, by John C. Branner. So far from rising only 2200 feet above sea-level, as hitherto supposed, the ice is shown to have covered the twin peaks of Elk Mountain (2700 and 2575 feet), and no doubt also the Sugar Loaf, Ararat, and the other loftiest summits of this region during the Glacial epoch. A sheet of ice 1500 feet or less in thickness could never have flowed across such a mountainous region, so regardless as the great glacier was of its marked topographical features.—On the time of contact between the hammer and string in a piano, by Charles K. Wead. Owing to the uncertainty attending the theory developed by Helmholtz regarding the action of the hammer on a piano-string, the author has attempted to measure directly the time of contact by a simple process with results here tabulated.—Photographic determinations of stellar positions, by B. A. Gould. This is a reprint of the paper presented at the late Buffalo meeting of the American Association, and containing a brief history of stellar photography, and of the results so far obtained by the author in this department of practical astronomy.—Lucasite, a new variety of vermiculite, by Thomas M. Chatard. A description and full analysis is given of this substance, specimens of which have been found associated with corundum at Corundum Hill, Macon County, North Carolina. It has been named lucasite in honour of Dr. H. S. Lucas, so well known in connection with the Chester emery mine, Massachusetts.—Crystallographic notes, by W. G. Brown. An account is given of certain artificial copper crystals, of artificial crystallised cuprous oxide (cuprite), and of crystallised lead carbonate (cerussite) found under circumstances here described.—On the chemical composition of ralstonite, by S. L. Penfield and D. N. Harper. A comparative table is given of the analyses made by Nordenskjöld, Penfield, and Brandle of this rare mineral, which was found associated with thomsenolite at Arksuk Fjord, Greenland.—Analyses of the thomsenolite by the same chemists.—Mineralogical notes, by Edward S. Dana. Descriptive analyses are given of columbite from Standish, Maine, of diasporite from Newlin, Pennsylvania, of zincite from Stirling Hill, New Jersey, and of some native sulphur from Rabbit Hollow, Nevada, interesting because of its complex crystalline form.

Rivista Scientifico-Industriale, October.—On the cause of the magnetic rotatory polarisation, by Prof. Augusto Righi. Fresnel's hypothesis having been proved inadequate by recent experiment, the author has resumed the subject, with the view of ascertaining whether it may be explained by the reflected or transmitted vibrations of bodies endowed with rotatory power. If the incident polarised ray on penetrating a body is really decomposed into two inverse circular rays endowed with different velocities, the intensity of the two rays must also vary both in the reflected and transmitted light. The ray possessing greatest velocity of propagation, and consequently a lower index of refraction, must possess least intensity in the reflected and greatest in the transmitted light, assuming the two indices to be greater than unity, as in the opposite case the result would be reversed. Hence both the reflected and transmitted ray will become elliptical; and Prof. Righi has succeeded in determining this ellipticity by employing iron, the body endowed with the greatest rotatory power. The elliptical vibration of the reflected ray is in the opposite direction to that of the magnetising current, while that of the transmitted ray is in the same direction. In a future communication it will be shown that this agrees with the hypothesis of double circular refraction.—On the tests of fatty substances, and especially of olive oil, by Professors G. B. Bizio and L. Gabba. This paper contains a critical inquiry into the methods of testing the purity especially of olive oil, and it concludes that none of the processes now in use are absolutely trustworthy. Even that of Bechi fails to distinguish with certainty between olive and cotton oil.

SOCIETIES AND ACADEMIES

LONDON

Royal Society, November 18.—“A Theory of Voltaic Action.” By J. Brown. Communicated by Lord Rayleigh, Sec. R. S.

The difference of potential near two metals in contact is due to the chemical action of a film of condensed vapour or gas on their surfaces. Such a pair of metals is thus similar to a galvanic cell with its electrolyte divided by a diaphragm of air or other gas, and it is the difference of potential of the films that is measured in “contact” experiments; the metals themselves being at one potential.

Experiments with an electrometer having quadrants of the metals under examination, the construction of which was described, were made on the rate of decrease of the difference of potential near two metals in contact, and exposed to the action of the air and of other gases; also where a change in the constituents of the atmosphere surrounding a pair of metals in contact reverses the difference of potential near them in correspondence with the reversal of electromotive force which takes place after a similar change in the corresponding liquid electrolyte used with the same metals as a voltaic cell.

Such reversal takes place with pairs of copper-iron when hydrogen sulphide gas, or ammonia gas, is added to the air surrounding them; with silver-iron, when hydrogen sulphide is added; and with copper-nickel when either ammonia or hydrochloric acid gas is added.

Neutral or inert gases have little or no effect.

Covering the metals with varnish, or immersing them in naphtha, to protect them from atmospheric action, reduced the difference of potential near them considerably, but not to zero.

Drying the atmosphere about a copper-zinc pair by means of phosphoric anhydride in one instance reduced the difference of potential in 173 days from '66 to '5 Daniell. Then, on opening the instrument, it rose to '67 Daniell.

A permanent current was produced by placing the (apparently) dry plates of copper and zinc in close proximity, so that their films were in contact. When the plates were either brought into actual metallic contact, or separated farther apart than a certain distance, as stated the current ceased. This “film-cell” could also be polarised by sending a current through it from another battery.

Modifying an old experiment, due to Cassiot, so as to avoid any contact of dissimilar metals, it was shown that, when the zinc plate of the volta condenser was joined to the zinc quadrant of the electrometer and the copper of the condenser to the copper of the electrometer, on altering the capacity of the condenser an alteration of the difference of potential near the quadrants was produced.

In an appendix, Mr. J. Larmor, of St. John's College, Cambridge, points out the difficulty of explaining this last experiment by any hypothesis other than that of some kind of chemical action at the surface of the metals.

November 25.—A paper by Sir Richard Owen, F.R.S., was read, of which the subject was a fossil lower jaw of the large extinct marsupial quadruped which the author, from previous fragmentary specimens, had referred to a carnivorous pouched species of the size of a lion, to which was assigned the generic name *Thylacoleo*, and the probable prey of which had been the larger forms of herbivorous marsupials, which, with their destroyer, had become extinct.

Several species, allied to the kangaroo, but equalling respectively in bulk a rhinoceros, an ox, an ass, had become extinct. The largest existing kind, to be seen in the Zoological Gardens, was named by Dr. Shaw, *Macropus major*. It has escaped extinction by its swiftness and power of concealment in the “scrub.” Wombats, also, of the size of fallow-deer, co-existed with the huge kangaroos; the small kinds, capable of concealing themselves in burrows, alone survive.

Remains of the large extinct marsupials, both devourers and prey, are to be seen in the Geological Department of the Museum of Natural History; they are described and figured in the author's work on “Fossil Marsupialia.” Their extinction is attributed, with that of the wolf-like *Cynocephalus* and the *Thylacoleo*, to the aboriginal natives of Australia.

Linnean Society, November 18.—W. Carruthers, F.R.S., President, in the chair.—Mr. H. Bury was elected a Fellow of the Society.—Mr. W. H. Beeby showed specimens of *Callitriche truncata*, Gussone, from near Westerham, Kent. The species had

long been supposed to be extinct in this country, being only known as British from dried specimens from Sussex in Borrer's Herbarium.—Mr. D. Morris exhibited two enlarged photographs of the *Castilleja* Rubber-tree of Central America (see *Trans. Linn. Soc. Botany*, 2nd ser. vol. ii. part 9). The larger photograph illustrated the manner in which trees were treated to extract rubber, by a special cut from above downwards. Trees of ten years old and upward are said to yield about eight gallons of milk at the first bleeding. This milk is coagulated by the use of the juice of *Calomictyon speciosum*, and the rubber prepared by washing and pressing. Mr. Morris described the habit and growth of the trees in their native forests, and expressed the opinion that for cultural purposes this rubber-tree may be better suited to the circumstances of planters than any other. It could be utilised as a shade tree in cacao and coffee plantations, and yield at the end of ten years at the rate of twenty shillings per tree in marketable rubber. In British Honduras trees are tapped for rubber every three or four years.—Mr. A. D. Michael exhibited living specimens and preparations of an *Argas*, received from Mrs. Crawford, the State Entomologist of Adelaide, Australia. The insects in question appear to be identical with the much-dreaded *Argas persicus*, Fischer, the bite of which was supposed to cause madness and death.—Mr. H. N. Ridley made remarks on specimens in spirit and drawings of species of *Coryanthes*, viz. *C. macrantha*, Hook., and *C. maculata punctata*. He mentioned that Mr. Rodway, of Demerara, had lately published observations showing that the statement of Cruger, hitherto believed, as to the fertilisation by bees, did not obtain in all the species; inasmuch as in *C. speciosa* he (Mr. Rodway) had noticed that a kind of green fly was the fertiliser.—Mr. Geo. Murray exhibited specimens of *Rhipilia* in spirit from Grenada, West Indies, obtained at a depth of five fathoms.—Mr. W. Fawcett, exhibited coloured drawings of *Hydnora abyssinica* and *H. bogosensis*, sent by Signor Beccari from Florence. They clearly showed the difference between the two species, in colour, and in the former having a book-like process below the apex, and its ramiferous surfaces have long ramenta at their margins. Both species differ from *H. africana* in the ramiferous surfaces not extending to the apex.—Mr. C. T. Musson drew attention to a branch of a blackthorn, obtained near Newark, showing a curious malformation of the branchlets.—Dr. Maxwell Masters read a paper on the peculiar conformation of the flowers of *Cypripedium*. The explanation may be sought in the course of development, in the minute anatomy and arrangement of the fibro-vascular bundles, and in the examination of the comparative morphology of the flower; organogeny affords in this case only doubtful testimony, as the flower is irregular from the first. The distribution of the primary fibro-vascular bundles, and of the offshoots from them, affords more conclusive evidence of the true construction of the flower, and if studied in conjunction with the comparative morphology leads to very satisfactory results. By these means it becomes easy to refer the flower to the ordinary type seen in a regular pentacyclic and trimerous monocotyledon, and from which it is reasonable to infer it may have originated. The deviations from the type have arisen from concrescence or inseparation of some parts, inordinate development of others, and complete suppression of a third series. The author cited instances showing numerous intermediate gradations between the ordinary conformation of *Cypripedium* and that of the ideal type trees, proving that what was, at first, a matter of speculation and inference from imperfect evidence, was borne out by actual facts. The illustrations brought forward afforded examples of the reduction of parts and the increased number of parts, in connection with which the author alluded to the special tendency to develop the second or inner row of stamens, as happens in Restiaceæ and Xyridaceæ, while in Iridaceæ the opposite tendency is manifested. Another series of illustrations comprised cases of regular and of irregular *Peloria*, which were of special importance as affording evidence on the one hand of the probable past conformation of the flower, and on the other of the probable course of development in the future.—The fifth and concluding part of the Rev. A. Eaton's monograph of recent Ephemeridæ or may-flies was read. The author says 55 genera and 270 species have been characterised, in addition to 11 nymphs and 19 species of doubtful position; 5 genera and 68 species are new to science.—Mr. J. G. Baker read a paper entitled “Further Contributions to the Flora of Madagascar,” in which upwards of 250 new plants, seven of them new genera, gathered recently by the Rev. K. Baron, F.L.S., are described. Of the new genera, one belongs to *Malvaceæ*, one to Geraniaceæ near *Impatiens*, one to Rubiaceæ.

h to Melastomaceæ and Compositæ. Of well-known Cape es, *Pelargonium*, *Stoebe*, *Cineraria*, and *Belmontia* are now the first time added to the Madagascar flora. The faint nity of the flora of Madagascar to that of India and Malaya strengthened by the di-covery of the genus *Cyclea*, and of new ies of *Alyxia*, *Didymocarpus*, and *Strobilanthes*. Of types economic interest there are new species of *Dalbergia*, *Macar- pa*, *Strychnos*, *Balsamolendron*, and *Garcinia*. It seems that ring the last ten years between 1100 and 1200 new plants from idagascar (29 of which are new genera) have been described the *Journal* of the Linnean Society and *Journal of Botany*, rily all of them collected by our own countrymen.

Chemical Society, November 18.—W. Crookes, F.R.S., ce-President, in the chair.—The following papers were read : *Researches on the relation between the molecular structure of bon compounds and their absorption-spectra* ; part 8, a study coloured substance, and dyes, by W. N. Hartley, F.R.S.— *ectroscopic notes on the carbohydrates, and albumenoids from uin*, by W. N. Hartley, F.R.S.—*Preliminary note on the ctrolysis of ammoniac sulphate*, by Herbert McLeod, F.R.S. The preparation and hydrolysis of hydrocyanides of the di- tones, by Francis R. Japp, F.R.S., and N. H. J. Miller, Ph.D. The action of salicylic aldehyde on sodium succinate in pre- ence of acetic anhydride, by Gibson Dyson.—The reduction of rites to hydroxylamine by hydrogen sulphide, by E. Divers, R.S., and T. Haga.—*Note on some double thio-sulphates*, by B. Cohen, Ph.D.—*Preliminary note on the action of triphenyl- thyl bromide on ethyl sodio-malonate*, by George G. Hender- n, M.A., B.Sc.—*Action of silicon tetrachloride on aromatic ido-compounds*, by Arthur Harden, B.Sc.

Physical Society, November 27.—Prof. W. G. Adams in e chair.—The following papers were read :—*On a method of asuring the coefficient of mutual induction of two coils*, by of G. Carey Foster, F.R.S. The two coils are for conve- nience designated by *P* and *S* (primary and secondary). The ethod as originally devised consists of two parts : (1) observing e swing of the needle of a galvanometer placed in series th the secondary coil when a current of strength γ is started he primary ; (2) placing the galvanometer and a condenser known capacity, *c*, as a shunt between two points, *A* and *B*, he primary circuit, such that the first swing of the galvano- eter needle on completing the primary is the same as in (1). is easily seen that under these conditions $M = cr\gamma_1$, where *M* he coefficient to be determined, *r* = resistance between the ints *A* and *B*, and r_1 = resistance of galvanometer and ondary coil. The method requires the value of γ to be the e in the two experiments, and facilities for varying *r* with- t altering γ . To overcome these difficulties the arrangement s been modified so as to make it a null method. The con- ditions remain the same as in (2), excepting that the ends of e secondary coil are connected to the terminals of the galvano- eter through a variable resistance with no self-induction. If be the resistance of the secondary coil and variable resistance en adjusted, so that, on completing the primary circuit, the egral current through the galvanometer is zero, it is shown at $M = cpr$, where *c* and *r* have the same meaning as before. r let *A* and *E* be the potentials of the galvanometer terminals any time, *t*, *g* the resistance of galvanometer, *y* the current rough it, and *N* and *L* the coefficients of self-induction of the lvanometer and secondary coil respectively. Then consider- g the path from *A* to *E* through the secondary coil we have—

$$A - E = px + L \frac{dx}{dt} - M \frac{dy}{dt}$$

or path through galvanometer—

$$A - E = qy + N \frac{dy}{dt}$$

Equating these, and integrating from $t = 0$ to $t = \infty$, we get—

$$p \int_0^\infty x dt - M\gamma = 0.$$

the $\int_0^\infty x dt$ = charge of condenser,

$\frac{M\gamma}{p} = cr\gamma_1$.

a telephone. By inversion, the method could be used for determining the capacity of condensers in absolute measure if *M* be known. The author thinks the method will be useful for dynamo-machines, and gave a series of numbers obtained by experiments on different coils, showing that it gives consistent results. Mr. C. V. Boys suggested that, by arranging a switch to change the connections from (1) to (2) in rapid succession, a steady deflection might be obtained, and thought that this would enable very small coefficients to be determined. Remarks by Prof. Forbes, Prof. Adams, and Prof. Perry were answered by Prof. Foster and Dr. Fison.—On the critical mean curvature of liquid surfaces of revolution, by Prof. A. W. Rücker, M.A., F.R.S. The paper is chiefly mathematical, and deals with liquid surfaces of revolution attached to two circular rings, the planes of which are at right angles to the line joining their centres. By "mean curvature" the author designates *half the sum of the reciprocals of the two principal radii of curvature of the surfaces*. Maxwell has shown in his article on "Capillary Action" ("Encyclopædia Britannica"), that, if the film be a cylinder, a slight bulge will cause an increase or decrease in the

mean curvature according as the length is $<$ or $>$ $\frac{\pi}{2}$ times the

diameter. If $l = \frac{\pi}{2} d$, then a small change in the volume of the

surface will modify its form, but will not alter the mean curvature. Thus the mean curvature of such a cylinder is evidently a maximum or minimum with respect to that of other surfaces of constant mean curvature, which pass through the same two rings at the same distance apart, and which differ but little from the cylindrical form. Hence the cylinder may be said to have a *critical*

mean curvature when the distance between the rings is $\frac{\pi}{2}$ times

their diameter. If the distance between the rings is altered, a similar property is possessed by some other surface. The author's paper investigates the general relation between the magnitude and distance apart of the rings, and the form of the surfaces of critical curvature. If *x* is the axis of revolution, then the equation to a liquid surface of revolution is given by the expressions—

$$x = \alpha E + \beta F, \quad y^2 = \alpha^2 \cos^2 \phi + \beta^2 \sin^2 \phi,$$

where *F* and *E* are elliptic integrals of the first and second kinds respectively, of which the amplitude is ϕ , and the modulus $K = \sqrt{\alpha^2 - \beta^2}/\alpha$ as usual, $\Delta = \sqrt{1 - K^2} \sin^2 \phi$, whence $y = \alpha \Delta$, and if $K = \sin \theta$, then $\beta = \alpha \cos \theta$, and since $\alpha > \beta$, α and β are the maximum and minimum ordinates. The results show that as θ increases from 0° to 90° , the surface of critical mean curvature is an unduloid with limits of cylinder and sphere, when $\theta = 0^\circ$, and $\theta = 90^\circ$ respectively. When θ passes from 90° to 180° , the surface is a nodoid with limits of sphere and a circle whose plane is perpendicular to the surface of revolution. In the third quadrant the surface is still a nodoid the limits of which are a circle and the catenoid. Finally, in the fourth quadrant the surface is an unduloid, the limits being the catenoid and cylinder. Experiments were shown proving that with cylindrical

films, where $l < \frac{\pi}{2} d$, increase of internal pressure produced a

bulging, whereas if $l > \frac{\pi}{2} d$, a bulging was produced by decrease

of pressure. From this it is evident that if the interiors of two

cylindrical films, whose $l < \frac{\pi}{2} d$, be connected, stable equilibrium

will result, whereas if $l > \frac{\pi}{2} d$, there will be unstable equilibrium.

These facts were illustrated experimentally with great success. After some remarks by Mr. C. V. Boys, the proceedings terminated.

Anthropological Institute, November 23.—Francis Galton, F.R.S., President, in the chair.—The election of Mr. C. W. Rosset as a Corresponding Member was announced.—Prof. A. H. Keane read a paper, by Consul Donald A. Cameron, on the tribes of the Eastern Soudan.—The Assistant Secretary ex-

hibited, on behalf of Mr. J. Olonba Payne, nine symbolic letters (Aroko) as used by the tribe of Jebu in West Africa.—The Secretary read a paper, by Mr. T. R. Griffith, on the races inhabiting Sierra Leone.—The Rev. George Brown gave a brief résumé of his paper on the Papuans and Polynesians, the reading of which was adjourned till the next meeting.

PARIS

Academy of Sciences, November 29.—M. Daubrée in the chair.—The medal prepared by the youth of France to commemorate the centenary of M. Chevreul, was presented to the President of the Academy, with some appropriate remarks by M. de Quatrefages. The medal, which is a fine work of art by M. Roty, bears on one side a bust of the illustrious *savant*, and on the reverse his full figure, seated in an armchair, in an attitude of study, with the legend "La Jeunesse française au Doyen des Étudiants, 31 Août, 1786—31 Août, 1886." After defraying the expenses of this and another medal of smaller size, a copy of which will be supplied to all subscribers, the Committee has a large balance in hand, which it proposes to utilise by issuing a complete *Catalogue raisonné* of M. Chevreul's works.—Remarks on the 210th volume of the *Connaissance des Temps* (for 1888), presented to the Academy by M. Faye.—A contribution to the history of the decomposition of the amides by water and the diluted acids, by MM. Berthelot and André. These studies have been undertaken for the purpose of better determining the degree of stability, in presence of the acids, of some typical amides, which play an essential part in the tissues of organised beings, such as urea, asparagine, and others.—Glycose, glycogene, and glycogeny, in relation to the production of heat and of mechanical power in the animal system, by M. A. Chauveau. In this second communication the author deals with combustion and the development of heat in the organs while at work. In this state of physical activity the quantity of glycose which disappears in the capillaries is increased, and is in proportion with the excessive activity of the combustions excited by the play of the organs.—Fluorescences of manganese and bismuth, by M. Lecoq de Boisbaudran. In this preliminary paper three conditions are considered: (1) a single solid dissolvent and two active substances, each fluorescing with this dissolvent; (2) a solid dissolvent and two active substances, of which one alone fluoresces with the dissolvent; (3) two solid dissolvents and one active substance fluorescing with each of the dissolvents.—Treatment of the grape-vine with the salts of copper against mildew, by MM. Crolas and Raulin. Quantitative analyses are given of the amount of copper detected in the products of vines treated by this process. Although the actual quantity is never really dangerous, special precautions are recommended in all cases where the grape is intended for consumption.—On the phosphates and arseniates of silver, by M. A. Joly. The precipitated triargentic phosphate, PO_3Ag_3 , obtained by double decomposition, is shown to be amorphous, easily dissolving in phosphoric acid even at a low temperature. The limits are determined within which the concentration of the phosphoric solution should be varied in order to obtain at pleasure the crystallised triargentic phosphate or the diargentic phosphate, PO_3Ag_2H .—On some coloured reactions of the titanate, niobic, tantalate, and stannic acids, by M. Lucien Lévy. Some new specific characters of these acids are described, the reagents employed being substances which nearly always present a phenolic function. Hence reciprocally these latter may in their turn be characterised by the same mineral acids.—On the conditions favourable to the restoration of the elements of the transparent cornea, by M. Gillet de Grandmont. These conditions are shown to be suppression of the suppuration, absolute repose, and absence of all intervening irritation.—On a process for intensifying the normal virulence of the microbe of symptomatic charbon, and restitution of the original activity after attenuation, by MM. Arloing and Cornevin.—Note on some essays in antituberculous vaccination, by M. Vittorio Cavagnis. These experiments were made according to M. Pasteur's method, on some rabbits and guinea-pigs, with but partial success. The author is now endeavouring to ascertain whether this method of vaccination is at all applicable to tuberculosis.—On the conformation of the external reproductive organs in the female of the anthropoid apes of the genus *Troglodytes*, by M. A. T. de Rochebrune.—Observations on the continuous blastogenesis of *Botryllodes rubrum* (Milne-Edwards), by M. S. Jourdain.—New methods of preparing the crystallised carbonates, by M. L. Bourgeois.—The Uralian

Society of Naturalists informs the Academy that it is organising an Ekaterinburg, Russia, a Scientific and Industrial Exhibition for Siberia and the Ural Mountains, which will be opened on May 15/27, 1887, and closed on September 15/27 following.

STOCKHOLM

Academy of Sciences, November 10.—On a recently discovered map of Scandinavia and parts of the North Atlantic, edited, in 1539, by Olaus Magnus, a Swedish Catholic clergyman, by Baron A. E. Nordenskjöld.—On the mineral thorite, from two new localities, by the same.—On the Quaternary strata of the Isle of Gothland, by Herr H. Munthe.—On the development of bi-periodic functions in the series of Fourier, by Dr. C. Charlier.—Contributions to the knowledge of the inflorescence and fructification of the Scandinavian alpine plants, by Dr. C. Lindman.

BOOKS AND PAMPHLETS RECEIVED

Histoire Générale des Races Humaines: A. de Quatrefages (A. Hennuyer, Paris).—Microscopic Fungi, 5th edition: Dr. M. C. Cooke (Allen).—The Greyhound: H. Dalziel (Gill).—British Dogs: H. Dalziel (Gill).—British Cage-Birds: K. L. Wallace (Gill).—On the Conversion of Heat into Work: W. Anderson (Whittaker).—Lives of the Electricians: W. T. Jeans (Whittaker).—Clark's Transit Tables for 1887: L. Clark (Spon).—A Text-Book of Steam and Steam-Engines: Prof. A. Jamieson (Griffin).—Outlines of Quantitative Analysis: Prof. A. H. Seaton (Griffin).—Studien über Protoplasma mechanik: Dr. G. Berthold (Felix, Leipzig).—Proceedings of the Queensland Branch of the Geological Society of Australasia, vol. i. (Watson, Brisbane).—A New Department in Science: Dr. C. Radcliffe (Macmillan).—The Mystery of God, 2nd edition: T. V. Tymms (Stock).

CONTENTS

	PAGE
Comparative Anatomy of Vertebrates	121
Science in Norway	122
Our Book Shelf:—	
"Acta Mathematica"	123
Shenstone's "Methods of Glass-Blowing"	123
Letters to the Editor:—	
Two Hours with a "Subject Index."—Justitia	123
The Origin of Species.—Dr. George J. Romanes, F.R.S.	124
Heredity in Abnormal-Toed Cats.—William White	125
Algebraic Notation of Kinship.—Prof. Alexander Macfarlane	126
Seismometry.—Thomas Gray	126
Botanical Lecture Experiment.—Prof. Bayley Balfour	126
A Lecture Experiment on the Expansion of Solids by Heat.—C. E. Stromeyer	126
Meteors and Auroras.—Dr. M. A. Veeder	126
The Guthrie Memorial Fund	127
Volcanic Eruption in Niua-fu, Friendly Islands. By Prof. T. G. Bonney, F.R.S.	127
Fourth Annual Report of the Fishery Board for Scotland	128
The Electric Charge on the Atom. By A. P. Laurie	131
Music and Mathematics. By Prof. J. J. Sylvester, F.R.S.	131
Notes	131
Our Astronomical Column:—	
Corrections to Refraction Tables	131
Comet Finlay (1886 e)	131
Comet Barnard (1886 f)	131
Astronomical Phenomena for the Week 1886	
December 12-18	131
The Law of Storms in the Eastern Seas. By Dr. W. Doberck. (With a Map)	131
Earthquake in Sierra Leone. By J. S. Hay and Jos. M. Metzger	14
Scientific Serials	14
Societies and Academies	14
Books and Pamphlets Received	14

THURSDAY, DECEMBER 16, 1886

THE PALISSY OF CALICO-PRINTING

The Life and Labours of John Mercer, F.R.S. By Edward A. Parnell. (London: Longmans and Co., 1886.)

THE subject of this memoir was one of the most remarkable men of his time. A son of the soil, and almost wholly self-taught, he effected what was practically a revolution in one of our staple industries by his discoveries in technical chemistry and by his application of chemical principles to the dyer's art. With no laboratory training other than that which he gave himself, he by his skill and sagacity as an experimentalist added enormously to the resources of a great industry: owing nothing to academies, and uninfluenced by schools of learning, he made himself master of the chemical philosophy of his time, and by the acuteness and originality of his speculations he has permanently influenced the development of theoretical chemistry. In Lancashire, the scene of his work, the name of John Mercer is held in hardly less esteem than that of John Dalton; and probably to many people in Cottonopolis the director of the Oakenshaw Print-Works was a far more important personage than the old Quaker in George Street, who gave lessons in the *New System of Chemical Philosophy* at the rate of half-a-crown an hour. The Atomic Theory has doubtless contributed much to the intellectual greatness of Manchester, and Manchester men are not ungrateful: they have named one of their streets after its illustrious author. Still calicoes and calico-printing are what they have to live by, and although they have not yet, so far as we know, named a street after John Mercer, they have shown, by the widespread adoption of his processes, a very practical appreciation of the value of his labours.

John Mercer is the Palissy of calico-printing. Not that there was anything in the least degree tragic in the life of the Lancashire dyer; his career was one of almost uninterrupted success, and his domestic peace was unclouded. But he had the great potter's indomitable will and fixity of purpose; his unwearied patience and unremitting industry. Both men had the same high ideal of their art and the same contempt for false work. Each began his life at the bottom rung of the social ladder, and each found his life's work in a direction other than that in which he set out. Both were men of strong religious feeling, and both left the faith of their forefathers in compliance with the dictates of principle, but with this difference, that whilst the Huguenot artist found the Bastille and death, John Mercer could build his Sunday-schools in peace and quietness, and find contentment in a standard of doctrine which Mr. Matthew Arnold has characterised as the product of a mind of the third order.

John Mercer was born on February 21, 1791, at Dean, near Blackburn. His father was originally a hand-loom weaver, but the development of the factory system had led him to take to agriculture. He died when the son was barely nine years old, and John was set to work as a "bobbin-winder." A pattern-designer belonging to the Oakenshaw Print-Works, in which Mercer was destined to play so considerable a part, gave him his first lessons in

reading and writing; and the Excise-surveyor at the same works (it was in the days when each square yard of printed calico paid an Excise duty of threepence) taught him the elements of arithmetic. He soon became noted for his aptitude at figures, and later on for his skill in music; and for a time he found a congenial exercise for his artistic faculty in the band of a militia corps. Music remained a passion with him throughout his life, and although, we are told, a man of great self-possession, he was sometimes entirely overcome by it. Mercer was sixteen years of age, and had settled down apparently to the work of a hand-loom weaver, when a very slight incident—as slight as that which made Palissy a potter—gave an entirely new direction to his thoughts. His mother, it appears, had married again. Visiting her one day, John was so much struck with the orange colour of the dress of his little step-brother on her knee, that, to use his own words, he "was all on fire to learn dyeing." He had no means of obtaining instruction: he had no book on the subject, nor could he procure any receipts. He found, however, that the dyers of Blackburn, some five miles distant, obtained their materials from a certain druggist in that town. Mercer repaired to him, and requested to be supplied with materials for dyeing. "What do you want?" inquired the shopman. "I can't tell you," replied John; "will you tell me the names of all the different materials you sell the dyers here?" "Oh, I sell them peach-wood, Brazil-wood, logwood, quercitron, alum, copperas, and others," mentioning their names. Mercer reckoned his money, and found he could afford threepence for each dye-stuff. Armed with these articles he returned home, "full," as he says, "of dyeing and dyeing materials." He seems to have been fortunate in obtaining the use of a convenient place for his experiments, where he had all the necessary apparatus for small trials. Here he commenced entirely by "rule-of-thumb"; but by industry and close observation he acquired considerable knowledge of the properties of dye-stuffs, and ascertained the methods of dyeing in most of the colours then in vogue.

To become a dyer was now the dominant idea of Mercer's life. Everything comes to him who waits, and fortunately for Mercer, as it seemed at the time, he had not to wait long. The Messrs. Fort, the proprietors of the Oakenshaw Print-Works, heard of the success of his dyeing experiments, and offered him an apprenticeship in the colour-shop of their factory. It was one thing to get inside a colour-shop and quite another to get any information there. No workmen are more jealous of their *arcana* than the foremen of colour-shops: their knowledge even to-day is almost entirely empirical, and their secrets are invested with a degree of mystery which is frequently ludicrously disproportionate to their value. After ten months' irksome labour Mercer's indentures were cancelled. The Continental disturbances of 1810 reacted disastrously upon all industries connected with the cotton manufacture, and the "Berlin decree," which led to the destruction of all printed calicoes and other goods of English manufacture then in bond in certain European States, was severely felt by the Lancashire printing establishments. Mercer was forced for a time to abandon the calling of a colour-mixer, and to return to his work at the hand-loom. But his brains were still among his colour-pots. It was characteristic of the man,

that, being in Blackburn to procure a marriage license, he should be led to a secondhand bookstall in the marketplace to search for printed matter relating to his favourite art. At a time when Mary Wolstenholme might properly consider him as more anxious about the *res angusta domi*, he was engaged in negotiating the purchase of "The Chemical Pocket-Book; or, Memoranda Chemica, arranged in a Compendium of Chemistry, by James Parkinson, of Hoxton." This book, together with "The Tables of New Nomenclature, proposed by Messrs. De Morveau, Lavoisier, Berthollet, and De Fourcroy, in 1787," opened out a new world to him. He had, at the very outset of his trials, convinced himself that it was only by a thorough knowledge of the properties of dyeing materials, and of their behaviour under varying conditions, that the operations of the dyer can be intelligently carried on: he now saw that all this knowledge must primarily depend upon chemical science, and that it was on chemistry that the extension of his art must ultimately rest. This view of the relations of science to practice strengthened with Mercer's experience. Years afterwards, when he had attained to fame, he was called upon to express his opinion concerning the necessity of technical education in this country. "I entirely concur with you," he wrote to a friend, "that for the preservation and benefit of the British arts and manufactures, the masters, managers, and skilled artisans ought to be better instructed in the *rationale* and scientific principles involved in their operations. Chaptal remarked that 'practice is better than science' (*i.e.* abstract principles), 'but when it is necessary to solve a problem, to explain some phenomenon, or to discover some error in the complicated details of an operation, the mere artisan is at the end of his knowledge, he is totally at a loss, and would derive the greatest assistance from men of science.' Probably no person would, from his own experience, confirm the above remark, as regards the art of calico-printing, more heartily than myself." He observed that, "as regards good practical men, no district could excel Lancashire; but in all the processes, from the grey piece to the finished print, embracing thirty to forty operations, both the science and practical experience of the cleverest are requisite to keep all things straight and to detect the cause of, and rectify, mishaps. . . . An amusing volume might be written about ludicrous mistakes, and equally ridiculous attempts to rectify them."

Mercer's first important invention in calico-printing was made in 1817, and curiously enough it was in the application of a colour akin to that which had fired his ambition to become a dyer. He found in the alkaline sulphantimoniates an excellent medium for procuring a bright orange colour on cotton fabrics. Heretofore no good orange suitable for the use of the calico-printer was known. The best orange was made from a mixture of quercitron yellow and madder red, but it was difficult to adapt it to other colours in the styles then in demand. Mercer's antimony orange supplied the want: it was not only a fine colour in itself, but was capable of being combined and interspersed in a great variety of styles. This discovery led to his re-engagement at the Oakenshaw Works: after a seven-years' service he was admitted as a partner, having as a co-partner, for a while, Richard Cobden; and he remained connected with the firm until

its dissolution in 1848, when he retired from business with a moderate fortune.

It would be difficult in the space at our disposal to do full justice to the many discoveries and improvements which Mercer introduced into the art of dyeing and printing. His skill and energy led not only to the invention of new styles and new colours, but to the development even of new branches of chemical industry. His application, for example, of chromium compounds practically created the manufacture of bichrome: when Mercer first began experimenting with this substance its cost was half-a-guinea an ounce; it is now produced by the hundreds of tons, and may be bought retail at less than sixpence per pound. Some of his processes are, of course, obsolete, but many are still in use: the "manganese bronze," for example, which he introduced in 1823, seems to re-appear about every ten years, and was in large demand some three or four years since. Mercer was an indefatigable experimenter: nothing is more extraordinary than his skill and inventiveness in the application of his new colours to the creation of fresh styles or novel combinations; his genius in this respect was almost kaleidoscopic.

One of the greatest improvements made by Mercer in the operations of the dyer was his introduction of the alkaline arseniates in what is called the "dun-*ging*" operation, the object of which is to remove that portion of the mordant which has not become insoluble and firmly attached to the fabric by the process of "ageing." The loosely-attached mordant, unless previously removed, would dissolve in the dye-bath, to the injury of the whites and the deterioration of the dyeing liquor. Of scarcely less importance was his method of preparing mixed cotton and woollen fabrics so as to enable the mixed fibres to acquire colouring-matters with equal readiness. His observation of the extraordinary facility with which certain "lakes," or compounds of alumina with organic colouring-matters, are dissolved by oxalate of ammonia led to the introduction of a method of using aluminous colour-precipitates in steam colour-work, which was extensively employed in the East Lancashire print-works. And lastly, his method of preparing stannate of soda was not only of service to the calico printer by greatly cheapening an indispensable agent, but was of considerable pecuniary benefit to himself.

Mercer's skill and knowledge were ungrudgingly given to the fellow-workers in his art, and he was constantly appealed to by the calico-printers and chemical manufacturers of Lancashire for assistance and advice. His acquaintance with the literature of the abstract chemistry of his time was very remarkable. He had indeed all the essential qualities and instincts of the scientific mind: there was a certain comprehensiveness about the man, a certain vigorous grasp of general principles, and a largeness of view which made his influence felt at once among men of science. There is no question that had Mercer devoted himself to pure science he would have attained hardly less distinction than he has secured as a technologist. His method of work was essentially scientific. Thus no sooner did he become acquainted with the doctrine of chemical equivalents than he had the strengths of his chemicals and reagents adjusted to a simple relation of their equivalents. Mercer indeed was

one of the earliest workers in volumetric analysis; in 1827 he devised a method of valuing bleaching-powder and bichrome by means of standard solutions. His speculations on the nature of white indigo, on the constitution of bleaching-powder, and on the ferrocyanides and nitroprussides were much in advance of his day. His theory of catalysis, which he illustrated by many striking and original examples, was extended by Playfair, and has been subsequently worked out by Kekulé as the only satisfactory explanation yet given of a very remarkable and interesting group of phenomena. Graham's early experiments on the heat of chemical combination and the nature of solution induced Mercer to test the practicability of effecting the partial separation of different hydrates by some process of fractional filtration. These experiments, made from a purely scientific stand-point, resulted in the discovery of the mode of action of the caustic alkalis on cellulose, and led to the process which has come to be known as "mercerising," in which cotton fabrics are "fulled" by their contraction on treatment with caustic soda. Mercer appears to have been the first to notice the remarkable solvent action of an ammoniacal copper solution on cotton, which could be re-precipitated as almost pure cellulose by the addition of an acid. His habit of searching for first principles led him, as far back as 1854, to speculate on the relations among the atomic weights of the chemical elements, and the constitution of chemical compounds: he brought his views before the Leeds meeting of the British Association in 1858. He was an early worker on photography, and devised several modifications of the cyanotype process adapted to printing on cambric and similar fabrics.

Mercer was one of the original Fellows of the Chemical Society, and he was a juror of the Exhibitions of 1851 and 1862. In 1852 he was elected into the Royal Society. He died, ripe in years and rich in the contentment afforded by the retrospect of a well-spent life, on November 30, 1866.

T. E. THORPE

THE BRITISH INTERNATIONAL POLAR EXPEDITION

Observations of the International Polar Expeditions, 1882-83: Fort Rae. 326 pp. 4to, and 29 plates. (London: Trübner and Co., 1886.)

AT the Polar Conference of Vienna in April 1884 it was declared to be very desirable that the results from all the circumpolar stations should be published by Christmas 1885. This time was not kept strictly by any of the parties. The first Report completed was that of Lieut. P. H. Ray, of the U.S. Army, for Point Barrow, which appeared early in 1886, and this has now been followed by the present volume, which came out in August last.

The other Expeditions, however, have not been idle, for several have issued portions of their Reports: e.g. the French for Cape Horn; the Russians for Sagastyr at the mouth of the Lena; and the Austrians for Jan Mayen; while quite recently the Germans have announced the publication of the results for their two stations—Cumberland Sound and South Georgia.

The British Expedition was from the outset at a serious

disadvantage. It was not until April 2, 1882, that the definite sanction of the Government was obtained, and the party were obliged to sail from Liverpool on May 11 in order to catch the Hudson Bay Company's convoy from Winnipeg. Accordingly the time available for preparations and training was extremely short, and no special instruments could be made.

The party consisted of Captain (now Major) H. P. Dawson, R.A., with two sergeants and a gunner of the same service. The journey was prolonged and fatiguing, lasting three months and a half, and the Expedition only reached its destination at 10 p.m. on August 30. Only one day was thus available for unpacking, &c., before the regular hourly observations commenced.

The start for the return journey was made within three hours of the time of the final observation, and even then it was only owing to a fortunate shift of wind on Lake Athabasca, which opened the ice and allowed the boats to get through, that the party was able to reach Manitoba, with its baggage, in October. Otherwise the instruments must have been left behind for some months, as the Expedition must have completed its journey by sledge.

The observations have been discussed in strict accordance with the International scheme, the units employed being metric and centigrade. The magnetic discussions were carried out by Major Dawson in conjunction with Mr. Whipple. The meteorological work was intrusted to Mr. R. Strachan and Mr. John A. Curtis, of the Meteorological Office.

The magnetic observations are specially interesting, from the proximity of the station to the magnetic pole. The disturbances were therefore of great frequency and violence, as will be seen from the plates to the volume. The auroral journal also affords a copious store of information on that subject.

The following few results, which we extract from the observations made by the Expedition, will be of interest to our readers:—

The barometer at Fort Rae varied between 771 mm. (30·35 inches) and 721 mm. (28·39 inches), with a maximum daily range of 24 mm. (0·94 inch), and the least of 0·7 mm. (0·03 inch).

The highest thermometer-reading recorded by the Expedition was 25·6 C. (78·1 F.), whilst the lowest was - 44·6 C. (- 48·3 F.) in the air, the terrestrial radiation instrument registering - 46·7 C. (- 52·1 F.).

On the coldest day experienced (January 3) the mean temperature of the twenty-four hours was - 41·9 C. (- 43·4 F.), whilst that determined for the hottest day (August 13) was 19·9 C. (67·8 F.), giving an extreme range of average daily temperature of 61·8 C. (111·2 F.).

The highest mean velocity of the wind recorded any day was 8·5 metres per second (19 miles per hour) from the north-north-west.

The average magnetic declination at Fort Rae was 40° 20' E., the extreme change observed in the diurnal range being 11° 25'. On the most quiescent day the angular motion of the needle was 0° 17', both values largely exceeding movements observed in these latitudes.

The dip or inclination of the needle was 82° 55', whilst the measured values of the total and horizontal magnetic forces were 0·62 and 0·08 electrical units respectively.

OUR BOOK SHELF

Natural History, its Rise and Progress in Britain, as developed by the Life and Labours of Leading Naturalists. By Alleyne Nicholson, M.D., D.Sc., Regius Professor of Natural History in the University of Aberdeen. British Science-Biographies. (London and Edinburgh: W. and R. Chambers, 1886.)

THIS little octavo volume of about 300 pages is a readable book, and accurate in its information as far as it goes. But, besides being sketchy—which is no doubt a fault incidental to the form of the series—it is strangely ill-balanced. In the first place, the author has travelled beyond the limits of his title by giving biographical sketches of Aristotle, Linnæus, Lamarck, and Cuvier—together constituting more than a third of the whole number of "British Science-Biographies" with which they are intermingled. In the next place, as regards the "British Science-Biographies" which are given, there is no proportion observable between the relative magnitudes of these British biologists and the amount of notice which is respectively bestowed. Running the eye over the table of contents, we find that separate chapters are devoted to eleven "leading naturalists" of this country. These, of course, must be understood by his general readers, for whom the book is designed, as representing what, in the author's opinion, are the eleven greatest names in the records of British biology. Yet six of these names are Sir Hans Sloane, Gilbert White, Alexander Wilson, William Swainson, Edward Forbes, and Robert Chambers! To take only the first and last of these names, surely when a whole chapter, with a portrait, is devoted to Sir Hans Sloane, it is remarkable that no mention at all should be made of Sir Joseph Banks; or that, when another whole chapter is assigned to Robert Chambers, we should nowhere encounter the name of Robert Brown. It appears to us that when a Professor of Natural History undertakes to popularise his science, his aim should be to place before what this writer calls "unprofessional readers" a true conception of the merit that attaches to solid work in science, as distinguished from the celebrity that belongs to a graceful writer or to an interesting personal character. He should endeavour to raise the popular mind to a just appreciation of *naturalists*: he should not pander to the already accomplished popularity of *authors*. Now, if this has been the aim of Prof. Nicholson—and in his preface he says as much—in our opinion he has shot wide of his mark. But, as before observed, if his object has been to produce a readable assemblage of short biographies, calculated to suit the popular taste, we should say he has every reason to be satisfied with the result.

The Journal of the Royal Agricultural Society of England. Part II., 1886. (John Murray, Albemarle Street.)

THE current number of this *Journal* furnishes an excellent illustration of the wide limits of agricultural science, and the varied knowledge required of its professors. There is perhaps no art or occupation which so directly requires elucidation from so many sciences; hence the varied nature of the bill of fare provided by the *Journal* Committee of the Royal Agricultural Society. In proof of this assertion we may take the contents of the entire volume for 1886, the second part of which lies before us. Pathology is treated of in papers upon foot-and-mouth disease; Pasteur and his work; lung parasites, by the late T. Spencer Cobbold, M.D.; and abortion in cows. Anatomy and physiology are the topics in Prof. Brown's paper upon organs of the animal body, their forms and uses. Chemistry and botany are amply represented in reports by Mr. Carruthers and Dr. J. Augustus Voelcker. Entomology in the form of papers on the recent appearance of the Hessian fly is the theme of Miss E. A.

Ormerod. Social science is illustrated by Mr. H. M. Jenkins's report upon farming and agricultural training in reformatory and industrial schools, and engineering in the report of the Judges on the Exhibition of Implements at Norwich.

The more immediately agricultural information is embodied in many interesting papers, among which may be mentioned continued reports upon field and feeding experiments at Woburn; experiments on ensilage conducted at Crawley Mill Farm, Woburn; report on the prize-farm competitions in Norfolk and Suffolk, 1886; the report on the Exhibition of Live-Stock at Norwich; and lessons from the winter of 1885-86.

The number issued during the past month also contains the examination papers on agricultural education set during the present year, and much statistical information useful to agriculturists. With such a large mass of material at hand, it is by no means easy to compress remarks into the limits of a short notice. The names of the authors of the various contributions is a guarantee of their value, and any person who desires to keep pace with scientific agriculture, whether actually engaged in agricultural pursuits or not, will do well to peruse these pages. The most interesting papers, and those containing the newest information on subjects of vital interest to us, are as follows:—(1) An inquiry into several outbreaks of abortion in cows, by C. J. B. Johnson, L.R.C.P., who traces most of the cases to the presence of ergot (*Claviceps purpurea*) in grass and hay. (2) Report on ensilage experiments, in which the results are less favourable to this innovation upon old-fashioned practice than some of the apostles of the movement could wish. Silage is found inferior to homely, honest hay and roots. It is true that silage made from green oats showed a distinct superiority, but the question still remains open whether these promising young oats, sacrificed while in the green stage, might not have developed into still greater value had they been allowed to bloom and fructify and bear their thirty, sixty, or perchance a hundred-fold. Promoters of ensilage have little to congratulate themselves on in this result of strict inquiry and accurate tests brought to bear upon their hobby. No doubt they will be equal to the occasion. The prize-farm competition is, as usual, interesting, but it is a matter of regret that, in such a noted county as Norfolk for farming, the best-known agriculturists, whose farming has been the admiration of their countrymen for generations, should apparently have held aloof from the competition. The first prize was awarded to a suburban farm close to Norwich, and but little can be learnt from management carried on under quite exceptional circumstances. It is also a pity that the able officials of the Royal Agricultural Society do not insist upon a greater uniformity in the reports of their judges in the matter of statistics. For purposes of comparison it would be well if some tabular statement could be made out, as for example as to the amount paid in rent, in labour, feeding-stuffs, and trade expenses; also as to the gross and net produce per acre in each case; the yield of corn in bushels, and of roots in tons; the uses made of straw; the amount of work expected per day from horses and men; the hours of labour; the rate of payment for day and for task work, &c. The reader looks in vain for any such comparisons. Statements regarding them he finds in respect of this or that farm, but any plan by which he may compare or note extremes and means he looks for in vain. Considering the many years in which prizes for the best-managed farms have been given, it is a matter for wonder that it is simply impossible to construct any comparative statement as to points of management in the numerous farms inspected and reported upon. Lastly, we must notice Mr. H. M. Jenkins's report on the cultivation of tobacco in the north-west of Europe, a fairly hopeful paper as to the introduction of this cultivation into England. It would ill become the able secre-

tary of our greatest Society to throw cold water on any suggestion made for the good of agriculture, especially in these sad times; but alas for the frosts of June, July, August, and September, which most of our years carry in their bosoms! Gardeners and farmers know them and dread them. Our summers are not to be relied upon, or we should grow tobacco—ay, and grapes!

JOHN WRIGHTSON

Madagascar: an Historical and Descriptive Account of the Island and its Former Dependencies. Compiled by Samuel Pasfield Oliver, late Captain R.A. Two vols. (London: Macmillan and Co., 1886.)

CAPT. OLIVER has made a useful compilation of information on Madagascar in all its aspects. The compilation consists largely of extracts from previous writers. Capt. Oliver himself visited Madagascar a good many years ago, and has naturally taken much interest in the island and its people ever since. It is evident these two volumes must have cost him much labour, which will no doubt be appreciated by those in search of information on Madagascar in a handy form. After an historical sketch, the first volume is devoted to geography, topography, climatology, geology, and natural history. These, in the second volume, are followed by chapters on natural and agricultural products, ethnology, manufactures, administration, trade and finance, bibliography and cartography, and a very long chapter, with appendixes, on the Franco-Malagasy war. The work, we should say, is exceedingly well supplied with maps and plans, of which there are nineteen altogether.

LETTERS TO THE EDITOR

[The Editor does not hold himself responsible for opinions expressed by his correspondents. Neither can he undertake to return, or to correspond with the writers of, rejected manuscripts. No notice is taken of anonymous communications.]

[The Editor urgently requests correspondents to keep their letters as short as possible. The pressure on his space is so great that it is impossible otherwise to insure the appearance even of communications containing interesting and novel facts.]

An Ice Period in the Altai Mountains

M. B. VON COTTA, who once visited the Altai Mountains, is decidedly of opinion that there are no traces of the Ice period on this range. But at the southern part of the Altai, where there are some large glaciers and many ridges covered with eternal snows, there are no doubted traces of a mighty spreading of ancient glaciers. At least this is the conviction I brought back in 1870 from a rapid examination of nearly the same localities as those which have been recently visited by Mr. Bialoveski.

The deposits of ancient glaciers may be observed, far more to the south, on the ranges of Tarbagatay and Saor, the southern limits of the basin of the Irtysh. There are not now any glaciers on Tarbagatay, but some sporadic snow-spots. As to the range of Saor, it attains to the height of 12,500 feet above the level of the sea, and snow always lies there in large masses. But there are no glaciers, properly so called.

Along the northern declivities of these mountains there are at many places large deposits of boulder- or cobble-stones, in great part composed of granite, which forms the crest of both ridges. The boulders are of various rocks and of different sizes, from an inch to some feet in diameter; and they are mingled together in complete confusion, the small boulders being generally well rounded, the large ones more angular, and the intervals being crammed with clay and sand without any traces of layer or assortment. The relation of these deposits to the neighbouring defiles is in most cases incomprehensible. Only at the sources of the River Kenderlik the boulders lie as if the ice which had carried them down had but lately melted. Here, instead of the sections of defiles in the form of the letter V, we find, beginning from the elevation of nearly 3000 feet above the level of the sea, a broad defile with transverse section in the form of the letter U. The walls (or cheeks, as the Russians call them) of this

defile are composed of inclined layers of sandstone and limestone (probably Tertiary deposits), replaced, nearer to the crests, at first by diorite and subsequently by granite. The bottom of the defile is filled up with a close layer of boulder-stones, many of which reach some 10 feet in diameter, the greater number being of gray granite with dark ellipsoidal inclusions. Just the same granite forms the crests of Saor. To the height of 8500 feet the defile rises steeply enough; but after this limit the inclination becomes more faint. Higher up, the defile grows broader, and at the height of 10,000 feet it is stopped up by two deep valleys crammed with close snow, and surrounded by steep snowy peaks. The full length of the layer of boulders reaches some ten English miles, with a direction from south to north.

The Saor chain is a post-Tertiary elevation, but the Altai range certainly arose at a most remote time. It must have formed dry land since the Cretaceous formation at least. Here might be found the solution of the question whether there was on the earth an ice period more ancient than that of which we have evidence in the ice-deposits of Europe and North America. Some facts observed by myself seem to me to show that the question must be answered in the affirmative.

E. MICHAELIS
Oostkamenogorsk, November 3

How to make Colourless Specimens of Plants to be preserved in Alcohol

MANY plants assume a brown colour when placed in alcohol for preservation. The colouring-matter is partly soluble in the alcohol, partly not, and is the product of the oxidation of colourless substances of the cell-sap. This unpleasant change may be prevented in a very easy manner by using acid alcohol. To 100 parts of common strong alcohol add 2 parts of the ordinary concentrated solution of hydrochloric acid of the shops. Parts of plants brought into this liquid while yet living will become absolutely colourless, or nearly so, after the alcohol has been sufficiently often renewed. Such parts as already had a brown colour before, being brought into the mixture, usually retain this character.

By this method colourless specimens may be made of such plants as *Orobancha* and *Monotropa*, which, when treated in the ordinary manner, always become of a dark-brown tint. There are only some species with coriaceous leaves that cannot be treated with success with the acid alcohol; colourless specimens of these must be made by plunging them into boiling alcohol.

The acidity of the mixture here recommended is nearly 0.2 Aeq. A greater quantity of acid is neither noxious, nor does it improve the effect. A lesser quantity was in many cases found not to be sufficiently efficacious. The specimens may remain for months, perhaps for ever, in the acid alcohol without any injury.

If the alcohol, after having been used, is to be decolourised by distillation, the acid should be neutralised by a previously-determined quantity of ammonia or carbonate of soda.

Old specimens, which have become brown in consequence of being treated in the ordinary manner, cannot, as a rule, be decolourised by using the acid alcohol. This, however, may often be done by adding to the alcohol some chlorate of potassa and some sulphuric acid.

HUGO DE VRIES

University of Amsterdam, December 1

Virtual Velocities

DE MORGAN in his "Differential and Integral Calculus," p. 501, says:—

"The principle of virtual velocities, like all other fundamental theorems, has had no proof given of it in the admission of which all writers agree. From its universality and simplicity it may be supposed to be rather the expression of some axiomatic truth than the proper consequence of first principles by means of a long course of regular deduction."

Would you kindly allow me to submit to your readers the following attempt to base the principle of virtual velocities and D'Alembert's principle on easily admitted axioms?

(1) The power of a force imparted to any molecule is (or is measured by) the product of the force itself, and the effective component in the line of the force, of the velocity of the molecule to which the force is imparted, and is positive or negative accordingly as the force and the effective component of the velocity are in the same or opposite directions.

(2) The power of a system of forces, whether imparted to the

same or different molecules, is the algebraical sum of the powers of the individual forces.

From the parallelogram of motions it follows that—

Prop. I. The power of the resultant of a system of forces imparted to a single molecule is equal to the power of the forces. Whence—

Cor. 1. If the forces imparted to a molecule are in equilibrium, their power for any actual or hypothetical motion of the molecule is zero.

Cor. 2. If the forces imparted to a molecule are not in equilibrium, their power for any motion in the direction of the resultant is positive.

Definition.—A system of molecules is said to be passive for a given motion when for that motion the power of its internal forces is zero.

Prop. II. The power of the external forces of a system for actual or hypothetical motions for which the system is passive is equal to the power of the resultant motions of the several molecules of the system.

For (by Prop. I.) the power of the resultant forces for each (and therefore for all) of the molecules is equal to the power of the external together with that of the internal forces, but the latter, in the case of the entire system, is zero by hypothesis.

Cor. 1. If external forces be imparted to a passive system at rest in a given position such that for any hypothetical motion through that position the power of such forces is zero, the system will remain at rest.

For if motion ensued, the resultant and therefore (Prop. I.) the external forces would have positive power for such motion, which is contrary to hypothesis.

Cor. 2. If external forces be imparted to a passive system at rest, and be in equilibrium, the power of these forces for any hypothetical motion of the system through this position of rest is zero.

For as the whole system is at rest each molecule is at rest, and the resultant forces of the molecules are all of them zero, whence their power and therefore that of the external forces (Prop. I.) is zero.

It will be seen that Prop. II. is (or is equivalent to) *D'Alembert's Principle*, and its two corollaries constitute what is called the *Principle of Virtual Velocities*.

It may be urged that this merely relegates the difficulty to determining for what motions systems are passive. This really, however, presents no difficulty, for it is obvious that a system is passive generally when its internal forces neither tend to produce or destroy kinetic energy in the system; so that (1) rigid systems are passive for all motions consistent with their rigidity; (2) all systems are passive for rigid motion; (3) inelastic and theoretically perfect funicular systems are passive; and (4) inelastic and theoretically perfect fluid systems are passive, &c.

D'Alembert's principle and the principle of virtual velocities ought to form the basis of that part of kinetics which involves the idea of the transmission of force, whether the result is motion or equilibrium. D'Alembert's principle is the most general. The principle of virtual velocities is to it what Maclaurin's theorem is to Taylor's. The form in which it is given in Prop. II. above is more convenient for use than that in which it is generally stated, viz. that the resultant forces reversed balance the impressed forces.

Lagrange's proof of the principle of virtual velocities and its modifications are altogether too artificial and unsatisfactory.

CAPE OF GOOD HOPE

F. GUTHRIE

Recent Gales

THE gales of October 16 and December 8 varied considerably. In the former gale there were constant oscillations, from '004 to '010 of an inch, every 30 seconds between 1 a.m. and 2 a.m.; whilst in the December gale there were no oscillations, but a constant fall that was most rapid during squalls. The difference between the dry and wet bulb thermometers in the October gale was only a quarter of a degree, whilst in that of December it exceeded from $2\frac{1}{2}$ to $3\frac{1}{2}$ (or a difference of from thirteen to eighteen times as great). During the gale in October, 1'160 inches of rain fell, and in that of December 0'758 of an inch.

The lowest reading (corrected for temperature) of the barometer at 530 feet above the sea was on October 16, 28'019, and on December 8, 27'693 inches (this occurred at 8 p.m.).

The barometer reduced to sea-level was less than 28'5 inches from 11.30 a.m. of the 8th till 8.15 a.m. of the 9th (or nearly

21 hours). The October gale was W.S.W., and the December gale W.

	Hour	Barometer reduced to sea-level	Temp.	Wet bulb	Diff.	
Oct. 15,	4.15 p.m.	28'880	49'7	49'5	0'2	
	12.15 a.m.	28'811	47'8	47'6	0'2	
	2.15 "	28'699				
	7.45 "	28'591	47'2	47'0	0'2	
	8.30 "	28'668	47'7	47'5	0'2	
	10.0 "	28'744	47'8	47'6	0'2	
	2.45 p.m.	28'941	47'8	47'6	0'2	
	5.0 "	29'042	47'8	46'8	1'0	
	Dec. 8,	2.20 a.m.	29'212			
		3.30 "	29'144			
8.5 "		28'596				
10.0 "		28'561	40'3	38'7	1'6	
2.0 p.m.		28'431	40'3	37'5	2'8	
3.30 "		28'378	37'3	34'7	2'6	
6.0 "		28'287				
7.30 "		28'278				
8.0 "		28'273	39'7	37'0	2'7	
9.0 "		28'286				
9, 12.30 a.m.		28'327	37'0	33'4	3'6	
2.45 "		28'297				
5.50 "		28'342				
10.0 "		28'642	42'0	38'7	3'3	
7'0 p.m.	28'987					
10, 10'0 a.m.	29'339	41'6	38'6	3'0		

The last gale commenced at 1 a.m. on the 8th (with constant squalls of hail and rain), and was most violent from 4.45 p.m. till 8.30 p.m.

Thunder and lightning occurred from 11 a.m. till 11.30 a.m.; and from 4 p.m. till 4.40 p.m. on the 8th, and from 1.35 a.m. till 2.45 a.m. on the 9th.

Much damage was done to house-roofs. Very few trees were blown down here, for in this exposed situation trees are better prepared to resist gales. About 11 feet of the top of a large specimen of *Picea Nobiliana* was destroyed. E. J. LOWE

Shirenewton Hall, Chepstow, December 11

Note on the Manipulation of Glass containing Lead

IN reading Mr. Shenstone's very useful little treatise on glass-blowing (reviewed in NATURE of the 9th inst., p. 123), I have failed to notice any mention of an expedient which I have found very useful for dealing with English flint-glass containing much lead silicate; although I greatly prefer for most purposes the readily fusible "soda-glass" used probably everywhere except in England.¹

Of course, all ordinary flames, such as those of the Bunsen burner and the blow-pipe, consist, in part, of reducing gases which cause the separation of lead from glass introduced into them. This reduction can be prevented or remedied, as Mr. Shenstone says, by holding the glass a little in front of the visible flame; but there is in this region hardly enough heat to do all that is required in the manipulation of the glass.

If, however, oxygen instead of air is used in a Herapath blow-pipe, the resulting flame has so little reducing power, that lead-glass can be safely held well within it; and this is the flame that I always use in dealing with such glass.

It is true that oxygen is, at present, rather more expensive than air; but most, if not all, laboratories have a supply of the gas, either in a gas-holder or a bag, for the optical lantern and other purposes; and with it the manipulation of lead-glass becomes what shaviness is, in certain advertisements, said to be—"a luxury."

H. G. MADAN

Eton College

P.S.—The oxy-coal-gas blow-pipe is also extremely useful for difficultly-fusible "combustion-tubing." Bulbs of fair size can be blown, and side-junctions, &c., made in this glass, with almost the same facility as in ordinary "soda-glass."

¹ The best glass of this kind is that used by Geissler, Alvergnot, and others, for making their marvellous specimens of glass-work; but I doubt if glass of the same excellence, in regard to fusibility and freedom from any tendency to devitrify, is generally procurable.

Fireball of December 4, 1886

THE fireball seen at Stonyhurst College, near Blackburn, on December 4, 9h. 16m., and described in NATURE of December 9, p. 133, was observed here as follows:—

1886, December 4, 9h. 17m., meteor equal ♀. Path from $184^{\circ} + 52^{\circ}$ to $195^{\circ} + 47^{\circ}$, rather swift. At the point $180^{\circ} + 50\frac{1}{2}^{\circ}$ it left a short brilliant streak of about $\frac{1}{2}$ °, which remained visible to the eye for $1\frac{1}{2}$ minute. The meteor gave a distinct flash in the moonlight, and the streak was projected just where the maximum outburst took place.

I have made a preliminary comparison of the observations recorded at the two places, from which it appears that the fireball, when first seen at Bristol, was some 64 miles vertically over a point of the earth's surface near Farnedale, in Yorkshire. Travelling to south west, it evolved an enduring light streak when 49 miles high, near Thirsk, and disappeared near Otley, at an elevation of 28 miles.

These values are derived chiefly from the Bristol observation, but they are somewhat uncertain, because the meteor was at a great distance from that city, and appeared close upon the sensible horizon. According to the Stonyhurst path, the figures are less, the streak being computed at a height of 42 miles near Thirsk, and the end point of the meteor, near Otley, is indicated at only 19 miles above the earth. The observations are extremely discordant in altitude. The exact place of the streak is given by both observers, and if we adopt a mean height of 45 miles we cannot be far wrong.

The apparent radiant-point derived from the two paths is at $137^{\circ} + 59^{\circ}$. Before seeing the Stonyhurst observation, I attributed the fireball to a shower near β Ursæ Majoris, at $162^{\circ} + 58^{\circ}$, from which I saw many swift streak-leaving meteors at the end of November and beginning of December, both in 1885 and 1886. I have a strong suspicion the observed paths of the fireball are slightly in error, both as to direction and length, and that the radiant should be near β Ursæ. In this case the motion would have been from near Guisborough to Harewood at heights of about 68 and 27 miles, but this does not differ materially from the course previously assigned.

In presence of the doubts as to the fireball's exact path in the air, it is most desirable to hear of further observations, and re-investigate it.

W. F. DENNING

Bristol, December 11

THE DISPERSION OF PLANTS BY BIRDS

THE part taken by birds in the dispersion of plants is one of great interest in view of the difficulty of accounting for the appearance of certain species in remote islands, no less than in localities nearer to each other, or divided by such barriers as mountain-ranges or deep seas. This subject has, more or less, engaged the attention of botanical travellers from the time when Darwin published his classical "Journal of Researches," nearly fifty years ago, down to the publication of Mr. Hemsley's "Botany of the Challenger Expedition," Part I., which was issued as lately as last year. In the careful summary of plants probably distributed by birds, *loc. cit.* pp. 44-49, it is mentioned that seeds may be carried by birds in either of two ways. First, by seeds, especially those provided with barbs and hooks, attaching themselves to the feathers of birds, and, in the case of aquatic or burrowing birds, being embedded in mud and thus carried accidentally outside; or, secondly, by seeds swallowed by frugivorous birds being for a time lodged within, and dejected afterwards in such a state as to be capable of germination. My object now is not to treat generally of this subject, but to place on record two remarkable and striking instances where seeds carried and dispersed by birds have come immediately under my own observation. The examples which I shall here describe will, I believe, show clearly that birds are capable of acting as very effective agents in the dispersal of plants, and that the results are so apparent as to be placed beyond reasonable doubt.

In cases where seeds of a light character are provided with barbs or hooks, they are well adapted for attaching

themselves to passing objects, and are most favourably placed for dispersal by means of birds. The particular plant with barbed seeds which I describe under this category has not, I believe, been mentioned before; but it is deserving of notice, as it fully meets all the requirements incidental to this form of dispersal, and, moreover, I have had, for some years, very favourable opportunities of observing its behaviour. This plant is *Uncinia jamaicensis*, Pers. (Cyperaceæ), which grows in damp places in the mountains of Jamaica, at elevations of 5000 to 6000 feet. It is generally found overhanging small pools of stagnant water or on banks of mountain rivulets. Its slender tapering spikes, when ripe, literally bristle with long exerted rachilla, each shaped something like a shepherd's crook (hamate), but with the hooked part so closely fitting and elastic, that, if drawn along the back of the hand, it would grasp and draw out the finest hairs. Now, such places as are affected by this *Uncinia* are also the frequent resort of numerous birds that come there to drink or bathe, or to seek coolness and shade. In the case of migratory birds, and especially those that cover long distances in their flight, the high lands are generally those first touched. This is doubtless owing to the elevation at which they fly to escape surface-currents or local objects. I have often noticed birds from the north (the United States) on their way south, and again birds from the south returning to the north in early spring, frequenting the high lands of Jamaica, and resting there for a time before continuing their journey. Some such birds have been easily caught by hand, so exhausted were they with their long flight. In two instances I have found small migratory birds so completely entangled in the hooks of the *Uncinia* (*Gardener's Chronicle*, 1881, p. 780) that they were unable to extricate themselves; and, unless set at liberty at the time, would probably have died in that situation. In these instances the hooks of the *Uncinia* overstepped their proper function; for, obviously, no benefit would arise to the plant from the death of the birds, but only in the removal of the seed to another place. Larger birds, of course, would not be caught; but on the other hand, if they came within reach of the *Uncinia*, they could hardly get away without detaching a large number of the fruits and transporting them wherever they went. In the case of the *Uncinia*, there is present nearly every condition necessary to secure a very complete dispersion of its fruits. The plant, in the first place, is possessed of light portable seeds easily carried about from one locality to another; in the second place, the seeds are provided with highly specialised hooks which effectually grasp anything that comes within their reach; and lastly, the plant affects just those places which are visited by birds, and seldom fails to secure a sure and trusty carrier. It follows, as a matter of course, that *Uncinia jamaicensis* is found plentifully distributed in the track of migratory birds, and is found in similar situations in the mountains on the mainland in Central America, Venezuela, Ecuador, &c.

So much for seeds with barbs and hooks. We now come to the second class of seeds, namely, those which are swallowed by frugivorous birds and dejected in a state suitable for germination. The most striking example I know of the dispersion of such seeds, and of the results which immediately follow, are shown in connection with the pimento industry of Jamaica, which, as shown below, depends entirely for its existence on the offices of frugivorous birds. The pimento of commerce is the dried fruit of the pimento allspice, or Jamaica pepper-tree (*Pimenta vulgaris*). No other country supplies this article (although the tree itself is widely distributed both in the West Indies and on the mainland), and the value of the exports of pimento from Jamaica have reached (in 1880) a total of 100,000*l.* This is probably the largest spice industry in the world, and, to repeat what is mentioned above, it is wholly dependent upon the action

of frugivorous birds. In Lunan's "Hortus Jamaicaensis," vol. ii. p. 67, published about the end of last century, it is stated that "the usual method in forming a new pimento plantation or 'pimento walk' is nothing more than to appropriate a piece of woodland in the neighbourhood of a plantation already existing; or, in a country where the scattered trees are found in a native state, the woods of which being fallen, the trees are suffered to remain on the ground till they become rotten and perish. In the course of twelve months after the first seasons (rains), abundance of young pimento plants will be found growing vigorously in all parts of the land, being without doubt produced from ripe berries scattered there by the birds, while the fallen trees, &c., afford them both shelter and shade." In a foot-note it is added that "birds eagerly devour the ripe seeds of the pimento, and, muting them, propagate these trees in all parts of the woods. It is thought that the seeds passing through them undergo some fermentation which fits them better for vegetation than those gathered immediately from the tree." The present plan for forming pimento plantations in Jamaica is exactly as described above. In fact, the planters firmly believe that no other plan is likely to produce good pimento walks, although it has been shown by experiments in the Botanical Gardens that by careful treatment plants of pimento can be raised in nurseries in large numbers, exactly as any other economic plants. It remains, however, that all the present pimento plantations in Jamaica have been formed by the action of frugivorous birds, and to this agency alone we are indebted for the commercial supply of a most valuable and wholesome spice.

Kew, December 3

D. MORRIS

SOUNDING A CRATER

THE following is a brief account of my third ascent of Asama Yama, an active volcano about 75 miles north-west from Tokio. My first ascent was made in the spring of 1877. The time we stayed on the summit, which is about 8800 feet above sea-level, was exceedingly short. The crater looked like a bottomless pit, with perpendicular sides. It was audibly roaring, and belching forth enormous volumes of sulphurous vapour, threatening suffocation to any living thing they might envelop. The drifting of these vapours across the snow, with which the upper part of the mountain was covered, had rendered it so bitter that we were unable to use it as a means of quenching our thirst. A quantity of this snow was carried to the bottom of the mountain in a handkerchief, where it was bottled, and carried to Tokio for chemical examination. The examination, however, only yielded *pure* water, from which it was concluded that the liquefaction of the snow had been accomplished by heating over a fire, and whatever it was that had given the snow its peculiarly bitter taste had been evaporated. My next visit to Asama was in the spring of 1886. One of the chief objects of this expedition was to satisfy a curiosity which had arisen with regard to the depth of the crater. Many visitors to the summit reported that at favourable moments, when the wind had blown the steam to one side, they had been able to see downwards to an enormous depth. One set of visitors, who had remarkable opportunities for making observations, were convinced that if the crater was not as deep as the mountain is high above the plain from which it rises (5800 feet), it must at least be from 1500 to 2000 feet in depth. Although I had provided myself with sufficient wire and rope to solve this problem, owing to the inclemency of the weather and the quantity of snow then lying on the mountain the expedition proved a failure. One of our number had to give up the attempt to reach the summit at about 6000 feet above sea-level, while I and my remaining companion only reached it with great difficulty. Our stay was very short. The wind, which was at times so

strong that we were often compelled to lie down, rendered it impossible to approach the crater, and after a few minutes' rest we beat a retreat, worn out with fatigue, across the snow-fields, towards our starting-point.

Two months after this, a visitor who ascended the mountain by moonlight reported that the crater was only 200 feet in depth, and that at the bottom there was a glowing surface. A second visitor, Colonel H. S. Palmer, R.E., estimated the depth as being between 500 and 600 feet. This estimate was based on the convergence of the walls of the crater, which he saw to the depth of about 300 feet, and the diameter of the crater, which he estimated by walking round a semi-circumference as about 370 yards. Previous estimates of the diameter had been 200 yards, three-fourths of a mile, and 1000 metres. The Japanese say that the periphery is $3\frac{1}{2}$ miles. These last estimates, as pointed out by Colonel Palmer, are nearly in the ratio of 10, 81, 85, and 150!

These wildly discordant results as to the dimensions of Asama, and the increasing curiosity on this question, led me, in conjunction with Messrs. Dun, Glover, and Stevens, to face the fatigue of ascending Asama for the third time. We left our resting-place, Kutoukake, at the foot of the mountain, at 4.30 a.m. on the morning of October 2, and in company with five coolies we reached the summit at 11 a.m. After a short rest, we commenced our measuring operations, the general arrangements of which were entirely the suggestion of Mr. Dun. When these are explained, they are no more remarkable than the manner in which Columbus caused the egg to stand; but before Mr. Dun made his suggestion, the various schemes which were proposed would, to my mind, have been unpractical and unsatisfactory. One suggestion was to roll a cannon-ball, with a string attached, down the crater; another was to shoot an arrow carrying a string into the hole; a third suggestion was to fly a kite across the crater; &c., &c.

Mr. Dun's method, as carried out, was as follows:—First, a light rope some 500 yards in length was attached to a block of rock lying on a high portion of the rim of the crater. Next, this rope, which I shall call the cross-line, was carried round the edge of the crater for about 150 or 200 yards. Here a heavy brass ring was tied upon it, and through the ring was passed the end of a copper wire coiled on a large reel. This was the sounding-line. Close to the ring, a string, which I shall call the guy-rope, was made fast to the cross-line. This being completed, the cross-line was then carried on round the rim of the crater until it reached an eminence, as near as we could judge, opposite to the point where the other end of it was attached to the block of rock. After this, the same line was jerked clear of pinnacles and boulders lying round the edge of the crater. The cross-line now formed two sides of a triangle, stretching across the crater from where the ring and lowering apparatus were to two points diametrically opposite to each other. By letting out the guy-rope, the cross-rope could be stretched until it formed a diameter to the crater, with the ring in the middle. The getting of these ropes into position was a matter of no little difficulty. First was the fact that clouds of vapour not only prevented us from seeing from station to station, but also from seeing far out into the crater. Secondly, on account of the hissing and bubbling noises in the crater itself, we could only communicate with each other by sound for short distances. And, thirdly, there was the difficulty of clearing the cross-rope from the ragged edges of the crater, which involved considerable risks in climbing. All being ready, word was passed along to haul on the cross-rope; and, as it tightened, the guy-line was let out, together with the sounding-line, running parallel to it, but passing through the ring. Owing to the twisting of the cross-line by tension, and the consequent revolution of the ring, the wire was broken, and the first attempt at sounding failed. This difficulty was overcome by attaching the guy-rope to the ring itself. Very luckily

owing to the sounding-wire having been entangled in the cross-rope by the twisting before it broke, the apparatus it carried was recovered. This apparatus consisted of an iron wire, to which were attached a number of metals of low fusibility, like antimony, zinc, &c., together with pieces of wood, india-rubber, sealing-wax, &c. By the melting, burning, or fusing of some of these, it was hoped to obtain a rough idea of the temperature. Above these came a small net, containing what was christened the "automatic chemical laboratory." This consisted of pieces of blue and red litmus-paper, Brazil-wood paper, and lead paper. With the assistance of my colleague, Dr. E. Divers, I had planned a number of chemical tests; but from previous experience I had learnt the impossibility of carrying out anything but the simplest of experiments when working on the summit of a live volcano.

At the second sounding, at a distance of about 100 feet from the edge, bottom (side?) was reached at 441 feet. The wire of metals, &c., came up without change, farther than the softening and bending of the sealing-wax. The automatic laboratory had a strong smell of the action of acid vapours. The blue litmus was turned red, and the lead paper was well darkened. Assuming the lead paper to have been blackened by sulphuretted hydrogen, then, as pointed out to me by Dr. Divers, the absence of this gas at the surface, and the presence of sulphurous acid, might be due to the decomposition of sulphuretted hydrogen by oxidation or by sulphurous acid in the presence of steam. The presence of sulphuretted hydrogen would indicate a relatively low temperature.

At the third sounding, the line, which was a copper wire, gave way at a depth of about 200 feet, carrying with it a mercurial weight thermometer and other apparatus which I had reserved for what I hoped to be the best sounding.

The fourth and last sounding was made, as measured on the guy-rope, at a distance of about 300 feet from the edge. In this case, the line, which was strong twine, after striking bottom when nearly 800 feet of it had run out suddenly became slack. On hauling up, 755 feet were recovered. The end of this line was thoroughly carbonised, and several feet were charred. Assuming that the guy-rope was paid out at an angle of 45° , we may conclude that the depth at this particular place was at least 700 feet. It is probable that the greatest depth is about 750 feet.

A final experiment was to attach a stone to the end of the cross-rope, and then throw it into the crater, with the hope of hauling at least a portion of it up the almost perpendicular face on the other side. Unfortunately the line caught, and, in the endeavour to loosen it, it was broken.

Before we left the summit, we were very fortunate in obtaining views of one side of the bottom of the crater. This we did by cautiously crawling out upon an overhanging rock, and then, while lying on our stomachs, putting our heads over the edge. The perpendicular side opposite to us appeared to consist of thick horizontally-stratified bands of rock of a white colour. The bottom of the pit itself was white, and covered with boulders and debris. Small jets of steam were hissing from many places in the sides of the pit, while on our left, where we had been sounding, large volumes of choking vapours were surging up in angry clouds.

After this we descended the mountain, reaching our hotel at 8 p.m., after 15 hours' absence.

This concludes the narrative of a holiday excursion, partly undertaken with the object of making a few scientific observations. The results which were obtained are undoubtedly very few, while the labour which was expended and the risks which were incurred were very great. All that we did was to solve a problem chiefly of local interest, to learn a little about the nature of the gases which are given off by one of the most active vol-

canoes in this country, and to enjoy the spectacle of a phenomenon which it is the lot of very few to witness. When a stranger gazes for the first time down upon the burnt and rugged sides of an apparently bottomless pit, which, while belching out enormous clouds of steam, roars and moans, he certainly receives an impression never to be forgotten.

The recorded eruptions of Asama took place in the years 687, 1124 or 1126, 1527, 1532, 1596, 1645, 1648, 1649, 1652, 1657, 1659, 1661, 1704, 1708, 1711, 1719, 1721, 1723, 1729, 1733, 1783, and 1869. This last eruption was feeble, but the eruption of 1783 was one of the most frightful on record. Rocks, from 40 to 80 feet in some of their dimensions, were hurled through the air in all directions. Towns and villages were buried. One stone is said to have measured 264 by 120 feet. It fell in a river, and looked like an island. Records of this eruption are still to be seen, in the form of enormous blocks of stone scattered over the Oiwake plain, and in a lava-stream 63 kilometres in length.

JOHN MILNE

Tokio, October 10

THE MATHEMATICAL TRIPOS¹

II.

VERY important regulations came into effect in 1848. The examination, as thus constituted, underwent no further alteration till 1873, and the first three days remain practically unchanged at the present time. The duration of the examination was extended from six to eight days, the first three days being assigned to the elementary and the last five to the higher parts of mathematics. After the first three days there was an interval of eight days (soon afterwards increased to ten), and at the end of this interval the Moderators and Examiners issued a list of those who had so acquitted themselves as to deserve mathematical honours. Only those whose names were contained in this list were admitted to the five days, and after the conclusion of the examination the Moderators and Examiners, taking into account the whole eight days, brought out the list arranged in order of merit. No provision was made for any further examination corresponding to the examination of the Brackets, which, though forming part of the previous scheme, had been discontinued for some time. A very important part of the scheme was the limitation, by a schedule, of the subjects of examination in the first three days, and of the manner in which the questions were to be answered; the methods of analytical geometry and differential calculus being excluded. In all the subjects contained in this schedule, examples and questions arising directly out of the propositions were to be introduced into the papers, in addition to the propositions themselves. Taking the whole eight days, the examination lasted $44\frac{1}{2}$ hours, 12 hours of which were devoted to problems.

In the same year as these regulations came into force, the Board of Mathematical Studies (consisting of the mathematical Professors and the Moderators and Examiners for the current and two preceding years) was constituted by the Senate. Although the new regulations had so strictly limited the subjects, and parts of the subjects, which could be set in the first three days, they had imposed no limitation whatever upon those which could be set in the last five days, the subjects of examination appearing in the schedule simply as pure mathematics and natural philosophy. Accordingly, the first matter to which the newly-constituted Board turned its attention was that of restricting the subjects on which questions should be set in the last five days of the examination.

It becomes necessary, therefore, at this point, to refer

¹ Address delivered before the London Mathematical Society by the President, Mr. J. W. L. Glaisher, M.A., F.R.S., on vacating the chair, November 22, 1886. Continued from p. 156.

briefly to the range of subjects which were included in the examination. Of the nature of the questions proposed prior to 1822, the first year in which all the papers were printed, very little can be known except what can be gathered from the problem papers and the specimens of the other papers that have been preserved;¹ but there can be no doubt that their character was determined by the ordinary Cambridge treatises then in use, which, it is well known, were far behind the corresponding treatises published on the Continent. Woodhouse's "Principles of Analytical Calculation" (1803), and "Plane and Spherical Trigonometry" (1809) are the earliest indications of the introduction of the analytical element into the mathematics of the University; a more decided impulse in this direction was given by the translation of Lacroix's "Differential and Integral Calculus" by Herschel, Peacock, and Babbage (1817), followed by Peacock's "Examples on the Differential and Integral Calculus," and Herschel's "Examples on the Calculus of Finite Differences" (1820).

The reform in the mathematical studies of the University which was effected by Herschel, Peacock, and Babbage, is well known. It is to them that we mainly owe the revival of mathematics in this country, and the restoration of intercourse with the rest of Europe after three-quarters of a century of isolation. Peacock was Moderator in 1817, and he ventured to introduce the symbol of differentiation into the examination, his colleague, however, retaining the old fluxional notation. The old system made its appearance once more in 1818, but in 1819 Peacock was Moderator again, with a colleague who shared his views, and the change was fully accomplished.

The introduction of the notation and language of the differential calculus into the Senate House examination forms an important landmark in the history of Cambridge mathematics. From that time onward the University began to make up slowly but surely the ground she had lost; step by step the analytical processes and methods superseded the older geometrical modes of treatment; and each year saw a substantial increase in the range of subjects included in the course of study.

Only second in importance to the revolution effected by the substitution of the differential for the fluxional calculus was the rise of analytical geometry in the first thirty years of the century; and, considering the amount of attention that this subject has received at Cambridge in the last fifty years, and the accessions that have been made in this country to the analytical theory of curves and surfaces, a peculiar interest attaches to the introduction into the University of the algebraic treatment of geometry and the early stages of its development. The first edition of Wood's "Algebra," which appeared in 1795, contained, as Part IV., a chapter of thirty pages "On the Application of Algebra to Geometry," in which are given the equations of the straight line, ellipse, cissoid, conchoid, and other curves, the construction of equations, &c. This chapter remained unchanged in the ninth edition (1830), and seems to have formed the only introduction to analytical geometry existing in the University until 1826, when Hamilton² published his "Principles of Analytical Geometry," designed for the use of Students in the University." This was not the first English treatise on analytical geometry, as Lardner's "Algebraic Geometry" was published, three years earlier, in 1823; but it was the first Cambridge book, and the first which included solid geometry. The problem papers from 1800 to 1820 show that at the beginning of the century analytical geometry was always represented to some extent, though scarcely as an independent subject, most of the questions relating to areas, loci, &c., in which but little more than

the mode of representation by means of ordinates and abscissæ was involved. Hymers published his "Analytical Geometry of Three Dimensions" in 1830, and his "Conic Sections" in 1837. The latter at once superseded Hamilton's treatise, and remained the standard work on the subject for many years.

In applied mathematics the character of the questions proposed was largely influenced by the publication of Whewell's "Mechanics" (1819), Whewell's "Dynamics" (1823), Coddington's "Optics" (1823), Woodhouse's "Plane Astronomy" (1821-23), and Airy's "Tracts" (1826). A second edition of this last work, which appeared in 1831, contained a tract on the "Undulatory Theory of Light," a subject which was freely represented in the examination for many years. Not only were the questions modified, in character and range, by the publication of new mathematical treatises in the University, but they were also affected to a certain extent by some of the professorial lectures. At this time, too, the Smith's Prize examination exerted a beneficial effect upon the Senate House examination, certain classes of questions which were originally introduced into the former having shortly afterwards been admitted into the latter. Between 1830 and 1840, questions in definite integrals, Laplace's coefficients, electricity, magnetism, and heat were also introduced. There were no regulations of any kind, and the responsibility of introducing innovations and alterations rested solely with the Moderators and Examiners. The uncertainty as to the subjects that the examination would embrace, and the want of any due notice of any extension of them, were found to be serious inconveniences to the higher class of students, although, as has been already stated, the introduction of a new subject had been generally preceded by the publication of a work by a Cambridge mathematician, in which it was treated in a manner adapted to the examination.

The Board of Mathematical Studies was created by the Senate on October 31, 1848, and in May of the following year they issued a report to the Senate in which, after giving a short review of the past and existing state of mathematical studies in the University, they recommended that, considering the great number of subjects occupying the attention of the candidates and the doubt existing as to the range of subjects from which questions might be proposed, the mathematical theories of electricity, magnetism, and heat should not be admitted as subjects of examination. In the following year they issued a second report in which they recommended the omission of elliptic integrals, Laplace's coefficients, capillary attraction, the figure of the earth considered as heterogeneous, &c., besides certain limitations of the questions in lunar and planetary theory, &c. In making these recommendations the Board expressed their opinion that they were only giving definite form to what had become the practice in the examination, and were only putting before the candidates such results as they might themselves have deduced by the study of the Senate House papers of the last few years. The Board also recommended that the papers containing book-work and riders should be shortened.

From 1823 onwards, the examination was conducted in each year by four examiners—the two Moderators and the two Examiners, the Moderators of one year becoming as a matter of course the Examiners of the next. Thus of the four examiners in each year two had taken part in the examination of the previous year. The continuity of the examination was well kept up by this arrangement; but perhaps it had the effect of causing its traditions to be rather too punctiliously observed, the papers of each year being, as regards the subjects included, exact counterparts of the corresponding papers of the previous year. The resolutions of the Board in 1849-50 were not binding on the successive Moderators and Examiners up to 1872, but each year they seem to

¹ The problem papers were printed from 1779; but only those of the present century are accessible in the Cambridge University Calendars and other publications.

² Late Dean of Salisbury; born April 3, 1774; died February 7, 1880.

have felt themselves bound to follow the precedent of their predecessors, so that no new subjects were introduced. One would suppose from an examination of the papers set that those of the last five days must have been framed in accordance with a schedule as precise and detailed as that which governed the first three.

In 1865 the Board recommended that after 1866 Laplace's coefficients and the figure of the earth considered as heterogeneous should be included in the examination, but this appears to be the only extension of the range of subjects recommended by the Board during the time that the regulations of 1848 remained in force.

The period that followed the constitution of the Mathematical Board was one of activity in the whole University. The first examinations of the Moral Sciences Tripos and of the Natural Sciences Tripos were held in 1851. In 1850 a Royal Commission was issued to inquire into the University and Colleges, and in 1852 their Report was presented to Parliament. In consequence of this Report, a Bill was introduced into Parliament, which received the Royal assent in 1856; and, under its powers new statutes were framed, both for the University and the Colleges. Amid all these changes the Mathematical Board, though not very active, was not idle. The subjects which chiefly occupied its attention were the alteration of the date of the first three days from January to the previous June (as by recent changes the poll-men were examined in June, and so received their degrees seven months before the mathematical honour men), and the introduction of the *vivâ voce* element into the examination. Neither of these innovations, though frequently discussed and finally recommended by the Board, was received with much favour in the University. With regard to the latter, the opinion seems now to have become general that an admixture of the *vivâ voce* element, however valuable it may be in the lecture-room, is useless, or even worse, in testing the proficiency of candidates with the view to arranging them in strict order of merit. The change of time from January to June was at length effected, as will be seen, by the regulations which came into operation in 1882.

In 1866 the attention of the Board was directed to the exclusion of certain important branches of mathematics from the studies of the University, owing to the fact that they were not represented in the Tripos examination. The rewards attending a high place in the Tripos were so great that the reading of most of the best men was directed almost wholly to this end; it was therefore practically impossible to introduce new mathematical subjects into the University without assigning to them some place in the Tripos. Now, although the recommendations of 1849-50 had curtailed the range of subjects, the course had nevertheless extended itself in some directions—where the name of the subject permitted of such extension—and especially in analytical geometry and higher algebra. The fact of this extension taking place in certain subjects, while others were wholly omitted, alone sufficed to show the need of some revision of the limitations imposed upon the subjects that might be set. The Board, after careful consideration, came to the conclusion that the time had come when it was desirable to allow the candidates a certain option with respect to the higher branches of mathematics, and that this could be effected by increasing the number of subjects and arranging them in several divisions over which the marks were distributed in a known proportion. Each candidate would be at liberty to devote himself to such of the divisions as he thought most advantageous, there being nothing to prevent his taking up all the divisions, if it were possible for him to do so. In a Report dated May 8, 1867, the Board gave expression to these views, and recommended a scheme for the five days, according to which the subjects of examination were arranged in five divisions, with an approximately determinate number of marks assigned

to each division. The subjects included in the five divisions were thirty-five in number, and included elliptic integrals, elastic solids, heat, electricity, and magnetism. On June 3, 1867, a syndicate was appointed by the Senate to consider the proposals of the Board; and the regulations recommended by this syndicate were approved by the Senate on June 2, 1868, and came into operation in January 1873.

In this new scheme of examination the three days were left unchanged, and the schedule of subjects for the five days, and their arrangement in divisions as proposed by the Board, were adopted with very slight modifications, the marks awarded to the five divisions being to those awarded to the three days in the proportion of 2, 1, 1, 1, 1 to 1 respectively.¹

The new regulations also made two other changes of importance: they added an extra day to the examination and increased the number of the examiners from four to five. The extra day was the day immediately following the three days, and it was devoted to easy questions upon the subjects in the five days' schedule. Although the papers set on this fourth day were put before all the candidates, they were taken into account along with the five-day papers, and not with the three-day papers; so that this day had no effect upon the alphabetical list of those who deserved mathematical honours; which, as before, was dependent upon the three days' marks only.

The Additional Examiner was appointed on the nomination of the Mathematical Board, and held office for one year only; and, to render his duties as little irksome as possible, he was not required to take part in the first three days—the most laborious part of the examination as far as the looking over the papers is concerned, on account of the quantity of work sent in. It was thought that in introducing the new subjects of electricity and magnetism into the examination, certain non-resident Cambridge mathematicians whose names were closely connected with great recent advances in these subjects might be willing to give the University the benefit of their assistance, and that the influence of eminent non-resident mathematicians upon the examination, and therefore also upon the course of studies in the University, would be of the greatest value. These hopes were abundantly justified.

The general working of the new system soon disclosed the fact that the desired effect of inducing the best candidates to make a selection from the higher subjects, and concentrate their reading, had not been attained. It was found that, unless the questions were made extremely difficult, more marks could be obtained by reading superficially all the subjects in the five divisions than by attaining real proficiency in a few of the higher ones; and the best men of the year were tempted, not to say compelled, to extend their reading as widely as possible over the book-work of the whole range of subjects. Thus, with respect to the main object which the framers of the scheme had in view, it was a complete failure.

Accordingly, on May 17, 1877, a syndicate was appointed by the Senate to consider the higher mathematical studies and examinations of the University. This syndicate consisted of eighteen members representing nearly all phases of mathematical research and study in Cambridge; they met every week during the whole academical year, and the thorough examination and discussion that the subject received, both on the syndicate and in the University at large, brought out in the strongest light how great were the intrinsic difficulties connected with the retention of the order of merit, and how wide was the diversity of opinion—so much so, that at one time it seemed almost hopeless to attempt to devise a scheme

¹ The regulation assigning the proportion of marks to be awarded to the different divisions was one which was found in practice very difficult to carry out, even approximately.

that should receive a fair amount of general support. Even when the subjects were restricted, as they had been in the twenty-five years from 1848-72, it was sufficiently difficult to include in one list all the various classes of candidates—those who may be described as professed mathematicians, who intended to devote themselves to mathematics after their degree as investigators or teachers; those who adopted mathematics as their subject of study on account of its unrivalled mental training, and subordinated their whole reading to the single object of obtaining the highest place their abilities would enable them to reach; and those who, without any hope of obtaining a good place in the list, desired, nevertheless, to graduate in the Tripos, on account of the high position held by mathematics among the branches of a liberal education. But, when the range of subjects was extended, there was the further dilemma: if there was to be a single order of merit, all the questions must be submitted to all the candidates; but, if a candidate was to be at liberty to attempt all the questions, it appeared that, under any scheme that could be devised, the best candidates would find it more to their advantage to read the elementary portions of all the higher subjects than the higher portions of a few. If the questions were to be alternative, how could the order of merit be retained? How was it possible to compare one student's elliptic functions with another's elastic solids? was a question often asked.

It was keenly felt in the University that subjects like heat, electricity, and magnetism could not with propriety be omitted from the course systematically studied by candidates for mathematical honours. On the other hand, it was universally admitted that, by the extension of the range of subjects, the severe strain of the competition had been intensified to an injurious extent; and not only had the addition of the new subjects aggravated the evils arising from excessive competition, but they had even caused a deterioration in the quality of the work of many of the students, who were led, in the hope of gaining higher places, to attempt matter really beyond their grasp. The opinion was expressed on the syndicate that the only escape from the dilemma was by abandoning the order of merit. The majority, however, preferred to attempt some other remedy without interfering with the final form of the Tripos list, which had been of such immense service to the University in the past, and was connected with so many valued associations. They therefore proposed, as the only method by which the pressure on the mathematical candidates could be relieved, to omit a varying portion of the higher subjects of examination in each year.

The Report of the syndicate was presented to the Senate on March 29, 1878. They recommended that the nine days of the examinations should be divided into three groups of three days each, called Parts I., II., and III. Part I. was to be the same as the first three days in the schemes that came into operation in 1848 and 1873. Part II. was to be conducted according to a schedule of subjects considerably more restricted than the unwritten schedule that ruled the five days from 1848 to 1872. It included the more elementary portions of most of the ordinary subjects, such as differential equations, hydrostatics, rigid dynamics, optics, spherical astronomy, &c, but excluded calculus of variations, thermodynamics, physical optics, &c. It was proposed to move forward the time of examination in these first two parts, from January to the previous June, *i.e.* two years and nine months from the time of coming into residence of the students. After the examination in Parts I. and II. a list of the candidates was to be published, arranged in three classes as before, the senior and junior optimes being placed in order of merit, and the wranglers in alphabetical order. Only the wranglers were to be admitted to Part III., which was to take place at the old time in the following January. A final list was then to be issued in which the wranglers

were to be placed in order of merit, the marks obtained by them in all three parts being added together. The most important part of the scheme was the schedule of subjects for Part III. It contained all the subjects which were included in the schedule of the five days of the then existing examination (for the syndicate had decided that they would neither propose the addition of any new subjects nor the omission of any that had been already included), divided into three groups, A, B, C. It was recommended that questions from the subjects in group A should be set every year, and that questions from groups B and C should be set in alternate years. It was thus proposed to establish, as it were, a "rotation of subjects." This scheme was voted upon by the Senate on May 13, 1878, when all its essential features were rejected. The division of the examination into three parts, of which the first two should take place in June and the third in the following January, was agreed to, as also was the limitation of Part III. to wranglers; but the carrying over the marks of the wranglers from June to January and the proposed rotation of subjects were rejected.

It is evident that the acceptance of the scheme, even by those who assented to its principle, depended largely upon the manner in which the subjects were divided into the three groups A, B, C. Whether a satisfactory division of the subjects was possible is very doubtful; but it is certain that the grouping of the subjects proposed by the syndicate was extremely unsatisfactory.

This scheme, though it never came into operation, will be memorable in the history of the Tripos as the final attempt made to retain the order of merit in its old form. With its rejection there passed away all hope of expressing the results of the whole examination by means of a single order of merit. The scheme also deserves notice for its own sake, if only on account of the influential mathematicians who supported it.

The syndicate then proceeded to build a new scheme upon the ruins of the old. They considered that the result of the voting on the nineteen graces in which the previous scheme had been submitted to the Senate showed that it was the opinion of the University that the examination in Part III. should be independent of the preceding parts, and that no scheme would be acceptable in which it was not provided that all the subjects should be included in the examinations of each year. They accordingly presented a Report to the Senate in October 1878, in which they proposed that in June, immediately after the examination in Parts I. and II., the complete list of wranglers, senior optimes, and junior optimes should be issued arranged in order of merit, that Part III. should be a separate examination, to which wranglers only should be admissible, and that after the examination in Part III. a list should be issued in which the candidates were arranged in three classes, the names in each class being arranged in alphabetical order.

The schedule of subjects consisted of all the existing subjects divided into four groups, A, B, C, D. Group A contained the pure mathematics; Group B, the astronomical subjects; Group C, hydrodynamics, sound, physical optics, elastic solids, &c.; and Group D, heat, electricity, and magnetism. In order to encourage the candidates to specialise their reading, one of the regulations authorised the Moderators and Examiners to place in the first division a candidate who showed eminent proficiency in any one group; so that it was not absolutely essential for a student, in order to be placed in the first division, to extend his reading beyond the subjects of a single group.

This scheme was approved by the Senate on November 21, 1878, and it came into operation in 1882, the first examination in Part III. taking place in 1883.

Parts I. and II. taken together differed in no essential respects from the Tripos as it had existed from 1848. The five days of the scheme of 1848 were reduced

three, and the range of subjects was more limited; otherwise the examination was exactly the same as in the period 1848-72. But Part III. was a complete novelty, and a great deal of curiosity was felt as to how the first Moderators and Examiners would interpret the regulations. Would the new examination resemble, as regards the character of the questions set, the last three days of the old five days, or was the examination to be one of a distinctly higher order? The result showed that the latter anticipation was the correct one. No longer hampered by the order of merit, the examiners felt themselves free to set difficult and elaborate questions, such as were only appropriate to specialists in the particular subjects; and a new departure was made.

As soon as the new system came into full operation, it was found that it needed amendment in various respects; and this is not to be wondered at, considering that it had been constructed in order to fit in with the few regulations that had escaped the general massacre of May 1878, and that almost every part of it was the result of a compromise. It was found that the interval between June and January—less than seven months, and including a long vacation in which very few lectures were given—was too short for an adequate preparation for Part III. It is true that most of the work for Part III. could be done—and indeed was done—before the examination in Parts I. and II.; but the competition in these two parts remained as keen as ever, and, as the examination became imminent, the candidates were tempted to neglect the higher work, and give their whole attention to the more elementary subjects, upon which the list in order of merit depended. As a consequence there was a diminution in the numbers of students attending the higher mathematical lectures in the University. With respect to the actual conduct of the examination, it was found that the strain upon the Moderators and Examiners was very serious, and general regret was expressed that under the new scheme no provision had been made for the annual appointment of an Additional Examiner, as in the previous scheme which had been in operation from 1873 to 1882. Under the new system the candidates devoted themselves to special branches of the higher mathematics, and there was even greater difficulty in adequately representing all the subjects of examination. Accordingly, on June 12, 1884, the Senate confirmed a Report of the Mathematical Board recommending that the examination in Part III. should take place in June, exactly a year after that in Parts I. and II., and that the Moderators and Examiners, with the Chairman of the Mathematical Board, should nominate an Additional Examiner, the first nomination being made in the Easter term, 1885, and having reference to the examination in January 1886. It was considered that the Moderators and Examiners were themselves the best judges of the branches of mathematics in which they most desired assistance, and were therefore the most suitable body to nominate the Additional Examiner.

The last time that the whole examination took place in January was in 1882. This year (1886) the examination in Part III. has taken place in January for the last time, so that the historic connection between the Tripos and the month of January has now finally ended. Henceforth the examination in all three parts will take place in the middle of the year.

(To be continued.)

EARTHQUAKE AT SEA

WE have received the following communication from Mr. R. H. Scott, F.R.S., Secretary, Meteorological Office:—

*British Consulate, St. John's, Porto Rico,
November 4, 1886*

SIR,—I have the honour to inform you that Mr. J. Simmons, master of the British brigantine *Wilhelmina*,

of Lunenburg, now loading in this port, has reported to me that, on October 20 last, at 4.30 p.m., while in latitude 19° 21' N., and longitude 64° 22' W., he felt a shock of earthquake which caused the ship to tremble. The shock lasted one minute, and was accompanied by a loud rumbling noise like distant thunder. Capt. Simmons states further that, were it not that he believed the depth of water at the spot to be no less than two thousand fathoms, he could have imagined that his vessel was running upon the rocks, so great was the vibration and so loud the noise. I have thought it my duty to report this occurrence officially, as it seems not improbable that some volcanic disturbance is in operation in the locality herein referred to.

I have the honour to be, Sir, your most obedient humble servant,

REGINALD H. HERTSLET,
H.M. Consul

The Assistant Secretary, Marine Department,
Board of Trade

NOTES

WE regret to hear of the death at Calcutta of Father Scortechini from dysentery. He has succumbed to his extraordinary exertions in the botanical exploration of Perak, where he had made very large and valuable collections. These he intended to make the basis of a flora of this native State in collaboration with Dr. King, the Superintendent of the Royal Botanic Garden, Calcutta. His collections will, as far as possible, be made use of by Sir Joseph Hooker in the portions of the flora of British India now in progress at Kew.

ONE of the severest storms of recent years swept over the country in the middle of last week, being indeed a storm seldom paralleled for its wide-spread destructiveness. The damage to property and the loss of life have been exceptionally great, and each morning newspaper has been adding to the long tale of losses and disasters. Another peculiarity of the storm is that it was heralded with only the slightest premonitions of its approach. It was at Valencia only that the observations of the previous evening indicated a storm, and these even seemed to foreshadow on more than a subsidiary cyclone. But on Wednesday morning last week the centre of the storm had already advanced on the north-west of Ireland, where at Belmullet, at 8 a.m., the barometer had fallen, at 32° and sea-level, to 27.580 inches. In the course of the day the cyclone moved eastward at the rather slow rate of 20 miles an hour, and by 6 p.m. its centre was near Barrow-in-Furness, where the barometer is stated to have fallen to 27.410 inches. The centre passed somewhat to the south of Edinburgh, about half-past seven, pressure being then 27.650 inches, and the wind easterly. The greatest interest is attached to the observations that may have been made in the north of England and the south of Scotland during the evening of Wednesday week, from which the path of the cyclone may be traced; and particularly, if the low reading at Barrow-in-Furness be confirmed, what lower readings of the barometer were made to the eastward. But in any case it is plain that in this part of Great Britain, on the evening of Wednesday week, pressure fell nearly as low as it did on January 26, 1884, at Ochtertyre, Perthshire, where it fell to 27.333 inches; and it is remarkable that these two low barometers, hitherto the lowest observed by man anywhere on the land surfaces of the globe after being reduced to sea-level, have occurred in the British Islands, and within three years of each other. It is noteworthy that the lowest pressure on Ben Nevis was 23.451 inches at 2h. 31m. p.m., and that at the height of the storm, at 6 p.m., the wind was south-east, and blowing at the rate of fully 120 miles an hour—thus indicating that the storm was not only wide-spread, but that it also, as regards direction and force

of wind, extended to a greater altitude than the Ben Nevis Observatory.

Mr. T. H. COX, of the firm of Cox Brothers, manufacturers, Cauperdown Linenworks, Lochee, has given a donation of £2,000 for the endowment and equipment of a Chair of Anatomy in connection with the Medical School it is proposed to establish in University College, Dundee.

WE are glad to notice that in the new French Ministry M. Berthelot, the eminent chemist, takes the portfolio of Education.

AN electrical metronome has been established at the Paris Opera House, which enables the *chef d'orchestre* to conduct choruses at any distance from his chair. The working is very satisfactory, and the effect really admirable.

THE late Prof. Morris at the time of his death had made considerable progress with a third edition of his "Catalogue of British Fossils." Some of his friends, reluctant that so valuable a work should be lost to science, have arranged to revise and complete the manuscript, and the necessary expenses of preparing it for the press have been guaranteed by his nearest surviving relative, who rightly holds that this will be the best monument to his memory. The editor-in-chief is Dr. H. Woodward, of the British Museum, and he is assisted by a number of eminent specialists, among whom are Drs. Hinde and Traquair, Profs. Duncan, Rupert Jones, Lapworth, Nicholson, and H. G. Seeley, Messrs. Carruthers, Etheridge, Hudleston, and Lydekker. The Syndics of the Cambridge University Press have now undertaken the publication of the work, which it is hoped may appear in the course of the coming year.

THE annual distribution of prizes and certificates to the successful students at the City and Guilds of London Institute was held on Monday night, when the Lord Chancellor gave an address in which he contrasted the restrictions which hampered industrial progress in the past with the complete freedom and publicity of the present day.

A VIOLENT shock of earthquake occurred at Smyrna and also at Chios on the morning of December 11. Frequent oscillations have been felt at Smyrna during the past fortnight, causing fissures in the walls and fronts of many houses in the town. A shock was felt on the 8th in Missouri City and in Missouri State, and a shock is also reported from Columbia, South Carolina. On the night of November 1, at 12.15 p.m., a sharp shock was felt at Nordheimsund, on the west coast of Norway. Houses and windows shook, whilst a man walking in the road felt the earth slowly rock under him. The shock, which was accompanied by a heavy rumbling noise, was from north-west to south-east.

A CORRESPONDENT in South Africa writes:—"Rogeria longiflora, the Martynia-like plant, has capsules which pierce the lips of the gnu or 'wildebeest,' and are rubbed to pieces in their efforts to get rid of them. Truly, what with *Uncaria*, costing the life of a springbok for every capsule trodden out, and *Rogeria* festering in the poor 'wildebeest's' mouth, the beneficent 'Nature' of the teleologist is in Africa a remarkably cruel divinity."

IN an interesting recent paper on Siberia as a colony, Prof. Petrie points out that there are two classes of colonists there—those attracted by the immense wealth of the country in furred animals and minerals, and an industrious people from the Russian peasant class engaged in agriculture. The number of wild animals taken in the boundless forests of Siberia shows a great reduction from year to year. The fisheries are capable of great development, and multitudes of fish are thrown away because the art of salting and preserving is not understood. In Ural, the southern steppes, Altai, and other places, there is

immense mineral wealth in silver, gold, iron, lead, copper, anthracite, graphite, &c. The steppes (quite different from the Central Asiatic and Kirghisian) are well suited for cattle-breeding; they have excellent grass and numerous birch woods, and also many lakes, large and small. In Western Siberia, about 32 per cent. of the whole land is arable. With her four rivers of the first rank, three of them flowing north and the other east, Siberia is well off for intercommunication by water and for transport of commerce to neighbouring countries. Notwithstanding three hundred years of occupation, the Russians in Siberia only amount to 4,800,000, and there are nearly as many natives. The Russian colonist in Siberia diverges from the Slav type, as the Yankee does from the Englishman. At present, farming and cattle-breeding in Siberia are carried on in an irrational way, commerce is in absolute dependence on European Russia, and the roads are dreadfully bad, so that, e.g., people commonly make circuits rather than use the post route from Tomsk to Irkutsk. There is, however, a party of intelligent Siberians bent on gaining the liberties and advantages of the mother country, stopping the deportation of criminals, and promoting education, &c. Many thousand roubles have been contributed by Siberian merchants to found the Tomsk University and other institutions.

MR. J. B. MEDLAND, of 12, Borough, has sent us a specimen of his new portable cabinet for microscope-slides. The cabinet has sixteen trays to hold nine objects each, contained in a well-made polished pine case. When closed, it is the same height and width, and only two inches and a half longer than the ordinary case holding only half the number. Each glass slip is held at its ends by the projecting side flap of the tray, which is held down by the succeeding tray, and so on, the lid holding the whole firmly down. When open, the lid and front fall back, forming a stand or table to place the trays upon, keeping them together and less liable to get displaced or up et, as when placed among other apparatus or upon the desk or work-table. The advantages of the cabinet will be obvious to microscopists.

A WORK by Mr. J. Allen Brown will appear early in January, published by Messrs. Macmillan and Co., entitled "Palæolithic Man in North-West Middlesex; the Evidence of his Existence, and the Physical Conditions under which he lived in Ealing and its Neighbourhood, illustrated by the Condition and Culture presented by certain existing Savage Races."

THE Council of the Essex Field Club has determined in future to issue the *Transactions and Proceedings* of the Club combined in the form of a monthly periodical, entitled *The Essex Naturalist: being the Journal of the Essex Field Club*. The journal will contain papers read before the Club, reports of past and announcements of future meetings, and, as space allows, notes and communications upon any matters of interest connected with the natural history, botany, geology, and prehistoric archaeology of Essex. We believe that this is a new departure in the policy of local societies, at least in the south of England, but the plan has been adopted by the Essex Club from a rapidly growing conviction that, if local societies are to flourish and do useful work, it is necessary to devise some means of "keeping touch" with their members, and encouraging intercommunication among them. The first number of the *Essex Naturalist* will appear in January next, and will be conducted by Mr. W. Cole, who has edited the publications of the Club since its establishment seven years ago.

THE Japanese Government has despatched an official of the Ministry of Commerce to Norway, in order to study the cod-fisheries, the preparation of oil, &c., in that country, the object being to develop these industries in Northern Japan, where large numbers of cod appear at certain seasons.

SOME important geological work has just been carried out at Landsort, near Stockholm. Close to the coast, pipes have been driven through the rock to the sea, by which sea-water will be carried up into a specially constructed kiosk for examination and registration, the object being to measure the elevation of the shore in course of time. It is intended to establish similar stations at various places on the coast.

BETWEEN 8 and 9 o'clock on November 3 a remarkable phenomenon was observed at Hamar, in Norway. At the time there was perfect darkness, when, suddenly, a bright white cloud appeared in the sky, drifting in a north-easterly direction, and from time to time emitting brilliant rays of light in various directions. The cloud retained throughout its original form, and disappeared at last in the darkness.

FISH-HATCHING operations have now commenced at the establishment of the National Fish Culture Association. The new hatchery that has lately been constructed is completed, and a batch of ova has already been laid down for incubation. These were taken from *Salmo fontinalis* located in the ponds of the establishment. A large number of rainbow trout (*S. iridens*), of California, hatched out two years ago by the Association, from ova sent by the American Government, will be ready to spawn at the end of the year, which is six weeks earlier than in their native waters. This shows to what extent fish alter their natures and habits according to the climatic and other conditions of their locations. The *S. iridens* is a late spawner in its native country, which is accounted for by the hardness of the water and the low temperature that prevails. It is hoped to secure a large quantity of ova from these fish. The American Government have announced their intention of forwarding consignments of ova from Transatlantic Salmonidae. A feature is to be made this year of hatching ova for Fishery Boards and other public bodies, who will collect ova from their respective waters and forward them to the Association for incubation. When hatched, the fry will be turned into the waters from whence they came.

ACCORDING to the *Colonies and India*, a discovery of much geological interest has just been made at Cockatoo Island, Sydney. A large fossil shell of the genus *Planorbis* was found in the excavation for a new Government dock at Cockatoo Island, and was forwarded to Mr. Wilkinson, the Government Geologist of New South Wales. This being the first fossil shell found in the Hawkesbury formation, he took the opportunity of examining the rocks, but only obtained some fossil plants. As, however, the rocks looked promising for fossil remains, he sent the collector, Mr. Cullen, to make a further search, which was rewarded by the discovery of a most interesting fossil, which Prof. W. J. Stephen has identified as *Mastodon aurus*, of which similar fossil specimen from Stuttgart is in the collection of the Sydney University. This being the first discovery in Australia of *Labyrinthodon*, is of much scientific importance, as proving the Triassic age of the Hawkesbury sandstone formation.

THE first number is to hand of the *Proceedings* of the Camera Club, the President of which is Capt. Abney. It is nicely printed, and will no doubt prove useful to members and to photographers generally.

THE additions to the Zoological Society's Gardens during the past week include a Sclater's Curassow (*Crax sclateri* ♀) from South America, a Razor-billed Curassow (*Mitua tuberosa*), a Lesser Razor-billed Curassow (*Mitua tomentosa*) from Guiana, presented by Rear-Admiral Fairfax, R.N., F.Z.S.; a Spanish Terrapin (*Clemmys leprosa*) from Spain, presented by Miss Alden; eighteen Brown Newts (*Spelerpes fuscus*), South European, presented by Prof. H. I. Giglioli, C.M.Z.S.; two European Phylodactyles (*Phylodactylus emarginatus*) from Cannes, presented by Mr. J. C. Warburg; two Peruvian Thicknees (*Edicnemus*

superciliaris) from Peru, an Allied Saltator (*Saltator assimilis*) from Brazil, an Australian Sheldrake (*Tadorna tadornoides*) from Australia, received in exchange; a Common Zebra (*Equus zebra* ♂) from South Africa, two Shore Larks (*Otocorys alpestris*), British, purchased.

OUR ASTRONOMICAL COLUMN

PUBLICATIONS OF THE WASHBURN OBSERVATORY, VOL. IV.—In the month of March 1884, Prof. Holden offered to Prof. Auwers to undertake the observation at Madison of the 303 fundamental stars required for the southern zones of the Astronomische Gesellschaft. In view, however, of the smallness of the staff of the Observatory, Prof. Holden would only pledge himself to secure four complete observations of each star; but, with his assistants, Mr. Comstock worked with so much zeal and energy that on his appointment to the Lick Observatory in the autumn of 1885, the stars from 0h. to 6h. of R.A., and from 12h. to 24h. had all been completely observed six times, the number Prof. Auwers had desired, in each element. Mr. Updegraff and Miss Lamb, who had latterly been Prof. Holden's assistants, succeeded in bringing the entire work to completion by the close of 1885, no fewer than 6444 observations of stars, irrespective of observations of the nadir point, having been secured in the course of its carrying out. The observations were always kept in a forward state of reduction, and thus the present volume contains the results of the entire work. Prof. Holden was not, however, able to give the observations so full a discussion as he had intended, and as they themselves seemed to merit by their accuracy. The probable error of a single R.A. of stars of the 303 list, observed in 1884, he found to be $\pm 0\cdot037s$. for himself, $\pm 0\cdot031s$. for Mr. Comstock; and for a single declination, for himself $\pm 0\cdot400$, for Mr. Comstock $\pm 0\cdot436$.

The results of these observations, which were made with the Repsold meridian-circle of 4·8 aperture, an instrument of essentially perfect optical and mechanical quality, naturally occupy the greater part of the present volume. It also contains some other matters of interest, amongst which may be noted a series of observations with wire screens before the object-glass of the meridian telescope, for the purpose of ascertaining the effect of magnitude on the recorded time of transit, and the determination of the longitude of a station near the western boundary of Dakota. It has been Prof. Holden's effort also to make the collection of star catalogues in the library of the Observatory as complete as possible, and for that purpose he has bought most of the principal catalogues attainable, and marked in them, so far as possible, all the errata which were known to him. A list of the sources from whence these corrections have been derived is here given, and will doubtless be of considerable use to other astronomers.

THE SECOND ARMAGH CATALOGUE OF 3300 STARS.—Dr. Dreyer, on his appointment to the direction of the Armagh Observatory after the death of Dr. Robinson, found a great mass of unpublished meridian observations which had been accumulating since 1859, the date of the publication of the first Armagh Catalogue. On the completion of that great work, Dr. Robinson had formed the plan of re-observing a number of stars occurring in Baily's Catalogue from Lalande's "Histoire Celeste," and the observations were commenced in 1859, but the work was interrupted at the end of the following year, the Primate, Lord John George Beresford, having generously provided a new telescope of 7 inches aperture for the mural circle, instead of the old one of 3½ inches aperture. The idea of Dr. Robinson, of converting the mural circle into a transit instrument by the addition of a second pier, was not, however, carried out. The observations were recommenced in April 1863, the Rev. W. H. Rambaut being the observer from August 1864 to July 1868, and the Rev. C. Faris from November 1868 to the beginning of 1882. Dr. Dreyer himself observed during 1883, with the end of which year the observations close. Considering that the majority of the stars had, in the course of late years, been observed in the zones of the Astronomische Gesellschaft, and that nearly all might be expected to be included in the forthcoming great Paris Catalogue, Dr. Dreyer thought it important to publish the Armagh results as speedily as possible, and the Government Grant Committee of the Royal Society having promised to meet the cost of publication, the present Catalogue was prepared. It contains the results of the whole of the meridian work carried on at the Observatory since 1859;

containing thus, with the first Armagh Catalogue, a complete record of all the meridian work accomplished at the Observatory since 1827; for the results published in the *Transactions* of the Royal Dublin Society in 1872, and forming a catalogue of 1000 stars, have been incorporated in the present work, as there were numerous unpublished observations of many of the stars there given.

The R.A.'s of the present Catalogue depend on the standard stars of the *Nautical Almanac*, four or five of which were observed on each night, whilst the N.P.D.'s depend upon observations of the nadir point, the adopted being $54^{\circ} 21' 12'' 70$. Dr. Robinson's investigation of the division-errors of the circle (*Mem. R.A.S.*, vol. ix.), and also his refraction-tables (Armagh Catalogue, pp. 334-35) have been used. The details of the construction of the refraction-tables, which may be considered as identical with Bessel's, are given in the *Transactions* of the Royal Irish Academy, vol. xix. The places of the stars are reduced to the epoch 1875.0, with Struve's constant, but proper motions were never taken into account. The Catalogue, which is very clearly printed, and forms a very compact and neat-looking volume, contains for each star its number in Lalande, its magnitude, generally from the D.M., its mean R.A. and N.P.D. for 1875.0, together with the annual precession, the number of observations, the epoch and references to other modern star catalogues, this last column being very complete. The secular variation has been omitted. The introduction also contains a comparison between the present Catalogue and Prof. Grant's Glasgow Catalogue of 6415 stars, not only because it was deduced from observations made nearly at the same time as the Armagh observations and depended in R.A. on the *Nautical Almanac* stars, but also because it had already been rigorously compared by Prof. Auwers with his "Fundamental Catalogue." From the comparison of 539 which the two catalogues have in common, it would appear that the Armagh and Glasgow Catalogues, though perfectly independent of each other, are in fair agreement, so far as N.P.D.'s are concerned. But the R.A.'s appear less satisfactory, as considerable discordances are evident. These Dr. Dreyer thinks may be readily accounted for, partly by the one-sided character of the instrument, partly by the conjecture that perhaps the azimuth found by observing the meridian mark may not be strictly applicable on the opposite (south) side of the zenith. The comparison with Auwers's "Fundamental System" gives a similar result, the N.P.D.'s agreeing much better than the R.A.'s. The probable error of a single observation found from 400 observations of 80 stars between 30° and 100° N.P.D. was R.A. $\pm 0.081s$, N.P.D. ± 0.0785 .

Great credit is due to Mr. Faris for his perseverance in continuing and reducing the observations during thirteen years, and to the present Director for his energy in completing and publishing the entire results, which will not fail to be a useful addition to our star catalogues.

ASTRONOMICAL PHENOMENA FOR THE WEEK 1886 DECEMBER 19-25

(FOR the reckoning of time the civil day, commencing at Greenwich mean midnight, counting the hours on to 24, is here employed.)

At Greenwich on December 19

Sun rises, 8h. 4m.; souths, 11h. 57m. 21.5s.; sets, 15h. 50m.; decl. on meridian, $23^{\circ} 26'$ S.; Sidereal Time at Sunset, 21h. 43m.

Moon (one day after Last Quarter) rises, 0h. 42m.; souths, 6h. 52m.; sets, 12h. 51m.; decl. on meridian, $1^{\circ} 8'$ S.

Planet	Rises		Souths		Sets		Decl. on meridian
	h. m.	h. m.	h. m.	h. m.	h. m.	h. m.	
Mercury	6	3	10	26	14	49	$18^{\circ} 54'$ S.
Venus	8	25	12	14	16	3	$23^{\circ} 58'$ S.
Mars	10	0	14	2	18	4	$22^{\circ} 4'$ S.
Jupiter	2	53	8	3	13	13	$10^{\circ} 31'$ S.
Saturn	17	35*	1	39	9	43	$21^{\circ} 38'$ N.

* Indicates that the rising is that of the preceding evening.

Occultations of Stars by the Moon (visible at Greenwich)

Dec.	Star	Mag.	Disap.	Reap.	Corresponding angles from vertex to right for inverted image	
					h. m.	h. m.
19	γ Virginis	2.3	1	50	2	34
19	B.A.C. 4277	6	2	55	3	21
					74	170
					100	148

Dec.	h.
20	15	Jupiter in conjunction with and $3^{\circ} 24'$ south of the Moon.
21	—	Sun at greatest declination south; shortest day in northern latitudes.
22	14	Mercury at greatest elongation from the Sun, 22° west.

Star	Variable Stars		Decl.	Dec.	h. m.
	R.A.	h. m.			
U Cephei	0 52.2	81 16	N.	23,	0 44 m
Algol	3 0.8	40 31	N.	24,	4 9 m
λ Tauri	3 54.4	12 10	N.	20,	6 42 m
U Monocerotis	7 25.4	9 32	S.	22,	5 35 m
W Virginis	13 20.2	2 47	S.	24,	21 30 m
δ Libræ	14 54.9	8 4	S.	20,	20 33 m
U Coronæ	15 13.6	32 4	N.	23,	4 24 m
V Ophiuchi	16 20.4	12 10	S.	20,	19 57 m
R Scuti	18 41.4	5 50	N.	24,	6 48 m
δ Cephei	22 24.9	57 50	N.	22,	2 20 M

M signifies maximum; m minimum.

Meteor-Showers

Ursa Major supplies a couple of radiants at this season—one near α , R.A. 131° , Decl. 48° N., the other near α , R.A. 157° , Decl. 64° N. December 19 and 21 are fireball dates.

SANITARY PROGRESS DURING THE REIGN OF THE QUEEN¹

IN opening the meetings of the One Hundred and Thirty-third Session, it appeared to me that, as we are entering upon the jubilee year of the Queen's reign, it might be interesting to take stock, as it were, of the progress which has been made by the nation in some one of the branches of usefulness to which the proceedings of this Society have contributed; and it occurred to me that the most fitting subject to select would be that of the progress which has been made in sanitation during Her Majesty's reign.

The year 1838 was the first complete year of registration. The first report of the Registrar-General brought forward the sanitary condition of different parts of the country, and of different classes of the population. Disease was as prevalent amongst the labouring population in rural villages as it was in the most crowded and filthy districts in towns, and, on the motion of the Bishop of London, the House of Lords, in August 1839, presented an address to the Queen, begging her to direct an inquiry into this prevalence of disease. From this period may be said to date that great social and sanitary movement which has tended so largely to ameliorate the moral as well as the physical condition of the people of this island, and which forms one of the most prominent features of the Queen's reign.

The Poor-Law Commissioners were directed to report upon the condition of the labouring classes; and the direct evidence of much preventable disease, which the records of disease and death furnished from all parts of the country, formed the basis on which the Commission founded their recommendations. In towns, the people were crowded in courts and alleys; they swarmed in cellars which were neither ventilated nor drained. In 1837, it was calculated that one-tenth of the population of Manchester, and one-seventh of the population of Liverpool, lived in cellars.

The dead were buried in overcrowded churches, chapels, and churchyards in the middle of towns. The rural districts were no better.

In the towns this condition of things arose from the great increase of population which had been taking place for some years previously, coincident with the rapid expansion of our trade and manufactures, coupled with the absence of legislative provisions to meet the new exigencies which had arisen, and with which the older laws, in consequence of that increase, were unable to cope.

But there were other active causes. For instance, the Commissioners state that parochial administration operated mischievously in degrading the habitations of the labouring classes,

¹ Abstract of Address by Capt. Douglas Galton, C.B., F.R.S., at the opening of the Session of the Society of Arts.

and in checking tendencies to improvement. The depression of the tenement depressed the habits and condition of the inhabitants.

In speaking of the insanitary condition of houses, we must not forget the effect of the window tax. This tax had been established for 150 years. Air and sunshine are the first requirements of healthy dwellings, and the window tax induced every builder to shut out the sun and exclude the air, so that poor men were unable to afford the luxury of adequate windows for their dwelling-rooms, or of any windows for their closets. Darkness and dirt go hand in hand, and in the class of houses above the cottages, darkness and want of ventilation were much fostered by the window tax. This tax was not abolished till 1851.

At the commencement of the Queen's reign, drainage over the whole country was provided for by various Commissions of Sewers. Their duty was limited to causing "to be made, corrected, or repaired, amended, put down or reformed, as the case shall require, walls, ditches, banks, gutters, sewers, gates, cullasses, bridges, streams, and other defences by the coasts of the sea and marsh ground."

The Highway Acts provided for road cleaning and road structure; and there was a law for cleansing of ditches, which forbade throwing offal and foul refuse into the ditches which might lead to the pollution of streams.

The most important, perhaps, because the most cheap and accessible, authority for enforcing the execution of the law for the protection of the subject against nuisances, and for punishing particular violations of it, was vested in the Court of Leet. The juries, commonly called "annoyance juries," impanelled to serve on courts leet in towns, perambulated their districts to judge of nuisances upon the view; but the Commissioners reported that, with all this legal strength, there was scarcely one town in England found in a low sanitary condition, or scarcely one village marked as the abode of fever, that did not present an example of standing violations of the law, and of the infliction of public and common as well as of private injuries, the tenements over-crowded, streets replete with injurious nuisances, the air rendered noisome by these and by the smoke from factory chimneys, and the streams of pure water polluted.

As regards smoke, most of the then modern private Acts contained penalties on gas companies, prohibiting their washings to contaminate streams, or using for steam-engines furnaces which did not consume their own smoke. The general statute, 1 and 2 Geo. IV., c. 41, empowered the Court to award costs to the prosecutor of those who used such furnaces; but the duty of informing was not placed on public officers, and private individuals were unwilling to become informers.

The provision of pure water, and the disposal of the water after it had been fouled, had scarcely been thought about. No doubt, in London, and in some large towns, water was provided by public companies or by the corporation; but in almost every country town the water supply was defective.

The report on the sanitary condition of the labouring classes states that it was difficult to conceive the great extent to which the labouring classes are subjected to privations, not only of water for the purpose of ablution, house-cleansing, and sewerage, but of wholesome water for drinking and culinary purposes. Whilst, however, the water supply was insufficient even in London, on the other hand the necessity for providing means for getting rid of the fouled water was generally ignored.

It is stated, in the report of 1842, that the courts inhabited by the poorer classes in towns are generally not flagged; they are paved with a sort of pebbles; they are always wet and dirty. The people, having no convenience in their houses for getting rid of waste water, throw it down at the doors; that scarcely one house for the working classes will be found in which there is such a thing as a sink for getting rid of the water. It mentions, in a typical case, that, where in one locality a large sewer had recently been made, the landlords are not compelled, and do not go to the expense of making any communication from the courts to the sewer; the courts are as wet and dirty, and in as bad a condition as they were before the sewer was constructed; and it is added that this miserable accommodation in the wretched courts pays a better percentage than any other description of property; it pays as much as 20 per cent. in many instances.

With regard to fecal matter, the general practice had been for each house to have its cesspit, which was emptied at intervals by night men; but in the poor districts the soil was allowed by the occupiers to accumulate for years to avoid the expense of emptying. Within the preceding twenty years water-closets had

been introduced into the better class of houses. The refuse from these was generally allowed to flow into the cesspits; but, to avoid the expense of frequent emptying, an overflow was made, where practicable, into sewers or adjacent ditches; in other cases the refuse was turned directly into the sewers, and created a dangerous deposit.

The danger had begun to be noticed long before; for in 1834 one medical witness stated to a Committee of the House of Commons that of all cases of severe typhus that he had seen, eight-tenths were either in houses of which the drains from the sewers were untrapped, or which, being trapped, were situated opposite gully holes; and the report of the Poor-Law Commissioners remarks that this recent mode of cleansing adopted in wealthy and newly-built districts by the use of water-closets, which discharge all refuse at once from the house through the drain into the sewers, whilst it saves delay, prevents accumulation, and also saves the expense of hand labour; yet has the objection that if much extended it may pollute the water of the river into which the sewers are discharged. They, however, recommend that this danger should be incurred, as a lesser evil than the retention of the refuse in houses; adding that—

"It is possible to remove the refuse in such a mode as to avoid the pollution of the river, and at the same time avoid the culpable waste of this most important manure."

The conditions under which the drains had been constructed were entirely different from those which became necessary with the increase of population. The sewers had been constructed for land drainage, and only with reference to the wants of the immediate locality, so as just to drain it to the nearest outlet, without any reference to any general plan of sewerage. The sewers were generally flat at the bottom, of stone or brick; the joints were not specially water-tight, so that much of the liquid passed into the surrounding soil, and the floor of the sewers was covered with deposit, which had to be removed at much expense by hand, and in many cases the size and form of the sewers were adapted to enable the workmen to enter for cleansing purposes. When new lines of houses were built, new sewers were required for which outlets into the old sewers did not afford sufficient fall, and they then became choked with deposit. The cleansing of streets was not performed with uniformity or rapidity; and the condition of many of the back streets and courts was deplorable. They were not properly paved, and had no conveniences.

The Poor-Law Commissioners recommended, in the report already mentioned, that the expensive and slow process of the removal of the surface refuse of the streets by cartage might be dispensed with, and the whole at once carried away by the mode which is proved, in the case of the refuse of houses, to be the most rapid, cheap, and convenient, namely, by sweeping it at once into the sewers, and discharging it by water. This recommendation was largely adopted.

In order to convey some idea to your minds of the difficulties which would necessarily be caused by turning the street sweepings, which consisted largely of mud from macadamised roads directly into the sewers, I may mention that at the present time in London every effort is made to stop the road material from passing into the sewers by sweeping the streets, and by placing catchpits at the gullies and cleansing them frequently, and that in the metropolis the quantity of dirt from roads and gullies, and of deposits from sewers, removed annually, amounts to nearly 1,000,000 tons, and the annual quantity in those days cannot have fallen far short of 350,000 tons. The combined effect of turning the street sweepings and the water-closet refuse into sewers, with uneven falls and flat bottoms, naturally added to the deposit, and intensified the evils in such a manner as finally to force on improvements in the construction of the sewers.

The difficulties as to drainage and the removal of refuse were principally entailed by the absence of any legal machinery to enable the inhabitants of a locality to combine for sanitary purposes, and to share the expenditure necessary for improvements.

Another important insanitary condition was caused by the fact that the vagrant population of the kingdom resorted to common lodging-houses, which were under no sort of supervision, and which were *faci* for the propagation of epidemic disease, as well as of moral depravity.

The general conclusions at which the Poor-Law Commissioners arrived in their report on the condition of the working classes were that disease originating in, or propagated by means of, decomposing refuse and other filth, and damp, close, and over-

crowded dwellings, prevailed generally among the working classes in all parts of the kingdom; and that whilst these diseases could be abated by improved sanitary conditions, they were not removed by high wages and abundant food if sanitary conditions were absent. They also pointed out that owing to the defective water-supply cleanly habits were impossible.

In illustration of the loss caused to the nation by these preventable diseases, they mentioned that out of 43,000 widows and 112,000 destitute orphans relieved from the poor-rates, the greater number had lost their husbands or fathers from preventable diseases; and that the youthful population of either sex brought up in crowded, unwholesome dwellings, and under the adverse circumstances described, were deficient in physical strength and moral conduct, and grew up improvident, reckless, and intemperate, caring for nothing but sensual gratification. They pointed out that the expenses of local public works were unequally and unfairly assessed, oppressively and uneconomically collected by separate collections, and wastefully expended by unskilled and irresponsible officers, and that the existing law for the protection of the public health, and the constitutional machinery for its execution, such as the Courts Leet, have fallen into desuetude.

The Commission then went on to state the conditions required for improving the sanitary condition of the labouring classes.

This report was thus one of the early fruits of the system of vital statistics which commenced at the accession of the Queen, under the able supervision of our late eminent member, Dr. Farr. The report itself was drawn up by another eminent member of this Society, Mr. Edwin Chadwick, C.B. It is a remarkable tribute to the foresight of Mr. Chadwick that, during the last half-century, almost all the sanitary principles laid down in the report have been recognised by the Legislature as necessary to the welfare of the community, and have become matters of ordinary practice. The conclusions of the Poor-Law Commissioners, and the general interest awakened in the subject, led to various sanitary investigations, both by Royal Commissions and Committees of the Houses of Parliament.

When the Registration Act came into operation, an epidemic of small-pox was advancing over this island. It attained its maximum in the spring of 1838, and destroyed 30,819 persons. Dr. Farr mentions that vaccination protected a part of the population, but that there is reason to believe that inoculation led to the extension of the epidemic by diffusing the infection artificially. In 1840 and 1841, the first Vaccination Acts were passed. These prohibited inoculation, and empowered the Guardians to provide means for vaccination, and to charge the expense on the rates; and enacted that vaccination was not to be considered parochial relief, thus recognising the fact that the community should bear the cost of measures which are found necessary to secure the public health. It was not, however, till 1853 that vaccination was made compulsory.

The reports of the various Commissions and Committees of Parliament which inquired into the condition of the people showed the great importance of cleanliness of person and clothing to health, and the difficulties which the poor suffered in respect of it; and in 1844, private associations, not only in London, but in Manchester, Liverpool, and other large towns, were formed to encourage cleanliness amongst the working classes by establishing public baths and wash-houses, and lending out pails, brushes, and whitewash to the poor to cleanse their dwellings; and in 1846, the Bishop of London brought in a general Act empowering local authorities to establish public baths and wash-houses, the expense of which was to be defrayed out of the rates.

As regards general sanitary legislation, it is probable that the recommendations in the Poor-Law Commissioners' report and in the reports of these several Royal Commissions and Committees of the Houses of Parliament, would have remained long in abeyance had it not happened that the nation was threatened with an epidemic of cholera.

In 1832-33, the cholera had visited our shores and snatched 16,437 victims. It again appeared in London on September 22, 1848, and in Edinburgh in the beginning of October, 1848. So long as the insanitary conditions remain, epidemics invariably haunt the same localities, and the first appearance of the cholera in Bermondsey in 1848 was close to the same ditch in which the earliest fatal cases occurred in 1832. The first case of cholera that occurred in the town of Leith took place in the same house and within a few feet of the very spot from whence the previous epidemic of 1832 commenced its course. On its

reappearance in 1848 in the town of Pollockshaws, it snatched its first victim from the same room and the very bed in which it broke out in 1832. It did not, however, attain its full intensity until 1849, and it ceased on December 22, 1849. Its progress fully corroborated the report of the Poor-Law Commissioners. It attacked those towns and houses which offered to it the best inducements to visit them, in their filthy, decaying refuse, crowded and dirty population, bad water, damp polluted sub-soil, or any other of those conditions which lead to bad health in a population, and which, when cholera is absent, afford an evidence of their existence by the prevalence of scarlet fever, small-pox, typhoid and other fevers, measles, whooping-cough, &c. The total number of victims was 53,293.

The near approach of the cholera led Parliament, in 1848, to the conclusion that—

“Further and more effectual provision ought to be made for improving the sanitary condition of towns and populous places in England and Wales, and it is expedient that the supply of water to such towns and places, and the sewerage, drainage, cleansing, and paving thereof, should, as far as practicable, be placed under one and the same local management and control, subject to general supervision.”

An Act was passed creating a General Board of Health. The main feature of this Act was, that when the Registrar-General's returns showed that the number of deaths on an average of the preceding seven years exceeded 23 per 1000, the General Board of Health were empowered to send an inspector to make a public inquiry as to the sewerage, drainage, water supply, burial-grounds, number and sanitary condition of inhabitants, and local Sanitary Acts in force; also as to natural drainage areas, the existing local boundaries, and whether others might be advantageously adopted. The General Board were empowered to issue provisional orders, creating a system of local administration by means of Local Boards of Health, consisting partly of municipal authorities, and partly of elected members. These Local Boards were empowered to appoint necessary officers, including medical officers of health, surveyors, and inspectors of nuisances. The public sewers were vested in the Local Board, and they were to maintain, cleanse, and regulate the use of sewers. All houses rebuilt were required to be provided with drains approved by the surveyor; and, before any new house was commenced, the levels of the cellars or lowest floors, and the position and character of the drains or cesspools, were to be approved by the surveyor. The occupation of cellars as dwellings was prohibited. Water-closets, or privies, and ash-pits were to be provided to all houses and workshops. The Local Board was also required to manage, repair, and clean the streets, and to provide for removal of refuse. They were to abate nuisances, regulate slaughter-houses, register and make by-laws to regulate common lodging-houses. The local authorities were empowered to provide public recreation-grounds, and to provide a water supply, except where a water company would supply on reasonable terms. They were also to provide mortuaries; to obtain power to close burial-grounds which they considered to be unhealthy, and to open new ones.

The Local Boards were empowered to make by-laws and impose penalties, subject to confirmation by the Secretary of State, and to levy rates, to mortgage the rates, and to borrow from the Public Works Loan Commission. The Act also provided for sewers, wells, pumps, &c., to be made where desired by the inhabitants in parishes containing less than 2000 persons. The metropolis was exempted from the operation of this Act.

The General Board of Health came into existence in 1848, just before the outbreak of cholera in this country, and it took measures at once to check the disease, and proclaimed the principles upon which the preventive and other measures for meeting the epidemic ought to be conducted. Amongst these measures, probably the one which had the greatest effect in promoting subsequently a general feeling of the necessity for sanitary improvements, and which awoke in the nation the needs of moral improvement, was that requiring house-to-house visitation, and the cleansing of the houses and streets, and obtaining an adequate water supply.

This epidemic also brought into notice the necessity of appointing efficient medical officers to supervise the sanitary condition of the different towns and districts.

Further Acts for regulating the public health were passed in 1858, 1861, and subsequent years; and all their provisions were embodied in a General Act in 1875, from the operation of which the metropolis was exempted. Subsidiary to these may be mentioned the Acts regulating rural water supply, the Artisans'

nd Labourers' Dwellings Acts, or what have been more recently termed the housing of the working classes, and also Acts for checking the adulteration of food, as well as other Acts relating to the diseases of animals. This general legislation has been largely supplemented by by-laws issued by local authorities, with the sanction of the Local Government Board, and by means of Local Acts obtained by various towns.

The Act of 1848 initiated the system which subsequent legislation has supplemented, under which many towns and rural districts have borrowed money for and have executed public sanitary works during the last forty years. The importance of his measure may be gauged by the fact that the money borrowed since that time for sanitary works, and not yet repaid, amounts to over 130,000,000*l.*, in addition to very large sums spent out of current rates; and in addition to an enormous private expenditure, which is beyond the reach of calculation, for the reconstruction of house drains. This legislation and expenditure have caused a complete revolution in that branch of engineering science connected with public health, viz. drainage and water supply, and has gradually established it on a scientific basis.

Modern sewerage may be said to date from the introduction of oval forms in sewers, by Mr. Roe and Mr. Phillips,¹ under the Commissioners of Sewers, in 1845; the construction of impervious clay pipes for smaller drains; the recognition of the necessity that sewers and drains should be water-tight and self-cleansing; and that junctions should be carefully made. Ventilation of the sewers followed a severe outbreak of typhoid fever, consequent upon the construction of a new unventilated sewer at Troydon. In 1849-50, Sir Robert Rawlinson introduced the system of constructing sewers and drains in right lines from joint to joint, with lamp-holes or man-holes at every change of direction or of gradient; this is now the recognised method of construction among all English-speaking races. The reconstruction of the sewers led to a reform in house drainage, of which the leading characteristics are imperviousness of material, free ventilation, and facility of inspection at all points.

The disposal of water-carried sewage began by leading to the widespread pollution of our streams and rivers, and the serious injury of the sea beach in many of our seaside health resorts. The problem was complicated by the doctrine that as the pollution was caused by a vast amount of fertilising matter, large profits might be made out of its removal. But those who made his assertion generally overlooked the fact that the conveyance of the refuse would have to be paid for just like any other work. The subject has been repeatedly discussed in this hall, but it is far too extensive for me to enter into here.

Let us now turn from the community generally to the metropolis, which was excluded from the operation of the Sanitary Acts of 1848 and 1875. The population of London was 960,000 in 1801. At the Queen's accession it had more than doubled, and amounted to about 1,900,000. At the present time it is very nearly 4,000,000. The metropolis has, from its situation, all the attributes of a healthy city. It lies in a valley through the centre of which the Thames sweeps from west to east, and the winds rushing over its water afford a continuous supply of fresh air to the middle of the City. But the advantages of this situation had been largely frustrated by the unopposed efforts of the landowners to accumulate the greatest possible number of houses on the least possible space, by which the free circulation of air was impeded in some districts, and the families of artisans were crowded in small, low, close rooms, without space for the safe retention of refuse; and there was no adequate machinery for its rapid removal.

London is now, undoubtedly, the finest capital in the world. It was far from being so at the beginning of the Queen's reign. Among other things, there were deplorable deficiencies in the sewerage. The drainage found its way through badly-formed, leaky drains into the old water-courses, and thence to the river; the sewage was floated up and down by the tide in the heart of the London, until it was deposited on the shore at low water in tidal banks, which covered the foreshore from Blackfriars to Battersea.

One of the early effects on the metropolis of the report of the Poor-Law Commission, was a Metropolitan Building Act for improvement of drainage, and for securing a sufficient width of streets and alleys, and due ventilation of buildings, and to regulate the construction of buildings, authorising the vestries to appoint district surveyors.

¹Mr. Phillips is at present employed in superintending the reconstruction of the drainage of the Houses of Parliament.

In 1846, a new Commission of Sewers was formed, and charged with the duty of revising the metropolitan drainage. The Commissioners applied for an Ordnance survey of the metropolis, which was commenced in 1847.

The water supply of London was furnished by water companies, who trenched upon each other's districts. Its volume may be assumed, at the Queen's accession, to have been about 36,000,000 gallons per twenty-four hours. It was estimated by Mr. Wicksteed, in 1845, at 45,000,000 gallons. Some was derived from the tidal part of the Thames, and was more or less filtered; but, from its doubtful purity, pumps in surface-wells, often adjacent to churchyards, were frequently preferred for drinking-water. In many of the courts and smaller streets water was obtained only from a small stand-pipe, where the water was turned on for an hour or less daily, when the inhabitants stood around waiting with whatever vessels they might have at hand for their turn to procure a portion of a miserably scanty supply, which was then stored for use in probably the only room occupied by a whole family. Amongst the poorer classes, almost the only receptacles that existed were wooden butts, frequently in a state of decay; and, as they were for the most part without covers, the water was placed under favourable circumstances for the reception of dirt and refuse and for the development of animal and vegetable growths.

After the cholera epidemic, the question of the purity and quantity of the water supply attracted notice; and in 1852, Parliament passed an Act forbidding the supply of water from the tidal part of the Thames or its tributaries, and requiring all river water to be filtered and to be kept covered after filtration; also requiring a constant service when demanded by four-fifths of the houses in a district. In 1858, the average daily supply had risen to 75,000,000 gallons. In 1871, another general Act was passed, to make further provisions for securing to the metropolis a constant supply of pure water; this Act defined the sources of supply of the several companies, and required, amongst other matters, efficient filtration, and the application of tests of purity.

The amount of water delivered into London by the water companies for September last was 178,196,597 gallons in twenty-four hours, of which about 90,000,000 gallons came from the Thames above Teddington Lock; its purity is ascertained by continual analysis; and it may now be said that the water supplied to London rivals that of any other city in purity.

It was not till 1852 that the Secretary of State was authorised to prohibit burials within the metropolis.

A new era in metropolitan sanitation was inaugurated in 1855. In that year the Metropolitan Board of Works was created. In this body was vested the main drainage of the metropolis, but the charge of the subsidiary parish sewers was left to the vestries, who were also charged with the care of the streets and roads, the Metropolitan Roads Commission being abolished, and all duties of lighting, control of removal of refuse, &c., were placed on the vestries.

Thus the formation of this new Board was somewhat of a retrograde movement, because the concentration of functions, which had been commenced under the Metropolitan Roads Commission and Metropolitan Sewers Commission, instead of being strengthened in the new Board, was abandoned, and something approaching chaos was introduced. This Board has, however, by degrees had remitted to it the care of London improvements, and certain other general municipal functions, as well as power to levy general rates. The City retained its individuality, excepting as to the main sewers, and effected improvements and opened out thoroughfares in the part under its jurisdiction. The improvements in the other parts of London are mainly due to the action of the Metropolitan Board of Works. Great alterations have taken place in our thoroughfares. Many of those large tracts of London which were occupied by dwellings of the most wretched description, are now traversed by wide thoroughfares, and covered by artisans' dwellings erected by private enterprise. But there is no diminution of the rate at which the vast aggregation of population in London still continues to progress; and, unfortunately, many of the wretched crowded dwellings still remain, where those born in close rooms, brought up in narrow streets, and early made familiar with vice, are deteriorated in physique, and grow poorer from inability to work.

The reconstruction of the drains, the removal of the sewage from the midst of the population, the opening out of thoroughfares so as to admit ventilation into crowded districts, have all tended to improve the sanitary condition of London.

I have some interesting tables, prepared for me by the kindness of Mr. A. J. Mundy, of the Registrar-General's Office, which show the remarkable sanitary results of these various efforts. The death-rate of London in the five years 1838-42 was 25·57 per 1000. In the five years 1880-84 it was 21·01 per 1000; and the deaths from zymotic diseases, which in the decade 1841-50 had averaged annually 5·29 per 1000, were reduced in the years 1880-84 to 3·4 per 1000. If, however, we assume that there had been no change in sanitary conditions, and therefore that the death-rate had gone on increasing according to Dr. Farr's formula of increase due to density of population when the sanitary conditions remain unchanged, the death-rate of 1880-84 would have averaged 26·62 per 1000; that is, a saving of 5·61 per 1000 has been effected by sanitary measures.

If upon this basis we compare the saving in life which has resulted from sanitary improvements at different periods since 1838-42, we find that it amounted to an annual saving of 4604 lives during 1860-70; of 13,929 lives annually during 1870-80; and of 21,847 lives annually between 1880-84. The main drainage works were commenced about 1860, and terminated in 1878, and the increase in the saving of life in these consecutive periods may to some extent be taken as a gauge of the effect of the gradual construction and completion of these works. No doubt this London death-rate is far too high, and is an evidence that insanitary conditions still prevail all round us, that the housing of the working classes is still far from satisfactory, and that we are too careless about infectious disease. The Metropolitan Board of Works has never had a clear field for municipal action; yet when we compare the present condition of London with what it was at the Queen's accession, the Metropolitan Board of Works, in spite of the disadvantages of its constitution, will have a grand record to show, in the jubilee year of the Queen's reign, of metropolitan improvements and metropolitan sanitation.

The main principle which guided public administration, both before and during the earlier years of the Queen's reign, may be said to have been that of non-interference, and of allowing free competition to prevail; although, no doubt, some efforts had been previously made to regulate the labour of females and children in Factory Acts.

The practical application of the knowledge derived from the Registrar-General's statistics led to further investigation in particular cases by such men as Dr. Simon, Dr. Buchanan, Sir Robert Rawlinson, and others, and gradually caused a reaction from what may be called the *laissez-faire* system, to the spread of opinion in the direction of control over individual action in the interest of the community generally; and the result was the enactment of the successive laws, for regulating the sanitary condition of the people, which I have enumerated above.

This large amount of legislation is practically little more than the interpretation required by the increase of population, and by the complicated exigencies of modern life, of the common-law maxims, *Prohibetur ne quis faciat in suo quod nocere possit alieno*; and *Sic utere tuo ut alienum non laedas*: that is to say, no man shall do anything by which his neighbour may be injuriously affected, and each person must so use his property and his rights as not to harm any one else.

This common-law doctrine had become practically obsolete, because there was no machinery in existence to enforce it; and the present generation inherited a legacy of misery amongst the poorer classes, owing to the absence of regulations in the building of houses as the towns increased in size, absence of water supply and drainage, and other matters which I have mentioned.

Mr. Mundy's calculations show us what have been the general results of the sanitary improvement of the nation. The death-rate of 1838-42 for England and Wales was 22·07 per 1000; that of 1880-84 was 19·62 per 1000; and the deaths from zymotic disease, which averaged 4·52 per 1000 in the decade 1841-50, were reduced to 2·71 per 1000 in the years 1880-84. It is, however, curious to note that the improvement in urban districts does not appear to have kept pace with that in rural districts, for it appears that whilst the deaths from zymotic disease in certain urban districts have declined from 5·89 per 1000 in the decade 1851-60 to 5·12 per 1000 in the decade 1871-80, the deaths from zymotic disease in rural districts in the same interval have declined from 2·77 to 1·67 per 1000.

In order to form an estimate of the saving of life due to sanitary measures, we may assume that sanitation remained in abeyance, and calculate what the death-rate, according to Dr. Farr's formula, would have been in consequence of increased density of population, and compare that with the actual death-

rate; upon this assumption we find that the sanitary improvements only began to tell after the cholera epidemic of 1848-49. In the decade 1841-50, indeed, it appears that the death-rate was actually larger than that due to the increased density of population. But in the following decade, the sanitary improvements began to produce their effect, and this effect has gradually increased. In the decade 1850-60, the annual average saving of lives in England and Wales from sanitary improvements was 7789; in the decade 1860-70, it rose to 10,481; in the decade 1870-80, it was 48,443; and in the five years 1880-84, the average annual number of lives saved by sanitary improvements have been 102,240.

The present social condition of the people affords an equally striking evidence of general improvement. Food and clothing are cheap; the construction of streets and new buildings in our towns are regulated; houses are improved; overcrowding and cellar dwellings are prohibited; the common lodging-houses are controlled. Petroleum affords a brilliant light to the poor in country districts which are beyond the reach of gas or of the electric light, and who were formerly dependent on rushlights. Water supply is rarely deficient; removal of refuse is enforced. But there remains much still to be done. Numbers of the people are still crowded in wretched dwellings; our rivers are polluted and subject to floods; our infectious diseases are not properly cared for.

The main feature of the legislation of the past half-century is the recognition of the principle that when large numbers are congregated together in communities, the duty of preventing injury from this aggregation rests on the community; and if this principle is duly acted on, if in all aggregations of population free circulation of air is encouraged by preventing the crowding together of buildings; if refuse is immediately disposed of, so as to cause no injury to any one; if pure water be provided; if we isolate infectious diseases; and, above all, if we are fortunate enough to retain the blessing of cheap food and clothing, we shall not transmit to our posterity a similar legacy of misery to that which we inherited.

ON THE FORMS OF CLOUDS¹

THE object of the paper was to explain a theory with regard to the principles that may have the greatest effect in producing the leading cloud-forms. Neglecting occasional and exceptional influences, the author stated that the causes with which his paper dealt might be classed under three heads: (1) the diminished specific gravity of the air when more or less charged with invisible vapour, (2) the differential horizontal motion of the atmosphere, (3) the vertical motion in the atmosphere produced by the heat of the sun expanding the lower air. The first of these was universally recognised as the initial cause of the cumulus, or first-born primary cloud. It was produced when there was so much vapour generated in the lower atmosphere that the vapour-laden layer projected up within the limit of condensation. Of course the vapour below this limit would itself become condensed if cooled in the course of its travels. During the formation of the cumulus, calm was supposed to prevail. When the atmosphere was in motion, its differential horizontal movement produced the first important modification. Retarded by friction and other causes, the lower portion of the cumulus moved more slowly than the upper, and the cloud sheared over into a slanting position, and ultimately became the cumulo-stratus. A young cloud was thus distinguishable from those that had travelled even a short distance. In this climate large well-developed cumuli, though common in summer, were seldom seen in the cold season. The majority of the clouds of the first stage seen here were born in warm latitudes, and, coming as travelled cumuli, showed more or less the condition of the cumulo-stratus. The invisible vapour was subject to this same shearing motion, and far-travelled water-vapour would, on its rising, as it soon does in this climate, to the height necessary for condensation, at once take the shape of the stratus. In the next stratum above, Mr. Glaisher's investigations in his balloon ascents showed a rather rapid change to a drier atmosphere. Here were found the cirro-cumulus, and cirro-stratus. The differential motion of the atmosphere, though diminished, was still an important agent, and produced results that were not possible in the more bulky and dense clouds of the lowest range. When the sun's

¹ Abstract of a Paper read at the Birmingham meeting, 1886, of the British Association, by A. F. Osler, F.R.S. Communicated by Prof. Balfour Stewart, F.R.S.

It expanded the lower atmosphere, the upper cloud-stratum would be lifted, flattened, and broken into patches, the result being a mackerel sky. Should, however, the expansion in the lower atmosphere take place very slowly, it was possible that the cloud, though thinned, would remain unbroken. Rapid motion of the atmosphere would elongate the cloud in the direction of motion; and, if accompanied by expansion from below, would rupture the cloud into ribs or bars at right angles to the current. The mass of the cloud were stationary or moving slowly, prominent parts might be drawn out into "mares'-tails."

FURTHER EXPERIMENTS ON FLAME

In my former paper, published in NATURE, vol. xxxi. p. 272, I showed that there are two classes of continuous spectra, those due to an incandescent precipitate, in which case the medium has the power of reflecting and polarising light; and, secondly, flames that possess no reflecting power, but give a soft continuous spectrum without maxima or minima.

Of this second class is carbonic oxide, which gives, at normal pressures, a fairly bright, and at increased pressure, according to Dr. Frankland, a very bright, continuous spectrum. I have observed its spectrum recently under reduced pressure, using an apparatus similar to that described by Dr. Frankland in his Experimental Researches, p. 884 et seq.

I had considerable difficulty at first in keeping the flame quiet at anything like low pressures, and finally adopted a glass, of a trumpet shape, increasing very gradually from 1 millimetre to 3 millimetres in diameter, the flame being farther shielded from draughts by a wide disk of cork 10 millimetres low the mouth of the jet.

Experiment 1.—Carbonic oxide was burnt in oxygen. The flame was densest close to the jet, and diminished in brightness

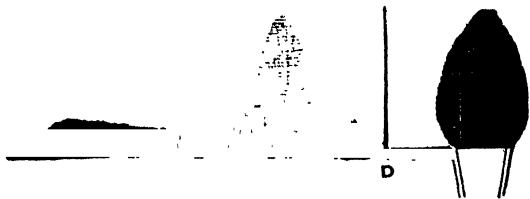

Flame of carbonic oxide burning in oxygen at 60 mm. pressure, with spectrum showing maxima. The continuous spectrum at the bottom is given by the red-hot top of the glass jet.

at the tip, without any definite separation into mantles with a space between. At normal pressure every part of it gave a continuous spectrum.

At about 260 millimetres there began to be a noticeable concentration of the light in the violet and the green in the position of the principal bands of the carbon spectrum. At 120 millimetres the concentration was unmistakable, but the spectrum was still continuous. At 60 millimetres it presented the appearance shown in the sketch. There appeared to be a second maximum in the green—not, however, at all well defined—but the principal maximum was continued upwards into a faint green cloud corresponding to the very faint tip of the flame; this cloud was perfectly isolated, but, unlike the carbon bands, was rightest in the middle.¹ I failed to see a similar cloud over the maximum in the violet, but this might be owing to insufficient light, my pumps being only able to maintain so high a vacuum against a very small flame. Mr. T. Legge, of Trinity, who was with me, observed that the comparative absence of the blue was very remarkable.

My supply of oxygen becoming exhausted, I had to use air. The flame became less bright, and the maxima less marked. By turning it very low, we brought the gauge down to 40 millimetres. The flame still burnt steadily.

Finally, at 60 millimetres pressure, I adjusted the flame to a height of three-quarters of an inch, opened the air-taps, and checked the pumps. The flame increased in brightness and decreased in size to rather more than a quarter of an inch at normal pressure, the spectrum becoming again perfectly continuous.

¹ It is impossible in a woodcut to give a true idea of the extreme faintness of this isolated cloud. It is only visible when the brighter part of the spectrum is hidden from the eye, and the room is perfectly dark.

Experiment 2.—Having the apparatus ready, I repeated Dr. Frankland's experiment of burning coal-gas in air under reduced pressure. He says that "finally, at 6 inches pressure, the last trace of yellow disappears from the summit of the flame, leaving the latter an almost perfect globe of a peculiar greenish-blue tint."

He used a jet contracted at the mouth to 1.5 millimetres. With my much wider trumpet-shaped jet, by turning on more gas I could produce smoke at 160 millimetres so as to blacken the glass chimney. At 120 millimetres the light was noticeably less vivid, the flame having a diluted appearance, but the spectrum showed the usual carbon lines much more sharply defined, the mantles being very much thicker than at normal pressure. With this exception there was no difference caused by the reduction of the pressure to 60 millimetres, and even then, on turning up the gas a little, the ellipsoidal flame became pointed, and the yellow light, giving the incandescence spectrum, re-appeared in the tip of it. It is evident that the trumpet-shaped jet allows carbon to be precipitated in the flame at much lower pressures than the contracted jet. In the same way alcohol heated in a bulb tube burns from the mouth of it with a bright and even smoky flame, whereas it burns from a wick with a blue one.

One phenomenon observed by Dr. Frankland I was disappointed not to see. He says: "Just before the disappearance of the yellow portion of the flame there comes into view a splendid halo of pinkish light forming a shell half an inch thick around the blue-green nucleus; . . . the colour of this luminous shell closely resembles that first noticed by Gassiot in the stratified electrical discharge passing through a nearly vacuous tube containing a trace of nitrogen." He does not speak of having used the spectroscopie to determine the nature of this pink glow.

I went considerably below the lowest pressure mentioned in his paper, viz. 4.6 inches, but entirely failed to reproduce it. But I have noticed that very small flames from capillary tubes, observed under a power of 100 in the microscope, are sometimes tinged with rose-colour in the outer mantle, from a very faint trace of sodium orange light mingling with the blue of the soft outer mantle; and I think that the jet he used or the glass chimney may have been sufficiently heated to give a rosy tinge to the flame.

One other point I would call attention to. The appearance of the gas-flame at low pressures is precisely like that of a very small gas-flame under the microscope. The inner mantle appears to be bordered with bright green light, due to the principal green band of the carbon spectrum extending slightly beyond the others. Beyond this, again, comes a zone of violet light due to the band in the violet, and in most cases this extends nearly, if not quite, to the outer mantle. At ordinary pressures this can only be seen with a magnifying-glass, except with a special burner; but the *in vacuo* flame is, as it were, magnified as to its structure, which is thus visible to the naked eye. This fact suggests that flames may in a sense obey Boyle's law, i.e. that the space required for complete combustion under given conditions varies inversely as the pressure. I am continuing my experiments.

GEORGE J. BURCH

SOCIETIES AND ACADEMIES

LONDON

Royal Society, November 18.—"The Coefficient of Viscosity of Air. Appendix." By Herbert Tomlinson, B.A. Communicated by Prof. G. G. Stokes, F.R.S.

In the previous experiments by the author on this subject, the coefficient of viscosity of air was determined from observations of the logarithmic decrement of amplitude of a torsionally vibrating wire, the lower extremity of which was soldered to the centre of a horizontal bar. From the bar were suspended vertically and at equal distances from the wire a pair of cylinders, or a pair of spheres. The distances of the cylinders or spheres from the wire were such that the main part of the loss of energy resulting from the friction of the air may be characterised as being due to the pushing of the air.

Acting on a suggestion of Prof. Stokes, the author proceeded to determine the coefficient of viscosity of air by suspending a hollow paper cylinder about 2 feet in length and half a foot in diameter, so that its axis should coincide as to its direction with the axis of rotation. The cylinder was supported by a light hollow horizontal bar, about 7 inches in length, to the centre of which the vertically suspended wire was soldered. The wire

was set in torsional vibration, and the logarithmic decrement determined with the same precautions as before.

The following were the results:—

Vibration-period in seconds	Coefficient of viscosity of air in C.G.S. units, μ	Temperature in degrees Centigrade
3.6038	0.00017708	12.225
8.8656	0.00017783	13.075

In these experiments the loss of energy arising from the friction of the air may be characterised as being due to the *dragging* of the air, and it is very remarkable that there should be such close agreement in the values of μ as determined by this and the previous methods. The mean value of the coefficient of viscosity of air obtained by this method is 0.00017746 at a temperature of 12.650 C., and the mean value deduced from the previous experiments when proper correction has been made for the rotation of the spheres and cylinders about their axes is 0.00017711 at a temperature of 11.79 C.

November 25.—“On the Structure and Life-History of *Entyloma Ranunculii* (Bonorden).” By H. Marshall Ward, M.A., F.L.S., Fellow of Christ's College, Cambridge, and Professor of Botany in the Forestry School, Royal Indian College, Cooper's Hill.

The author found plants of *Ranunculus Ficaria*, the leaves of which were spotted with white patches; the white patches spread from leaf to leaf, and the disease assumed the nature of an epidemic over a given area under examination. The rise, progress, and climax of the disease were observed both on isolated plants and in the open country, and the nature of the lesions in the leaves was made out. Some plants were found to succumb more rapidly; the evidence supporting this conclusion was given, and the circumstances to which the differences are due explained.

The white disease-spots contain the mycelium of *Entyloma Ranunculii*, and the resting-spores of this fungus (one of the Ustilagineae) were observed on it. The mycelium is very delicate and septate, and runs in the middle lamellæ between contiguous cells. The white powder on the outside of the disease-spot consists of conidia, very like those of some Ascomycetes. The author examined the anatomical connection between the conidia and the resting-spores, and showed that the conidia really belong to the same mycelium—in other words, the conidia are a second kind of spore of the *Entyloma*.

Even more important is the germination of these conidia: this has not been before observed in any *Entyloma*. The germination was traced step by step, not only on glass slips, but also on the living plant. Artificial infections were made, and it was shown how the germinal hyphæ entered the stomata, and produced a mycelium exactly like that in the disease-spots first investigated; not only so, but the *resting-spores of the Entyloma were produced on this mycelium*, thus placing beyond doubt the connection of the two spores. The time occupied in infection was also determined in many cases. Moreover, all the symptoms of the disease produced by infection with the conidia were as before. The paper was illustrated by diagrams, and specimens of the fungus were exhibited under the microscope.

Mathematical Society, December 9.—Sir J. Cockle, F.R.S., President, in the chair.—Prof. D. Y. Kikuchi, of Tokio, was elected a Member, and Mr. F. S. Macaulay admitted into the Society.—The following communications were made:—The linear partial differential equations satisfied by pure ternary reciprocants, by E. B. Elliott.—Circular notes, by R. Tucker.—The problem of the duration of play, by Capt. Macmahon, R.A.—Note on two annihilators in the theory of elliptic functions, by J. Griffiths.—Mr. Hammond spoke upon the subject of Capt. Macmahon's communication at the November meeting.

Linnean Society, December 2.—William Carruthers, F.R.S., President, in the chair.—The following gentlemen were elected Fellows of the Society, Messrs. J. W. Willis Bund, Arthur Dendy, Anthony Gepp, Tokutaro Ito, F. Krause, F. M. Lascelles, Fred Sander, R. von Lendenfeld, John Samson, Harry S. Burton, A. W. Sutton, and Chas. W. Wilson; afterwards Mr. Geo. Sim was elected an Associate.—The President read a letter from the Rev. M. J. Berkeley, concerning the death of his old and respected co-worker on fungi, Mr. C. E. Broome.—Mr. G. Maw exhibited ten photos of living *Narcissi*, made in the Riviera in 1870. He afterwards gave a short account of the North African and South Spanish *Narcissi* as

observed by him on a recent visit thither. The *Narcissus papyraceus* extends as far as Fez, in Morocco; south of that *N. sub-Broussoneti* takes its place, and is found from Saffi to Mogador. Incidental allusion was made to the smallest of the white forms of *N. Tazzetta* in the Island of Tenerife. Of the autumnal species, reference was made to *N. nudiflorus*, which had been lost sight of for half a century, but was re-discovered by Mr. Maw in 1883 in the neighbourhood of Gibraltar, and again recently near Tangier. A hybrid between *N. viridiflorus* and *N. serotinus* was found by him close to Gibraltar, and a series of hybrids between *N. viridiflorus* and *N. elegans* were got in North Morocco. Mr. Maw stated that *N. serotinus* was limited to the south of Spain, and *N. elegans* to the Morocco coast, the latter plant bearing true leaves. He mentioned the abundance in flower and fruit of a small Amaryllid, *Tapeinanthus humilis*, Herlert, as occurring eight miles south of Tangier.—Dr. Day read a paper on the Lochleven trout, which is the form that has been utilised by Sir James Maitland at Howietoun, where the elevation is similar to that of their original home, distant about 25 miles. These fish are known by their numerous œreal appendages, and up to their fourth or fifth year they are of a silvery gray, with black, but no red, spots. Subsequently they become of a golden purple with numerous black and red spots. Undergrown ones take on the colour of the burn trout. Remove these fish to a new locality, and they assume the form and colour of the indigenous trout. In 1883 a salmon parr and Lochleven trout were crossed, and the young have assumed the red adipose dorsal fin, and the white-edged margins to the dorsal and ventral, also the orange edges to both sides of the caudal—all colours found in the brook trout, but not in the salmon or Lochleven trout. The maxilla in this form not extending to behind the eye, the absence of a knob on the lower jaw in old breeding males and the difference in the fins from those of *Salmo fario* were shown to have been erroneous statements.—A paper was read on Hermann's “Ceylon Herbarium” and Linnaeus's “Flora Zeylanica,” by Dr. Henry Trimen. The collection of dried plants and the drawings of living ones made in Ceylon by Paul Hermann in the latter half of the seventeenth century possess a special interest as being the first important instalment of material towards a knowledge of the botany of the East Indies; but Hermann himself, who died in 1695, published very little of this material. Some of his manuscripts were subsequently printed by W. Sherard, including a catalogue of the herbarium, as then existing, under the title of “Museum Zeylanica” (1717). This herbarium was lost sight of till 1744, when it was recognised by Linnaeus in a collection sent to him from Copenhagen. After two years work at it, Linnaeus produced in 1747 his “Flora Zeylanica,” in which all the plants that he could determine are arranged under his genera. At that date Linnaeus had not initiated his binomial system of nomenclature; but in his subsequent systematic works he quoted the numbers of the “Flora Zeylanica,” and thus Hermann's specimens became the types of a number of Linnaeus's species, for the most part additional to those in his own herbarium in the possession of the Linnean Society.

Zoological Society, December 7.—Prof. W. H. Flower, F.R.S., President, in the chair.—Prof. Bell exhibited and made remarks on a specimen of a rare Entozoon (*Tenia nana*) from the human subject.—Mr. Tegetmeier exhibited and made remarks on a pair of antlers of a Deer, said to have been recently obtained in the Galtee Mountains in Ireland. They appeared to be those of the Elk (*Alces nuchalis*).—Mr. Frank E. Bedford read a paper on the development and structure of the ovum in the Dipnoan fishes. The present communication was a continuation of a research into the structure of the ovary in *Protopterus*. The author, besides being able to give a more complete account of the ovarian ova of *Protopterus*, was also able to supplement this account with some further notes respecting the structures observed in the ovary of *Ceratodus*.—Mr. A. Smith-Woodward read a paper on the anatomy and systematic position of the Liassic Selachian, *Squaloraja polyspondyla*. After a brief notice of previous researches, the author attempted an almost complete description of the skeletal parts of *Squaloraja*, as revealed by a fine series of fossils in the British Museum. He confirmed Davies's determination of the absence of the cephalic spine in certain individuals (presumably females), and added further evidence of its prehensile character, suggesting also that the various detached examples afforded indications of one or more new species. The author concluded with some general

remarks on the affinities of the genus, and proposed to institute a new family, "Squalorajidae," which might be placed near the Priostophoridae and Rhinobatidae.—Mr. Sclater, F.R.S., pointed out the characters of an apparently new Parrot of the genus *Conurus*, from a specimen living in the Society's Gardens. The species was proposed to be called *Conurus rubritorquis*.—Mr. F. Day, F.Z.S., communicated (on the part of Mr. J. Douglas Ogilby, of the Australian Museum, Sydney) a paper on an undescribed fish of the genus *Pimelopterus* from Port Jackson, N.S.W., proposed to be named *P. meridionalis*.—Mr. G. A. Boulenger read a paper on the South African Tortoises allied to *Testudo geometrica*, and pointed out the characters of three new species of this group, which he proposed to call *Testudo trimeni*, *T. smithii*, and *T. fiski*.—A second paper by Mr. Boulenger contained some criticisms on Prof. W. K. Parker's paper "On the Skull of the Chameleons," read at a previous meeting of the Society.—Mr. Oldfield Thomas read a paper on the Wallaby, commonly known as *Lagorchestes fasciatus*, and showed that the dentition of this animal was entirely different in character, not only from that of the typical species of *Lagorchestes*, but even from that of all the other members of the sub-family Macropodinae. He therefore proposed to form a new genus for its reception, to which he gave the name of *Lagostrophus*.—A communication was read from Prof. R. Collett, C.M.Z.S., containing the description of a new Pouched Mouse from Northern Queensland, which he proposed to name *Antechinus thomasi*.

Geological Society, November 17.—Prof. J. W. Judd, F.R.S., President, in the chair.—The following communications were read:—A letter from the Lieutenant-Governor of the Falkland Islands, communicated by H.M. Secretary of State for the Colonies, and printed in NATURE, vol. xxxiv. p. 440.—On the drifts of the Vale of Clwyd, and their relation to the caves and cave-deposits, by Prof. T. McKenny Hughes, M.A., F.G.S. The author divided his subject as follows:—I. Introductory remarks; II. the Drifts, viz. (i.) the Arenig Drift, (ii.) the St. Asaph Drift, (iii.) the Surface Drifts; III. the caves, viz. (i.) the caves themselves, (ii.) the cave-deposits; IV. conclusion. He exhibited a table showing the tentative classification he proposed. II. (i.) The Arenig Drift, he said, might be called the *Western Drift*, as all the material of which it was composed came from the mountains of Wales; or the *Great Ice-Drift*, as it was the only drift in the vale which contained evidence of direct ice-action. He traced its course from the Arenig and Snowdon ranges by striae on the solid rock and by the included fragments, a large proportion of which were glaciated. There are no shells in this drift. II. (ii.) The St. Asaph Drift might, he said, be called the *Northern Drift*, as it was the deposit in which fragments of north-country rocks first appeared; or the *Marine Drift*, as it was, excepting the recent deposits at the mouth of the estuary, the only drift in the vale which showed by its character and contents that it was a sea-deposit. It contained north-country granites, flints, and sea-shells, of which he gave lists. Most of them are common on the adjoining coast at the present day; a few are more northern forms. None of the rocks are striated, except those derived from the Arenig Drift (i.). II. (iii.) The Surface-Drifts included the older and newer alluvia of the rivers, the Morfa Rhuddlau Beds or estuarine silt, the recent shore-deposits or Rhyll Beds, and all the various kinds of deposits known as talus, trail, rain-wash, head, run-of-the-hill, &c., of which, in so long a time, very thick masses have accumulated in many places. He explained some methods of distinguishing gravels according to their origin. Turning to the subject of caves, he thought they should be careful not to confound (III. i.) the question of the age and origin of the caves themselves with (III. ii.) that of the deposits in the caves. He then described some of the more important caves of the district, explaining the evidence upon which he founded the opinion that the deposits in Pontnewydd Cave were post-glacial palaeolithic. He arrived at the same conclusion with regard to the deposits in the Ffynnon Beuno Caves. Combating the objections to this view which had recently been urged, he pointed out that the drifts associated with the deposits in those caves cannot have been formed before the submergence described under II. (ii.), because they contained north-country fragments and flints, and that, even if they were of the age of the submergence, they would not be pre-glacial; that they cannot have been formed during the submergence, as the sea would have washed away the bones, &c., from the mouth of the cave, and its contents must have shown some evidence of having been sorted by the sea. He considered that the greater part of the material that

blocked the upper entrance of the upper cave belonged to the surface-drifts described under II. (iii.), and were, as they stood, almost all sub-aërial. He further pointed out that, so far as palaeontologists had been able to lay before them any chronological divisions founded on the Mammalia, the fauna of the Ffynnon Beuno Caves agreed with the later rather than with the earlier Pleistocene groups.

Middlesex County Natural History Society, November 16.—Dr. Archibald Geikie, F.R.S., in the chair.—A paper was read by Mr. Sydney T. Klein, entitled "Thirty-six Hours' Hunting amongst the Lepidoptera and Hymenoptera of Middlesex, with Notes on the Methods adopted for their Capture." The especial object of the paper was to show how much good work could be done in a short time and within a small space—the time being made up by an hour or so each evening, and the space being the author's garden at Willesden. Detailed observations on the methods of enticement and capture—such as the rearing of special food-plants, sugaring, bright lights, &c.—were entered into, and a list of the Noctuae captured was read. Mr. Klein stated that he had taken over 170 species in the short time at his disposal, and had noticed, on an average, 500 or more moths on each occasion. With regard to the Hymenoptera, both mason and leaf-cutter bees had established themselves in his garden, and some interesting observations on their habits and economy were given. A large collection, containing specimens of every insect taken, was exhibited, together with the ichneumons peculiar to several of the species; a torpid mason-bee, which was restored to activity by breathing; and cells of the queen of the Ligurian honey-bee. A discussion followed, in which the Chairman joined; and, with a few remarks by the other members who had brought exhibits, a vote of thanks to Dr. Geikie brought the meeting to a close. Another paper, "On the Flora met with on the occasion of the Highgate Excursion," by Dr. Henry Wharton, was postponed till the December meeting.

CAMBRIDGE

Philosophical Society, Oct. 25.—Annual General Meeting.—Prof. Foster in the chair.—The following were elected Officers and new Members of Council for the year:—President: Mr. Trotter; Vice-Presidents: Prof. Babington, Prof. Adams, Prof. Foster; Secretaries: Mr. Glazebrook, Mr. Vines, Mr. Larmor; new Members of Council: Prof. Liveing, Mr. Forsyth, Mr. Marr, Mr. Pattison Muir.—Mr. Trotter then took the chair, and the following communications were made to the Society:—On Lagrange's equations of motion, by Mr. J. C. McConnel. The paper contains a proof of Lagrange's equations founded on that in Lord Rayleigh's "Theory of Sound," with some remarks on the proof given in Maxwell's "Electricity and Magnetism."—On the potentials of surfaces formed by the revolution of limaçons and cardioids about their axes, by Mr. A. B. Basset. The potential of a spheroid can be expressed in terms of a series of spheroidal harmonics. From this by inversion with respect to a focus the potential of limaçon is found, while that of a cardioid is obtained from a paraboloid either in a similar manner or by treating it as the limiting case of the spheroid.—An attempt to explain certain geological phenomena by the application to a liquid substratum of Henry's law of the absorption of gases by liquids, by Rev. O. Fisher. The author supposes that a liquid substratum exists beneath the earth's crust, and that this consists of fused rock holding gas, chiefly water above its critical temperature, in solution. This water is supposed to be that which is given off so largely in volcanic eruptions. If such be the constitution of the substratum, the reactions between it and the crust will largely depend on it, and also the tidal effects. The problem is worked out in the paper, and numerical results, which accord fairly with observed facts, are obtained.—A new method of determining specific inductive capacity, by Mr. L. R. Wilberforce. The author briefly described the method, which consisted in the comparison of the directive couples upon two spheroids, the one made of the dielectric to be investigated, and the other of some conducting material, when they were placed in a uniform electric field. He further indicated certain theoretical considerations with regard to the eccentricities of the spheroids and their manner of suspension, and stated a general theorem relating to the mechanical effect due to such a field upon a body of any material or form.

PARIS

Academy of Sciences, December 6.—M. Daubrée in the chair.—Reply to M. de Lapparent's note of November 22, on the

conditions determining the form and density of the earth's crust, by M. Faye. The conclusions of modern physicists regarding the uniform flattening of both terrestrial poles are vindicated against M. de Lapparent's captious objections. The general charge that the work of geodesy is far from completed is admitted; but it is pointed out that, in order to continue this work, it is not necessary to sweep away the secure results already obtained; it will be safe to prosecute it on the safe lines already laid down by Sabine, Freycinet, Foster, Clarke, Lütke, and other eminent men of science.—Action of manganese on the phosphorescent property of carbonate of lime, by M. Edmond Becquerel. The experiments here described place in a clear light the action of manganese, explaining how the carbonate of lime derived from the solution of Iceland-spar in pure hydrochloric acid always leads to preparations of orange phosphorescent sulphurets, while the phosphorescent matter is always bright green when the carbonate of lime used in the preparation is aragonite.—On the nitric substances of vegetable soil, by MM. Berthelot and André. A first series of experiments is here described, which have been carried out in the presence of diluted hydrochloric acid for the purpose of determining the chemical constitution of the nitric substances found in all vegetable soils in association with carbon, hydrogen, and oxygen, and almost absolutely insoluble.—On the composition of cider, by M. G. Lecharrier. A quantitative analysis is given of the various ciders at present consumed in Paris, and coming chiefly from Normandy and Brittany. The results show an average proportion of alcohol lying between 5.1 and 9.40 per cent.—On the red fluorescence of alumina, by M. Lecoq de Boisbaudran. These experiments show that the presence of chromium appears to be indispensable for the production of the red fluorescence of alumina. There seems to be a complete analogy between the parts played by chromium and all other active substances, such as Mn, Bi, Zn, Zr, or Sm.—Report made, in the name of the Section of Physics, in reply to a letter of the Minister of Public Instruction, Fine Arts, and Worship on sundry questions connected with the establishment of lightning-conductors on the buildings of the Lyceums (Commissioners: MM. Becquerel, Berthelot, Cornu, Mascart, Lippmann, and Fizeau). The report considers it indispensable for complete safety to have all iron roofs, doors, sashes, pipes, &c., carefully connected with the general apparatus usually attached to these buildings as protections against electric discharges.—On the fundamental principles of the higher geometry, by M. A. Mouchot. To generalise the figures of geometry by assigning them well-defined imaginary points, and then to prove that the algebraic symbols express all the relations of magnitude or position between the elements of these figures, is the double problem which has engaged the attention of the author for the last thirty years, and a rational and complete solution of which is now submitted to the Academy.—On certain problems in which are considered, on a plane curve, arcs of the same origin traversed in the same time as the corresponding chords, by M. G. Fouret.—On a new testing exploder ("exploseur-verifyeur") of quantity and tension, by MM. Louis de Place and Basse-Crosse. This apparatus consists of a moist pile of the Place-Germain system, an induction bobbin, and a telephone. It is described as very handy, portable, and durable, advantageously replacing the exploders of quantity and the exploders of tension. It also verifies the circuits at any given moment without danger of premature explosion.—Calorimetric researches on the specific heats and changes of state at high temperatures, by M. Pionchon. In this first communication the author gives, in tabulated form, the results of his calorimetric studies for silver, tin, iron, nickel, and cobalt. His experiments fully confirm the opinion already announced by M. Berthelot on the so-called law of Dulong and Petit.—On the tensions of vapour of solutions made in ether, by M. Em. Raoult. The tensions of vapour for the solutions here determined by Dalton's method show that the molecular diminutions of tension are always comprised between 0.67 and 0.74, with a general average of 0.71, whatever be the composition, chemical function, and molecular weight of the substances held in solution.—Researches on the bi-metallic phosphates and allied salts, and on their transformations, by M. A. Joly.—Saturation of normal arsenic acid by magnesia, and formation of ammoniaco-magnesian arseniate, by M. Ch. Blarez. These researches on the formation of the arseniates of magnesia and of ammoniaco-magnesian arseniate have been undertaken for the purpose of completing the author's studies on the saturation of normal arsenic acid.—On the phenomena attending the heating and

cooling of cast steel, by M. Osmond. In continuation his studies of these phenomena between the normal temperature and 800° C. the author here gives the results of his researches brought up to 1200° C.—On the influence of silicium on the state of the carbon in pig-iron, by M. Ferdinand Gautie. The experiments already carried out by Messrs. Stead and Wood of Middlesbrough, are here repeated under somewhat altered conditions and with analogous results.—On the water of combination of the alums, by M. E. J. Maumené.—Heat of neutralisation of the meconic and mellic acids, by MM. H. Gal and I. Werner.—A contribution to the study of the fossil fruits of the Eocene flora in the west of France, by M. Louis Crié.—On the diseases of the olive, especially tuberculosis, by M. L. Savastan.—On the phenomenon of the green ray, by M. de Maubeuge. The author's repeated observations of this well-known phenomenon, both at sunset and sunrise under varying atmospheric conditions, lead him to conclude that it is really objective, and not merely a subjective sensation.—The Indo-European Cana and the navigation of the Euphrates and Tigris, by M. Emil Eude. It is suggested that with a capital of about 60,000,000 a canal available both for navigation and irrigation might be constructed from the Mediterranean to the Persian Gulf, shortening the route to India by six days.

BOOKS AND PAMPHLETS RECEIVED

The History of Howietoun, and also of the Fish-Cultural Work: See J. R. G. Maitland (Guy, Stirling).—Mittellungen des Vereins für Erdkunde zu Halle, 1886 (Halle).—Traité de Zoologie Agricole: P. Brocchi (Baillière et Fils, Paris).—Pearls and Pearling Life: E. Streeter (G. Bell and Sons).—The Owens College: J. Thompson (Cornish, Manchester).—Journal of the Royal Society of New South Wales, vol. xix. (Sydney).—The Pre-History of the North: J. J. A. Worsaae, translated by A. F. M. Simpson (Trübner).—The Age of Electricity: P. Benjamin (Cassells).—Journal of the Royal Microscopical Society, December (Williams and Norgate).—Hydraulic Power and Hydraulic Machinery: H. Robinson (Griffin).—Educative Exhibits, part 1 (Washington).—Elementary Course of Practical Zoology: B. P. Colton (Heath, Boston).—Old and New Chemistry: S. E. Phillips (Wertheimer, Lea, and Co.).—Calendar of the University College of Wales Aberystwith, 1886-87 (Cornish, Manchester).—A Treatise on Chemistry, vol. iii, part 3: Sir H. Roscoe and Prof. C. Schorlemmer (Macmillan).—A Text-Book of Pathological Anatomy and Pathogenesis, part 2, sections ix, xii: Prof. E. Ziegler, translated by Dr. D. Macalister (Macmillan).

CONTENTS

PAG

The Palissy of Calico-Printing. By Prof. T. E. Thorpe, F.R.S.	
The British International Polar Expedition	
Our Book Shelf:—	
Nicholson's "Natural History, its Rise and Progress in Britain"	
"The Journal of the Royal Agricultural Society of England."—Prof. John Wrightson	
Oliver's "Madagascar"	
Letters to the Editor:—	
An Ice Period in the Altai Mountains.—E. Michaelis	
How to make Colourless Specimens of Plants to be preserved in Alcohol.—Prof. Hugo de Vries	
Virtual Velocities.—F. Guthrie	
Recent Gales.—E. J. Lowe	
Note on the Manipulation of Glass containing Lead. H. G. Madan	
Fireball of December 4, 1886.—W. F. Denning	
The Dispersion of Plants by Birds. By D. Morris	
Sounding a Crater. By Prof. John Milne	
The Mathematical Tripos, II. By J. W. L. Glaisher, F.R.S.	
Earthquake at Sea. By Reginald H. Hertalet	
Notes	
Our Astronomical Column:—	
Publications of the Washburn Observatory, vol. iv.	
The Second Armagh Catalogue of 3300 Stars	
Astronomical Phenomena for the Week 1886 December 19-25	
Sanitary Progress during the Reign of the Queen. By Capt. Douglas Galton, C.B., F.R.S.	
On the Forms of Clouds. By A. F. Oser, F.R.S.	
Further Experiments on Flame. By Dr. George J. Burch. (Illustrated)	
Societies and Academies	
Books and Pamphlets Received	

THURSDAY, DECEMBER 23, 1886

CANAL AND RIVER ENGINEERING

The Principles and Practice of Canal and River Engineering. By David Stevenson. Revised by his Sons, D. A. and C. A. Stevenson. Third Edition. Pp. xiv. + 406, and 18 Plates. (Edinburgh: A. and C. Black, 1886.)

THE fact of this work having reached a third edition shows its appreciation by the public. The title, however, indicates a wider scope than that actually embraced. Thus only 65 pages are given to canals, and these only for navigation; no mention is made of the very large subject of irrigation-canals (surely a passing notice of the reason of this omission was required). In his short compass (30 pages given to barge canals, 35 pages to ship canals), part of which is an historical sketch, it is of course impossible to give much constructive detail. Thus no details or sketches are given of most of the appliances needed for canals, *e.g.* locks, turbines, lifts, waste-weirs, &c. The two chapters on canals are otherwise unsatisfactory; *e.g.* 14 pages devoted to the Suez Canal consist chiefly of extracts from Reports made in 1863 and 1870: much of this now purely historical matter might have been with advantage replaced by later information.

The remainder of the work (331 pp.) is devoted to river improvement. And this part of the work is of great value and interest, especially where accounts are given of some of the numerous successful instances of improvements of estuaries effected by the author and the revisers themselves. The great help of a large rise and fall of tide to a commercial port situate in the tidal portion of a river, *viz.* in aiding vessels coming to and leaving the port, is first explained; the pre-eminent importance of this tidal action to England is evident. As might be expected, then, the greater part of the work is devoted to the improvement of the tidal portion of rivers such as those of the British Isles.

Two useful chapters (92 pp.) are given to the observations required for a project for such work, *e.g.* tidal phenomena, soundings, current-velocities, discharges, salinity, &c. In quoting Cunningham's instrument (twin balls, sunk one to 211 and one to 789 of the depth) for measuring mean velocity past a vertical *at one operation*, it should be stated that the two balls should be *alike in all respects*. Fourteen pages are given to the subject of "under-currents"; one instance is quoted (p. 135) of a velocity of 4 miles per hour at 50 feet depth measured with a "double-float," when the surface-velocity was only 1.8 miles per hour. This is one of the best instances (known to the reviewer) of the excellence of the "double-float" (when well designed) for sub-surface velocity-measurement; several other good instances are quoted. These should surely convince those who condemn the "double-float" as useless for such work. The natural defects of most (tidal) rivers in their tidal reaches are detailed as the presence of a "bar" at the mouth, of hard veins of gravel, rock, &c., obstructing the water-way, of extensive mud or sand flats through which the deep channel is ever shifting, &c.

VOL. XXXV.—NO. 895

The explanation of the cause of a "bar" at a river mouth now generally accepted, *viz.* as being really a submerged part of the "beach" of the outer shore-line, produced from the sea by the action of the waves (not from the alluvium brought down by the river), appears to have been first proposed by the author of this work in 1842. This suggests the treatment usually found successful in tidal rivers, *viz.* prolonging the fairway of the river, by piers, seawards into the deep water beyond the reach of the waves which produce the beach. And it is seen that this will fail in effecting a permanent cure in deltaic rivers, in which the gradual advance of the delta will reproduce shoal-water outside the ever-advancing mouths, in which the waves will therefore reproduce a bar.

The ideal improvement to be aimed at in the tidal part of a river is explained to consist chiefly in introducing increased tidal scour by removing obstruction to it (such as bars, &c.), and by confining its action under half-tide to a definite channel. These changes accelerate the propagation of the tidal wave, and decrease the tidal current, thereby giving (sometimes greatly) increased depth of water, not only over the bar at the mouth, but throughout the tidal reaches, and also prolong the duration of the tidal effect. The benefit of these results to navigation is obviously very great.

It is shown that jetties, groynes, &c., projected from the banks of a stream for confining the fairway to a defined channel are very uncertain in their effects. The course recommended in general is the use of low parallel training walls for confining the course of the river under half-tide to a single definite channel, low enough to be covered at half tide. Several interesting instances are given of the failure of the jetties, &c., and success of the low parallel wall system. After this treatment silting will generally occur in places behind the training walls, increasing gradually till marsh-land is produced; after which it is often possible to reclaim some of the raised land: but it is stated that it seldom pays to do this in British rivers until the silting has raised the land to the level of ordinary spring-tides. A most useful practical rule is proposed, that reclamation work should only be undertaken as part of a large general scheme of improvement of a navigation, and never be permitted to the desultory self-interested efforts of private riparian proprietors.

A short chapter (9 pp.) is given to the effect of bridge on navigable rivers. In highly civilised countries this is now a question of rapidly increasing importance. It is shown that the interests of the bridge constructors, especially in the case of railways, are generally adverse to those of the navigation. Of course the subject cannot be much developed within 9 pages. But a short description (with plate) of the railway swing-bridge over the Ouse has been included.

An excellent account is given (31 pp.) of the various processes of dredging and excavating, with a description of some of the most recent machines, and an analysis of the cost of the work.

It will be seen that on the whole this treatise is an excellent account of the principles and practice of river engineering, to the successful practice of which its able authors have so largely contributed.

ALLAN CUNNINGHAM, Major R.E.

ALPINE WINTER

Alpine Winter in its Medical Aspects: with Notes on Davos Platz, Wiesen, St. Moritz, and the Maloia. By A. Tucker Wise, M.D., &c. Third Edition. (London: Churchill, 1886.)

THIS work possesses a fourfold interest. The meteorologist will find in it an account of the Swiss Alpine climate in winter, with full and careful records of the author's observations, which occupy one-fourth of the whole volume. The sanitary engineer may here obtain a clear account of the first successful attempt that has been made to warm and ventilate a large building on strictly scientific principles during the months when the temperature of the air frequently falls below zero. To the physician the book will serve as a guide in advising his patients on the subject of the Alpine health-resorts, in the determination of suitable cases, the peculiar advantages of each place, the duration of stay, and the time to leave—giving, as it does, the physiological effect of each of the peculiar elements of a winter climate at high elevations. Lastly, all those who, either from necessity or from choice, have arranged to pass part of the winter in the Engadine or at Davos, can learn from these pages how to plan and prepare for their outfit and journey, the best routes by which to travel, how to avail themselves of the advantages of the winter health-resorts of these parts, and how to minimise the drawbacks or dangers connected with this system of treatment.

The principal places which Dr. Tucker Wise describes are Davos-am-Platz, Wiesen (a warm bright hamlet six miles lower down the stream), St. Moritz (now almost as renowned for the winter effect of its atmosphere in consumption as of its waters in debility), and, lastly, the Maloia. As the author has now taken up his residence at the Maloia *Kursaal*, it is only natural that he should devote a considerable part of his book to it. It is this hotel which presents, as we have said, the earliest and one of the greatest efforts in the direction of artificial heating and ventilation in the Alps. Nature and art meet at the Maloia in the most interesting combinations. Without the *Kursaal* there is the brilliant, dry, calm, absolutely pure atmosphere of the Upper Engadine, "laden with balsamic vapour from the pines"; within its walls there is every appliance which science can suggest to preserve the purity and maintain the proper temperature of the respired air, constantly liable as it is to dangerous contamination by the residents, who to the number of several hundreds can be accommodated in its apartments. The elaborate system adopted for warming and circulating the admitted air is fully explained in this work with the aid of a series of large diagrams. The air, drawn from the outside on the basement, is made to pass over a series of *batteries*, consisting of steam-pipes inclosed in a case, by means of which it is raised to a temperature of 50° C., whilst it is at the same time mixed with a due proportion of watery vapour. The ascending power of the heated air raises it to the rooms above, which it enters at a rate sufficient to change the atmosphere every two or three hours. To extract the used-up air there are two tubes of exit, which finally communicate with an iron casing around the main flue of the furnaces, which thus acts as the extraction-shaft. Not only is

every room thus warmed and ventilated, but the atmosphere of any particular chamber can be medicated at will by placing an antiseptic agent in the air-tube supplying it. A plan has also been adopted in the *Kursaal* of introducing ozone into the building by means of the electricity used for lighting, the motor force for the machines being a fall on the River Inn. "The ozoniser draws off its electricity from the main current of the incandescent lights. After passing through an inductorium, an induced current of about 200,000 volts is obtained, and distributed over the surface of numerous glass plates coated with tin-foil. The method employed is an imitation of the natural process which takes place in the atmosphere,—the production of ozonised air by electricity in a state of high tension. Air is forced between the glass plates and through the ozoniser by means of a 'blower,' driven by a water motor."

To those for whom any of the subjects which we have selected for comment may possess practical interest we would say: "Do not be satisfied with reading Dr. Tucker Wise's book; go and see for yourselves on the spot." There is no more enjoyable or more successful holiday in our dark and dreary winter for the jaded dweller in large English towns than a few weeks spent in the sparkling air of St. Moritz or the Maloia. B.

OUR BOOK SHELF

Magnetic Horizontal Intensity in Northern Siberia. By A. C. von Tillo. From the *Repertorium für Meteorologie*, Band x., No. 7. (St. Petersburg, 1886.)

THE maps of lines of equal magnetic horizontal intensity which have been published during recent years have been more or less defective in that part of Siberia lying north of the 60th parallel of latitude, partly arising from want of fresh observations, but more directly from insufficiency of data respecting the secular change of that element.

The present paper, with its accompanying map, is intended to remedy these defects, as far as is at present possible, for the epoch 1880. For this purpose, every observation since 1828, when Hansteen and Due started on their well-known magnetic survey, has been collected in a Table A, and the best values obtainable of the secular change in a Table B. As represented in the latter table, the secular change is of so moderate an amount, that every observation during the interval 1828-84 may, without large error, be considered available for combination in one map for 1880.

This has been accordingly done, and a map drawn, showing lines of equal horizontal intensity expressed in Gaussian units, the scale being in conformity with that of the maps published in the *Annalen der Hydrographie*, Heft vii., July 1880.

Amongst the most important recent observations recorded in Table A are those of F. Müller in the *Olenek Expedition* of 1873, and of the voyage of the *Vega* in 1878-80, and as a whole the paper and map may be taken as a valuable contribution to terrestrial magnetism. The secular change, however, still remains a quantity requiring much more accurate results than those hitherto obtained for Siberia, and such as are derived from prolonged observation in one spot, it being now well known that a change of position of a few feet often allows an element of error to enter, caused by local magnetic disturbance.

The Ordnance Survey of the United Kingdom. By Lieut.-Colonel T. Pilkington White, R.E. (London and Edinburgh: Blackwood and Sons, 1886.)

THIS is a slight sketch, most of which has already appeared in *Blackwood*. Carefully as the author has kept himself

to what in an account of many businesses would be "dry detail," avoiding all anecdote, either biographical or operative, in illustration of work done, it is still a most interesting little book to all who have seen the Ordnance surveyors and their assistants about the town or country, or even their mark upon the stone, brick, or other permanent material. Few indeed will there be who will not find their own special taste ministered to either in the account of the measurement of a base-line with its verification by astronomical observation, by trigonometrical calculation, and by exact chain measurement of a known proportion of it, with the record of frequent triumphs of marvellous correctness; or, again, in the exactness required and gained in the standard measure, with the careful comparison of the English measure with the corresponding foreign standards by which to unite our observed measurements with those of other countries. Such histories give confidence in the trustworthiness of the maps when published, to the surveyor, and hence to both buyer and seller of land. Distant, we hope, is the time when they will be of value to military commanders for choosing ground and availing themselves of the various features of the country, so well laid down that a practised eye like that of Prof. J. Geikie can detect different geological formations by the shading of the hills! Still, this military value is an argument for the frequent revision of maps in which even trees are marked down that would form an important item in strategical movements. We must sympathise in the hope strongly expressed here that the present accomplished staff may be permanently kept together in periodical revision of these maps. Their value after a space of time to the scientific geologist wishing to compute rates of denudation or deposition is invaluable; while a much more potent argument to this generation probably is that much of the whole surface of Lancashire and Yorkshire has been changed by the hand of man during the forty years which have now elapsed since that district was surveyed, and perhaps the environs of London still more completely during the twelve to twenty-one years since the maps of them were published. Certainly no one who reads the numerous labours to which they have turned their hands, some of them seeming little connected with their regular work, can have any fear of idleness on the part of the staff of this department.

LETTERS TO THE EDITOR

- [The Editor does not hold himself responsible for opinions expressed by his correspondents. Neither can he undertake to return, or to correspond with the writers of, rejected manuscripts. No notice is taken of anonymous communications.]
- [The Editor urgently requests correspondents to keep their letters as short as possible. The pressure on his space is so great that it is impossible otherwise to insure the appearance even of communications containing interesting and novel facts.]

The Cambridge Cholera Fungus

IN No. 247, vol. xli. of the *Proceedings* of the Royal Society, just published, there is a preliminary report on the pathology of cholera asiatica, by Messrs. C. Roy, J. Graham Brown, and C. S. Sherrington, in which these gentlemen describe and figure the occurrence, in the tissue of the intestinal mucous membrane of persons dead of cholera asiatica, of hyphæ or mycelial threads and "granules." Messrs. Vines and Gardiner have, we are told, declared these to be Chitridiæ. We are further informed that the Chitridiæ were found by Messrs. Roy, Brown, and Sherrington in the intestinal mucous membrane of the twenty-five cases of cholera they have examined, as also in the kidney, and in the blood-vessels of some of these

cases. I have no hesitation in saying that I consider these statements are based on error. What these gentlemen have seen and described is nothing [less or more than the hyphæ or mycelial

threads of common mould (probably aspergillus), which, during preserving of the material, have grown from the free surface into the tissues. I possess a large number of specimens made of the diseased intestine, lung, kidney, liver, and skin of various animals and men, in no way connected with cholera asiatica; in many of them I find the exact appearances described and figured by these gentlemen, viz. mycelial threads of precisely the same size and appearance as those above mentioned. They are seen to penetrate from the surface, where they form a copious dense mycelium, into the depth to various degrees. I possess sections through the mucous membrane of the intestine of the calf, of the mouse, of the guinea-pig, and of man, in which these hyphæ have penetrated as deep as the submucous tissue; in the lymphatics of this part they were very abundant. Similarly, I have specimens of the lung of calf, cow, and guinea-pig, where the growth of the mycelial threads can be traced from the pleural surface into the lung-tissue; in the lymph-vessels of the intertubular septa they are very numerous, and possessed of those knob-shaped outgrowths figured and described by Messrs. Roy, Brown, and Sherrington. I have also specimens of the ulcerated skin of calf and cow, where these hyphæ can be traced as deep as the subcutaneous tissue. Into the kidney and the mesenteric lymph-glands they also penetrate, but less than in the above organs, probably owing to the greater density of the tissue.

Now, in all these instances, these tissues had been preserved during and over the summer months; they were examined after three or more months' preservation, and the sections were stained in methylene-blue. But I must state, also, that the same tissues had been examined fresh, and after a few weeks' hardening, and in none of them had any mycelial growth been present. It is a fact, as is pointed out by Roy, Brown, and Sherrington, that methylene-blue brings the threads out more easily and better than other aniline dyes.

There can be absolutely no doubt about the identity of the Cambridge "Chitridiæ" with the hyphæ of the common mould found in the sections of my non-choleraic specimens. What Messrs. Roy, Brown, and Sherrington describe as "granules," connected by delicate filaments, are, in most instances, filaments and branches seen in optical or real transverse section; with careful fine adjustment of the microscope this can be without difficulty ascertained.

Messrs. Roy, Brown, and Sherrington assume that their Chitridiæ have been overlooked by others who have examined cholera intestines, because methylene-blue had not been used. This assumption is entirely wrong, because methylene-blue, as Löffler's (or alkaline) solution and in other modifications, had been used by many investigators. While in India, I largely used it for the staining of sections, fresh, and after a few days' to a few weeks' hardening, and I know, as a positive fact, that the German Commission have, in Egypt, in India, and after their return to Berlin, largely used this dye. But in not one single case have they or have I found anything of mycelial threads either in the intestinal mucous membrane or in any other organ. The only difference between Messrs. Roy, Brown, and Sherrington on the one hand, and all other investigators on the other, is this, that while the former kept their material bottled for some months (*vide* their report, p. 177), the latter examined theirs fresh or after short and careful hardening. That this is the real explanation of the difference of our results is proved by the following:—A bottle containing bits of choleraic intestine preserved by me in Calcutta, and brought over to England, was opened many months after; sections were made of the intestine, and stained in methylene-blue. On the free surface of the mucous membrane was found a dense plexus of mycelial threads of common mould, from which threads of various thickness had singly grown into the tissue to the depth of the submucous tissue.

Of the same choleraic intestine numerous sections had been made in Calcutta, fresh, and after a few weeks' hardening; these had been stained in methylene-blue, but in none of them is there any trace of mycelial threads. I have these sections at present in my possession; and, while they show that there is a complete absence in the mucous membrane of mycelial threads, the others, viz. those made of the same intestine, and after the same method, but after having been kept bottled for some months, show beautiful mycelial threads pervading the mucous membrane through all depths.

These threads, in their course, thickness, mode of branching, in the character of the bud-like sprouts, in short in all their

morphological characters, are unmistakably identical with the hyphæ found in specimens of the non-choleraic intestine, lung, skin, kidney, mesenteric glands, preserved, as stated above, over the summer.

In conclusion I wish to say that I shall be most happy to place at the disposal of Messrs. Roy, Brown, and Sherrington, as also of Messrs. Vines and Gardiner, the materials or sections, mounted and stained, of the various non-choleraic tissues in which are present the mycelial threads of common mould identical with the Cambridge cholera fungus. E. KLEIN

94, Philbeach Gardens, Earl's Court, December 18

The Longitude of Rio

MAY I ask for a few lines in which to correct an erroneous impression naturally made by a sentence in my recent paper on "Ten Years' Progress in Astronomy," which you have honoured me by reprinting in NATURE. The sentence relates to the longitude of Rio; and although it does not really assert that the error in this longitude was first detected and corrected by our American naval officers, yet I must frankly admit that the connection and form of expression are such that this would be the natural, though incorrect, inference. The fact is that Admiral Mouchez and his coadjutors in the French Navy had already, by their chronometric and other work, brought the uncertainty to very narrow limits (say ± 2s.) before the telegraphic campaign of the Americans. The history of the case is peculiar, but too long to be given here: it affords an excellent example of the uncertainty of longitudes based on lunar observations.

The misleading form of the sentence is due to a little carelessness on my part in cutting down the much more extended statement I had made in the first draft of the paper. The available limits of time and space compelled me to compress my material to the utmost.

I cheerfully make this correction in justice to Admiral Mouchez, who has called my attention to the matter.

Princeton, N.J., December 9

C. A. YOUNG

An Error in Maxwell's "Electricity and Magnetism"

MANY of your readers will be aware that Maxwell (ii. § 544) deduces the equations of induction of currents from the laws of electro-dynamics with the aid of the principle of energy, using a proof taken from Helmholtz. I find that this proof is erroneous; and, as a point of considerable physical interest is involved, I wish to call attention to the error in your columns.

We suppose two circuits carrying currents to be moving relatively to each other. Let R_1, R_2 be the resistances, I_1, I_2 the currents, A_1, A_2 the electromotive forces of the batteries, and

$\frac{dV}{dt} - I_1 I_2$ — the rate at which work is done by the external forces which are moving the circuits. Then $A_1 I_1 + A_2 I_2$ is the rate at which the batteries are doing work, and $R_1 I_1^2 + R_2 I_2^2$ is the rate at which energy is being changed into heat in the wires. So Maxwell says we have—

$$A_1 I_1 + A_2 I_2 - I_1 I_2 = R_1 I_1^2 + R_2 I_2^2 \quad (1)$$

and it is this equation that is wrong. He has omitted to take into account the change in the electro-kinetic energy which is taking place. If, for instance, the two batteries were suddenly thrown out of the circuits, the quantity of heat that would afterwards appear, either in the wires or in the form of sparks, would depend on the relative position of the circuits. And the energy that would then appear as heat previously exists in the form of electro-kinetic energy.

Let M be the coefficient of mutual induction. Then, if we neglect the rate of change of the currents, the rate of increase

of the electro-kinetic energy is $I_1 I_2 \frac{dM}{dt}$. So, instead of (1), we should write—

$$A_1 I_1 + A_2 I_2 - I_1 I_2 = R_1 I_1^2 + R_2 I_2^2 + I_1 I_2 \frac{dM}{dt} \quad (2)$$

If we assume the accepted equations of induction of currents, viz.—

$$A_1 = R_1 I_1 + I_2 \frac{dM}{dt} \quad (3)$$

$$A_2 = R_2 I_2 + I_1 \frac{dM}{dt}$$

neglecting, as before, the rate of change of the currents, see that $\frac{dM}{dt} = \frac{dV}{dt}$.

And therefore the decrease of electro-kinetic energy is equal to the work done by outside mechanical forces on the system. This result was long ago obtained by Sir William Thomson, is indeed noticed by Maxwell in this very article.

Notwithstanding the use of the incorrect equation (1), Maxwell obtains a correct result. In fact, he falls into a second error which exactly compensates for the first. He supposes $\frac{dM}{dt}$ to be very small compared with I_1 , and says that we may take with sufficient accuracy put $A_1 = R_1 I_1$ in (1). But by (3) — see that the term thus neglected is $I_1 I_2 \frac{dM}{dt}$, which is not negligible.

As I have not had access to Helmholtz' original memoir, I cannot say whether Maxwell has correctly transcribed his proof.

JAMES C. MCCONNELL

St. Moritz, Engadine, Switzerland

Seismometry

IN reply to my letter answering Prof. Milne's assertion (NATURE, Nov. 25, p. 75), Mr. T. Gray (his associate in seismometric work) says nothing in support of these, but attacks me on two distinct and quite irrelevant issues. The tone of Mr. Gray's letter (Dec. 9, p. 126) is unusual: as to that no answer is necessary; but the two questions of fact raised by him require reply.

(1) Mr. Gray writes:—"He [Prof. Ewing] says, or leads on to infer, that he introduced horizontal pendulums in seismology. On the contrary, what I have said (in my memoir on "Earthquake Measurement," Tokio, 1883, p. 21) is this:—

"It appears that the earliest attempt to apply the horizontal pendulum to the measurement of earthquake-motions was made by Prof. W. S. Chaplin, of the University of Tokio, about 1871. His apparatus consisted of a wooden rod, free to turn about vertical axis, and carrying at its end a rigidly attached block. It was intended that the motion of the earth should be recorded on a tracing-point fixed to the block, writing on a smooth surface fixed to the earth below it. There was no multiplication of the motion, and either for this reason, or because friction was not sufficiently avoided at the joints and pointer, no results were ever obtained, and the apparatus was abandoned."

The passage Mr. Gray alludes to as having been "read in my presence" was a casual reference by Prof. Milne to unsuccessful experiments. Prof. Chaplin, their author, has himself written to me:—

"I certainly think you were the first to use successfully a seismograph depending on the principle of the horizontal pendulum. I believe the records obtained by you with this apparatus were the first obtained in Japan (and probably in the world) which showed the motion of the earth during an earthquake from beginning to end of the shock. I cannot mark the effect which the first record produced than by my own experience. I was, up to that time, working on an instrument for determining the velocity and direction of earthquake; and my design was founded on the idea that earthquake began with a sudden and violent shock. Your record showed (I believe for the first time) that an earthquake often began with an almost imperceptible motion, which increased in amplitude and might have many maxima; hence my machine would have been useless had I completed it."

What I do claim in this matter is that I succeeded in constructing the earliest successful seismograph capable of making absolute measurements of the horizontal motion throughout an earthquake, in conjunction with the time, and giving records from which the amount, direction, velocity, and acceleration of the successive movements could be, and were, for the first time determined. The earliest records, referred to by Prof. Chaplin, were obtained in November 1880, and are described in the Transactions of the Asiatic Society of

Japan for that year (vol. ix. p. 40). Further, in publishing an account of the horizontal pendulum seismograph, I pointed out that the way to get a steady-point with respect to one component of earthquake-motion, is to pivot a body in nearly neutral equilibrium, with the corresponding kind of freedom, and to use the centre of percussion as the steady-point, the steadiness of the steady-point being increased, if need be, by pivoting a second mass there. So far as I am aware, this obvious principle was first explicitly recognised and applied in my horizontal pendulum seismograph; and on this point I shall appeal from Mr. Gray of 1886 to Mr. Gray of 1881:—

"I believe the first time special attention was paid to the application of this well-known dynamical principle to seismometers is to be found in a paper communicated by Prof. Ewing to the last meeting of this Society" (T. Gray, *Trans. Seis. Soc. Jap.*, vol. iii. p. 5).

(2) Mr. Gray's second charge is that I am using his vertical motion seismometer without acknowledgment. I am not using his instrument; and I have acknowledged fully his service to seismometry in this connection. A horizontal bar, loaded at one end and held up by a spring, was used for vertical motion by the British Association Committee at Comrie in 1842. In 1881, Mr. Gray, holding the bar up by a long spiral spring, made the suspension astatic by adding a trough or tube containing mercury (*Trans. Seis. Soc. Jap.*, vol. iii. p. 137). After seeing this, I devised another and simpler method of making the suspension astatic, and in describing it I said:—

"At a recent meeting of the Society, Mr. T. Gray described a seismometer for vertical motion, in which the problem of supporting a heavy mass, so that it should be free to move vertically and yet remain in neutral equilibrium, was for the first time (so far as I am aware) successfully solved" (*Ibid.* p. 140).

My method is entirely different from Mr. Gray's. He now says that it was anticipated by a paper of his, dated May 1880. He did not suggest this at the time; and, on reading the paper now, I can find no trace of the alleged anticipation. In the passage quoted above, and in other writings ("Earthquake Measurement," p. 48; *NATURE*, vol. xxx. p. 152; "Encyclopædia Britannica," Art. "Seismometer"), I have tried to do justice to Mr. Gray's priority in the solution of this problem of vertical astatic suspension; but I prefer, and use, my own later solution.

J. A. EWING

University College, Dundee, December 11

How to make Colourless Specimens of Plants to be preserved in Alcohol

In your last number (p. 149) Prof. H. de Vries described a valuable method for making botanical museum specimens colourless; but, as it is more important in many cases to keep the original colour, you will allow me to call your attention to a note in the *Berichte der deutschen botanischen Gesellschaft* (1886, No. 8), where Dr. Tschirch describes a method for retaining the colour (green or other) on specimens preserved in spirit. He discovered some time ago that tannates and colouring-matters (as found in plants), with the exception of xanthophyll, form compounds with lead and barium which are insoluble in alcohol, and he based his method on this discovery. He recommends the specimens to be put into solutions of compounds of lead or barium before transferring them to spirit, or simply to add concentrated solutions of acetate or nitrate of lead, or chloride or hydrated oxide of barium, to the spirit. I may add that I have tried this method, but I have not yet got quite satisfactory results. My best results were obtained by plunging the specimens first of all into boiling water before putting them into the above-mentioned mineral solutions.

SELMAR SCHÖNLAND

Botanic Garden, Oxford, December 18

The Recent Weather

MY barometer, at 250 feet above sea-level, fell to 28·20 at 3 a.m. on December 8, and to 27·82 at 8 p.m.

Birstal Hill, Leicester, December 18 F. T. MOTT

I GATHER from your notice of the great storm on the 8th that readings of the barometer taken during its passage across the country will be of some interest. I therefore place at your dis-

posal copies of the records made at Belvoir Castle. An indication of an approaching storm was given by a falling barometer on the 6th, its reading at 9 a.m. on that day being 29·380. The depression increased on the 7th, reaching 28·960; at 9 a.m. on the 8th it had fallen to 28·200, and then went down rapidly, until at 9 p.m. it reached its lowest point, 27·800, the lowest I have registered at this place during a period of thirty-two years. During the 8th the wind was strong from the south, amounting to a gale, and was accompanied with rain, 0·60 being recorded, but it was less violent than the indications of the barometer led me to expect. That the pressure was less intense here than in the storm on October 14, 1881, was evidenced by the escape of timber-trees; some 400 to 500 were blown down in 1881, and not half a dozen in the woods adjacent to the Castle on the 8th. Belvoir Castle is in the northern division of Lincolnshire, about twenty miles east of Nottingham. The height of our station, but not of the Castle, is 237 feet, lat. 52° 53' 39" N., long. 0° 3' 7" W.

WILLIAM INGRAM

Belvoir

Electrical Phenomenon

I BEG to inclose extract from a letter just received from a young friend at Yloilo, and shall be glad if you will insert it in your next issue. Some of your readers may have further information respecting this interesting sight. THOMAS HIGGIN

Ethersall, Roby, Liverpool, December 15

"Yloilo, October 1, 1886

"Last night a most extraordinary phenomenon was visible in the heavens. About 9 o'clock the sky was perfectly clear, all the stars visible, but no moon, when suddenly the whole heavens were lit up as if by electric light, a very large globe of fire became visible (about the size the moon appears when full) and floated slowly northwards. I was in rather a bad position for seeing where it actually went, a house being between me and the horizon. This ball was followed by smaller ones, which were close to the big one, and gradually got smaller, till they appeared like falling stars, only they went much more slowly."

Electricity and Clocks

WOULD any of your readers aid me in carrying out this idea: To make the works of a small striking clock strike the hours on a large bell by an electrical connection. T. WILSON

Rivers Lodge, Harpenden, St. Albans

BOTANY OF THE AFGHAN DELIMITATION COMMISSION

WHEN, in 1884, it became known that the Government intended sending a Commission to settle the boundary of North-Western Afghanistan, representations were made to the Marquis of Ripon, then Viceroy of India, that it was desirable in the interests of science and commerce that a naturalist should be attached to the staff, and Brigade-Surgeon Aitchison was accordingly appointed in that capacity. Certainly no better choice could have been made, at least as far as botany was concerned, because no other person had the practical knowledge of the vegetation of the region possessed by Dr. Aitchison, who, moreover, is unsurpassed as a collector. As long ago as 1859 he began collecting plants in the Punjab, the flora of which he fully investigated; and later he collected in Scinde and some parts of Kashmir; but this was all done during his leisure hours. In the winter of 1878 he accompanied the troops under the command of General Sir F. Roberts in the advance on Kuram, and subsequently he was attached to the force as botanist, and commenced operations in April 1879. Botanists of all countries know full well what excellent and extensive collections he made during that and the following year, for, with assistance from the Government of India, the results were promptly published by the Linnean Society. Large and interesting as those collections were, the present equals them in extent and exceeds them in importance, inasmuch as Dr. Aitchison paid special attention to the investigation of the many

vegetable products of the Perso-Afghan region which are articles of commerce with India and other countries. Much uncertainty existed respecting the plants yielding some of these drugs, dyes, and other substances, and no more welcome contribution to botanical knowledge could be made than the removal of this uncertainty.

The Commission left Quetta in September 1884, taking a south-westerly direction as far as Nushki, and thence the course was north-westward across Northern Baluchistan to the Helmund River, which was touched in about 63° E. long. This section of the journey produced little, as the country is very barren and the season in which it was traversed the worst of the year for botanising. Nevertheless a few interesting things were picked up, notably ripe fruit and seeds of *Stocksia brahuica*, which were previously unknown. The fruit, or seed-vessel, is an inflated capsule, similar to that of the Chinese *Koeleruteria*, near which *Stocksia* is placed, and so brightly coloured that it bears a name equivalent to "mountain peach."

That part of the journey from the Helmund northward to Kuhsan, a little to the north-west of Herat, was accomplished at the rate of twenty miles a day, therefore there was little opportunity for collecting. Indeed the fatigue attending the travelling was so great that frequent dismounting to secure specimens of natural history was out of the question. In spite, however, of all drawbacks and difficulties, specimens of about one hundred species of plants were dried; and this collection was despatched to India, by way of Herat and Candahar, where it arrived in a rotten condition, having apparently been immersed, probably in crossing some stream, during the transit. The small collection made in Baluchistan had in the meantime reached Kew safely.

The main collection of dried plants, consisting of about 800 species in 10,000 specimens, was made in an irregular tract of country lying between about 59° and 64° of longitude and 34° and 37° of latitude, with Herat near the south-eastern, and Meshed near the north-western limits. This collection was the result of one year's work; yet it by no means represents the entire flora of the area in question, partly in consequence of the difficulties attending the daily transport of collections constantly increasing in weight and size, and partly on account of the necessity for keeping with the main party. These contingencies, rather than the resources of the country, determined the extent of the collection. Thus, for instance, Dr. Aitchison rarely reached an altitude of more than 5000 feet, so that he collected no portion of the vegetation of the upper zone of the country. However, as the mountain flora is of more purely botanical interest, while that of the plains is of special commercial importance, on account of the number of economic plants it contains, its absence is, from the economic point of view, the less to be regretted.

At present the collection has not been fully worked out; but it is estimated that it comprises about a hundred species previously unknown to science, besides largely supplementing the material in herbaria of many obscure plants. Its principal value, however, as already mentioned, lies in the number of usually very complete specimens of economic plants and their products.

Foremost in importance, and the characteristic and dominating feature of the vegetation of the plains, are the *Umbelliferae*. Some of these are of gigantic size, for herbs, and several of them yield valuable gum-resins, known in commerce as gum ammoniacum, gum galbanum, asafoetida, &c. A special paper on these plants was read by Dr. Aitchison on December 8 before the Pharmaceutical Society, therefore it would be superfluous to enter into details here. Early next year will be published a full and illustrated Report on the whole collection, in which prominence will be given to the economic plants: such as have not previously been figured, or only in-

adequately figured, will be selected for illustration. Remarkable among the *Umbelliferae* not known to yield gum-resins are *Ferula oopoda*, Boissier, *F. suaveolens*, Aitchison and Hemsley, and *Dorema serrulatum*, Aitchison and Hemsley. The first we have identified with a described species, though the specimens are very fragmentary, and the description incomplete. It is a most singular plant, in which the bases of the cauline leaves are developed into large circular bowls, through a succession of which, gradually smaller upwards, the stem passes. The largest of these bowls are as much as a foot in diameter, and about two quarts in capacity. From his investigations on the spot, Dr. Aitchison is of opinion that these bowl-like expansions of the petioles do not serve the plant as reservoirs of water: possibly they may prevent the ascent of insects which infest and consume the fruit of many of the *Umbelliferae* of the region. *F. suaveolens* furnishes a kind of sambal, and the *Dorema* is a very distinct new one. These *Umbelliferae* form very beautiful miniature forests; *D. glabrum* growing as much as 10 or 12 feet high.

Among other economic products whose sources have been traced and good specimens of the plants secured, yellow dye, largely imported into India, may be mentioned. It is furnished by an apparently undescribed species of *Delphinium*. Another dyeing material turns out to be the roots of a species of *Prunus* (*P. (Cerasus) calycosus*, Aitchison and Hemsley), remarkable in being apetalous; the petals being replaced by the coloured petal-like calyx-lobes. *Pistacia vera* Dr. Aitchison regards as undoubtedly indigenous in this region, and numerous other interesting facts of the same nature will be described in his Report.

In conclusion, it may be mentioned that Dr. Aitchison succeeded in bringing home his extensive botanical and zoological collections by way of the Caspian and Black Seas, in an admirable state of preservation. Of course it will be understood that there is no difficulty in drying plants in Afghanistan and Persia. In fact, they are likely to get too dry, and consequently break and crumble pieces in transport, especially when, as in this case, they are carried on camels and mules day after day; and it was only by the most careful and elaborate packing that the plants were prevented from being rubbed into powder.

W. BOTTING HEMSLEY

DEPOSITS OF VOLCANIC DUST

IN several recently-published papers,¹ Prof. George Merrill has called attention to some interesting deposits which are shown by careful microscopic study to consist of volcanic dust.

Samples sent by Mr. Zahn, of Nebraska, to the United States National Museum were supposed to be "geyserite" and similar materials are said to occur in Western Kansas, Eastern Colorado, and Wyoming. They were found in small patches or in beds up to four feet in thickness, covered by a considerable thickness of other deposits. Of this material Prof. Merrill writes as follows:—

"A glance at the samples was sufficient to convince the writer that they were not the result of geyser action, but were probably of volcanic origin. One was of a bluish chalky whiteness, very finely pulverised, and of a soft-gritty feeling when rubbed between the fingers. The second was gray in colour, slightly coarser, and had, to the naked eye, a flaky appearance. Submitted to microscopic examination, both samples were found to consist almost entirely of the minute particles of amorphous glass, such as originate from the fine pulverisation of glassy pumice, with only occasionally a fragment of greenish mineral that was apparently hornblende."

¹ "On Volcanic Dust from South-Eastern Nebraska" (*Proc. Nat. Mus.* vol. vii. 1885, p. 99); "Notes on the Composition of Certain 'Pebble Sandstones' from Montana and Idaho" (*Am. Journ. Sci.* vol. xxviii. p. 199).

The figures given of these particles show that they closely resemble pumiceous dusts (see NATURE, vol. xxix. p. 587). An examination of the sandstones with which these dusts are sometimes found interstratified proved that they consist of well-rounded particles of triclinic feldspar, hornblende, and magnetite, and that they are therefore, like the associated dust deposits, of volcanic origin.

Among a series of so-called "Pliocene sandstones" collected in Montana and Idaho in 1871 by Dr. A. C. Peale, of the Hayden Survey, Prof. Merrill was able to detect similar pumiceous sands in a more or less pure state. In their microscopic characters several of these were found to be very similar to the pumice-dust which was thrown out so abundantly during the great eruption of Krakatãb.

"All of the above-mentioned dusts yielded water when heated in a closed tube, and fused readily, with swelling, before the blow-pipe. Samples submitted to Mr. J. E. Whitfield, of the Geological Survey, for analysis, yielded results as follows:—

	Marsh Creek Valley, Idaho	Little Sage Creek Mountain	Devil's Pathway
Ignition	6'00	6'50	5'60
Water ¹	1'60	1'12	3'46
Fe ₂ O ₃ + Al ₂ O ₃	16'22	18'24	17'18
SiO ₂	68'92	65'56	65'76
CaO	1'62	2'58	2'30
MgO	trace	0'72	trace
Na ₂ O	1'56	2'08	2'22
K ₂ O	4'00	3'94	3'14
	99'92	100'74	99'66

Accepting the apparently well-founded conclusions of others to the effect that such dusts represent the extreme degrees of acidity of the lavas of which they formed a part, we are led to consider these as of andesitic or possibly trachytic derivation."

Other similar materials have been examined from Bridger Creek, on summit of a hill near Bozeman, and in connection with fossil bones from the Niobara Loup Fork and Sweetwater regions. A sample obtained from the base of the Mazatzol Mountains at the edge of Verde River Valley is stated to be quite similar to that described from the east of the Black Hills of Dakota, described by Dr. Wadsworth,² and also to those previously described by Prof. Merrill from Nebraska. Other similar dusts have been obtained by the officers of the United States Geological Survey from Wray Station in Eastern Colorado, and from Norton and Phillips Counties, Kansas.

"In studying the probable origin or sources of these various beds, the distances which the dust can be carried by atmospheric currents is likely to prove of importance. It may therefore not be out of place to state here, that among a collection of pumices, ashes, &c., from the Krakatãb eruption in 1883, and which were donated to the Museum by T. H. Houghton, was a small sample of the dust (36974) that 'showered on board ship *Beaconsfield* at the rate of one inch per hour for three days, in latitude 14° S., longitude 92° E., or at a distance of 855 miles from the scene' of volcanic activity. This dust is a very pure, nearly colourless, gray and highly pumiceous glass, the particles of which vary in size all the way up to 0'25 mm.

"As a matter of economic interest I may say in conclusion that in Kansas and Nebraska these dusts are collected and sold in paper packages as 'diamond polishing-powder,' or put into soap which is sold for general scouring as well as for dental use under the name of 'Geyserite soap.'"

¹ Water given off at 100° C.
² *Science*, July 24, 1885.

THE POTATO TERCENTENARY

AN article on "The Origin of our Potato," which appeared in our columns on May 6, contained these words: "It would be a fitting observance of the third centenary . . . if we could celebrate it, not by speeches and after-dinner toasts to the memory of Drake or of Raleigh, but by clearly laying down our lines of inquiry, for they have been very ill-defined." These words, penned by our contributor with then no definite idea as to the way in which various thinkers could be brought together to help to lay down lines of inquiry, have had their effect. The proprietors of the St. Stephen's Hall took the subject up, and in a circular headed 1586-1886, printed in old English type, referred to the article in NATURE as drawing attention to the fact that 1886 was the accepted date for the tercentenary, and announcing their intention to celebrate it in the spirit suggested, with Conferences and an historic and scientific Exhibition, conjoined with a display of all known varieties of tubers that could be obtained. A "Scientific Committee of Consultation" readily offered their services to arrange the "historic and scientific" portions of the Exhibition and to conduct the Conferences. Leaving, as it was seen we were, the old lines of cultivation, and entering on a more thoughtful, a more scientific way of procedure, the turning-point appeared to demand a recognition of the past, an exposition of present knowledge, and something tangible of the on-look into the future.

The proprietors of the St. Stephen's Hall, while acting as the executive, and arranging the display of tubers, and offering gold, silver, and bronze medals, left all the scientific work to the Committee of Consultation. Those who first accepted their responsibilities had to seek the co-operation of others, and only those who were specialists in the portion of the subject they represented were invited to join it. In the list of sections as drawn up, the botanical aspects of the question naturally came first, and Mr. J. G. Baker, F.R.S., of Kew, undertook to illustrate "The Known Wild Species of Solanum," which he did partly by dried specimens and partly by drawings. No one was found to undertake the section "Batatas, yams, ighnamas, &c., that in Elizabethan times were called potatoes," but specimens of yams and so-called batatas were shown. Some uncertainty about the vernacular nomenclature of these seems to exist. The section "Cultivation by the Incas and other Andean Nations" was accepted by Mr. C. R. Markham, C.B., F.R.S., who in the Conference added more information than could be given in the form of an exhibit. For the next section on the programme, "Early Cultivation in the British Isles," no one could be found. This is a fact worth notice. There must surely be some one who has paid attention to this subject, yet even after the Committee was fully formed it was not known to whom to apply for information.

The next section, "Cultivation," with its sub-sections—(1) Selection, (2) Cross-breeding, (3) Hybridisation, (4) Grafting—was undertaken by Dr. Maxwell Masters, F.R.S.; and the following section, "Potato-disease," was well filled up with contributions from Mr. W. Caruthers, P.L.S., Mr. Worthington Smith, Dr. Plowright and Mr. Geo. Murray, F.L.S. For the section "Chemistry of the potato and batata as a food" Prof. Church sent new analyses, and Mr. W. Topley, F.G.S., of the Survey, contributed maps and notes on "Soils suitable for Potatoes geologically considered."

In "Meteorology as affecting Disease," Mr. J. G. Symons, F.R.S., exhibited rainfall maps showing coincidence with special disease years. The next section, "Historic literature of the potato," was in charge of Mr. W. S. Mitchell, M.A., and by the help of dealers in old books, and of private collectors, the list he had drawn up had but one gap—a Monardes. Such a collection has no before been brought together. The section "Maps showing the knowledge of the New World at the time of Elizabeth"

was formed by the help of Mr. Coote, of the Map Department of the British Museum, Mr. C. R. Markham, Mr. Henry Stevens, and others. For the section "Raleigh" Dr. Brushfield, of Salterton, Devon, sent up his collection of works, which, with some additions, were arranged by Mr. H. B. Wheatley, F.S.A.; while the "Drake" section was mainly composed of an interesting series of illustrations sent up from Plymouth by Mr. W. H. K. Wright, of the Public Library. Mr. B. D. Jackson, Sec. L.S., contributed the works illustrating the "Gerard" section; but no one could be found to supply any information about Heriott, as that section was blank.

It is worth noting that this Exhibition was not one in which the list of sections followed what was sent in. What ought to be shown was drawn up first, and where the required works or maps, &c., could not be obtained the blank was understood.

Many unexpected curiosities arrived. Potatoes from Youghal, co. Cork, where it is said Raleigh planted his first potatoes in Ireland, were sent, together with views of his residence there where he conversed with Spenser. Irish cooking-pots of the same type as those in use 300 years ago, and rough garden, or possibly field, tools, were also sent over. Potato-culture in every aspect was represented, except in illustrations of the new methods of artificially fertilising by removing pollen from one flower to another.

As regards the show of tubers, the judges, Messrs. Shirley Hibberd, William Earley, and R. Dean, considered them well worthy of the occasion. The especial aim was that every known variety should be represented, and there was a special section for new varieties, introduced within the last two years, not yet in the market. The prize-winners of the medals offered by the executive have been made known in journals devoted to these subjects.

The Exhibition itself dealt with the past, including in that, history from the time of Raleigh and Drake down to the recent past.—Mr. Baker's work on distinct wild species of tuber-bearing Solanums, which he has reduced from six to four since his paper at the Linnean Society was read.

The chief scientific importance of the celebration of the tercentenary, however, lay in the Conferences.

At the opening, Mr. W. Carruthers, P.L.S., took the chair, and the first paper was read by Mr. W. Stephen Mitchell, M.A., on "Historic Consideration of the Question, whence came the Potato to England." Alluding to articles he had written, he said it was easy to see how the mistake had arisen that the introduction of the potato had been attributed to Raleigh, and that Virginia had been regarded as its original home; and he expressed his belief that Drake brought it from Carthage in his 1586 expedition, on which expedition he had asked his friend, Mr. W. H. Pollock, to contribute a paper. This paper (read in the writer's absence by Sir Richard Pollock) detailed the expedition, and showed that there was opportunity for Drake to have taken on board the potato as ship's-provender at Carthage. The supply at Carthage depended on native cultivation. Then in due sequence followed Mr. Clements R. Markham's paper on "The Cultivation by the Incas and other Andean Nativon." This paper proved to be the surprise for the Conference. The cultivation by the Incas was already fairly well known, as our article of May 6 showed, from the writings of Garcillasso de la Vega, Acosta, and Cieza de Leon. But the cultivation by the Chibchas was the revelation. Not only have the people died out, but their language has been lost. A *vocabulario*, however, has preserved many of the words they used, and nine varieties of potato are in it named. It is thus seen that before the Old-World people (the Spaniards) reached the New World, the potato had been so long cultivated, and that distinct varieties were recognised. Mr. Markham most eloquently described the high civilisation of the Incas,

and with a large-scale lecture-map, belonging to the Royal Geographical Society, showed the regions of potato-cultivation as they can be inferred from early writers. Following most appropriately on this was Mr. J. G. Baker's paper on wild species of potatoes as known to botanists at the present day. In the discussion which followed, there was naturally raised the question, What are wild species, and what were cultivated by the Incas and other neighbouring peoples? but, of course, no definite answer could be given. This is one of our troubles. Mr. Markham's paper was also of very considerable interest. M. Henri de Vilmorin then gave a brief account of what he had been able to ascertain about the introduction of the potato into France, which he hopes to be able to work out more fully. This concluded the historic portion of the work of the Conference. Then Mr. George Murray, F.L.S., of the British Museum, gave an account of the history, of the study, and of the present state of our knowledge of the potato-disease. The facts he mentioned have already appeared in these columns. The day's work ended with a vote of thanks to the Chair, proposed by Earl Cathcart.

On the second day of the Conference, Mr. W. S. Mitchell in the chair, the first paper read was by Dr. Maxwell Masters, F.R.S., "On the Production of Varieties by Cultivation." It embodied the thoughtful appreciation of past work, and what has to be done in the future. It is on hybridisation our hope must mainly rest on a cross by artificial fertilisation between two distinct species, all other "cultivation" being but a continued ringing of changes. It was, from a practical point of view the most important communication made to the Conference. The following papers by Mr. W. Earley, Mr. A. Dean, and Mr. R. Dean took up the question of cultivation from the grower's point of view, and coming as they did from such recognised practical men they were of value. Mr. Hibberd criticised, from his own experiments the value of the Jensen system of earthing-up, and stated his belief that it did not add to the crop, even if it might, as asserted, prevent disease from spreading. He suggested and backed up his suggestions with reference to his own experience, that the early raising of a crop showing signs of disease was of use. The period for doing this, however, he did not mention, and to raise a crop before the starch is formed in the tubers would be of little real value. The suggestion, however, is one of importance for future consideration. He detailed an unintended experiment made during the last twelve months which is worthy of attention of practical men. It will reach them through horticultural journals. Mr. R. Dean, in his paper admitted that, although he had thought potato-cultivation thoroughly "threshed out," he had come to the conclusion that remained to be done. The aim of the cultivation was to produce handsome table tubers. Sufficient attention has not been paid to degeneracy and the cause of it, although it is very well to produce new varieties is to get them into general use. People are too fond of old lines. In the course of his paper he detailed the following:—Mr. A. Dean, in reading on "Risks to varieties of potatoes," referred to the fact that cultivated varieties do not produce any flowers, and some wild flowers do not mature pollen. He detailed several experiments in crossing, and especially drew attention to varieties that do or do not produce much haulm. As it is through the leaves on the haulm that the disease reaches a plant this is a matter of importance. In the course of the discussion Mr. Ap Thomas gave some valuable information about potatoes in South America, and Earl Cathcart expressed the hope that the information should be in some form preserved.

After the usual votes of thanks had been passed, the generally expressed opinion in conversation was that the Exhibition should have been open for four weeks instead of four days. That the Conference, by bringing together

people who view the whole subject from different stand-points, have done good appears to be admitted. The future will show.

NEW ZEALAND COLEOPTERA¹

IN an important memoir quite recently published, Dr. Sharp describes a large number of new species of Coleoptera from New Zealand. Although the entomology of these islands is of considerable interest, it is still very imperfectly known, and a quite erroneous idea as to its poverty is very often found to exist. Linnæus knew of no Coleoptera from the group, but a small number had been obtained by the naturalists of Capt. Cook's voyage. Some of these were described by Fabricius about a century ago, and a few of these are still to be found in the Banksian Collection at South Kensington, but from Cook's day until the date when the island was visited by Her Majesty's ships *Erebus* and *Terror* little was done in the way of investigation. When Adam White published the account of the Coleoptera of this last Expedition (1846), he enumerated all the species of the group known to date to inhabit New Zealand, and the total was about 150; however, between 1866 and the present time, the greatly increased activity of collectors swelled the number of species known to nearly 1500, and in the memoir we are now noticing Dr. Sharp describes 141 additional forms. Dr. Sharp still, however, regards the Coleopterous fauna as very incomplete, and on the consideration of such data as he possesses ventures on an estimate that between 3000 and 3500 species will probably be found in New Zealand; so that there is an immense field still open for collectors. The fauna so far as known is very analogous to that of Europe in extent and complexity. The species when examined show similar structures, exhibiting analogous gradations and cross affinities, but the New Zealand insects possess a larger proportion of forms in which the structures are less perfect—comparatively, as it were, little evolved. In brilliancy of colour and in large and conspicuous forms, the New Zealand Coleoptera are very deficient, but to the specialist they make up for this in the interest attaching to many of them as isolated forms having, so far as is at present known, little or no connection with the ordinary Coleopterous fauna of the island.

While the data are so imperfect it is obvious that no reliable answer can be given to the question of the affinities of the New Zealand fauna; but Dr. Sharp, from what is known, entertains the impression that it will be in the Chilian and Patagonian fauna that the greatest amount of affinity will be found, and that, while numerous points of propinquity with the Australian fauna undoubtedly exist, yet they are rather exceptions dealing with isolated forms, and but little affect the mass of the fauna.

Lasiornychus barbicornis is the only member of the Brenthidæ found in New Zealand, and is perhaps the most remarkable beetle of the islands; it must be considered a highly evolved form, the sexual differentiation being great, with remarkable male characters, large size, and considerable perfection of general structure, and while it appears to be quite foreign to the New Zealand fauna, it would seem to have no really close ally in any other country.

Another isolated form, of large size, for many years known, but still a great rarity, is *Dendroblox*. Its position has never been satisfactorily fixed; it has no ally in New Zealand, and no near ally out of it. Such cases are extremely difficult to explain. Dr. Sharp thinks it possible that there has been going on in New Zealand, for an enormous period of time, the evolution of a fauna parallel with that of the continents of the world, and that during this period it has occasionally received intrusions

from other countries, some of which have continued to evolve since their introduction, while others have remained with little change. On such a view *Dendroblox* might be an ancient intrusion into New Zealand, which has become extinct elsewhere, and has evolved but little in New Zealand; while *Lasiornychus* might have evolved much since its introduction.

This memoir forms a part of the *Scientific Transactions* of the Royal Dublin Society, and both as regards the paper and press-work it is extremely creditable to the Society. The two quarto plates contain fifty figures of the new species described. These are from the pencil of Baron Schlereth, of Vienna, and are among the best illustrations of Coleoptera we have seen. The plates have been printed after a new and brilliant process by Bannwarth, of Vienna.

THE RELIEF OF EMIN PASHA

EVERYBODY seems agreed that Dr. Schnitzler, better known as Emin Bey, but recently created Emin Pasha, ought to be relieved; for he does not want to be rescued. For ten years he has been in the Egyptian service, for most of that time as Governor of the Equatorial Province, which, in spite of the Mahdi and his hordes, the death of Gordon, and the collapse of the Egyptian Soudan, he continues to administer with success, and to the comfort and satisfaction of all but slavers. What Emin Pasha has done for science in the little leisure left him by his arduous duties, the readers of *Petermann's Mitteilungen* and the *Proceedings* of the Zoological Society know. He is a good type of the kind of explorer that is wanted now that mere pioneering work has been pretty well exhausted: a man well qualified by his scientific training to remain in a particular region for years if necessary, and study it in all its aspects. We have had such men in the past: some of the greatest names in science could be mentioned as examples. We do not insist in these pages on the great services which Emin Pasha has rendered to civilisation during his residence in the Soudan, first as the noble-minded Gordon's lieutenant, and latterly as one who, in the spirit of Gordon, resolved to stick to what he conceived to be the post of duty at all hazards. Our own Government has virtually admitted its responsibility for the present position of Emin Pasha, but has weakly attempted to shirk its duty by devolving the business of relief on private individuals. Should disaster happen, however, to Emin Pasha or to any expedition sent to his relief, we may be sure that public opinion will not blame any private individuals. Government, however, has gone so far as to promise every assistance short of contributing money.

It is unfortunate that already there has been a delay of several months since first we knew of Emin Pasha's critical position, and since first the Intelligence Department began to make inquiries as to the best route for a relief expedition. Even now, when an expedition has been decided upon, there seems little prospect of a speedy start. Surely, if those to whose hands the 10,000*l.* contributed by the Egyptian Government have been intrusted had the interests of Emin Pasha solely at heart, a competent leader would have by this time been within hail of Zanzibar. A better leader, under the conditions, than Mr. Stanley could probably not be found; but surely there has been unnecessary delay in deciding to send him. The idea of more than one expedition is entertained by many; and, as our map will show, the most direct and safest route is by Masai Land, about which we now know so much through the journeys of Mr. Thomson and the late Dr. Fischer. Dr. Junker telegraphs from Zanzibar that a relief expedition is urgently necessary, and that as fighting is inevitable, Mr. Stanley ought to be sent. By the Masai Land route, as shown on the map, avoiding Ungoro

¹ On New Zealand Coleoptera, with Descriptions of New Genera and Species. By David Sharp, M. B. With two plates. (Dublin, 1886.)

and Uganda, and skirting Lake Baringo and Tūrkan, we doubt if any fighting would be necessary. We have reason to believe that the King of the Belgians will not object to Mr. Stanley undertaking an expedition, and that Mr. Stanley will choose the East Coast route, but whether through Masai Land, or by the the west side of Lake Victoria Nyanza, and so on to Albert Nyanza, remains to be seen. What geographers would like most of all, would be an expedition by the Congo and Mobangi Rivers. In this way, not only would fresh discoveries be combined with the relief of Emin Pasha, but, by sending out two independent expeditions, the latter would almost certainly be accomplished.

Our map is intended to show the various routes that have been proposed. There is, first, the Masai Land route described above, the total length of which, to

Wadelai, where Emin Pasha is stationed, is only 820 miles, and thus is the shortest of all the routes. Mr. Thomson has traversed this route to within 300 miles of Wadelai, and these 300 miles are as yet unexplored. The most formidable difficulty here would be the bellicose Masai, but these, Mr. Thomson has shown, can, after all, be managed. By keeping well to the east, there would be little danger of the cruel young potentate of Uganda hearing of the expedition, and so the lives of missionaries and native Christians would not be endangered. Next is the Uganda route, which is understood to be favoured by Mr. Stanley, and which is 1050 miles in length, and all previously traversed. Most tempting of all the routes, if exploration were the only object in view, would be the Congo-Mobangi route. The Mobangi is one of the greatest of the tributaries of the Congo, and

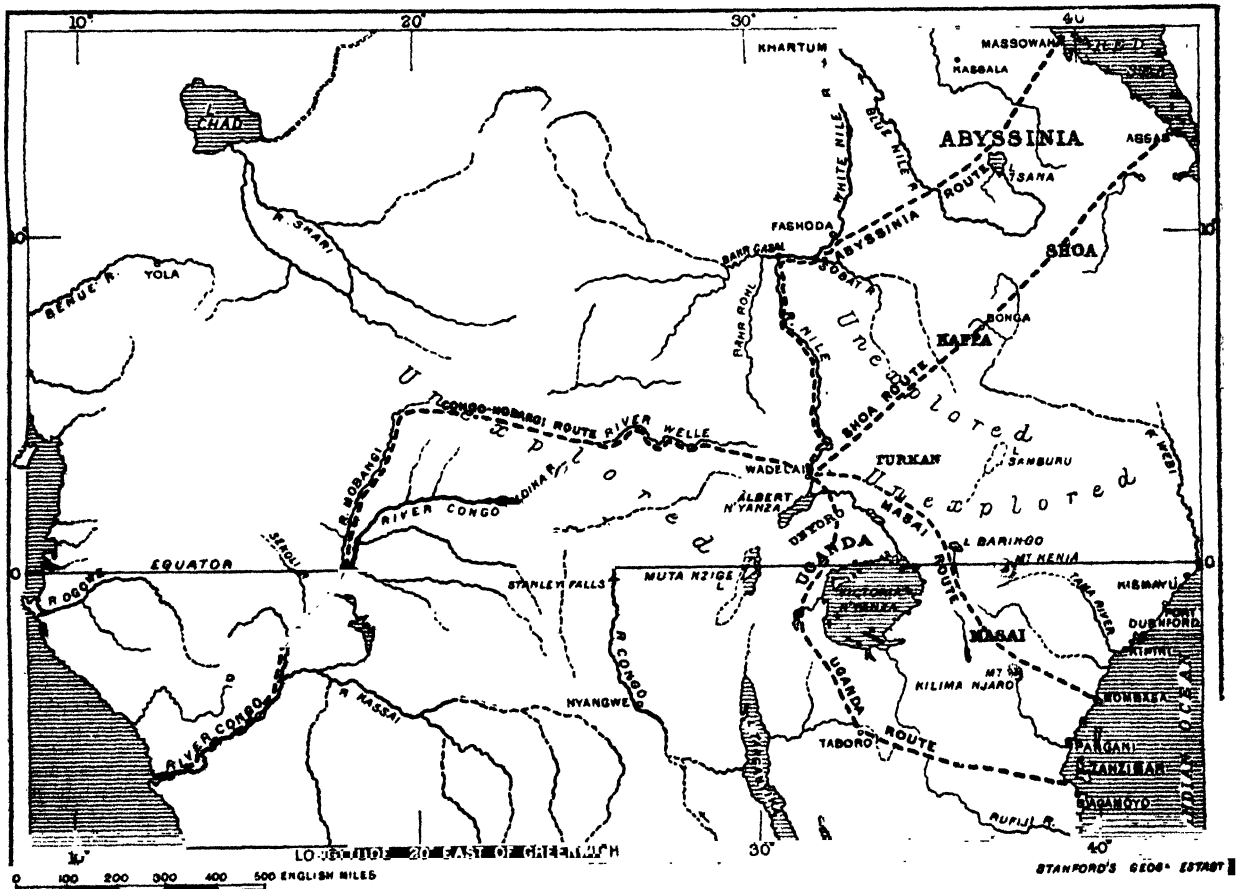

has been navigated for about 250 miles by Mr. Grenfell. On the other hand, Dr. Junker has been down the Welle-Makua to 22° E., within about 200 miles of Grenfell's farthest. Now, if we were certain that the two rivers were one, in spite of the rapids on the Makua this is a route we should be strongly inclined to support. But no risks should be run and no experiments tried in a matter so critical. By all means send an expedition by this route, and solve one of the few remaining hydrographical problems in African geography. We must say, however, that those best acquainted with the levels in this region still maintain that the Welle does not come down to the Congo at all, or, if it does, not by the Mobangi. This route is 1900 miles in length. The Abyssinian route, in our opinion, does not deserve any consideration so far as the relief of Emin Pasha is concerned, though there is some exploring work

to be done in this direction. The total length from Massowah to Wadelai is 1400 miles,—Massowah to Fashoda 700 miles, of which at least one half is unexplored, and from Fashoda to Wadelai by the Nile about 700 miles. In the same category as the Abyssinian route is the Shoa route—1050 miles, from Assab to Wadelai, 300 miles being unexplored. There is also a rumour that the King of the Belgians intends to send Mr. Stanley up the Nile, but this is a rumour that can scarcely be credited.

Altogether it seems evident that, if Emin Pasha is to be reached with the least possible delay and with substantial relief, the Masai Land route is the one to take. There is one important consideration that must be mentioned. With a caravan consisting solely of men they could take only what they themselves would consume, and it is difficult to see how a supply of ammunition and

other necessaries could be conveyed. Now, by Masai Land it is all but certain that camels could be utilised, and these animals could find their own provender. With 30 or 40 camels and 60 donkeys, very substantial relief could be taken to Emin Pasha. Indeed, the whole route, at least to the borders of Emin Pasha's province, is so comparatively level that Cape wagons could be taken, though in such an expedition it would not be advisable to try the experiment. The important thing is that there should be no further delay in starting at least one expedition, whoever the leader is to be.

Mr. Stanley was to arrive at Southampton yesterday, and we may be sure that if there is any delay in getting an expedition under way he will not be to blame.

NOTES

ON the 15th inst. a meeting was held of the Association for Promoting a Teaching University for London, when the Committee presented their second report. At a meeting held in December 1885, the Committee were instructed to open communications with the governing bodies of the University of London, University College, King's College, the Royal College of Physicians of London, the Royal College of Surgeons of England, and the various Medical Schools of London, as well as with the Council of Legal Education, for the purpose of promoting the objects of the Association on the basis of that report. The Committee have been informed by the Senate of the University of London and by the Councils of University College and King's College, that committees of those bodies had been appointed to consider the objects and proposals of the Association. The Council of King's College have adopted a resolution to the effect that "the Council, while reserving their opinion as to the details of the scheme laid before them by your Committee, approve generally of the objects which the Association has in view." The subject having been brought before the Council of University College, they adopted a resolution to the following effect:—"That this Council do express a general approval of the objects of the Association, which are as follows:—(1) The organisation of University teaching in and for London, in the form of a teaching University, with Faculties of Arts, Science, Medicine, and Laws; (2) the association of University examination with University teaching, and direction of both by the same authorities; (3) the conferring of a substantive voice in the government of the University upon those engaged in the work of University teaching and examination; (4) existing institutions in London, of University rank, not to be abolished or ignored, but to be taken as the base or component parts of the University, and either partially or completely incorporated, with the minimum of internal change; (5) an alliance to be established between the University and the Professional Corporations, the Council of Legal Education as representing the Inns of Court, and the Royal Colleges of Physicians and of Surgeons of London." A conference between the deputation of the Committee named in that behalf and the Committee of the Senate of the University of London was held on November 23 at the University of London; and, at the conclusion of a long and important discussion, the Vice-Chancellor gave to the deputation the assurance that the general disposition of those present was to move in the direction indicated by the Association. Various other institutions have virtually expressed approval of the object of the Association, and, while awaiting some further communication from the Senate of the University of London, which it is understood will be made, either to them, or in an independent way to the University teachers of London, the Committee propose to take steps for bringing to the notice of Her Majesty's Government the need which exists for the co-operation of the Government

and of the Legislature, in order to place University teaching in London on a more satisfactory basis.

IN connection with the report referred to above, the *University College Gazette* of December 17 contains a long article sketching briefly the career of University College, and alluding specially to the results of its severance from the University. The University, the article maintains, has carried out with great success, and to the great benefit of many workers, its design of a testing machinery that should enable it to throw its degrees open to all the world, without restrictions of any sort. It has grown to be a great Imperial University. Whatever faults there may be in its imperial system are of a kind to be corrected in the ordinary course of administration as time proves the need. On the side of the University of London, there is leisure now to go back to the point of separation from the Colleges, and having done one part of its work well, see that it does not leave the other undone. On the side of the Colleges, and of London itself, there is now a determination that the chief city of the world, abounding in the best elements of a true University life, shall not remain without a teaching University. The first aim of University College, the article goes on to say, is to form an alliance with the present University, by large expansion of its powers. "The desired work can be done so much more thoroughly by the University in concert with the College, and the issues are so important for their influence on the London of the future, that, if the result of the present deliberations at the London University were but faintly satisfactory, effort towards united action should be steadily continued by our College. Not until it has been proved (apart from rash assumption) that the desired concert cannot be obtained, should we consider that the time had come for advancing our next line of battle. Then it must be our resolve to apply all our powers to the creation of a separate teaching University in London; to the resuming of our first battle, and recovering for University College the position it gave up on conditions that are no longer fulfilled. King's College will join forces with us, but with or without allies we must press on to victory, and in this form of the battle, should we be forced to it, we depend on ourselves; we shall have public feeling with us, and the fault will be ours if we fail."

THE death is announced, on Friday last, of Sir Douglas Forsyth, at the age of fifty-nine years. He will be best known to science as the leader of the mission to Kashgar, the report on which, only recently completed, forms so valuable a contribution to the natural history of Central Asia.

IT is evident that at Rodriguez, a small dependency of Mauritius, the indigenous plants are threatened with extinction from an enemy of a peculiar character. In the Annual Report of the Acting Civil Commissioner on Crown Lands and Forests for 1885 it is stated:—"In my report for the year 1884, I pointed out the existence of a kind of white lice, commonly called here 'cochenille,' which had in a very short time multiplied enormously, and threatened to destroy the forests of Rodriguez. During the year 1885 matters looked more alarming still. It was reported to me that these insects had begun to attack the maize, manioc, and bean plantations: I myself while visiting the mountain ascertained the correctness of the report. However the bean harvest had not been bad, and the inhabitants had not to suffer from any scarcity of food. As regards the citron, lemon, and orange trees, for which this island has long been famous, hundreds of them have been killed by these insects. The mango and cocanaut trees felt their baneful influence, and yielded sour and unsavoury fruits. One of the best forest trees which grow here, the 'Bois puant' (*Festidia mauritiana*), seems unable to resist their attack, and I am afraid that there will not be one of these trees left within a

twelvemonth, unless, by some happy circumstance, these insects were to disappear altogether." We learn from Kew that the interesting indigenous tree, whose complete extinction within twelve months is here anticipated, is very rare in Mauritius, and unless steps are taken to preserve it at Rodriguez, it will probably disappear altogether as a forest tree from the flora of these islands.

A MEETING of students anxious to form a Biological Society in connection with University College, London, was held on Monday, the 13th, in the Zoological Theatre, Prof. Lankester in the chair. The provisional Committee appointed at the first meeting submitted to the Society the rules they had drawn up, which after some discussion were passed with slight amendments, and sent up to the Council for approval. Many lady-students were present at this meeting, and so strong is the wish on all sides that they may be admitted to the Society, especially as the classes of Botany and Zoology have been thrown open to them, that two lady-students were put up as candidates for the Committee, and only missed election by a few votes.

AT a meeting of biologists held in the Natural History laboratory, University College, Liverpool, on Saturday, December 11, it was resolved to found a Biological Society in Liverpool, to have for its object the study and advancement of zoology, botany, palæontology, anatomy, physiology, and embryology, and the publication of papers of scientific value on any or all of these subjects. The following gentlemen were elected as office-bearers for the ensuing year:—President: Prof. W. Mitchell Banks, M.D., F.R.C.S.; Vice-Presidents: James Poole, J.P., Mayor of Liverpool, and Prof. W. A. Herdman, D.Sc., F.R.S.E.; Treasurer: J. C. Thompson, F.R.M.S.; Secretary: R. J. Harvey Gibson, M.A., F.R.S.E. It was decided to hold the first meeting of the Society at University College on Saturday, January 15, 1887, when the work of the Society will be initiated by the delivery of an inaugural address.

DURING a recent voyage of the U.S.S. *Juniata* to South America, observations were made as to the height and length of waves, with the following result, as reported by Commander Davis: height of wave from hollow to crest, 25 feet; length from crest to crest, 375 feet; wave-period, 7.5 seconds. The wind-velocity at the time was 10 miles per hour. The height of wave was measured by the elevation at which an observer could see over the crest when the ship was in the hollow. The wave-period was estimated by counting the average number of waves per minute. The wave-length was determined by the time occupied by the crest in passing a measured portion of the vessel's length.

IT is stated that the task of working up the materials collected by the survey parties of the Afghan Boundary Commission during the past two years into a regular series of maps has been undertaken by Capt. Gore, R.E., and that it will be carried out at Dehra Dun.

HIGHER mathematics in its applications to social problems is the subject dealt with in a new Vienna journal, *Die Controle*, which is edited by the mathematician, Dr. Grossmann. In an appendix, entitled "Die Mathematik im Dienste der National-ökonomie," questions of national economy are treated on a mathematical basis.

PROF. DEWAR'S course of six lectures on the Chemistry of Light and Photography (adapted to a juvenile auditory) which begin on Tuesday next (December 28) at the Royal Institution will be very fully illustrated. Arrangements have been made for the introduction of a powerful beam of electric light, equal in intensity to a sunbeam, into the theatre, for photographic experiments. Many improvements have been made in the warming, lighting, and ventilation of the theatre during the autumn recess.

THE last mail from Singapore brings news of the death there on November 29, of Mr. William Cameron, explorer and geologist to the Government of the Straits Settlements, at the age of fifty-three. Mr. Cameron, after an eventful life in England and Australia, settled down in the Straits Settlements, where his practical knowledge of mineralogy and geology, combined with his love of exploration, procured him several appointments. Lately he had been employed by the Colonial Government exploring and mapping out the unknown parts of the Native States, and he received the title of Government Explorer and Geologist. The production of one of his maps of these States has recently been noticed in these columns. He was well known throughout the Native States, especially amongst the Malays and Sakies, of whose language and customs he is said to have had a most accurate knowledge, and over whom he had great influence.

ON December 18 the fine new Ethnological Museum at Berlin was ceremoniously opened by the Crown Prince, who was accompanied by the Princess. The Museum, which is a very fine large building, contains collections from all parts of the world, including the antiquities dug up by Dr. Schliemann at Troy. Herr Gossler, the Minister of Public Worship, read an address on the nature and objects of the institution, and the Crown Prince in replying referred among other things to the benefits which had accrued to the Museum from the colonial expansion of the Empire.

AT the last meeting of the Paris Geographical Society, M. de Lesseps was in the chair. After having heard an account of an exploration in the Panama Isthmus by M. Désiré Charnay the Chairman spoke about the canal. He said that, if necessary, sluices should be constructed, so that the canal should be opened at any price in 1889. Ulterior steps should be taken dispensing with them.

WE have received the report of the Leicester Literary and Philosophical Society for the past year, and also the first number of the new quarterly series of the *Transactions*. The reports from the various sections contained in the former are in all respects but one eminently satisfactory, as they show great activity and excellent work. The exception is Section B, Botany, astronomy, physics, and chemistry, in respect to which it is stated that there is "a lack of interest in Leicester in physical science, especially when real work is to be done." Indeed, this has become a question whether the Council should not be asked to terminate the existence of the section; but "the Council express a hope that the section may live through its time of depression, and, when the interest in physical science has revived, may regain its vigour." We are glad to observe that the botanical sub-committee, who have undertaken and are now editing a work on the flora of Leicestershire, have nearly completed the printing of the book, and hope to be able shortly to announce its publication. The *Transactions* will in future be published quarterly, in place of annually with the Council's report. Of the first quarterly number of the *Transactions* little need be said. It speaks well for the prosperity of the Society that an annual publication no longer supplies its requirements, and that a high standard of the papers read is shown by the fact that a number of them have been published by scientific periodicals of repute. The papers now published deal mainly with scientific subjects connected with Leicestershire, such as the Campanian of that county, the Lower Lias and Rhætic in the Spinn Hills, Leicester, &c. Special mention should be made of a very interesting chart by Mr. Montagu Browne, giving the dates of arrival of summer birds of passage in Leicestershire, from 1810 to 1855, and from 1877 to 1886.

WE understand that Mr. H. S. Vines is intending entirely to re-cast and almost re-write his edition of Prof. Prantl's "Flora of Leicestershire."

"Text-Book of Botany," and that his new work may be issued from Messrs. Swan Sonnenschein and Co. in the course of next year. In the meantime the publishers are re-issuing the existing book without alteration.

In the annual report of the Leyden Museum for the year ending September 1, 1886, Dr. Jentink, the Director of the Museum and the successor of Prof. Schlegel, is able to report substantial progress with the zoological collections, the most noticeable additions being an egg of *Apyornis maximus* and a skeleton of *Echidna bruijnii*. Considerable series of animals of all classes have been added to the Museum from the travels of Mr. Stampfli in Liberia and Mr. Van der Kellen in Benguela.

ACCORDING to the *Colonies and India*, the last experiment in sending salmon-ova to the antipodes appears to have been a great success. In January 1885, a shipment of eggs was made by Mr. James Youl, by desire of the Tasmanian Government, and the bulk of the eggs reached the colony in good condition, development of the embryo having been suspended by means of Haslam's refrigerating machinery. The eggs have developed into "fry," and the "fry" into "smolts," for several young salmon about 8 inches long have been captured accidentally in the Tasmanian Mersey.

THE same journal states that a Mining Institute has been successfully launched at Sydney, with a programme of future work calculated to increase the welfare of the mining industry.

IN the Reingraben s'ate of Polzberg, near Lunz (Austria), among other fossils a well-preserved skull of *Ceratodus* has been found. Two years ago a flat-pressed vertebral column was found in the same place, which seems to have belonged to the same animal.

THE additions to the Zoological Society's Gardens during the past week include a Red-handed Tamarin (*Midas rufimanus* ♀) from Surinam, a Mauge's Dasyure (*Dasyurus maugei*) from Australia, presented by Mr. Robert J. Hamilton; two Collared Peccaries (*Dicotyles tajacu*) from South America, presented by Mr. Thomas Bell; two Peafowls (*Pavo cristatus* ♂ ♀) from India, presented by Mr. Richard Hunter; two Indian Crows (*Corvus splendens*) from India, presented by Lord Lilford, F.Z.S.; a Yarell's Curassow (*Crax carunculata*) from South-East Brazil, a Razor-billed Curassow (*Mitua tuberosa*) from Guiana, a Red-billed Tree Duck (*Dendrocygna autumnalis*) from America, two White-faced Tree Ducks (*Dendrocygna viduata*) from Brazil, presented by the Rev. W. Bramley Moore; four Herring Gulls (*Larus argentatus*), British, presented by Capt. S. T. Sargent; six Spectacled Salamanders (*Salamandrina perspicillata*) from Italy, presented by Prof. H. H. Giglioli, C.M.Z.S.; a Macaque Monkey (*Macacus cynomolgus*), an Isabelline Bear (*Ursus isabellinus* ♂) from India, deposited.

OUR ASTRONOMICAL COLUMN

BARNARD'S COMET.—This comet has become an exceedingly interesting object, of no small beauty and brightness. Prof. Cacciatore, Director of the Palermo Observatory, in a letter appearing in the *Giornale di Sicilia* of December 1, speaks of it as visible to the naked eye. He says:—"Its head shines as a star of the fifth magnitude, and is accompanied by two tails, the one directed to the north-west, of a length of about a degree and a half, and the other to the west, about half a degree in length." But few observations would seem to have been made of the comet in this country, when the comparative brilliancy of the object is borne in mind; still, several English observers have called attention to the second tail. One observer speaks of the shorter tail as being, on December 9, more than 10° in length, visible to the naked eye; the second tail, which was inclined at an angle of 40° to the other, was much fainter and shorter, an aperture of about 2 inches to show it well.

The comet is now receding rapidly both from the earth and sun, and as its declination is diminishing, it will soon be lost to English observers.

ROTATION-TIME OF THE RED SPOT ON JUPITER.—Prof. Young, in the December number of the *Sidereal Messenger*, gives a fresh determination of the rotation-period of the great red spot on Jupiter. The determination rests upon eight observations made in the spring of the present year, and the rotation-period deduced is 9h. 55m. 40.7s. ± 0.2s.; the probable error of a single observation being ± 44s. This rotation-period shows that the gradual retardation of the period still persists, the following having been the values deduced in former years:—

	h.	m.	s.
In 1879	9	55	34.9
1880-81	9	55	37.2
1882-83	9	55	38.4
1883-84	9	55	38.5
1884-85	9	55	40.1

Prof. Young remarked the apparent overlapping of the southern belt and the red spot which took place towards the end of March and the beginning of April, and which was observed by many English observers (*Observatory*, May 1886, p. 188); but, whilst admitting that it was impossible to say which was uppermost, Prof. Young was inclined, in opposition to Mr. Denning's view, to believe the red spot to be the lower. Mr. Denning has pointed out that the apparent partial coalescence of the two markings was simply due to an arm of the southern belt overtaking the red spot, the former having a rotation-period shorter by about 19s. than the latter. Prof. Young observed a white spot in a yet higher latitude than this part of the southern belt, and deduced a period of rotation for it of 9h. 55m. 11.14s. It would thus appear that the red spot moves more slowly than the markings on either side of it, to the south as well as to the north.

ASTRONOMICAL PHENOMENA FOR THE WEEK 1886 DECEMBER 26—1887 JANUARY 1

(FOR the reckoning of time the civil day, commencing at Greenwich mean midnight, counting the hours on to 24, is here employed.)

At Greenwich on December 26

Sun rises, 8h. 7m.; souths, 12h. 0m. 51.4s.; sets, 15h. 54m.; decl. on meridian, 23° 22' S.; Sidereal Time at Sunset, 22h. 14m.
Moon (one day after New) rises, 8h. 32m.; souths, 12h. 56m.; sets, 17h. 22m.; decl. on meridian, 18° 54' S.

Planet	Rises	Souths	Sets	Decl. on meridian
	h. m.	h. m.	h. m.	° ' "
Mercury	6 18	10 28	14 38	20 50 S.
Venus	8 35	12 25	16 15	23 49 S.
Mars	9 47	13 57	18 7	20 55 S.
Jupiter	2 32	7 40	12 48	10 52 S.
Saturn	17 6*	1 10	9 14	21 44 N.

* Indicates that the rising is that of the preceding evening.

Variable Stars

Star	R.A. (1887°)	Decl. (1887°)	h. m.
	h. m.	° ' "	h. m.
U Cephei	0 52.3	81 16 N.	Dec. 28, 0 24 m
Algol	3 0.8	40 31 N.	27, 0 58 m
			29, 21 47 m
λ Tauri	3 54.6	12 10 N.	28, 4 27 m
			Jan. 1, 3 19 m
δ Libræ	14 54.9	8 4 S.	Dec. 27, 20 7 m
			30, 3 58 m
U Coronæ	15 13.6	32 4 N.	27, 17 40 m
			31, 4 31 m
R Serpentis	15 45.5	15 29 N.	29, M
β Lyræ	18 45.9	33 14 N.	28, 0 0 m
			31, 5 0 M
R Lyræ	18 51.9	43 48 N.	29, m
δ Cephei	22 25.0	57 50 N.	26, 21 30 m

M signifies maximum; m minimum; m, secondary minimum.

Meteor-Showers

On December 30 and 31 slow bright meteors fall from a radiant near 2 Lyricæ, R.A. 92°, Decl. 57° N. Other showers of the season radiate from near ζ Ursæ Majoris, R.A. 201°, Decl. 57° N., and from near β Bootis, R.A. 221°, Decl. 41° N.

Occultation of Star by the Moon (visible at Greenwich)

Dec.	Star	Mag.	Disap.	Reap.	Corresponding angles from vertex to right for inverted image
			h. m.	h. m.	° ′
28 ... 29	Capricorni ... 6		18 31	19 34	159 307
Dec. 27 ... 19	Mars in conjunction with and 3° 29' south of the Moon.				

GEOGRAPHICAL NOTES

SEVERAL recent German geographical periodicals refer to a paper read by Prof. Kan, of Amsterdam, before the Section for Geography and Ethnology at the fifty-ninth Congress of German Physicians and Men of Science at Berlin in September, urging on German explorers the necessity of undertaking a geographical and geological exploration of the Moluccas. He said that, although Europeans had settled in the islands for centuries, our knowledge of the orography, especially of the physical features of the archipelago, was exceedingly small. Excellent charts exist in abundance, and travellers, English and German, have subsequently visited it; but they were neither geographers nor geologists, but as a rule studied only the fauna and flora. The Dutch Government has done nothing as yet in reference to the geography of the Moluccas, because it has turned all its energies to procuring good maps of the more extensive Sunda Archipelago. Java has been triangulated and surveyed; there are excellent charts of the coast of Sumatra, and the triangulation of this great island has also been commenced, and, in late years, maps of parts of Celebes and Borneo have been produced. In geology, those islands of the Sunda Archipelago which contain useful minerals have been studied, and excellent geological maps of Sumatra, Banka, Billiton, South-East and North-West Borneo have appeared. In addition, the Government places annually at the disposal of the Geographical Society of Amsterdam 10,000 florins, which, Prof. Kan hoped, would next year be applied to the exploration of the Aru Islands. On the whole, therefore, the Dutch authorities are not lax in surveying and mapping their possessions in the East. Besides the Moluccas, Flores and Timor still offer a virgin field to the explorer, and Prof. Kan hinted that the traveller who undertook the work would not lack pecuniary or other help in Holland.

THE last number of *Petermann's Mitteilungen* contains the conclusion of Lieut. von François's account of his journey in the Southern Congo basin, the present instalment being mainly occupied with climatology and detailed hydrographical observations. Dr. Philippi also concludes the very interesting paper, to which we have already referred, on the changes wrought by man in the flora of Chili. It contains systematic tables of the plants introduced into Chili, and which it now has in common with Europe. Dr. Emil Jung continues his examination of the last census returns of India, the special subject in this number being the effect of the last famine on the movement of the population. There is, further, a brief review of the new edition of Berghaus's "Physical Atlas," and notes on an excellent map of the Dobrudja, which is appended.

WE have also received the last supplementary number (No. 84) of the *Mitteilungen*. It deals with the economical geography of the whole of North America, and is really the first number of a series called *Archiv für Wirtschaftsgeographie*. It treats of agriculture, forestry, mining, industry, trade, shipping, &c.

AT the last meeting of the Paris Geographical Society (November 19), M. Hansen-Blangsted read a communication on the physical appearance of Denmark in the middle of the eleventh century, as compared with the present time. M. Venukoff referred to the results of M. Nikolsky's studies last year of the physical geography of Asiatic Russia, especially the gradual drying up of Lake Balkash. The level of the lake is lowered by about 1 metre every fourteen or fifteen years. Two letters addressed to the Ministry of Public Instruction by M. Chaffanjon *en route* for the Upper Orinoco, were read, one from Ciudad Bolivar, the second, dated August 18, from Caracas. An interesting communication was read with regard to the last resting-place of Tavernier, the celebrated French traveller, who died in 1689. It was long unknown where he was buried, but it has at last been discovered to be the Pro-

testant cemetery at Moscow. The question of the best method of permanently marking the grave was referred by the Society to a Committee. Capt. Longbois read a humorous account of a journey to Choa, which had for its object the exploration of the Awash and its basin.

THE current number of the *Boletín* of the Madrid Geographical Society contains an interesting account of Don Manuel Iradier's recent explorations in the newly-acquired Spanish territory on the west coast of Africa. The enterprising explorer paid two visits to this region—first in 1875-77, and again in 1884-85, during which he traversed 40.0 miles between the equator and 3° N. lat., penetrating from the sea-board into the interior as far as about 20° E. long., and surveying to their sources all the coast streams between the Rio-del-Campo and the Gaboon. By far the largest of these rivers is the Muni, which enters the Atlantic in Corisco Bay, after receiving the contributions of the Utamboni, Noya, and other considerable affluents on both sides, and draining an area of nearly 6000 square miles between the Gaboon and the Rio San Benito. The whole of this river-basin is now Spanish territory, the protectorate having been everywhere accepted by the chiefs of the local tribes, who are collectively known as Vengas, and belong in type and speech to the Bantu family.

THE same *Boletín* reports the arrival in Lisbon of Major Serpa Pinto and Lieut. Augusto Cardoso, leaders of the Portuguese Expedition which has just completed the exploration of the region between Mozambique and Lake Nyassa. Starting from Ibo, south of Cape Delgado, the explorers advanced to the Mutepuezi River, and thence to Medo, where, Serpa Pinto falling ill, Cardoso took the lead. After traversing the Metarica district, the Lienda, an affluent of the Rovuma, was followed for some days, and found not to rise in Lake Nmaramba, but to flow through that lacustrine basin from Mount Songe, further to the west. From this point Lake Nyassa was reached in the Ki-Rassia district, whence the explorers proceeded by the familiar route down the Shiré to the Zambesi, and so on to Quilimane, on the coast. Being provided with excellent instruments, the explorers were able to take a very large number of astronomical and meteorological observations in a region now for the first time systematically surveyed.

THE prospectus has been issued in Vienna of a new geographical periodical to be called *Geographische Abhandlungen*; the editor is Prof. Penck, of the Vienna University, and Herr Hölzel is the publisher. It is not intended to compete with any existing geographical publications, but rather to supplement them. Each number will be complete in itself; compilations will be wholly excluded, and although a certain number will appear in the course of a year, the dates will not be fixed beforehand, in order to leave the writers as unfettered as possible. The three numbers promised are on the glaciation of the Salzach district, the orometry of the Black Forest, and the arrangement or distribution of the Eastern Alps, by Drs. Brückner, Neumann, and Böhm respectively.

ON SOME FURTHER EVIDENCES OF GLACIATION IN THE AUSTRALIAN ALPS¹

SINCE my announcement of the discovery of glacier evidences in the Mitta Mitta Valley ("On the Meteorology of the Australian Alps," *Trans. Roy. Soc. Vict.*, 1884, p. 23), and Dr. von Lendenfeld's subsequent discovery of traces of ancient glaciers on Mount Kosciusko ("On the Glacial Period in Australia," *Proc. Linn. Soc. N.S.W.*, 1885, p. 45), an interesting controversy has arisen respecting the nature and extent of such glaciation. Having recently undertaken an exploration of Mount Bogong, the highest mountain in Victoria, in company with Dr. von Lendenfeld, for the purpose of discovering further glacier evidences, and so aiding a solution of this important question, I have much pleasure in submitting the following remarks on the results of that expedition. It may be of interest to review my connection with the controversy as a student of physiography resident in the central part of the Australian Alps. During 1880-83, when studying the flora of the Australian Alps and collecting herbarium specimens for our venerable Nestor of botanic science, Baron von Mueller, it appeared to me that the date of the introduction of the endemic flora of the Australian

¹ Paper read at the Linnean Society of New South Wales, on May 26, 1886, by James Stirling, F.G.S., F.L.S.

Alps (whose affinities were so closely Tasmanian) might safely be centred in glacial movements since Miocene times ("Remarks on Flora of Australian Alps," *Southern Science Record*, 885, p. 93), provided geological evidences which would lend support to the hypothesis could be obtained; for, as remarked by the ex-President of the Linnean Society, Mr. Wilkinson, F.G.S., F.L.S., in one of his admirable addresses to the Society (President's Address, *Linne. Soc. N.S.W.*, vol. ix., p. 1236), the existence of a semi-tropic flora in South-East Australia during Miocene times and its subsequent banishment from this region is evidence of a great change of climate in Post-Pliocene times.

In a paper which I have in preparation on the geographic range of the flora of the Australian Alps, it will be shown that many species found there between 2000 and 5000 feet have a wide range, recent researches on the flora of Morocco in Africa, and on that of Kurum Valley, Afghanistan, having disclosed the presence of numerous species of plants common to the Australian Alps; and as Sir Joseph Hooker remarked many years since in his splendid essay on the flora of Australia, "if it is complete evidence of such a proportionately cooled state of the intertropical regions were forthcoming as there is of a glacial condition of the temperate zones, it would amply suffice to account for the presence of European and Arctic species in the Antarctic and south temperate regions of both hemispheres on the mountains of intermediate tropical latitudes."

As early as 1882 I discovered many examples of what appeared to be glaciated surfaces in the higher regions of the Australian Alps, notwithstanding that in some areas there were strong evidences of powerful sub-aerial denudation and erosion having taken place during Pleistocene times. *En passant*, I may mention that these apparently glaciated surfaces were seen on the quartz porphyries of Mount Cobboras at elevations between 1000 and 6000 feet; on the metamorphic rocks of Mount Pilot on the Pilot River Valley, down to 3000 feet; and on the granitic rocks of Mount Kosciusko, recently photographed by Dr. von Lendenfeld. Partly, however, from inexperience of glaciated surfaces elsewhere, I hesitated to pronounce authoritatively on them as glacier evidences until further opportunities were afforded me of discovering moraines and erratics at the lower levels. From the fact that my friend, Mr. A. W. Howitt, F.G.S., had not observed any appearances which he could in any way refer to a glacial period analogous with that of the northern hemisphere, unless (as he further remarks) the old lake basins near Omego might suggest the action of ice ("Geology of North Gippsland," *Q. J. G. S. Lond.*, vol. xxxv. p. 35), I thought it very probable that any pre-existing evidences at the lower levels might have been scoured away by a subsequent pluvial period. "On a Geological Sketch Section through the Australian Alps," *Trans. Roy. Soc. S.A.*, 1884).

The publication by my friend, Mr. G. S. Griffiths, of a paper on evidences of a glacial epoch in Victoria during Post-Miocene times (*Trans. Roy. Soc. Vict.*, 1884), induced me to re-examine the evidences at the higher altitudes, and to endeavour to follow the traces to lower levels in the Indi and Mitta Mitta Valleys, with the result that I felt justified in making the announcement previously referred to on December 11, 1884, even though some of the phenomena therein ascribed to glacier action might be found on closer scrutiny to have been produced by other causes. The indications taken as a whole were sufficient in my opinion to justify the hypothesis of glaciation, for on no other conceivable theory, as it appeared to me, could the facts as a whole be accounted for; while refrigeration of the area, and the consequent production of glaciers in the valleys of the Australian Alps over wide areas, would harmonise with conclusions deducible from an examination of the flora and fauna. In the beginning of January 1885, Dr. von Lendenfeld ascended Mount Kosciusko and photographed some glaciated surfaces. From the absence of any reference to my previous announcements save a mere reference from the *Southern Science Record* to the snow patches at the higher regions of the Australian Alps, I inferred that Dr. von Lendenfeld was unaware of my previous writings and discoveries, or he would not have stated in his interesting paper "On the Glacial Period in Australia," read before the Linnean Society of N.S.W. during January 1885, that the glacial area was limited to 100 square miles above 5800 feet altitude. On July 9 I published in the *Transactions* of the Royal Society of Victoria the first of an intended series of papers "On the Evidences of Glaciation in the Australian Alps," detailing certain phenomena in the Livingstone Creek and Victoria River Valleys. During the same month a

paper, by Captain, now Professor, Hutton, F.G.S., of New Zealand, was read before the Linnean Society of N.S.W., "On the Supposed Glacial Epoch in Australia," being in part a reply to Dr. von Lendenfeld's previous writings concerning a very recent glacier epoch in the southern hemisphere, based upon New Zealand experiences and explorations, and partly an endeavour to show that the *roches moutonnées* and smoothed surfaces on Mount Kosciusko by no means imply, or, to use the actual words of the learned Professor, "it by no means follows, that they were caused by a glacial epoch, because they might equally well be due to greater elevation, combined with greater atmospheric moisture. We are also advised to distrust an attempt to explain an *isolated phenomenon* by means of a wide-spread cause." Now it appears to me that Captain Hutton would not have assumed the isolation of the phenomena if he had been fully acquainted with the literature of the subject, and especially my announcement previously referred to. I do not propose to join issue with him in respect to the distinction he seeks to draw between a "glacier epoch" and a "glacial epoch," but merely to show that the phenomena of glaciation are not so isolated as his remarks would lead one to suppose he believes them to be. I am led to make these remarks because as a student of physiography I feel very much indebted to Prof. Hutton for the valuable information supplied by his writings concerning the geological structure, flora, fauna, and climatology of New Zealand, and I should be sorry to know that he laboured under any misapprehension as to the nature and extent of the evidences of glaciation in the Australian Alps. Following the publication of the papers of myself and Prof. Hutton we have one by Prof. Tate, F.G.S., of South Australia ("On Post-Miocene Climate in South Australia," *Trans. Roy. Soc. S.A.*, 1885), read before the Royal Society of that colony, in which are stated very clearly the evidences in favour of a glacial period in South Australia. The objections by Mr. Scoullar, Cor. Mem., as to the origin of the glaciated surfaces near Adelaide, viz. that they were caused "by the attrition of blown sand," are also controverted. I have seen some photographs of these glaciated surfaces (sent to me for inspection by Prof. Tate), and they resemble very strongly the glaciated surfaces on Mounts Cobboras and Bogong, to be hereinafter referred to. Dr. von Lendenfeld has also seen some photographs of polished rocks from South Australia, and has no doubt as to the glacier origin of the polishing ("Note on the Glacial Period in Australia," *Proc. Linne. Soc. N.S.W.*, vol. x. p. 330), although he doubts whether the striæ referred to are isochronal with the glacial traces he discovered on Mount Kosciusko. In consequence of a very interesting correspondence on the subject of glacier evidences between Dr. von Lendenfeld and myself, it was arranged that we should make a joint trip to the highest mountain in Victoria, Mount Bogong, and, if time and circumstances permitted, explore the Bogong High Plains to the south, and proceed thence along the main dividing range towards Mount Kosciusko, so that his extensive European Alpine experience and my local geological knowledge might be utilised, and the features discussed on the ground. On January 3, 1886, we met at Snowy Creek junction, a tributary of the Mitta, and on the following three days made the ascent of Mount Bogong from the north, an arduous journey, but still of great interest. Dr. von Lendenfeld has already described our journey in the publications of the Mining Department of Victoria (Mining Registrar's Returns for Quarter ended March), so that it is unnecessary for me to repeat the narrative. Suffice it to say that the evidences of glaciation discovered by us are:—

- (1) Erratics in the Reewa River and Snowy Creek Valleys.
- (2) *Blocs perches* and smoothed surfaces on Mount Bogong.
- (3) Moraines at base of Mount Bogong, Mountain Creek in Reewa River Valley.

The first-named are abundant in the Pleistocene drifts at Snowy Creek, consisting of huge basaltic boulders, &c., in linear extension for miles, as at Granite Flat; the nearest basaltic outliers being fully twenty miles distant on Bogong High Plains, &c.

The second, or what I have called *blocs perches*, are large semi-rounded or sub-angular masses of igneous or rather plutonic rock—hornblende porphyrites—occupying the crests of spurs and sidelings in a regular descending series from near the summit of Mount Bogong, 6508 feet, towards the Reewa Valley, many of them resting upon smoothed surfaces of pegmatite at lower levels. (Mount Bogong is gneissic.)

The last-named are huge masses of angular and sub-angular

rocks at the base of Mount Bogong, pronounced by Dr. von Lendenfeld to be undoubted moraines (at an elevation of 1000 feet above sea-level). I may remark that these masses are too extensive and distant from the steep spurs of Mount Bogong to be considered as *talus*; besides which they show evidences of translocation.

I do not purpose entering into a description of further evidences discovered by myself in the Mitta Mitta Valley, at Lake Omeo, or Benambia Creek, &c., in the present paper. There will in due course be communicated a second article on the evidences of glaciation in the Australian Alps, together with a reply to later criticisms. I merely desire to show that the evidences discovered on Mount Kosciusko by Dr. von Lendenfeld are by no means isolated, and that the highest mountain in Victoria, Mount Bogong, presents features which confirm the evidences of glaciation elsewhere, and that there is no *a priori* impossibility of the area of glaciation being more extensive than has been assumed. In conclusion, I would add that taking into consideration the facts supplied to us by the examination of the ancient flora and fauna of Australia as contained in the writings of Prof. Tate, of South Australia, and of Mr. Wilkinson, F.G.S., of New South Wales, and the geological evidences of glaciation over widespread areas daily accumulating, it is difficult indeed to resist the conviction that Southern Australia, as well as South America and Southern Africa, and indeed New Zealand, all participated in a period of refrigeration, culminating in an ice-clad region during later Pliocene or Pleistocene times, notwithstanding that many difficulties suggest themselves in endeavouring to work out the problem from mere localised observations.

SORGHUM SUGAR

SOME months ago considerable interest was excited by a report by Mr. Victor Drummond on the production of sugar from sorghum and maize. The report was sent from the Colonial Office to Mr. Thiselton Dyer, with a request that he would state his opinion on the questions raised by Mr. Drummond. For several years the importance of the subject had been recognised at Kew; and in his reply, dated August 10, 1886, Mr. Thiselton Dyer expressed his belief that if sugar could be produced at a cheap rate from sorghum and maize it would entirely take the place of cane and beet sugar, the geographical range of sorghum being far more extensive than that of the sugar-cane proper or of the beet. At the same time he drew attention to the fact that the results summarised by Mr. Drummond had been for the most part derived from laboratory experiments only, and that the question whether the new industry was likely to prosper could not be determined until those results had been tested over wide areas. He also pointed out that some statements in Mr. Drummond's report were at variance with well-known facts in vegetable physiology. Mr. Thiselton Dyer therefore advised that exact information as to the position of the sorghum and maize-sugar industry in the United States should be obtained through the Foreign Office.

In accordance with this advice, copies of Mr. Drummond's report and Mr. Thiselton Dyer's letter were sent to Sir L. West. By him the matter was put into the hands of Mr. C. Hardinge; and now Mr. Hardinge's report has been published in the series of Foreign Office "Reports on Subjects of General and Commercial Interest." The sorghum-sugar industry has hitherto been conducted on a small scale. In 1884 it was carried on at eight factories, which produced 1,000,000 lbs. in all. The comparative insignificance of this result will be seen when it is stated that in 1885 the quantity of cane-sugar consumed in the United States was 1,170,000 tons. In most cases it was found that the cost of extracting sugar from sorghum exceeded receipts, and at the present time the industry is prosecuted at only two factories—that of the Rio Grande Company and that of the Franklin Sugar Company, whose works have been removed from Ottawa to Fort Scott.

Dr. Wiley, by whom the subject has been thoroughly investigated, attributes the failure of the industry, so far, chiefly to the following causes:—

(1) The difficulties inherent in the plant have been constantly under-valued. By taking the mean of several seasons as a basis of computation, it can now be said that the juices of sorghum, as they come from the mill, do not contain over 10 per cent. of sucrose, while the percentage of other solids in solution is at least 4, thus rendering the working of such a juice one of extreme difficulty.

(2) The chemistry of the process is at present hardly known, and great development is necessary in this direction.

(3) The area of land where the climate and soil are best adapted for the cultivation of sorghum is not nearly so extensive as was at first imagined, and investigation should be made in order to discover in which localities the necessary conditions are most favourable.

(4) Commercial depression and the consequent low prices have affected this industry, and caused failure and losses in cases where all other conditions were favourable.

(5) Lastly, the mechanical treatment of the juice is very imperfect, the machinery used in the mills being quite inefficient for the purposes intended.

In order that the last-mentioned defect might be corrected, the Commissioner of Agriculture decided that experiments for the application of the process of diffusion on a practical scale should be carried on with the best machinery possible, and the direction of the experiments was intrusted to Dr. Wiley. He erected the battery and necessary buildings in connection with the works of the Franklin Sugar Company at Ottawa, Kansas, and the first trial of the process of diffusion was made on October 8, 1885. The general results of the experiments of 1885 show that:—

(1) By the process of diffusion 98 per cent. of the sugar in the cane was extracted, and the yield was fully double that obtained in the ordinary way.

(2) The difficulties to be overcome in the application of diffusion are purely mechanical, and by enlarging the diffusion-cells to a capacity of 130 cubic feet, and by making a few changes in the apparatus, it would be possible to work 120 tons per diem.

(3) The process of carbonatation for the purification of the juice is the only method which will give a limpid juice with a minimum of waste and a maximum of purity.

(4) By a proper combination of diffusion and carbonatation, 95 per cent. of the sugar in the cane can be placed on the market, either as dry sugar or molasses.

When his experiments were ended, Dr. Wiley was instructed by the Commissioner of Agriculture to proceed to Europe for the purpose of inspecting and purchasing such forms of machinery as might appear most useful, also to gain such information as might secure the greatest success in this work; and Mr. Hardinge reports that much useful information, chiefly of a mechanical nature, was obtained by Dr. Wiley during the course of his visits to several of the most important sugar factories in France, Germany, and Spain.

During the season of 1886 further experiments have been carried on at Fort Scott, under the direction of the Department of Agriculture, and the results have not proved to be as satisfactory as was anticipated.

ON THE CUTTING OF POLARISING PRISMS¹

THE author showed the manner of cutting two new polarising prisms, designed by Ahrens and by himself, and described and figured in the *Phil. Mag.* for June 1886. The Ahrens polariser is a rectangular parallelepipedon of calc-spar having square end-faces, and having its long sides in the proportion of about 1.6 : 1 relatively to the short sides. The square end-faces are principal planes of section of the crystal. Two oblique sections are cut in the prism, being carried through the top and bottom edges of one end-face, and meeting in the horizontal middle line of the others. The dihedral angle between these planes of section is about 32°. The faces are polished and reunited with Canada balsam in the usual way. The advantages claimed for the new prism are: (1) decrease in length, (2) increase in angular aperture, (3) saving of light consequent on non-obliquity of end-faces, (4) minimum of distortion, (5) less spar required than in Hartnack, Glan, or Thompson prisms of same section. Against this are the slight disadvantages of (1) the line of section across end-face, and (2) the use of more spar than a Nicol of equal section. But Mr. Ahrens has recently added a thin covering-glass at the end-face crossed by the line of section, thereby making this line almost imperceptible; and he has also succeeded in finding a new method of cutting the prism in which there is extremely little waste of spar. The other prism designed by the author is a simple modification of the Nicol, giving a wider angle of field. A wedge is cut off

¹ Abstract of a Paper read at Association, by Prof. Silveanus P.

each end of the calc crystal so as to make the new end-faces almost co-planar with a principal plane of section, and the crystal is cut through along the other diagonal of the sides. The results may be tabulated thus:—

	Ordinary Nicol	Reversed shortened Nicol
Obliquity of end-face	71	69
Angle between end-face and crystallographic axis	45	5
Angle between balsam-film and crystallographic axis	45	94

The effect is to throw the blue-iris limit right back, to shorten the prism, and to widen the field. In the discussion that followed, Prof. Stokes remarked that there was no dearth of Iceland spar in Iceland, but that the supply had been limited through ignorance of the extent of the demand. The mine had, however, been bought by the Icelandic Government, and a plentiful supply might therefore be expected.

THE SYMPATHETIC NERVOUS SYSTEM¹

THE lecturer commenced by giving a short sketch of Bichat's views of the division of life into organic and animal life, and pointed out how that division naturally led to the conception of two separate central nervous systems, the one, the sympathetic, to which all the organic functions are to be referred, the other, the cerebro-spinal, regulating the animal functions. He then pointed out how Remak's discovery of a special kind of nerve-fibre—the non-medullated nerves—associated only with the ganglia of the sympathetic system, tended strongly to confirm Bichat's teaching of the existence of two separate central nervous systems in the human body, each of which communicated with the other by means of its own special kind of nerve-fibres; the cerebro-spinal supplying the sympathetic system with white medullated fibres, and the sympathetic supplying the cerebro-spinal with gray or gelatinous non-medullated fibres. He then continued as follows:—

Even at the present day the teaching of Bichat still very largely holds its ground. It is true that the tendency of modern physiology is to increase the number of centres of action for the organic nerves, which exist in the cerebro-spinal central axis, and therefore to do away with the necessity for a separate independent sympathetic nervous system, yet the automatic actions of isolated organs such as the heart, and the existence of special nerve-fibres in connection with this system, still induce the neurologists of the present day to place the sympathetic nervous system on an equality with the brain or spinal cord. In this lecture to-night I hope to give the death-blow to Bichat's teaching, and to prove to you that the whole sympathetic system is nothing more than an outflow of visceral nerves from certain nerve-centres in the cerebro-spinal system, the ganglia of which are not confined to one fixed position, as is the case with the ganglia of the posterior roots, but have travelled further away from the central axis.

I do not propose to-night to deal with the argument for the independence of the sympathetic nervous system, which is based upon the automatism of such isolated organs as the heart; I have already in various papers given the reasons and arguments why I look upon such automatic movements as due to the automatism of the cardiac muscular tissue rather than to any action of nerve-cells comparable to the nerve-centres of the spinal cord; I shall deal entirely with the anatomical argument, and show you step by step how the nerve-fibres which constitute the sympathetic system can be traced to their origin in the central cerebro-spinal axis.

Evidently, in endeavouring to determine by anatomical means whether the sympathetic and cerebro-spinal systems are in reality independent of one another, our attention must necessarily be especially concentrated upon the nature of the connecting-link between the two systems, *i.e.* upon the nature of the rami communicantes. Largely owing to the pre-conceived notions of anatomists, you will find that the rami communicantes are arranged symmetrically in connection with all the spinal nerves of the body. In reality this is far from being the case; the rami communicantes of the thoracic nerves differ from those above them, *i.e.* of the cervical nerves, and from those below them,

i.e. of the lumbar nerves, in two important particulars: in the first place the corresponding sympathetic ganglion is connected with each thoracic nerve by two rami communicantes; and secondly, these two rami differ in colour, one being gray, *i.e.* composed almost entirely of non-medullated nerves, and the other white, *i.e.* composed essentially of medullated nerve-fibres.

This double nature of the ramus communicans is confined to the region lying between the two large plexuses which supply the anterior and posterior extremities, *viz.* the brachial, lumbar, and sciatic plexuses; the rami communicantes to the lower cervical and first thoracic nerves, as well as those to the nerves forming the anterior crural and the sciatic, are, on the other hand, single, and are composed only of gray rami. In other words, the sympathetic chain is connected with the central nervous system by means of white rami communicantes only between the second thoracic and second lumbar nerves.

Further, I have been able to trace both the white and gray rami in their journey to the spinal cord by means of consecutive sections of osmic acid preparations, and have found that the gray rami pass out of the sympathetic ganglion as a single nerve, and then ramify in the connective tissue about the vertebral foramina, a portion only reaching the spinal nerve-trunk; the gray fibres of this portion pass mainly along the nerve peripherally, the few which pass centrally never reach the spinal cord, but pass out with the connective tissue which lies in between the medullated nerve-fibres of the anterior and posterior roots, to ramify over and to supply the blood-vessels of the various membranes which inclose the spinal cord.

In fact the gray rami communicantes are peripheral nerves, which partly supply the vertebræ and the membranes of the cord, and partly pass to their destination in the same direction as the efferent fibres of the spinal nerve itself.

So far then I come to these conclusions:—

(1) The sympathetic does not send non-medullated fibres into the cerebro-spinal system, because these fibres all pass out of the nerve-roots before they reach the spinal cord.

(2) White or medullated nerve-fibres constitute the only link between the sympathetic and cerebro-spinal systems, constituting the white rami communicantes.

(3) Consequently the connection between these two nervous systems is limited to the region of white rami communicantes, *i.e.* to the region between the second thoracic and second lumbar nerves.

Further, these conclusions are borne out when we attempt to follow the white rami communicantes into the central spinal axis by means of their structural peculiarities; sections of osmic preparations show that each white ramus is composed chiefly of very small medullated nerve-fibres, varying in size from 1.8μ to 3.6μ , very much smaller, therefore, than the large medullated nerves which form the bulk of the anterior roots of the spinal nerves, these latter varying between 14μ to 20μ or even larger. Clearly then the fibres of the white ramus communicans ought to show very conspicuously among the large fibres of the anterior roots whenever they are present in those roots. I have cut sections of the anterior roots of all the spinal nerves in the dog, and have found, as I show you on this screen, that these very fine medullated nerve-fibres make their appearance for the first time in the anterior roots of the second thoracic nerve; they are found in large quantities in all the anterior roots between the second thoracic and second lumbar, and then again the anterior roots immediately below the second lumbar are free from such groups of very fine fibres. We see then that exactly corresponding to the presence of white rami communicantes in the thoracic region we find groups of characteristic fine medullated fibres existing in the anterior roots, fibres which clearly form part of the white ramus communicans, and confirm by their presence the conclusion already arrived at, *viz.* that the nerves which pass from the spinal cord into the sympathetic system are limited to the thoracic region of the cord.

We can now go a step further and argue in the reverse direction that the presence of groups of these very fine medullated fibres in the anterior roots of any nerve implies the existence of nerve-fibres belonging to the same system as the white rami communicantes or rami viscerales, as we may now call them. Examination shows how just is this argument, for I find that the same groups of fine nerve-fibres suddenly appear again in the anterior roots of the second and third sacral nerves, and can be traced into that well-known nerve which passes from the second and third sacral nerves into the hypogastric plexus to

¹ Abstract of Lecture at the Royal Institution on June 4, 1886, by Walter H. Caskell, M.D., M.A., F.R.S.

supply the rectum, bladder, and reproductive organs; a nerve, therefore, which may be looked upon as the white ramus communicans of the sympathetic ganglia which form the hypogastric plexus.

Again, in the cervical region, although such groups of fine fibres are absent from the anterior roots of all the cervical nerves, yet they form a conspicuous part of the upper roots of the spinal accessory nerve, and upon tracing them outwards I find that they separate entirely from the large fibres of the accessory which form its external branch to pass as the internal branch into the ganglion trunci vagi (Fig. 2). Here, then, we see in the upper cervical region that the internal branch of the spinal accessory nerve is formed on the same plan as a white ramus communicans, the ganglion belonging to which is the ganglion trunci vagi.

Among the cranial nerves we find, especially in the vagus, glosso-pharyngeal, and chorda tympani, groups of fine nerve-fibres belonging to the same system. We can therefore say that the communication between the so-called sympathetic and cerebro-spinal systems is not symmetrical throughout, but consists of three distinct outflows of characteristic visceral nerves, viz.: (1) cervico-cranial; (2) thoracic; (3) sacral; the break of continuity corresponding to the exit of the nerve plexuses which supply the upper and lower extremities.

These medullated visceral nerves then pass out from the central nervous system into the various ganglia of the sympathetic, and it is possible that these latter ganglia bear the same kind of relation to them as the ganglia on the posterior roots bear to the sensory nerves. Before, however, we can accept this view, it is absolutely necessary to account for the non-

medullated nerves which arise from the sympathetic ganglia. Now it is hopeless to follow, by anatomical means, any special nerve-fibre through the confusion of a ganglion. What we cannot effect by anatomical methods we can by physiological. If we find two nerves, one of which enters a ganglion and the other leaves it, and we find their function absolutely the same on both sides of the ganglion, we have a perfect right to conclude that we are dealing with the same nerve in different parts of its course. Thus, in the case of the posterior root ganglion, the same sensory nerves are found on each side of the ganglion, although they are in connection with nerve-cells of the ganglion itself.

So also with the sympathetic ganglia: we know, for instance, that the nerves which increase the rate and strength of the heart's beat pass to the ganglion stellatum along the rami communicantes of the second and following thoracic nerves, and we know also that the same nerves pass to the heart from the ganglion stellatum, from the annulus of Vieussens, and from the inferior cervical ganglion. Now, seeing that these nerves are known to pass out of the cord in anterior roots, and from thence into the white rami communicantes of the upper thoracic nerves, it follows that they are medullated in this part of their course, and are to be found among the bundles of very fine medullated nerves which we have seen are characteristic of the anterior roots of this region and of the white rami communicantes.

We can then say with certainty that the accelerator nerves enter the ganglia stellata as fine white medullated nerves. I am also able to say with absolute certainty that the accelerator nerves in that part of their course which lies between the chain of sympathetic ganglia and the heart are entirely composed of

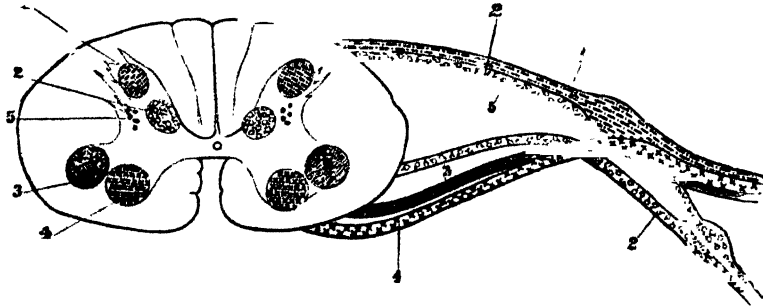

FIG. 1.—Diagram of section of spinal cord to show the various groups of nerve-cells in the gray matter, and the formation of a spinal nerve with its sympathetic ganglion. 1, cells of posterior horn and somatic sensory nerves. 2, cells of Clarke's column and ganglionated splanchnic nerves. 3, cells of lateral horn and non-ganglionated splanchnic nerves. 4, cells of anterior horn and somatic motor nerves. 5, solitary cells of posterior horn and splanchnic sensory nerves.

non-medullated fibres. I know no other bundle of nerve-fibres which is so absolutely free from medullated nerves: in other words, nerve-fibres of the same function enter a sympathetic ganglion as white medullated fibres, and leave it in increased numbers as gray non-medullated nerves.

Throughout we find the same fact—all the vasomotor nerves behave in exactly the same manner as the accelerators of the heart. In all cases the non-medullated fibres of the sympathetic are simply the fine medullated visceral nerves which have passed from the spinal cord in one or other of the three visceral outflows and lost their medullary sheath in their passage through the ganglia of the sympathetic system; together with that loss of medulla they have increased in number by division.

Seeing, then, that the non-medullated (so-called sympathetic) nerve-fibres are throughout modified medullated (so-called cerebro-spinal) fibres, and do not, therefore, arise in the sympathetic ganglia, we may fairly look upon the sympathetic ganglia as bearing the same kind of relation to the visceral nerves that the ganglia of the posterior roots bear to the ordinary sensory nerves. This conception is remarkably confirmed by the observations of Onodi, who has shown that the ganglia of the sympathetic are developed in close connection with the posterior root ganglia, and travel further away from the central axis as the animal grows.

Finally, the meaning of the sympathetic as a simple outflow of ganglionated visceral nerves from certain portions of the spinal cord and medulla oblongata is, to my mind, conclusively settled by the intimate relationship which exists between the structure of the spinal cord and the presence or absence of rami viscerales. In the gray matter of the spinal cord we find, as

shown in the accompanying diagram, certain well-defined groups of nerve-cells, viz., *a*, a group of large nerve-cells in the anterior horn (4 in Fig. 1); these are known to be the origin of ordinary motor-fibres (4); *b*, a group of nerve-cells (3) split off from this and forming the lateral horn; *c*, a group (2) known as Clarke's column; and *d* and *e*, two sets of nerve-cells, (4) and (5), in the posterior horn connected with sensory nerves. All these groups of nerve-cells are found along the whole length of the spinal cord, except those of Clarke's column. Their connection with nerve-fibres of different functions is known, except those of Clarke's column. Thus both sets in the anterior horn are connected with ordinary motor-nerves; both sets in the posterior horn with ordinary sensory nerves. Now, Clarke's column is limited to certain definite regions of the cord, being conspicuous: firstly, between the second thoracic and second lumbar nerves; secondly, at the top of the cervical region and extending into the cranial region; and, thirdly, an isolated patch in the sacral region. In other words, its cells correspond exactly in position to the distribution of the white rami communicantes, so that, corresponding to the variation of this cell-group, we find variations of the number of very fine medullated fibres in the anterior roots, and we find corresponding variations in the white rami communicantes, which latter, as I have told you, are the only true connections of the cerebro-spinal nerve-centre with the sympathetic. In other words, we have driven home to their origin these visceral nerve-fibres, and we find that they do not arise from any nerve-cells outside the brain and spinal cord, but from a definite nerve-group within the spinal cord.

We can, I think, go further than this, and say, with Bichat,

that two nerve-systems do exist—the one for organic, and the other for animal, life. These two, however, are not separate and distinct, but form parts of the same central nervous system. Looking at this diagram of the upper cervical region of the cord, we see that the voluntary striped muscles may be divided into two groups, according to their nerve-supply, viz. a group supplied by the anterior (4), and one by the lateral horn of nerve-cells (3), and we know also that these two groups of nerve-cells separate from one another more and more as we pass into the brain region. So that we find for the muscles of the face a distinct separation of two groups, viz. (1) those which move the eyes and the tongue—these are supplied by nerves which arise from the continuation of the anterior horns; and (2) the muscles of expression and mastication, the nerves of which arise from the continuation of the lateral horn; and remembering how the smile, the laugh, and the snarl, as well as the action of swallow-

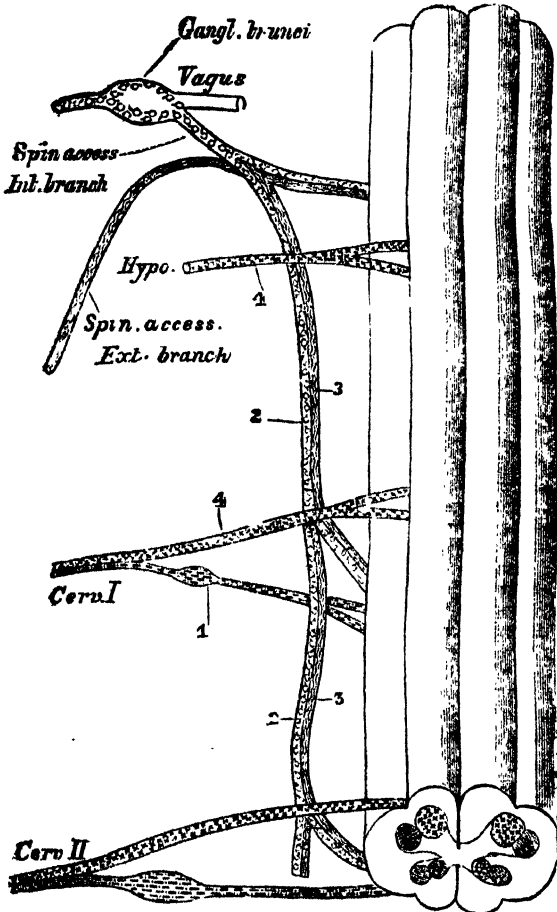

FIG. 2.

ing, are at the bottom only modified respiratory movements, we see that Charles Bell was not so far wrong when he inserted a lateral or respiratory system of nerves in between the anterior and posterior roots. This insertion is actually to be seen at the upper part of the cervical cord (Fig. 2) where a separate nerve is formed by elements which arise laterally, known as the spinal accessory; and what is most striking is this fact, that in this region the fine medullated fibres (2 in Fig.) are found only in connection with these lateral motor nerves, and not with the anterior motor, so that not only do these lateral or respiratory tracts supply special muscles with motor nerves, but these motor nerves have a closer relationship to the visceral nerves than other motor nerves. What is true of the upper cervical region is true also of the medulla oblongata. Here, again, the visceral fine medullated nerves are closely connected with the motor fibres which arise from the lateral horn, e.g. the chorda tympani and the facial. Undoubtedly this particular group of muscles has some closer relationship to the viscera than other trunk muscles,

and that relationship is explained immediately if we can accept and extend van Wijhe's investigations, viz. that in the cranial region the muscles which are supplied by the third, fourth, sixth, and twelfth cranial nerves are derived from the myotomes, while the muscles supplied by the seventh and fifth cranial nerves are derived from the lateral plates of mesoblast.

In fact we may look upon the body as composed of two parts—an outside or somatic part, and an inside or splanchnic part. Each part has its own system of voluntary muscles; each part is supplied by nerves arranged on the same plan, viz. a ganglionated and non-ganglionated portion; and each part has its own individual centres of action, the inside portion of the gray matter of the spinal cord containing the centres for the splanchnic roots (2, 3, 5, in Fig. 1), i.e. the centres of organic life; the outlying horns the centres for the somatic roots (1 and 4), i.e. centres for the animal life. It is a strange and suggestive fact that these two sets of centres are not arranged symmetrically along the spinal axis, but that two great breaks occur in which the centres of organic life fall into the background in comparison to those of animal life. These two great breaks correspond to the origin of the nerves for the legs and arms, and suggest that the formation of the limbs in the originally symmetrical ancestor of the Vertebrata—i.e. the large outgrowth of somatic elements in two definite portions of the body—caused of necessity a corresponding increase in the centres for animal life, while there was no necessity for a corresponding increase in the centres for organic life. The oldest part of us is undoubtedly the vital part; those organs and their nervous system by which the mere act of existence is carried on. With these two there may have been originally a symmetrically segmental arrangement of locomotor organs. Such symmetry, however, went for good when it was found more convenient to concentrate the locomotor machinery into the anterior and posterior extremities, and with the asymmetrical arrangement of the locomotor organs disappeared also the symmetry of the central nervous system. This correspondence between the plan of the central nervous system and the development of the extremities is, to my mind, strongly in favour of the view which I have put before you to-night. In conclusion, I thank you for the kindness with which you have listened to me, and hope that I have succeeded in convincing you that Bichat's teaching of an independent sympathetic system is finally dead.

SCIENTIFIC SERIALS

Revue d'Anthropologie, troisième série, tome I, 1886, Paris. —On the colour of the eyes and hair in different parts of France, by M. Topinard. This paper will form the introduction to a comprehensive work, in which the author proposes to consider the various methods followed in other countries in collecting the necessary data for determining the racial significance of these physical characteristics. In France, where good charts of stature have been drawn up for the several departments, no statistical observations have been made in regard to the colour of the skin, eyes, and hair. This M. Topinard considers at length, both in its significance as a racial characteristic, and in regard to the modifications which it undergoes at various ages, and from different local surroundings. In considering the more or less typical series of colour, the writer draws attention to the extreme rarity in Europe of greenish eyes. In Germany, Prof. Virchow states that, among 6,000,000 persons, green eyes were noted only in six cases. Chinese annals record, however, that green eyes are met with in parts of Asia; and Pallas notes a similar fact in regard to Siberia. In concluding his exhaustive résumé of what has been done in other countries, M. Topinard states that he has addressed letters to the members of the French Association for the Promotion of Science, begging their co-operation in the collection of the necessary data for drawing up statistical tables of the relative proportion of the different shades of colour of the eyes and hair in various parts of France.—Illyrian anthropology, by Dr. R. Zampa. The author, who is well known for his able contributions to the ethnography of Italy, has turned his attention to the anthropological character of the Illyrian races, who occupied the South Danubian and other eastern trans-Alpine lands, to which tradition points as the original home of the earliest settlers of the Adriatic provinces of central and lower Italy. Dr. Zampa denies that the Illyrians were ever a homogeneous race, and he points out that while those of the north retained through the ages the character of

savage marauders and pirates, the South Illyrians, four centuries B.C., had been thoroughly amalgamated with the Macedonian and Epirote nations, adopting the pre-Hellenic form of speech of those peoples, which still lingers in the spoken tongue of the modern Albanians. After the incursions of Finns and Slavs into the Balkan and Danube territories, in the sixth and seventh centuries, the remnant of Illyrian and other primitive races that escaped extermination were comprised under the general name of Albanians; and Dr. Zampa believes that in the mountainous districts of Scutari we find the purest representatives of the ancient Albanian race. In this region, therefore, he has sought the data necessary for the elaboration of the comparative anthropological researches of the ethnic relations and differences existing between the Italian and other branches of the Albanian peoples. The author gives at length the results of his measurements of several series of crania obtained in Dalmatia, comparing them with those taken from living subjects; and although it cannot be said that his researches decide the question whence the Albanian Italians derive their origin, they throw important light on the early history of the primitive races of the Balkan Peninsula, and on their gradual amalgamation with the numerous invaders and alien settlers who, in the course of ages, have occupied the lands of the ancient Illyrians.—On trephining, as practised in Montenegro, by M. Védreñes. The question of prehistoric trepanning, which first excited attention about ten years ago, has led to the consideration of the hitherto almost unnoticed fact that cranial trephining has been practised in Europe from the most remote ages to the present day. Indeed, according to M. Védreñes, the operation is also of frequent occurrence among the natives of Aurès, in Algiers, where it is held in high esteem as being both safe and beneficial. Here it is generally used to arrest the acute pains which are frequently experienced after severe injuries to the head; a portion of bone, about a centimetre in diameter, being cut out to admit of the introduction of a sponge for the removal of extravasated blood. A precisely similar operation is common in Montenegro, where, as at Aurès, it is performed by the members of certain families, amongst whom the profession of trephining has flourished for ages, and been respected as an hereditary distinction transmissible from father to son. The author draws attention to the curious circumstance that the practice of trephining and implicit faith in its efficacy have kept their ground, not merely in the semi-barbarous populations of Algiers and the Balkan mountain districts, but even among the miners of Cornwall, who have continued, to our own times, to regard this operation as the only adequate mode of treatment in various injuries to the head.—Contribution to the history of anomalies of the muscles, by M. Ledouble. The author considers that, while the pyramidalis abdominis, peroneus, palmaris, plantaris, and psoas parvus are more usually absent than any of the other muscles, the last-named is so frequently missing, that some writers have even assumed that its presence was abnormal. It is more frequent in women than in men; but for this peculiarity, as well as for the variations observable in the mode of insertion of psoas magnus and parvus, the author does not attempt to offer any explanation; his paper giving simply the result of his own observations of muscular anomalies in the lower animals, as well as in man.

SOCIETIES AND ACADEMIES

LONDON

Royal Society, November 25.—“On Jacobi’s Figure of Equilibrium for a Rotating Mass of Fluid.” By G. H. Darwin, M.A., LL.D., F.R.S., Fellow of Trinity College, and Plumian Professor in the University of Cambridge.

Jacobi was the first to prove that a mass of fluid in the form of an ellipsoid, with three unequal axes, is in equilibrium when rotating about the smallest of the three axes. The determination of the axes in terms of the angular velocity of the system has hitherto been left in an analytical form, not well adapted for numerical calculation. In the present paper the formulæ are brought into a shape involving elliptic integrals, and, by the aid of Legendre’s tables, a table of solutions is calculated.

If σ be the density of the fluid, ω the angular velocity, and ρ the mass, then, when $\omega^2/4\pi\sigma = .09356$, the Jacobian ellipsoid is a revolutionary figure with axes 1.1972, 1.1972, 0.6977. For smaller values of the angular velocity the first axis increases and the two latter diminish. For example, when $\omega^2/4\pi\sigma = .07047$, the axes are 1.899, 0.811, 0.694.

When the angular velocity is infinitely slow, the ellipsoid becomes infinitely long and thin, and tends to assume a figure of revolution about its greatest axis.

Although the angular velocity diminishes as the length of the ellipsoid increases, yet the moment of momentum continually increases, and becomes infinitely great when the ellipsoid is infinitely long.

The kinetic energy at first increases with the length, attains a maximum, and then diminishes, so that when the ellipsoid is infinitely long it vanishes.

The intrinsic energy, however, always increases, so that the total energy of the system has no maximum, and continually increases with the length of the ellipsoid.

Approximate formulæ are given, which assume a very succinct form when the ellipsoids are long.

December 9.—“A New Method for the Quantitative Estimation of the Micro-organisms present in the Atmosphere.” By Percy F. Frankland, Ph.D., B.Sc. (Lond.), F.C.S., F.I.C., Assoc. Roy. Sch. of Mines.

The author commences by describing some of the more important methods which have been elaborated for the bacterioscopic examination of air. In these he includes the experiments of Pasteur, Tyndall, Freudenreich and Miquel, Koch, and Hesse. After pointing out the several advantages and disadvantages which attend these processes, he describes a new method which he has devised, in which he has endeavoured to overcome some of the objections to which the others are open. The following is a brief description of the author’s method:—

A known volume of air is aspirated through a glass tube containing two sterile plugs, consisting either of glass-wool alone, glass-wool and fine glass-powder, glass-wool coated with sugar, or sugared glass-wool and fine sugar-powder. The plugs are so arranged that the first one through which the air is drawn is more pervious than the second. After a given volume of air has been aspirated, the two plugs are transferred respectively to two flasks, each containing melted sterile gelatine-peptone, which are then plugged with sterile cotton-wool stoppers. The plug is then carefully agitated with the gelatine until it has become completely disintegrated, care being taken to avoid any frothing of the gelatine; and the latter is then slowly congealed so as to form an even film over the interior surface of the flask.

On incubating these flasks at a temperature of 22° C., in the course of from four to five days the colonies derived from the organisms contained in the plugs make their appearance, and can be readily counted and further examined. A very large number of experiments are recorded which were made to test the accuracy of the “flask-method.” For this purpose experiments were made, in which sometimes single, and sometimes double plugs were employed, and it was almost invariably found that all the organisms were deposited on the first plug; the second plug, in the very exceptional cases when it did yield anything, rarely gave rise to more than a single colony.

It was also found that, whereas in out-of-door experiments a blank Hesse-tube, exposed side by side with the one through which air was being aspirated, contained a number of organisms,—thus creating an important source of error in the quantitative results obtained by Hesse’s method,—in the “flask-method” such blank tubes rarely contained any organisms; and even when such was the case, but a very small proportion of those present in the actual tube.

This shows that, whereas in Hesse’s apparatus any disturbance of the air during the experiment vitiates the accuracy of the result, in the “flask-method” no such effect is produced.

On the other hand, in the absence of aerial currents, the blank Hesse-tube contained only a few organisms, and a remarkable uniformity was found in the results obtained by Hesse’s method and that of the author. This is important, not only as showing the quantitative accuracy of the “flask-method,” but in clearly demonstrating that the organisms present in the air exist in an isolated condition, and not in aggregates, as suggested by Hesse, for it will be remembered that the plug is violently agitated with the gelatine-peptone in the flask, during which operation such aggregates would undoubtedly be broken up wholly or at least partially. It would therefore be reasonable to expect that the “flask-method” would yield a larger number, and possibly a far larger number, of colonies than found in Hesse’s tubes; but since, on the contrary, the numbers agreed under the circumstances described in so striking a manner shown convincingly that they exist in an isolated condition

The paper is illustrated by photographs and drawings.

Of the numerous experiments recorded in the paper, the following series made at St. Paul's may be specially referred to, both as treating the quantitative accuracy of the process, as well as showing how it may be employed in ascertaining the distribution of micro-organisms in the atmosphere:—

November 19, 1886		Number of micro-organisms found in 10 litres of air
St. Paul's Churchyard	...	47
Stone Gallery	No. 1	40
	No. 2	35
Golden Gallery	No. 1	10
	No. 2	11
	No. 3	11

The following are the principal advantages which the author aims for the "flask-method":—

- (1) The process possesses all the well-known advantages attaching to the use of a solid cultivating medium.
- (2) The results, as tested by the comparison of parallel experiments, can lay claim to a high degree of quantitative accuracy.
- (3) The results, as tested by control experiments, are not appreciably affected by aerial currents, which prove such a disturbing factor in the results obtained by some other methods.
- (4) The collection of an adequate sample of air occupies a very short space of time, so that a much larger volume of air can be conveniently operated upon than is the case with Hesse's method. Thus, whilst the aspiration of 10 litres of air through Hesse's apparatus takes about three-quarters of an hour, by the new method about 48 litres can be drawn through the tube in the same time; whilst a better plan is to take two tubes and alternately draw a definite volume of air through each, as by this means duplicate results are obtained.
- (5) As the whole plug upon which the organisms from a given volume of air are deposited is submitted to cultivation without subdivision, no error is introduced through the multiplication of results obtained from aliquot parts, and all the great difficulties attending equal subdivision are avoided.
- (6) The risk of aerial contamination in the process of flask-cultivation is practically nil.
- (7) The apparatus required being very simple and highly portable, the method is admirably adapted for the performance of experiments at a distance from home, and in the absence of special laboratory appliances.

"Further Experiments on the Distribution of Micro-organisms in Air (by Hesse's method)." By Percy F. Frankland, Ph.D., Sc., F.C.S., F.I.C., and T. G. Hart, A.R.S.M. The authors record a number of experiments, made with Hesse's apparatus, on the prevalence of micro-organisms in the atmosphere. The results are intended to form a supplement to those already obtained by one of the authors, and published in the last number of the Society's *Proceedings*. The greater number of the experiments have been performed on the roof of the Science Schools, South Kensington, the air of which has now been under observation at frequent intervals during the present year. The authors point out the variations, according to season, which have taken place in the number of micro-organisms present in the air collected in the above place. The average results obtained were as follows:—

1886	Average number of micro-organisms found in 10 litres of air by Hesse's method
January	4
March	26
May	31
June	54
July	63
August	105
September	43
October	35

Experiments are also recorded showing the enormous increase in the number of micro-organisms present in the air of rooms consequent on crowding. In illustration of this point the authors cite a series of experiments made in the library of the Royal Society during the evening of the *conversazione* in June 1886, when the following results were obtained:—

Royal Society's Library	Number of micro-organisms found in 10 litres of air
June 9, 1886, 9.20 p.m.	326
" " " " 10.5 " "	432
June 10, 1886, 10.15 a.m.	130

In addition to determining the number of organisms present in a given volume of air, the authors have also, in each case, roughly estimated the number falling on a given horizontal surface by exposing dishes filled with nutrient gelatine and of known superficial area, as in the experiments previously published.

Society of Antiquaries, December 9.—Dr. John Evans, President, in the chair.—Mr. J. Allen Brown, F.G.S., F.R.G.S., read a paper on his discovery of a Palaeolithic workshop floor of the Drift period near Ealing. He pointed out that the discovery of this Palaeolithic working site fully confirmed his previous observations of the higher river-drift deposits in North-West Middlesex, *i.e.* that such old floors or former land surfaces are often discernible therein, and that such habitable spots have been preserved in different parts of the Thames Valley, though they have frequently been disturbed, removed, and re-deposited in other places by the changing course and curves of the wider river of the past, and by floods and other conditions of the severer climate which then prevailed. This Palaeolithic workshop floor, which is about 100 feet above the present bed of the Thames, and about two miles distant from it, is situated near the junction between the Creffield Road and Mason's Green Road, Acton; the floor is here about 6 feet from the surface, with a steeper slope to the river than the present surface; it is covered to this extent with sand, brick earth, and trail deposits. At this site, on an area of about 40 feet square, were found nearly 600 unabraded worked flints, including long spear or javelin heads from 5 to 6 inches long, neatly trimmed to a point, and of the same form as those of obsidian, &c., now employed by the natives of New Caledonia, the Admiralty Islands, and Australia, for insertion into the shafts of their spears, to which they were fixed by lashings, &c. There were also shorter ones, not only wrought along the sides to the point where the flake required trimming, but also neatly chipped at the butts into rough rudimentary tangs. Such spear-heads have not only been described by Messrs. Lartet and Christy from the cave of Le Moustier, in the Dordogne, but have been met with in the alluvial deposits of the Somme at Abbeville, the Seine, and other French rivers, as well as by Dr. J. Evans, from Mildenhall, &c. Roughly wrought hatchets, axes, or choppers formed from flakes chipped on one or both faces to a cutting edge were also found rather abundantly on the floor. They are probably some of the earliest rude celt forms, and have been found also in other gravel deposits of the district. At the Creffield Road site they were discovered both finished and unfinished, and correspond with similar tools described by Dr. Evans from the high-level deposits at High Lodge, Mildenhall, Saaton Downham, and Fisherton, near Salisbury, &c., as well as in the high-level Quaternary drift at Sauvigny (Loire) described by Dr. H. Jaquinot, and in the deposits of Le Moustier (Dordogne), &c. Some of the specimens exhibited were worked on both faces and pointed, thus approaching the Saint Acheul types, which M. G. de Mortillet considers as belonging to the earliest drift series, that of the Chelléen epoch; they have also been described from other places in North-West Middlesex, as well as by Prof. Boyd-Dawkins from Wookey Hole, and by Dr. Evans from Biddenham, Bedford, Thetford, &c. Among the most interesting implements exhibited were borers, awls, or drills, some being large enough for boring wood; while others were sufficiently small for piercing bone needles, and also flints with neatly chipped symmetrical depressions, which it is believed were used as shaft-smoothers, or spokeshaves, like those lately exhibited in Mr. Dunn's collection of Bushman and Hottentot stone implements at the Colonial and Indian Exhibition. Large numbers of knives formed from flakes, often neatly worked on the edge with fine secondary work, and also saws chipped with a distinctly serrated edge, were exhibited from this site, with other tools apparently intended to be used as chisels, &c. Large numbers of waste flakes, as well as blocks of flint which had been worked upon, were also found at this spot; and in Ealing, about two miles distant, in a deposit of about the same age, a large boulder of metamorphic rock, concave on both faces and roughened and scored in the hollows from use, was met with; it is 7½ inches long; and a quartzite boulder which fits the hollows was found near it, in fine gravel. They are the first pounding-stones discovered in the drift deposits. The author—after describing the various typical forms of the flint implements from the river-drift deposits of Ealing, Acton, Hanwell, Dawley, &c., in his large collection, and their respective ages, as deduced from the position or layer at which they have been found, as well as their condition,

whether abraded or unrolled, with other surface features of the specimens—showed that the flint implements from the Thames Valley may be divided into three groups, decreasing in age from the highest beds of drift to those lower in the valley as the process of erosion and part infilling of the valley continued. The implements and flakes found at the Creffield Road working site, which are as sharp and unabraded as on the day they were struck from the cores, were compared both as to their forms and associated Quaternary fauna with those from the upper drift of England and France. When considered in reference to M. G. de Mortillet's classification of four divisions—*i.e.* the Chelléen or Acheuléen, with which remains of the older Quaternary fauna, such as *E. antiquus*, *Rhinoceros hemitechus*, hippopotamus, large cave-bear, &c., are associated; the Moustierien characterised by lance-heads, chopping-tools, &c., formed, from flakes, with the later Quaternary fauna, such as the *E. primigenius*, *Rhinoceros tichorhinus*, reindeer, &c.; and the less ancient divisions of the Solutréen and Magdalénien—Mr. Allen Brown showed, from the discovery of *Rhinoceros hemitechus*, of hippopotamus, and an older form of deer, &c. (though at the mid-terrace stage of the erosion of the valley), by Colonel Lane-Fox and others, that the fabricators of the human relics discovered at the workshop site at Creffield Road lived contemporaneously with some of the older Quaternary fauna, and that they may therefore be considered as older than the epoch Moustierien, and may perhaps belong to the Chelléen period; but it is evident most of them were intended for mounting in handles or shafts, as such implements are hafted now by Australians and others, and not as "the coups de poings," or fist-strikers, of M. de Mortillet; and that, since they were made, the vast mass of matter represented now by the space between the 100-foot contour and the present bed of the Thames, two miles away, has been eroded. A large collection of objects from the workshop floor were exhibited, and many other flint implements from North-West Middlesex, illustrating the author's classification.

Geological Society, December 1.—Prof. J. W. Judd, F.R.S., President, in the chair.—Henry Howe Arnold-Bemrose, Richard Assheton, Francis Arthur Bather, Rev. Joseph Campbell, John Wesley Carr, Thomas J. G. Fleming, Thomas Forster, Edmund Johnstone Garwood, George Samuel Griffiths, Dr. Frederick Henry Hatch, Robert Tuthill Litton, Frederick William Martin, Richard D. Oldham, Forbes Rickard, Albert Charles Seward, Herbert William Vinter, and Charles D. Walcott were elected Fellows of the Society.—The President announced that he had received from Prof. Ulrich, of Dunedin, New Zealand, the announcement of a very interesting discovery which he had recently made. In the interior of the South Island of New Zealand there exists a range of mountains, composed of olivine-enstatite rocks, in places converted into serpentine. The sand of the rivers flowing from these rocks contains metallic particles, which, on analysis, prove to be an alloy of nickel and iron in the proportion of two atoms of the former metal to one of the latter. Similar particles have also been detected in the serpentines. This alloy, though new as a native terrestrial product, is identical with the substance of the Octibeha meteorite, which has been called octibehite. Prof. Ulrich has announced his intention of communicating to the Society a paper dealing with the details of this interesting discovery—which is certainly one of the most interesting that has been made since the recognition of the terrestrial origin of the Ovipak irons.—The following communications were read:—On a new genus of *Madreporaria*—*Glyphastraea*, with remarks on the *Glyphastraea forbesi*, Edw. and H., sp., from the Tertiaries of Maryland, U.S., by Prof. P. Martin Duncan, M.B., F.R.S.—On the metamorphic rocks of the Malvern Hills, part 1, by Frank Rutley, F.G.S., Lecturer on Mineralogy in the Royal School of Mines. Part 1 is the result of conclusions arrived at in the field; part 2 will be devoted to a microscopic description of the rocks. The author referred especially to the paper by the late Dr. Holl, whose work he, in the main, confirmed. Dr. Holl's object was to demonstrate that the rocks which had hitherto been treated as syenite, and supposed to form the axis of the hills, were in reality of metamorphic origin, and belonged to the pre-Cambrian. Mr. Rutley restricted his observations to the old ridge of gneissic syenite, granite, &c., which constitutes the main portion of the range, and, reversing the order of his predecessor, commenced at the north end of the chain. He considers that the beds of crystalline rock, mostly of a gneissic

character, in the old ridge have been disposed in a synclinal flexure, which stretched from the north end of the chain to the middle of Swinyard's Hill, where they receive an anticlinal flexure, and are faulted out of sight. The length of this synclinal fold would be over 5½ miles. The lithological evidence is in favour of the rocks forming the north part of Swinyard's Hill being a repetition of those on the Worcestershire Beacon. We might expect to find the older beds having the coarsest granulation, and being even devoid of foliation, and this is what occurs on the Malverns, where the northern hills are made up of the coarsest rocks, with finer schistose beds towards the south; the exception is at Swinyard's Hill; hence there are two groups of coarsely crystalline rocks at either extremity of the presumed synclinal. The contrast between these and the fine-grained rocks of the other portions of the range has already attracted attention. The most northern of the coarse-grained masses is cut off towards the south by a fault near the Wych, while the other lies between a fault on the north side of the Herefordshire Beacon and the before-mentioned fault on Swinyard's Hill. The metamorphic rocks of the Malverns seem, therefore, to be divisible into three series, extending from the North Hill to Key's End; a Lower, of coarsely crystalline gneissic rocks, granite, syenite, &c.; a Middle, of gneissic, granitic, and syenitic rocks of medium and fine texture; and an Upper, of mica-schist, finely crystalline gneiss, &c. A diagrammatic section shows the distribution of these: the northern block, extending as far as the Wych, consists of the Lower and the lower part of the Middle; the central block, from the Wych to the fault in Swinyard's Hill, consists chiefly of the Lower and upper Middle, but with a portion of the Lower at the south end; the southern block, south of the fault on Swinyard's Hill, consists wholly of the Upper series. How far the foliation of these rocks and their main divisional planes represent original stratification must, the author thought, remain an open question. It has been held that the strike of foliation lies parallel to the axes of elevation; but this is far from being the case in the Malverns. Still a once uniform strike may have been dislocated by repeated faulting. The author further discussed the general question of how far foliation may or may not coincide with planes of sedimentation. He admitted that the absolute conversion of one rock into another by a process of shearing has been shown to occur, but doubted its application in this case. Although he is inclined to believe that the divisional planes, with which the foliation appears to be parallel, may be planes of original stratification, yet, as a matter of fact, they are nothing more than structural planes of some sort, between which the rocks exhibit divers lithological characters.—On fossil chilostomatous Bryozoa from New Zealand, by Arthur Wm. Waters, F.G.S. The fossil Bryozoa described in the present paper are from the localities of Petane, Waipukurau, Wanganui, and some simply designated as from the neighbourhood of Napier. The first three represent deposits of a well-known position, which was considered Miocene by Tenison-Woods, but which Prof. Hutton (*Quart. Journ. Geol. Soc.*, vol. xli.) has more recently called Pliocene. Some others, sent over as from "Whakati," are thought to be from Waikato. The genus *Membranipora*, which is largely represented from near Napier, is not one of the most useful palæontologically, because the shape of the opesia opening only, and not the oral, is preserved, and also the appearance of the zoecia is often remarkably modified by the ovicells, which, however, are frequently wanting, and in many well-known species have never been found. The author pointed out that in the commoner and best-known species of Bryozoa the amount of variation is recognised as being very great, and considered that in the face of this there is too great a tendency to make new species on slight differences which may be local variations, and that even in some cases, instead of the description referring to a species, it may be that only a specimen has been described. A list of New Zealand Bryozoa has been drawn up by Prof. Hutton, and our knowledge of the New Zealand and Australian Bryozoa is being constantly increased by MacGillivray, Hincks, and others; nevertheless, enough is not yet known to fix the exact age by means of the Bryozoa alone, but the large number of species entirely identical with those living in the neighbouring seas, and the general character of the others, show that the deposits must certainly be considered as of comparatively recent date. Out of the seventy-eight species or varieties, sixty-one are known living, twenty-nine of these from New Zealand seas, forty-eight from either New Zealand or Australian waters, and twenty-eight have been found fossil in Australia. Judging from these alone, it would

seem that some authors have assigned too remote an age to the leposita. The new forms described were:—*Membranipora recultata*; *Monoporella capensis*, var. *dentata*, *M. waipukurensis*; *Micropora variperforata*; *Mucromella tricuspis*, var. *waipukurensis* and *minima*, *M. firmata*; *Porina grandipora*; *Lepralia similis*, var. *simplex*, *L. bistata*; *Schizoporella cinctipora*, var. *personata*, *S. tuberosa*, var. *angustata*; *Cellepora decepta*, *Cellepora* sp.

Royal Microscopical Society, November 10.—Rev. Dr. Dallinger, F.R.S., President, in the chair.—A microscope, with a set of apparatus and a cabinet of objects, bequeathed to the Society by the late Miss Tucker, was laid on the table.—Amongst the exhibits was a microscope for examining minute aquatic organisms under very high pressures; Leeuwenhoek's microscopes; objectives made of the new glass by Zeiss and by Powell, which were very highly spoken of by the President and others; and some gold-plated diatoms.—Mr. S. O. Ridley read a paper on the classification and spiculation of the monaxonid sponges of the *Challenger* Expedition; drawings and specimens illustrative of the various typical forms were shown.—Mr. A. Dendy also read a paper on the anatomy and histology of the monaxonid sponges of the *Challenger* Expedition, the subject being illustrated by drawings and specimens.—Dr. Crookshank read a paper on flagellated Protozoa in the blood of diseased and apparently healthy animals. He described a disease known in India as "Surra," occurring among horses, mules, and camels. A parasite was discovered in the blood of these by Dr. Evans, and was referred to Dr. Lewis for an opinion as to its nature, who concluded that it was not identical with, but closely allied to, the flagellated organisms which he had observed in Indian rats. Five years later an outbreak of the same disease occurred in British Burmah, and the report of an investigation was published by Veterinary Surgeon Steel, who observed the same parasite, but regarded it as closely allied to the Spirillum of relapsing fever in man, and named it *Spirochata evansi*. This opinion was not accepted by Dr. Evans, who placed blood, stained preparations, and material for section cutting, in Dr. Crookshank's hands for further opinion. Dr. Crookshank at once dispelled the idea of the parasite being a Spirillum, and gave a full account of his observations. These had led him to discover an anterior flagellum, a longitudinally-attached undulating membrane, and a posterior, acutely-pointed, rigid filament, from which characters he recognised that the parasite was a flagellated monad, probably absolutely identical with the parasite discovered by Mitrophanow in the blood of the carp, and named by him *Hematomonas carassii*. Dr. Crookshank consequently observed that the Surra parasite should rather be called *Hematomonas evansi* than *Spirochata* as suggested by Steel. Lewis's observation with regard to the flagellated organisms in Indian rats led Dr. Crookshank to investigate the species obtainable in England, which resulted in his discovering flagellate parasites in 25 per cent. of apparently healthy rats from the London sewers. These organisms proved to be morphologically identical with the Surra parasite and the parasite described by Mitrophanow in the blood of the carp, and were also recognised by a photo-micrograph made by Lewis to be identical with the organism observed by him in Indian rats, though Lewis's description and figures presented material differences.

Entomological Society, December 1.—Robert McLachlan, F.R.S., President, in the chair.—Messrs. W. H. Miskin, R. E. Salwey, and F. W. Biddle, M.A., were elected Fellows.—Mr. Howard Vaughan exhibited a long series of *Gnophos obscurata*, comprising specimens from various parts of Ireland, North Wales, Yorkshire, Berwick-on-Tweed, the New Forest, Folkestone, Lewes, and the Surrey Hills. The object of the exhibition was to show the variation of the species in connection with the geological formations of the various localities from which the specimens were obtained.—Dr. Sharp showed a series of drawings of New Zealand Coleoptera, by Freiherr von Schlereth, which, though executed in pencil, were remarkable for their delicacy and accuracy.—Mr. R. Adkin exhibited specimens of *Cidaria reticulata*, recently bred by Mr. H. Murray, of Carnforth, from larvae collected near Windermere, on *Impatiens noli-me-tangere*. Mr. Adkin said that, as the food-plant was extremely local, Mr. Murray had endeavoured to get the larvae to feed on some other species of balsam, including the large garden species usually known as Canadian balsam, but that he had not succeeded in doing so.—Mr. Billups exhibited a number of living specimens of *Aleurodes vaporariorum*, obtained from a

greenhouse at Snaresbrook, where they had caused great havoc amongst tomato-plants (*Lycopersicum esculentum*). He remarked that the species had been first figured and described by Prof. Westwood in the *Gardener's Chronicle*, 1856.—Mr. Poulton exhibited the blood of a larva of *Smerinthus tilia*, and demonstrated, by means of a micro-spectroscope, the existence of chlorophyll therein.—Mr. G. T. Porritt exhibited forms of *Cidaria suffumata* from Huddersfield, and a series of small bilberry-fed *Hypsipetes elulata* from the Yorkshire moors, showing green, red-brown, and black forms.—Mr. S. Stevens exhibited forms of *Camptogramma bilineata* and *Enimelesia albula* from the Shetland Isles, and a variety of *Chelonia caja* from Norwich.—Mr. H. Goss read a letter from the Administrator-General of British Guiana, on the subject of the urticating properties possessed by the larvæ and pupæ of certain species of Lepidoptera collected in Demerara.—Mr. McLachlan read a note concerning certain *Nemopteridae*.—Miss E. A. Ormerod communicated a paper on the occurrence of the Hessian Fly (*Cecidomyia destructor*) in Great Britain. It appeared from this paper that there could be no longer any doubt as to the occurrence of the insect in this country, specimens obtained in Hertfordshire having been submitted to, and identified by, Prof. Westwood, and by Mr. W. Saunders, of Ontario. Prof. Westwood said the specimens agreed exactly with Austrian specimens in his possession, sent to him some years ago by M. Léfévre, who had received them from the late Dr. Hammerschmidt, of Vienna. A discussion followed, in which the President, Mr. C. O. Waterhouse, Mr. Theodore Wood, and others took part.

Victoria (Philosophical) Institute, December 6.—A paper was read by the Rev. S. D. Peet on the religious beliefs and traditions of the aborigines of North America, which was followed by a discussion.

EDINBURGH

Royal Society, December 6.—Mr. J. Murray, Ph.D., in the chair.—The chairman gave an opening address. Among other points, he referred to the almost total absence of recognition by Government of scientific research in Scotland. The Ben Nevis Observatory, for example, instead of receiving support from Government, is, on the contrary, a source of considerable revenue to it.—The Hon. Lord Maclaren communicated astronomical tables for facilitating the computation of differential refraction for latitudes 56° and 57° 30'.—Prof. Tait communicated the second part of his paper on the foundations of the kinetic theory of gases. In this part he treats of gaseous viscosity, and conduction and diffusion of heat in gases. In his investigations he takes account of the fact that the mean free path of swift-moving particles is greater than that of slow-moving particles. This point has been wrongly introduced by all previous investigators.—Mr. R. T. Omond communicated an account of a fog-bow observed on Ben Nevis, October 22, 1886. He communicated also an account of experiments on the temperature at different heights above ground at Ben Nevis Observatory. He hopes to repeat them under more favourable atmospheric conditions, and also when the ground is covered with snow.

Mathematical Society, December 10.—Mr. George Thom, President, in the chair.—Mr. R. E. Allardice read a paper on the equiangular and the equilateral polygon; and Mr. J. S. Mackay communicated a solution and discussion, by M. Paul Aubert, of a geometrical problem.

PARIS

Academy of Sciences, December 13.—M. Junia Gravière, President, in the chair.—Glycose, glycogen, and mechanical force in the animal economy, by M. A. Chauveau. In this third and last contribution on the subject, an attempt is made to determine absolutely the extent to which the combustion of glycose co-operates in the development of animal heat and energy. The part played by the liver in these phenomena is specially studied, and it is shown generally that the glycose supplied by the liver to the blood constitutes the principal aliment of organic combustions, whence are derived animal heat and muscular energy.—Note on an epidemic of typhoid fever which prevailed at Pierrefonds during last August and September, by M. P. Brouardel. This outbreak is clearly traced to the polluted sources whence was derived the water consumed by the inhabitants of the Pierrefonds district.—On the formation of *Bifidobites* during the present epoch, by M. Ed. Bureau. In order to

determine the true character of the doubtful fossil organisms still by many naturalists classed with the Algæ, the author has carefully studied the traces of all kinds observed especially at points on the coast of Brittany, where extensive tracts are exposed at low water. Impressions have been taken of marks due to animals, yet exactly resembling the forms occurring in Secondary and even Primary formations often described and figured as belonging to the vegetable kingdom.—On the means of reducing momentary accelerations of velocity in machines fitted with regulating gear acting indirectly, by MM. A. Bérard and H. Léauté. The object of this memoir is to supply trustworthy governors, applicable especially to machinery used in the manufacture of gunpowder. For the apparatus here described, it is claimed that, while giving the required uniformity of action, it checks all abnormal increase of speed, so dangerous in this industry.—Observations of Finlay's comet (1886), made at the 0°38 m. equatorial of the Bordeaux Observatory, by M. F. Courty. The tabulated results of these observations include the mean position of the stars taken as points of comparison borrowed from Schönfeld's Catalogue, published in the eighth volume of the "Bonn Observations," 1886.—A practical demonstration of the existence of diurnal nutation, by M. Folie. The remarkable agreement of the results here recorded, deduced from observations made at various points of latitude and longitude, is considered sufficient to prove the existence of the diurnal nutation of the terrestrial axis, and to determine its constant at about 22".—On certain problems of isochronism, by M. G. Fouré.—On a theorem relating to the permanent movement and flow of fluids, by M. Hugoniot. The curious relation which is shown to exist between the permanent movement of fluids and that of the propagation of sound is here investigated.—On the coefficient of explosion for a perfect gas, by M. Félix Lucas. Various arguments are advanced to show that this coefficient is 1.40, not 1.41, the number generally adopted.—On the coefficient of pressure for thermometers, and on the compressibility of liquids, by M. Ch. Ed. Guillaume. The probable coefficient resulting from M. Descamps' experiments is shown to approximate very closely to that of Regnault, and the coefficients of compressibility must be corrected accordingly.—On the nature of electric actions in an insulating medium, by M. A. Vaschy. Assuming that the reciprocal actions of two electrified bodies are exercised through the intermediary of the intervening medium, and not directly at a distance, the author endeavours here to determine the part played by this medium in the transmission of the electrostatic actions. The medium itself is regarded as a combination of the ether and ponderable matter in relations to be subsequently determined.—Note on an absolute electro-dynamometer, by M. H. Pellat. By means of this instrument, which has been constructed by M. Carpentier, the intensity of a current may be determined directly in absolute value with an error less than 1/2000.—Note on steno telegraphy, by M. G. A. Cassagnes. By this combination of mechanical stenography and telegraphy the operator is enabled to record and transmit along a single wire a considerable number of words instantaneously. Numerous experiments on the French lines have yielded the following results for a single wire: (1) 400 words a minute to a distance of 350 kilometres (with two fingerboards 24,000 words an hour); (2) 280 words a minute to a distance of 650 kilometres (with two boards 16,000 to 17,000 words an hour); (3) 200 words a minute to a distance of 900 kilometres (with one board 12,000 words an hour). Messages may be forwarded simultaneously in both directions, and the system offers other advantages greatly accelerating and simplifying telegraphic work.—On a process of rock-erosion by the combined action of the sea and frost, by M. J. Thoulet. Certain results observed on the Newfoundland coast are attributed to the combined action of liquid and frozen water.—On some coloured reactions of arsenic, vanadic, molybdic, and arsenious acids, as well as of the oxides of antimony and bismuth, by M. Lucien Lévy.—Thermic phenomena accompanying the precipitation of the bi-metallic phosphates and allied salts, by M. A. Joly. Here are studied the extremely complex relations of bicalcic, bibarytic, distrontianic, and other phosphates, bibarytic arseniates, and monobarytic hypophosphate.—Heat of neutralisation of glyceric and camphoric acids, by MM. H. Gal and E. Werner.—On the water-bearing apparatus of *Calophyllum*, by M. J. Vesque. A study of this highly specialised apparatus enables the author to classify the twenty-five known species of the genus *Calophyllum*.—Analysis of the Javanese

mineral waters, by M. Stanislas Meunier. The specimens here examined were brought from the Kuripan district, near Boghor, and yielded 54.203 per cent. of chloride of calcium, 40.651 of chloride of magnesium, 2.860 of chloride of sodium, 1.104 of chloride of potassium, and 1.924 residue insoluble in water.—On a new locality containing the nummulitic formations of Biarritz, by M. de Folin.—On the importance and duration of the Pliocene period studied in connection with the Roussillon basin; fresh documents relating to the Pliocene mammiferous fauna of this district, by M. Ch. Depéret. In the discussion which followed the reading of this paper, both M. Gaudry and M. Hébert argued that the Pikermi and Léberon deposits should be referred, not to the Pliocene, but to the Upper Miocene epoch.—Note on the reptiles and fishes found in the caves of Mentone, by M. Emile Rivière.—On the storm of December 8, by M. Fron.—The Fohn and its cosmic origin, by M. Ch. V. Zenger. It is argued that this wind is a cyclonic movement of cosmic origin, allied to such phenomena as the aurora borealis, electric and magnetic storms, terrestrial currents, and the seismic waves which so often accompany violent tempests.

BOOKS AND PAMPHLETS RECEIVED

Crustacea and Spiders: F. A. A. Skuse (Sonnenschein).—The Queen's Jubilee Atlas of the British Empire: J. F. Williams (Philip).—A Concise History of England and the English People: Rev. Sir G. W. Cox (Hugbes).—The Tea-Planter's Manual: T. C. Owen (Ferguson, Colombo).—Diseases and Sin (Wyman).—Hours with a 3-inch Telescope: Capt. W. Noble (Longmans).—Proceedings of the Davenport Academy of Natural Sciences, vol. IV. (Davenport, Iowa).—Zeitschrift für wissenschaftliche Zoologie, Vierundvierzigster Band, Drittes Heft (Engelmann, Leipzig).—Differential Calculus: J. Edwards (Macmillan).—Proceedings of the American Philosophical Society, vol. xxiii. No. 123 (Philadelphia).—Report of the National Academy of Sciences, 1885 (Washington).—Bulletin of the U.S. Geological Survey, Nos. 27, 28, 29 (Washington).—Morphologisches Jahrbuch, 12 Band, 3 Heft Prof. Gegenbaur (Engelmann, Leipzig).—Bulletin de la Société Impériale des Naturalistes de Moscou, No. 2, 1885 (Moscou).

CONTENTS

	PAGE
Canal and River Engineering. By Major Allan Cunningham, R.E.	169
Alpine Winter	170
Our Book Shelf:—	
Von Tillo's "Magnetic Horizontal Intensity in Northern Siberia"	170
White's "Ordnance Survey of the United Kingdom"	170
Letters to the Editor:—	
The Cambridge Cholera Fungus.—Dr. E. Klein, F.R.S.	171
The Longitude of Rio.—Prof. C. A. Young	172
An Error in Maxwell's "Electricity and Magnetism."—James C. McConnell	172
Seismometry.—Prof. J. A. Ewing	172
How to make Colourless Specimens of Plants to be preserved in Alcohol.—Selmar Schönland	173
The Recent Weather.—F. T. Mott; William Ingram	173
Electrical Phenomenon.—Thomas Higgin	173
Electricity and Clocks.—T. Wilson	173
Botany of the Afghan Delimitation Commission. By W. Botting Hemsley	173
Deposits of Volcanic Dust	174
The Potato Tercentenary	175
New Zealand Coleoptera	177
The Relief of Emin Pasha. (With a Map)	177
Notes	179
Our Astronomical Column:—	
Barnard's Comet	181
Rotation-Time of the Red Spot on Jupiter	181
Astronomical Phenomena for the Week 1886	
December 26—1887 January 1	181
Geographical Notes	182
On some Further Evidence of Glaciation in the Australian Alps. By James Stirling	184
Sorghum Sugar	184
On the Cutting of Polarising Prisms. By Prof. Silvanus P. Thompson	184
The Sympathetic Nervous System. By Dr. Walter H. Gaskell. (Illustrated)	185
Scientific Serials	187
Societies and Academies	188
Books and Pamphlets Received	192

THURSDAY, DECEMBER 30, 1886

BABINGTON'S "BIRDS OF SUFFOLK"

Catalogue of the Birds of Suffolk; with an Introduction and Remarks on their Distribution. By Churchill Babington, D.D., &c. Reprinted from the *Proceedings of the Suffolk Institute of Archæology and Natural History*. 8vo, pp. 281. Map and 7 Plates. (London: Van Voorst, 1884-86.)

NUMEROUS as have lately been contributions to local British ornithology, the treatment of the subject is very far from being exhausted, and Dr. Babington's book is extremely welcome as supplying a new catalogue of the birds of a county having so favourable a situation as Suffolk. For though wanting the extended sea-board of one neighbour, Norfolk, which meets the uninterrupted roll of the polar waves, and possessing an almost even coast-line, very unlike the irregular contour of its other neighbour, Essex, Suffolk yet contains the most easterly point of England in Lowestoft Ness, as it is still fondly called, though a "ness" is there as hard to recognise in these days as is the "bay" of its historic Solebay, a few miles further south. Suffolk also is not without its "broads"—at Fritton, Oulton, Benacre, and Easton—insignificant as they may be in comparison with those of the northern half of the ancient East Anglian kingdom. It also shares with Norfolk the great Breydon Water, and with Essex the wide mouth of the Stour, while it has for its own the estuaries of the Blythe, the Alde, the Debden, and the Orwell, by no means despicable, even if they are not equal in size to those of the Colne, the Blackwater, and the Crouch, that drain so much of Essex. Suffolk again has a natural feature, the like of which is not possessed by either of its neighbours:—

"On Orfordness lies many a stone,
But Dungeness has ten for one,"

says the old adage, and it is not until the south-eastern corner of Kent is reached that a similar "beach" is presented, and that one only to be surpassed by the Chesil Bank of Dorset. Highly cultivated, too, as now is almost every acre in Suffolk that will repay cultivation, there are still some wide tracts along its eastern border, and again towards its north-western extremity, which, if indeed they have ever been under the plough, have long since lapsed into an approach to their original condition, and are overgrown with heather and gorse, or form "brecks," kept, by the teeth of countless sheep and rabbits, in the state of the poet's "smooth-shaven green." The western limits of the county not only bound, but slope into, the great Fen district, that spreads for miles and miles in an almost level plain towards the Wash. The chief part of Suffolk has long been inclosed, presenting, in the absence of any but the most inconsiderable elevations, a very uniform appearance; and, were it not for its numerous woods—not many of which are really ancient—and plantations, would afford harbour to few but the commonest of birds. An indefinite district, the soil of which is of the stiffest clay, is colloquially named "High Suffolk"; but where it begins or ends, no one knows; and, for some mys-

VOL. XXXV.—NO. 896

terious reason, nobody will own to living in it. "High Suffolk" always begins in the next parish, or the next parish but one! A great contrast to these heavy lands is presented by the "breck" district already mentioned, where the chalk-formation comes nearly to the surface, and is only overlain by a few inches of the lightest sand—so light, indeed, that some places may be found as bare of vegetation as is a real desert—every particle of fertilising matter having been blown away by the wind after a spell of dry weather; and it will be remembered that in East Anglia the rainfall is less than in any other part of England. This district still retains, in at least one of its birds, in some of its insects, and in a few of its plants, indications of having been once—and that perhaps not so very long ago—a littoral, an arm of the sea having doubtless reached its low hills, and in after times retreating, having left these survivors who still hold their ground. But here we may say that we cannot for a moment subscribe to the opinion to which Dr. Babington gives currency (p. 123), though not saying whether he himself shares it, that the marine connexion was by "a broad estuary running from the South Suffolk coast between Bury St. Edmund's and Stowmarket through Thetford." So far as we are aware, there is no evidence in favour of such a violent supposition, and much against it. On the other hand, a very slight depression of the surface would once more bring the sea from the Wash up to Brandon, if not to Thetford.

We make no attempt to trace the deeper effects of geological formations and changes; but all these superficial characters, here so briefly sketched, combined with the geographical situation of the county, will serve to show why Suffolk should present a field of great interest to the ornithologist; its varied features offering suitable accommodation for many kinds of birds of diverse habits, and its eastward position a sanctuary where the wings of many a weary wanderer from afar may be folded at rest. There is the more need to urge the importance of these favourable circumstances, because they cannot be said to be too prominently laid before his readers by Dr. Babington, who perhaps through modesty, or perhaps through prudence (in which latter case he is certainly to be commended), abstains from setting forth the advantageous conditions of existence that the county of his adoption thus affords, albeit he devotes a few pages (258-268), which might well have been more, to the subject.

In computing the birds of a circumscribed area, it is always a difficult task to decide whether the adventitious strangers whom the accidents of travel may have driven upon its coast should be enumerated among its real inhabitants, for there is really much to be said on both sides of the question. At first sight it seems most absurd that, granting even there is no reasonable probability of its importation, the stray example of an exotic species, whose home may perhaps be in the further wastes of Northern Asia or the wilds of Arctic America, should be enrolled as a "British bird," because it has had the ill-luck to find its way hither and be killed—*secundum usum Anglicanum*—within the confines of the United Kingdom; but almost immemorial practice may be pleaded for this view of the case, and we are not minded to place on record a distinct decision against the claims

of a local faunist on so delicate a question. However, the local faunist should recognise the fact that a long list is not necessarily "a strong list"—to use Dr. Babington's expression—and if space allowed us to go into details we should be inclined to strike off not a few species from his register. It is true that this would not materially alter his position, for a corresponding number would on the same ground have to be struck off the register of other counties. In reality, no one has ever doubted that the Suffolk roll is one of the highest to be found in England. Perhaps it would stand only second to that of Norfolk on the English record, for though both, so far as published lists go, are inferior to that of Yorkshire, we are persuaded that this last has been unduly swollen. We have a strong suspicion that a Kentish list would run any of them very hard; but we here speak without facts, for ornithologists have long been scarce in Kent, and no attempt at a Kentish list has been made for many a year. The comparison instituted by Dr. Babington between the ornithological wealth of Suffolk and certain other counties is in some measure fallacious,—the last list of Sussex birds, for example, dates from 1855; (not 1865 as he inadvertently states), while practically it was compiled in 1849, since which time a good many things have happened. Comparison with inland counties is of course misleading, and probably the well-known published catalogues for Cornwall, Somerset, Northumberland, and Durham, and for the Humber district, are alone those with which catalogues for Suffolk and Norfolk can be rightly compared; while the county last named, from the abundance of ornithological observers it has produced, is manifestly favoured in the race. One other thing may perhaps be mentioned in this connection, and that not so much for Dr. Babington as for authors of future "Avifaunas"; the ornithological richness of a district depends far more on the number of its real inhabitants than on the number of species which have occurred as stray visitors within its limits and only *bond fide* travellers. As regards large areas this is a truth so obvious that our remark may seem to be a platitude, but as regards small areas the consideration is too often overlooked.

Among all the English works on local ornithology with which we are acquainted, Dr. Babington's holds a peculiar place. Its contents are distinctly matters of fact, or of what passes for fact; in other words, it is a summary of records. No one would pretend to say that any book of this kind is, or could be, exhaustive; but the author has done his best to make his work so, and the infinite pains he has taken to be precise are present on every page—for every page bristles with references that have obviously cost him immense labour to collect, and his patient industry in culling them deserves the highest praise. On the other hand, this very precision may not unfrequently mislead the unwary. Unless the reader have a competent knowledge, elsewhere obtained, he may be apt to presume that the fact of such or such a species having been recorded as occurring or breeding at such or such a place and at such or such a time is an indication that it has not occurred or bred there at any other time. For the sake of those who are beginners, or ill-instructed in ornithology, and they ought to form a majority of those who use this book, it would have been better had the author uttered a warning against this kind of misconception, which in

many cases is certain to follow from this concise method of citing previously recorded observations. Experts, of course, will not be taken in by it, but we think it may deceive others. Experts, however, unless they be accustomed to the way in which local florae are compiled, have some right to complain of the application of botanical methods to a fauna—for it is plain that the "Catalogue of the Birds of Suffolk" is planned on essentially the same principle as would have been a catalogue of the plants of the same county, and not according to any zoological precedent.

A few words are Dr. Babington's due on another matter. To most zoologists his name will be new, and yet entered the field of biological literature nearly five-and-forty years ago! His ornithological appendix to Potter's "History and Antiquities of Charnwood Forest," published in 1842, was a respectable, not to say ambitious, performance for an undergraduate; and, while showing rudiments of the same scrupulosity as is seen in the present work, is equally removed from loquacity, though containing some information that the British ornithologist would not willingly let die. Both in conception and in execution it naturally has been surpassed by late publications, nor can it be regarded as the original precursor of the numerous local "Avifaunas" of Britain. The primacy in this respect belongs, we believe, to one the author of which has lately died, and to his memory we take this occasion of offering a passing tribute. The "Ornithological Rambles in Sussex," which was added a catalogue of the birds of that county, appeared in 1849, the work of Mr. Arthur Edward Knox, who died on September 23, 1886, having nearly completed his seventy-eighth year. Mention of this observant naturalist, agreeable author, and accomplished gentleman is all the more needed, since his death obtained scant, if any, notice in the newspapers of the day, though column after column in their broad sheets chronicled the career of a successful horse-jockey who expired not long after. Mr. Knox, it is true, never assumed the character of a man of science any more than that of a man of letters, yet his literary style was of the best, while few professed naturalists have so thoroughly practised scientific methods of observation, and none could more fully appreciate scientific worth. His three works—that already named, his "Game-Birds and Wild Fowl," and his "Autumns on the Spey"—all of the kind that is usually called "popular," have some characteristics that at once distinguish them from so many others to which that epithet is commonly applied. They are always accurate, seldom trivial, and never vulgar.

To return, however, to Dr. Babington's little volume. Its value, notwithstanding some shortcomings to which we have referred, is great, and the recorded facts, with which, as already stated, it is crammed, are such as no "British" ornithologist can afford to neglect. As a final mark of attention, let us notice that Dr. Babington's scholarly instinct has inspired him with enough courage to be the first writer who has corrected an unhappy mistake made by Linnæus, and restored (pp. 200-203) the old

¹ Of course there are several other local lists of older date, from that of Markwick downwards, including "The Norfolk and Suffolk Birds" of Sheppard and Whitear; but these were published in journals (mostly in the Linnæan Transactions), and we are here speaking of separate works the scope of which is ornithology alone.

spelling *Podicipes*, for the ungrammatical, senseless, and misleading *Podiceps*, thereby removing a reproach which every literary man could successfully cast at a zoologist. *Exemplum sequendum!*

INTERMITTENT DOWNWARD FILTRATION
Ten Years' Experience (now Fourteen Years) in Works of Intermittent Downward Filtration. By T. Bailey-Denton. Second Edition. (London: E. and F. N. Spon, 1885.)

THE treatment of sewage by intermittent downward filtration on specially prepared areas of land is now generally recognised as the most efficient method for the purification of the sewage of towns. Mr. Bailey-Denton is one of the ablest exponents of this system, and one who has had large experience in its practical application. He is also well known as being the joint author, with Col. Jones, of a well-devised scheme for treating the sewage of the metropolis on Canvey Island at the mouth of the Thames—a scheme, however, which has not been received with any sort of approval by the Metropolitan Board of Works. The Royal Commission on Metropolitan Sewage Discharge considered very fully the merits and demerits of the system, and expressed their opinion—“(1) That the process has great scientific merit, and offers valuable practical advantages for the disposal of sewage in situations where broad irrigation is impracticable, and where land suitable for filtration can be obtained. (2) That, however, it appears desirable, when the area of land is considerably reduced, that the sewage should be previously treated by some efficient process for removing the sludge. (3) That an arrangement of this kind would be applicable to the metropolis. . . .” Broad irrigation was defined by the Royal Commission to mean “the distribution of sewage over a *large* surface of ordinary agricultural ground, having in view a maximum growth of vegetation (consistently with due purification) for the amount of sewage supplied,” whereas filtration means “the concentration of sewage, at short intervals, on an area of specially chosen porous ground, as *small* as will absorb and cleanse it; not excluding vegetation, but making the produce of secondary importance.” On a suitable soil—a sandy loam with a small proportion of gritty gravel to quicken percolation is the best—specially prepared by surface levelling and deep under-drainage, one acre is capable of effectually purifying the sewage—without any preliminary treatment—of 1000 people, provided that the sewage is free from any large proportion of trade or manufacturing refuse, and that storm and surface waters are kept out of the sewers. The obligation to treat storm waters, which come down in the sewers in times of heavy rain, is one of the greatest obstacles in the path of any system of sewage purification, and will continue to be until all towns are supplied with a dual system of drains and sewers. One inch of rain, thrown off 100 acres, equals 2,262,200 gallons; “and if,” says Mr. Bailey-Denton, “one-tenth of this quantity suddenly reaches the outfall—say, in half an hour—no mode of treatment yet devised can deal with such a quantity without injury or defect.” As a rule, at the present time, despite prospective penalties for river pollution, the mixed sewage and storm water is allowed to pass into the rivers

without any sort of treatment. Mr. Bailey-Denton recommends that the storm overflow be connected with osier beds. “The beds are formed in horizontal areas which serve to *check* the rapidity of flow of suddenly discharged rainfall. This check causes the deposit of the floating solid matters in the furrows, while the flood-water rises and overflows the ridges and the osiers growing on them. These beds are not under-drained in any way; their simple purpose being to clarify those excess-waters which, without the check afforded by them, would be impetuously discharged, together with everything floating in them, into the natural streams of the watershed.” Mr. Bailey-Denton does not think it necessary or even desirable, in most cases, to precipitate the sludge—the minute suspended particles, organic and inorganic, of sewage—by chemical processes or depositing tanks, before the sewage is applied to the filtration beds. He does not believe that the sludge, unless mixed with solid trade refuse, under proper treatment is capable of clogging the pores of the land or of injuring vegetation. He recommends the filtration beds to be laid out in ridges and furrows—the sewage only flowing into the latter, and not being allowed to flood the ridges on which plants and vegetables are growing. The plants cannot then be injured by the deposit of the solid ingredients of the sewage on their stalks and leaves. “As soon as the deposit of sludge on the sides of the furrows is sufficient to prevent infiltration in any great degree, the sewage is withheld from the areas so affected. The sludge is then allowed to dry (partially) in the furrows, and when in a fit condition it is lifted and dug into the ridges,—as can be seen practised at Gennevilliers (Paris). The slimy matter which had appeared so considerable, and which puddled the bottom of the furrows, when in a wet state, shrinks to a skin of very insignificant thickness when dry, and is readily broken up and mixed with the soil.” Still Mr. Bailey-Denton admits that the extraction of the sludge has one great advantage, viz. that “the same land will filter double the quantity of clarified sewage liquid that it would cleanse sewage of which the finer particles have not been removed;” a very important point to towns where the area of land at disposal for sewage purposes is strictly limited.

The intermittency of the application of the sewage to the filter beds is a *sine quâ non*. Each bed should have 18 hours' rest out of the 24, to allow air to follow the sewage as it percolates through the pores of the land, thereby renewing the oxidising properties of the soil—properties largely dependent, no doubt, on the life and growth of certain Bacterial organisms resident in the superficial layers of the soil, which have been shown by Warrington and other observers to be the principal agents in the nitrification and purification of the nitrogenous organic matters of sewage. The assimilative power of growing plants is doubtless also a great aid in the purification of sewage, and the plan of ridges and furrows adopted by Mr. Bailey-Denton, in enabling him to raise large crops on filtration areas, has taken away from the system the reproach that it was utterly unremunerative. There can, however, be no doubt that it is in combination with surface or broad irrigation that intermittent filtration is likely to have its most useful application. In a valuable chapter on sewage farming, Mr. Bailey-Denton points

out that whatever the estimated value of sewage may be—8s. 4d. per annum per head of the inhabitants of water-closet towns, or 1½d. per ton with a dilution of 61 tons—it is actually reduced to the sewage farmer by attendant drawbacks to the present mode of application to much less than ¼d. per ton. The sewage must be applied to the land whether it is wanted or not, and may, under such circumstances, be the cause of mischief to crops rather than of benefit. It has been assumed that by surface irrigation one acre is capable of purifying the sewage of 100 persons; but what farmer, Mr. Bailey-Denton very pertinently remarks, would give even a farthing per ton for the obligation to apply in a year 6100 tons of liquid to an acre—equivalent to a superincumbent depth of 5 feet, or 2½ times the average rainfall—though he would gladly give a larger price per ton if he could have what he wanted, just at such times as he wanted it? “All experiences tend to prove that the obligation to ‘get rid’ of a large quantity of sewage under all circumstances and conditions, at night as well as day, on Sundays as well as week-days, on cropped lands as well as fallows, and at all stages of growth, from seed-time to harvest, puts it beyond the reach of man to gain any real profit from it.” Many of the ordinary farm crops, as cereals, pulses, potatoes, and turnips, are injured by the application of sewage. Rye-grass, cabbages, mangolds, carrots, parsnips, and perhaps onions, are the plants that thrive best under sewage (it is said to be impossible to overdose rye-grass with sewage); but these are crops that may very readily be produced in larger quantities than there are markets for.

The great drawback, alluded to above, can be overcome by every sewage farm having specially prepared filtration areas, capable of purifying the whole sewage, when not wanted on the general surface of the farm, and leaving it within the power of the occupier to draw such quantities, at such times as he requires them, as dressings for his crops. Under such arrangements sewage farming may be expected—as it has been found by Mr. Bailey-Denton at Malvern and elsewhere—to be remunerative to the farmer and satisfactory to the town authorities. The cost of laying out the land for intermittent filtration is high—from 30l. to 150l. per acre in difficult cases, according to Mr. Bailey-Denton’s estimate—but not sufficiently high in any way to counteract the immense advantages which the possession of such filtration areas confers.

A MEDICAL INDEX-CATALOGUE

Index-Catalogue of the Library of the Surgeon-General’s Office, U.S. Army. Vol. VII. Insignarès-Leghorn, pp. [100] and 959. (Washington: Government Printing Offices, 1886.)

THE masterly way in which Mr. J. S. Billings is conducting this Index-Catalogue, and publishing punctually year by year these large volumes of about a thousand closely-packed pages, is a matter worth the attention not only of all interested in medicine and surgery, but also of all interested in modern libraries and modern journalistic literature. For the Library of the Office of General Robert Murray, Surgeon-General of the U.S. Army, though only founded in 1830, is now one of the largest collections of medical literature in the world,

larger possibly than that of the British Museum, of the Bibliothèque Nationale of Paris, or the collections Berlin or Vienna, and it contains some manuscripts, notably a letter of Edward Jenner’s, which the English librarians would be glad to have. Its catalogue is certainly much more complete, as far as it has been published, in spite of the method of execution having been much more difficult. For these seven volumes that have been hitherto published contain more than 254,000 references to articles or essays in journals and periodicals of all kinds and in all languages, arranged under the subjects to which they refer. The French and German pleasure in framing appended bibliographies on the subjects of some monographs which they publish has never given them courage enough to face such a Herculean task. The number of periodicals which either have been or are being taken in by the Library has risen since last year, when vol. vi. was published, from 3005 to 3270, and extends through a wide geographical range, from the *Norsk Magazin* of Christiania, to the *Klin-le I-letzu* (the *Modern Medical News*) of Yedo; and in wide range of interest from the *Revue des deux Mondes*, to the *Dental Luminary* of Macon, Ga., U.S. The learned compilers of the Index-Catalogue are good enough always to translate the Japanese titles when they print them in English letters; indeed they sometimes go further, and, avoiding the difficulty of even transliterating them, give us merely the title in English, with a warning note that the original title is Japanese. Magyar is also as a rule, though not by any means always, translated; Polish sometimes, Russian only occasionally. The whole method of the book is so perfectly orderly and symmetrical, that it makes us wonder whether this want of rule in translation is one of the trifling points in which the individualism of Mr. Billings’ assistants has crept in; for we cannot see that the translated titles are in any way more difficult than the untranslated.

Under the subject-headings come the great masses of quotation of the titles of articles in periodical literature which make the Catalogue so unique. If we turn to the name of an author who writes both books and papers in journals, &c., we shall not find entered under it anything but his separately published works; though, probably, all of those down to his smallest reprint from some Society’s *Transactions*, and with these, in smaller type, a reference to other books to which he has contributed or which he has translated; and, if he is dead, a reference, probably, to some biography of him, and some portrait; but, beyond this, none of his contributions to journals or *Transactions*. Nevertheless, under the subject-title of any such contribution, whether it be Jaundice, Jealousy, or Jequirity, will be found a reference to his article if it was signed, and his name, in bold type, clearly standing out among the mass of contributors to that branch of knowledge. It would have been possible, of course, to print such references twice over—once under the heading of the author, and again under the subject-title; but we can hardly wonder that that has not been done, as it would have added some five or six thousand pages to a series of volumes already in danger of being overweighted, and, also, it would have supplied information which is of more importance to the biographer than to medical science.

Of the subject-titles in this volume, the largest is Labor, under which, in 150 pages, a very complete library is catalogued of some 1500 books and 10,000 articles, well arranged under many headings. Under Kidney, the student will probably be content to find references to about 400 books and 2500 articles.

It is easy to show the vast extent of the work attempted and executed; that there are absolutely no inaccuracies in the result is hardly possible, difficult as it may be to find them. The references in this volume certainly stand many tests, and most of those who have made frequent use of the previous six volumes in practical work have acquired a confidence in their accuracy which is very rare in dealing with such an immense mass of varied languages and types and abbreviations so thickly interspersed with figures.

Both the Library and the Index-Catalogue are brought fully up to date. The volume is presented to the Surgeon-General of the U.S. Army in a letter of preface dated June 1, 1886, and it contains the books and periodical references practically complete up to the end of 1885. If any comparatively modern subject is examined, e.g. kairine, we find nothing said or known of it before 1882, and yet 120 references, taking us over all the published literature of the subject, down to the end of 1885.

This seventh volume includes the entries from Insignarès to Leghorn. It is likely to be the middle volume of this encyclopædic work; and certainly if Mr. Billings is able to publish his last and concluding volume in 1892 no one who has any interest in the progress of knowledge will hesitate to congratulate him and his colleagues even more heartily, if it be possible, than at present.

A. T. MYERS

LETTERS TO THE EDITOR

[The Editor does not hold himself responsible for opinions expressed by his correspondents. Neither can he undertake to return, or to correspond with the writers of, rejected manuscripts. No notice is taken of anonymous communications.]

[The Editor urgently requests correspondents to keep their letters as short as possible. The pressure on his space is so great that it is impossible otherwise to insure the appearance even of communications containing interesting and novel facts.]

Sounding a Crater, Fusion-Points, Pyrometers, and Seismometers

THE account given by Prof. John Milne of his ascents and attempts at sounding the crater of Asama Yama is exceedingly interesting, and I can thoroughly sympathise with him in the difficulties he encountered, having been exposed to them on many occasions, and not always coming off so victoriously. He and Mr. Dun, however, have been forestalled by the late Robert Mallet. When I came to Naples some eight years since, I found in one of the store-rooms of the geological department of the Naples University a quantity of apparatus which I soon made out the use of.

It appears that Mallet had this apparatus made especially for the purpose of measuring the temperature and studying the gases and the lava itself within the mouth of the volcano Vesuvius. On his arrival in Naples the state of the mountain did not permit of the experiments being carried on, and the whole of the materials were left in charge of Prof. Guiscardi, who could give no other information than the above. By carefully studying the apparatus I was soon able to understand Mallet's intentions and the mechanism he intended to employ. There are two drums of small wire cable—one for traversing the crater to hold a pulley over the "hacca," and the other for letting down the weight and crucible. The crucible is of cast iron with a bayonet-jointed cover, and is, no doubt, intended to contain substances of

different fusibilities. The apparatus is, however, an improvement on that used in Japan, in that the sounding-rope is insulated and there is an electrical bell and battery so arranged that when the crucible enters the lava it makes an earth-contact and rings the bell. There are other pieces of apparatus that I could not get at, but I think they are intended for chemical researches.

From these facts it will be seen that Prof. J. Milne has been forestalled as far as the method is concerned, but no experiments were ever carried out, either by Mallet on account of failing health, or by those in whose hands the apparatus fell. I made application to be allowed to use the apparatus, but for various reasons was unable to.

Before leaving this subject, may I appeal to your readers for a list of substances the fusion-point of which is known, and all of which would be above a dull red heat? I should like to have as complete a series as possible, so as to obtain results confined within narrow limits. Also any suggestions as to the best form of pyrometer that might be forced into and held in a stream of flowing lava, and that would not be injured by the breaking off of the rocky crust on its removal.

May I be permitted to make a few observations on the question lately raised about the authorship of certain seismographs? Not long since I described in your pages certain instruments that I considered as likely to be useful in such violent earthquakes as shake Ischia from time to time. With the exception of two, no claim was made to originality of principle, and yet I received through your pages a severe scolding from Prof. Ewing. Now if we really go into the literature of the subject we shall find the horizontal pendulum is not the invention of Prof. Ewing, but his present form of seismograph is one of the best applications of such a contrivance for measuring the horizontal component of an earth-wave, and I think he is justified in calling it *his seismograph* in so far as the present model goes. If we did not allow so much, no man using a vertical pendulum, however well contrived and modified, could call such *his*. At any rate I shall leave Prof. Milne, Prof. Ewing, and Mr. Gray to fight their own battle, but Prof. Ewing has fallen into the very same error of which he not long since accused me.

Naples, December 20 H. J. JOHNSTON-LAVIS

The Recent Earthquakes

MAY I ask to be allowed to call attention to some points in relation to the two earthquakes mentioned in your issues of December 9, p. 127 ("Volcanic Eruption in Niua-Fu, Friendly Islands"), and December 16, p. 157 ("Earthquake at Sea"). As regards the first, it is stated that "The whole island has been in a disturbed state for some three months and a half, the dates of the principal disturbances coinciding remarkably with those which are going on in other parts of the world—earthquakes on June 8 and 11, which, I think, are the dates of the first New Zealand outbreaks. . . This is, of course, not wonderful; but the final catastrophe here took place on August 31, which, we understand, was the exact date of the recent American earthquake. It was preceded for twenty-four hours by earthquakes, and went on for ten days."

Assuming the synchronism of the Tonga eruption and earthquakes with those of the North Island of New Zealand, there is this very interesting relation between the two localities, that they both lie very near to a great circle which I may designate as the "West Coast of Africa Great Circle." This passes through, or near, the following points:—

Cape of Good Hope to St. Helena Bay; mouth of River Orange; Walfish Bay; Cape Marha; Cape Lopez Gonzalez; Bonny River; Algerian coast, near Nemours; south-east coast of Spain, near Almanzora; north coast of Spain (3° 25' W. long.); west coast of Ireland (Loop Head); southern point of Iceland (near Westmanna Island); north-west point of Iceland; Greenland, Cape York; Melville Island (south coast and point of); Bering Island; Cape Dalhousie and coast-line of Liverpool Bay; Ala-ka, Montagu Island; Tonga Island (half a degree to west of Tonga Tabu); New Zealand, north-east point of North Island; passes between Adeline Land and South Victoria Land; Enderby's Land. It may be remarked that several of these localities are noted for disturbances both volcanic and seismic.

As regards the "earthquake at sea" mentioned in your number of the 16th inst., the position where it was felt is given as N. lat. 19° 21', and W. long. 64° 22'; this gives a point about 93 miles north-east of Porto Rico. The interest in this

case lies in the fact that the antipodal point corresponding, being S. lat. $19^{\circ} 21'$ and E. long. $115^{\circ} 38'$, lies about 100 miles north by east of Barrow Island, off the west coast of Australia. It is further interesting to note that the line which joins this point with the southern point of Barrow Island fairly represents the direction of the coast-line at this point, and leads to the presumption of the existence of main lines of faulting there having that direction. To this relation of antipodean points in connection with earthquakes I have already had occasion to call attention.

J. P. O'REILLY

Royal College of Science, Dublin, December 22

Barnard's Comet

THIS comet has been observed here with the $7\frac{1}{2}$ -inch refractor, with power 50, than which no higher power could be used with advantage.

On December 19, at 18h., it appeared as bright as a 2nd magnitude star similarly situated; the nebulous head was about $10'$ in diameter, with central condensation of perhaps half a minute. The "position" of the principal tail was estimated to be 0° : it remains of a parallel breadth throughout, and does not increase in breadth as it recedes from the head of the comet; this constant breadth is equal to the diameter of the nebulous head, that is to say, $10'$. By sweeping, this tail may be traced to a distance of some 10° from the head.

The secondary tail is inclined at an angle of between 30° and 40° to the principal one, and fades away rapidly at a distance of perhaps 1° from the head; it is well defined on the preceding side, but on the following side it melts away into a nebulous mass connecting it with the principal tail for some distance from the head.

On the 27th, at 19h., the comet was decidedly less bright than on the 19th, but the same general description applies.

The "positions" of the two tails were measured, and were: the principal tail, $15^{\circ} 5'$; the secondary, 338° ; the included angle, $37^{\circ} 5' \pm 0^{\circ} 5'$. The secondary tail did not appear as well defined, on the following side, as on the 19th.

Finlay's comet presents no visible feature of interest.

WENTWORTH ERCK

Shankill, co. Dublin, December 28

Electricity and Clocks

IN the absence of any details, apparently Mr. Wilson's simplest plan would be to insulate the hammer and bell of his "small striking clock," and arrange that a galvanic current should pass through both, when they come in contact by the act of striking: this current of course to be directed to a large electro magnet, to raise the hammer for striking on his bigger bell. Should the striking of Mr. Wilson's smaller clock be on a gong with a leather-beaked hammer, a separate attachment must be made for contact.

HENRY DENT GARDNER

Lee, S.E., December 26

P.S.—If a longer contact be desired, the hammer whilst at rest should repose upon a weak spring, and be kept away from the banking; when the hammer rises, contact will ensue between the spring and banking, and last until the hammer falls again.—H. D. G.

Seismometry

THERE are one or two points in Prof. Ewing's letter on the above subject in the last number of NATURE which seem to call for a few words of reply.

(1) As to the alleged inconsistency between what I wrote in 1881 and what I wrote in my last letter. The remark quoted referred to a light pivoted frame carrying at its centre of percussion, relatively to the axis through its pivot, a pivoted mass. There was no "if need be" about this mass: it was an essential part of the system. I believe the remark I then made was perfectly correct and in no way inconsistent with my remarks in 1886.

(2) As to the vertical-motion instrument, the lever with spring joint used at Comrie in 1842 does not at all resemble the rigid lever working on knife edges and supported by springs as introduced by me and used by Prof. Ewing. On the question of compensating the lever by the addition of negative stability, I have nothing to add to what I stated in my last letter.

(3) As to the publication referred to by Prof. Ewing, the memoir printed by the Tokio University is probably, from the circumstances of its publication, hardly known to anybody. The "Encyclopædia Britannica" article is not, in my opinion, a fair account of what has been done in sei-mometry.

THOMAS GRAY

7, Broomhill Avenue, Partick, December 27

The Recent Weather

AT Cardross, half-way between Dumbarton and Helensburg on the Clyde, at about 25 feet above sea-level, in an outer lobb with a temperature of say 45° to 50° F. at 9 a.m. on Wednesday, the 8th inst., the mercurial barometer stood at 27.51 inches, which, with reduction of say 0.02 added for elevation, and say 0.03 subtracted for temperature, would make it 27.50 inches. On January 26, 1884, it stood at 27.39 inches, which with like reductions would give 27.38 inches. These are nearly as low as those you refer to in your number for last week.

Cardross, Dumbarton, December 23

R. B. W.

OBSERVATIONS OF NEBULÆ AT ARCTURI

M. TEMPEL observes under difficulties. The Arcturi Observatory possesses, it is true, two fine refractors by Amici, one of 11, the other of 93 inches aperture but neither is, properly speaking, available for astronomical use. The smaller is rudely set up on an open and uneven terrace, exposed to every gust of wind, and, at the most, serves to display the wonders of the heavens to curious visitors. Amici I. is duly ensconced in a revolving dome, but clockwork motion is wanting; the circles, both of declination and right ascension, are (strange as it may seem) *undivided*; and when the necessarily somewhat unwieldy instrument is, with infinite pains and without so much as the aid of a handle, pointed towards the object sought, there is actually no means of clamping it in the position so laboriously arrived at! That M. Tempel, under circumstances so discouraging to him and disgraceful to the responsible authorities, should have executed a number of valuable drawings of nebulae should have re-observed many such objects neglected, or even believed to have disappeared, since the elder Herschel's time, besides discovering a good proportion of new ones, gives astonishing proof of his keenness, zeal and accuracy. All the more, nevertheless, there is reason to regret that qualities so rare should be employed at such cruel disadvantage for want of the judicious expenditure of a couple of thousand francs.

The paper before us is accompanied by reproductions of two admirable drawings by the author, one of the Orion, the other of the "Crab" nebula (Messier I.). The latter is of especial interest, as disclosing a feature unnoticed by any previous observer. This is a dark cleft right through the central condensation, dividing it along the major axis into two spindle-shaped nebulae. Incipient fission would seem to be indicated. On the same plate with his own, M. Tempel has engraved five earlier drawings of the object, by J. Herschel, D'Arrest, Lassell, Secchi, and Lord Rosse. The comparison is instructive, if somewhat disheartening; for, assuredly, no two of the six confronted delineations could be supposed, on an unprejudiced inspection, to have been inspired by one original. Yet the nature of that original sufficiently explains the discrepancies. The apparent form of nebulae depends upon almost evanescent gradations of diffused faint light, and differs, for each individual eye, with its sensitiveness to them. And since personal equation, as regards such gradations, is shown by many proofs to be enormously large, a vast amount of detailed variation in the representation of the objects exhibiting them becomes intelligible. It is, then, a circumstance of pecu-

¹ "Ueber Nebelflecken. Nach Beobachtungen angestellt in den Jahren 1876-79 auf der Königl. Sternwarte zu Arcturi bei Florenz." Von W. Tempel. Abhandlungen der Königl. Böhm. Gesellschaft der Wissenschaften. VII. Folge, 1. Band. (Prag, 1885.)

liarily good omen for progress in the study of nebulae that a mode of record at once so fluctuating and so laborious as that of hand-drawing should be replaced (as it will no doubt soon wholly be) by automatic impressions which, with some points of inferiority, at least leave no room for "individualism."

M. Tempel's description of the Merope nebula (discovered by himself in 1859), and his remarks on the great elliptical mass in the girdle of Andromeda, derive particular interest from recent events. His observational faculty, and the high quality of his telescope, are illustrated in the disclosure to him, by Amici I., of nearly 900 stars in the Pleiades, all of them comprised within the field of view of a 4-inch Steinheil bearing a magnifying-power of 24. With the former instrument he detected independently on September 30, 1875, a few days before reading Bond's description of them, the strange obscure channels in the Andromeda nebula; and has since with some difficulty made out similar markings in some small nebulae of the same class. They would accordingly appear to be a more or less characteristic feature of "oval" nebulae, and might perhaps be assimilated to the symptoms of partial duplication in Messier I.

In respect to the nature of nebulae, our author's experience leads him decidedly to adopt the view of their close connection with stars. He shows, indeed, for spectroscopic evidence a disregard that is neither philosophic nor just; yet his contention that *purely gaseous* nebulae do not exist, is probably well founded. No aggregation of celestial mist, at any rate, has ever been observed by him in which his 11-inch failed to reveal the pricking light of minute stars, marking some knot or nucleus, and thereby evincing structural relations of a most intimate kind.

THE MATHEMATICAL TRIPOS¹

III.

WHEN the interval between the earlier portion of the examination and Part III. had been extended to a year, it became evident that some substantial relief must be afforded to the examiners. By the existing regulations a person who accepted the office of Moderator would have to take part in the examination in three consecutive years, and in his second year of office he would have to examine the candidates of one year in Part III. simultaneously with those of the year below in Parts I. and II. This led to the consideration of the whole question of the appointment of examiners. The two Moderators in each year are nominated by two colleges, according to a prescribed cycle of fifty years. This nomination by colleges, though theoretically not very defensible, had worked very fairly so long as the examination only included subjects with which any high wrangler might be expected to be acquainted; but it was clearly unsuitable for Part III. In any case the nomination of the four examiners by four independent bodies might easily bring about the result that among the various subjects included there would be some which had not been made the object of special study by any of the examiners: indeed there was nothing to prevent the four examiners being all pure mathematicians or all physicists. Accordingly, with a unanimity almost unique in matters relating to the Tripos, the Board recommended in a Report dated June 15, 1885, that the examiners for Part III. should be quite distinct from those for Parts I. and II., and that all four should be nominated by the Board. It was also proposed that they should hold office for only one year. This Report was sanctioned by the Senate on October 29, 1886. In future, therefore, the Moderators will not take part in the highest portion of the examination. The appointment of Moderators dates from 1680. Previously the Proctors had themselves pre-

sided in the schools, but in that year the duty of conducting the disputations was transferred to the Moderators, who were specially appointed to perform this office. The Moderators have always been, and still remain, high University officers, ranking next to the Proctors.¹ Not only were they the earliest examiners in the University, but it is to them that we owe the origin of the examination system. Their severance from a portion—and that the highest portion—of the examination is therefore a notable event in the history of the Tripos. Neither the Board nor the University would have agreed lightly to such a break in the traditions of the Senate House examination, had it been possible to retain the Moderators as examiners for the final part without altering the system of nomination by colleges. The complete separation of Part III. from the earlier parts of the examination was, however, inevitable. Many members of the University who would discharge most admirably the duty of examining for Parts I. and II. would shrink from Part III.; and the professors and specialists who were best fitted to examine in Part III. would generally be reluctant to undertake the heavy burden of examining all the candidates for Parts I. and II., especially in two consecutive years.

Thus, by the irresistible pressure of events, it has come to pass, in the last few years, that not only the titles of wranglers, senior optimes, and junior optimes have lost their old significance and refer only to the earlier examination, but that even the more ancient title and office of Moderator has undergone a similar restriction. The final part of the examination has indeed made rapid progress: within three years of its first coming into existence it has emancipated itself from union with the earlier parts, and become an independent examination.

Besides these important innovations, the Senate sanctioned at the same time a slight change in the nomenclature of the Tripos, the earlier portion of the examination, previously called Parts I. and II., upon which the list in order of merit depended, being designated Part I., and Part III. being henceforth designated Part II. This change was made in order to bring the nomenclature of the Mathematical Tripos into harmony with that of the Classical and other divided Triposes.

As soon as Part II., to adopt its new name, became an independent examination, the Board directed its attention to the schedule of subjects relating to it. The existing schedule contained only those subjects which had been included in the schedule which came into operation in 1873, when the results of the whole examination were still expressed by one final list, arranged in order of merit. Now that Part II. was a separate examination, and that there was no order of merit, the reasons for the limitation of the subjects had been entirely removed. Although the theory of elliptic functions, which dates only from the publication of Jacobi's "Fundamenta Nova" in 1829, was included, the theory of numbers, which had its origin in Gauss's "Disquisitiones Arithmeticae" of 1801, was still excluded. Abelian functions, the theory of functions of a complex variable, projective geometry, and quaternions were not formally included by name, and questions on these subjects could only be set, if at all, by straining the meaning of the title of some other subject. Besides the total exclusion of certain branches of pure mathematics, a further reason for revising the existing schedule was afforded by the fact that the four groups A, B, C, D were very unequal both in magnitude and popularity among the students. According to the existing regulations the four groups had to be equally represented by questions,

¹ It is still the custom for the list of wranglers, senior optimes, and junior optimes to be shown to the senior Proctor on the evening of the day before it is read in the Senate House. This is doubtless a relic of the fact that the Moderators were originally the substitutes of the Proctors. It has been already mentioned that the Proctors, as well as the Vice-Chancellor, used to have the right to insert a certain number of names where they pleased in the Tripos list.

¹ Address delivered before the London Mathematical Society by the President, Mr. J. W. L. Glaisher, M.A., F.R.S., on vacating the chair, November 11, 1886. Continued from p. 197.

and this led to a great waste of examining power, many questions having to be constructed each year upon subjects which none of the candidates had studied. The Board accordingly formed a schedule in which all the subjects of pure and applied mathematics were included—none being intentionally omitted. These were divided into eight divisions, the first four relating to pure mathematics, and the last four to applied mathematics. To avoid the waste of questions that would ensue from the examiners having to represent all the subjects in the papers in each year, they proposed that before the first day of December preceding the examination the names of the candidates and of the divisions and subjects in which they desired to be examined should be forwarded to the Registry of the University. The examiners would thus be made acquainted with the subjects which the candidates had studied, and would be able to frame their questions accordingly. Changes were also proposed with respect to the candidates who were admissible, and to the form of the final list. By the existing regulations only wranglers were allowed to present themselves for examination in Part II., and the list was arranged in three divisions; there was no separation into *classes*, because, as only wranglers were admissible, it was considered that all the candidates were first-class men from the beginning. The new proposals were, that the restriction which admits only wranglers should be removed, and that the candidates should be divided into three classes, each class being subdivided into as many divisions as the examiners in each year thought proper. In previous schemes the endeavour of the Board had been to frame regulations that would tempt the students to specialise their reading. A few years had made so great a difference that, with a view to prevent undue specialisation, the Board now inserted a regulation to the effect that proficiency in subjects taken from more than one of the divisions should be requisite in order that a candidate might be placed in the first class.

The Report containing these proposals was confirmed by the Senate on May 27, and it is noteworthy that both this Report and its predecessor, in which the nomination of examiners was placed in the hands of the Board, were sanctioned without opposition of any kind. The latter of these Reports also made a few minor changes, the most important of which was the omission of the problem paper which had been still retained, from the old five days, in the scheme of 1882.¹ The examination in Part II. had assumed such a character, that the kind of questions to which one would usually apply the name of problems was no longer in keeping with the contents of the other papers.²

Under the new scheme, in which all the examiners were to be appointed by the Board with special reference to their collective fitness for conducting the examination in Part II., there was no further need for an Additional Examiner, and this office was, accordingly, discontinued.³

Thus has the Mathematical Tripos been divided into two parts; and thus has surely arisen in the University

¹ Although the Board were unable to make any recommendation upon the subject, I may mention that the principle of prefixing to the final three days a preliminary day, in which the subjects of examination should be those parts of higher pure mathematics which are needed in mathematical physics, found a considerable amount of favour on the Board. The proposal, however, was found to be more difficult in execution than was anticipated (partly on account of the impossibility of forming a perfectly satisfactory schedule of subjects for this day), and was ultimately abandoned by most of its original supporters.

² In the first examination in Part III., in 1883, the examiners set, as one of the question papers, a paper of essays; and their example was followed by the examiners in 1884, 1885, and 1886. These essay papers were introduced merely on the authority of the examiners, and not in consequence of any new regulation. Experience seems to show that the essay paper affords very little additional assistance in ascertaining the relative merits of the candidates. The essays were, perhaps, more useful at first, when they were a novelty.

³ Unless the office should be revived at some future time, there will therefore have been only one Additional Examiner for the final part of the examination, viz. in 1886, the last occasion of the examination taking place in January.

a mathematical examination of a higher type than has been known before, or could have existed under any system in which all the candidates for mathematic honours were required to be examined by the same papers throughout. For those who study mathematics for the sake of exact knowledge or mental discipline, or who propose to go forth into the world to follow professional or other careers, the first part secures all the old stimulus to industry, and gives to those who are successful the same stamp of intellectual distinction as before: such students are released at the end of the third year to enter upon the active duties of their lives, equipped with a sound understanding of the principles of the exact sciences, and with minds well trained to accurate habits in reasoning and in the acquisition of knowledge. To those whose attachment to our sciences lies deeper, and whose studies have carried them beyond its threshold, the second part, at the end of their fourth year, affords an opportunity of distinction of a higher kind, and one more suited to their tastes: no longer is the wide and thoughtful student hopelessly distanced in the Tripos race by his quick and ready rival.

The wants of the candidate whose mathematical cares close with the last paper in Part I., and of the candidate whose mathematical life only begins from this moment are equally provided for by the new scheme. The order of merit relates to an examination that can bear it. All the subjects included in Part I. are such as ought to be the common property of every one who has received a sound mathematical education; and by the results of an examination in subjects which all the candidates should have read a list in order of merit can properly be formed. The specialist for the first time is set free to follow his own tastes, and give his whole heart and time to the branches of mathematics by which he is attracted. If the University permits him to select any subjects he pleases from the whole range of pure and applied mathematics, and undertakes to examine him in them and award him the credit he deserves for his attainments. A perfectly free choice is given to him, subject only to the condition that, in order to qualify himself for admission to the first class, he must not select all his subjects from a single division.¹

But what to us as mathematicians is more than all, and bearing on the future of our science, is that now for the first time will it be possible in Cambridge for an able and earnest worker and teacher to interest and engage his pupils in his work, and found a school such as we are so familiar with in foreign Universities, where the presence of a great professor has been almost invariably marked by a succession of illustrious pupils—pupils worthy their master, and worthy to carry on his work. This of the school of arithmeticians founded by Gauss at Göttingen, and how impossible such a result would have been at Cambridge, dominated as she has been by the competition for places in the Tripos! Great as has been the value to the University of the order of merit—as a stimulus to industry, an encouragement to thoroughness in mathematical study, and a paramount influence in regulating elections to Fellowships at colleges where independent examination existed—it has yet been in recent years a deadly enemy to the spread of research and the advance of our science. Throughout his career the student has had to devote himself unremittingly to the work for his Tripos, taking up a fresh subject each term, and often having to read two in one term. It could never pursue any subject far enough to reach the really interesting portions of it, or obtain complete

¹ This condition would be complied with by the candidate's showing proficiency in one subject taken from one division and in one other subject taken from one other division. The intention of the Board was to discourage students from specialising too narrowly at too early a period. Some of the divisions (as, for example, the fourth, which contains only projective geometry and analytical geometry of curves and surfaces) are so restricted that it was considered undesirable that students should be allowed to confine themselves entirely to subjects chosen from a single division.

command over its methods: he was always occupied with something new, starting afresh and gaining familiarity with new principles, new processes, new modes of thought. Many of the higher lecturers in the University were necessarily neglected by the students: they could pay but scant attention to any subject which was not adequately represented in the Tripos, and even in the case of the subjects which were so represented they were tempted to pass lightly over those investigations, however important, which from their length and character were unsuitable for reproduction in an examination. Now, however, all this is history. When a good course of lectures upon any high subject is given in the University, those students who have attended the course will send in that subject as one on which they desire to be examined: it will, therefore, be properly represented by questions; and the subject will become one that will be increasingly studied year by year. It will now be possible for any capable mathematician, by means of his lectures, to gather pupils round him who will bring his subject into prominence, and make it one of special study in the University.¹ It has been said that in mathematics we have in England generals without armies: the great men who are independent of circumstances have arisen among us, but where are the rank and file? It is my belief that the great obstacle to the existence of the rank and file has now been removed.

Whatever else it may be, Part II. is at all events a "limiting form." No wider choice of subjects could be given to the candidates; no greater freedom to the examiners. The schedule of subjects includes all mathematics: the examiners may issue any kind of list. By introducing numerous divisions into the classes they may make it approximate as closely as they please to an order of merit; or, on the other hand, they may make it merely a class list. They are empowered to give to their list just such a form as they feel justified in doing by the results of the examination. In the appointment of examiners, also, the limiting form has been reached, all four being nominated by the same University authority, and holding office for one year only.

With respect to Part I., it may be that the ultimate form has not yet been reached. There are some who think that, as in some other Triposes, the students should have the option of becoming candidates at the end of their second year. It would seem, also, that the range of subjects is rather too restricted; and, as may be inferred from what I have said near the beginning of my address, I should myself like to see the elementary portions of elliptic functions included in the schedule of Part I. Still, these are but minor points; and I think that the principle of subjecting all the candidates for mathematical honours to one and the same examination in comparatively elementary subjects, and arranging the list in order of merit, meets with general approval.

A few years ago, when the old Tripos was exerting its stifling influence upon the higher mathematical studies of the Universities, I felt disposed to welcome the abolition of the order of merit as the lesser of two evils; but now that the Tripos is divided, and that the mathematician has his own examination especially framed for him, I should be sorry to see a modified class list substituted for the order of merit in Part I. A severe competition for places has the great advantages of keeping the candidates closely employed, and extracting from them their best work. At present an immense amount of thoroughly good mathematical work is done in the University. We have received from our predecessors a system under which the principles of mathematics are efficiently taught, the powers of the students are

exerted to the utmost, and upwards of a hundred persons each year receive a mathematical education which is in some respects unique. These are substantial advantages which should not lightly be jeopardised or exchanged for others that are problematical. Under any other system I think the quantity and the quality of the mathematical work done in the University would suffer. It should be remembered also that there is no subject in which the knowledge of a candidate can be so readily tested by examination as in mathematics, and that in no other subject can the results of an examination be expressed with such certainty and accuracy by an order of merit.

I believe there are indeed but very few who have graduated in the Tripos who would set a slight value upon the advantage which their mathematical training has been to them throughout life; and on the other hand I think that it has been an indirect benefit to our science that among those who have won distinction in public and professional life there have always been some—and those not the least influential or eminent—who have passed through an extensive and thorough course of mathematical study, and to whom our world of symbols is no *terra incognita*. The fact that our results, unlike the conquests of astronomy and other branches of applied mathematics, can only be expressed by means of a language of their own, requiring years of study, imposes of necessity such narrow limitations upon the numbers of our audience that we cannot be insensible to the advantages of any system by which the power of understanding and appreciating the beauties of our science is extended to others external to our own ranks. Under the new scheme these advantages are still retained; and, difficult as is the problem of combining a mathematical course for the many with the technical requirements of the few, I believe that a satisfactory solution has rewarded the efforts of the last twenty years. I believe that the University of Cambridge will become a great centre of mathematical research and a home of the exact sciences, and that it will be found that these objects have been attained without any sacrifice of the general efficiency of the training received by the bulk of the candidates for mathematical honours.

On taking a survey of the history of the Tripos during the last half century, perhaps the feature that stands out most strongly is the part played by the subjects of electricity and magnetism—their half-recognised existence before 1848, their exclusion until 1873, and the effects which followed their restoration in that year. It was the extension of the dominion of mathematics over these great and growing branches of physical science that broke down the old system. Electricity and magnetism became too important to be excluded; but when included the examination in its old form was too heavily weighted to exist.

The year 1877-78, in which the syndicate of 1877 was endeavouring to frame a scheme that should relieve the strain of the excessive competition without sacrificing the order of merit, was perhaps the most eventful period in the whole history of the examination: it then became evident that it was impossible to retain the existing system even in a modified form, and that a complete re-organisation of some kind was inevitable. Although the frequent changes in the last few years have been productive of some inconvenience, I think it is fortunate that the syndicate was so reluctant to propose any sweeping changes, and that the present scheme has come into existence as it has done—not as the work of any influential legislator, but as the form which the examination has of itself assumed under the pressure of the actual forces at work in the University. The order of merit for the whole examination was not given up till it was clearly shown that its retention was an impossibility; and, on the other hand, Part II. has grown up by a process of regular development, and been moulded into

¹ In the schedule for Part II. no subjects are ignored or favoured less than others, so that by the new scheme provision is made for the growth of any subject which may happen to take root.

its present form by those most interested in promoting the higher mathematical studies of the University.

Special reference also should be made to the "three days." It will be remembered that this preliminary portion of the examination was the principal feature of the scheme which came into operation in 1848. Both the subjects and the methods of solution that may be employed are defined by a schedule, and only those who satisfy the examiners by their performances in these three days are admitted to the subsequent parts of the examination. It is very singular that an arrangement devised so long ago should not only still continue in force, but even be regarded by some as the most thoroughly satisfactory portion of the whole system. The framers of this scheme and schedule might well have been proud of the lasting character of their work if they could have known that it would outlive two sets of University statutes, and, amidst changes on every side, remain unchanged for forty years.

The early history of the Tripos and its gradual development into an examination by written answers, and finally by printed papers also, are especially interesting in these days, when the merits of the examination system are so highly appreciated, and its adoption is so universal. The Senate House at Cambridge is the cradle of the modern form of examination in England.

In connection with the Tripos there is one matter of so much importance that I cannot pass over it entirely without mention. I mean the influence of the system of private tuition. I believe that while there is an order of merit it will always be a great assistance to the majority of the candidates to read with a private tutor. Mathematics is a difficult science; and when a considerable range of subjects has to be traversed in a comparatively short time, and the knowledge of the candidate has to be finally tested by an examination such as Part I. of the Tripos, it cannot fail to be a great advantage to him to have his difficulties explained, his path smoothed, and his skill in working out problems developed, by an experienced private tutor specially interested in his individual welfare. The system of private tuition has been objected to from two points of view: (1) because it is unsatisfactory that the instruction which is valued most highly by the student should be received from his private tutor instead of from college lecturers or University professors; and (2) because the student who has followed implicitly, during his whole undergraduate career, the minute directions of one man with regard to his reading, is placed after his degree, when he is deprived of his guide, in a very unfavourable position for pursuing further his mathematical studies. The first objection does not concern us here: my own feeling is, as I have just said, that, whenever an order of merit exists and the competition for places is keen, the services of private tutors will necessarily be called into requisition. The second objection is one which is of far more importance to our science. There can be no question that, brilliant and eminent as have been the greatest of the private tutors at Cambridge, one result of the system has been that many of the ablest students have been left after graduation not only without any knowledge of the way to follow up the study of the subjects of which they had learned the elements, but even without any taste or inclination to do so. The private tutor's manuscript and verbal instruction had superseded all need of referring to the original memoirs, and the nascent wrangler knew nothing of the great world of mathematical literature or of the modes of reaching it. On the other hand, it is only fair to say that the amount of mathematical knowledge acquired by the best pupils from their private tutors in the course of their undergraduate career was really wonderful; and that till quite recently neither the University nor the colleges offered

any inducement to the mathematical student to continue his reading after the Tripos. The fact that the student's horizon should have been bounded by the Tripos, and that his training should have been directed with the view to giving him skill in working out questions rather than developing his taste for the science he was studying, was principally the fault of the system as a whole; but it was certainly intensified by the complete subjection of the pupil to the course of reading placed before him by the private tutor. A student whose interests and aspirations had been at least held in check, and perhaps entirely stifled, throughout his whole undergraduate career, generally too subdued or helpless to be able to use of his freedom when the examination was over.

Under the new scheme the private tutor still occupies in the main his old position with respect to Part I., although, of course, the higher places in this examination have much less significance than before. With respect to Part II. it is quite different. No attempt is made by private tutors to teach these higher subjects, which, both from their character and extent, are clearly unsuited for private tuition; and the students are compelled to rely upon the lectures delivered in the colleges and University in their preparation for this final examination. Thus, in their fourth year they are brought into contact with the leading mathematicians in Cambridge; and when the examination sets them free to pursue their own studies or researches, they start on their new career fresh from the best teaching which the University affords.

Although the subject of my address is the Mathematical Tripos, it may be regarded as still falling within my province to refer to other changes that have taken place in the University for the purpose of encouraging original mathematical work. Fourteen years ago Trinity College invited mathematical candidates for Fellowships to send in, before the examination, dissertations upon any subjects of their own selection. It was announced that these dissertations, if possessed of decided merit, would be taken into account in the Fellowship election, together with the results of the Fellowship examination. Not only have these dissertations been of the greatest value in guiding the choice of the electors, but many of them have been important contributions to mathematical literature. The example of Trinity College has been recently followed by St. John's College and King's College. The Smith's Prizes, which for a great number of years have been awarded by a special examination, are now awarded annually for mathematical dissertations, the candidate being free to select their own subjects. This new scheme passed the Senate on October 25, 1883, and the first award of the prizes under it was made in 1885. Powerful inducements are, therefore, now held out by the University some of the colleges for the best students to devote themselves to original work. The importance to our science of these direct incentives to research cannot be overestimated. They come into operation as soon as the stimulus of the examination is removed, and, instead of resting upon their laurels, the ablest mathematicians the year are induced to concentrate their powers upon single subject, just at the time when they are undaunted by any amount of hard work, when their stock of general mathematical knowledge is freshly acquired, and when their minds are flexible, vigorous, and free from care. It is indeed strange to look back upon the changes of the last few years, and to contrast the encouragement

¹ Among the Trinity dissertations which have subsequently been printed I may mention the late Mr. R. C. Rowe's "Memoir on Abel's Theorem" (*Phil. Trans.*, 1881), Mr. Forsyth's "Memoir on the Theta Function" (*Phil. Trans.*, 1882), Mr. Homersham Cox's "On the Theory of the Group of Order 24" (*Phil. Trans.*, 1882), and Grassmann's "Ausdehnungslehre" (*Phil. Trans.*, 1882), Mr. Gallop's "Distribution of Electricity on the Circular Disc and Spherical Bowl" (*Quart. Math. Journ.*, 1886), and Mr. R. Lachlan's "Systems of Circles and Spheres" (*Phil. Trans.*, 1886).

given to mathematical research with the indifference, or even worse, of twenty years ago.¹

I cannot close my address without saying a few words upon our Society. We were founded in 1865, and so today we attain our majority. I think we can safely say that we have steadily and uniformly kept to our single purpose of promoting the advance of mathematics. We have published seventeen volumes of *Proceedings*, and every paper we have printed has been subjected to a rigorous examination by two referees. We already have a history to look back upon: familiar presences among us—De Morgan, Clerk Maxwell, Clifford, Henry J. S. Smith, Spottiswoode—have passed away; and for most of us this very room is full of associations with those whom we shall see no more. I should like before concluding to formally express our gratitude to our two Secretaries, Mr. Morgan Jenkins and Mr. Robert Tucker, who have served us so faithfully almost from our foundation, and to whom the successful development of our Society has been largely due. I will not utter any aspirations with regard to our future: we shall never be a great Society in numbers, but we can continue to do what we have done, and to spare no effort to encourage the advance of mathematical science.

THE INTERNATIONAL COMMITTEE OF WEIGHTS AND MEASURES

THE results of the scientific investigations made under the directions of the Comité International des Poids et Mesures at their Bureau at Sèvres during the past year are stated in vol. v. of their "Travaux et Mémoires," recently published (Gauthier-Villars, Paris, 1886) under the authority of the Director of the Bureau. This volume contains the following papers:—"Note sur l'étalonnage des sous-divisions d'une règle, sur l'étude des erreurs progressives d'une vis micrométrique, et sur le calibrage des thermomètres," by Dr. O. J. Broch; "Études thermométriques," by M. Ch. Ed. Guillaume; "Études sur la balance," by Dr. M. Thiesen; "Sur quelques analyses chimiques faites pour le Bureau International," by M. Tornøe. The two latter memoirs, however, are published under the responsibility of their authors.

In the method of calculating the errors of the subdivisions of a standard measure of length, or of calibrating a thermometer, Dr. Broch has followed the celebrated astronomer P. A. Hansen; but he has endeavoured to render Hansen's method more simple; and he has abbreviated it and reduced the number of observations, without increasing the probable error of the results obtained. Convenient tables of equations are given for the more ready application of Hansen's formula, and also examples of an abbreviated method for calculating the several lengths of the decimetres, centimetres, and millimetres on a subdivided standard metre.

The second part of this Note deals with the progressive errors of the micrometer-screw. As each interval to be measured on a linear standard is contained within two lines, we have to pass by successive turns of the micrometer-screw from one line to the other. Each line in turn is bisected by means of cross or of parallel webs; and not only do the personal errors of bisection have, of course, to be allowed for, but even small errors in the micrometer-screw itself have to be corrected. Examples of such corrections are given in this note. In considering the progressive errors of micrometer-screws, we are not sure that Dr. Broch has sufficiently, however, investigated the variation in the amounts of such errors owing to the wear of the screw.

In the third part of the note is given an explanation

¹ Under the old system, the Cambridge graduate who devoted himself to mathematical research possessed one advantage over his Continental colleagues in the wider range of his general mathematical knowledge. Although Part I. is considerably more restricted than the Tripos of 1848-72, this advantage is still retained to a substantial extent.

of an abbreviated method of calibrating graduated glass tubes or thermometer-stems, and of applying corrections to the calibrated lines. The method of interpolation by differences is also discussed and simplified.

Dr. Guillaume, in his "Études thermométriques," continues the thermometric work which was begun by Dr. Benoit, and by Pernet at this Bureau. It is required of all standard thermometers verified at the Bureau, that they should carry the fundamental points 0° and 100° C.; that they should have a total length of as much as 70 centimetres, the diameter of the stem varying from 3.5 to 5.5 millimetres; and that each division should be nearly 5 millimetres in length. The testing of the thermometers includes the three distinct operations:—

- (1) Division and calibration.
- (2) Determination of the coefficient of pressure (when the thermometer is placed alternately in a vertical and in a horizontal position).
- (3) Determination of the fundamental points and of the mean value of each degree.

It is with these operations, as well as with the actual verification of certain standard thermometers at the Bureau since the year 1883, that Dr. Guillaume now deals. The paper is an interesting one, and all the observations are printed in the fullest detail. Particularly in that part of this paper which discusses the variations in the readings of thermometers by time and circumstance, there is much to be learnt.

Of late, attention has been given, especially in Germany, to the kind of glass best adapted for thermometers, the zero-points of thermometers made of some kinds of glass, being found less likely to alter by age like ordinary thermometers. A careful analysis made by M. Tornøe of the glass used for the bulbs of two of Tonnello's thermometers used at the Bureau, gave the following results:—

	Hard glass	Plate glass
Silica	71.52	60.68
Sulphuric acid	0.72	0.37
Chlorine	traces	—
Peroxide of iron	0.22	—
Lime	14.55	5.44
Soda	10.81	10.50
Potash	0.37	6.55
Magnesia	traces	traces
Protoxide of manganese	traces	—
Oxide of lead	—	15.12
Alumina	—	—
Alumina, with traces of iron and manganese	—	0.87

The analyses of the stems of the thermometers showed somewhat different results.

The memoir by Dr. Thiesen, "Études sur la balance," continues the excellent work on the construction and use of the balance which was originally begun at the Bureau by M. Marek. In the "Théorie générale de l'équilibre statique de la balance," and in the "Calcul de l'équilibre de la balance," Dr. Thiesen has discussed the conditions which affect the equilibrium of a balance, and also has investigated the effects of outside influences during weighings, as those arising from currents of air and from changes in the condition of the air; and from electrical disturbances, magnetic and radiometric. A good balance may be relied on to 0.001 mgr. in the comparison of two standard kilogramme weights, but outside influences increase the probable error to ± 0.004 mgr.

The labours of the Bureau have been particularly devoted to the perfecting of existing methods, and they have resulted in the attainment of far higher accuracy in weighing and measuring than was thought to be possible, or necessary, even ten years ago. We trust that the labours of the Comité may soon be crowned by the completion of the international metric standards of length and weight, for which all their present investigations are preparatory.

NOTES

MR. C. L. GRIESBACH, lately geologist to the Afghan Boundary Commission, and deputy superintendent of the Geological Survey of India, has been appointed by the Viceroy to officiate as superintendent.

THE annual meeting of the Association for the Improvement of Geometrical Teaching will be held on Friday, January 14, 1887 (11.30 a.m.) at University College, Gower Street. At the afternoon meeting (2 p.m.) the following papers will be read:—"On the Teaching of Modern Geometry," Rev. G. Richardson; "The Modern Treatment of Maxima and Minima," Rev. J. J. Milne; and on "Geometry from an Artist's Point of View," G. A. Storey, A.R.A. The meetings are open to all who are interested in the objects of the Association.

OUR readers will be interested to hear that at the meeting of the British Association recently held in Birmingham, a movement was originated in the Committee of Section D (Biology) having for its object an application to Government for a small grant out of the Civil List to Mr. Thomas Bolton of Birmingham, whose important services to science as a naturalist and microscopist have long been well known and appreciated. A memorial setting forth Mr. Bolton's claims was prepared by Mr. W. R. Hughes, late President of the Birmingham Natural History and Microscopical Society, and was signed by Sir J. W. Dawson, the President of the British Association, and by a large number of eminent men of science. It also received the signature of the Mayor of Birmingham. The memorial was recently presented to Lord Salisbury as First Lord of the Treasury, who has recommended that Her Majesty grant Mr. Bolton a Civil List pension of 50*l.* per annum.

THE finest of all Japanese botanical books is the Honzo Dsufu. It is also from a scientific point of view the most valuable, inasmuch as it contains excellent coloured figures of no less than 1500 species of Japanese plants, of many of which there are no other published representations. Franchet and Savatier, in their "Enumeratio plantarum in Japonia sponte nascentium," quote throughout the copy in their possession, which was not, however, quite complete. It is in ninety-six volumes, or rather *livraisons*, and is rare even in Japan. It was prefaced in 1828, but only the first six *livraisons* have ever been printed, and the rest only exists in hand-made copies. It has long been desired to obtain a copy for the library of the Royal Gardens, Kew, and this wish has at length been gratified by the kind liberality of Mr. Tokutaro Ito, grandson of the well-known Japanese botanist, Keisuke Ito. Mr. Ito is now studying botany at the University of Cambridge, and lately communicated a revision of Japanese *Berberidacea* to the Linnean Society, of which he has recently been elected a Fellow. The Kew copy of the Honzo Dsufu is probably the finest to be obtained in Japan. It came from the library of Senator Tanaka (himself a distinguished botanist), who, with extraordinary generosity, placed it at the disposal of Mr. Ito for presentation to Kew.

IN the *Annalen* of the Vienna Natural History Museum, Herr von Pelzeln and Fr. von Lorenz have just published the first of a series of articles on the types of birds contained in that Museum. This cannot fail to be of the greatest use to students, who often require to know the present resting-place of typical specimens. Following the Cuvierian arrangement as adapted by Gray in his "Hand-list of Birds," the authors present, as a first instalment, a list of the types of the *Accipitres* and *Tenuirostris*. The chief interest naturally centres round the species procured by Johann Natterer in Brazil, for nothing more wonderful is known in the history of ornithology than the way in which Natterer's collections, made in the early part of the present century, still remain the basis of our knowledge of the ornithology of that country, and, notwithstanding the subse-

quent efforts of travellers, there are numbers of Brazilian species obtained by Natterer alone, and unrepresented in any Museum except that of Vienna. Curiously enough, too, the Vienna Museum also possesses several of Latham's and Shaw's types founded on the specimens in the Leverian collection, and purchased in 1806. The value of a type was not understood in England so long ago as 1806, and the specimens were allowed to leave the country, to find a home in Austria. Such would scarcely be permitted now, under the enlightened management of our authorities at the Natural History Museum at South Kensington, who are doubtless mindful of the disgrace attaching to the British Museum in former years, when that institution allowed the whole of the Gould collection of Australian birds, with its 300 types, to go for 1000*l.* to America, where it now lies, scarcely heeded, in the Museum of the Academy of Natural Sciences of Philadelphia. Let us hope that the Gouldian type are better looked after in the Philadelphia Museum than some of the types of Du Chaillu's Gaboon species, which are no longer forthcoming, to the no small embarrassment of ornithological students.

PROF. MENZBIER has recently published, in the *Bulletin* of the Society of Naturalists of Moscow, an account of the birds collected by Mr. Zaroudnoi, a Russian naturalist, who has been exploring the oasis of Akhal-Tekké, the Kara-Kum desert, and the adjacent mountains, in Central Asia. The want of funds appears to have crippled the efforts of the traveller to a great extent, but he managed to procure 184 different species of birds, though his observations were confined to the summer months and early autumn. Mr. Zaroudnoi found several rare species nesting, and besides his own observations there are interesting scientific notes from Prof. Menzbie's pen. We are informed that the traveller has recently prosecuted a further expedition into Khorasan and Northern Afghanistan, the result of which may be expected to be of considerable importance to zoologists.

THE *Auk*, which is the journal of the American Ornithologists' Union, and answers to our English *Ibis*, has just completed its third volume, under the able editorship of Mr. J. A. Allen, who is the President of the American Ornithologists' Union. The present volume abounds in interesting memoirs, and fully maintains the high standard of the journal. The Union now numbers 46 active members, 112 associate members, 26 foreign members, and 59 corresponding members. The Committee on the Migration and Geographical Distribution of North American Birds and for the Protection of North American Birds have both done excellent service during the past twelve months.

MR. G. H. HINSBY, of Hobart Town, has forwarded us a useful list of the birds of Tasmania: 178 species are found in that island, but the author is apparently unaware that several Tasmanian birds to which he gives the same scientific name as the Australian species are considered by recent writers to be peculiar to Tasmania itself.

A RECENT issue of the *Japan Weekly Mail* contains a report of the Japan Educational Society, an association founded to bring together persons interested in education, to assist in its diffusion, and to improve and advance education in the country. Besides general and ordinary meetings in furtherance of the objects of the Society, members are frequently sent to various localities at the request of local educational institutes for the purpose of delivering addresses or lectures. Thirty-three numbers of the memoirs have been published, the total number printed being 100,000. In addition, books under the title "Hints to Educators" were published, and 7000 copies printed. The number of members is 3000, and a prince of the Imperial House is President.

UNDER the title of a "Descriptive List of Native Plants of South Australia recommended for Cultivation," Mr. J. G. Otto Tepper, F.L.S., has reprinted in pamphlet form some notes that apparently appeared periodically in Adelaide. As a reason for publishing the list Mr. Tepper says:—"At the rate South Australia and its sister colonies are progressing in civilisation, the time can easily be foreseen when for long distances from any centre of population not a mark would be discoverable where any one could view the native vegetation in its natural state. Owing to the very local distribution of many Australian herbs, shrubs, and trees, there is even the possibility that they may be entirely extirpated, caused by ruthless and ill-judged clearing, depasturing of domestic animals, choking by introduced weeds, and the diminution of the moisture in the soil by the first two causes. Few attempts are made to cultivate any, so far as we know, though a few (for example *Kennedyia monophylla*) have already found their way to the favour of gardeners, who, perhaps, do not even know that these plants are indigenous." The list consists of a number of plants belonging to very different natural orders and of very different characters, such as herbs, trees, shrubs, &c., as may be instanced by species of *Mesembryanthemum*, *Viola*, *Acacia melanoxylon*, &c., &c. To each plant its habit and size are given, a short description of the leaves and flowers, time of flowering, and nature of locality where found. The descriptions, however, are by no means equal in point of detail, some being considerably longer than others. To some of the plants the natural orders are stated, while to others no mention whatever is made. No references are made to the uses of the plants, and no kind of arrangement of genera has been adopted, either scientifically, alphabetically, or in any other way. The list may be of use to those for whom it has been written, but it would have been more valuable if some arrangement had been adopted by which any given plant could have been found without wading through the whole nineteen pages.

MR. STEVENS, the Queensland naturalist whose visit to the Veddas of Ceylon we have already mentioned, addressed a recent meeting of the Asiatic Society of Ceylon on this little-known people. He found the time at his disposal on his first visit too short to investigate satisfactorily the problem of their origin, but he intends going amongst them for another six months on his approaching return from India. He has offered to live with them for a year or two if such a long absence from his other duties can be arranged. He regards the popular notion in Ceylon of the Veddas as a cruel, vindictive, suspicious people as wholly erroneous. He found them truthful, hospitable, and honest, but they exhibit a marked aversion to Singhalese and Tamils. They are very peaceful, and hence a European can travel amongst them in perfect safety and freedom. They have a language of their own which the Singhalese do not understand, and of which he collected a considerable number of words for examination by Oriental scholars. They are expert archers, and can send an arrow completely through a wild animal. Mr. Stevens would prefer to face a rifle in the hands of an experienced person at fifty yards' distance rather than a Vedda armed with his bow. They have no idea of boiling anything; they use the fire-drill, and they appear to have had sufficient knowledge of working in metals to supply themselves with weapons. He questions whether there are 500 Veddas in all Ceylon, so that soon it will be difficult to find a real one. Hence he urges the great importance to science of a thorough study now of their language and habits. Demonology is, he thinks, an incorrect term to apply to their religion; it is, rather, "Kapuisim." They do not believe in the existence of any injurious or malevolent spirits. Once a year the whole of a Vedda encampment make a propitiation; it is not worship, but simply a propitiation to the eight or nine gods of their pantheon. They divide themselves into eight clans,

which rank in a kind of social gradation, depending, in some instances, apparently on their traditional origin. He obtained skulls of representatives of seven of these clans. Throughout the address, Mr. Stevens constantly insisted on the tentative nature of his investigations so far. His facts, "or, rather, supposed facts," are entirely unverified. They require assortment and further examination, and he urges societies and students in Ceylon to undertake the work. It is greatly to be hoped that Mr. Stevens himself may be able to carry out his project of residing amongst the Veddas for a prolonged period, and studying them from the inside, and, in a certain degree, as one of themselves. One of his facts requires no verification, viz. that he can live and travel amongst them with safety, and that he has the capacity for making friends of them.

M. DE QUATREFAGES, at a recent meeting of the Geographical Society of Paris, advanced the theory with regard to the migration of peoples at a remote period of antiquity, which, at a subsequent meeting, was discussed and approved by M. H. Chevalier. The theory is that these migrations were due essentially to the gradual increase of cold in the northern regions, which forced the inhabitants to wander to the south in search of a more temperate climate. M. Chevalier quoted certain passages from the Zend Avesta, which, he argued, corroborated this theory.

A PROSPECTUS has been issued by the Council of the "Lochbuie Marine Institute" on the Isle of Mull, recently established under the auspices of the National Fish Culture Association, setting forth their objects. One of these is to incubate herring-ova to re-stock such locations in Scotland as have been depleted of that fish through the action of fishermen in exhausting the supply under the belief that they were general instead of local. Meteorological and other observations are also to be carried out under the direction of Mr. Anderson Smith.

DR. FOREL sends us the following list of recent earthquakes in Switzerland:—December 16, 16h. om., at Sarnen (Unterwalden); 22, oh. 3m., 4h. 20m., and 5h. 30m., at Pontresina (Grisons), all Greenwich time.

WE have referred on several occasions to the extraordinary number of rats which emerge from various parts of the building when the late Exhibitions at South Kensington have closed and the supply of food is cut off. This year their number has been larger than ever, and shortly after the termination of the late Colonial and Indian Exhibition the rats, desperate with hunger, invaded every part. During the summer nothing would induce them to enter traps, whereas now they rush in as fast as they are set, and not until they have devoured the bait do they seem to realise the fact that they are prisoners, when they seek deliverance in their usual wild fashion. During last week their cravings for food culminated in a fierce onslaught upon one another, which was evidenced by the piteous cries of those being devoured. Their method of seizing their victim is to suddenly make a raid upon one weaker or smaller than themselves, and after overpowering it by numbers, they tear it in pieces. At the present time there cannot be found a single young rat in the building. So far this is satisfactory, as the large numbers bred during the summer will thus become exterminated.

AT present the city of Worcester possesses a public free library and natural history museum in one building, and a Government school of art in another. It is proposed to celebrate the Queen's Jubilee by establishing an institution to be called the Victoria Institute in a central position in the city, in which the existing library, museum, and school of art will be placed, and to unite with them in the same building a school of science and an art gallery. The cost is estimated at 18,000*l.*, of which the Corporation have voted 7000*l.*, and the old site and other sources of income will leave only about 5000*l.* to be raised by

public subscription. A considerable portion of this amount has already been raised.

A LATE issue of the *Batavia Dagblad* contains a report of a paper read by Dr. Cornelissen, of the Java Medical Service, before the Society for the Advancement of Medical Science of Java, on his researches in Acheen, in Sumatra, into the causes of the dreaded disease *beri-beri*, known as *kakke* in Japan—a species of elephantiasis. Dr. Cornelissen comes to the unexpected conclusion that it is infectious, and is propagated by bacilli. He accordingly recommends a thorough system of disinfection in hospitals and troop-ships where patients suffering from this malady have been kept. The theory has caused much excitement in Java and the neighbouring regions where the disease prevails, for it has not hitherto been suspected that it was infectious. Dr. Cornelissen's theory, however, does not appear to be generally accepted in Java and the Straits Settlements.

IN the current number (27) of *Excursions et Reconno* of Saigon, M. Aymonier brings to a conclusion his notes on Annam, the particular province dealt with being Khanh-Hoa. The most interesting part of the paper is the sketch of the so-called savages, or Mois, inhabiting the mountains of the province. These papers have now been running through many numbers of the periodical, and are encyclopædic in their nature. M. Aymonier is, beyond question, the greatest living authority on Cochin China generally, and he undertook prolonged journeys into various parts of the country with a view to perfecting his information for this series. His original intention was to explore the whole coast of Annam up to Tonquin, but the rebellion of 1885, which resulted in frightful massacres of missionaries and native Christians, prevented him from carrying out this project. Accordingly in his "Notes" he has been compelled to omit all reference to the ancient kingdom of Ciampa, as well as to a great part of Annam, and to confine himself to the two great southern provinces Binh Thuan and Khanh-Hoa, which stretch from Ciampa on the coast across to Cambodia. Capt. Réveillère, who has already twice navigated the Meikong rapids in a gunboat, describes a voyage on that river in a steam-launch. The Meikong can scarcely be said to be a new river to geography, inasmuch as the greater part of its course was described with great minuteness in the work recounting the details of La Grée and Garnier's expedition from Saigon along the Meikong to the Yangtze, published ten or twelve years ago. Father Azemar describes the Stiengs, amongst whom he lived between 1861 and 1866, and gives a vocabulary of their language. The Stiengs form one of those wild tribes which inhabit the mountains between Cochin China and Tonquin on the east and Laos and Siam on the west. The writer thinks they have no ethnic affinity with the Mongol family, mainly basing his opinion on differences in language and manners.

PERHAPS the most important point to be noticed about the Perthshire Society of Natural Science, the *Proceedings* of which for the past year we have received, is that the present method of publication has been abandoned. For six years past the *Proceedings* have, for the most part, been reprinted from the reports of the meetings which have appeared in a local newspaper. But the selection and arrangement of matter most suited to a newspaper were not always the best adapted for the *Proceedings* of a scientific Society. The Council have, therefore decided to commence a new series of *Transactions* and *Proceedings*, which will be specially printed for the Society, under the supervision of a publishing Committee. An examination of the *Proceedings* now before us certainly reveals so much activity in many departments of research that the Council appear justified in this resolution. It is especially noticeable that the papers read refer, almost without exception, to local investigation

our judgment the most valuable and instructive work in which the members of such a Society could systematically engage. Thus, we have some notes on a collection of nests and eggs presented by a local landowner; a thorough description, by several hands, of the natural history of Kinnoull Hill, under the heads of Introductory, Geology, Flowering Plants, Ferns, Mosses and Fungi, Insects, Mollusca, and Vertebrates, and many others of the same kind. Dr. Buchanan White's address this year, as last, urges the improvement of the museum, with a view to securing more space for the exhibition of the collections. He dwells on the value of a properly selected and arranged museum as an educational medium for the members of the Society, and, quoting the words we used last year in regard to this subject, that a local museum, to be of the fullest value, should be made as complete as possible, he explains what degree of completion he expects such a museum to attain.

WE have received the *Proceedings* of the Holmesdale Natural History Club, with its home at Reigate, for 1884 and 1885. The papers are of a very general kind, ranging from the continuity of protoplasm to the wild animals of South Africa, and from mahogany to the Yellowstone National Park. Students will probably turn with most interest to two papers by Mr W. H. Beeby on recent additions to the flora of Surrey, Mr. Tyndall's meteorological notes for the two years, and Mr. Crossfield's paper on the geographical distribution of wild plants in the British Isles.

THE Town Council of Bombay has unanimously resolved that the municipality must bear its share, with the Government and other public bodies, in the expenses of the establishment of a technical school, and a sum of 5000 rupees was voted for the purpose at a late meeting. The scheme is one drawn up by Dr. Cooke, Principal of the Poona College of Science, and explained by him to the Council. The skilled artisans, he said, turned out by the school would be a benefit to the country and to the municipality alike.

THE additions to the Zoological Society's Gardens during the past week include an Indian Rhinoceros (*Rhinoceros unicornis* ♂) from India, presented by the Maharajah of Cooh Behar; a Tiger (*Felis tigris* ♂) from India, presented by the Zoological Gardens, Calcutta; a Chanting Hawk (*Melierax musicus*) from South Africa, a Red-throated Diver (*Colymbus septentrionalis*), European, presented by Lord Lilford, F.Z.S.; a Short-eared Owl (*Asio brachyotus*), British, presented by the Rev. Hubert D. Astley, F.Z.S.; ten Moorish Geckos (*Tarentola mauritanica*) from the borders of the Mediterranean, presented by Mr. J. C. Warburg; three Zebus (*Bos indicus* ♂ & ♂) from India, a Montagu's Harrier (*Circus cinereus*), European, deposited.

OUR ASTRONOMICAL COLUMN

THE SPECTROSCOPIC METHOD OF DETERMINING THE DISTANCE OF A DOUBLE STAR.—Mr. A. A. Rambaut, in a paper communicated to the Royal Irish Academy on May 24, discusses at some length the possibility of determining the distance of a double star by measures of the relative velocities of the components in the line of sight by means of the spectroscope. Of course, as soon as Dr. Huggins had demonstrated that it was practicable to measure the rate of approach or recession of a star, it was seen that it would be at least theoretically possible to determine the distance of a star by this method, but Mr. Rambaut does not merely repeat the suggestion, but examines the conditions of the problem that he may ascertain what chance there is of putting it into successful operation. His first step is to find the value of ΠV for the satellite star of any binary system, Π being the parallax in seconds of arc, and V the velocity of motion in the line of sight expressed in miles per second. The resulting formula is—

$$\Pi V = \frac{a^2 \sqrt{1 - e^2} \cdot \sin(\phi - \lambda) \sin \gamma}{Pr \sqrt{1 - e^2 \cos^2 \phi}} = k,$$

where ϕ denotes the angle between the tangent and major axis,
 λ denotes the angle between the line of nodes and major axis,
 γ denotes the angle between the plane of orbit and tangent plane to sphere,
 P denotes period in years,
 l denotes mean motion of earth in miles.

This equation therefore gives a relation between Π and V depending only on the period and the angular elements of the orbit, so that if either Π or V can be measured the other may at once be determined. If k be greater than unity, then either V must exceed ten miles per second, or Π one-tenth of a second of c. If, then, the spectroscopes show the lines in the spectra of both stars to be absolutely coincident, it follows that the parallax must exceed 0".1, and the star will repay investigation. But if measurable displacement be noticed, V can be determined, and the parallax will follow at once. So that "all double stars for which k is at any time greater than unity may be said to be within measurable distance either by the spectroscopic or the trigonometrical method." If, however, k be less than unity, the star may still chance to be within a measurable distance, for V may be small either from the small linear dimensions of the orbit or the length of the period; but if k be smaller than unity, and V be large, then we shall at once know, "with a certainty which the mere failure to measure its parallax trigonometrically could never reach, that the star is at an inconceivable distance from the solar system." Mr. Rambaut next proceeds to determine k for some 39 stars, the elements of whose orbits he takes for the most part from Houzeau's "Vade Mecum." In the case of five only does it exceed unity, viz., α Centauri 6.023, Sirius 5.400, γ Ophiuchi 1.270, η Cassiopeie 1.247, and γ Coronae Australis 1.224. Of these the parallax has already been determined for all but the last named. This star, the components of the pair being of nearly equal magnitude, would be well adapted for examination by the spectroscopic method if one of the new giant telescopes were employed, and since $k = 1.224$, had it been examined in 1880 either the velocity in the line of sight would have been found to exceed 12 miles per second, or the parallax to exceed 0".1. Since a star fainter than the fifth and a half magnitude would be beyond the reach of even the most powerful instrument to successfully measure its movement in the line of sight, the field of inquiry is practically confined to α Centauri, and the following three stars for all of which k is fairly large though less than unity: ξ Ursae Majoris 0.895, γ Virginis 0.624, and ζ Herculis 0.605. The result of Mr. Rambaut's inquiry is therefore to show that but little practical use can be made of the suggested combination of the two methods in the case of double stars.

NAMES OF MINOR PLANETS.—The following minor planets have recently received names:—No. 254, Augusta; No. 255, Oppavia; No. 257, Silesia; No. 260, Huberta; and No. 261, Prymno.

COMET FINLAY (1886 e).—Dr. J. Holetschek gives (*Ast. Nach.*, No. 2763) the following elements and ephemeris for this object, which, though now diminishing somewhat in brightness, becoming well placed for observation in northern latitudes:—

$T = 1886 \text{ November } 22.48418.$
 $\omega = 315.21 \text{ } 0^{\circ}.5$
 $\Omega = 52.45 \text{ } 43^{\circ}.2$
 $i = 3.1 \text{ } 9.4$
 $\log q = 9.997122$
 $\log e = 9.850744$
 $\log a = 0.533468$
 $\text{Period} = 6.31 \text{ years.}$

Ephemeris for Berlin Midnight

1887	R.A.	Decl.	log r	log Δ	Bright-ness
Jan. 0	23 49 17	1 23 S.	0.0565	9.9245	2.3
4	0 8 58	1 23.7 N.	0.0670	9.9343	2.1
8	0 28 10	3 45.0	0.0779	9.9461	1.9
12	0 46 52	5 59.9 N.	0.0889	9.9598	1.7

The brightness at the time of discovery is taken as unity.

COMET BARNARD (1886 f).—The following ephemeris for Berlin midnight is in continuation of that given in NATURE for December 9 (p. 134):—

1887	R.A.	Decl.	log r	log Δ	Bright-ness
Jan. 0	19 32 32	4 5.2 N.	9.8652	0.1478	10.5
5	19 53 52	1 13.5 N.	9.8935	0.1845	7.8
10	20 11 46	1 20.1 S.	9.9243	0.2177	5.8

The brightness at the time of discovery is taken as unity.

ASTRONOMICAL PHENOMENA FOR THE WEEK 1887 JANUARY 2-8

(FOR the reckoning of time the civil day, commencing at Greenwich mean midnight, counting the hours on to 24, is here employed.)

At Greenwich on January 2

Sun rises, 8h. 8m.; souths, 12h. 4m. 14.9s.; sets, 16h. 1m.; decl. on meridian, 22° 55' S.; Sidereal Time at Sunset, 22h. 49m.
 Moon (at First Quarter) rises, 11h. 56m.; souths, 18h. 12m.; sets, 0h. 38m.*; decl. on meridian, 2° 25' N.

Planet	Rises		Souths		Sets		Decl. on meridian
	h. m.	h. m.	h. m.	h. m.	h. m.	h. m.	
Mercury ...	6 41	...	10 39	...	14 37	...	22 38 S.
Venus ...	8 41	...	12 36	...	16 31	...	23 5 S.
Mars ...	9 34	...	13 52	...	18 10	...	19 35 S.
Jupiter ...	2 10	...	7 16	...	12 22	...	11 11 S.
Saturn... ..	16 35*	...	0 40	...	8 45	...	21 49 N.

* Indicates that the rising is that of the preceding evening and the setting that of the following morning.

Occultations of Stars by the Moon (visible at Greenwich)

Jan	Star	Mag.	Disap.	Reap.	Corresponding angles from vertex to right for inverted image	
					h. m.	h. m.
4 ...	μ Ceti ...	4 ...	20 28	...	21 33	... 87 34 ^o
5 ...	f Tauri ...	4 ...	17 21	...	18 24	... 48 293
6 ...	γ^1 Tauri ...	6 ...	18 50	...	19 7	... 359 334
6 ...	θ^1 Tauri ...	4 $\frac{1}{2}$...	19 47	...	21 2	... 68 295
6 ...	θ^2 Tauri ...	4 $\frac{1}{2}$...	19 54	...	20 55	... 47 316
6 ...	B.A.C. 1391 ...	5 ...	21 2	...	22 19	... 108 289
6 ...	δ^5 Tauri ...	6 ...	22 19	near approach	27	...
7 ...	Aldebaran ...	1 ...	0 17	...	1 15	... 165 283
7 ...	η^1 Tauri... ..	5 $\frac{1}{2}$...	19 51	near approach	340	—
7 ...	η^2 Tauri... ..	6 ...	20 53	...	22 6	... 95 261

Jan. 2 ... h. 20 ... Sun at least distance from the Earth.

Saturn, January 2.—Outer major axis of outer ring = 46".4; outer minor axis of outer ring = 18".5; southern surface visible.

Variable Stars

Star	R.A.		Decl.	h. m.
	h. m.	h. m.		
U Cephei ...	0 52.3	...	81 16 N.	Jan. 2, 0 3 m
λ Tauri ...	3 54.4	...	12 10 N.	6, 23 43 m
S Cancrī ...	8 37.5	...	19 26 N.	5, 2 12 m
U Hydræ ...	10 32.0	...	12 48 S.	5, 1 40 m
R Crateris ...	10 55.0	...	17 43 S.	6, m
S Leonis ...	11 5.0	...	6 4 N.	6, m
W Virginis ...	13 20.2	...	2 48 S.	2, 4 0 M
δ Libræ ...	14 54.9	...	8 4 S.	3, 19 41 m
U Coronæ ...	15 13.6	...	32 4 N.	6, 3 33 m
U Ophiuchi... ..	17 10.8	...	1 20 N.	7, 2 14 m
W Cygni ...	21 31.8	...	44 52 N.	4, 4 18 m
δ Cephei ...	22 25.0	...	57 50 N.	and at intervals of 20 8

M signifies maximum; *m* minimum.

Meteor-Showers

The principal shower of the week is that of the *Quadrantids*, maximum January 2, radiant R.A. 228°, Decl. 53° N. Other showers are as follows:—From the borders of Gemini and Cancer, R.A. 119°, Decl. 16° N.; near θ Ursæ Majoris, R.A. 140°, Decl. 57° N.; near ζ Bootis, R.A. 220°, Decl. 13° N.

NOTES FROM THE OTAGO UNIVERSITY MUSEUM

IX.—On the Nomenclature of the Brain and its Cavities

IN working at the brain of the lower Vertebrata, the inconvenience of the received terminology of the cerebral cavities became so manifest, that I adopted the plan¹ of distinguishing each cavity by the simple expedient of placing before the syllable *caele* (κοῖλος, κοιλία) the prefix used for the corresponding division of the brain in the systematic nomenclature adopted in Quain's "Anatomy." Thus, the entire cavity of the mid-brain of fishes, for which the usual names "aqueduct of Sylvius" or "iter a tertio ad quartum ventriculum" were unsuitable, became the *mesocaele* or cavity of the mesencephalon, the "lateral ventricles," the *proso-caeles* or cavities of the prosencephala, and so on. A similar but more thorough-going reform had been previously and independently proposed by Burt Wilder (*Science*, ii., 1881, pp. 122 and 133), and adopted in Wilder and Gage's "Anatomical Technology" (New York, 1882). Prof. Wilder was good enough to write to me on the subject, and, after some correspondence had passed between us, he published an article² giving a full account of the nomenclature he proposed to adopt, and stating that certain of his terms (e.g. *neurocaele* for the entire cavity of the cerebro-spinal axis, and *encephalocaele* for the entire system of brain-cavities) had been proposed by me.

The chief features in Wilder's nomenclature are the following:—

(a) The adoption of *diencephalon* in preference to the more cumbersome *thalamencephalon* as the systematic name of the "tween-brain (*Zwischenhirn*). The former term is given as a synonym by Allen Thomson (Quain's "Anatomy," ninth edition, vol. ii. p. 828), and is used by Rolleston in "Forms of Animal Life." In correspondence with this, the third ventricle becomes the *diacaele* (*thalamocaele*, *mihi*).

(b) The adoption of Quain's name of *epencephalon* for the cerebellum (*Hinterhirn*), and of *metencephalon* for the medulla oblongata (*Nachhirn*). Huxley's term, *myelencephalon*, for the latter division, is rendered inconvenient, to say the least, from the fact that it is used by Owen to designate the entire cerebro-spinal axis. The fourth ventricle is called the *metacaele* (*myelocaele*, *mihi*), and the cerebellar ventricle the *epicaele* (*metacaele*, *mihi*).

(c) The word *prosencephalon* is used in the same sense as by Quain, i.e. as including the whole of the fore-brain proper (*Vorderhirn*). Both Owen and Huxley, on the other hand, use this term as synonymous with cerebral hemisphere, i.e. speak of paired *prosencephala*. In correspondence with this, the entire cavity of the fore-brain is called the *proso-caele*, and the lateral ventricles themselves *proso-caeles* (*proso-caeles*, *mihi*).

(d) The unpaired cerebral rudiment of the embryo is distinguished as the *protocerebrum*.

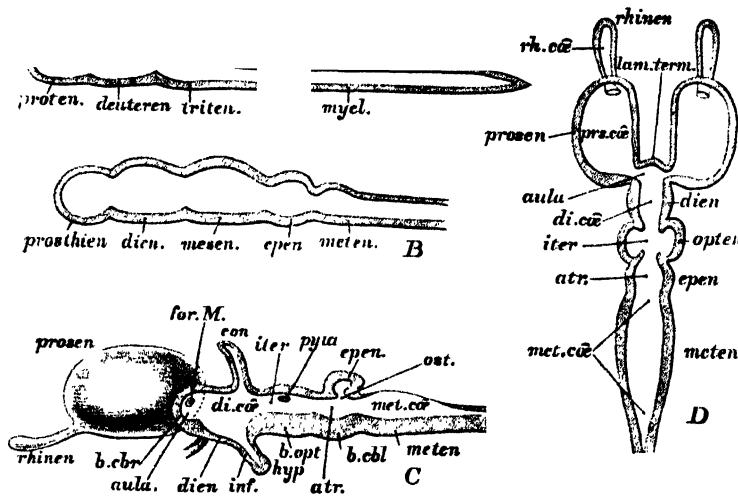

FIG. 2.—Diagrams showing three chief stages in the development of the nervous system. A, the neuron is divided into myelon and encephalon, the latter being again divided into the three primary vesicles. *protencephalon*, *deuterencephalon*, and *tritencephalon*. Similarly, the *neurocaele*, or general cavity of the neuron, is divided into *myelocaele* and *encephalocaele*, and the latter, again, into *proso-caeles*, and *trito-caeles*. B, the brain now consists of five encephalomereres, the *prosthio-*, *dia-*, *meso-*, *epi-*, and *meta-encephala*, containing respectively the *prosthio-*, *dia-*, *meso-*, *epi-*, and *meta-caeles*. C, D, the brain has assumed its permanent form, and is shown in C in vertical, in D in horizontal section. The prosthioencephalon has sent out paired *prosencephala*, a small unpaired portion, the *basocerebrum* (*b.cbr.*), being left, the latter being bounded in front by the lamina terminalis (*lam. term.*). Each *prosencephalon* has further given rise to a *rhinencephalon*. Similarly, the *prosthio-caele* now consists of unpaired *aulu* and of paired *proso* and *rhino-caeles* (*prae. cae.*, *rh. cae.*), the former communicating with the *aulu* by the foramina of *Monro*, or *portae* (*for. M.*). The *diacaele* is continued above into the *conarium* (*con*), below into the *infundibulum* (*inf*) with the *hypophysis* (*hyp*). The mesencephalon consists of an unpaired ventral *basiopticus* (*b. opt.*), and of paired *opticocephala*: its cavity of a median *iter*, and of paired *optico-caeles*, which communicate with the *iter* by the *pyla*. The epencephalon is divided into a dorsal portion, the cerebellum, or epencephalon proper, and a ventral division, the *basio-cerebellum* (*b. cbl.*), containing a cavity, the *atrium* (*atr.*), which communicates with the *epicaele* proper, or cavity of the cerebellum, by the *ostium* (*ost.*). The metencephalon and *metacaele* (*met. cae.*) have undergone but little alteration.

(e) The unpaired portion of the fore-brain, left by the budding-off of the cerebral hemispheres, is not specially named, but its cavity is termed the *aulu*. This is a large and distinct cavity in some sharks (e.g. *Scymnus*, Fig. 2), but in the higher forms becomes the Y-shaped passage between the third and the lateral ventricles. This passage is sometimes spoken of as the "foramen of *Monro*," but the latter term is more correctly applied to the aperture between each of its anterior limbs and the corresponding lateral ventricle: this aperture Wilder calls the *pyla*.

(f) The specialised cavities in the optic lobes of Amphibia and Sauropsida are called *optico-caeles*, the name *iter* (abbreviation of "iter a tertio ad quartum ventriculum") being retained for the

unpaired portion of the *mesocaele* or entire cavity of the mid-brain. The *iter* communicates with each *optico-caele* by a small aperture, the *pyla*. No name is given to the ventral portion of the mesencephalon after formation of the optic lobes, i.e. the part usually known by the awkward plural designation *crura cerebri*.

(g) The ventral portion of the epencephalon, the fibres of which become the pons Varolii in mammals, is called the *pre-oblongata*, the word *post-oblongata* being used as a synonym for metencephalon or medulla oblongata in the restricted sense.

(h) The entire cerebro-spinal axis is called the *neuron*, its cavity the *neurocaele*.

(i) The name *encephalocaele* is applied to the entire system of brain-cavities, or to the single cavity of the undivided embryonic encephalon.

(k) The name *myelocaele* is applied to the central canal of the myelon. This cavity is also distinguished into a lumbar dilatation, the *rhombocaele* (*sinus rhomboidalis*) and a contracted portion, the *syringocaele*.

¹ "Notes on the Anatomy and Embryology of *Scymnus lichia*," *Trans. N.Z. Inst.* xv. (1882), p. 222; "A Course of Instruction in Zoology," London, 1884.

² "Encephalic Nomenclature," *New York Medical Journal*, xii. (1885), pp. 325 and 354.

This scheme I propose to modify in certain particulars. For the sake of clearness I give diagrams (Fig. 1) showing three important stages in the development of the brain, as well as drawings of the brain of *Scymnus lichia* (Fig. 2). The latter shows with such diagrammatic clearness the typical structure of the Vertebrate encephalon that I now always use it as a starting-point for the study of that organ in my lectures.

(a) I propose to follow Wilder in his use of the words neuron and neurocoele, encephalon and encephalocoele, myelon and myelocoele (Fig. 1, A). The words syringocoele and rhombocoele

appear to me unnecessary: I prefer to say that in some Vertebrates (e.g. birds) the lumbar region of the myelocoele is dilated into a sinus rhomboidalis.

(b) The three primary cerebral vesicles may be called respectively the *protencephalon*, *deuterecephalon*, and *trit.encephalon*; their cavities the *protocoel*, *deuterocele*, and (primary) *tritocoel* (Fig. 1, A).

(c) In what may be called the sub-primary stage of segmentation, the anterior, or first, and the posterior, or third, cerebral vesicles have each divided into two parts, the brain thus consisting of

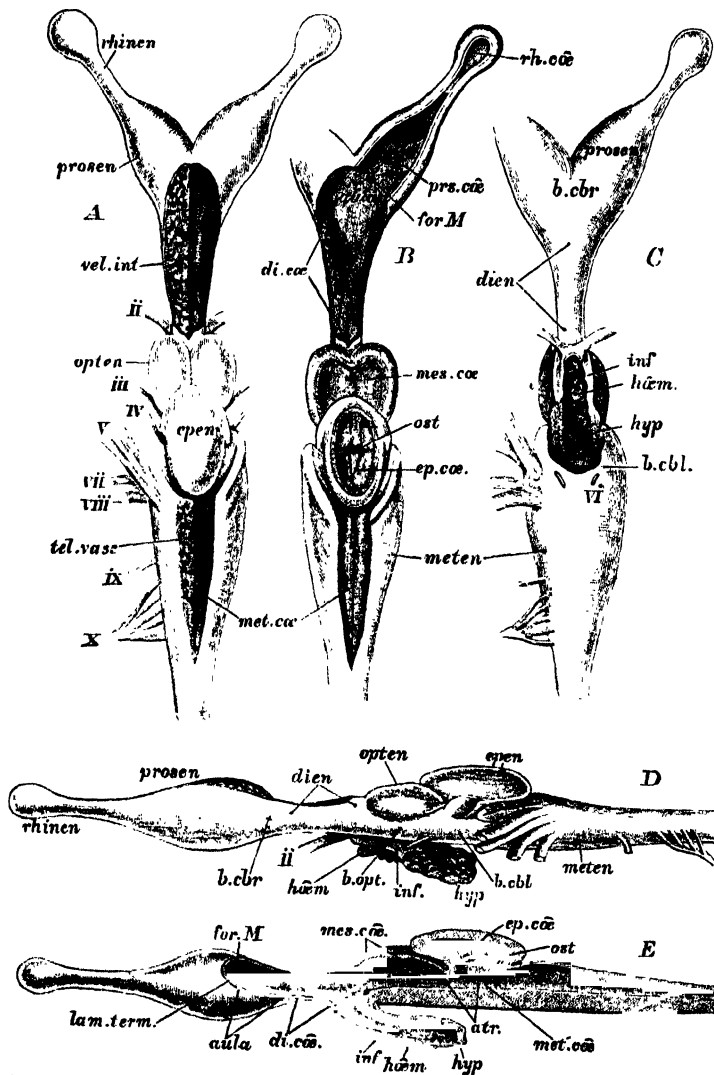

FIG. 2.—Five views of the brain of *Scymnus lichia* (nat. size). A, dorsal view of the brain, entire, save for the removal of the velum interpositum (*vel.int*) and tela vasculosa (*tel.vasc*) on the right side. B, the same, with the cavities opened from above. C, the entire brain from below. D, the entire brain from the left side. E, longitudinal vertical section. The letters have the same significance as in Fig. 1, except *ham*, hamatosac (saccus vasculosus); *vel.int*, velum interpositum; *tel.vasc*, tela vasculosa; and *ii-x*, cerebral nerves.

five encephalomes, which I propose to call respectively the *prosthiencephalon* (= prosencephalon of Quain, *Vorderhirn*) and *diencephalon* (= thalamencephalon), derived from the protencephalon; *mesencephalon* (identical with the deuterecephalon), *epencephalon*, and *metencephalon*, formed by the constriction of the primitive tritencephalon. The cavities of these five brain-segments will be the *prosthio-*, *dia-*, *meso-*, *epi-*, and *meta-coeles* (Fig. 1, B).

(d) In the next stage of differentiation of the fore-brain, the prosthiencephalon gives rise dorsally to the two cerebral hemispheres: I propose to follow Owen and Huxley in calling them the *proencephala* (Fig. 1, C and D; Fig. 2, A-E, *prosen*);

their cavities, or lateral ventricles, being named *prosoceles* (*prs.coe*). The median portion of the prosthiencephalon, after separation of the prosencephala, may be called the *basicephalon* (*b.cbr.*); its cavity, the *aula*, is Y-shaped, communicating by its unpaired posterior limb with the diacoel, by its paired anterior limbs with the prosoceles through the *foramina of Monro* (*for.M*), or *porta*. The two prosencephala may be spoken of collectively by the old name, *cerebrum*, which, as Pye-Smith remarks,¹ "ought to be strictly limited to the hemispheres with the corpus callosum, corpora striata, and fornix."

¹ "Suggestions on some Points of Anatomical Nomenclature" *Journ. of Anat. and Phys.*, xii. (1878), p. 154.

From each prosencephalon is budded off an olfactory lobe or *rhinencephalon*, containing a cavity, the *rhinocele*, and usually divisible into a stem-like portion, or *crus*, and a dilated extremity, or *bulb*.

(e) The mesencephalon becomes differentiated dorsally into the paired optic lobes, or *optencephala*, the cavities of which, or *optocæles*, are frequently clearly distinguishable from the remaining median portion of the mesocele, or *iter*, with which they communicate by small apertures, or *pyle*. In many fishes, however, although the optic lobes are well formed, the mesocele shows no distinction into iter and optocæles (cf. Fig. 2, B and E). The unpaired ventral portion of the mid-brain, which in the lower forms shows no differentiation into crura cerebri may be distinguished as the *basi-opticus*.¹

(f) In the epencephalon the dorsal region grows out into the cerebellum, or epencephalon proper, its ventral region, or *basi-cerebellum* (præ-oblongata, Wilder), being usually quite indistinguishable from the metencephalon, but becoming marked off in the Mammalia by the development of the pons. The anterior portion of the fourth ventricle of the adult, *i.e.* the portion corresponding to the basi-cerebellum, is of course epencephalic and not metencephalic, and may be distinguished as the *atrium* (Fig. 1, c and d; Fig. 2, E): it communicates, in Selachians, with the epicele proper, or cerebellar ventricle, by a small aperture, the *ostium* (Fig. 2, B and E, *ost.*)²

It will be noticed that a mixture of Latin and Greek names occurs in the above scheme. This has been adopted so as to interfere as little as possible with the names in common use and with those proposed by Wilder. The Latin names, moreover, are introduced with a certain consistency; *e.g.* the basi-cerebrum is the median unpaired portion of the protencephalon, the basi-opticus of the mesencephalon, and the basi-cerebellum of the epencephalon; similarly, the cavities of these basal regions are respectively the aula, the iter, and the atrium, the main "ventricles" being all distinguished by names of Greek origin.

The advantages claimed for the proposed nomenclature are the following:—

(a) Names are given to important structures which have hitherto been designated by more or less lengthy phrases, *e.g.* basi-cerebrum, aula, mesocele, &c.

(b) The systematic brain-nomenclature of Quain is brought up to date by introducing changes rendered desirable by the progress of animal morphology.

(c) The cavities of the brain are distinguished by systematic names which have an evident connection with those of the encephalomeses themselves, instead of by names which have no relation either with the regions of the brain in which the cavities occur, or with one another.

(d) The description of the nervous system of the lower Chordata is simplified. For instance, in *Amphioxus*, one may say that the neuron shows no distinction externally into encephalon and myelon, but that the neurocele is dilated anteriorly into a small encephalocæle.

While agreeing with Prof. Wilder in the advisability of making the changes proposed above in the nomenclature of the central nervous system, I differ from him in failing to see the necessity, or, indeed, the desirability, of making all binomial names monomial. Such names, for instance, as anterior commissure, corpus callosum, lamina terminalis, which are not misleading, and which do not require to be connected with homologous parts by a consistent nomenclature, may very well be left alone; although, if one could start *ab initio*, I quite admit that the substitutes proposed by Wilder might be preferable. In any case, however, his name *pseudocæle* is thoroughly deserving of adoption as a substitute for the misleading appellation, "fifth ventricle."

Prof. Wilder's suggestion that *encephalon* should be Anglicised into *encephal* is worthy of consideration, especially as the word ought to be written *encephalos*, and it would be an advantage to get rid of the incorrect neuter termination. I have adopted the abbreviated form in the following table, which shows at a glance the nature of the proposed scheme of nomenclature. The

names of the various divisions of the nervous system are printed in capitals, those of the corresponding cavities in italics.

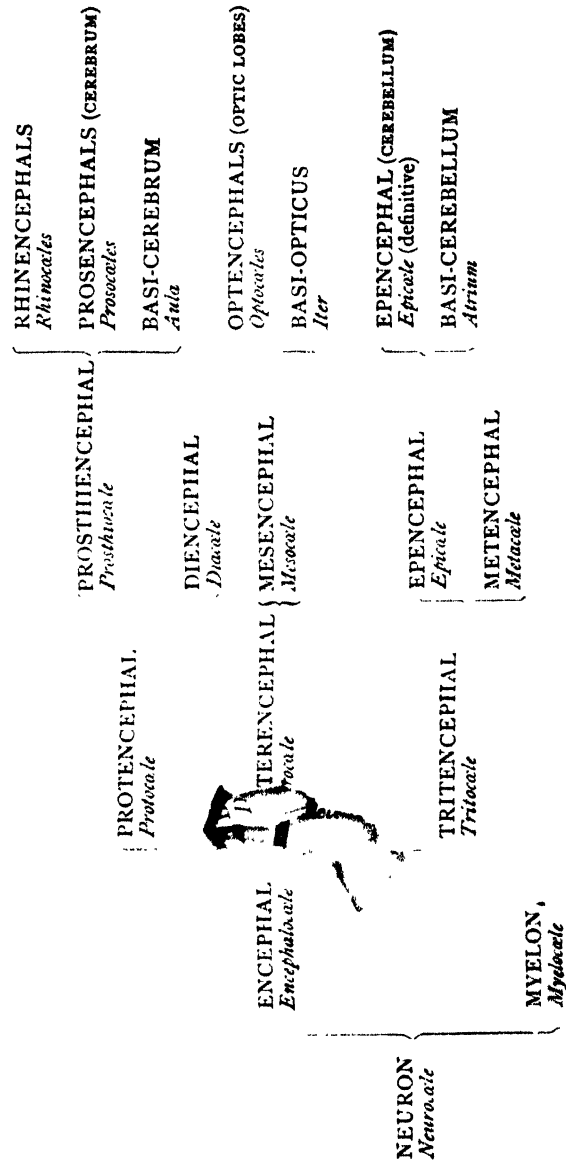

My object in writing this note is not so much to get my own or any other system of names adopted, as to urge the necessity for a reform in the nomenclature of the central nervous system and its cavities—a necessity which no comparative anatomist, especially if he be a teacher, can fail to see. Recent investigations of the skull, shoulder-girdle, urinogenital organs, &c., of Vertebrates have necessitated corresponding changes in nomenclature, and similar changes are constantly being made among the various Invertebrate groups. It would certainly be a great boon, both to teachers and students, if a like reform could be generally adopted for the Vertebrate nervous system.

Dunedin, N.Z., September 15

T. JEFFERY PARKER

THE IMPERIAL INSTITUTE

THE following is the report of the Committee appointed by H.R.H. the Prince of Wales to prepare a scheme for the proposed Imperial Institute:—

The committee appointed by your Royal Highness to frame a scheme for an Imperial Institute intended to commemorate the

¹ Critics will no doubt object to using an adjective as a substantive, but how far this is admissible is entirely a matter of usage." &c. (Pye-Smith, *loc. cit.*, p. 174, note).

² *Cerebellum* is one of the few names in the older brain-nomenclature which present no ambiguity, so that the only reason for giving it a Greek synonym is the logical satisfaction of having a similar set of names for all the great divisions of the brain. Strictly speaking, the word epencephalon, being synonymous with *cerebellar segment*, ought not to be used for the cerebellum itself, and *hypencephalon* might be used instead, with *hypencele* for cerebellar ventricle.

of Her Majesty's reign beg leave to submit to your Majesty the following report.

They do not fail to remember that the scheme which your Royal Highness indicated in your letter of September 13 last to the Lord Mayor of London had its origin in the remarkable interest excited by the recent Exhibition, by which not only the material products, resources, and manufactures, but the loyal feeling of the great colonies and possessions of Her Majesty's Empire, were illustrated in a most signal manner.

The object, therefore, which naturally suggested itself first to the committee was the development, with some necessary modifications, of your Royal Highness's idea of creating a permanent representation of the resources and progress of the colonies and India.

On pursuing, however, the consideration of the subject, the committee became persuaded that a memorial really worthy of the jubilee year of Her Majesty's reign could not be confined in its objects to any one part or parts of Her Majesty's Empire, and that it must in some form and degree also comprehend a representation of the United Kingdom.

Their desire, therefore, in the following outline of the scheme which they recommend is to combine in a harmonious form, and with a view to some practical and useful purpose, a representation of the colonies and India on the one hand and of the United Kingdom on the other.

They submit that this object will be best indicated by giving to the memorial the title of The Imperial Institute of the United Kingdom, the Colonies, and India.

They think that the Institute should find its home in buildings of such a character as worthily to commemorate the jubilee year of the Queen's reign, and to afford accommodation suitable for an institution combining the important objects which they now proceed to describe.

It is obvious that several departments of the Institute, such as the hall, conference rooms, &c., which will be found described under the Colonial and Indian Section and the United Kingdom Section respectively, will be common both to the colonies and India and to the United Kingdom: but as others have special relation to a particular portion of Her Majesty's dominions, it will be found convenient to make the following division.

A. Colonial and Indian Section.—The object of the Colonial and Indian Section will be to illustrate the great commercial and industrial resources of the colonies and India, and to spread a knowledge of their progress and social condition.

To this end provision should be made for—

(1). The display in an adequate manner of the best natural and manufactured products of the colonies and India, and in connection with this the circulation of typical collections throughout the United Kingdom.

(2). A hall for the discussion of colonial and Indian subjects, and for receptions connected with the colonies and India.

(3). The formation of colonial and Indian libraries, and establishing in connection therewith reading, news, and intelligence rooms.

(4). The incorporation in some form into the proposed Institute of the Royal Colonial and Royal Asiatic Society, if, as is hoped, it be possible to bring about such a union.

(5). The collection and diffusion of the fullest information regard to the industrial and material condition of the colonies, so as to enable intending emigrants to acquire all requisite knowledge. Such information might be advantageously supplemented by simple and practical instruction. An emigration office of this character should be in correspondence with the provincial towns, either through the free libraries or by other means, so that information may be readily accessible to the people. These objects would be greatly facilitated if, as may be hoped, the Government should consent to the transfer to the buildings of the Institute of the recently formed Emigration Department, which would, by a close connection with the Institute, largely increase its usefulness.

Facilities might be afforded for the exhibition of works of colonial and Indian art.

It is also considered desirable that means should be provided, not for a general exhibition, but for occasional special exhibitions of colonial and Indian produce and manufactures. At one time a particular colony or portion of the Empire may desire to show progress; at another time a general comparison of particular industries may be useful. Whilst the permanent galleries would exhibit the usual commercial or industrial products of the several colonies and India, the occasional exhibitions would stimulate and enlist the sympathies of colonial and Indian producers, and

keep up an active co-operation with the industrial classes of this country.

B. United Kingdom Section.—The leading objects of this Section will be to exhibit the development during Her Majesty's reign and the present condition of the natural and manufactured products of the United Kingdom, and to afford such stimulus and knowledge as will lead to still further development, and thus increase the industrial prosperity of the country.

We submit that these objects may be carried out by making provision for the following purposes:—

(1). Comprehensive collections of the natural products of the United Kingdom, and of such products of other nations as are employed in its industries, with full scientific, practical, and commercial information relating thereto.

(2). Illustrations of manufactured products, typical of their development and present condition, of trades and handicrafts, and their progress during the Queen's reign, including illustrations of foreign work when necessary for comparison; together with models illustrating naval architecture, engineering, mining, and architectural works.

(3). A library for industrial, commercial, and economic study, which should contain standard works and reports on all subjects of trade and commerce. It will be desirable also to include a library of inventions of the Empire, and, as far as possible, of the United States and other countries.

(4). Reading and conference rooms supplied with English, colonial, and foreign commercial and technical periodicals, and a fully-equipped map room for geographical and geological reference. The conference rooms would be of value for meetings of Chambers of Commerce and other bodies of a kindred nature.

(5). The promotion, in affiliation with the Imperial Institute, of commercial museums in the City of London and in the commercial centres of the provinces. To these the Institute would contribute specimens, samples, and exhibits of the commercial products likely to be specially valuable in particular localities. There should also be an organisation to connect the Imperial Institute with the provincial centres by lectures, conferences, the circulation of specimens, and other means.

It is hoped that the Institute may lead to the organisation of high schools of commerce, such as are now established in the chief commercial towns of most Continental countries, but which have, as yet, unfortunately no existence in the United Kingdom.

(6). The building will also advantageously afford accommodation for (a) comparing and examining samples by the resources of modern science, and (b) the examination of artisans under the various schemes already existing for the promotion of technical education.

Space should also be provided for occasional exhibitions of separate industries, or of the special industries carried on in great provincial centres: for example, there might at one time be an exhibition of iron manufactures, at another of pottery, at another of textile fabrics, &c., which would tend to stimulate improvement in the different departments of industrial life. This object might be assisted by separate exhibitions of the handiwork of artisans.

The committee, having detailed the general nature of their suggestions under these heads, desire to add that they do not anticipate the exhibits in the collections remaining unchanged. They contemplate that as improvements are made from time to time the later and better results would displace those out of date.

They have had to consider how the space should be distributed between the United Kingdom on the one hand and the colonies and India on the other, and they recommend that whatever portion of the buildings is not required for purposes manifestly common to both should be allotted to the two sections fairly in equal parts.

C. Government of Institute.—The committee recommend that a new body, entirely independent of any existing organisation, should be created for the government of the Institute. This body should be thoroughly representative of the great commercial and industrial interests of the Empire. The colonies and India should have a fair share in the government of the Institute, and each colony should have special charge of its own particular department, subject, of course, to the general management of the entire institution.

The method of carrying this out would be prescribed by the Charter, after full consideration by Her Majesty in Council.

D. Site.—The committee, being fully conscious of the advantage

of a central position for the Institute, have considered the various possible sites, and have, as far as has been within their power, obtained estimates of their cost.

To carry out the several objects which the committee have indicated, a large space is necessary. The committee have been unable to find any such suitable site in the central parts of London, except at a cost which, looking at the probable amount of subscriptions, would, after the purchase of the ground, leave a sum wholly inadequate for the erection and maintenance of the buildings, and for carrying out the objects of the Institute.

The site of about five acres recently secured for the New Admiralty and War Offices is valued at 820,000*l.*, or rather over 160,000*l.* per acre. That now vacant in Charles Street, opposite the India Office, is less than an acre, and would cost at least 125,000*l.*; probably another acre might be secured by private contract, so that the value of a limited site in this position would not be less than 250,000*l.* It has been suggested that a single acre not far from Charing Cross might be obtained for 224,000*l.* Two and a half acres on the Thames Embankment have been offered for 400,000*l.*; and it is stated that six acres might be procured from Christ's Hospital at 600,000*l.* Another good central position has been suggested, consisting of two and a half acres, which has been valued at 668,000*l.*

It is, of course, probable that these sites might be obtained at somewhat less than the prices asked, but, allowing for this, it is obvious that the purchase of any adequate area would involve the expenditure of a quarter to half a million.

The committee have therefore been forced to abandon the hope of obtaining a central site within the limits allowed by any probable subscription.

The attention of the committee was then drawn to the property at South Kensington belonging to the Commissioners for the Exhibition of 1851. This property was bought out of the profits of that Exhibition, with the express object of offering sites for any large public buildings which might be required for the promotion of science and art.

Under these circumstances, the committee submit to your Royal Highness that the Imperial Institute may well establish a claim for the grant of a site of sufficient magnitude on property bought and reserved for public institutions of this character.

Though sensible of the objections that may be urged against the situation at South Kensington, the committee think that the advantage must be obvious of obtaining a sufficient site virtually free of cost, so that the whole of the subscriptions may be devoted to providing a building for and establishing and maintaining the Institute.

The committee, while guided in the recommendation of a site by the considerations they have indicated, think it right to add that there are some incidental advantages connected with that at South Kensington.

In that locality are combined the City and Guilds Technical College, the Royal College of Music, and the Government Museums and Schools of Science and Art, which ought to be in immediate proximity to an Imperial Institute of the character which we have described.

The technical character of the collections and exhibitions of the Imperial Institute has a natural connection with the collections of science and art in the Government Museums.

E. General Observations.—An Imperial Institute for the United Kingdom, the Colonies, and India, would fail in its chief object if it did not constantly keep in view that it ought to be a centre for diffusing and extending knowledge in relation to the industrial resources and commerce of the Empire.

The necessity for technical education is now fully appreciated, because the competition of industry has become, in a great measure, a competition of trained intelligence. The committee, however, do not recommend that the Imperial Institute should aspire to be a college for technical education. Many of the large towns in Great Britain have recently established colleges or schools of science and art. The Imperial Institute might serve to promote technical education in these, and to unite them with colleges of larger resources which have been founded or formed branches for the purpose in the metropolis. It is too much to hope that an active co-operation of this character between the provincial centres and London could be at once undertaken by the Imperial Institute. But the committee bear in mind that, in their last report, the Commissioners of 1851 have indicated an intention to assist in carrying out such a scheme. If the Commissioners would contribute three or four thousand

pounds annually, it would be possible to establish scholarships which might enable promising candidates of the working classes to attend the local institutions, and even, when it was desired, to complete their technical education in colleges of the metropolis. In addition to this aid, the Imperial Institute might be able, in other ways, to promote the foundation of scholarships both in connection with the colonies and provincial centres, in the hope of still further extending these benefits to the working classes.

In conclusion, the committee submit that an Imperial Institute such as they have sketched in broad outline would form a fitting memorial of the coming year, when Her Majesty the Sovereign of this Empire will celebrate the jubilee of her happy reign. It would be an emblem of the unity of the Empire, embracing as it does all parts of the Queen's dominions, and tending to promote that closer union between them which has become more and more desired. It would exhibit the vast area, the varied resources, and the marvellous growth, during Her Majesty's reign, of the British Empire. It would unite in a single representative act the whole of her people; and, since both the purpose and the effect of the Institute will be to advance the industrial and commercial resources of every part of the Empire, the committee entertain a confident hope that Her Majesty's subjects, without distinction of class or race, will rejoice to take part in offering this tribute of love and loyalty.—HERSCHELL (Chairman), CARNARVON, REVELSTOKE, ROTHSCHILD, G. J. GOSCHEN, LYON PLAYFAIR, HENRY JAMES, HENRY T. HOLLAND, H. H. FOWLER, C. T. RITCHIE, FRED. LEIGHTON (President of the Royal Academy), ASHLEY EDEN, OWEN T. BURNE, REGINALD HANSON (Lord Mayor), J. PATTISON CURRIE (Governor of the Bank of England), JOHN STAPLES, FREDERICK ABEL (Vice-President of the Society of Arts), J. H. TRITTON (Chairman of the London Chamber of Commerce), NEVILLE LUBBOCK, HENRY BROADHURST.

UNIVERSITY AND EDUCATIONAL INTELLIGENCE

CAMBRIDGE.—At the annual election to scholarships and exhibitions in St. John's College, for candidates who have not yet commenced residence, the following awards were made:—

Foundation Scholarships: (8*ol.*) to A. Vaughan, University College School, and H. Reeves, Surrey County School; (5*ol.*) to O. W. Owen, Liverpool In-titute (all for Mathematics); (6*ol.*) to J. T. Hewitt, South Kensington School of Science, for Chemistry.

Minor Scholarships: (5*ol.*) to G. T. Bennett, University College School, and W. J. Dobbs, Wolverhampton School, for Mathematics, and to R. A. Lehfeldt, for Physics.

Exhibitions to J. J. Alexander, Queen's College, Belfast, for Mathematics, and to F. F. Blackman, St. Bartholomew's Hospital, for Physiology and Botany.

SCIENTIFIC SERIALS

THE articles in the *Journal of Botany* for November and December are mostly descriptive. Mr. H. N. Ridley concludes his description of the Monocotyledonous plants collected in New Guinea by Mr. Forbes, including a number of new species; Mr. J. G. Baker, his synopsis of the Rhizocarpeæ, with a monograph of *Pitularia*; and Dr. Trimen, his valuable account of the flora of Ceylon and its relations to the climate of the island.—Mr. J. G. Baker describes some new species of Liliaceæ from the Cape of Good Hope.—The other original papers refer to the distribution of British plants.

Nuovo Giornale Botanico Italiano for October.—G. Venturi describes several species of moss new to the Italian flora, or rare or critical species.—L. Macchiati, on the extra-floral nectaries of the Amygdalææ, describes nectariferous glands on the leaf-stalk of *Persica vulgaris*, *Cerasus vulgaris*, *Prunus domestica*, and *Amygdalus communis*. These agree in function with the extra-floral nectaries in other European plants, in serving as a protection against the attacks of caterpillars; while in the case of natives of Tropical America, their purpose is invariably to protect against the attacks of the ant *Oecodoma*, by attracting other ants, enemies to this species. The author records a diurnal periodicity in the amount of nectar exuded from the glands, which reaches its maximum early in the morning, its minimum in the afternoon.—B. Scortechini describes several

species of Scitamineæ from the Malayan peninsula, including a new genus, *Lowia*.—Prof. T. Caruel has a note on the fruit and seeds of the cacao.—P. Severino describes the variety *urea* of *Aceras anikropophora*, and the micro-chemical reactions of the purple cells.—Two teratological papers complete the list: on viviparity and prolification in *Spilanthes caulorrhiza*, Dr. F. Tassi; and teratological notes (on *Aegle sepiaria*, *ysimachia ephemerum*, and *Saxifraga crassifolia*), by C. Alongo.

SOCIETIES AND ACADEMIES LONDON

Royal Society, December 16.—"On a Varying Cylindrical Lens." By Tempest Anderson, M.D., B.Sc. Communicated by Prof. A. W. Williamson.

The author has had constructed a cylindrical lens in which the axis remains constant in direction and amount of refraction, while the refraction in the meridian at right angles to this varies continuously.

A cone may be regarded as a succession of cylinders of different diameters graduating into one another by exceedingly small steps, so that if a short enough portion be considered, its curvature at any point may be regarded as cylindrical. A lens with one side plane and the other ground on a conical tool is therefore a concave cylindrical lens varying in concavity at different parts according to the diameter of the cone at the corresponding part. Two such lenses mounted with axes parallel with curvatures varying in opposite directions produce a compound cylindrical lens, whose refraction in the direction of axes is zero, and whose refraction in the meridian at right angles to this is at any point the sum of the refractions of the two lenses. This sum is nearly constant for a considerable distance along the axis so long as the same position of the lenses is maintained. If the lenses be slid one over the other in the direction of their axes, this sum changes, and we have a varying cylindrical lens. The lens is graduated by marking on the same the relative position of the lenses when cylindrical lenses of known power are neutralised.

Lenses were exhibited varying from 0 to -6DCy, and from + to +6DCy.

Linnean Society, December 16.—W. Carruthers, F.R.S., President, in the chair.—H. R. H. the Prince of Wales was elected Honorary Member of the Society.—Messrs. A. Bawtree, Justen, T. N. Mukharji, F. W. Oliver, and R. V. Sherring were elected Fellows, and G. Nicholson an Associate, of the Society.—The President announced that Sir George MacLeay, C.M.G., had presented to the Society a portrait of the late W. W. Kirby, the distinguished entomologist, and the manuscripts and correspondence of his father, Alexander MacLeay (elected F.L.S. 1794), formerly Secretary to the Society. For acceptable donations, a special vote of thanks was accorded by the Fellows.—Prof. F. O. Bower exhibited a series of photographs illustrating the vegetation of Ceylon.—Mr. E. A. Leath showed a stormy petrel, *Procellaria pelagica*, which was picked up alive in Kensington Gardens on December 9; the bird evidently having been driven inland by the great storm of the previous day.—Mr. D. Morris drew attention to the fresh vesicles, and the fibres extracted therefrom, of *Agave salmodyckia*.

ists of ninety-six volumes containing 2000 coloured figures. Two or three copies of this important botanical work are known to be complete, as a great part of it only exists in the original native hand-work.—The President exhibited a spike of reed from an ancient Peruvian grave, also samples of prehistoric reed from ancient British and Romano-British burial-mounds in Wiltshire.—Mr. G. J. Romanes read a paper on the sense of smell in dogs, a report of which we hope to give in a future number.—C. T. Drury gave a communication on a new instance of apospory in *Polystichum angulare*, var. *pulcherrimum*. He stated that the formation of the prothallus is preceded by a very interesting series of phenomena from those already recorded. In one case the prothalli are simple extensions of the cellular substance of the tips of the pinnules commencing at points quite beyond the venation, and produce no root-hairs unless brought into contact with the soil. In the other case, however, the prothallus is a direct outgrowth of the tip of a veinlet, and at

once produces root-hairs in abundance long before it assumes any other characteristic of a prothallus, and finally the resulting prothallus is much thicker in substance.—A paper was read on apospory and allied phenomena, by Prof. F. O. Bower. The term "sporal arrest" is applied to all cases where such spores do not come to functional maturity. The arrest is often, but not always, followed by substitutionary or correlative vegetative growths: these take the form of buds, similar to the sporophyte which produced them, and then would be termed cases of "sporophytic budding"; but in other cases the correlative growths may assume the characters of the oophyte or prothallus. Where this happens, the phenomenon is termed "apospory." This direct transition from the sporophyte to the oophyte was induced some ten years ago in certain mosses, by Pringsheim and Stahl; and it is now described in detail in two ferns, an *Athyrium* and a *Polystichum*. Both plants were found some years ago growing wild, and the fact of the transition was recognised by Mr. Drury and Mr. Wollaston, and has been already published by the Linnean Society. The present paper describes these and similar phenomena in detail, and shows how in the *Polystichum* at least four different modes of origin of the oophytes may be distinguished, two being in connection with the sorus, while two are at points apart from the sorus, and may even occur on fronds which bear no sori at all. The latter part of the paper is occupied by comparing these phenomena with others already known in higher and lower plants. The general conclusion is that the whole phenomenon of apospory is to be regarded rather as a sport than as a reversion bearing deep morphological conclusions with it.

Chemical Society, December 2.—W. Perkin, F.R.S., Vice-President, in the chair.—Mr. Forbes Rickard was formally admitted a Fellow of the Society.—The following papers were read:—Bismuthates, by M. M. Pattison Muir and Douglas J. Carnegie.—The action of inorganic compounds on living matter, by James Blake, M.D.—Morindin and morindon, by T. E. Thorpe, F.R.S., and T. H. Greenall.—The hydration of salts: cadmium chloride, by S. U. Pickering.—The decomposition of sodium carbonate on fusion, by S. U. Pickering.—Derivatives of tolylbenzene, by Thomas Carnelley, D.Sc. (Lond.), and Andrew Thomson, D.Sc. (Edin.).—The amount of chlorine in rain-water collected at Cirencester, by Edward Kinch, Royal Agricultural College, Cirencester.—Some analogous phosphates, arsenates, and vanadates, by John A. Hall, student in the Laboratory of Owens College.—Agricultural experiments with iron sulphate as a manure during 1886, by A. B. Griffiths, Ph.D.

Royal Meteorological Society, December 15.—Mr. W. Ellis, F.R.A.S., President, in the chair.—Mr. G. R. Farncombe, B.A., Mr. C. E. B. Hewitt, B.A., and Capt. S. Trott were elected Fellows of the Society.—The following papers were read:—On the proceedings of the International Congress of Hydrology and Climatology at Biarritz, by Mr. G. J. Symons, F.R.S. This Congress was held in October, and was divided into three sections, viz. Scientific Hydrology, Medical Hydrology, and Climatology, Scientific and Medical. The total number of papers read was 109. An Exhibition was also held in connection with the Congress. The excursions were of primary importance to the medical men, and extended over a period of three weeks. The places visited were: Bayonne, Cambon, Dax, Arcachon, Pau, Eaux-Bonnes, Eaux-Chaudes, Cauterets, Lourdes, Bagnères-de-Bigorre, Luchon, Ussat, Ax, Montpellier, Cette, Boulou, Amélie-les-Bains, La Preste, Banyuls-sur-Mer, and Thues.—Report on the phenological observations for 1886, by the Rev. T. A. Preston, M.A., F.R.Met.Soc. The weather was, on the whole, very ungenial and everything much retarded; it was also very fatal to insect life, so that the complaints on this head have been far less than usual. Bush fruits were very abundant; strawberries and peas were spoiled by drought in many places; stone fruits, except plums, were not abundant; plums were extraordinarily plentiful, so much so that they realised nothing in the markets, the cost of picking and carrying often being more than they realised; apples were very poor, from the destruction of the bloom by heavy rain. Hay was good and plentiful, and well harvested; corn and other grain were not up to an average: root-crops were, as a rule, remarkably good.—A criticism of certain points of Prof. Langley's researches on solar heat, by Prof. S. A. Hill, B.Sc., F.R.Met.Soc. These experiments were carried out at Mount Whitney, in Southern California, during 1881.—Account of the

hurricane of March 3-4, 1886, over the Fiji Islands, by Mr. R. L. Holmes, F.R. Met. Soc. This storm was the most destructive that has ever been known to occur in the Fiji group. The lowest barometer reading was 27.54 inches at Vuna, in Taviani. The storm was accompanied by a great wave from 18 to 30 feet in height, which swept over the land and caused an immense amount of damage. It was reported that fifty vessels were wrecked and sixty-four lives lost during this hurricane.—Results of meteorological observations made at the Military Cemetery, Scutari, Constantinople, 1866-85, by Mr. W. H. Lyne. The annual mean temperature is 58°.4; the highest temperature registered was 103°.6 on June 22, and the lowest 13°.0, on January 25, both in 1859. The annual rainfall is 29.29 inches; the greatest fall in one day was 4.06 inches on September 25, 1866.

Physical Society, December 11.—Prof. McLeod, Vice-President, in the chair.—W. Natanson, Ed. Natanson, the Hon. R. Abercromby, Jul. Vertheimer, and H. M. Elder were elected Members of the Society.—The following papers were then read:—On the influence of change of condition from the liquid to the solid state on vapour-pressure, by Prof. W. Ramsay, Ph.D., and Sydney Young, D.Sc., read by Dr. Young. The authors refer to some experiments published in *Wiedemann's Annalen*, vol. xxviii, p. 403, by W. Fischer, on the above subject, which show that the vapour-pressure of ice and solid benzene are less than those of water and liquid benzene at the same temperatures. By using the formula $p = a + bt + ct^2$ to express the relation between the pressure and temperature of saturated vapours, Fischer arrives at the absurd result that the vapour-pressure of liquid benzene is not identical with that of solid benzene at melting point. If the above formula be replaced by $\log p = a + bt$, it is shown that the anomaly disappears. The authors have measured the vapour-pressures of solid and liquid benzene by the dynamical method, and obtain results agreeing closely with those of Fischer determined statically. They also calculate the vapour-pressure of solid benzene from that of the liquid, using the formula—

$$P_t - 1 = P - (P' - P'_{t-1}) \left(\frac{V_t - \frac{1}{2} + F_t - \frac{1}{2}}{V_t - \frac{1}{2}} \right),$$

where P_t and P'_t are the vapour-pressures of the solid and liquid at temperature t , $V_t - \frac{1}{2}$ = heat of vaporisation of liquid, and $F_t - \frac{1}{2}$ = heat of fusion of solid at temperature $t - \frac{1}{2}$. The numbers so obtained are in accordance with those determined experimentally.—On the nature of liquids as shown by the thermal properties of stable and dissociable bodies, by the same author, read by Prof. Ramsay. From experiments on the vapour-density and heat of vaporisation of stable and dissociable bodies, the authors arrive at two important results: (1) that for stable bodies, such as alcohol and ether, the density of their saturated vapours increases with rise of temperature, whereas for bodies such as acetic acid and nitric peroxide the vapour-density attains a minimum at a certain temperature, and increases with either rise or fall of temperature; (2) the heat of vaporisation of alcohol decreases with rise of temperature, but that of acetic acid attains a maximum at about 110° C., and decreases with rise or fall of temperature. From these results the authors seek to prove that the difference between stable liquids and their vapours consists in the relative proximity of the molecules, this proximity being greater in liquids than gases, and that the molecules of stable liquids are not more complex than those of their gases. Prof. Pickering dissented from this view, and thought that the molecules of liquids are aggregations or compounds of those of the gases. In answer to inquiries by the authors, Mr. Lewis Wright said that bodies which rotate the plane of polarisation of light when in the liquid state also rotate it in a proportionate degree when gaseous; and Capt. Abney remarked that stable liquids and their vapours give similar absorption-spectra, whereas those of dissociable bodies differ considerably. Both these facts seem to support the view put forward by the authors.—An account of Cauchy's theory of reflection and refraction of light, by Mr. James Walker, M.A. This paper is intended as a statement of the work previously done in the subject, and gives references to the original papers and "reproductions," &c., which will be of great value to persons studying this important branch of the theory of optics.—Mr. Shelford Bidwell exhibited and described a voltaic cell, in which the electrolyte is dry peroxide of lead. It consists of carefully dried peroxide placed between plates of lead and sodium, and gives a compara-

tively strong current, which passes from the sodium to the lead within the cell.

CAMBRIDGE

Philosophical Society, November 8.—Mr. Trotter, President, in the chair.—The following communications were made:—On the oœlum and body-cavity of Peripatus and the Arthropoda, by Mr. A. Sedgwick.—Note on the "vesicular vessels" of the onion, by S. H. Vines, M.A. Christ's, and A. B. Rendle, St. John's. In investigating the vesicular organs with the object of determining whether or not the transverse walls are perforated so as to place the cavities of successive segments in communication, the authors observed that, in the quiescent winter condition of the bulb, there are patches of callus—easily made conspicuous by staining with corallin—on the transverse walls. From this they infer that the transverse walls are perforated, the canals through them being open in the active, and closed by callus in the quiescent, condition of the bulb, just as is the case with sieve-tubes. This inference has, however, to be confirmed by an investigation of the bulb in the active condition. The authors also observed that each segment of a vesicular vessel contains a large nucleus.—On *Epiclemydia lusitanica*, a new species of Alga, by Mr. M. C. Potter. During August and September, the author, with assistance from the Worts Travelling Scholars' Fund, investigated the life-history of a new species of Alga, now named *Epiclemydia lusitanica*, which lives on the backs of the tortoises inhabiting the pools of Southern Europe. This Alga, which to the naked eye appears as small green roundish patches, is found to consist of a number of cells closely applied to tortoise-shell, but which are only a few layers deep, here and there penetrating into the tortoise-shell and causing it to flake off. The cells next to the tortoise-shell always force their way into any available crack, where they divide, and thus penetrate to some depth into the shell of the tortoise, and finally cause it to be flaked off. The Alga is reproduced by means of zoospores formed in the external layer of cells. These zoospores are all exactly similar, and swim about for a considerable time, after which they come to rest and germinate.—On a peculiar organ of *Hedysonia heteroclitia*, by Mr. Walter Gardiner. The author gave some account of the gland-bearing organs which are found in *Hedysonia*—one in the axil of each of the foliage leaves. A study of the development of these organs demonstrates that they are peculiarly modified leaves, or rather bracts, since they are associated with the rudimentary flower-bud. They are doubtless identical with the similarly modified bracts which occur in connection with the fully developed flowers. The glands are found on the lower surface of the bract, and belong to the same type as those of *Luffa*, although of a distinctly higher order. Glands of a similar nature also occur on the under surface of the foliage leaves and on the sepals. The substance secreted by the glands is most probably of the nature of nectar, and the whole structures are to be regarded as extra floral nectaries. Having shortly described their histology, the author proceeded to make some remarks upon their function. A careful survey of the various gland-bearing genera of the *Cucurbitaceæ* and *Passifloraceæ*, and a comparison of such cases as those presented by *Passiflora quadrangularis* and *Passiflora foetida*, placed it, in his opinion, beyond doubt that the function of the extra floral nectaries of the two orders is to attract certain insects—probably ants—which are of service to the plant in protecting it from the attacks of other and harmful insects, such as caterpillars, which are accustomed to creep up the narrow stem for the purpose of devouring or otherwise injuring the young growing shoots. As regards the fertilisation of *Hedysonia*, the author showed that there were special contrivances to prevent the animal which fed upon the nectar of the flower from obtaining that of the extra floral nectaries, and *vice versa*, and stated that, considering all the circumstances of the case, it was exceedingly probable that fertilisation was accomplished through the agency of a large night-flying moth.

EDINBURGH

Royal Society, December 20.—Sir W. Thomson, President, in the chair.—The Chairman communicated a paper, by the Rev. J. H. Sharpe, on a remarkable case of stream-lines in two-dimensional fluid motion. The body which produces the stream-lines is symmetrical about an axis, and consists of a semicircular head, with another portion the form of which is given by a transcendental equation.—A note on knots, by Mr. A. B. Kempe, was communicated by Prof. Tait. This paper is pre-

to a detailed investigation of knots by an entirely new process.—Sir W. Thomson discussed the ring-waves produced throwing a stone into water. This investigation constitutes an extension of Poisson's and Cauchy's results. The wave-velocity is directly proportional to the square root of the wave-length, and the group-velocity is one half of the wave-velocity.—Sir W. Thomson also gave an investigation of the waves produced by a ship advancing uniformly into smooth water. His results show that there is practically no disturbance of the surface outside lines drawn from the ship making an angle of $19^{\circ} 28'$ on either side with the direction of motion. When tested by experiment the angle obtained was $19^{\circ} 13'$.—Dr. T. Muir communicated a paper, by Mr. P. Alexander, on the expansion of functions in terms of linear, cylindrical, and spherical, &c., functions by a new and very general method.—In a paper on even distribution of points in space, Prof. Tait replied to certain criticisms made on his results regarding the foundations of the kinetic theory of gases.

MANCHESTER

Literary and Philosophical Society, November 2.—Prof. Osborne Reynolds, LL.D., F.R.S., Vice-President, in the chair.—The following papers were read:—Measurements of the magnetic induction and permeability in soft iron, by H. Holden, B.Sc.—The action of hydrochloric acid gas upon certain metals, by J. B. Cohen, Ph.D., F.C.S.—Capillary constants of benzene and its homologues occurring in coal-tar, by J. B. Cohen, Ph.D., F.C.S., all communicated by Dr. A. Schuster, F.R.S.

SYDNEY

Linnean Society of New South Wales, October 27.—Prof. W. J. Stephens, F.G.S., President, in the chair.—The following papers were read:—Catalogue of the described Coleoptera of Australia (part vi.), by George Masters. The present part contains all the known Scolytidae, Brentidae, Anthribidae, Bruchidae, and Cerambycidae of Australia, making the total number of species catalogued up to the present time, 6231. The next part, which will be published early in next year, will complete the Coleoptera.—Descriptions of new Lepidoptera, by E. Meyrick, B.A., F.E.S. In this paper descriptions are given of sixteen new species of Australian Lepidoptera belonging to fourteen genera, of which six are new. Among them is *Thalpochara cocophaga*, of which, at the December meeting of the Society, Mr. Masters exhibited specimens of both moths and larvæ, and called attention to the singular habits of the latter, which feed on a species of Coccus infesting a Macrozamia, living concealed in a cocoon-like shelter formed of the exuviae of the Coccus, and finally pupating therein.—On the flowering seasons of Australian plants, by E. Haviland, F.L.S. This paper enumerates 113 species of plants observed in flower in the neighbourhood of Sydney during the month of July of this year, and is intended to be the first of a series of papers on the subject, by means of which it is hoped that the flowering seasons of at least the plants of the county of Cumberland will eventually be recorded.—Notes on the Rutaceae of the Australian Alps, by James Stirling, F.G.S., F.L.S. Fourteen species of Rutaceous plants are enumerated as occurring in the region of the Australian Alps, of which one belongs to the genus *Zieria*, two to *Boronia*, nine to *Eriostemon*, and two to *Correa*. Remarks are also made upon the climatic and other conditions under which the plants occur, and the origin of their specific differences.—On a probably new species of tree-kangaroo from North Queensland, by C. W. De Vis, M.A. The name of *Dendrolagus mitchellianus* is proposed for a supposed new species of tree-kangaroo of which one specimen was obtained in the Daintree River District. It lived in captivity for a time, but was subsequently killed, and its skin, unfortunately deprived of everything but the bones of the hands and feet, was subsequently submitted to Mr. De Vis, who, after comparing it with two skins of *Lumholtzi*, Collett, has no doubt that it is distinct from its compatriot, and is more nearly allied to *D. dorianus*, Ramsay. A full description as is possible under the circumstances is given in the paper.—Dr. Ramsay exhibited a specimen of an apparently new species of Monacanthus, presented to the Australian Museum by Mr. G. R. Eastway. He also exhibited eggs of *Ptilonorhynchus violaceus* and *Rhynchaea australis*, and read a paper on the subject.—Mr. A. J. North exhibited eggs of *Ura victoria*, Gould, from South Gippsland, and of *Ura sticticus spinicollis*, Jameson, from Hillston, N.S.W.—Mr. Whitelegge exhibited some magnificent specimens of the Alga

Claudea Bennettiana, Harvey, hitherto known only from one small specimen. It was found abundantly near the Heads of Port Jackson during a recent trawling excursion in connection with the Australian Museum. Some of the specimens taken were nearly 1 foot in diameter. Mr. Whitelegge also exhibited a fine specimen of *Eozoon canadense*, and slides of it and of the above-mentioned Alga under the microscope.

PARIS

Academy of Sciences, December 20.—M. Jurien de la Gravière, President, in the chair.—Addendum to the note of December 6 on the conditions determining the form and density of the earth's crust, by M. Faye. In reply to M. de Lapparent's further objections to his theory, the author gives more detailed explanations regarding the phenomenon of compensation between land and water, pointing out that to this compensation is due the persistence of the original ellipsoidal figure of the globe.—On the phosphorescence of alumina, by M. Edmond Becquerel. The experiments here described point to different conclusions from those recently arrived at by M. Lecoq de Boisbaudran, while confirming those deduced from the author's earlier researches.—On some dispositions by means of which birefractive photometers may be realised without polarising the light, by M. A. Cornu. Without dispensing with the simpler apparatus of geometrical optics, the author describes several readjustments, which enable him to obtain double images of variable intensity in accordance with a well-known law, without having recourse to the employment of polarised light.—Remarks on M. Hugoniot's notes on the flow of gases, published in the *Comptes rendus* of November 15 and 22, by M. G. A. Hirn. The author replies briefly to the objections urged against his conclusions by M. Hugoniot, and still rejects the kinetic theory of gases, which he persists in regarding as one of the most fatal errors of modern science.—Observations in reference to Dr. Philip Paulitschke's "Researches on the Ethnography and Anthropology of the Somali, Gallas, and Hararis," by M. de Quatrefages. These observations, accompanying presentation of a copy of Dr. Paulitschke's work to the Academy, dwell especially on the great scientific interest presented by the mixed Negroid populations of Eastern Africa to the student of anthropology. These peoples are regarded as the outcome of an extremely ancient crossing between the Negro and the White races, the latter being represented chiefly by the African Semites.—Considerations on deep-sea fishes, and especially on those belonging to the sub-order Abdominalidae, by M. Léon Vaillant. These remarks have special reference to the captures made by the *Talisman* Expedition, which included no less than 3800 true fishes, and which, combined with the researches of Günther, Gill, Cope, Goode, and Bean, already supply materials for a rough classification of these marine Vertebrates.—On the copper present in the grapes and wines yielded by vines treated with various cupreous preparations against mildew, by MM. U. Gayon and Millardet. These researches seem to show that, while the different processes generally exercise some influence on the quantity of copper contained in the grape and vinous fermentation, they appear to have none at all on the quantity of copper which remains in the wine after fermentation. The clear wine, after perfect clarification, contains no appreciable quantity of the metal.—Volume, absolute heat, and specific heat of saturated vapours, by M. Ch. Antoine. Taking a special zero for each vapour, simple formulas are established for working out these several volumes.—Note on the Abelian functions, by M. Appell.—On angular acceleration, a problem of pure kinematics, by M. Ph. Gilbert.—On the flow of elastic fluids, by M. Hugoniot. The author here applies to the flow of saturated aqueous vapour the same method already employed by him in the study of the flow of permanent gases.—Apparatus showing the two modes of reflection of a vibratory movement, by M. J. Violle. The apparatus here described has been constructed by M. König, and is perfectly adapted for demonstrating the method employed by Regnault in his great work on the measurement of the velocity of sound.—On some new properties, and on the analysis, of the pentafluoride gas of phosphorus, by M. H. Moissan. Having already indicated a new process for preparing this substance, the author here gives some fresh results terminating his researches on the phosphorated compounds of fluor.—On the relations of the efflorescence and deliquescence of the salts with the maximum tension of the saturated solutions, by M. H. Lescœur. The conditions of the efflorescence and deliquescence of the salts as determined by Debray are here brought into rela-

tion with the maximum tension of the saturated solutions.—Heat of formation of the methylate and ethylate of potassa, by M. de Forcrand.—On the wines and brandies extracted from strawberries and raspberries, by M. Alph. Rommier. By the process here described raspberries are made to yield a wine with over 18 per cent. of alcohol instead of the normal 2 or 2.5 per cent., while the brandy distilled from it retains a highly aromatic flavour. A still more palatable wine, with 16 per cent. of alcohol, is obtained from the fine strawberries grown in the neighbourhood of Paris, the corresponding brandy also preserving the flavour of the fruit.—On the zymotic properties of certain virus: fermentations of nitric substances under the influence of non-aërial virus, by M. S. Arloing. The object of this communication is to show that the virus of non-aërial microbes stimulates the fermentation of albuminoid substances.—Note on the multiplication of *Leucophrys fatula*, Ehrenberg, by M. E. Maupas. In a favourable medium, a single individual of these Infusoria, which multiply by fission, is found to increase to over a million in five days. Certain hitherto unobserved irregularities in the process of segmentation are here described.—On the phosphorescence of the Geophili, by M. Macé. As studied on a *Geophilus simplex*, Gervais, this phenomenon appears to be analogous to that of certain Chetopoda described by Panceri and Jourdan.—On the typical nervous system of the dexter and sinister Prosobranchæ, by M. E. L. Bouvier. Fresh anatomical and physiological studies on the Glyciphagi, by M. P. Mégnin.—The diseases of the olive, by M. L. Savastano. A brief description of the various forms of hyperplasia and tumours by which this plant is affected.—Remarks on the so-called Calcifugal vegetation, by M. Ant. Magnin. A theory is advanced to explain the presence of these plants in the limestone region of the Jura.—On two rocks in the Velay and Lyons districts, containing beryl and apatite, by M. Ferdinand Gonnard.—On an experiment undertaken to determine the direction of the currents of the North Atlantic, by Prince Albert of Monaco. The author describes a second excursion on board the *Hirondelle*, during which 510 bottles were thrown into the sea along a course about 500 miles long, and nearly parallel with the twentieth meridian west of Paris. The operation was begun on August 29 and completed on September 5, 1886, and some of the floats have already been picked up at various points on the European seaboard; but the general results are reserved for a future communication.—The periodical showers of shooting-stars and the seismic disturbances of the years 1883, 1884, and 1885, by M. Ch. V. Zenger. During these years, both orders of phenomena are shown to coincide, while they are also frequently accompanied by hurricanes, cyclones, electric discharges, and auroras.

BERLIN

Physiological Society, October 29.—Prof. du Bois-Reymond in the chair.—Dr. J. Munk reported on experiments instituted by him in the course of the last two years with a view of arriving at an experimental decision between the two theories of the secretion of urine: the filtration theory of Ludwig, and the secretion theory of Heidenhain. According to the first theory, the blood-pressure prescribed the measure for the urine secretion; according to the second theory, the urine got secreted from the secretory epithelial cells of the kidneys, and the quantity of the matter secreted was dependent on the rate of movement of the circulation of the blood. The speaker had instituted his experiments on excised but living kidneys, through which he conducted defibrinated blood of the same animals, under pressures which he was able to vary at pleasure between 80 mm. and 190 mm. Fifty experiments on dogs whose blood and kidneys were, during the experiment, kept at 40° C., yielded the result that the blood of starving animals induced no secretion of urine, which, on the other hand, showed itself in copious quantities where normal blood was conducted through the kidney. If to the famished blood was added one of the substances contained as ultimate products of digestion in the blood, such, for example, as urea, then did the secretion ensue. The fluid dropping from the ureter contained more urea than did the blood. That fluid was therefore no filtrate, but a secretion. An enhancement of the pressure of the blood flowing through the kidney had no influence on the quantity of the secretion passing away. An increased rate of movement on the part of the blood, on the other hand, increased in equal degree the quantity of urine. On a solution of common salt or of mere serum sanguinis being poured through the kidney, no secretion

followed. All these facts, involving the exclusion of the possibility of a central influence being exercised from the heart from the nervous system on the kidneys, were deemed by the speaker arguments proving that the urine was secreted by renal epithelial cells. A series of diuretics was next tried in order to establish whether they operated in the way of stimulating centrally on the heart or peripherally on the renal cells. Urea was a central diuretic. Common salt, on the other hand, was a peripheral diuretic. Added in the portion of 2 per cent. to the blood, it increased the quantity of urine eight- to fifteen-fold. Even in much less doses, it was a powerful diuretic. In a similar manner, if yet not so intensely, operated saltpetre and carbonate of soda, as also urea and pilocarpine. On the introduction, however, of the last substance into the blood, the rate of circulation was accelerated in an equal measure as was the quantity of urine secreted, so that in this case the increase in the quantity of urine was, perhaps, exclusively conditioned by the greater speed of the movement of the blood. On the other hand, the quantity of secreted urine was reduced when morphine or strychnine was administered to the blood. In the case of the application of strychnine, the rate in the current of the blood was reduced in a proportion equal to the reduction in the secretion of the urine. The speaker had, finally, demonstrated the synthesis of hippuric acid and sulphate of phenol in the excised kidney as a function of its cells, by adding to the blood pouring through the kidney in the first place, benzoic acid and glycol; in the second place, phenol and sulphate of soda. In order that these syntheses should make their appearance in the excised kidney, the presence of the blood-corpuscles was not necessary, though, indeed, the presence of oxygen in the blood was indispensable.

BOOKS AND PAMPHLETS RECEIVED

The Origin of Mountain Ranges: T. M. Reade (Taylor and Francis).—The Six Inner Satellites of Saturn: Appendix 1 and 2: A. Hall (London).—Conchylien der Gosauergelände von Aigen bei Salzburg: L. Tausch (Fischer, Wien).—Ueber die Fauna der Oolithe von S. Vigilio: M. Vacek (Fischer, Wien).—Jahrbuch der k.k. geologischen Reichsanstalt, 1886 (Hölder, Wien).—Monthly Summary of Meteorological Means for Year 1885, Imperial Meteorological Observatory.—Report of the Meteorological Observations for Years 1876-85 at the Meteorological Observatory at Tokio.—The Arithmetic of Electrical Measurements: W. R. P. Hobbs (Murby).—Zoological Record, vol. 1 (Van Voorst).—My African Home: L. W. Fielden (Low).—Studies in Life: G. C. Lorimer (Low).—The Mechanics of Machinery: A. Kennedy (Macmillan).—A Strain Indicator for Use at Sea: C. E. St. John.—Report on the Progress and Condition of the Government Botanical Garden at Saharanpur and Mussoorie for Year ending March 31, 1886 (Allahabad).

CONTENTS

Babington's "Birds of Suffolk"
Intermittent Downward Filtration
A Medical Index-Catalogue. By A. T. Myers
Letters to the Editor:—
Sounding a Clarion, Fusion-Points, Pyrometers,
Seismometers.—Dr. H. J. Johnston-Lavis
The Recent Earthquakes.—Prof. J. P. O'Reilly
Barnard's Comet.—Dr. Wentworth Erck
Electricity and Clocks.—Henry Dent Gardner
Seismometry.—Thomas Gray
The Recent Weather.—R. B. W.
Observations of Nebulæ at Arcetri
The Mathematical Tripos, III. By J. W. Glaisher, F.R.S.
The International Committee of Weights and Measures
Notes
Our Astronomical Column:—
The Spectroscopic Method of Determining the
Distance of a Double Star
Names of Minor Planets
Comet Finlay (1886 e)
Comet Barnard (1886 f)
Astronomical Phenomena for the Week 1887
January 2-8
Notes from the Otago University Museum, IX.
By Prof. T. Jeffery Parker. (Illustrated)
The Imperial Institute
University and Educational Intelligence
Scientific Serials
Societies and Academies
Books and Pamphlets Received

THURSDAY, JANUARY 6, 1887

SCIENCE AND THE JUBILEE

THE year of Jubilee has come, and on all sides we hear of proposals to make it memorable in one way or another. It is right that the completion of fifty years of such a glorious reign as that of the present Queen should be celebrated by all kinds of noble effort, and the more the future greater well-being of the Queen's subjects is considered in those efforts, the more lasting such memorials will prove. But, so far, the word Science has scarcely been mentioned either in summing up the progress of the nation during the last fifty years, or in considering how science should have its place among the memorials by which this year is to be marked out from among its fellows.

This is not encouraging; still less encouraging is it that at the beginning of such a year the progress of science in this country finds itself jeopardised in a serious manner. According to rumour part of Lord Randolph Churchill's famous "plan" was to increase his reputation not only by crippling our national defences but by paralysing all those efforts to spread science broadcast in our land for which the Science and Art Department and other kindred organisations, such as the British Museum, are responsible. To effect any large economy in this direction science schools must have been swept away, science classes crippled, science scholarships abolished, and science museums cast into the limbo of ineffectiveness.

Truly the politician's trade is a curious one; for, supposing the rumour to be well founded, and that all these things had been proposed, what then? In a week the common-sense of the country would have found out that the Government which could sanction such measures was out of touch with all true progress. But suppose, further, that they were permitted to be carried out; we should just be where we were fifty years ago in many things which by common consent lie at the root of all true national progress. It is lamentable, indeed, that even yet the Philistine is so rampant among us, and that those to whom the nation looks for good government and light and leading know so little about our actual needs.

Indeed, it must be frankly conceded that in these matters our nation is fifty years behind others. Nay, more: we must possess our souls in patience for yet another fifty years: for not till then, as things go, it is to be feared, will the average politician know the rôle which science plays in modern progress, and the stern necessity there is, if we are to hold our own among the nations, that scientific instruction must be enormously extended.

Turning now to another matter which is engaging much attention in connection with this memorable year, we must confess to a feeling of disappointment in connection with the proposals for an Imperial Institute which we printed last week (p. 210). The Committee who drew up the Report, on which, no doubt, action will soon be taken, have undoubtedly avoided many errors into which they would have fallen had they followed much of the advice which has so freely been tendered to them; but we think that they have missed their mark in great measure, for the reason that the Committee too much resembles the

play of "Hamlet," with the Prince of Denmark omitted. It did not please the Prince of Wales to nominate any official representative of science upon it. We do not forget that the Committee had the advantage of numbering Sir Lyon Playfair among its members, but he was not there as an official representative of science, and, had he been, such representation would have been numerically insufficient. As it is, it is not difficult to surmise that many of the best suggestions contained in the scheme are his, and this makes us regret the more that he was there single-handed.

In our view, there is room for an Imperial Institute which might without difficulty be made one of the glories of the land, and which would do more for the federation of England and her colonies than almost any other machinery that it is possible to imagine. But it must be almost exclusively a scientific institution. Its watchwords should be "Knowledge and Welcome." England, through such an institution, should help her colonies in the arts of peace, as she does at present exclusively in the arts of war. In an Imperial Institute we can imagine the topography, the geology, the botany, and the various applications of science and the industries of Greater Britain going hand in hand.

This year is not only the 50th anniversary of the Queen's accession, but it is the 800th anniversary of Domesday Book. Let the Imperial Institute be the head-quarters of a bigger Domesday Book; let all knowledge be there accumulated concerning the growth of England's children during the last 800 years; let the knowledge be complete and so arranged that what comes from each quarter shall throw light on all. Those who know how matters stand best, will see that in the case of many of our colonies this knowledge does not exist; then let it be the proud duty of the Imperial Institute to get it. We have colonies in which ar large stretches of country teeming with mineral and botanical wealth where no surveyor, or botanist, or geologist has ever trod. Let the Imperial Institute bring about the arrangements by which they may be sent; we have men engaged upon all these works at home. We can imagine no greater service rendered to the science of this country than that those engaged upon its various surveys should enlarge their experience by that "travel, travel, travel" upon which Sir Charles Lyell insisted. The presence of such men for a few months in those colonies where survey have not already been established would be of inestimable advantage on both sides; and if the system were at work for a few years it would be found that there is no more necessity for a colony, unless it prefers to do so, to establish the whole mechanism of a Geological Survey and a Topographical Survey for itself than there is for it to establish an Admiralty or a War Office.

We would by no means limit this scientific outlook to surveys merely. Take the present condition of Barbados as a case in point. Barbados must either start some new industry or she must starve. This new industry must depend upon new knowledge. We take no steps to help Barbados with our brain power, as if it was not our concern; but if Bridgetown were under the guns of a foreign fleet, the whole money and muscle power of the Empire would, if necessary, be at her disposal.

We have said enough to indicate the general direction in which we believe the Imperial Institute can do the noblest

work, and can make itself felt more and more as years roll on, and we believe that if the future governing body of the Institute is a truly representative one, that is, if science is properly represented on it, by such men as the President of the Royal Society, the Directors of the Royal Gardens and of the Geological and Topographical Surveys, that such functions as those we have suggested will be obvious.

To turn now to another part of the scheme, the Report wisely suggests that the new Emigration Office should form part of it. With this we cordially agree. But the return current must be provided for. Those who have lived in England's colonies and dependencies know best the intense home feeling, and in many cases the stern necessity there is of close contact with the mother country. Let the Imperial Institute be England's official home of her returning children, the Hall in which she officially welcomes them back. Let them here find all they need, and let information and welcome be afforded with no stinted hand.

Along the two large lines we have indicated, we believe that there are efforts to be made which could only be effective as connected with such an institution as an Imperial Institute, and we believe that they are more germane to its functions than some of the minor utilities shadowed forth in the Report.

The Committee has certainly made out its case in favour of South Kensington. And it will be generally conceded that, if the Institute has for its chief objects the binding together of the various developments of science and art in the mother country and her colonies into one homogeneous whole, the Commissioners for the Exhibition of 1851 would be perfectly justified in making the valuable gift to the Institute which is referred to in the Report. We shall not follow the *Times* in gibing at South Kensington. To us South Kensington means the Science and Art Department, with its schools, museums, and laboratories, and the Natural History Museum; and we know that these institutions have had no more to do with the various shows there during the last few years than they have with the services of the Oratory, with which they are also geographically associated.

It is with several unpleasant reminiscences connected with these shows still in our minds that we are somewhat doubtful of that part of the Report which refers to the exhibitions of various Imperial products, and we believe the only safeguard possible, if they are really instituted, would be that they should be open free to the public like the National Museums.

HISTORICAL GEOLOGY

The Student's Hand-book of Historical Geology. By A. J. Jukes-Browne. (London: George Bell and Sons, 1886.)

GOOD wine needs no bush, but every prudent vintner will carefully abstain from hanging out a sign calculated in any way to convey to the passer-by the impression that the liquor to be obtained within is of inferior quality. If authors were equally cautious, we should not see, as in the case before us, a good book disfigured by a frontispiece, to say the least, not calculated to produce a favourable impression on the mind of one who opens the

work for the first time. The plate in question is a fanciful representation of what some one has imagined may have been the distribution of land and sea during the Carboniferous period. It depicts the present bed of the North Atlantic as then occupied by a broad tract of continental land. Now, when we picture to ourselves a long tongue of land running out, during Carboniferous times, from Scandinavia across the Highlands of Scotland and on to the north and west of Ireland, we are well within the bounds of legitimate speculation. The arguments in favour of such an hypothesis are too well known to need reproduction here. Again, when we look at a geological map of North America, and note how the great central tract of Palæozoic formations is even now hemmed in on the north and east by a belt of Archæan rocks, we are indulging in no improbable supposition if we infer that during Palæozoic times, the eastern Archæan strip extended further to the east than now, and that from it was derived part of the material for the formation of the rock of the Palæozoic basin. But it is obviously quite another thing if, on the strength of these two highly probable suppositions, we proceed to fill up the whole of the intervening ocean. It is a puzzle to our mind to imagine on what grounds any one can pretend to know what was the condition of things in mid-Atlantic so far back in the earth's history, and any attempt to lay down such a map as figures in the frontispiece to the present volume seems to be about as striking an instance as can be found of unscientific use of the imagination.

Luckily a very slight acquaintance with the book will dispel the unfavourable impression likely to be created by its frontispiece, but the introduction of this map has permanently impaired the usefulness of the present edition, because the money spent on it would probably have sufficed to furnish a number of illustrations of real value, which are very much wanted. The book contains careful descriptions of the physical geography of the British Islands at different geological periods, but the verbal accounts of the distribution of land and sea are hard to follow; and if each had been accompanied by a small outline map the value of these really important descriptions would have been more than doubled.

To pass to our author's treatment of the several formations. In the case of each he begins with a general sketch, in which he explains, among other matters, the grounds on which the formation was established and received a distinctive name; then follows a summary of the life of the period, illustrated by woodcuts of rather unequal execution; after this he proceeds to detail stratigraphy, describing the minor subdivisions and lithological character of their rocks at the principal localities where the formation has been studied; and he concludes with restorations of the physical geography of each period. Detailed stratigraphy in a work of the present size must necessarily be very condensed; and it is a question whether under this head an attempt has not been made to be too encyclopædic. In his nomenclature the author perhaps shows some weakness for new names; the restorations of old physical geography seem to be accurate and cautious, and as successful as they can be made without illustrative maps.

In the account of the Archæan rocks he displays caution and a freedom from dogmatism and partisanship.

denuded Carboniferous beds. Elsewhere, as on the west side of England, there was no break of this kind, but sedimentation went on continuously, or with but very slight interruption, from Carboniferous into Permian times, and there is what practically amounts to a passage from Carboniferous into Permian rocks.

There is one very healthy sentence in the chapter on "The Dyas." "There is no proof that the red rocks" (of the English Permians) "are as a whole older than the limestones, and the notion of their being so is a mere assumption founded on their lithological similarity to the German Rothliegende." If the author had said "fancied similarity," it would have been still more to the point; but it will be most useful to have clearly stated that this correlation, so dear to the pigeon-hole systematists, has nothing to rest upon.

Before concluding, we would call attention to three omissions which it seems desirable to notice. In the account of the Lower Oolites of the Yorkshire coast there is no mention of the marine band discovered by the Geological Survey and named the Ella Beck Bed (*Memoirs of the Geological Survey, explanation of Quarter Sheet 95, N.W., p. 33*). This is a very small matter; but we think it is very much to be regretted that no word has been said, in the account of the Cretaceous rocks, of the southern type of that formation, the Hippurite Limestone, and that in the description of the Tertiary rocks the Nummulitic formation is also passed by in silence. The book is primarily a book on British geology, but in cases, like that of the Triassic rocks, where the British representatives are abnormal or exceptional, the author has not hesitated to take his readers to foreign localities where the normal type is found. Now surely the rocks of the Anglo-Parisian Cretaceous basin are decidedly exceptional in their character, and were formed to a large extent under very special conditions; and the best way to enforce this truth on the reader is to introduce him to the beds of the same age deposited elsewhere in a less special manner. The large range too of the Hippurite Limestone gives it precedence over the deposits laid down in what was after all only a biggish and somewhat land-locked inlet of a western ocean. And the same thing may be said, even with more emphasis, of the Eocene beds. What an imperfect idea any one would have of the physical geography and events of that period who knew only the littoral and estuarine representatives found in the London and Paris basins. If space were an object, it would have been better to have omitted many things which now find a place in the book than to have passed over two such formations as the Hippurite and Nummulitic Limestones. For instance, it seems to be a fixed article of faith that every geological text-book must contain an account of the Permians of the Thüringerwald, a little isolated group with a very special character of their own, and with little or no bearing on British geology, but, as has been said, dear to the pigeon-holders. The omission of the account of this group, and of one or two similar sections of the book besides, would have left ample room for all that need have been said about the two great formations mentioned above.

Such little flaws as have been noted seem to be present in the structure of what, on the whole, will prove a most useful book. If any of the suggestions we have made

commend themselves to the author's judgment, we trust he will soon have an opportunity of acting upon them in a second edition.

A. H. GREEN

PHOTOGRAPHS AND DESCRIPTIONS OF WILD ANIMALS

Wild Animals, Photographed and Described. Illustrated by Phototype Reproductions of Photographic Negatives taken from Life. By J. Fortuné Nott, Major, Canadian Active Militia. (London: Sampson Low and Co., 1886.)

THE author of this splendidly printed volume, while disclaiming the idea that it is an erudite or scientific work on natural history, assures us that his object in writing and compiling it was to furnish some trustworthy information about some few of the most important varieties of existing wild animals, and to do this in an entertaining and readable manner. The works at present existence on such a subject may be classified, the author thinks, into the "scientific" and the "educational": the former are, in great measure, incomprehensible to general reader; the latter have their value to the same class of reader greatly spoiled by the taint of levity that characterises the style in which they are written. When a bear is talked of as "Master Bruin," and a lion as "His Majesty," the dignity of the subject is compromised.

This being so, Mr. Nott thought there was room for a book which "would accurately describe the salient features distinguishing peculiarities, and specific habits" of wild animals, and that by dropping, as far as possible, scientific descriptions and the general use of scientific nomenclature, and adding certain historical facts or interesting anecdotes in which they prominently figured, he could make such a volume readable and entertaining.

It is, however, obviously impossible that any one man could personally be familiar with the habits of all our larger animals, and the author has borrowed a good deal from the works of travellers that "have appeared within the last few years, rather than from similar works of previous dates, wherein fable and truth are so blended that they were practically useless" for his purpose.

Respecting the illustrations of this volume, the author has attempted a new departure. Instead of illustrating his book with portraits of animals taken by artists, which often represent rather the artists' ideas of what animal ought to be than what the animal really is, he has had photographs of these wild beasts made, and illustrates the volume with phototype reproductions of these. He apologises for the photographs, owing to the difficulties encountered. It is difficult to get human beings to properly for their portraits, but wild animals must be taken often in darkish dens, and are not amenable to orders to keep quiet and look their best.

To our mind, these photographic illustrations are the more important portion of this volume, which, from its fine type and paper, and wealth of illustration, is likely to become popular. The photograph of the lion is excellent. This beast, as our author would call him, has behaved extremely well under the trying ordeal, and has "come out" first-rate. The group of zebras form a pretty picture. The photographs of the giraffe, hippopotamus, and kangaroos are characteristic. The text calls for li

comment: we have descriptions of a large number of familiar wild animals, and in these the author has undoubtedly avoided as much as possible being at all scientifically exact. In our opinion the work would have gained in value and interest, and as an "educational" work, if the author had taken care, when he had to use scientific phrases, that he did so with some meaning. Thus it appears odd, to say the least, to read: "The bears, genus *Ursidæ*, belong in natural history to the sub-order *Carnivora*"; and that the kangaroos belong to the genus *Macropodidæ*. It would not have required a large knowledge of logic or science to avoid such mistakes.

Most of the photographs are from animals in the London Zoological Gardens, which will give a special interest to the volume.

OUR BOOK SHELF

First Year of Scientific Knowledge. By Paul Bert. (London: Relfe Brothers, 1886.)

THIS is an English edition of a little book which made M. Paul Bert's name familiar to a vast number of persons in France who knew nothing of his eminence either in science or in politics. As the title indicates, it is intended for children beginning to study science, and we know of no book better adapted for this purpose. It is a book of great merit both in style and selection of subjects. The more experimental sciences are treated as their nature demands—practically; the experiments are simple, and few will find any difficulty in performing them.

The illustrations constitute one of the special features of the book, for a diagram often conveys more meaning than a whole page of print. The language throughout is clear, and everything is simply yet accurately explained. As an example we may refer to p. 333, where the popular fallacy respecting the so-called "respiration of plants" is disposed of:—

... "Thus, simultaneously, in the same plant, two opposite phenomena take place: the production of carbonic acid by the parts that are not green, and consumption of carbonic acid by those that are green. Only, the latter activity being much more powerful than the former, the plant not only does not augment the proportion of carbonic acid in the air, but consumes what it finds there. . . . The decomposition of the carbonic acid by the green parts is quite the reverse of respiration, and bears a much closer resemblance to digestion."

The general character of the book leaves little to be desired.

La France en Indo-Chine. Par A. Bouinai et A. Paulus. (Paris: Challamel Ainé, 1886.)

THE important events of the last few years in Annam, Tonquin, and Cambodia have given rise to a quantity of literature in France, relating to this region, which has now reached enormous proportions. French periodicals of all kinds are full of papers relating to it, and new books on the same subject have been issued in many scores during the past three years. Every department of research is represented—historical, scientific, literary, antiquarian, industrial, commercial, &c. If this great flood represents, as it undoubtedly does, the keen interest taken by the French people in the countries with which they have now so close a connection, it is none the less embarrassing to foreign readers who desire to obtain a general and accurate survey of Indo-China. Amid the host of works, good, bad, and indifferent, now issuing from the French press on this region, and on every conceivable topic connected with it, it is difficult to select one which contains all that is wanted by the ordinary cultivated person, who desires to have some knowledge of countries which have been the theatre of events that have

moved Europe profoundly. At last MM. Bouinai and Paulus have produced such a book. Capt. Bouinai has served long in Tonquin, and is actually a member of the Frontier Delimitation Commission, and Prof. Paulus, of L'École Turgot, though, we believe, he has never visited the country, has made it a special study, and has laboured to popularise a knowledge of it in France. The two authors have already published a very much larger work on the same subject, of which the present one appears to be an abridgment intended for wider circulation and more general information.

Perhaps the most satisfactory manner of reviewing a work such as this, which covers a large and varied field with brevity, is to describe shortly its arrangement and contents. The first chapter refers to the geography, orography, hydrography, and climate of Indo-China, including in this term French Cochinchina, Cambodia, Annam, and Tonquin. The second chapter deals with the history of French intercourse with these regions, commencing, properly speaking, with the cession to France of Tourane Bay and Pulo Condor in 1787, a cession which was due to the management of Pigneau de Béhaine, Bishop of Adran *in partibus*. All the interesting and exciting incidents of the occupation of Saigon, the Garnier and Philastre missions to Tonquin, and the events succeeding the death of Rivière down to the death of Courbet and the peace with China, are recounted with perfect clearness and accuracy. Next, the inhabitants are described, as well as the towns, and forms of religion prevailing in the countries. The aboriginal population is treated under the heads Moïs, Chams, and Muongs, a division which is perhaps sufficient in a book intended for popular reading, but which the authors themselves acknowledge to be wholly inadequate, as they refer also to "savages inhabiting the mountains," the phrase usually employed by the Chinese when speaking of a people about whom they know nothing. The ethnological questions connected with the Moïs, Muongs, Chams, and the unnamed "savages" can scarcely be answered for many years to come; but they are amongst the most interesting ones connected with ethnology in the Far East. The origin and relationship of these and other scattered fragments of once powerful peoples, not in Indo-China alone, but in Upper Burmah, and all over China south of the Yangtze, did not come within the scope of MM. Bouinai and Paulus's work, although the latter shows how little is known about them when they are all classed indiscriminately as "savages of the mountains." The fourth chapter deals with productions, trade, and communications, and the fifth with the administration in each of the countries mentioned. Finally comes a chapter on the future, a political forecast, to which we need not refer further. The work, it will be seen, goes over the whole field, and, as far as we have been able to check the statements, it is very accurate. As there is no English book on the subject, this may be recommended to readers who desire to know something of the new region which is but now being brought into close contact with Europe. Whether the French are a colonising or only a conquering people, though much debated, is a question with which we are not concerned here: what is beyond all question is that no effort is spared by the Government or the public to acquire that first indispensable requisite of all good and intelligent government, viz. a knowledge of the country and people to be governed. No expense is considered too great, no labour too burdensome, to obtain this knowledge. In this respect they set an example which one more successful colonising nation at least might well follow.

My African Home. By Eliza Whigham Feilden. (London: Sampson Low, 1887.)

In 1852 Mrs. Feilden and her husband went to Natal, where they remained for five years. On her return to

England her letters were restored to her, and in the present volume she has arranged them in chronological order, with extracts from her journal. The book contains a mass of petty details in which few readers will find much to interest them; but there are also some very good sketches of the scenery of Natal and of the rough, free-and-easy life of the colonists. Mrs. Feilden was much impressed by the fertility of the soil, and by the beauty of the vegetation with which she was surrounded. "As for fruits, vegetables, and flowers," she wrote, "you have only to put the seeds and young plants in the ground and they grow. There is no end of season in Natal." She remarked that there were not many native fruits, but that all that were imported seemed to suit the soil and climate. The native flowers she considered "very exquisite." They "grew in great variety and luxuriance, with the waxy look of hot-house plants." As for birds and insects, the air teemed with them. Of the Caffres Mrs. Feilden formed a very poor opinion. "The Caffre is indolent; he lives only like the beast, to eat and sleep, and pass through life with ease; but to do this he must have his land tilled, and to purchase wives to till his land he must have cows to pay for them. He sells his daughters to be drudges to other Caffres, while the boys and young men go out to work for the white man, till they can in turn buy cows and wives." Even Caffres, however, have one good quality: "they heartily share anything they have with each other, and eat out of the same pot without the least feeling of who shall have most." To Mrs. Feilden they seemed to be rather like Jews, and she asks whether they may not be descendants of Ishmael or an offshoot from the lost tribes—from which it may be inferred that in the list of subjects she has tried to study ethnology has not yet been included.

LETTERS TO THE EDITOR

- [The Editor does not hold himself responsible for opinions expressed by his correspondents. Neither can he undertake to return, or to correspond with the writers of, rejected manuscripts. No notice is taken of anonymous communications.]
- [The Editor urgently requests correspondents to keep their letters as short as possible. The pressure on his space is so great that it is impossible otherwise to insure the appearance even of communications containing interesting and novel facts.]

The Coal-Dust Theory

UNDER the title of "A New Mining Danger," the *Yorkshire Post* of the 16th ult. published its final report on the proceedings at the inquest on the bodies of twenty-two men and boys who perished in an explosion at Altofts Colliery, Normanton, on the 2nd of October last.

The inquest was commenced immediately after the explosion, but was adjourned until the workings could be sufficiently reopened to admit of a careful examination being made into all the circumstances. It was resumed and concluded on the 13th, 14th, and 15th of December. The witnesses, including Mr. F. N. Wardell, Her Majesty's Inspector of Mines for the district, were unanimously of opinion that the explosion was originated by the firing of a shot in the stone or rock constituting the side of one of the main thoroughfares of the colliery, which was also a main intake airway; and they were of opinion that it had expended part of its energy in raising and igniting a cloud of coal-dust, which formed the nucleus whence the explosion was propagated.

The coroner in summing up agreed with this conclusion, and the jury returned the following verdict:—

"That the whole of the workmen killed, except Deakin and Lomax, met their deaths from an explosion of coal-dust, which originated in the west chain road, which explosion was caused by the firing of an unskillfully drilled shot by one of the men engaged in widening the road; and that Deakin and Lomax were suffocated by the stoppage of ventilation consequent on the explosion."

The coal-dust theory, which is discussed at some length in the Final Report of the Royal Commissioners on Accidents

in Mines, postulates that coal-dust may not only serve to originate an explosion, under certain given conditions, but may continue to carry it on as far as the same conditions extend. The essential conditions appear to be: that the coal-dust be perfectly dry, in a very fine state of division, and fairly abundant in quantity; that the initial cause be a large flame expanding with sufficient force to propel the air rapidly in front of it, so as to raise a cloud of coal-dust; and, lastly, that the explosion take place in a confined space, such as the workings of a mine.

From the first this theory was intended to account for great explosions in mines, or accomplished facts, which seemed to be otherwise inexplicable. It has nothing to do with mines in which explosions have not taken place, except to point out a possible source of danger; and arguments opposed to it which are based upon the fact that all kinds of coal-dust are not equally inflammable are therefore obviously inapplicable. It was adopted by the Prussian Commissioners as being applicable to certain inflammable dusts in a minute state of subdivision, but not to others of a somewhat different chemical composition. In discussing the Camphausen explosion in *NATURE* (vol. xxxi. p. 13), I pointed out that the conclusions arrived at from a consideration of the experimental results obtained with Camphausen dust by the Prussian Commissioners, fell far short of the actual occurrence in the colliery, and that the same relation would probably obtain in the case of all the other dusts experimented with, provided all were made equally fine.

MM. Mallard and Le Chatelier, whose conclusions were accepted by the French Commission, of which they were members, rejected the coal-dust theory, and endeavoured to reason away all apparently confirmatory arguments drawn from the consideration of actual explosions in mines.

In this country it has been accepted by some of the Inspectors of Mines, and more particularly by Messrs. W. N. and J. B. Atkinson, who uphold it vigorously in their treatise on "Explosions in Mines," which was recently reviewed in *NATURE* (Nov. 4, 1886, p. 1) by Prof. Thorpe. It appears also to have found favour with a number of mining-engineers and colliery managers, both here and abroad. There seems, however, to be some doubt as to how far it was accepted by the Royal Commissioners on Accidents in Mines, and I shall therefore quote their own words on the subject:—

"In emphasising this claim (*Proc. Roy. Soc.*, vol. xxxvii. p. 43), Mr. Galloway does not appear to have realised the fact that, if dust were the principal agent in coal-mine explosions, every blown-out shot occurring in a very dusty and dry mine should actually be attended by a more or less disastrous explosion or conflagration, and that, looking therefore to the enormous amount of powder expended in shot-firing in this and other countries, and to the not inconsiderable proportion which blown-out shots must constitute, in many localities, of the total number of shots fired, disastrous coal-mine explosions should be of more than daily occurrence, if his view were correct."

I submit that the conclusion here stated is not deducible from the premiss; and in support of this position I adduce the fact that coal-dust is admitted to have been the principal agent in two of the most disastrous explosions of the present year, namely, those of Mardy and Altofts collieries, in both of which shots were fired. Altofts Colliery alone is sufficient to prove the case against the Commissioners, for it has been in operation for twenty-one years, and shot-firing has been carried on in it during the whole of that period. If, then, blown-out shots constitute a "not inconsiderable proportion" of the whole, there is a probability amounting to a certainty that such shots must have been fired in Altofts Colliery many times without the results here postulated having been attained until now. The argument as made use of against my own views appears therefore not to be in accordance with ascertained facts.

It may be safely maintained, therefore, that every blown-out shot does not fulfil the whole of the conditions necessary for creating an explosion. For instance, the dust may not be present in sufficient abundance within reach of the flame; it may not be fine enough to ignite at the point where the shot explodes; it may contain too much foreign matter, or be covered with coarse rubbish, or be locally damp; the shot may be too high, or too low, or pointed in an unfavourable direction; the direction and velocity of the passing air-current may exercise some influence on the result; the creation of a nucleus of explosion may in certain cases be facilitated by the previous formation of a cloud of coal-dust to windward, raised by another

shot (as imagined by the late Prof. Marreco and Mr. D. P. Morrison), or by a fall of roof, a train of mine waggons that has just passed, or any other accidental circumstance, and subsequently carried past the mouth of the shot-hole at the instant the flame issues from it."

Immediately after the passage quoted above the Commissioners proceed to say:—

"The following facts relating to the part played by dust in coal-mine explosions may, however, now be regarded as conclusively established:—

"1. The occurrence of a blown-out shot in working-places where very highly inflammable coal-dust exists in great abundance, may, even in the total absence of fire-damp, possibly give rise to violent explosions, or may at any rate be followed by the propagation of flame through very considerable areas, and even by the communication of flame to distant parts of the workings where explosive gas-mixtures, or dust-deposits in association with non-explosive gas-mixtures, exist."

"2. The occurrence of a blown-out shot in localities where only small proportions of fire-damp exist in the air in the presence of even comparatively slightly inflammable or actually non-inflammable, but very fine, dry, and porous dusts may give rise to explosions the flame from which may reach to distant localities, where either gas accumulations or deposits of inflammable coal-dust may be inflamed, and may extend the disastrous results to other regions."

This has the appearance of conceding all that is asked, but when read in the light of the first quotation it leaves the matter in considerable doubt. Indeed, it was stated at the inquest on Altofts explosion that the proprietors of that colliery had not gathered from the Commissioners' Report that they were running any risk of an explosion, such as the one that happened; and at the inquest on Elemore explosion, which has been adjourned until the 18th inst., Mr. Lishman, the manager, gave utterance to similar sentiments. Be this as it may, it is obvious that legislative measures ought to be adopted without further delay, with the object of rendering the recurrence of coal-dust explosions impossible for the future. In providing against them it must also be recollected that a local explosion of fire-damp, such as the one which originated Mardy explosion, produces exactly the same result as a blown-out shot fired under the most favourable conditions imaginable.

Cardiff, January 5

W. GALLOWAY

The Cambridge Cholera Fungus

In your issue of December 23 (p. 171) appears a letter from Dr. E. Klein, in which that gentleman attempts to show that the micro-organisms found by Dr. Graham Brown, Mr. Sherrington, and myself in the substance of the mucous membrane of the small intestine in cases of *Cholera asiatica* are nothing more than "common mould (probably aspergillus)," which has grown on and into the tissue during the process of hardening. We were and are, however, perfectly well acquainted with the fact that imperfectly preserved animal tissues are liable to be invaded by various forms of fungi, and took, therefore, precautions which we believe to be ample to prevent such contamination of our material. Moreover, the presence of the micro-organisms in certain parts of the tissues only, their absence in others or on the surface of the specimens, the fact that their presence in the part is accompanied by anatomical changes which could not have taken place during the process of hardening, and, most of all, the characters of the micro-organisms themselves, render such an hypothesis as that brought forward by Dr. Klein absolutely unacceptable.

It is unnecessary for me to answer all the arguments advanced by Dr. Klein in support of his views on this subject. They prove nothing more than that fungi grow on and in animal tissues which are not adequately preserved—a fact which no one will doubt. That, on the other hand, the micro-organisms found by us are of this nature is a matter which neither Dr. Klein nor any other person who is unacquainted with the facts is in a position to decide. Since a short preliminary account only of the work done by Dr. Graham Brown, Mr. Sherrington, and myself, on the pathology of cholera has as yet been published, Dr. Klein has not before him the facts on which alone a decision of any value is possible.

CHARLES ROY
Pathological Laboratory, New Museums, Cambridge
December 30, 1886

An Error in Maxwell's "Electricity and Magnetism"

THE criticism of Mr. McConnell upon Maxwell's derivation of the inductive action of currents from the principle of energy is perfectly correct. It is inconsistent with the experimental facts appealed to by Mr. McConnell and Mr. Maxwell's own treatment of the field as the seat of electro-kinetic energy.

In the excellent treatise of Messrs. Mascart and Joubert, a similar misleading appeal is made to Helmholtz's proof, and I have little doubt that Maxwell has correctly stated it. I should be inclined to think that the existence of the energy of the field was not distinctly present to Helmholtz's mind.

Maxwell, as is well known, by an ingenious application of Lagrange's equations of motion, proves that, in the case of two currents, this electro-kinetic energy T_e is given by the equation—

$$T_e = \frac{1}{2}(L_1 i_1^2 + M i_1 i_2 + L_2 i_2^2),$$

where $M = \int \int \frac{\cos \epsilon}{r} ds ds'$ taken round both circuits, and L_1 and L_2 are similar expressions for the separate circuits.

I believe, though I dare not trespass upon your space to give the reasoning *in extenso*, that this result may be obtained somewhat more simply and without the use of the Lagrangean equations, a treatment which has the disadvantage of assuming the electric co-ordinates y_1 and y_2 , the currents being i_1 and i_2 . Then the equation of energy becomes

$$A_1 i_1 + A_2 i_2 = \frac{dT_e}{dt} + \frac{dT_m}{dt} + R_1 i_1^2 + R_2 i_2^2,$$

where T_m is material kinetic energy, and $\frac{dT_m}{dt} = i_1 i_2 \frac{dM}{dt}$

supposing the circuits rigid. Therefore

$$A_1 i_1 + A_2 i_2 = i_1 \left\{ \frac{d}{dt}(-L_1 i_1 + M i_2) + R_1 i_1 \right\} + i_2 \left\{ \frac{d}{dt}(-L_2 i_2 + M i_1) + R_2 i_2 \right\},$$

reducing to Mr. McConnell's equation, when the currents are constant.

In the case of two circuits thus moving in connection with their batteries we may infer that A_1 and A_2 must be such functions of i_1 and i_2 , and the coefficients of configuration, that, when the suffixes are interchanged in the expression for A_1 , that for A_2 must result, and *vice versa*. If this be so, then the aforesaid equation necessitates the separate equations—

$$A_1 = -\frac{d}{dt}(L_1 i_1 + M i_2) + R_1 i_1;$$

$$A_2 = -\frac{d}{dt}(L_2 i_2 + M i_1) + R_2 i_2.$$

Or Maxwell's equations are obtained without the use of Lagrange.

Berkeswell Rectory, near Coventry

HENRY W. WATSON

The Manipulation of Glass containing Lead

IN a note on this subject in NATURE (Dec. 16, p. 150), Mr. H. G. Madan has made a suggestion which is likely to be very valuable to those who require to manipulate "combustion-tubing" before the blow-pipe. But, in proposing the employment of oxygen in place of air to produce flames for heating glass containing lead, Mr. Madan introduces a refinement which is unnecessary; for lead-glass may be quite as easily manipulated in flames produced by plain air and gas as soda-glass itself. The pointed flame should be employed for small objects, and the oxidising brush-flame in the case of larger objects. By the oxidising brush-flame, however, I do not mean the brush-flame as ordinarily employed, but one to which the air is supplied liberally through an air-tube without any contraction at its end, and at a steady pressure from a good blower; care being taken, on the other hand, not to introduce such an excess of air as to reduce the temperature of the flame.

In his note, Mr. Madan quotes me as saying, in the "Methods of Glass-blowing," that the reduction of lead-glass may be prevented or remedied by holding the glass a little in front of the visible flame, with the comment that there is hardly enough heat in that position to do so.

of the glass. I hope he will excuse me if I point out that in this he hardly does me justice; for, although words in the above sense are to be found on p. 18, they occur only towards the end of the preliminary treatment of the subject, attention is at once called to the objections to the method, and they are followed by a full account (with references to diagrams) of the method of adjusting the supplies of air and gas so as to produce flames *within which* lead-glass may be sufficiently heated without reduction.

I have ventured to trespass on your space to this extent, because, for various reasons, I have come to the conclusion that lead-glass is distinctly the best glass for beginners to work with, and therefore I am anxious to correct the widespread and mistaken idea that its manipulation is very difficult, and requires special appliances.

W. A. SHENSTONE

Clifton, December 28

Pyrometers and Fusion-Points.

I READ with much interest the letter from Naples of Dr. H. J. Johnston-Lavis, and beg to offer a few suggestions in answer to his inquiries. I have done much work with pyrometers, and for my purposes have used Siemens's water pyrometer with satisfaction.

It occurs to me, however, that the pyrometer most suitable for the volcanic lava investigations proposed by Dr. Johnston-Lavis would be either Siemens's electrical pyrometer, or the one recently introduced by Messrs. Murries and Co., 45, West Nile Street, Glasgow. It would seem that, with the latter, observations can be readily taken at a considerable distance from the pyrometer, so that the pyrometer stem might possibly be lowered into the crater, and readings of the internal temperatures taken at various depths, and possibly of the contained lava also.

With regard to the fusing points of various substances, reference may be made to the recent careful researches on this subject of Dr. Thomas Carnelley and Prof. W. C. Williams.

THOS. ANDREWS

Wortley Iron Works, near Sheffield, January 4, 1887.

Electricity and Clocks

THE exact combination about which Mr. Wilson inquires is already in existence: it can be seen at 2, Garfield Buildings, Gray's Inn Road, in the Jensen electric bell factory. The arrangement used by Mr. Jensen—and it seems to me preferable to that suggested by Mr. Gardner—is to cause the hammer of the small clock to make electric contact in the circuit of the distant large bell as it rises in preparation for striking the blow upon its own small bell. With a rubbing contact the action is perfectly certain.

SILVANUS P. THOMPSON

City and Guilds Technical College, Finsbury

Barnard's Comet

ON December 25, about 6h., with a binocular field-glass, power about 4, I noticed a third tail to this comet between the other two. It was extremely faint, but 6° long, reaching to 11 Aquilæ. The principal tail was reduced to 10° in length, and was far more conspicuous than this shorter, though much broader, tail. The shortest tail, though actually much brighter than this latter, was very indistinct with these field-glasses, being best seen with the telescope, power 20, whereas the middle tail was not distinctly visible therewith, although it showed an evident dark space immediately preceding the principal tail. With the naked eye I could see the long tail only. The head was about as bright as δ Aquilæ.

T. W. BACKHOUSE

Sunderland, December 29, 1886

Meteor

I HAVE just seen a very beautiful meteor about the size of Sirius. The local time was within a minute or two of half-past 10. It started out between Pollux and the star-cluster in Cancer, and fell rather slowly in the direction of Regulus, going out before it reached that star. It had a trail, which vanished with it. The sky had just cleared after a thunderstorm.

Sidmouth, December 28

J. M. H.

Red Sunsets and New Zealand Eruptions

NEW ZEALAND eruptions have not the projectile force to cause red sunsets. Singularly, the very same current of ideas expressed by Prof. Newcomb in NATURE, vol. xxxiv. p. 340, occurred to the writer, when in Australian waters the June previous, on the deck of the P. and O. steamer *Ballaarat*, off the Great Bight, on noticing a peculiarly red northerly sunset. The newspapers at King George's Sound were full of accounts of the magnitude of the eruption of Tarawera, and it must be the fine dust from New Zealand that has passed overhead.

The atmosphere of Australia, it may be mentioned, is one of the clearest, "exceptionally free," as Prof. Newcomb puts it, "from vapours or other attenuated matter," and in which volcanic dust would tell immediately.

This suggestion disappeared at once on getting to the actual site of the New Zealand eruption, only six weeks after it had occurred, and on seeing the limited area covered with mud—a mere nothing compared with the vast stretch of country in the North Island passed through. As there was not a trace of its effects till within eight miles of the foot of Tarawera, it was simply ridiculous to suppose that any of the dust had invaded the higher atmosphere.

Besides this, the boundary of the cloud of atmospheric disturbance was distinctly seen, and the altitude placed by none of the spectators to be above 12,000 feet.

The explosion at Tarawera appears to have been merely one of superheated steam. It was different in the case of Krakatōa, where the initial force had much more of the character of an explosion of nitroglycerine than of high-pressure steam, as the matter was stated to have been projected at least 40,000 feet into the air.

The magnitude of the New Zealand eruption could only be felt after getting well within the diameter of sixteen miles on which the mud fell, plastering hill and dale, evenly, of a dull gray, eighteen inches thick. Exterior to this it possessed none, and the distant results evidently were infinitesimal.

The writer also saw the "green sun" from the south of India, where it lasted for days, and has no doubt that this phenomenon was due to the dust from Krakatōa, such an appearance having never been even faintly approached, before or since, from ordinary natural causes, and more impressive, because unaccounted for, than a total eclipse of the sun.

India, November 26, 1886

A. T. FRASER

THEODOR VON OPPOLZER

THEODOR VON OPPOLZER, one of the most eminent of modern astronomers, died at Vienna on December 26, 1886. He was the only son of Johannes von Oppolzer, the famous pathologist of Vienna, and was born on October 26, 1841. In accordance with the wish of his father, he studied medicine, and took his doctor's degree in 1863. From early youth he had shown great interest in astronomy, and, soon after taking his degree, he caused an observatory to be built at his own expense, and resolved to devote himself wholly to his favourite science. In 1866 he began to lecture at the University of Vienna, on theoretical astronomy, and he was soon promoted to the position of full Professor in his department. In 1870 he was asked by his Government to take charge of the operations for determining the length of a degree in Austria, and to this task he applied himself with so much energy that all the necessary observations were by and by completed, although his results have not yet been published.

Oppolzer distinguished himself in all departments of astronomical science. One of the most important of his writings was his "Lehrbuch zur Bahnbestimmung Kometen und Planeten," a work which has already become classical. He had hoped to place the theory of the moon on a new basis, but his labours in connection with this subject were not finished at the time of his death. On his death-bed he corrected the last proof-sheets of his "Canon der Finsternisse," in which he calculates the eclipses of the sun and moon which have taken place, or which have yet to take place, between the years B.C. 1500 and A.D. 2000.

His services to science were recognised by all the great learned Societies, and he was a Foreign Member of the Royal Astronomical Society of London. He was a man of a singularly noble personal character, and his death is deeply regretted by a wide circle of friends.

THE COLONIAL AND INDIAN EXHIBITION

CANADA.—This section of the Exhibition will be remembered chiefly for its agricultural machinery in motion, its fur, and agricultural trophies, and its large collection of furniture. The collection of fruits in the agricultural trophy has probably never before been equalled either in number, variety, or perfection of preservation, the colours of the several fruits being extremely well preserved in various solutions, such as dilute sulphurous acid for the lighter coloured fruits or salicylic acid for the darker ones. Besides these, however, there were numerous exhibits which, though less imposing to the general visitor, were of considerable interest, such, for instance, as the collection of timbers, and manufactures therefrom, photographs of American timber-trees, &c. The enormous sizes of many of the American Coniferæ were well illustrated by magnificent planks of such woods as the Douglas fir (*Pseudotsuga Douglasii*), some sixteen feet high and about ten feet in diameter, large slabs of hemlock spruce (*Tsuga canadensis*), also enormous logs of black walnut (*Juglans nigra*), and many others. Perhaps the most compact and interesting collection of timbers, however, was that from New Brunswick, where the woods were arranged so as to form a kind of design, the lower or basal portion being formed of trunks of trees, with their burks remaining, about three feet high, over this were arranged sections of the wood in frames composed of the young branches with the bark on; and above these, again, panels of the same wood as shown below, cut longitudinally and with a cross section at the base, both polished to show the grain or figure, and on the panel of each wood was painted a very good representation of a spray or branch of the plant itself. Each specimen was properly named, so that the whole thing was very complete. The series of photographs before alluded to are correct representations of the tree flora, each photograph being framed with the wood of the tree illustrated. The general use of the bark and wood of the cedar of British Columbia (*Thuja gigantea*), for useful and ornamental articles, was well shown in the exhibits of mats, native head-dresses, masks cut from the solid wood and grotesquely painted, spoons, whistles.

Fiji.—Though the space occupied by these islands was but small, the exhibits were of an interesting character, including a fine set of native timbers, for the most part scientifically named, and including some large blocks of Fijian sandalwood (*Santalum yasi*), roots of the kava (*Piper methysticum*), which is generally used in the Society and South Sea Islands in the preparation of an intoxicating beverage by chewing the root, ejecting the saliva into large bowls, and then fermenting it; or by pounding the root between two stones, then putting it into a bowl, pouring water upon it, kneading it, and afterwards straining it. The taste is said to be like that of soap-suds, but a liking for it is easily acquired, and it is said to quench the thirst better than any other beverage. A spirit prepared from it in Germany was sold in the Exhibition under the name of yagona or kava schnaps. This spirit, which is something of the nature of a liqueur, is described as having medicinal properties, and is recommended for its remarkable soothing and stimulant effects, restoring faded energies and exhausted nerve-power. Cocoa-nut fibre and oil of course form large staples of produce in Fiji, and were fully represented in the Exhibition, as well as dilo nuts and oil (*Calophyllum inophyllum*). Some excellent samples of sugar, grown and manufactured in

the islands, and tea, also grown and prepared in Fiji, as well as many other products, were shown in quantity. Great credit is due to the Executive Commissioner, the Hon. J. E. Mason, for making the resources of his colony known by the distribution of small samples, during the period the Exhibition was open, to any one having a real interest in their development.

Victoria.—Besides the splendid collection of water-colour drawings of Australian plants exhibited on the north side of the Court, the fine series of Victorian woods, the golden arch, and the native encampments, all of which attracted a considerable amount of attention, the products of the genus *Eucalyptus* in the shape of oils and resins, exhibited by Mr. Joseph Bosisto, M.P., and President of the Commission, were amongst the most interesting and important. Samples of the oil of *Eucalyptus amygdalina*, rectified and non-rectified, were shown. This is the best quality of eucalyptus oil, and the oil for the preparation of which Mr. Bosisto's firm has become noted. A sample of the essential oil of eucalyptus of commerce was also shown, and described as being obtained from the allied varieties of *E. amygdalina*, but not from the true species. So many varieties of this species are known that it is difficult for bushmen who collect the leaves to distinguish those of the true species from its congeners, forming, as they often do, a compact jungle or bush growing in close proximity to each other. The oil is rubefacient, antiseptic, disinfectant, and a deodorant of great power. The essential oil of *Eucalyptus globulus*, the blue gum-tree of Victoria, having tonic, stimulant, and antiseptic properties, as well as those of *E. oleosa*, *E. dumosa*, *E. citriodora*, *E. goniocalyx*, *E. obliqua*, &c., were also shown. A sample of eucalyptol from *E. amygdalina* and *E. globulus* is described in the Catalogue as "a homologue of camphor, and appears to be two steps higher in the series. Its vapour, mixed with air, is agreeable when inhaled, and is employed as a therapeutic agent in bronchial and diphtheritic affections." Amongst resins were those of the red gum of Victoria (*E. rostrata*), described as a thoroughly soluble and delicate mucilaginous astringent, and *E. resinifera*, Australian kino. Fine samples of the resin of the Australian grass-tree (*Xanthorrhoea hastilis*) were also shown. This is obtainable in large quantities; it is of a deep amber colour, soluble in spirit, and is used for staining wood to imitate cedar and oak, and is also used in this country in French polish to deepen the colour of light mahogany and other woods.

New South Wales.—Minerals, wools, timber, and furniture made of the timber, were the principal objects exhibited. None of the woods called for any special remark except, perhaps, a small collection either known or considered to be adapted for wood-engraving, and these specimens were of little or no value in themselves, being badly selected, and in many cases much split or cracked. The collection was more valuable as giving a clue to the source of the woods considered suitable for engraving purposes than for any qualities of their own. Among the woods so exhibited were *Bachousia myrtifolia*, *Hymenosporum flavum*, *Xanthoxylum brachyanthum*, *Acacia Cunninghami*, *Duboisia myoporoides*, *Dysoxylon Fraserianum*, *Gmelina Leichhardtii*, *Hemicyclia australasica*, *Weinmannia rubifolia*, *Eugenia myrtifolia*, *Pentaceras australis*, and others. Amongst fibres and fibrous barks was the bark of the small-leaved nettle-tree (*Laportea photiniphylla*), also a fishing-net, cordage, and a dilly bag made from the fibre by the aborigines of the northern coast districts. The collection from New Guinea exhibited in this Court was of considerable interest. The utilisation of the bony seed shells of *Pangium edule* for decorating the skin drums is one not seen by us before. The seeds produce a rattling sound when shaken similar to those of *Thevetia nerifolia*, which are used for like purposes in British Guiana.

South Australia.—The centre of attraction here was undoubtedly the scene on the Murray River wherein the habits of the aborigines were depicted. Wool figured largely, and the applications of emus' eggs for a great variety of purposes were fully illustrated. A good collection of small specimens of the woods of the colony was shown, as well as a collection of fruits and seeds.

Western Australia.—A fine collection of the timbers of the colony was exhibited in this Court, and outside near the basin adjoining. The principal woods shown were jarrah (*Eucalyptus marginata*), and karri (*E. diversicolor*). Of the former, one of the principal attractions in the Court was a log, some seven feet long, over four feet in diameter, and weighing nearly five tons, carefully polished on one end to show the cross section, and in the middle to show the longitudinal structure. The wood has a very fine deep red colour, and "for the durability of its timber," Baron Mueller says, "is unsurpassed by any kind of tree in any portion of the globe." When carefully selected and dried, it is proof against the attack of teredo, termites, or any other wood-borers. It is consequently in great demand for jetties, piles, railway-sleepers, fence posts, and all kinds of underground work, as well as for planking and frames of ships. This fine block of wood, and a fine slab or counter-top of figured jarrah and other West Australian woods, have been presented to the Museum of the Royal Gardens, Kew. Amongst the plants exhibited as being used for tea by the natives were the following:—The leaves and flowers of *Verticordia pennigera*, known, it is stated, to the settlers in the earlier days of the colony, and used medicinally. The taste is said to be similar to Chinese tea. Another kind of native tea proved upon examination to be furnished by *Kunzea Muelleri*.

Queensland.—Of vegetable products exhibited from this colony the collection of woods was the most noteworthy, not only for the number of species, but for the care shown in their selection and preparation. The two enormous trunks of cedar (*Cedrela Toona*), each some fifteen feet high, and one with a girth of twenty feet five inches, will as long be remembered for their majestic size by those interested in tree growth as the number and brilliancy of the opals will be remembered by those interested in gems.

New Zealand.—Next to the collection of birds and minerals, the timbers of New Zealand held a prominent place, and the furniture made from the most important and beautiful woods, such as mottled kauri (*Dummaru australis*), and totara (*Podocarpus totara*) was well illustrated. The beauty of these woods is so great that it is remarkable they should still remain comparatively unknown amongst cabinet-makers in this country.

Cape of Good Hope.—The centre of attraction in this Court was undoubtedly the diamonds and diamond-polishing. Of the vegetable products a collection of native medicinal plants was shown, and their uses were well described in the catalogue of Cape exhibits, and for the most part are to be found also in Pappel's *Flora Capensis Medica Prodrromus*. There was also a very fine collection of well-seasoned and polished wood slabs, amongst them being Outeniqua yellow-wood (*Podocarpus elongatus*), an extremely valuable, fine-grained wood of a light yellow colour, useful for furniture, planks, flooring-boards, beams, &c. One slab of this fine wood—which was almost entirely hidden during the Exhibition by a counter being built over it, and measures about twenty feet long by five feet in diameter—has been presented to the Kew Museum, together with a fine set of other Cape woods, many of which might become useful in this country were they better known, notably the stinkwood or laurel wood (*Oreodaphne bullata*), a dark-coloured wood much resembling walnut in appearance, but heavier and considerably stronger, so that it has been recommended quite recently for gun-stocks. In the colony it

is very highly prized for nearly every kind of work connected with building and cabinet-making, being little inferior if not equal to teak in strength and durability.

Natal.—Raw vegetable products largely predominated in this Court. Sugar, maize, tea, and tobacco were the principal staples. The cultivation and manufacture of tea is a new industry for Natal, and the result is that an article of very good quality has been produced, Natal tea having been on sale during the period of the Exhibition and well spoken of, so that there seems every probability of a future trade in this article with Natal. Amongst tanning materials we noticed the root, both entire and broken, of the Elands Bontjis (*Elephantorrhiza Burchellii*), which has attracted some attention of late as a valuable tanning material. Preserved native fruits, such as granadilla (*Passiflora maliformis*), papaw (*Carica Papaya*), amatungulu (*Carissa grandiflora*), and others, were exhibited, as well as a variety of hard woods, many of which were without scientific names.

West African Settlements.—Under this head was included the Gold Coast, Lagos, Gambia, and Sierra Leone. The exhibits consisted largely of raw products of both the vegetable and animal kingdoms, together with some native manufactures, such as textiles from indigenous palm fibre or grasses, carvings in wood, &c. Oil seeds were shown in variety as well as in bulk, and notable amongst them were the kernels of *Elais guineensis*, malukeh seeds (*Polygala rarifolia*), which only occasionally finds its way to this country, physic nuts (*Jatropha Curcas*), benniseed (*Sesamum indicum*), and others as well known. Some very large balls of rubber were exhibited from Sierra Leone, and some fine masses of a kind of gum copal from the Gold Coast.

Ceylon.—Vegetable products abounded in this Court. On the walls were exhibited no less than 362 specimens of native vegetable drugs, got together by the Director of the Royal Botanic Gardens, Peradeniya. A very fine series of planks of the principal useful or ornamental timbers were exhibited, amongst them being tamarind, satinwood, ebony, calamander, and nedun (*Pericopsis mooniana*). The most attractive of the Ceylon woods is certainly calamander, but this is said to be now extremely scarce, and as it is of slow growth, the supply is very limited. Satinwood trees are common "in the northern, eastern, and north-western forests, but the proportion of these which yield 'flowered satinwood' is very small, and this description of wood is therefore comparatively high in price." Notwithstanding this scarcity of "flowered satinwood," several of the show-cases which contained the exhibits of tea, cardamoms, &c., and some of the barrels containing coffee, were of flowered satinwood. The Ceylon collection on the whole was one of particular interest.

India.—The extent of space occupied by our Indian Empire, and the varied and interesting character of the exhibits, will long be remembered. The contents of the art courts do not come within our notice, but there was sufficient material in the Economic Court for an extended notice. Space, however, will not allow us to say more than a few words on the unrivalled collection of the raw products of India—such a collection, indeed, as in all probability was never brought together at one time before. In such a collection it would be impossible to individualise any of the exhibits—those most striking, such as the bamboo bridge, will remain fresh in the memory—but it is in such details as the individual contents of the several shops that the interest of the economic botanist lies. To obtain any idea of the contents and value of the Indian Economic Court, we must refer our readers to the recently-issued "Special Catalogue of Exhibits," a large portion of which has been compiled by Dr. Watt, who had charge of the Economic Court during the Exhibition. This catalogue is a valuable and interesting record of one of the most important sections of the whole Exhibition.

We cannot close these notes without saying a word in commendation of the excellence of most of the catalogues, especially those of Ceylon and the Cape of Good Hope.

JOHN R. JACKSON

Museum, Royal Gardens, Kew

IPECACUANHA CULTIVATION IN INDIA

THE following note is from a letter which I have received from Mr. Gammie, who has charge of the cinchona plantations of the Bengal Government at Darjeeling. The facts are of considerable biological interest, as showing that amongst closely connected forms, which can scarcely be distinguished by palpable morphological differences, there may yet be unobvious constitutional distinctions which in the struggle for existence may determine the survival and ultimate dominance of some one form in particular.

The facts are also perhaps interesting in another way. To any one who will be at the pains to turn up vol. vii. of NATURE, p. 6, it will be amusing to see the sequel which the chance of circumstance has brought to one branch of a long-burnt-out controversy.

W. T. THISELTON DYER

Royal Gardens, Kew, December 13

"I don't think I ever told you the final results from our ipecacuanha-growing experiments, but do so now.

"Our original stock of plants came from Kew and Edinburgh—the great majority from Edinburgh. The few plants from Kew differed a good deal in appearance from the Edinburgh lot, which, again, differed greatly from each other. All the Kew plants were of one sort, which we named, from the start, the Kew variety. It was rougher in the leaf than the Edinburgh sorts, and not so strong-growing while under glass.

"After we had satisfied ourselves that we could make nothing of ipecacuanha, from a commercial point of view, we put all the plants out in the open, under shade, and let them take their chance. By this time we had all the sorts mixed up together; and as we had originally at least ten Edinburgh plants for each one of the Kew sort, and the Edinburgh lot had, besides, been much the stronger growers under glass, the Kew plants formed less than 5 per cent. of the whole. But very soon the Edinburgh sorts began to disappear, until, in the course of a year or two, there was not a single plant of one of the Edinburgh varieties alive, whilst almost every plant of the Kew variety lived. Of it, at the present moment, we have a good stock, and in one place, at 1400 feet elevation, under the shade of living trees, we have plants, which were put out many years ago, in the most perfect health, but unfortunately their growth has been so slow as to render the prospect of any profitable return from them almost hopeless. Still it strikes me that, in places geographically better situated for ipecacuanha-growing than Sikkim, this particular variety may succeed, although other sorts may have failed. Probably our ipecacuanha experiments may prove another instance of the folly of giving up the cultivation of new crops as hopeless until the most exhaustive experiments have been carried out. It may be that there are even hardier varieties of ipecacuanha than the 'Kew variety' to be found."

SUNSPOT OBSERVATIONS IN HUNGARY¹

THE Observatory, of which the first volume of Publications is now before us, was founded by Cardinal Haynald in 1878 in connection with the archiepiscopal gymnasium at Kalocsa in Hungary. Preliminary geodetic operations, of special importance as supplying an inde-

pendently determined point of reference for the Hungarian survey, with the examination and adaptation of instruments, cost much time and labour; so that only a fragmentary part of the energy of the establishment has hitherto been available for purely astronomical work. The Director, however, Dr. C. Braun, has wisely embraced the rule of concentration which governs most successful campaigns, and is hence enabled to present, in lieu of a multitude of scattered and perhaps useless observations, the connected results of four years' solar study, unpretending in aim, but thoroughly well executed, and developed with much clearness and not a little originality. The time, it is true, has somewhat gone by for visual solar work of the kind here described; and Dr. Braun, like all other astronomers, is getting ready his camera. Still, it is well worth while to consider what has been learned—even at a somewhat disproportionate cost of labour—by graphical delineation pursued through fifty consecutive solar rotations.

The instrument employed was the smaller of two excellent Merz refractors possessed by the Kalocsa Observatory. It is of four Paris inches aperture, is equatorially mounted, and appears to possess uncommonly fine definition. To its eye-end was fitted an apparatus invented and constructed by Dr. Braun himself, by means of which an image of the sun 22 centimetres in diameter was projected, after total reflection from a right-angled prism, upon a sheet of drawing-paper. In this way nearly 5000 drawings of spots were executed during the years 1880 to 1884. For their reduction two expeditious methods—one graphical, the other computative—were devised; and the resulting heliographical latitudes are rendered strictly comparable with those derived by English observers, through the application of a small correction due to a difference in the adopted elements of the solar rotation. Now that sunspot observations have become cosmopolitan, it seems indeed a pity that there should not be unanimity on this point among astronomers. Dr. Braun conforms, however, to the solar prime-meridian chosen at Greenwich, so that the longitudes given in his maps practically coincide with Greenwich longitudes.

The highest grade of accuracy was not aimed at in these observations. Their object was the collection of materials for studying the processes of spot-formation and the relation of spots to prominences, with side-glances towards a possible, but every year less and less probable, transit of "Vulcan." The determination of the solar rotational elements, or of the minute changes of latitude of spots, was left to observers provided with the means of executing refined micrometrical measurements. Nor was the estimation of maculated area attempted. Yet with all these limitations, much of interest remains to be gathered from the paper before us.

The results are portrayed in fifty maps, each representing the aspect of the sun's surface between the parallels of 40° north and south, during one synodical rotation. The indication of the solar meridians which on successive days were central at mean mid-day (Kalocsa time) renders it easy to trace the fluctuating appearance of the actual visible disk throughout each period. The maps further contain two long sinusoid curves—one denoting the heliographical latitude of that point on each meridian of which the position-angle on the east limb was 90°, the other showing the latitude of the points similarly situated on the west limb. Hence the position-angle of any given spot as it traversed either edge of the sun can at once be deduced—a datum obviously much facilitating inquiries into the connection of spots with prominences.

To each map corresponds a table, in which, besides the heliographical position of each spot, something of its history and peculiarities is set forth—the number of times it was observed, the epochs of its appearance and disappearance, with a general description of its size and shape. Especial interest attaches to a table in which Dr. Braun

¹ "Berichte von dem Erzbischoflich-Haynaldschen Observatorium zu Kalocsa in Ungarn." Von Carl Braun, S. J. (Münster i. W.: Aschendorff, 1886.)

has separately collected particulars of sixty-one spots, held, with more or less of probability, to have presented themselves afresh after making the circuit of the sun, and hence to be available as guides to the period and law of its rotation. From these data he constructed a curve (Plate XVI. Fig. 2) showing the variations in the rate of spot-displacement with varying latitude, the perfect symmetry of which on either side of the sun's equator testifies to the absence of any systematic difference in this respect between the hemispheres. From the curve were derived three distinct formulæ of the solar rotation, all fitting perfectly with the observations within the parallels of 30° , but diverging widely in their results for high latitudes. For example, No. I. gives for the region close to either pole a period of just 33 days; No. III. of a little over 40; No. II. of 55.8 days. From Carrington's formula, Dr. Braun deduces a polar period of 30.86 days; Faye's implies one of 32; Spörer's actually reverses the direction of change beyond the spot-zones, indicating a recovery of velocity towards the far north and south, and a period, in latitude 90° , of no more than 25.1 days—about the same which prevails in parallels of 10° . It may be worth remarking, as at least a coincidence, that almost precisely this rate of motion was inferred by Father Secchi (very doubtfully, it is true) from observations of relatively stable prominences near the pole. Nevertheless, a survey of the discrepancies tabulated by our author can hardly fail to inspire a profound distrust of empirical formulæ, and still more of the risky process termed "extrapolation."

The swiftest-moving spot noted by the Kalocsa observers was situated $1^\circ 20'$ north of the equator; its estimated daily displacement of 868' bringing about the completion of its circuit in 24.88 days. The most sluggish was in south latitude $29^\circ 38'$, and gave a period of 26.5 days. As might have been expected, considerable irregularities are apparent; yet not more than might reasonably be set down to uncertainties of observation. A much higher degree of accuracy must, however, be reached before the mean rate of motion proper to each parallel can be at all satisfactorily ascertained. This mean rate is itself, in Spörer's view, subject to cyclical change; and his observations during the years 1861-1871, as compared with Carrington's during seven preceding years, disclosed persistent differences not easily accounted for. Dr. Braun's results, on the other hand, agree quite as well as could be expected with those of the English observer. A further complication is introduced by what may be called the individual caprices of spots. Each spot has probably a velocity of transport peculiar to itself, depending upon the circumstances of its origin; this velocity is certainly subject to accelerations connected with the processes of its development. These accelerations (for the change of motion is always in a *forward* direction) are shown, in Prof. Spörer's recent communication to the Physical Society of Berlin, to be very considerable; they are beyond question highly significant; yet they emphasise our disadvantage in being compelled to rely upon such unstable phenomena for all our knowledge regarding that most important datum—the rate of the sun's revolution on its axis.

The Kalocsa solar observations were made at a critical period. They cover the whole of the prolonged maximum which culminated near the close of 1883, and disclose or confirm very satisfactorily some of its characteristics. Dr. Braun has depicted in a remarkable curve the progressive changes in the mean latitude of the spot-zones during the years 1880-84. Their continuous approach to the equator at once strikes the eye; but superposed upon the line of uniform descent is a series of minor oscillations with a period of about a year, and an amplitude of fully 2° , which seem too regular and strongly-marked to be the mere effect of accident. This feature is quite novel and deserves attention.

The general rule that the long series of spots comprised

within each cycle break out first in high latitudes, and become extinct close to the equator, was first observed Carrington, and may now be regarded as fully established. Ordinarily, the maximum occurs when the mean latitude of the zones is 16° or 18° , the energy of the disturbance diminishing as they close further in. But the retarded character of the recent crisis was significantly attested by the fact that it did not reach its height until the closing in had proceeded much further than usual. In 1882, when the maximum was due, the average latitude of spots was (from Dr. Braun's curve) about 16° ; whereas, at the close of 1883, when the maximum actually occurred, it was no more than 11° . It would seem as if the punctuated and duly prepared completion of the outburst had been frustrated, and its stored-up energy spent upon abnormal protraction of the maximum.

It might even be said that the perturbation thus indicated affected chiefly, or solely, the southern hemisphere of the sun. Although the respective sum-totals of spots observed at Kalocsa north and south of the equator eventually almost exactly balanced each other, large temporary discrepancies were manifest. The northern hemisphere displayed in 1880 an excess of activity, still more conspicuous in the ensuing year. Southern spots, on the contrary, outnumbered northern in 1882 to the extent 8 per cent., and in 1883 in the proportion of nine to five. Dr. Braun adds the remark that each hemisphere would almost seem to have completed its cycle of change independently of the other, the northern maximum having occurred late in 1881, while the southern was postponed for two further years. The cause of perturbation should, in this view, be localised in the southern hemisphere.

A. M. CLERKE

NOTES

ON November 10 last, an important meeting of intercolonial delegates was held at the rooms of the Royal Society, Sydney, for the purpose of forming an Australasian Association for the Advancement of Science. There were delegates from all the principal scientific Societies of Australia, and they seem to have had no difficulty in arriving at a decision on the questions they had met to discuss. On the motion of the chairman, Mr. Russell, it was agreed that an association of the scientific Societies of Australasia should be formed under the name of "The Australasian Association for the Advancement of Science." It was also resolved that the rules of the British Association should be adopted, and that the first meeting of the Australasian Association should be held in Sydney in the first week of September 1888. This date was fixed because it will be the hundredth anniversary of the foundation of the colony of New South Wales.

MR. H. N. RIDLEY, of the British Museum, intends to make an expedition to the island of Fernando Noronha for the purpose of investigating its natural history. The funds for the expedition have been supplied by the Royal Society, and Mr. Ridley hopes to be able to start at the end of February. The marine flora and fauna were collected by the *Challenger* Expedition, but owing to the fact that the island is a Brazilian penal settlement, no naturalists have hitherto been permitted to make collections therein. The Trustees of the British Museum have obtained from the Emperor of Brazil the necessary permission for Mr. Ridley's exploration of the island, which, from what little is known of it, and from its geographical position, promises to be of exceptional interest from a natural history point of view.

THE death is announced, at Victoria, British Columbia, of Dr. W. F. Tolmie. Dr. Tolmie's name has been favourably known to ethnologists for many years in connection with his researches respecting the Indian tribes of British Columbia and

ighbouring parts of the Pacific coast, where he has been most continuously resident since 1833. Dr. Tolmie was a native of Inverness, but in 1832 accepted an appointment as medical officer to the Hudson's Bay Company at Fort Vancouver on the Columbia River, and subsequently became a chief factor in the Company's service. Information supplied by him to George Gibbs and other ethnologists has appeared in various publications. In 1884 he published, in conjunction with Dr. G. Dawson, a nearly complete series of short vocabularies of principal languages spoken in British Columbia. He has for many years a larger work in contemplation on the traditions and folk-lore of the same tribes, but the materials for it are not complete at the time of his death.

CHARLES SHALER SMITH, the distinguished engineer, died his home in St. Louis, Mo., on December 19, 1886. He had been suffering from the effects of a fall, which resulted in serious injuries. From the first his case was considered very grave, but his great vital powers enabled him to keep up for 10 years.

MR. CLEMENT WRAGGE, late of Ben Nevis Observatory, and now of Adelaide, is to be appointed Meteorologist to the Government of Queensland.

YESTERDAY Prof. A. W. Reinold, F.R.S., delivered at John Addington (the Society of Arts), the first of the usual short series of lectures adapted for a juvenile audience. The subject was "Soap Bubbles." The second lecture will be given on January 12.

THE lectures founded by Sir Thomas Gresham will be read to the public gratuitously on the following days, at Gresham College, Basinghall Street, in the subjoined order, beginning on the evening at 6 o'clock:—Rhetoric (Mr. J. E. Nixon), January 18, 19, 20, and 21; law (Dr. Abdy), January 25, 26, 27, and 28; geometry (Dean Cowie), February 1, 2, 3, and 4; music (Dr. Symes-Thompson), February 8, 9, 10, and 11; natural philosophy (Dean Burgon), February 15, 16, 17, and 18; astronomy (the Rev. E. Ledger), February 21, 22, 24, and 25; and natural history (Dr. H. Wyld), March 1, 2, 3, and 4.

THE complaint is frequently heard that natural science does not get adequately encouraged in Oxford. Six weeks ago a notice was issued by Queen's College that an examination would be held on March 1, 1887, for the purpose of filling up various Scholarships and Exhibitions, including one Scholarship in mathematics and another for natural science. This notice was inserted in various newspapers, of which copies were sent to the heads of a hundred schools in England. The result is that a candidate has signified his intention of offering himself for examination in natural science. No doubt there will be at least a dozen candidates for the vacancy in mathematics, and twenty for the vacancy in classics. This certainly does not show a demand for natural science scholarships in excess of the supply.

ON December 9 the Council of the College of Surgeons met, and ordered to be entered on the minutes, a report from the Committee, recommending that the Committee's powers should be enlarged, with a view to the extension of the museum of the library, and the addition of work-rooms. It was also recommended that the Committee should receive power to take other improvements into consideration, and to inquire to what extent an increase of the staff would be rendered necessary by the proposed changes. The improvements, it is believed, would be paid for out of the Erasmus Wilson legacy. The scheme is likely to meet with some opposition, and before finally deciding a matter of so much importance the Council would do well, as the *British Medical Journal* suggests, to submit its plans to the laws.

WE regret to notice that objection is being made in Hong Kong to the expense of publishing in the official gazette the Monthly Weather Reports of the Observatory there. These tables, which have frequently been noticed in these columns, contain the usual statistics of evaporation, radiation, the relative humidity and tension of aqueous vapour, the classification of clouds, and other meteorological details. The local critics say that these are of no practical value; but they surely forget that similar tables are published by every Observatory in the world. The Tokio and Siccawei establishments, to select two which are nearest to Hong Kong, publish periodically the same meteorological statistics, and it is therefore sincerely to be hoped that Dr. Doberck will be permitted to pursue his arduous and useful labours. The colony handsomely voted a sufficient sum for an Observatory a few years ago without question, and the work which it has since done is appreciated in Europe. Only a few weeks since we printed a paper by Dr. Doberck on the typhoons of the China seas, which was essentially and directly practical, for it told the mariner of the various classes of these storms, their direction, and course, and the time at which they are most prevalent. It further explained how vessels caught in these typhoons may best minimise or escape altogether from their evil effects. All this information, the value of which for the protection of life and property, can be appreciated nowhere better than in Hong Kong, with its enormous shipping trade, is obtained only by the careful and sedulous collection and collation of statistics. The physical position of Hong Kong renders its Observatory one of considerable importance in meteorological science, and it is the duty of the colonial Government to see that the institution is not allowed to decline from the high standard which it has already attained.

THE ideas of some Americans as to the education of women seem to be very far ahead of those which still prevail in this country. At Northampton, near Amherst, an observatory is being built by the Trustees of Smith College for young women. Mr. David P. Todd, Director of the Amherst College Observatory, has lately devoted much time to the plans for the construction and equipment of this building, taking care that it shall be thoroughly fitted for the purposes of collegiate instruction, and that it shall contain ample facilities for research.

A SOCIETY for the promotion of the higher education of women has been founded in Japan, under the presidentship of the Prime Minister, and with the support of various influential foreign and Japanese gentlemen. Besides regular courses of instruction which will be provided, special courses of afternoon lectures will be delivered by the professors of the University. The whole institution will be under the control of a foreign lady principal, assisted by two or more foreign lady teachers. Although female education in Japan has already reached an advanced stage, this appears to be the first attempt to provide for the higher education of women, as understood in European countries.

THE late Mr. Greenleaf, the Boston hermit, left the whole of his fortune—probably amounting to five hundred thousand dollars—to Harvard College. The conditions imposed by him are said to be not unreasonable, but it would have been better, as *Science* urges, if he had imposed no conditions whatever. Wealthy men who think of bequeathing money to learned institutions apparently find it hard to realise that the authorities of those institutions are likely to be the most competent judges of the way in which the money should be spent. The needs of Harvard College were certainly not so well known to Mr. Greenleaf as to its President and Faculty.

THE other day *Science* commented on the fact that advertisements calling for applications for vacant Chairs in leading univer-

tional institutions are often inserted in educational and literary journals in England. This is never done in the United States. There were no fewer than forty applications for a recent vacancy in a prominent American college, and if the appointment had been advertised, the number would no doubt have been very much larger. *Science* is of opinion that American colleges lose nothing by declining to follow the English example in this matter, since in the case of every important college "the president and trustees keep their eyes continually open, and when a vacancy occurs they are pretty sure to know who is the best man for the place, or, in any event, they have made up unconsciously a short list from which the selection is to be made." A distinct advantage of the American plan is that governing bodies are not troubled with the importunities of persons who wish to be appointed to positions for which they are wholly unsuited.

THE Wagner Free Institute of Science, Philadelphia, has issued a valuable report, by Mr. Angelo Heilprin, on his explorations on the west coast of Florida and in the Okeechobee Wilderness. Mr. Heilprin is of opinion that the whole State of Florida belongs exclusively to the Tertiary and post-Tertiary periods of geological time, and consequently, as a defined geographical area, represents the youngest portion of the United States. There is not, he thinks, a particle of evidence supporting the coral theory of the growth of the peninsula. Sedimentation and deposition along this portion of the American coast appear to have been practically unbroken or continuous, as is indicated by the gradational union of the different formations, and the absence of broad or distinct lines of faunal separation. The elevation of the peninsula, especially in its more southern parts, seems to have been effected very gradually, judging from the perfect preservation of most of the later fossils, and the normal positions—*i. e.*, the positions they occupied when living—which many of the species still maintain. There is evidence that before its final elevation a large part of the peninsula was for a considerable period in the condition of a submerged flat or plain, the shallows covering which were most favourably situated for the development of a profuse animal life, and permitted of the accumulation of reef-structures and of vast oyster and scallop banks. The present submerged plain or plateau to the west of the peninsula may be taken to represent this condition. Fresh-water streams, and consequently dry land, existed in the more southern part of the peninsula during the Pliocene period, as is proved by the inter-association of marine and fluviatile mollusks in the deposits of the Caloosahatchie. Mr. Heilprin holds that the doctrine of evolution receives positive and most striking confirmation in Florida, because the modern fauna of the coast is indisputably a derivative, through successive evolutionary changes, of the pre-existing faunas of the Pliocene and Miocene periods of the same region; and the immediate ancestors of many of the living forms, but slightly differing in specific characters, can be determined among the Pliocene fossils of the Caloosahatchie. He is also convinced that man's great antiquity on the peninsula is established beyond a doubt, and he suggests that the fossilised remains found on Sarasota Bay, now wholly converted into limonite, may represent the most ancient belongings of man that have ever been discovered.

AN interesting paper on the sub-genus *Cylinder* (Montfort) of *Conus*, contributed by Mr. J. Cosmo Melvill, M.A., F.L.S., to the tenth volume of the third series of *Memoirs of the Manchester Literary and Philosophical Society*, has been reprinted. Mr. Melvill has much to say about the *Conus gloria maris*. This exquisite shell is "prominent among all its kindred for beauty of shape and excellence of pattern; and" "the reticulations are so fine as to defy the skill of the lithographer." The land of its nativity is Jacna, island of Bohol, Philippines, where the late Mr. Hugh Cuming found two examples, one very juvenile,

scarcely more than an inch in length. Mr. Cuming tried hard to find other specimens, employing all the available natives in dredging expeditions; but his efforts were unsuccessful. It is said that the original very circumscribed locality has been annihilated by an earthquake, and Mr. Melvill thinks that this is not improbable. Only twelve specimens are known to exist. Five are in this country, and one of them is in Mr. Melvill's collection at Prestwich. Another—perhaps the finest specimen known—is in the collection which belonged to the late Mrs. De Burgh, and three are in the British Museum collection at South Kensington. A good example was bought by Mr. Lovell Reeve in 1855 for the Melbourne Museum.

WE have received a "List of the Macro-Lepidoptera of East Sussex," compiled by Mr. J. H. A. Jenner, F.E.S., Lewes. It is reprinted from the Proceedings of the Eastbourne Natural History Society. East Sussex, according to Mr. Jenner, is probably one of the richest, in number of species, in the country. This he attributes to the southern latitude of the district and its varied characteristics—its downs, marshes, extensive woods and forests, and its sea-coast. Some parts of East Sussex have been well worked by entomologists, especially near the larger towns, but little is known of some of the outlying districts.

AMONG the numerous forms of fungus which live upon higher plants (many of which are so detrimental to their hosts) are some, it is now believed, which live with these on terms of mutual assistance. Frank found that the young root points of some of our forest trees, as the beech and the oak, are covered with a coating of fungus (probably belonging to the truffle or allied family), which seems to help in the nutrition of those trees. Another interesting case is that of fungi which live with orchids, and whose mode of propagation has lately been established by Herr Wahrlich (*Botanische Zeitung*). The fungus appears in the outer cells of the root tissue in the form of yellow bladder-like balls (of the nature of *haustoria* or suckers) surrounded by numerous filaments. It works no perceptible harm to the plant, but on the contrary it is thought that, especially in the case of orchids which live on the humus of woods, the fungus probably transforms the humus matters into such as are more easily utilised by the orchid, thus doing it a physiological service. The fungi observed by Herr Wahrlich belong to the family of *Tyrenomyces*, and the genus *Nectria*.

THE amount of free carbonic acid in the ground has been lately shown by Prof. Wollay (we learn from *Naturforscher*) to depend, on the one hand, on the factors of decomposition of organic substances (heat, moisture, porosity), as affected by the physical nature of the ground and its covering; on the other hand, on the resistance which the ground presents, according to its mechanical state, to the escape of the gas. Ground-air seems to have most carbonic acid when the ground is at a slope of about 20°. Slopes facing south have most carbonic acid; those facing north, least, though the difference is not great, as the two principal factors, heat and moisture, largely counteract each other. In drought, ground facing north has more carbonic acid. With equal quantities of organic matter there is more carbonic acid, the more finely granular the ground; and such ground hinders movement of the gas downwards as well as into the atmosphere. The air in ground shaded by living plants has considerably less carbonic acid than that in bare ground, and in the latter it has less (in dry years, not in wet) than in ground covered by dead parts of plants.

IN lecturing upon the "Denizens of the Aqueous Kingdom" on Friday last at the Royal Aquarium, Mr. August Carter referred to deformities that exist among fish. In 1885 and 1886 he had examined many thousands of trout and salmon fry at South Kensington on their emerging from the ova, and found

is case of deformity in every thousand, and one case of monstrosity, such as twin and dual-headed fish, in every four thousand. From observations he had made at the South Kensington Aquarium and elsewhere, the lecturer concluded that certain fish, such as the carp and perch, have the power of communicating with one another.

WHILST collecting fish ova from the River Colne for the utchery at the Delaford Fish Culture Establishment, the water-luffs found an "egg-bound" trout, that is, one that had died rough being unable to extrude its eggs. It was brought to Mr. W. Oldham Chambers, who on examination found the ova to be thoroughly healthy, although the fish, judging from its decomposed state, must have been dead about three weeks. He once obtained a milter, and succeeded in impregnating the ova, which appear to be quite healthy and capable of incubation. His spawning season has been greatly retarded by the extreme severity of the weather.

WE have received the first number of the *Cycling Budget*, the editors of which undertake to keep cyclists "thoroughly well posted in every imaginable topic which may be of service to them." There are to be careful analytical descriptions of every new or modified type of machine as it comes into the market. The *Budget* advocates the building of a club-house for cyclists in London. In America, it appears, there are magnificent club-houses for "the votaries of the pastime."

DURING the year ended October 31, 1886, the total quantity of steel and ingot iron made from phosphoric pig was 1,313,631 tons, of which 927,284 tons were ingot iron containing under 7 per cent. of carbon. As compared with the make of the previous twelve months, there was an increase of about 368,314 tons. The total quantity produced represents about 394,000 tons of slag, containing from 30 to 35 per cent. of phosphate of lime. Most of the basic slag made in Germany is finely ground, and used in place of superphosphates.

M. ALFRED MARCHE, who has already been despatched on more than one scientific mission to distant regions on behalf of the French Ministry of Public Instruction, left Marseilles on the 15th ult., on a similar errand, for the Marianne Islands.

M. THOUAR's expedition to solve the question of the navigability of the Pilcomayo, and its suitability as a trade route between Bolivia and the eastern parts of South America, has had to be postponed so far as the upper waters are concerned, owing to the refusal of the Bolivian Government at present to supply its share of the funds for the undertaking. Writing, however, from Sucre on October 22, M. Thouar reports that the Bolivians have confided to him a mission of exploration in the remote regions. He is to cross the Bolivian Chaco and survey it, with a view to discovering a land route for trade, and also to make a scientific investigation of the territory on the right bank of the Paraguay, directing especial attention to its capacity for cultivation and to the methods by which immigration should be encouraged. M. Thouar was to start on this mission about November 18.

THE *Annuaire pour l'An 1887*, issued by the Bureau des Longitudes, Paris, contains much astronomical and other scientific information, arranged in a convenient form. The work is carefully edited, and has been considerably enlarged, by M. Newy, one of the members of the Bureau.

THE current number of the *Memorie della Società degli Spettroscopisti Italiani* contains a good portrait of the late Alessandro Dorno, with a brief sketch of his career. Dorno was born at Udine on February 13, 1825. He had scarcely taken his degree at the University of Turin in 1848 when he was appointed Professor of Mechanics at the Military Academy there. In 1865 he was made Professor of Astronomy at the University of Turin

and Director of the Observatory. Many papers by him appeared in the Transactions of the Turin Academy of Sciences, and he was a frequent contributor to the various scientific journals. In 1874 he took part in the scientific expedition to India for the observation of the transit of Venus. He died at the Villa di Borgo, San Pietro, near Turin, on August 19, 1886.

WE have received Parts 16-20 of the "Länderkunde des Erdteils Europa," which is being issued at Leipzig and Prague. This admirable work is edited by Dr. A. Kirchhoff, who has secured the co-operation of many eminent geographers. There are numerous illustrations, all of which are carefully executed.

WE print to-day an abstract of an excellent paper on "The Use and Equipment of Engineering Laboratories," by Prof. A. B. W. Kennedy, M.Inst.C.E., read at the ordinary meeting of the Institution of Civil Engineers on Tuesday, December 21, 1886.

WITH regard to the postscript to his letter on "Electricity and Clocks," in our last number (December 30, 1886, p. 198), Mr. Henry Dent Gardner writes to us that it is the weak spring, not the hammer, which should be kept away from a banking.

THE additions to the Zoological Society's Gardens during the past week include two Green Lizards (*Lacerta viridis*), a Slow-worm (*Anguis fragilis*), European, presented by Mr. R. M. J. Teil; a Yellow-footed Rock-Kangaroo (*Ictrogale xanthopus*), born in the Gardens.

OUR ASTRONOMICAL COLUMN

THE ANDROMEDES, NOVEMBER 27, 1886.—P. F. Denza, writing in *Cosmos* under date December 2, gives the results of the watch maintained on the night of November 27 last at seven observatories distributed over the Italian peninsula. All the reports alike agree in showing that there was no repetition of the shower of 1885, the number of meteors observed being no greater than on an ordinary night, and of these the majority radiated from Perseus and Taurus, only very few from the radiant of the Andromedes. It follows, therefore, from these observations and those of 1873 and 1885, that the meteoric cloud giving rise to the shower is of comparatively small extent, but very dense. This fact tends to confirm the theory of the recent formation of the stream and of its origination in the disintegration of Biela's comet. The interval, thirteen years, between 1872 and 1885, corresponds to two revolutions of the comet; but the earth was in quite a different part of its orbit at the date of the intermediate return, and therefore no shower was witnessed.

THE REDUCTION OF THE POSITIONS OF CLOSE POLAR STARS FROM ONE EPOCH TO ANOTHER.—A paper containing a catalogue of 130 Polar stars for the epoch 1875.0, resulting from all the available observations made between 1860 and 1885, and reduced to the system of the Catalogue of Publication xiv. of the Astronomische Gesellschaft, has been communicated to the American Academy of Arts and Sciences by Prof. W. A. Rogers and Miss Anna Winlock. The first section of this work, giving an investigation of the methods of reducing the positions of close Polar stars from one epoch to another, has been published in the *Memoirs of the Academy*, vol. xi. part 4, No. 5. And Prof. Rogers chivalrously appends a note to the effect that his connection with the work is limited to the methods of discussion adopted, and to an examination of the numerical results obtained; and that beyond this all the work in the preparation of the paper has been done by Miss Winlock, who is entitled to all the credit therefor. By the laborious process of actual computation, taking the instance of Groombridge 1119—a star situated within 1° of the Pole, it is shown that it is impossible to obtain an exact agreement between the values of the precessional motion computed by Taylor's theorem and the corresponding values computed from the rigorous trigonometrical formulæ, in the case of such a star, when the time exceeds forty years. But it is also shown that the time at which the values derived from the development by Taylor's theorem begin to deviate from those derived from the rigorous formulæ may be extended many years by means of a secondary series, which represents the residuals

between the exact co-ordinates and those obtained with any assumed limit to the terms of the series. The application of this principle to the case of Groombridge 1119 is explained, and the formulae formed for reducing the stellar co-ordinates to any date between 1875 and 1955, and also between 1875 and 1755. The results obtained by Miss Winlock will doubtless be very useful to astronomers discussing the positions of close Polar stars.

ASTRONOMICAL PHENOMENA FOR THE WEEK 1887 JANUARY 9-15

(FOR the reckoning of time the civil day, commencing at Greenwich mean midnight, counting the hours on to 24, is here employed.)

At Greenwich on January 9

Sun rises, 8h. 6m.; souths, 12h. 7m. 20.2s.; sets, 16h. 9m.; decl. on meridian, 22° 6' S.: Sidereal Time at Sunset, 23h. 24m.

Moon (Full) rises, 4h. 11m.; souths, 0h. 9m.*; sets, 8h. 3m.*; decl. on meridian, 18° 44' N.

Planet	Rises h. m.	Souths h. m.	Sets h. m.	Decl. on meridian
Mercury ...	7 4 ...	10 55 ...	14 46 ...	23 45 S.
Venus ...	8 42 ...	12 46 ...	16 50 ...	21 45 S.
Mars ...	9 19 ...	13 47 ...	18 15 ...	18 4 S.
Jupiter ...	1 47 ...	6 52 ...	11 57 ...	11 28 S.
Saturn ...	16 5* ...	0 10 ...	8 15 ...	21 55 N.

* Indicates that the rising is that of the preceding evening and the southing and setting each that of the following morning.

Occultations of Stars by the Moon (visible at Greenwich)

Jan.	Star	Mag.	Disap.	Reap.	Corresponding angles from vertex to right for inverted image
			h. m.	h. m.	
9 ...	B.A.C. 2432 ...	6½ ...	19 6 ...	19 40 ...	106 175°
10 ...	f Geminorum ...	6 ...	3 5 ...	4 9 ...	111 303
11 ...	54 Cancri ...	6½ ...	8 6 ...	near approach	205
12 ...	18 Leonis ...	6 ...	6 21 ...	6 55 ...	54 346
12 ...	45 Leonis ...	6 ...	21 11 ...	21 50 ...	83 171
12 ...	ρ Leonis ...	4 ...	23 29 ...	0 30† ...	61 199
13 ...	49 Leonis ...	6 ...	1 29 ...	near approach	320

† Occurs on the following morning.

Jan.	h.	Event
9 ...	5 ...	Venus at greatest distance from the Sun.
9 ...	14 ...	Saturn in opposition to the Sun.

Variable Stars

Star	R.A.	Decl.	Jan.	h. m.
	h. m.	h. m.		
U Cephei ...	0 52.3 ...	81 16 N. ...	Jan. 11,	23 22 m
Algol ...	3 0.8 ...	40 31 N. ...	" 13,	5 52 m
R Persei ...	3 22.8 ...	35 17 N. ...	" 13,	M
λ Tauri ...	3 54.4 ...	12 10 N. ...	" 9,	1 4 m
				12, 23 56 m
U Monocerotis ...	7 25.4 ...	9 33 S. ...		13, m
V Cancri ...	8 15.3 ...	17 39 N. ...		9, M
W Virginis ...	13 20.2 ...	2 48 S. ...		11, 5 0 m
Z Virginis ...	14 4.3 ...	12 46 S. ...		14, M
δ Libræ ...	14 54.9 ...	8 4 S. ...		10, 19 15 m
U Coronæ ...	15 13.6 ...	32 4 N. ...		13, 23 56 m
R Draconis ...	16 32.4 ...	67 0 N. ...		10, m
U Ophiuchi ...	17 10.8 ...	1 20 N. ...		9, 5 4 m
		and at intervals of 20 8		
β Lyræ ...	18 45.9 ...	33 14 N. ...	Jan. 9,	23 0 m,
			" 13,	4 0 M
R Lyræ ...	18 51.9 ...	43 48 N. ...	" 13,	M
S Delphini ...	20 37.9 ...	16 41 N. ...	" 14,	m
R Vulpeculæ ...	20 59.4 ...	23 22 N. ...	" 12,	m
δ Cephei ...	22 25.0 ...	57 50 N. ...	" 11,	23 0 m

M signifies maximum; m minimum; m₂ secondary minimum.

GEOGRAPHICAL NOTES

THE latest news from Dr. Oscar Lenz is of much interest. Three letters have been received from him, the latest dated June last from Kasonge, a large Arab town, three days south-east from Nyangwe, on the Upper Congo. Dr. Lenz, it will be

remembered, went out for the purpose of reaching Dr. Junker and Emin Bey. The latest rumours state that he has been compelled to abandon this object, and may therefore be soon heard of at Zanzibar. Dr. Lenz, in canoes furnished by the famous Tippoo Tip, journeyed up the Congo from Stanley Falls, taking fifty days by the way. This, however, included frequent stoppages. He found great changes had taken place since Mr. Stanley made his memorable voyage down the river ten years ago. Then there were few Arabs to be seen beyond Nyangwe, and the river over a great part of its length was peopled by natives, between whose villages the expedition had to run the gauntlet. Now Dr. Lenz finds the whole country practically in the hands of Arab and Zanzibari slavers and traders. The natives in many places have retired into the recesses of the forest, and large Arab settlements have taken their place at several points along the river. There is a constant traffic up and down the river between Nyangwe, or rather Kasonge, and Stanley Falls. Immense rice-fields occupy the swampy and unhealthy areas round these Arab settlements, and all round Nyangwe and Kasonge the country is covered with rice, and plantations of bananas and other fruits. Nyangwe is no longer the important centre it was in the days of Livingstone. It is an irregular collection of Arab settlements, covering a considerable area. Kasonge, three days' journey off further up the river, is, on the other hand, a large town, with broad streets and many well-built houses. This is the head-quarters of Tippoo Tip and other Arab traders, who have their agents for their ivory in Muscat and India. It is evident that we have here a great and increasing intrusion of a foreign element among the native population. In some cases the natives are on friendly terms with the Arabs, and in other cases hostile. At any rate the result will in the end be a very serious modification of the population over a great area of Central Africa, and a marked change in the face of the country by the introduction of rice and other exotic cultures.

MM. BONVALOT AND CAPUS, the French travellers in Central Asia, lately turned back by the Emir of Afghanistan, write to the French Geographical Society, giving some account of their recent journeys. They refer especially to the country between Teheran and Meshed, which they traversed in April last, and which, as they say, is so much frequented that no one thinks it worth while to observe its special features. They found it much cut up by broad rivers with pebbly beds, and irrigation canals which nourish the rare oases along the base of the Elburz Range. The travellers found themselves almost always in the steppe region, on the edge of an immense basin, the bottom of which is the "Khevir" or great salt desert. It is incrustated on the surface with a great quantity of saline crystals, especially soda and magnesia, which often spoil the water and render cultivation impossible. The flora, the fauna, and the geology are those of the steppe, and MM. Bonvalot and Capus make out that the region forms a geographical unit with Central Asia. Not a tree, not a bush even, unless a few garden fruit-trees, with willows and poplars along the canals, relieve the monotony of the country. From the bridge of Saugil to the Thian-Shan, going from west to east, such a thing as a forest is unknown.

HERR QUEDENFELDT, in a paper in the last number of the *Verhandlungen* of the Berlin Geographical Society, on a recent journey in Morocco, mentions a fact of some geographical interest. For more than two years a commission of three or four Spanish staff officers, with a colonel as chief, has been stationed at Tetuan, and have quite publicly been carrying out a topographical survey. They have in this way already surveyed a considerable part of the Garb region, as far as Tangier, Arsilá, Larash, Alkasar, and even Fez.

IN the December *Petermann*, Count Pfeil describes his journeys of exploration last year in the Ulanga and Ussagora regions, with a map. But the article which will attract most interest now—a melancholy interest in some respects—is the preliminary report of the late Dr. Fischer, on the expedition for discovering Dr. Junker; this, too, is accompanied by a map. Dr. Emil Jung continues his essay on the effect of the last Indian famine on the movements of the population, basing the discussion on the official census. A special part of the *Mittheilungen* has been issued, containing an elaborate and systematic index of the contents of the periodical for the ten years 1875-84, including ten annual volumes and eight supplementary volumes. By an ingenious system of colouring, a glance at the maps of the various continents shows

Special maps have been published with the magazine during that period, what the scale of each is, at what part of publication it is to be found, and whether the map is topographical, physical, geological, or statistical. These maps, with their variously-coloured lines, show, too, in a moment, what the regions of the earth which have most engaged attention during the last ten years. In Europe the Balkan peninsula is crowded with lines, in Asia the khanates, the Pamir, Tibet, South-Western China, while the number of lines in Central America north and south of the equator form a veritable labyrinth. A rough idea of the work of every traveller in the last years could be formed from this outline map alone, as the date and occasionally the date are added in each case. The maps and the maps give a bird's-eye view of the work of this series of geographical publications better than anything else can, and we are glad to know that it begins a new decade full of fruitful life and vigour, and with the prospect of a career of as much usefulness in the future as in the past.

HERR NIEDERLEIN, of Buenos Ayres, has been appointed Naturalist and Geographer to the Argentine-Brazilian Boundary Commission, on behalf of the Argentine Government, and he is in October last for the *rendezvous* of the Commission at Montevideo. He has been engaged for sixteen months in the Ministry of Foreign Affairs of the Republic, working out the details of a previous journey, especially his surveys on the Uruguay and Parana Rivers and their main tributaries; these, however, did not rest on any astronomical observations, a defect which he hopes to remedy in the present journey. A careful detailed survey of the frontier districts will be made, and a map of these and of the province of Corrientes will be published this year.

TASMANIAN FISHERIES

THE Report for 1885 of Mr. Saville Kent, Superintendent and Inspector of Fisheries to the Tasmanian Government, contains a good deal that is of scientific as well as economic interest, as will be seen from the following extracts:—

1) *The Oyster Fisheries.*—It affords me much gratification to inform you that considerable success has attended the experiments made in the direction of breeding oysters on the Government reserves and in private fisheries, upon the system advocated and explained in my last year's Report. This system consisted chiefly of laying "collectors," constructed of thin planks or split logs coated with cement, over the breeding oysters placed in the beds. At the Government reserve at Little Oyster Cove, on a private bed at Great Oyster Cove, and on one at the Prosser's River on the East Coast, a considerable quantity of spat or spat has adhered to the collectors laid down, giving the best encouragement for a yet more substantial and commercially remunerative return resulting from the following out of them upon a sufficiently extensive scale. The operations so conducted have been furthermore productive of much valuable information concerning the breeding habits of the oysters of this colony that may be hereafter utilised in their artificial culture. As, last summer none of the collectors were placed on the shore until November, which is generally accepted, as is May in England, as representing the earliest month in which the spat or oyster is liberated. From the size of the brood deposited on the collectors, as also by an examination from time to time of the parent oysters, it was, however, made evident that the greater portion of the spat had been already emitted before the collectors were placed over them. This circumstance indicates the desirability, in future years, of having at least a considerable portion of the collectors in position by the commencement of September. It is of interest to observe that the larger portion of the spat deposited, at both the Government reserve at Little Oyster Cove and on the private bed in the adjacent bay, was derived from New Zealand oysters, thus demonstrating that that variety is suitable for acclimatisation in Tasmanian waters. Another important circumstance to be recorded of the Oyster Cove reserve is the fact that the spat thus obtained was attached exclusively to the cemented collectors, and in no case to the shells of the parent oysters or to the rocks, cultch, or other natural objects to which they customarily adhere; this fact of itself affords practical evidence of the efficacy of these collectors for the purpose for which they have been devised.

At the Government reserve at Spring Bay the collectors ordered were not supplied sufficiently early to intercept the fall of spat.

At the same time the fall which took place, both in the reserve and also upon the public and private oyster-beds throughout the Spring Bay district, has been a very abundant one, the young brood adhering plentifully to the parent shells, mussels, cultch, stakes, and any other objects that afforded them a suitable fulcrum for attachment. With a continuance of this past season's rate of increase, and provided a sufficient amount of breeding stock is maintained on the reserves and private beds, it should not take many years for this locality to regain its original prominent position with relation to the oyster trade. At the present time the recovery of this district has advanced to such an extent that there has been no difficulty experienced in obtaining from it during the present season a stock of about 50,000 breeding oysters for laying down upon various private beds and the Government reserves. From the third Government reserve, established at the West Arm on the Tamar estuary, no substantial results have as yet been obtained, it having been found impossible to complete it and stock it with oysters in time to obtain last summer's fall of spat. A fourth oyster reserve is in process of formation at Little Swanport; and it is proposed, with the funds available for the purpose during the current year, to establish similar Government reserves in the following neighbourhoods, *i.e.* the Carlton River, Taranna, and Southport in the southern district; and at George's Bay, Port Sorell, and other favourable localities to be yet selected, on the north-eastern and northern coast-lines.

I am gratified to be able to report to you that there are already substantial prospects of accomplishing one of the most important objects of the establishment of the Government oyster reserves. At the time of their inauguration it was anticipated and intended that these reserves, in addition to fulfilling the part of nurseries for the propagation of oysters and the replenishment of the surrounding waters, should likewise constitute central stations for the assistance and encouragement of private enterprise in a similar direction, and by whose aid, if developed upon an extensive scale, the restoration of the oyster fisheries of this colony on a thoroughly substantial commercial basis would be greatly accelerated. One private bed with breeding oysters is already established in the vicinity of the Government reserve at Little Oyster Cove, one at Spring Bay, and another at the Prosser's River. Encouraged by the success of these undertakings, applications have been or are about to be made for the leasing of three more suitable areas for the same purpose at Spring Bay, for the same number at Great and Little Oyster Cove, and for others in the neighbourhood of Little Swanport, and at Port Sorell on the north coast.

The important operations connected with oyster-culture in course of progress at the newly inaugurated Fisheries Establishment at Battery Point are recorded under the following heading.

(2) *Fisheries Establishment, Battery Point.*—Since the date of my last Report, and in accordance with the recommendations therein made, suitable premises, including a residence, have been selected and are now rented by the Government at Battery Point for the development and maintenance of a Fishery Establishment. To this site the marine hatchery originally erected at Gore Street has been transported, and re-erected with various additions. The premises occupied include a sea frontage of about three hundred feet, allowing the location of the hatchery so close to the water's edge that the salt water necessary for the maintenance of a constant circulation through the tanks is pumped direct from the sea. The mechanical arrangements are at the same time so disposed that in the event of a storm or flood rendering the outside water temporarily unfit for circulation, the intake pipe can be disconnected, and the water circulated independently from a small reservoir beneath the building. The great advantages derived from the transport of the marine hatchery to its present site, next to the means now afforded for obtaining an unlimited supply of pure sea-water, are the facilities it has provided for constructing in connection therewith tidal ponds for the culture of oysters and marine fish generally upon the adjacent shore. For this purpose an area of about one acre has been inclosed with stakes wired together after the manner adopted for the fencing off of the Government oyster reserves, and within this inclosure two such ponds have been already constructed. In consequence of the circumstance that at ordinary ebb tide the water recedes from a large portion, and at spring tides from almost the entire extent of this inclosed area, the plan has been adopted of excavating these ponds for a foot or two below lowest tide-level, so that under any circumstances they contain an abundant supply of water. The nature of the ground upon the

foreshore inclosed has proved to be well adapted for the construction of these ponds, as immediately beneath a thin superficial covering of sand it is composed of pebbles and tenacious clay so firmly amalgamated as to almost resemble concrete; any excavations made in this bed are consequently thoroughly water-tight. In the preparation of this site for the required purpose, it was found desirable to divert the course of that portion of the Sandy Bay Rivulet which formerly at low tide flowed over the area now occupied by the ponds. This has been accomplished by further excavating the main channel of the stream straight out to sea, and away from the area inclosed, and by interposing between the two a barrier or groin of rocks and tree-trunks, which has had the desired effect of accumulating along its course a natural sand-bank which effectually shuts off the water of the creek. One of the ponds constructed in the inclosure, measuring sixty feet long by thirty wide, is situated immediately beneath the hatchery, and serves as a reservoir for the constant supply of the tanks. This pond, being fenced round with wire netting, is further utilised for the storage and culture of a variety of edible fish in addition to oysters. With each ebb and flow of the tide the water in this pond is more or less completely renewed, and the fish under these conditions are found to thrive remarkably. A list of the edible species of fish that have been cultivated in the pond and tanks since the establishment of the fishery at Battery Point—that is, between the months of February and July 1886—is herewith annexed.

1. Native Salmon (*Arripis salar*).
2. Sea Carp (*Chilodactylus allporti*).
3. Black and Silver Perch (*Chilodactylus macropterus*).
4. Magpie Perch (*Chilodactylus gibbosus*).
5. Real Trumpeter (*Latris hecateia*).
6. Silver Bastard Trumpeter (*Latris forsteri*).
7. Rock Gurnet (*Sebastes percooides*).
8. Flathead (*Platycephalus bassensis*).
9. Tasmanian Whiting (*Sillago ciliata*).
10. Snotgall Trevally (*Neptonemus brama*).
11. Sea Mullet (*Agonostoma forsteri*).
12. Rock Cod (*Pseudophycis barbatus*).
13. Tasmanian Ling (*Ginnypteris biacodes*).
14. Flounder (*Rhombsolea monopus*).

In both the ponds and tanks of the Fisheries Establishment the chief attention is at present being given to the culture of oysters. There is already upon the premises a stock of some eight or ten thousand oysters of different varieties, and in all stages of growth, which stock it is proposed to yet further increase in anticipation of the approaching spatting-season. The varieties include the irregular-shaped Rock Oyster (*Ostrea angulata*) from New South Wales; the smooth variety of *O. edulis* from New Zealand, and many modifications of the indigenous type of the same species. The majority of these oysters have now been acclimatised in the tanks and ponds for the last three or four months, in which space of time it is gratifying to have to record that all of them have thriven and considerably increased the size of their shells. This is particularly noticeable of the New South Wales species, which it is anticipated from this experience it will be found possible to establish and propagate in these waters. The experiment now in course of trial, as to whether they will be able to withstand the severity of the Tasmanian winter months, will be an important factor in this question. The series under cultivation includes, in addition to the stock of adult oysters for breeding purposes, samples of brood raised last summer at Little Oyster Cove and other Government reserves. Among the useful functions accomplished by the Oyster-Culture Department of the Fisheries Establishment at Battery Point may be mentioned the rôle it fulfils of an accessible model for the advantage of those who, in increasing numbers, are taking up oyster-culture as a private enterprise, and who can there obtain information and instructions as to the best methods upon which to conduct their operations. It is also of much value as a central station, at which practical experiments can be made with the view of solving the many vexed problems that present themselves to the pioneers of this industry, and of discovering newer and more profitable methods of cultivating and breeding this mollusk. Already among eminent American and European oyster-culturists it is maintained that the secret of obtaining a far larger percentage of the brood produced by the parent oyster than has hitherto been accomplished is to be solved through the medium of tidal ponds and tanks, wherein the oysters will be supplied with all the equipments necessary for their healthy growth and develop-

ment, and wherein at the same time suitable provision is made for the retention of the produced spat. Tentative experiments having this object in view are now in course of progress under scientific direction in all of the more important oyster-growing communities, and it is hopefully anticipated that some material assistance towards the solution of this important question may be forthcoming from this newly-established practical branch of the Fisheries Department of this colony.

Among the more important points to which my attention has been recently directed and advice solicited is the widely recognised desirability of discovering some method for cultivating oysters in localities in all respects suitable for their growth, with the exception that the labour involved in keeping them constantly clear from sedimentary deposits, or from sinking beneath a too yielding bottom, is too costly for their profitable culture. Experiments made with the view of surmounting this difficulty have resulted in the invention of a species of frame or cradle composed of wood and strong galvanised wire netting, measuring 6 feet long and 3 feet wide, upon which the oysters are placed, and raised to a height of from 9 to 10 inches off the ground. This description of frame so completely answers the purpose for which it was devised that they are being supplied to all of the Government reserves, and are recommended for the use of private growers. Each frame of the dimensions above quoted, which are found to be most portable, conveniently carries as many as 500 adult oysters, so that for a well-stocked bed of, say, 10,000 oysters, a score of them will be sufficient. Having the stock placed on frames of this description, a vast amount of labour usually bestowed in keeping the beds clean and the oysters free from sediment can be dispensed with. In place of the tedious process of dredging the bed through and raising the oysters a few at a time, to be cleaned and re-deposited on the cleared ground, each frame, with its contents, can be raised to the surface, a few shakes suffice to get rid of the sediment that may have accumulated upon them, and they may again be lowered to their place. This object may indeed be accomplished in many instances without raising the frames to the surface, it being sufficient merely to tilt the frame to and fro a few times, as it lies on the bottom, with the aid of a boat-hook, such agitations effectually getting rid of all the sedimentary matter. Wire handles for raising the frames to the surface of the water, with the aid of a boat-hook, should be attached.¹ Further advantages are attached to this frame-system of oyster-culture, since not only can the frames and their contents be raised to the surface at all times to be cleaned and manipulated, but it affords facilities, hitherto unprovided, of keeping an accurate estimate of the amount of stock placed upon the beds, and of watching, from time to time, the progress it is making in development. The form of spat collector that can be most advantageously utilised in conjunction with these oyster-frames is the one figured and described in my last Report under the title of the "single pale" collector, consisting, as its name implies, of a single split paling 4 feet long by 8 or 9 inches wide, having its under surface coated with cement and a brick attached at either end to retain it in the desired position. The experience gained by the past season has demonstrated this to be the most economic and productive form of collector, no alteration in its construction being suggested, with the exception that, by placing a single wire loop or handle in the centre instead of one at each end, as hitherto, their portability, both in and out of the water, is greatly increased. The adaptability of these paling collectors for use in conjunction with the newly-invented frames is very obvious, and their size is such as to allow of their being placed over the oysters in either a single or in two or more transverse rows. It is anticipated that the oysters placed upon the frames will of themselves constitute very efficient spat-collectors, their under surfaces, exposed through the meshes of the wire netting, being kept free from slime and sediment, and raised to a height above the ground favourable for the adherence of the spat. Empty shells or cultch similarly placed on frames in the vicinity of the breeding stock are also likely to prove favourable fulera for the brood to adhere to. A remaining direction in which the oyster culture department of the Fisheries Establishment at Battery Point is found to be of great assistance in the operations now in course of progress relates to its value as a central depot for the reception and temporary storing of the stock brought from a distance for distribution among other reserves.

¹ The frames are raised to the surface of the water by blocks and cord attached to a tripod; where the boat is sufficiently large to carry a mast, the same apparatus may be more conveniently worked from a small derrick affixed to the mast.

THE FORMS OF SEEDLINGS: THE CAUSES TO WHICH THEY ARE DUE¹

SIR JOHN LUBBOCK commenced the lecture with some general remarks on the innumerable types of foliage among mature plants and the causes to which we might refer their various forms, the breadth of some and narrowness of others, the differences of position, the differences of length in conifers, &c. He said that these considerations had led him to study the cotyledon or first leaves of seedlings. Cotyledons do not present such extreme differences as leaves; nevertheless, they afford a very wide range. Some are broad, some narrow, some are long, some short, some are stalked, some sessile, some lobed, some even bifid or trifid. At first sight these differences seem interminable, and it might appear hopeless to attempt to explain them. Sir John Lubbock, however, pointed out, as regards many species, taking especially the commonest plants, as the familiar mustard and cress, the beech, sycamore, chickweed, &c., the conditions of their formation and growth, and it is beautiful to see the various reasons to which the differences are due, gradually unfolding themselves; the same result being sometimes brought about by very different circumstances—emargination of the cotyledons, for instance, being due to at least six different causes. He mentioned one curious peculiarity in the seedling of a species allied to our common mistletoe. It is a parasitic species, and its fruit, like that of the mistletoe, is somewhat viscid, so that it adheres to any plant on which it falls. But, even if it reaches the plant on which it grows, it may light on an unsuitable position—say, for instance, a leaf. What then happens? The radicle elongates for about an inch, and then develops on its tip a flattened disk, which applies itself to the plant. If the situation be suitable, there it grows; if not, the radicle straightens itself, tears the berry from the spot where it is lying, curves itself, and then brings the berry down on to a new spot. The radicle then detaches itself, curves in its turn, and thus finds a new point of attachment. We are assured that this has been seen to happen several times in succession, and that the young plant thus seems enabled to select a suitable situation.

The form of the cotyledons, or seed-leaves, depends greatly on that of the seeds, long narrow seeds naturally, in most instances, producing embryos with narrow cotyledons. The cases, however, which can be so simply accounted for are comparatively few. Many plants with narrow cotyledons have flattened and orbicular seeds. In such species, however, the cotyledons lie transversely to the seed. An interesting case is afforded by the pink family, where the pink itself has broad cotyledons, while the chickweed has narrow ones. In both cases the seeds are flattened and orbicular, but in the pink the seed is dorsally compressed, and the cotyledons lie in the broad axis of the seed; while in the chickweed the seed is laterally flattened, and the cotyledons lie transversely to the seed.

Another very interesting case which he gave is that of the genus *Galium*, to which the common "cleavers" of our hedges belongs. Here also we find some species with narrow, some with broad, cotyledons; but the contrast seems to be due to a very different cause. *Galium aparine* has broad, *Galium saccharatum* narrow, cotyledons. So far as the form of the seed is concerned, there is no reason why the cotyledons should not be much broader than they are. The explanation may perhaps be found in the structure of the pericarp, which is thick, tough, and corky. It is very impervious to water, and may be advantageous to the embryo by resisting the attacks of drought and of insects, and perhaps even, if the seed be swallowed by a bird, by protecting it from being digested. It does not split open, and is too tough to be torn by the embryo. The cotyledons, therefore, if they had widened as they might otherwise have done, would have found it impossible to emerge from the seed. They evade the difficulty, however, by remaining narrow. On the other hand, in *Galium aparine* the pericarp is much thinner, and the embryo is able to tear it open. In this case, therefore, the cotyledons can safely widen without endangering their exit from the seed. The thick corky covering of *Galium saccharatum* is, doubtless, much more impervious to water than the comparatively thin test of *Galium aparine*. The latter species is a native of our own isles, while *Galium saccharatum* inhabits Algiers, the hotter parts of France, &c. May not then, perhaps, he suggested, the thick corky envelope be adapted to enable it

to withstand the heat and drought. In this genus, as in many other plants, the embryo occupies only a part of the seed, being surrounded by a store of food or "perisperm." In many cases the embryo occupies the whole seed, and the cotyledons must, therefore, in large seeds, either be thrown into various folds, as in the beech, or be thick and fleshy, as in the bean or oak. The reasons for their numerous differences open up an inexhaustible variety of interesting questions. Sir John gave a great number of examples, which were rendered clearer by means of numerous diagrams of seeds and seedlings.

In conclusion, he said it might be asked whether the embryo conformed to the seed, or the seed to the embryo, and showed that, at least as regards certain species, the former was the case; while the shape of the seed, again, might be shown to be influenced by considerations connected with the construction of the fruit. In reply to this he compared the seedlings of the sycamore and of the oak. In the sycamore, the seed is more or less an oblate spheroid, and the cotyledons, which are long and ribbon-like, being rolled up into a ball, fit it closely, the inner cotyledon being generally somewhat shorter than the others. On the other hand, the nuts of the beech are triangular. An arrangement like that of the sycamore would therefore be utterly untable, as it would necessarily leave great gaps. The cotyledons, however, are folded up somewhat like a fan, but with more complication, and in such a manner that they fit beautifully into the triangular nut. Can we, however, he said, carry the argument one stage further? Why should the seed of the sycamore be globular, and that of the beech triangular? Is it clear that the cotyledons are constituted so as to suit the seed? May it not be that it is the seed which is adapted to the cotyledons? In answer to this, we must examine the fruit, and we shall find that in both cases the cavity of the fruit is approximately spherical. That of the sycamore, however, is comparatively small, and contains one seed, which more or less exactly conforms to the cavity in which it lies. In the beech, on the contrary, the fruit is at least twice the diameter, and contains from two to four nuts, which consequently, in order to occupy the space, are compelled (to give a familiar illustration, like the pips of an orange) to take a more or less triangular form. Thus then, he said in conclusion, in these cases, starting with the form of the fruit, we see that it governs that of the seed, and that the seed again determines that of the cotyledons. But, though the cotyledons often follow the form of the seed, this is not invariably the case. Other circumstances, as I have attempted to show, must also be taken into consideration, and we can throw much light on the varied forms which seedlings assume.

I fear you may consider that I have occupied your time by a multiplicity of details, and I wish I could hope to have made those little plants half as interesting to you as they have made themselves to me; but, at any rate, I may plead that without minute, careful, and loving study, we cannot hope in science to arrive at a safe and satisfactory generalisation.

The lecture was accompanied not only by numerous diagrams, but by specimens, kindly lent by the authorities of Kew, and by some practical illustrations.

ON THE USE AND EQUIPMENT OF ENGINEERING LABORATORIES

AT the ordinary meeting of the Institution of Civil Engineers, on Tuesday, December 21, 1886, Mr. Edward Woods, President, in the chair, the paper read was "The Use and Equipment of Engineering Laboratories," by Prof. Alex. B. W. Kennedy, M.Inst.C.E. The author believed that it was essential for a young engineer to obtain his practical training, in the ordinary sense of the expression, in a workshop. But the practical training of a workshop was incomplete even on its own ground, and there appeared to be plenty of room for practical teaching such as might fairly fall within the scope of a scientific institution, and which should at the same time supplement and complete workshop experience without overlapping it. In an ordinary pupilage a young engineer did not have much opportunity of studying such things as the physical properties of the iron and steel with which he had to deal, nor the strength of the materials, nor the efficiency of the machines he used, nor the relative economy of the different types of engines, nor the evaporative power of boilers. He required such experience as might help him to determine for himself, or at least to see for himself how other people had

¹ Lecture at the Royal Institution, May 27, 1886, by Sir John Lubbock, Bart., M.P., D.C.L., LL.D., F.R.S., M.R.I.

determined, all the principal engineering constants, from the tenacity of wrought-iron to the calorific value of coal, or the efficiency of a steam-engine, or the accuracy of an indicator-spring, or the discharge-coefficient of an orifice. He thought that this kind of practical experience could be gained best in an Engineering Laboratory, in connection with some institution where technical instruction was given. He claimed that, in the matter of engineering laboratories, as a branch of technical education, England had really taken the lead, instead of being, as was too often the case in such matters, in the rear.

After distinguishing between laboratories whose chief function was original investigation or research, and those whose main object was the practical education of young engineers, and after giving an outline of the method of work which he had adopted, he went on to enumerate the principal subjects upon which experiments in an engineering laboratory might be carried out, summarising them thus:—(1) Elasticity and the strength of materials; (2) the economy, efficiency, and general working of prime movers, and especially of the steam-engine and boiler; (3) friction; (4) the accuracy of the apparatus commonly used for experimentation, such as springs, indicators, dynamometers, gauges of various kinds, &c.; (5) the discharge over weirs and through orifices, and hydraulic experiments in general; (6) the theory of structures; (7) the form and efficiency of cutting-tools; (8) the efficiency of machines, especially of machine-tools and of transmission-gearing; (9) the action and efficiency of pumps and valves; (10) the resistance of vessels and of propellers, and experiments in general connected with both. The paper dealt mainly with the three first subjects, the others receiving brief mention only.

In discussing the best form of testing-machine for laboratory purposes the author described specially the Werder machine, used by Bauschinger and largely elsewhere in engineering laboratories on the Continent, the vertical machine of Mr. J. H. Wicksteed, and the horizontal machine of Messrs. Greenwood and Batley, on Mr. Kirkaldy's principle, used by himself. Incidentally he described a number of other testing-machines, including the Emery machine at the United States Arsenal at Watertown, Fairbanks' machine, and others. The three machines first named were compared in some detail in respect to their accuracy, mode of applying load, methods of making observations, adaptability for varied experiments, simplicity, and accessibility, and the comparative advantages and disadvantages of each were discussed, the author preferring, on the whole, the Greenwood type. The method of testing employed by the author, with pump, accumulator, and Davy motor, was then described and illustrated.

Different apparatus for the measurement of minute extensions, compressions, &c., occurring below the limit of elasticity, were next discussed, the instruments specially mentioned being those of Prof. Unwin, Prof. Bauschinger, Mr. Stromeyer, and the author, as representing micrometric, optical, and mechanical exaggeration of strains. Automatic test-recording apparatus was next dealt with, Prof. Unwin's, Mr. Wicksteed's, Mr. Ashcroft's, and the author's diagramming machines being mentioned and illustrated. Automatic diagramming apparatus for elastic strains was next discussed. The paper contained *fac-similes* of various diagrams, both ordinary and elastic. In concluding this section of the paper, brief references were made to machines for transverse tests, torsional tests, shearing tests, cement and wire tests, secular experiments, experiments on repeated loads, &c.

In discussing the design of an experimental engine for laboratory purposes, the author first enumerated the principal conditions under which such an engine should be capable of working, summarising them thus:—(1) Condensing or non-condensing; (2) simple or compound; (3) compound, with cranks at various angles; (4) with the greatest possible variation of steam-pressure; (5) with the greatest possible variation of cut-off and other points in the steam distribution; (6) with the greatest possible variation of brake-power; (7) with considerable variation in speed; (8) with or without throttling; (9) with or without jackets, and with varying conditions as to their use; (10) with variation of clearance-spaces; (11) with variation of receiver-volume; (12) with or without arrangements for intermediate heating; (13) with variation in the reciprocating masses. He then enumerated the principal quantities which had to be measured during an engine-test, making remarks upon each important point in passing. A list was given of the principal experimental engines in existence,

including those in London, Birmingham, Leeds, Munich, and Liège. This section was concluded by a description of the arrangement of an experimental boiler.

Under the head of friction-experiments, the principal points were summarised upon which experiments were required, in order that anything like a complete theory of friction in machines might be worked out. These included the variations of velocity, intensity of pressure, extent of contact, temperature, lubricant, method of lubrication, and nature of rubbing material. Friction-measuring machines, used or proposed by Prof. Thurston, Prof. R. H. Smith, Mr. Tower, and himself, were briefly described. The paper concluded with a few remarks on laboratory experiments connected with hydraulic work, the theory of structures, the form and efficiency of cutting-tools, the efficiency of machines and of transmissions, the action and efficiency of pumps and valves, and the resistance of vessels and propellers.

In an appendix there were added:—(a) Forms used by the author for conducting engine-trials. (b) Notes on the principal engineering laboratories in Europe and in America, with brief accounts of the chief apparatus used in each.

BIRDS' NESTS AND EGGS¹

THE philosophy of birds' nests and eggs involves questions far too profound to be settled in an hour's lecture. The extreme partisans of one school regard birds as *organic automata*. They take a Calvinistic view of bird-life: they assume that the hedge-sparrow lays a blue egg because, under the stern law of protective selection, every hedge-sparrow's egg that was not blue was tried in the high court of Evolution, under the clause relative to the survival of the fittest, and condemned, a hungry magpie or crow being the executioner. The extreme partisans of the other school take an entirely opposite view. They regard the little hedge-sparrow, not only as a free agent, but as a highly intelligent one, who lays blue eggs because the inherited experience of many generations has convinced her that, everything considered, blue is the most suitable colour for eggs.

Perhaps the first generalisation that the egg-collector is likely to make is the fact that birds that breed in holes lay white eggs. The sand-martin and the kingfisher, which lay their eggs at the end of a long burrow in a bank, as well as the owl and the woodpecker, which breed in holes in trees, all lay white eggs. The fact of the eggs being white, and consequently very conspicuous, may have been the cause, the effect being that only those kingfishers which bred in holes survived in the struggle for existence against the marauding magpie. But the converse argument is equally intelligible. The fact that kingfishers breed in holes may have been the cause, and the whiteness of the eggs the effect; for why should Nature, who is generally so economical, waste her colouring-matter on an egg which, being incubated in the dark, can never be seen? The fact that many petrels and most puffins, which breed in holes, have traces of spots on their eggs, whilst their relations the auks and the gulls, who lay their eggs in open nests, nearly all lay highly-coloured eggs, suggests the theory that the former birds have comparatively recently adopted the habit of breeding in holes, and that consequently the colour being no longer of use is gradually fading away. Hence, we assume that the colour of the egg is probably the effect of the nature of the locality in which it is laid.

The second generalisation which the egg-collector is likely to make is the fact that so many of these birds which breed in holes are gorgeously coloured, such as kingfishers, parrots, bee-eaters, &c. The question naturally arises, Why is it so? The advocates of protective selection reply, Because their gay plumage made them so conspicuous as they sat upon their nests, that those that did not breed in holes became the victims of the devouring hawk, exactly as the conspicuous white eggs were eaten by the marauding magpie. But the advocates of sexual selection say that all birds are equally vain, and wear as fine clothes as Nature will let them, and that the kingfisher is able to dress as gorgeously as he does because he is prudent enough to breed in a hole safe from the prying eyes of the devouring hawk. The fact that many birds, such as the sand-martin and

¹ Abstract of a lecture delivered by Mr. H. Seebohm at the London Institution on December 20, 1886.

the dipper, which breed in holes, are not gorgeously coloured, while others, such as the pheasants and the humming-birds, are gorgeously coloured, but do not breed in holes, is evidence, as far as it goes, that the gorgeous colour of the bird is not the effect of its breeding in a hole, though the white colour of the egg probably is. It must be admitted, however, that the latter cases are not parallel. Whilst the hen kingfishers and bee-eaters are as gorgeous as their mates, the hen pheasants and the hen humming-birds are plainly, not to say shabbily, dressed. If birds be as vain as the advocates of sexual selection deem them, it must be a source of deep mortification to a hen humming-bird to have to pass through life as a foil to her rainbow-hued mate. Whilst the kingfisher relies for the safety of its eggs upon the concealed situation of its nest, the humming-bird depends upon the unobtrusiveness of the plumage of the sitting hen.

A very large number of birds, such as the grouse, the merlin, most gulls and terns, and all sandpipers and plovers rely for the safety of their eggs upon the similarity of their colour to the ground on which they are placed. It may be an open question whether these birds select a site for their breeding-ground to match the colour of the eggs, or whether they have gradually changed the colour of their eggs to match the ground on which they breed; but, in the absence of any evidence to the contrary, it is perhaps fair to assume, as in the previously mentioned cases, that the position of the nest is the cause, and the colour of the egg the effect.

Many birds make their nests in lofty trees, or on the ledges of precipitous cliffs. Of these, the eagles, vultures, and crows are conspicuous examples. They are, for the most part, too powerful to be afraid of the marauding magpie, and only fear the attacks of beasts of prey, amongst which they doubtless classify the human race. They rely for the safety of their eggs on the inaccessible positions of the nest. Many of them also belong to a still larger group of birds who rely for the safety of their eggs upon their own ability, either singly, in pairs, or in colonies, to defend them against all aggressors. Few colonies of birds are more interesting than those of herons, cormorants, and their respective allies. These birds lay white or nearly white eggs. Nature, with her customary thrift, has lavished no colour upon them because, apparently, it would have been wasted effort to do so; but the eggs of the guillemot are a remarkable exception to this rule. Few eggs are more gorgeously coloured, and no eggs exhibit such a variety of colour. It is impossible to suppose that protective selection can have produced colours so conspicuous on the white ledges of the chalk cliffs; and sexual selection must have been equally powerless. It would be too ludicrous a suggestion to suppose that a cock guillemot fell in love with a plain-coloured hen because he remembered that last season she laid a gay-coloured egg. It cannot be accident that causes the guillemot's eggs to be so handsome and so varied. In the case of birds breeding in holes secure from the prying eyes of the marauding magpie, no colour is wasted where it is not wanted.

The more deeply Nature is studied, the more certain seems to be the conclusion that all her endless variety is the result of evolution. It seems also to be more and more certain that natural selection is not the cause of evolution, but only its guide. Variation is the cause of evolution, but the cause of variation is unknown. It seems to be a mistake to call variation spontaneous, fortuitous, or accidental, than which expressions no adjectives less accurate or more misleading could be found. The Athenian philosophers displayed a less unscientific attitude of mind towards the Unknown when they built an altar in its honour.

SCIENTIFIC SERIALS

American Journal of Science, December 1886.—On the crystallisation of native copper, by Edward S. Dana. This elaborate memoir, which is illustrated with four plates figuring fifty-four varieties of native copper crystalline forms, is based chiefly on the fine collection of over sixty specimens from Lake Superior, belonging to Mr. Clarence S. Bement, of Philadelphia, supplemented by reference to the cabinets of Yale College Museum and Prof. G. J. Brush. The planes here determined are disposed in the three groups of tetrahedrons, trisectahedrons, and hexoctahedrons, and include several new to the species. The paper also comprises an historical summary from the studies of Haüy and Mohs (1822) to the recent contributions of W. G.

Brown.—On the trap and sandstone in the gorge of the Farmington River at Tariffville, Connecticut, by W. North Rice. The trap and sandstone of this locality are here specially studied with a view to the general elucidation of the history of these formations in the Connecticut Valley. The author's researches confirm the conclusion already arrived at by Prof. W. M. Davis, that some of the sheets of trap intercalated among the sandstones and associated rocks are contemporaneous, and others intrusive.—Comparative studies upon the glaciation of North America, Great Britain, and Ireland, by Prof. H. Carvill Lewis. This is an abstract of a paper by the author, read at the Birmingham meeting of the British Association last September. Its object is to show that the glacial deposits of the British Isles, like those of America, may be best interpreted by considering them with reference to a series of great terminal moraines, which both define confluent lobes of ice, and often mark the line separating the glaciated from the non-glaciated areas.—On certain fossiliferous limestones of Columbia County, New York, and their relation to the Hudson River shales and the Taconic system, by J. P. Bishop. The author describes some new fossils recently discovered in a metamorphic limestone occurring in the Chatham and Ghent districts on the western border of the Taconic slates of Columbia county, and tending to throw further light on the age of the Taconic formation. His investigations are still in progress, but from the facts so far determined, he considers that the fossils are of Trenton age, suggesting a synclinal having the Trenton limestone outcropping on both sides, and with the eastern edge pushed over westward.—Crystallised vanadinite from Arizona and New Mexico, by S. L. Penfield. The specimens here described and figured belong partly to the collection of the late Prof. B. Silliman, partly to that of Prof. Geo. J. Brush. Those from Pinal County, Arizona, are specially interesting, being of a deep red colour, and usually showing the very simple combinations already described by L. H. Blake.—The viscosity of steel and its relations to temper, by C. Barus and V. Strouhal. Having during the course of their former researches expressed the belief that the qualities of retaining magnetism exhibited by steel would probably stand in relation to the viscous properties of the metals, the authors here make a first search for such a relation. For several reasons their investigations are limited to torsional viscosity, and a new and very sensitive differential method is partially developed for the study of this property, with incidental reference to the viscosity of iron and glass. The results of the method as applied to steel are further compared with the known behaviour of permanent linear magnets tempered under like conditions.—Some remarks upon the journey of André Michaux to the high mountains of Carolina in December 1788, in a letter addressed to Prof. Asa Gray, by C. S. Sargent. Michaux's chief object was to secure living specimens of *Magnolia cordata*, and the locality explored by him appears to have been the highland region of North and South Carolina about the head waters of the Savannah River. The author has recently visited the same district for the purpose of re-discovering the same plant where Michaux was thought to have found it, but he searched for it in vain, and he concludes that Michaux's *Magnolia cordata*, as known in gardens, must be regarded as a rare and local variety of *M. acuminata*.—Note on the age of the Swedish Paradoxides beds, by S. W. Ford. It is argued on several grounds that these beds, or at any rate those above the division characterised by *Paradoxides kjerulfi*, are of the age of the Menevian group. Even this species should probably be referred to the same group, so that the strata contain it may be regarded as constituting a legitimate portion of the Swedish Paradoxides measures.

Rivista Scientifico-Industriale, November 1886.—On the development of atmospheric electricity which accompanies the condensation of aqueous vapour to rain or snow caused by a lowering of the temperature, by Prof. Luigi Palmieri. Those physicists who still doubt the reality of this phenomenon are recommended to conduct their researches with the Bohnenberger electro-scope, as perfected by the author.—On the electric conductivity of vapours and gases, by Prof. Constantino Rovelli. Some experiments are described, fully confirming the important conclusions recently announced by Prof. Luvin regarding the non-conducting property of aqueous vapour.—On the pairing-season of frogs and toads in the Venetian district, by Dr. Alessandro P. Ninni. This period is shown to be determined by the atmospheric conditions, being advanced or retarded according to the mildness or severity of the weather in spring.

SOCIETIES AND ACADEMIES

LONDON

Royal Society, November 18.—"On the Specific Heats of Minerals." By J. Joly, B.E., Trinity College, Dublin. Communicated by Prof. Fitzgerald, F.R.S.

A number of experiments—carried out by the method of condensation—are tabulated in this paper, on minerals whose specific heats have not previously been determined as well as on some mineral substances previously dealt with by Kopp, Regnault, &c.

The observation of specific heat is suggested as of value in determinative mineralogy. It is, with some exceptions, nearly constant for the same chemical composition, and calculable from an assumed chemical constitution, not alone in the case of simple compounds, but in the case, often, of the more complicated silicates, &c. No difficulty is introduced into its determination by conditions of aggregation such as looseness, &c. The method by weighing in air and steam admits of its value being very simply determined, and, if great accuracy be not required, very rapidly.

The experiments made by the writer show that there is a small variation in the specific heats of minerals of the same species, accompanying slight differences in translucency, lustre, perfection of crystalline form, the tendency being for the specific heat to be a minimum in the most perfect crystals. There is, further, in some cases, a variation of quite different order accompanying pronounced differences in physical appearance, as from the transparent aquamarine to the clouded beryl, sapphire to corundum, &c.; so that a distinct and definite value exists for each variety, unaccounted for by any probable variation in chemical composition.

It appears, also, that this kind of variation obtains in the case of the isometric sulphides, pyrite, galenite, sphalerite, and in such degrees as admit of the several values being stated in numerical proportion from one substance to another. Thus, using the initial letters for the observed values, it is found that—

$$P_1 : P_2 :: S_1 : S_2$$

and, if the orthorhombic disulphide of iron, marcasite, be included, the proportion

$$S_1 : S_2 :: P_1 : m :: S_1 : S_3$$

obtains very closely. The observations of other observers are included in these ratios, the existence of which, if further borne out, suggest as an explanation the existence of variations of structure of definite character affecting, in a definite way, the freedom of the atom. From this point of view, the case of marcasite would be that in which such variation proved adequate to determine a special symmetry for the aggregate.

December 9.—"Note to a Paper on the Geometrical Construction of the Cell of the Honey-Bee" (*Proc. R.S.*, No. 240, p. 253, 1886). By Prof. H. Hennessy.

The author found in the foregoing paper that a side of one of the lozenges terminating the cell was three times the difference between two parallel edges of the hexagonal prism, and from this result he constructed one of the lozenges by erecting a perpendicular at one-third of its length from one end, and from this end, with radius equal to the side, he inflected a second side of the lozenge, which gave the whole figure and also the six trapeziums forming the prism. With a compass and ruler the whole figure can be thus easily constructed.

The author further proves that the triangular pyramid which terminates the bee's cell may be inscribed in a sphere whose diameter is three times one of the edges of the pyramid. Moreover, this sphere contains within it as much of the hexagonal prism as may be measured by twice the side of a lozenge on the prism's shorter edge. These results, together with the extremely simple mode given by the author for constructing the figure, divest the problem of the complex character which it was sometimes supposed to have, and they may also assist in explaining the action of the bees in moulding the cells of the honeycomb to their observed shapes.

"The Intra-ovarian Egg of some Osseous Fishes." By Robert Scharff, Ph.D., B.Sc. Communicated by Prof. McIntosh, F.R.S.

December 16.—"On the Changes in the Proteids in the Seed which accompany Germination." By J. R. Green.

The author described experiments proving the existence in germinating seeds of a ferment resembling the proteolytic ferment of the pancreas. This exists in the resting seeds in the

condition of a mesostate or zymogen, and is, on the starting of the germinative process, transformed into the active ferment. He traced the changes which it brings about in the reserve proteids of the seed, and showed that, while they passed through the stage of peptone, the nitrogen was carried to the growing points in the condition of a crystalline amide, such as leucin, asparagin, &c.

Zoological Society, December 21, 1886.—Prof. W. H. Flower, LL.D., F.R.S., President, in the chair.—Mr. Howard Saunders, F.Z.S., exhibited and made remarks on a specimen of a hybrid between the Tufted Duck and the Pochard, bred in Lancashire in 1886.—Mr. J. Bland Sutton, F.Z.S., read a paper on atavism, being a critical and analytical study on this subject.—Dr. von Lendenfeld read a paper on the classification and systematic position of the Sponges. This was based on the recent researches on the Hexactinellida, Tetractinellida, and Monaxonida of the *Challenger* Expedition, and on his own investigations on the rich Australian Sponge-fauna, particularly of the groups Calcarea, Chalinidæ, and Horny Sponges. A complete system of Sponges was proposed, and worked out down to the families and sub-families, and all the principal genera were mentioned. An approximately complete list of the literature of Sponges (comprising the titles of 1446 papers), a "key" to the determination of the 46 families, and a discussion of the systematic position of the Sponges were also contained in the paper.—Prof. Ray Lankester communicated a paper by Dr. A. Gibbs Bourne, of the Presidency College, Madras, on Indian earthworms, containing an account of the earthworms collected and observed by the author during excursions to the Nilgiris and Shevaroy Hills. Upwards of twenty new species were described.

Geological Society, December 15, 1886.—Prof. J. W. Judd, F.R.S., President, in the chair.—John Usher and Joseph Tertius Wood were elected Fellows of the Society.—The following communications were read:—Notes on *Nummulites elegans*, Sow., and other English Nummulites, by Prof. T. Rupert Jones, F.R.S. The author finds, in the "Sowerby Collection," now in the British Museum, the original specimens on which Sowerby founded his *Nummularia elegans* (1826, "Min. Conch." vol. vi. p. 76). These are partly specimens from that part of the bed "No. 29" of Prof. Prestwich's section of Alum Bay (Quart. Journ. Geol. Soc., vol. ii. (1846), p. 257, pl. ix. fig. 1), which is known to be the lowest of the Barton series; and partly some in a stone said to be from Emsworth, in Hampshire. The former are the same as those named *Nummulites planulata*, var. *Prestwichiana*, by Rupert Jones in 1852; and the latter are *N. planulata*, Lamarck (1804), and probably foreign. Thus *N. elegans* has priority over *Prestwichiana*; and as this last was determined by De la Harpe to be a variety of *N. wemmelsensis*, Van den Broeck and De la Harpe, this variety should be var. *elegans*. The author thinks that, on broad zoological principles, *N. planulata* might still be regarded as the species; but, in view of the careful differentiation worked out by De la Harpe, he accepts the "specific" standing of "*wemmelsensis*" as useful among *Nummulites*; but "*Prestwichiana*" has to give way to "*elegans*" for the peculiar "Barton" variety. A bibliographical history of the long-misunderstood *N. elegans*, Sowerby, descriptions of this form and of *N. variolaria* (Lam.), notes on *N. levigata* (Brug.), and an account of their range in England, complete the paper.—On the dentition and affinities of the Selachian genus *Psychodus*, Agassiz, by A. Smith Woodward, F.G.S. The genus *Psychodus*, owing to the detached condition in which the teeth are usually found, has hitherto been imperfectly understood. Agassiz referred it to the Cestraciontidae, on account of a supposed resemblance in the arrangement of the teeth, and Owen's researches on their microscopic structure served to confirm this view. On the other hand, several writers have pointed out characters tending to show affinity between *Psychodus* and *Rhynchobatus*. More recently, however, Prof. Cope and the author had shown that the supposed affinities between *Psychodus* and the Cestraciontidae were only apparent, and in the present paper additional evidence was brought forward. The author proceeded to describe several specimens of *P. decurrens* in the British Museum, and in the collection of Mr. H. Willett, of Brighton, one of the latter, especially, containing, what had been previously entirely unknown, the dentition in part of both jaws. These specimens showed that each jaw contained six or seven longitudinal rows of teeth on each side of the median row, and that the genus must

referred to the true Rays, and not to the Cestraciont sharks, though the precise family to which *Psychodus* belongs was more difficult to determine. On the whole the writer was disposed to assign it a place either amongst the Myliobatidæ or in their neighbourhood. The microscopic structure of the teeth was found to be insufficient, by itself, to show their affinities.—On a collar of a Pliocene type of *Equus*, from Nubia, by R. Lydekker, F.G.S. A small collection of Mammalian remains from near Wadi Halfa had recently been placed in the author's hands; some of the bones were mineralised similarly to those of the Upper Pliocene of the Val d'Arno, or the Lower Pleistocene of the Narbadda valley. Amongst others, the most interesting was a right upper cheek-tooth of *Equus* but little worn. It evidently does not belong to any of the late Pleistocene or recent species of the genus, but to the more generalised group comprising *E. sivalensis*, &c.; though, bearing in mind the impossibility of distinguishing many of the existing species of the genus by their teeth alone, its absolute specific identity is not asserted. We may infer, then, that the ossiferous beds of Wadi Halfa are not improbably of Pliocene age, since this group of horses, both in Europe, Algeria, and India, had totally disappeared after the period of the forest-bed. Moreover, it is of interest, in view of previously expressed opinion, to find in the tertiary of Nubia a species of this primitive group of *Equus*, which is apparently more nearly allied to the Siwalik than to the European species.

Royal Microscopical Society, December 8, 1886.—Rev. Dr. Dallinger, F.R.S., President, in the chair.—Mr. J. Mayall, jun., called attention to a microscope, exhibited and made by Mr. Hilger after the designs of Sir A. Campbell, for measuring with great accuracy the divisions ruled upon a diffraction-plate. A special feature was the application of electricity, so that, by means of a weak battery and a galvanometer, it could be arranged that a contact should be made when passing every line, such contact being shown instantly by a deflection of the galvanometer-needle. In this way, end-measurements could be made with great accuracy.—Mr. Mayall also exhibited and described a new form of heliostat (made by Mr. Hilger) for use in solar photomicrography. The pencil of sunlight reflected from the first mirror could, by means of the second, be directed in any desired direction, affording to the worker the very great advantage of being able to place his microscope and camera in any position he pleased.—Mr. F. R. Cheshire exhibited and described an improved form of inoculating needle for use in connection with Bacterium culture-tubes. It was mounted in a wooden handle having a square ferrule which prevented it from rolling when placed upon an uneven surface; in this was inserted a piece of silver tube, at the end of which was the platinum wire. A circular disk of silver was fixed on the tube, which, when placed in the flame of a lamp, rapidly became hot, and communicated the heat to the needle, while the small size of the tube enabled it to be introduced into the culture-tube more easily than the glass rod usually employed.—Prof. Bell called attention to some specimens exhibited of *Tenia nana*, the smallest of the human tape-worms, originally found by Bilharz in Egypt in 1850. Though extremely rare, it had the great advantage, to the physiologist at least (though not perhaps to the patient), of being found in considerable numbers. In the present instance the worms had been found in quantities in the abdomen of a girl aged seven years, at Bellegarde. The largest specimen met with was only 15 millimetres long.—Mr. D. Hardy called attention to a paper, by Dr. O. Zacharias, in which it was stated that Rotifers could never be revived after desiccation. He thought a protest should be entered against his, as it was within his knowledge that revivification had taken place over and over again. He had frequently tried the experiment, and had found that, when the dried mud was moistened, the Rotifers constantly revived. Prof. Stewart pointed out that a good deal must turn on what was meant by "desiccation." It was exceedingly difficult, under ordinary circumstances, to produce a condition of complete desiccation, and it was therefore very probable that in all cases of revivification there was sufficient moisture retained to preserve life. Prof. Bell said this explanation had usually been accepted as the real one when this subject perennially came to the front. The most curious part of Dr. Zacharias's paper, however, was that he did not in any way attempt to criticise the observations of his predecessors on the facts, but simply declared them to be fables, not inquiring at all into the conditions under which the revivals took place, so as to ascertain whether or not they were desiccated in the same sense

in which his objects were when dried up in a granite basin. A discussion ensued, in which the President, Mr. Crisp, Mr. Michael, and Mr. Lewis joined.—Colonel O'Hara's note on the dissimilarity of appearances of crystals of blood as examined by him, and the illustrations in text-books, was read.—Mr. P. H. Gosse's paper, on twenty-four new species of Rotifera, was read, and two plates, drawn by Mr. Gosse in illustration, were handed round for inspection.

Anthropological Institute, December 14.—Francis Galton, F.R.S., President, in the chair.—The election of Mr. J. A. Otonba Payne, of Lagos, as an Ordinary Member, and of Dr. W. J. Hoffmann as a Corresponding Member, was announced.—Dr. E. B. Tylor read a paper by the Rev. G. Brown on Papuans and Polynesians, in which Mr. Brown contended that, notwithstanding physical differences, the similarity of their languages and customs prove the Papuans and the inhabitants of all the Pacific Islands have a common origin.—The following papers were also read:—Notes on songs and song-makers of some Australian tribes, by A. W. Howitt, F.G.S.—Music of the Australian aborigines, by G. W. Torrance, Mus.D.—On the aborigines of Western Australia, by R. H. Bland.

PARIS

Academy of Sciences, December 27, 1886.—M. Jurien de la Gravière, President, in the chair.—The proceedings were opened with an eloquent allocution by the President on the progress and triumphs of science during the past year, with a touching allusion to the loss sustained by the Academy in the death of its distinguished members, MM. Tulasne, de Saint-Venant, Laguerre, and Paul Bert.—The allocution was followed by the announcement of the prizes awarded during the year to the successful competitors in the various branches of the physical and natural sciences:—Prix du Budget (Mathematics), Edouard Goursat; Prix Francœur (Geometry), Emile Barbier; Extraordinary Prize of 6000 francs (Navigation), Capt. G. Fleuriat; 4000 francs, Capt. de Bernardières; 2000 francs; Prix Montyon, 2500 francs (Mechanics), M. Rozé; Prix Plumey (Naval Engineering), M. de Bussy; Prix Poncelet (Mathematics), Emile Picard; Prix Lalande (Astronomy), M. O. Backlund; Prix Damoiseau (Astronomy), M. Soullart, and to M. Obrecht 1000 francs; Prix Valz (Astronomy), M. Bigourdan; Prix Bordin (Optics), M. R. Radau; Prix Montyon (Vital and Social Statistics), M. Victor Turquan, with honourable mention of Dr. Mireur, Cazin, and Socquet; Prix Jecker (Chemistry), divided equally between MM. Colson and Oechsner de Coninck; Prix Vaillant (Geology), the members of the French Mission to Andalusia, MM. Michel Lévy, Bertrand, Barrois, Offret, Kilian, and Bergeron, and 1000 francs to M. de Montesson; Prix Barbier (Botany), M. Eugène Collin; Prix Desmazières (Botany), MM. H. van Heurck and A. Grunow; Prix de la Fons Mélicocq (Botany), divided equally between MM. Gaston Bonnier, G. de Layens, and E. G. Camus; Prix Montagne (Botany), Dr. Quélet; Prix Thore (Entomology), M. Peragallo; Prix Montyon (Medicine), Drs. Léon Colin, Dejerine and Landouzy, and Orcé, 2500 francs each, besides honourable mention with 1500 francs to MM. Cadéac and Malet, Masse, and Ollivier; Prix Bréant (Medicine), Dr. Duflocq 2000 francs, M. Ad. Guérard 1500 francs, and M. Thoinot 1500 francs; Prix Godard (Surgery), M. Bazy; Prix Lallemand (Surgery), M. W. Vignal; Prix Montyon (Experimental Physiology), M. Gréhan, with honourable mention of M. Assaky; Prix Gay (Physical Geography), M. Ph. Hatt; Prix Montyon (Unhealthy Industries), MM. Appert Brothers, and M. Kolb 2500 francs; Prix Trémont (Magnetism), M. Moureaux; Prix Gegner, M. Valson; Prix Delalande-Guérineau (Terrestrial Physics), M. Hyades; Prix Jean Reynaud (Therapeutics), M. Pasteur; Prix Ponti (Aerial Navigation), MM. Renard and Krebs; Prix Marquise de Laplace, M. E. A. Brisse.—Prizes proposed for the year 1887:—Francœur, 1000 francs, discoveries or works useful to the progress of pure and applied mathematics; Extraordinary Prize of 6000 francs, works tending to increase the efficiency of the French naval forces; Poncelet, 2000 francs, for the most useful work for the advancement of the pure and applied mathematical sciences; Montyon, 700 francs, mechanics; Plumey, 2500 francs, improvement of steam-engines, or any other invention contributing most to the progress of steam navigation; Fourneyron, 500 francs, theoretical and practical study of the progress made in aerial navigation since 1880; Lalande, 540 francs, Valz, 460 francs, and Damoiseau and Janssen, gold medals, works contributing to the advancement of astronomy; Grand Prize of the

Mathematical Sciences, 3000 francs, researches on the elasticity of one or more crystallised bodies from the experimental and theoretical standpoints; L. Lacaze, 10,000 francs each, to the authors of the best work on physics, chemistry, and physiology; Montyon, 500 francs, vital statistics; Jecker, 10,000 francs, organic chemistry; Delesse, 1400 francs, to the author of a treatise on the geological or mineralogical sciences; Barbier, 2000 francs, for any valuable discovery in surgery, medicine, pharmaceuticals, or botany, in connection with therapeutics; Desmazières, 1600 francs, for the most useful work on the whole or any section of cryptogamy; Thore, 200 francs, awarded alternately for works on the cellular cryptogams of Europe, and for researches on the habits and anatomy of any European entomological species; Montagne, 1000 and 500 francs, to the authors of important works on anatomy, physiology, the development or description of the lower cryptogams; Grand Prize of the Physical Sciences, 3000 francs, researches on the phenomena of phosphorescence in animals; Bordin, 3000 francs, for a comparative study of the African, South Asiatic, and Australasian freshwater fauna; Bordin, 3000 francs, for a comparative study of the auditory apparatus in the warm-blooded vertebrates, mammals, and birds; Savigny, 975 francs, for young zoological travellers; Montyon, 750 francs, medicine and surgery; Bréant, 100,000 francs, to the discoverer of an efficacious remedy against Asiatic cholera; Godard, 1000 francs, anatomy, physiology, and pathology of the genito-urinary organs; Serres, 7500 francs, general embryology, especially as applied to physiology and medicine; Chaussier, 2500 francs, for important works on forensic and practical medicine; Lallemand, 1800 francs, for works relating to the nervous system in the widest sense of the term; Montyon, 750 francs, experimental physiology; Gay, 2500 francs, distribution of heat on the surface of the globe; Montyon, unhealthy industries; Trémont, 1100 francs, for any naturalist, physicist, artist, or mechanic needing assistance in the accomplishment of any undertaking useful to France; Gegner, 4000 francs, in aid of any *savant* distinguished by serious pursuits undertaken for the purpose of advancing the positive sciences; Petit D'Ormy, 10,000 francs, pure and applied mathematics, and the natural sciences; Laplace, a complete edition of the works of Laplace, for the first student leaving the Ecole Polytechnique. General conditions: the Academy retains all memoirs, the authors being at liberty to obtain copies from the Secretary. Competitors must send in their papers by June 1, accompanied by a brief summary of the part containing the discovery on which they desire the judgment of the Academy. No one can claim the title of Laureate of the Academy unless awarded a prize. Honourable mention or any other formal recognition of merit does not justify the assumption of this title.

STOCKHOLM

Society of Natural Science, September 18.—Prof. Wittrock gave an account of the gypsies, chiefly in relation to Hungary, which country he had recently visited with a view to studying its various nationalities.—Dr. Skåberg exhibited abnormal specimens of various plants he had found in Sweden last summer, viz. *Phleum pratense*, *Listera ovata*, *Linaria cymbalaria*, *Typha angustifolia*, and *T. latifolia*.—Herr Berggren exhibited a specimen, in spirits, of *Nyctalis parasitica*, which had grown on another fungus, *Russula adusta*, whilst the latter was still quite fresh. The former fungus, he said, was also at times attacked by a smaller parasitic one, imparting to it a kind of coating.—Herr Meves exhibited a specimen of *Oriolus guttula*, shot last May, a bird very rarely found in Sweden.

Entomological Society, September 25.—Prof. Chr. Aurivillius gave an interesting account of his studies, last summer, of the habits of various species of Hymenoptera. He specially referred to one, *Odynerus muralis*, which he had found when boring holes in red-painted wooden walls, at the bottom of which it deposited its larvæ, protecting the latter against attack by making partitions of clay at intervals, and by putting a prop at the end, which it carefully covered with tiny bits of red paint, whereby these holes were almost impossible to detect.—Dr. Lampa described his observations of the remarkable keenness of the olfactory organs of the males of *Bombyx quercus*, L., whereby they were enabled to discern the females, even when far off. In one instance a female had been discovered by a male, although access to the former, which was in a cage, could only be gained through a balcony and room beyond.—Dr. Adlerz referred to an unusual case of hermaphroditism in an ant, whose left half was formed like a male, and the right like a female.

CHRISTIANIA

Society of Sciences, October 1.—The following papers were presented:—*Der Ursprung der Etrusker durch zwei jenseitige Inschriften erläutert*, by Prof. Sophus Bugge.—*Fresh contributions to our knowledge of the extension of the tall plants in Norway*, by Prof. A. Blytt.—*On variations in climate in the course of time* (see NATURE, vol. xxxiv. pp. 220 and 239), by the same.—*Ueber die Entwicklungsgeschichte der Pollenkörner des Angiospermen*, by Dr. N. Wille.—*Fresh contributions to our knowledge of the extension of lichen in Norway*, by Herr B. Kaalaas.—Dr. G. Storm read a paper on *voyages to countries north and north-west of Iceland, maintaining that the priests who, in 1285, discovered "Nya Land" (New Land) did not reach Newfoundland, but the south-eastern part of Greenland, and that the island discovered in 1194, "Svalharde," was Jan Mayen. He further believed that the old Norsemen knew of other Arctic countries north of Russia and Norway.*

BOOKS AND PAMPHLETS RECEIVED

Annual Report of the Geological and Natural History Survey of Canada new series, vol. i.: A. R. C. Selwyn (Dawson Bros., Montreal).—Negret and Zambra's Encyclopedic Catalogue.—Proceedings of the Royal Physical Society, Session 1885-86 (M'Farlane and Erskine, Edinburgh).—D. Norske Nordhaas-Expedition, 1876-78, XVI. Zoologi, Mollusca, II. H. Friele (Grondahl, Christiania).—Transactions of the Sanitary Institute of Great Britain, vol. vii. 1885-86 (Stanford).—Zeitschrift für Wissenschaftliche Zoologie, xlv. Band, 4 Heft (Engelmann, Leipzig).—Geological Survey of Alabama—On the Warrior Coal-Field: H. McCalley (Montgomery).—Year-book of Photography, 1887 (Piper and Carter).—Anuario de la Oficina Central Meteorológica de Chile, 3er Cuaderno, Mayo y Junio. Fourth Annual Report of the Metropolitan Public Gardens Association.

CONTENTS

	PAGE
Science and the Jubilee	21
Historical Geology. By Prof. A. H. Green	21
Photographs and Descriptions of Wild Animals	22
Our Book Shelf:—	
Bert's "First Year of Scientific Knowledge"	22
Bouinain and Paulus's "La France en Indo-Chine"	22
Feilden's "My African Home"	22
Letters to the Editor:—	
The Coal-Dust Theory.—W. Galloway	22
The Cambridge Cholera Fungus.—Charles Roy	22
An Error in Maxwell's "Electricity and Magnetism."	
Rev. Henry W. Watson	22
The Manipulation of Glass containing Lead.—Prof. W. A. Shenstone	22
Pyrometers and Fusion-Points.—Thos. Andrews	22
Electricity and Clocks.—Prof. Silvanus P. Thompson	22
Barnard's Comet.—T. W. Backhouse	22
Meteor.—J. M. H.	22
Red Sunsets and New Zealand Eruptions.—Lieut. Colonel A. T. Fraser, R.E.	22
Theodor von Oppolzer	22
The Colonial and Indian Exhibition. By John R. Jackson	22
Ipecacuanha Cultivation in India. By W. T. Thiselton Dyer, C.M.G., F.R.S.	22
Sunspot Observations in Hungary. By A. M. Clerke	22
Notes	22
Our Astronomical Column:—	
The Andromedes, November 27, 1886	231
The Reduction of the Positions of Close Polar Stars from one Epoch to another	231
Astronomical Phenomena for the Week 1887	
January 9-15	231
Geographical Notes	231
Tasmanian Fisheries	231
The Forms of Seedlings: the Causes to which they are due. By Sir John Lubbock, Bart., M.P., F.R.S.	231
On the Use and Equipment of Engineering Laboratories. By Prof. Alex. B. W. Kennedy	231
Birds' Nests and Eggs. By H. Seebohm	231
Scientific Serials	231
Societies and Academies	231
Books and Pamphlets Received	24

THURSDAY, JANUARY 13, 1887

SCIENCE AND THE JUBILEE

II.

IN our article last week we referred to two directions in which the Jubilee memorial could in our opinion be made to fulfil functions of the highest importance which none of our existing institutions could take up, and we pointed out that one of them would be almost exclusively scientific.

The fact that so distinguished a man of science as Sir Frederick Abel has been appointed the organising secretary of the new institution amounts almost to an assurance that these possible high purposes will not be lost sight of. Sir Frederick Abel has proved himself to be not only a brilliant and patient investigator of new problems in science, but also one of those men whose indomitable energy and administrative power peculiarly fit him for a post in which sympathy with science in its highest aspects must be associated with a keen knowledge of and interest in affairs.

It is not merely a coincidence, but rather a sign of the times, that this week we refer in our columns to two other apparently distinct subjects, which in fact are most germane to the one we are discussing. The first is an article by Mr. Morris on the botanical federation of the West Indies, and the second is the recently issued Report of the Committee appointed by the Government to consider the question of the national science collections. Mr. Morris's article is connected with the proposed Jubilee memorial in this way: it shows that already, by the nature of things, the West India Islands are associating themselves with the mother country in things botanical, as, according to our view, all our colonies should in things scientific generally. The necessity, the thoroughness, and the economy which obviously must result from such an arrangement are well stated by Mr. Morris, than whom we know no higher authority. It should be a subject of pride to our men of science that, thanks to the broad views taken by three successive Directors of the Royal Gardens, Science is ahead of politics on a line where politics is bound to follow her; for the political federation of the West India Islands is a thing of the not very distant future. This reference to the West Indies induces us, almost compels us, to return for one moment to another matter touched on in our article last week. We then pointed out that topography, geology, and botany would not be the only arts of peace to which we need confine ourselves. Now, we are inclined to believe that any money which might be spent in federating the West Indies meteorologically by means of the telegraph, even if new cables had to be laid here and there, would be saved over and over again in twenty years by the protection afforded to shipping by forecasts during the hurricane season. Now, supposing such a system as this at work in one of the most interesting regions of the world from a meteorological point of view, and controlled, if need be, from the mother country, represented by the Meteorological Council, good would come all round; the Meteorological Council would gain a larger and closer view of the phenomena which it is its duty to study, and the federated colonies would obviously gain by the reduction in the yearly loss of life and capital.

logical Council, good would come all round; the Meteorological Council would gain a larger and closer view of the phenomena which it is its duty to study, and the federated colonies would obviously gain by the reduction in the yearly loss of life and capital.

We now pass to the Report on the National Science Collections. The connection between this Report and the proposal for the Institute can be gathered from the following statements.

We showed in our last article that the Committee appointed by the Prince of Wales were driven to South Kensington for a site by stress of money, even supposing that South Kensington was the worst possible site that could be selected. Our opinion is that South Kensington is the best site that could be selected for any institution which is to be anything more than an expanded Chamber of Commerce or Mart. But, however this may be, the fact remains that the Institute buildings, if erected at all, will be erected at South Kensington. Further the building must have a frontage.

It will be gathered from the Report of the Government Committee on the Science Collections that it is proposed to house them, including the historical and other objects recently transferred from the Patent Museum, in a building to run from Prince's Gate to Queen's Gate, at the back of the Museum of Natural History. Now, why should not the Royal Commissioners and the Government arrange matters so as to enable the Science Museum, which thus must be geographically associated with the Institute, to be commenced at the same time? In this way, it appears to us that the Royal Commissioners would have fully discharged their functions as regards the southern part of the land for which they are trustees, provided always that the Institute is really to promote the progress of science and art.

One word now as to the real place of this Science Museum among our national institutions for the promotion of knowledge. The student of literature in this country—the man who has to make new books, or whose desire it is to obtain any of the knowledge contained in old ones—finds in the British Museum library and reading-room the most magnificent organisation to supply him with what he wants. In this respect the British citizen to-day is as well off as, but perhaps no better off than, the citizen of Alexandria was in olden times; and now, as then, it is conceded that it is the duty and glory of a State which makes any pretence to civilisation to have such an institution as this among its resources. It is one of the arsenals of peace.

Turn to another line of intellectual activity: take the student of the biological sciences. The British Museum of Natural History is a library no longer containing books merely, but things which have to be studied to obtain new knowledge. Here, as among the books, the student is allowed to examine, to study, to collate, and to describe without stint, microscopes and other apparatus being provided for him; facilities are afforded to him in order that he may learn, and that the field of knowledge may be enlarged through his labours.

Yet another region of activity: take Art in all its branches. Our National Gallery and the art collections at the British Museum and South Kensington show that

in past times, at all events, the State has considered it its duty to bring together collections for the benefit of the student, and even for the delight of the eye of the uninformed.

These institutions are not merely depositories for loans, in which the State enables its citizens to be benefited provided only that the process costs nothing, or next to nothing; but fabulous sums have at times been given, and willingly given, by the nation in order that we shall not be behind others in the opportunities afforded of cultivating the arts of peace.

We now come to the newest developments of human activity. We leave the ground common to us and Greece and Rome, and we approach the modern world, the world which is as it is because physics and mechanics and chemistry have been developed since those earlier days to which we have referred. These developments form the glory of our modern civilisation, and are the pith and marrow of our national life.

What do we find in our national collections representing these in this our England, where till a few years ago physics, mechanics, and chemistry had been most, and most successfully, applied?

Nothing, or practically nothing. The State, which has absorbed greedily some two millions nett in patent fees which have come into its coffers in consequence of these developments, has given nothing, or practically nothing, back. It is true that the generosity of private individuals has enabled the nation to possess and exhibit some of the most interesting among the historical apparatus illustrating the applications of those branches of science to which we refer. It is true also that the Science and Art Department has done its best to make bricks without straw, and the state of things is better now than it was ten years ago. We say ten years ago, because it is about that period since the Duke of Devonshire's Commission pointed out in the clearest and most emphatic way this great and damaging gap in our national resources, and pointed out, too, the various evils which would arise from it. Since that time other Committees have reinforced the Commission's suggestions. Those who know best know how well for the country it would be if the modern developments of knowledge were illustrated as well as the older ones. It is true that after ten years the thing has gone so far that a Treasury Committee has been appointed to consider how such a national collection could be housed. But it is not impossible that another ten years may elapse before anything is done, unless some special and extraneous reason be urged for the doing of it.

Then why should not the men of science in this year of Jubilee urge upon the Government that it also should not be lacking in commemorating this year? If the citizens of Greater Britain contribute a quarter or half a million in commemorating the year, why should not the Government contribute some 25,000*l.* (as an instalment of 100,000*l.*, which is all such a Museum need cost) in starting an institution which all students of science or its applications know will be the most important of all in fifty years time, most important, that is, in everything that relates to the development of the resources of Greater Britain?

So much then for what the Government might well do in the year of Jubilee. It remains for us to consider what men of science as such can do. We believe that the keynote of what they can best do was struck by Prof. Huxley as President of the Royal Society. To this matter we shall probably take another opportunity of referring.

MARINE ENGINEERING

Die Schiffsmaschine; ihre Construction Wirkungsweise und Bedienung. Bearbeitet von Carl Busley. (Kiel: Verlag von Lipsius und Tischer, 1886.)

THE concluding volume of this important work on marine engineering equals in merit and style the portion previously published, of which a notice appeared in NATURE, vol. xxix. p. 426. It is a most laborious and well-digested compilation of all that is best worth preserving in relation to the resistance and propulsion of ships. The author with true German industry has sought far and wide for his materials, drawing from the writings of French, German, Dutch, American, and English authorities. But it may be stated with some satisfaction that the most recent and valuable investigations to which reference is made are those of our own countrymen. The labours of the late Mr. Scott Russell, Prof. Rankine, and Mr. W. E. Froude, have given an impulse and direction to the theoretical and experimental investigations of the problems of resistance and propulsion, of which the practical value cannot well be over-estimated. The action of the Admiralty in assisting the late Mr. Froude, and in now establishing, under the able direction of Mr. R. E. Froude, experimental works on an enlarged and permanent basis, has yielded substantial advantages to the Royal Navy, and benefited the science and practice shipbuilding generally. One private firm on the Clyde has, for its own purposes, created a similar experiment establishment; another was established in Holland by the late Chief Constructor, Dr. Tideman; France has done something in the same direction; and Russia and the United States have given attention to the matter. Everywhere it is now recognised that the resistances of full-sized ships may be closely approximated to by means of experiments with models; and in this manner the problems of ever-increasing difficulty incidental to the attainment of higher and yet higher speeds are being dealt with confidently and successfully. Pure theory cannot master these problems, although it has suggested the best experimental procedure. The older theories of resistance summarised by Mr. Busley have given place to the "stream-line" theory, and upon it has been based the "law of comparison" between ships and models independently laid down by the great French teacher, M. Reech, and the late Mr. W. Froude.

Mr. Busley shows full appreciation of the value of modern experimental methods, while he also describes the more or less "rule-of-thumb" methods which formerly prevailed and have still their uses. It is not possible for most shipbuilders and marine engineers to have model experiments for new ships, and they therefore depend largely upon the analysis of the results of speed trials made with other ships. Carefully conducted trials on what

called the "progressive" principle—that is, at a number of different speeds from the maximum speed attainable down to four or five knots per hour—are of the greatest value to future designs of ships and machinery. For a long time they have been made occasionally in the Admiralty practice; but Mr. W. Denny deserves great credit for bringing the system into general use and establishing its practical value. Associating progressive trials with the "law of comparison" for the resistances of ships of different dimensions but similar forms, a designer can feel great confidence of success in most of his practice. If he has the *data* for small ships propelled at relatively high speeds, he has the means of approximating closely to the performances of larger ships up to much higher speeds, and this is of enormous value under present conditions.

Methods of *propulsion* and details of *propellers* occupy a large section of the volume under review. The paddle-wheel, the screw, and the water-jet propeller all receive full discussion in their theoretical and practical aspects. Probably no such summary of facts relating to modern practice has been made before by any writer. Under paddle-wheels, for example, there are descriptions constituting practical data for designing paddles at the *sides* of steamers (the ordinary plan), at the *stern*, as in light-draught river-steamers, and at the *centre*, between twin-hulls, as is the fashion in some American river-steamers. Under the jet-propeller appears a great mass of information as to the fittings and performances of a number of vessels, including the English gunboat *Waterwitch* and Thornycroft's torpedo-boat of recent construction, the German *Hydromotor*, described in NATURE, vol. xxvi. pp. 18 and 247, and a Swedish experimental boat. Naturally the greatest attention is bestowed upon screw-propellers, which are most generally employed. To the theory of the screw-propeller laid down by Rankine, many valuable additions have been made by the Froudes, father and son, Mr. R. Froude being still engaged in the investigation of the subject experimentally. Up to the present, however, it cannot be said that any complete, acceptable theory has been put forward. Experience shows that by the choice of proper screws enormous economies of power or sensible increases in speed may be secured. The first trials of H.M.S. *Iris*, nearly ten years ago, were fortunately most disappointing, for they compelled a close study of the screw question in her case, with the result that the speed was increased from 16½ to 18½ knots per hour simply by a change of screws. Similarly striking results have been obtained in ships and boats of the torpedo flotilla, and in vessels of the mercantile marine. Much yet remains to be done before a satisfactory practice can be insured in choosing a suitable propeller for a ship of novel type or exceptional speed. Probably here also experiment with models of screws will come in to assist full-scale operations. Attempts in that direction have been made for many years past in the Admiralty Experimental Works, but the task is one of great delicacy and difficulty, and is far from having been completed.

Mr. Busley goes over this ground very carefully, and gives practical rules, based on experience for the most part, for fixing the sizes and pitch of screws. One of the best of these is that published by Mr. S. Barnaby and

based on the extensive experiments of the Messrs. Thornycroft, whose success in the construction of exceptionally swift vessels results in part from the close attention given by them to screw-propellers. Mr. Busley has an interesting chapter on the geometry of screw-propellers; and his remarks on the most suitable materials for propellers are important.

The illustrations to this volume are numerous and well executed. The letterpress and general style of production leave nothing to be desired. It may be anticipated that the work now completed will speedily become a standard book of reference for German marine engineers.

W. H. W.

AN ARCTIC PROVINCE

An Arctic Province: Alaska and the Seal Islands. By Henry W. Elliott. Illustrated by many Drawings from Nature, and Maps. (London: Sampson Low and Co. 1886.)

MANY accounts of Alaska and of the wonderful seal-rookeries to be met with on some of the islands in its Arctic seas have been published, but none which have given in so interesting and succinct a manner the history of these far-off northern solitudes as the present volume. The author's personal knowledge of these regions, and his intimate acquaintance with the very numerous writings of others on the subject, have enabled him to write a volume that will long remain a standard one; while the illustrations from his own pencil are full of life and vigour, and add immensely to the value of the work.

The volume contains, of course, an account of the discovery, in 1741, of the Alaskan Province by Veit Bering, and of his shipwreck and sad death. The survivors spread the news of the wealth of fur and ivory that was to be found there, and soon came the rush of Russian traders. Fierce struggles took place between the individual traders and the natives, and much blood was shed, but at last a Russian American Company was established with supreme powers; and for a time, under the supervision of that very remarkable man, Governor Alexander Baranov, it flourished. Its decadence, however, proved to be as rapid as its rise; and after various vicissitudes, lasting during the first half of the present century, the district was, in 1867, acquired by the United States Government by negotiation from Russia. The name of Bering was given to the Straits connecting the Pacific with the Arctic Ocean by our Capt. Cook.

The features of the Sitkan region are treated of in a special chapter. Were it not for the damp and extensive rainfall, the climate would be endurable. A great deal of the scenery is most picturesque. The aboriginal life of the Sitkans is glanced at, but this portion of the work contains nothing very new or profound, as the author does not profess to know as much about the natural history of the human race as about that of the marine mammalia. In separate chapters, the alpine zone of Mount St. Elias, Cook's Inlet and its people, and the great Island of Kodiak, are treated of. The quest of the otter has a whole chapter devoted to it. Few ladies realise how many men are engaged in deeds of hazardous perit

to obtain for them the ebony sea-otter trimming to their dainty sealskin sacques. These otters would seem to be on the eve of extirpation, so ruthlessly are they hunted and destroyed. All the world's supply comes from the North Pacific and Bering Sea. The chase and capture of the otter furnish the only employment possible for several thousands of the semi-civilised natives of Alaska, so that the destruction of this trade would be very disastrous to the hunters.

The chapter on the great Aleutian Chain tells us of the volcanic island of Oonimak, the cone-shaped crater of Shishaldin, and Oonalashka Island, with its smoking volcano of Makooshin. The chief interest of the volume centres, however, in the chapters relating to the wonderful Seal Islands, and on the modes of capture of the seals, and on their habits. The Pribylov Islands of Bering Sea were discovered just a century ago by Pribylov, the commander of a Russian sloop. He called them Subov Islands, but the Russians seem unanimously to have elected to call them after their discoverer. Sketch-maps of St. Paul and St. George are given, and there are very full and minute details of each, and of the few neighbouring rocky islets, including Walrus Island, which would appear to teem during the summer season with bird life. The history of the progress made from the earliest to the present times by the various villages on these islands is also given, and the writer alludes to the fact that the natives may be expected in the end to adopt the English rather than the Russian tongue.

The longest chapter in the volume is that devoted to the history of the habits and manners of the fur seal, which in myriads frequents these islands, and this chapter will well deserve perusal. From the economic point of view the author seems satisfied that, should the laws and regulations made by the United States Government be acted on in the future as they are now, 100,000 male seals under the age of five years and above the age of one year may be safely taken each year without the slightest injury to the regular birth-rate, or the natural increase thereof. Calculating the pups at 1,000,000 a year, of this number half are males. Of these, say one-half are lost during their first year of infancy. Owing to the polygamous habits of the males and the great age to which the adult males live, not one-fifteenth of this number is ever needed on the rookeries, and on this showing it is better that they should be killed to supply the fur trade with their skins, than that they should be allowed to live to consume millions of cod and wolf-fish.

The sea-lion (*Eumetopias stelleri*) is also a characteristic pinniped of these islands, but, having no fur, is for its naked skin valuable only to the natives. Mr. Elliott gives a graphic account of the habits of these enormous beasts, the adult males of which will measure 10 to 11 feet in length, with a girth of 8 to 9 feet around the chest and shoulders.

In the chapter on "Innuite Life and Land" a good deal of information is given as to an immense northern area, where the dwelling-houses are approached by underground passages, and where moose and reindeer abound. Still more northern wilds are described in a chapter on "Lonely Northern Wastes," while one on "Walrus and Walrus-hunting" concludes the volume. These morse are perhaps of all animals the most difficult subjects that

an artist can find to reproduce from life. There are no angles or elbows to seize hold of; the outlines of the body and limbs are all rounded, free, and flowing. Some life studies of the young made by artists no doubt are good; but, until the appearance of Mr. Elliott's drawings of the fully mature animal, we had nothing in the way of portraits much better than caricatures of these strange beasts.

One interesting fact is mentioned in connection with Norton's Sound: on its shores are many low clayey bluffs, which, as they are annually undermined by the surf and chiselled by frost, fall in heavy masses on the beach, thereby exposing deposits of the bones and tusks which apparently belong to the mammoth. From time immemorial the Innuits have used this ivory for tipping their spears, lances, and arrows.

The illustrations, as we have before said, form a very prominent feature in this volume, which we commend to the reader's notice as both interesting and pleasant reading.

ANTIQUITIES OF SPAIN AND PORTUGAL

Les Ages préhistoriques de l'Espagne et du Portugal.

Par M. Émile Cartailhac. Imperial 8vo, with 450 cuts and 4 plates. (Paris: Reinwald, 1886.)

ANTHROPOLOGISTS and archæologists will gladly hail this handsome volume from the pen of the editor of the "Matériaux pour l'Histoire primitive de l'Homme." It relates to two countries of the primæval antiquities of which but little is generally known, and the literature concerning whose early relics has hitherto been but scanty. It is true that we have various essays on the prehistoric antiquities of Portugal by Carlos Ribeiro, Delgado, and the Geological Commission; while those of Spain have been treated of by Signor Tubino and Dr. Vilanova y Piera, and, so far as Andalusia is concerned, by Signor Gongora y Martinez; and, as to some of the caves, by Mr. MacPherson and the late Mr. Busk. The work, however, of M. Cartailhac is far more general and comprehensive than that of any previous author. It will be well perhaps to give some sort of summary of the contents of his book.

After some preliminary considerations, he attacks the subject of the quartzite and flint flakes, which have been considered by some to prove the existence of man in Portugal in Tertiary times, but, after a fair examination of the facts, not only in Portugal but in France, he regards the proofs as not sufficiently convincing, and remarks that unexceptionable traces of Tertiary man remain still to be discovered. Probably not a few of those who visited the plain of Otta on the occasion of the Prehistoric Congress at Lisbon in 1880 will agree in this verdict of M. Cartailhac.

The existence of Quaternary man in Spain has evidence in its favour of a far more satisfactory character. Sections of the remarkable valley-gravel deposits of the Manzanares at San Isidro, near Madrid, are given, as well as cuts of some of the implements there found, which, so far as form and material are concerned, might have come from the valley of the Somme. Some other implements of the same class have also been found in Portugal. Instruments both in flint and bone similar to

those from the caves of the Dordogne, including needles and the peculiar barbed harpoons, have been found in caverns in the north of Spain; but at present no remains of reindeer have been found associated with them. Notwithstanding this fact, the caves would appear to be of about the same age as those of La Madelaine.

The remains of Neolithic age found within the Iberian Peninsula form the subject of the next portion of M. Cartailhac's book. Foremost among these he places the shell-mounds, which in some parts of the valley of the Tagus attain to considerable dimensions. Those at Mugem were visited by many of the members of the Prehistoric Congress, and it is somewhat remarkable that the mollusks, of the shells of which the *Kjökken möddings* principally consist, no longer are occupants of the Tagus near the mounds, but are only to be found much lower down the river, where the waters are more salt.

The principal worked flints that occur in the mounds have much the appearance of having been chisel-shaped arrow-points. Curiously enough, the mound which was thrown up as a refuse-heap by the living has been also utilised as a cemetery for the dead—intramural interments having probably not been forbidden. Some of the caves have furnished remains of pottery covered with a raised reticulated pattern, as well as objects in stone, bone, and shell. Many of them have also been the site of Neolithic interments, and the Casa da Moura has furnished one of those remarkable skulls on which trepanation has been begun but not finished. Large flat lance or javelin points of flint were found in this cave, having both faces polished after the manner of some Irish specimens. Indeed, there is a considerable resemblance in the *façies* of the flint antiquities of Portugal with what prevails in Ireland, and this somewhat corroborates the view of there having been in ancient times Iberian settlers on the shores of Hibernia. The resemblance between some of the bronze implements of the two countries is also worthy of notice. A number of ornamented pendants of slate, some of peculiar plume-like form, have also been found in the caves, the devices upon them being formed of notched and plain triangles and zigzags of almost identical character with the ornaments upon some of the Irish bronze celts.

Some imitations of stone or possibly bronze celts mounted on handles, as adzes, are very remarkable. They are carved in marble or soft stone, so that they could hardly have been used as cutting tools, but they may have had some symbolical meaning. The most interesting of the burial-places are the *Antas* or dolmens, of which a considerable number exists, some of large dimensions. In their general character they much resemble the megalithic monuments of France and Britain. Chambered barrows and *allées couvertes* are also known. In them have been found arrow-heads not unlike some of the Danish forms, with very long curved barbs and no central stem, as well as others of more simple triangular forms. In the dolmens also some of the chisel-shaped tips like those from the shell-mounds have occurred.

Traces of the old copper-mining industry of Spain have been found in the shape of large mauls of stone, with a groove or channel around them destined to receive the with which formed the handle. The bronze swords and daggers much resemble those of Southern France and

Italy, while the flat celts of bronze and of copper are like those of Ireland. The palstaves, however, or flanged hatchets, have frequently a loop on either side, instead of one only as is commonly the case in most European countries. The socketed celts have also frequently two loops, a peculiarity which is more common in parts of Russia than in other countries of Europe.

Coming down to what our author calls protohistoric times, various weapons and ornaments of the Early Iron period are figured, as well as some slabs of stone inscribed with what are apparently Phœnician letters. Of these, however, no interpretation is given. The concluding chapter is devoted to anthropological remarks, and full particulars are given of a series of skulls from some of the caves, together with photographic illustrations.

The preface to the work is from the pen of M. A. de Quatrefages, who, however, goes far in advance of M. Cartailhac in his acceptance of the discoveries of Tertiary man.

Those who are interested in the early history of mankind, and in comparative archæology in general, will do well to consult M. Cartailhac's book, in which they will find many other points of interest besides those which have been summarised in this brief and imperfect notice.

J. E.

OUR BOOK SHELF

Educational Exhibits and Conventions at the World's Industrial and Cotton Centennial Exposition, New Orleans, 1884-85. Special Report by the Bureau of Education. Part I. Catalogue of Exhibits. (Washington: Government Printing Office, 1886.)

THE extensive collection of everything connected with education which was to be made at the Exhibition held at New Orleans, and also the remarkable success of the United States Bureau in obtaining and dispersing educational information, have been referred to more than once in this journal. The Hon. John Eaton, Commissioner of Education, accepted the post of Superintendent, and the Government encouraged him to do everything in his power for the success of the undertaking; and this not unwisely, for the excellence or otherwise of the education exhibits of any locality is regarded as an attraction or warning by the most valued class of emigrants. Accordingly he made use of a visit to France, Belgium, and England to gain exhibitors, and in France he was very successful. At the Exposition he addressed large assemblies of teachers, and to himself as well as to the Bureau which he represented were awarded "Grand Diplomas of Honour" for valuable contributions. An illustrated catalogue of apparatus lent by the Bureau for experiments in the leading departments of physics is given in the Report. Among these the electrical instruments, as also a solar microscope, were particularly attractive at the Exhibition. Each State was urged to send specimens of the work, as also any objects which illustrated the growth and present condition, of its University; of its normal schools; of its schools of each grade; the work, on uniform paper, of children in every subject and standard; photographs and ground-plans of its best schools; school literature published in the State; technical work also, and both the methods and the performances of special schools, as for the blind, &c. Though not many States responded fully to this wide invitation, yet the fact that over nine thousand specimens (many of them volumes of school-work) were exhibited by Ohio alone, with regrets that a more complete set from all cities could not be got together, shows that a worthy response was made in some cases.

As much school *matériel* was exhibited as manufacturers could be induced by a circular from the Bureau to show gratis, and naturally the smaller articles were profusely sent in. Where specimens were deficient, as in the case of heavier furniture, heating and ventilating apparatus, &c., they were not unfrequently purchased and supplied by the Bureau, as was also a fully equipped laboratory arranged so as to economise space in schools.

Among the objects supplied by American exhibitors, were statistical charts of every educational subject. Manual training, a matter of special value in the Southern States, was carried on in the building, and the boys' products attracted particular interest. An effort was made that household industry, in its four departments of nursery, kindergarten, kitchen-garden, school of cookery, with sewing, &c., should be fully illustrated, but the first and fourth were not found practicable. A model kindergarten, in which sixteen children were being taught by means of choice objects in each important department of knowledge, instead of with books, and so furnished that it looked the brightest and pleasantest room in the building, was exhibited by the Commissioner; and kitchen-"garden" instruction, *i.e.* in domestic servants' work, was given on four afternoons a week during March and April.

Gymnastics and physical education with apparatus for exercises of various degrees of severity were shown, with lessons and illustrations several times a day. Library appliances, as well as every description of educational works, were largely exhibited in this land of the free library. Specimens of work from reformatory schools, boots, brushes, wood-work, and clothing made by boys had their place beside photographs, publications, kindergarten work, sewing and fancy work done by girls. Washington exhibited a collection of apparatus for showing the simpler scientific experiments, made by public school pupils, the illustrations of which, given in the Report, show how brain and fingers have worked together there. From the same city also was sent a miniature copy of a school recently erected there, set up as a "model" school in both senses of the word, but plans of it are not given in this Report.

One of the most important exhibitors was Prof. Ward, of Rochester, N.Y., of whose museum of natural history, though it comes under the head of commercial department, a full-page ground-plan is given. It consists of a well-balanced collection of specimens of recent stuffed and extinct restored animals; specimens of minerals found in the United States; and models of the most important geological features from all the best known parts of the globe.

An item worth notice in grammar-school, *i.e.* secondary education, is a collection of maps made by the boys under the master's instructions, showing countries in relief, with their natural productions denoted by little pieces of minerals, or grains of rice or corn.

A Text-book of Pathological Anatomy and Pathogenesis. By E. Ziegler. Translated and edited by Donald MacAlister, M.A., M.D. Part II. Special Pathological Anatomy, Sections IX-XII. (London: Macmillan & Co., 1886.)

THIS, the third volume of the work, fully justifies the high opinion we expressed of its predecessors. In point of excellence of treatment, lucidity of description, general arrangement of the subject, fullness of detail, and abundance of excellent illustrations, it gives to the work as a whole a completeness and thoroughness which, we believe, have not been attained by any previous work, in English or foreign tongues. The pathology of the urinary organs is described in Section IX. (Chapters lxxiv.-lxxv.); Section X. (Chapters lxxvi.-xc.) treats of the diseases of the respiratory organs, the thyroid and thymus glands; Sections XI. and XII. (Chapters xci.-ciii.) of the pathology of the central and peripheral nervous system. If amongst

all that is good in the volume we had to choose what is best, we should name the chapters on the pathology of the lung and central nervous system. The classification and the detailed description of the morbid changes of these two organs are most excellent in every respect.

As in the previous volumes, so also in this, a carefully collected summary of the more recent references is given in connection with each subject. A useful index, both of the names of authors cited and of the subjects treated, concludes the volume. The illustrations are copious, representative, and well-chosen. Those illustrating the pathology of the kidney and respiratory organs are in point of printing far above the illustrations one is accustomed to see in English text-books.

As a text-book for students, and a book of reference to workers in pathological anatomy, it is unequalled.

E. KLEIN

Hours with a Three-Inch Telescope. By Capt. Wm. Noble. F.R.A.S., F.R.M.S. (London: Longmans, Green, and Co., 1886.)

THE present volume, which is to a great extent a reprint, is designed for the help and instruction of those who, possessing a small telescope, are at a loss as to how best to use it. On the whole, the book well fulfils its author's purpose. Clear, simple, straightforward, and practical, it gives just that elementary instruction in the use of a small instrument which so many require, and which has hitherto been provided for them nowhere else, and it will undoubtedly serve as a good introduction to more advanced books, such as Webb's "Celestial Objects." Occasionally a rash statement needing correction is met with—*e.g.* the footnote on p. 84—but for the most part the book has been carefully written. It is illustrated by a good map of the moon, and by over one hundred woodcuts. The latter are clear, but possess no special merit otherwise; indeed, the representations of Jupiter and Saturn are poor; but, despite a few such slight blemishes in detail, the volume cannot fail to be useful.

Lunar Science. By the Rev. Timothy Harley, F.R.A.S., Author of "Moon-Lore," &c. (London: Swan Sonnenschein, Lowrey, and Co., 1886.)

THIS little book contains a clear and interesting account of the essential facts known about the moon in ancient and modern times. Having referred, in the introduction, to some of the more general aspects of his subject, the author proceeds to discuss, in separate chapters, the moon's distance, its size, shape, substance, formation, condition, surface, and motions. In the chapter on the moon's motions, the writer has a good deal to say about the use which has been made of the moon as the measurer of time. "The etymology of the word," he says, "is full of meaning. 'Moon' and 'Month' are twins, whose parentage was Sanskrit." The truth, of course, is, not that "their parentage was Sanskrit," but that "Moon" and "Month" and the Sanskrit word "Mās," the measurer, have the same root. As kindred words appear in several other Aryan languages, it may be assumed that the moon serves as a chronometer to the Aryans before they dispersed. The Athenians began their year upon the first new moon after the summer solstice, and this year they divided into twelve months, containing alternately thirty and twenty-nine days. Each month, again, was divided into three decades. The Romans also divided their months into three parts, and, says Mr. Harley, "the first day called *Calenda*, from an old verb meaning 'to call,' because a pontiff then made proclamation to the people that it was new moon. These *Calenda* have given us our word 'calendar.'" Among the North American Indians, time is computed by moons or months, and they talk of the "beaver moon," the "buck moon," the "buffalo moon," and so on, exactly as the Greeks used to talk the "planting moon," the "reaping moon," the "wine moon" and the like.

LETTERS TO THE EDITOR

[The Editor does not hold himself responsible for opinions expressed by his correspondents. Neither can he undertake to return, or to correspond with the writers of, rejected manuscripts. No notice is taken of anonymous communications.]

[The Editor urgently requests correspondents to keep their letters as short as possible. The pressure on his space is so great that it is impossible otherwise to insure the appearance even of communications containing interesting and novel facts.]

Mr. Wallace on Physiological Selection

IN the September issue of the *Fortnightly Review*, Mr. A. R. Wallace published an article criticising the theory of physiological selection, and subsequently published a letter in *NATURE* conveying the substance of that criticism. Having now replied to all my critics in the current issue of the *Nineteenth Century*, I will here give the substance of my answer to Mr. Wallace.

"(1) Mr. Romanes makes a great deal of the alleged 'inutility of specific characters,' and founds upon it his extraordinary statement that, during his whole life, Darwin was mistaken in supposing his theory to be 'a theory of the origin of species,' and that all Darwinians who have believed it to be so have blindly fallen into the same error. I allege, on the contrary, that there is no proof worthy of the name that specific characters are usually useless, and I adduce a considerable series of facts tending to prove their general utility."

Now, in this matter I not only "allege," but prove, that I have upon my side Darwin himself ("Origin of Species," pp. 171, 176, 421; "Descent of Man," p. 61) and more or less "all Darwinians." Moreover, I have shown that the arguments whereby Mr. Wallace seeks to justify his own individual views are quite unworthy of their distinguished author.

"(2) In support of his view as to the swamping effects of intercrossing, Mr. Romanes objects to the assumption of Darwin, 'that the same variation occurs simultaneously in a number of individuals,' adding: 'Of course, if this assumption were granted, there would be an end of the present difficulty'; and his whole argument on this branch of the question rests on the assumption being false. I adduce evidence—copious evidence—that the supposed assumption represents a fact, which is now one of the best-established facts of natural history."

The "copious evidence" here alluded to consists merely in a reference to the well-known observations of Mr. J. A. Allen upon the kinds and degrees of individual variation exhibited by certain species of American birds. I am able to show that none of these observations have any bearing upon the "difficulty" in question; and that so far from the "assumption" in question representing "a fact which is now one of the best-established facts of natural history," even so accomplished an ornithologist as Mr. Seebohm displays so sublime an ignorance of its establishment as to affirm, in his criticism of my paper, that "it is seldom that the difficulties of natural selection from fortuitous variations have been so clearly, so impartially, but so candidly set forth." And he adds, *speaking specially of birds*, "So far as is known, no species has ever been differentiated without the aid of geographical isolation," *i.e.* without some check upon free intercrossing.

"(3) Mr. Romanes states, as the special feature of his physiological varieties, that 'they cannot escape the preserving agency of physiological selection.' He gives no particle of proof of this, while I show that, on the contrary, it is hardly possible for them to survive to a second or third generation."

The objection here is that the chances must be greatly against the "physiological complements" (or the suitably varied individuals of opposite sexes) happening to mate, and, even if they did, that their progeny should likewise do so often enough to start a permanent variety.

In answer to this objection I first of all adopt my critic's assumption, namely, that in all cases physiological selection must depend on the chance unions of physiological complements, relatively very few in number, and scattered over areas occupied by large species. Upon this assumption I agree that the sexual variation, "whenever it occurs, is almost certain to die out immediately," after which the paper proceeds as follows:—

"Granting it is shown that the union of these physiological varieties of opposite sexes is a matter of enormously rare occurrence, is it not also true that the origin of a new species is an enormously rare event? Not a few existing species have remained unchanged from remote geological time; the life of all species

is incalculably long as compared with that of their constituent individuals; and in every generation of individuals there are, in the case of most species, millions of fertile unions. Therefore, so far as we can form any estimate on a subject where all proportion seems to fail, we may safely conclude that the ratio between the number of species which have appeared upon this earth, and the number of fertile unions between their constituent individuals, can only be represented by unity to billions.

"In view of this fact I am not afraid of any calculation that can be made, in order to show how many chances there are against the confluence of those conditions on the occurrence of which my theory supposes the origin of a species to depend. According to Mr. Wallace's estimate, the chances against the suitable mating of these physiological varieties 'may be any number of thousands to one'; so that, in view of the considerations above given, and the large number of species existing at any one time, we might conclude that Mr. Wallace supposes the birth of a new species to be an event of almost daily occurrence. Therefore, looking to what we all know are the real facts of the case, even if it were true that whenever one of these physiological varieties occurs, 'it is almost certain to die out,' this almost may be here quite sufficient for all that is required. Thus, upon the whole, and under my temporary acceptance of Mr. Wallace's assumptions, I confess it appears to me a somewhat feeble criticism to represent that the conditions which my theory requires for the origin of a new species are probably about as rare in their occurrence as is the result which they are supposed to produce.

"So much, then, for my first answer. My second answer simply is that from its beginning to its end this criticism is wholly in the air. Hitherto I have been considering his assumptions merely for the sake of argument. But they are not my assumptions; they form no part of my theory; and, therefore, I repudiate them *in toto*. The paper which Mr. Wallace is criticising clearly and repeatedly sets forth that I do not suppose the mating of physiological varieties to be wholly a matter of chance. Whether or not it is a matter of chance will depend on the causes which determine the variation. When these causes are of a kind which act simultaneously on many, on most, or even on all individuals occupying the same area, the element of chance is proportionally excluded. One very obvious, and probably frequent, instance of what may be termed collective variation in the reproductive system—or a variation due to a common cause acting on many individuals simultaneously—is actually quoted from my paper by Mr. Wallace himself, namely, changes in the season of flowering or of pairing, which insure that any section of a species so affected shall be fertile only within itself. Collective variation of this kind may be directly due to the incidence of some common cause, such as changed conditions of life with respect to food, climate, station, &c.; or, as in the case of bud-variation, it may be due to a single 'sport' affecting all the blossoms growing upon the same branch. But besides such direct action of a common cause, it is easy to see that natural selection, use and disuse, &c., by operating in the production of organic changes elsewhere, may not infrequently react on the sexual system indirectly, and so induce the sexual change required in a number of individuals simultaneously. All the parts of an organism are so intimately tied together, and the reproductive system in particular is known to be so extraordinarily sensitive to slight changes in the conditions of life, or to slight disturbances of the organic system generally, that in their work of adapting organisms to changes of their environment all causes of an 'equilibrating' kind must be calculated more or less frequently to affect the reproductive system in the way required.

"If I have succeeded in making myself intelligible, it will have been seen that Mr. Wallace's objection to my theory admits of a twofold answer. In the first place, it is impossible for him to 'show' that the origin of a species is any more frequent than it ought to be, even upon the assumption which he has imputed to me—namely, that such origin is always due to the chance mating of more or less extremely rare varieties. And, in the next place, this assumption on his part is wholly gratuitous—or rather, I should say, directly opposed both to my own statements and to all the probabilities of the case.

"From which it is easy to perceive the inevitable inference, or, if not, by stating it I will furnish a cue to future critics. *The real difficulty against my theory is precisely the opposite of that which Mr. Wallace has advanced.* This real difficulty is that the differentiation of specific types has not been of nearly so frequent

occurrence as upon the theory of physiological selection we should have antecedently expected. Looking to the great sensitiveness of the reproductive system, to the many and the varied causes which affect it, to the frequency with which these causes must have been encountered under Nature, to the fact that whenever a collective variation occurs of the kind which induces physiological selection it must almost certainly leave a new species to record the fact—looking to all these things, the only real difficulty is to explain why, if physiological selection has ever acted at all, it should only have done so at such comparatively rare intervals, and therefore have produced such a comparatively small measure of result. If my critics had adopted this line of argument I should have experienced more difficulty in meeting them. But, as the case now stands, it seems enough to remark that I do not know of any way in which an adverse criticism admits of being more thoroughly exploded, than by showing that the difficulty which it undertakes to present is the precise opposite of the one with which an author is in his own mind, and at that very time, contending.

"Seeing how remarkable has been the misunderstanding displayed by such competent readers as Mr. Wallace and Mr. Seebohm—a misunderstanding on which they both found their only objection to my theory—I should have been compelled to suppose that my paper failed in clearness of expression, were it not that (as above shown) they have disregarded the literal construction of my sentences. Nevertheless, it is probable enough that I may not have sufficiently guarded against a misunderstanding which it never occurred to me that any one was likely to make. For I supposed that all readers would have perceived at least that the main feature of the theory is what my paper states it to be—namely, that sterility with parent forms is one of the *conditions*, and not always one of the *results*, of specific differentiation. But, if so, is it not evident that all causes which induce sterility with parent forms are comprised by the theory, whether these causes happen to affect a few individuals sporadically, a number of individuals simultaneously, or even the majority of an entire species?"

GEORGE J. ROMANES

Meteor of December 28, 1886

THE meteor referred to by your correspondent "J. M. H." (*NATURE*, January 6, p. 224) was also observed at Bristol at 10h. 28m. The path was from $95^{\circ} + 9\frac{1}{2}^{\circ}$ to $106\frac{1}{2}^{\circ} - 6^{\circ}$. A train of sparks was thrown off from the nucleus as it slowly fell.

Comparing the apparent course of the meteor as recorded at Sidmouth and Bristol, it is evident that its radiant-point was at about $77^{\circ} + 30'$, near β Tauri. It belonged to a shower which appears to have a very extended duration, and has been specially referred to, with diagrams, in *NATURE*, vol. xxxi. p. 463.

This recent meteor affords unmistakable proof that the radiant near β Tauri continues active until the end of the year. The relative paths at Sidmouth and Bristol show that the meteor was about 97 statute miles high at its first appearance over a point in the English Channel some 28 miles off the Isle of Wight. Moving with a very slight inclination west of north, it disappeared 10 miles south-west of Niton, Isle of Wight, when 39 miles high. It traversed a path of 62 miles at an inclination of 69° to the earth's surface.

The duration of the meteor was about three seconds, so that its velocity appears to have exceeded 20 miles per second, which is greater than that of a body moving in a parabola, though the difference may quite possibly have been induced by observational errors. As regards visible effect, the meteor can lay no claim to the dignity of a fire-ball, but it is one of considerable interest as belonging to the remarkable display of β Taurids.

Bristol, January 7

W. F. DENNING

The Production of Ozone

I SHALL be much obliged if you can inform me through your paper—

(1) What apparatus would be most conveniently and easily worked by ordinary persons for the production of ozone in a room? I have tried a four-cell Smee's battery with a Siemens' ozone tube. This produces the required quantity of ozone, and works well in the hands of people used to scientific apparatus, but the general manipulation (especially as regards keeping the battery in working order) is above most people.

(2) Is there any battery you know that would give good

results and be easily worked by people wholly unused to tific apparatus (domestic servants for instance)? The quantity required is what would keep the air of an ordinary sitting-room, say $18 \times 16 \times 11$ feet so charged, that ozone would be always just sensible to the smell.

I see by the advertisements of the hotels in the Engadine that the air in their corridors is kept constantly ozonised. (3) Could they adapt their electric light dynamos for this purpose (4) If so, how?

I may say I have no "trade purpose" in making these queries. I am a sufferer from phthisis, and find relief in the inhalation of ozone, but I want an apparatus that I could leave to my servants to manage.

W. H.

"Brading," Madeira Road, Bournemouth

JOHN ARTHUR PHILLIPS, F.R.S.

BY the sudden death of this chemist and metallurgist on the 5th inst. geology loses one of its ablest leaders in a department where the labourers are not very numerous here, and at the same time one of the kindliest and most helpful among the students of science. Mr. Phillips was born in Cornwall, and among the metalliferous rocks of that county began the scientific researches which he has since prosecuted with so much success. Having early shown his taste for mining and metallurgy, he was sent to obtain his training in these subjects at the *École des Mines* of Paris. As far back as 1841 he began to contribute papers to the scientific journals. His early essays were almost wholly devoted to chemical and metallurgical subjects. His studies among the Californian gold-fields, however, led him to investigate wider questions in physical geology. By degrees he turned into the domain of petrography, and for the last sixteen years it has been mainly in that branch of science that his original researches have been carried on. His papers on the eruptive rocks the south-west of England are admirable illustrations of the value of the union of chemical and mineralogical qualifications in petrographical inquiry. Most of his time during the last two or three years had been devoted to the production of large and important treatises. Of these his volume on "Ore Deposits," published in 1884, has taken its place as a standard English work of reference. At the time of his death he was busy with the preparation of a new edition and expansion of a work on "Metallurgy," which he had published when still a young man. In this task he had associated Mr. Bauerman with himself, whose competent hands the volume is sure to see the light in a form worthy of its author's reputation. Those who were personally acquainted with Mr. Phillips, while they lament the loss to science which his sudden death has inflicted, mourn still more the extinction of a life singular in its simplicity, earnestness, and kindliness. He was a large-hearted and open-handed man, fond of taking every chance that came in his way of doing a good deed and helping every one to whom his help could be service.

BOTANICAL FEDERATION IN THE WEST INDIES

IN the nearest of our tropical colonial possessions, which comprise the group of islands generally known as the West Indies, the dominant industry for the last hundred years has been that of the sugar-cane. Sugar and rum are indissolubly connected with these islands, and under the circumstances which existed fifty years ago there is no doubt that lowlands in the West Indies were better suited for the remunerative culture and growth of the sugar-cane than any other plant. Owing to a variety of causes, among which the abolition of slavery and the extension of sugar plantations in other lands are the chief, sugar-growing in the West Indies has suffered numerous reverses of fortune. Latterly, the difficulties of pi-

have been greatly increased by the improved production of beet-sugar in Europe.

The chief sugar islands at present are Barbados, Antigua, St. Vincent, Trinidad, St. Lucia, and Tobago. At Jamaica, sugar and rum are still the staple industries, and form 39 per cent. of the exports, the balance being made up by other industries, such as coffee, fruit, and dye-woods. At Trinidad cacao is largely grown, and the export value of this article is nearly two-thirds that of sugar. Grenada, once a large sugar-growing colony, is now almost entirely devoted to cacao. Montserrat is becoming noted for its lime plantations, and exports of lime-juice; while Dominica exports concentrated lime-juice, cacao, cocoanuts, and tropical fruits. The Bahamas have a large tropical fruit trade with America, supplemented by the export of sponges, to the value of £60,000 annually. In spite of these smaller industries, however, there is no doubt that the chief business of the West Indies is still that of sugar. A capital of something like fifty millions sterling is invested in it, and the people are naturally reluctant to relinquish an industry which has, in the course of a century, become thoroughly established, and which is familiar in its details to all classes of the community. But, after all, it is impossible to overcome the logic of facts: and it is admitted on all sides that sugar, under present circumstances, can with difficulty be grown and manufactured to pay a profit. Hence it is not surprising that there is a strong desire to enter upon other cultivations; and it is well for the future prosperity of the West Indies that this should be so. The depression in the past and the comparative poverty of the present are no doubt due to the exclusive cultivation of one plant; for under such circumstances, when the sugar-market is depressed, everything is depressed. If improvements in cultivation were adopted, and if such high scientific skill as is applied to the manufacture of beet-sugar were applied to the manufacture of cane-sugar, it is the opinion of many that the planters would again become prosperous. But something more is necessary. With the exception of two islands in the whole group—namely, Antigua and Barbados—it is estimated that more than one-half of the actual surface of the West Indian Islands is suitable for other cultivations than sugar-cane. This being so, the people injure their best interests by neglecting the resources at their disposal.

In purely sugar islands, such as Barbados and Antigua, permanent improvement is to be sought in more economic and improved systems of cultivation, added to which there should be a concentration of all purely manufacturing processes under what is known as the *Usine* system. This latter system is already in existence at Trinidad, St. Lucia, British Guiana, and in the French island of Martinique; and it is proved beyond question that where the manufacture of sugar is treated as a highly specialised industry, finer and better qualities are produced, and the expenses are considerably diminished. Planters are therefore recommended to confine themselves as much as possible to the cultural operations of a sugar estate. Under such a division of labour there would follow a more careful trial of different varieties of the sugar-cane, adapted to the different soils, a more scientific application of special manures, and such general regulation of all cultural operations as would produce canes of the highest saccharine richness. In Barbados, Trinidad, and Jamaica, there are already Government analytical chemists, who are qualified to give valuable information to planters as regards soils and manures; and from a report recently prepared at Barbados by Prof. Harrison it is evident that much good would result from a larger utilisation of chemical knowledge as applied to sugar cultivation, both in the interest of the individual and of the general community.

During the last five or six years efforts have been made to increase the efficiency of West Indian industries by a wider and more general application of scientific

methods not only to the sugar-cane but to all other plants which may be found suitable to the circumstances of the several islands. Hitherto two botanical establishments have been maintained for the West Indies—one at Jamaica and the other at Trinidad. From these centres, but especially from that of Jamaica, economic plants and information by means of annual reports and other publications have been regularly furnished, and such agencies have greatly assisted in enlarging the scope of experimental culture.

In the Report of the Royal (West Indian Finance) Commission, appointed in 1883, it was stated that there was a growing inclination on the part of the planters in other West Indian colonies to apply for seeds and plants to the Botanical Establishment in Jamaica, which could supply each island with what it required in the most economical manner. Sir Joseph Hooker, commenting on this report, expressed the opinion that there could be no doubt that the future prosperity of the West Indies would be largely affected by the extension to other islands, unprovided with any kind of botanical establishment, of the operations so successfully pursued in Jamaica. And it was suggested by Mr. Thiselton Dyer that, in addition to the distribution of plants, there might be organised a regular system of botanical bulletins, containing practical hints as to the treatment of economic plants, and the conditions under which they might be best utilised as objects of remunerative industry.

At the instance of the Secretary of State for the Colonies, it was ultimately decided that the whole of the West India Islands should be asked to co-operate in a systematic endeavour to promote and extend the cultivation of economic plants, and thus to develop more fully than heretofore their natural resources. This proposition was duly laid before the Governments of Barbados, the two groups of the Leeward and Windward Islands, and the colony of British Honduras. On account of the want of direct and regular communication, it was found impossible to include the Bahamas, while British Guiana is already supplied with its own botanic garden. The conditions on which the islands lying within the West India group were asked to join in this industrial federation were, first, the provision of an annual grant for the maintenance of a local station to discharge the functions of a scientific outpost and a nursery; and secondly, the contribution of small sums towards the support of operations at the central establishment. These small sums were intended to cover the special expenses incurred in behalf of each island in maintaining a depot for seeds and plants, and to pay the cost of publishing the botanical bulletins, which were intended to form an important feature in the scheme. The Legislative Council of Jamaica has recently expressed its willingness to give effect to the principle of the scheme as regards making the Botanical Establishment in that colony one of the central points of action; and it is anticipated that, while granting valuable aid to the smaller islands, Jamaica itself will derive, both directly and indirectly, considerable benefit from such vigorous and systematic working as would naturally arise in its own area, as well as from a larger interchange of plants and seeds with the neighbouring islands.

It is hardly necessary to observe that, in reply to the Secretary of State's despatch, the smaller islands were not slow to express their desire to be included in the scheme, and steps were taken in several to give effect to this desire by the establishment of local stations. Barbados was fortunate in possessing favourable means for starting a botanical station in connection with the Boys' Reformatory at Dods, where land was already under experimental cultivation in canes and in food-plants suitable to the district. This station is now at work, under a committee whose business is to supervise operations, and to communicate directly with the central establishment.

Grenada, which is in a fairly prosperous condition, has enlarged the original idea of a botanic station by making provision for a small botanic garden, which is now in course of being laid out under the charge of a trained superintendent (originally from Kew, but with Jamaica experience) at the Paddock, within easy reach of the town of St. George. At St. Vincent the proposal to utilise the old botanic garden of the colony as a botanical station has been adopted, but the provision at present made is insufficient for the purpose, and will require to be slightly increased.

St. Lucia, to the north-west of Barbados, has shown a spirit of commendable energy in taking up the idea, and has given practical effect to it through the operations of its well-organised agricultural society. An experienced curator, also from Jamaica, has recently been appointed to the charge of the station, and good results are anticipated. At Dominica the botanical station has not yet assumed a practical form owing to the depressed state of the finances; but there is little doubt that ultimately such a station will be established, and the resources of this fertile island more largely developed.

Further north, Antigua, more especially concerned in the cultivation of the sugar-cane, has joined the scheme, and apparently is only waiting the completion of final arrangements at the central establishment. British Honduras, which has already benefited by its intercourse with the Botanical Establishment in Jamaica, has the site for a station, and a managing body has been appointed to begin operations at an early date.

To give a certain cohesion and uniformity of action to these several agencies, it was thought very desirable that a visit should be made to the islands concerned by the head of the Jamaica Department. This was accomplished in the early part of last year by the writer of these notes, who was happy to devote a short holiday, on retirement from Jamaica, in visiting the islands at his own expense.

During this visit sites for stations were examined and discussed, and suggestions made for their working on the lines best suited to local circumstances. As a practical instance of the feasibility of a botanical federation of the West Indies, it may be mentioned that recently an inquiry has been made, by general consent of the local Legislatures, into the condition of the indigenous forest growths of these islands, by Mr. E. D. M. Hooper, of the Madras Forest Department.

The Reports on Jamaica and St. Vincent are already published, and they are of such a practical and useful character that they cannot fail to have an appreciable effect upon the treatment and management of the forests both as reserves of timber to supply future wants, and as a means of maintaining a due humidity of climate and protecting the sources of springs and rivers. These Forest Reports, when completed, will add greatly to our knowledge of West Indian timbers, their nature, extent, and distribution; and they will also afford for the first time in history the actual economic and meteorological conditions of the interior of several islands beyond the confines of the present areas under cultivation.

In many instances the natural forest trees, as at Barbados, the Virgin Islands, and some of the islands of the Grenadines, have been nearly exterminated; those once very common, and represented largely in collections of botanical travellers of the last century, are now almost unknown. If the botanical stations are carried on with due regard to the industrial wants of the community, and are not allowed to degenerate into mere nurseries for ornamental plants, they will indirectly do much to enlarge knowledge as regards local floras, and bring to light many indigenous plants likely to prove useful on account of such medicinal and economic properties as they may possess. In the year 1824 it was laid down as one of the objects of the then Botanical Garden, at Jamaica, that it should devote

attention "to the investigation of many unknown native plants of the island, which, from the properties of those already known, it is reasonable to infer would prove highly beneficial in augmenting internal resources by supplying various articles either for food, for medicine, or for manufacture, . . . by means of which great commercial advantages might be obtained; among others, the various vegetable dyes claim particular attention, as promising a fruitful field of discovery." As indicating the direct bearing which this one field of inquiry (vegetable dyes) among many others had upon the future of Jamaica, it is interesting to note that while no dye-woods whatever were exported from the island in 1824, a small trade of the value of 1859*l.* was started in 1833, which since that time has steadily increased, until now it has assumed relatively large dimensions. The exports of dye-woods in 1870 reached a gross value of 112,313*l.* ("Jamaica Handbook," 1884-85, p. 375).

Similar results in more recent times have attended the increased attention given to the cultivation of fruits that had been neglected in Jamaica. The export of these in 1875 amounted to 14,912*l.*, in 1884 the total value had increased to 273,534*l.*

Results such as these, although obviously of a special character, justify any attempt that may be made to improve the circumstances of the West India Islands; and they afford also a striking instance of what is capable of being accomplished in these islands when careful investigation and judicious and enterprising effort are made to fit local circumstances to the demands of the outer world.

As regards the carrying out of a scheme of local enterprise in the West Indies, it may be mentioned that the recent appointment of Mr. William Fawcett, a highly-qualified botanist, to the post of Director of the Botanical Department in Jamaica, and the transfer of Mr. Hart, late senior Superintendent at Jamaica, to the post of head of the Botanic Garden at Trinidad, appear to offer every hope of success to a botanical federation of the West India Islands. Jamaica and Trinidad, as the two foci of operations, could very well group round them the lesser islands, and the full realisation of such a scheme as is here indicated only requires such working out of details as may well take place at an early period.

It is important, however, to bear in mind that the success of the Jamaica Botanical Department, which has acted for several years as the centre of botanical and economical operations in the West Indies, has been in a great measure due to the valuable suggestions and the moral and material support which for many years it has received from Kew. It was from Sir William Hooker that Jamaica received its first supplies of seed of the several species of Cinchona, which have laid the foundation of the only English Cinchona enterprise in the New World. It was from his illustrious son and successor at Kew, Sir Joseph Hooker, that Jamaica received its tea plants and seeds, india-rubber plants, coca plants, fibre plants, and regular and large supplies of all the economic and medicinal plants which have flowed through Kew for distribution to various portions of the British Empire. Few can realise the eminent services which have been rendered by Kew in this direction, both by its correspondence and contributions, but there is every reason to believe that the results will ultimately be apparent in the greater prosperity of the inhabitants of the West Indies, and in the larger development of their rich and varied resources.

D. MORRIS

ART AND SCIENCE IN A NEW LIGHT

MR. BRETT is an artist of reputation and of remarkable industry. His pictures are popular, and meet with appreciative purchasers. He is enrolled among the Associates of the Royal Academy, and no doubt looks forward to be in due time raised to the dignity of Acade-

mician. At the request of the Fine Art Society he has this winter allowed a series of about fifty sketches painted by him on the west coast of Scotland last summer to be exhibited in the New Bond Street rooms. These sketches show that he has recently spent a long holiday among some of the most delightful scenery in the British Isles. As a man who has evidently got on in the world, looking back upon a distinguished past and forward to perhaps a still more distinguished future, he might reasonably be expected to smile pleasantly on the world that has used him so well. If the keen eyes that stand him in such good stead in landscape-painting reveal to him the weaknesses and frailties of his fellow-men, one might at least anticipate that they would wink hard at these shortcomings and rather turn to the good side of men and of things. But apparently Mr. Brett sees only too vividly what he conceives to be the impostures and ignorances around him, and his soul is stirred within him at the sight. The exhibition of his last year's sketches has furnished him with the occasion for discharging the vials of a wrath which, like that of Tam o' Shanter's wife, he must have been nursing for a long while to keep it so warm.

The Exhibition (now closed) was illustrated by a pamphlet, which on the title-page is described as "An Explanatory Essay," and on the first page is more emphatically designated as "The Commentaries." Mr. Brett, apparently with some presentiment that this literary effort of his might not meet with the same kind reception that attends his pictorial labours, stipulated expressly, as he tells us in a "Prefatory Note," that his paper should be published exactly as it left his hands. We cannot therefore plead for him that his essay was hurriedly thrown off in a fit of ill-temper. He ostentatiously goes out of his way to accept the responsibility of its matter and its style. A description of each picture, from the artist's point of view, with a running commentary on his method of working, the difficulties in Nature to be overcome, and his way of grappling with them, would have been interesting to the general public and valuable to artists and students of art. He seems to have started with the idea of writing some such commentary. But by the time he gets to the second page he catches sight of the red rags of imposture and ignorance, and without more ado rushes madly at them. The first victims of his fury are press critics of art. Nothing is too contemptuous to be said of them. Mr. Brett looks on them as a set of ignorant charlatans, too idle to work, too proud to beg, but who are glad to earn the slender pay allowed to them by careless editors. Some wretched scribbler had pronounced his work to be "laborious," which we would have thought rather a complimentary epithet; but Mr. Brett cannot forgive it. The writer who used it he stigmatises as a "bell-wether," and those who blindly followed his lead are described as "enlightened tom-tom players, who have gone on sounding the same note for a quarter of a century or more."

After this onslaught the painter tries to find his way back to where he was, and for a little while the reader begins seriously to entertain the hope that the promised commentary is coming. But the author gets upon the subject of clouds, and instantly a bigger bunch of red rags looms in front of him. Down goes the head, and with one triumphant howl of derision the infuriated writer rushes at scientific men in general, and the Royal Society in particular. After this second outburst he hardly calms down again till the end of the performance. No sooner does he turn from the treatment of the clouds to the ground beneath us than geological theories in all their hideous deformity and crass ignorance stare him in the face. The text is not roomy enough to contain all that he has to say about the misdoings of the geologists, so that he has to overflow into a footnote. Next comes the turn of those misguided astronomers who have

led mankind wrong about the moon and the planet Mars.

One is tempted to ask what is the meaning of all this sound and fury. What relation has it to the pictures it is meant to preface? What object can the writer have had in indulging in it? Men of science are, no doubt, often wrong. But at least they take the trouble to try to be right. Their greatest aim is to get at the truth, and they welcome whatever will lead them nearer to that goal. They will even willingly learn from Mr. Brett if he has anything to teach them, though he laughs them to scorn, and derides them as "scientific Johnnies," "lovers of jargon," makers of "real gibberish," by whom various "forms of silliness are palmed off as science disguised in Greek or Latin." If the meteorologist turns for suggestions to Mr. Brett's essay, he there learns that "the fundamental phenomena of evaporation have always been misrepresented," and that he and his gaping fellow-students of Nature will learn more about clouds from the pictures of a well-known landscape-painter "than from all the Transactions of the Royal Society put together." If the geologist inquires what Mr. Brett has to say for his consideration regarding the "laws of the rocks," he is told that water is a "recent formation," that upheaval is a "childish conception," and that geologists "ignore the moon." If the astronomer in turn asks what the author of "The Commentaries" has to say in his department of knowledge, he is informed that Mr. Brett defies him "to point out a single instance of a volcano or a volcanic crater in the whole disc" of the moon. The "jargon" and "real gibberish" of modern science not only afflict the artist's own soul, but they disturb the peace of his family. "One professor the other day," he indignantly exclaims, "learnedly instructed my boy that aqueous vapour was formed by evaporation!" Hapless youth! Let us hope that his father has found time to instruct him in "the fundamental phenomena of evaporation."

After such a tirade against scientific men, one might suppose that Mr. Brett would be disposed rather to avoid them, or at least not to show himself ostentatiously in their company. And yet the reader will be amused to discover him, in the midst of these rabid denunciations, contriving to find room for a statement that he himself has written a scientific paper which has been published in a scientific journal, and that this important fact may not be missed, he quotes the paper in a footnote! Is Saul also among the prophets? There would be something pathetic, were it not so ludicrous, to see the proud paternal way in which the artist brings forward his feeble little scientific bantling. We should not be surprised if he thought more of it than of some of the pictures that have made his fame. His contempt for "lovers of jargon" and "real gibberish" is apparently equalled by his profound satisfaction with his own achievements. Not content with indicating the artistic value of his work, he claims that, "if these sketches have any distinct peculiarity worthy of notice, it is that they are optically correct, or at least are intended to be so, and that intention, strange to say, is new in pictorial art"! It would be interesting to hear the painter's defence of the "optical correctness" of some of the pictures. Did he ever see, for instance, a castle standing as he has depicted one in No. 22? Of his peculiar greens and blues we need not speak. They are part of his "confirmed mannerism," to use his own phrase, and are characteristic of his canvas, no matter under what skies and among what seas and rocks he may paint.

The pamphlet to which reference has been made in this article would not, of course, have been noticed here but for the name of its author. Science owes much to art, as art in turn lies under many obligations to science, and it should be the aim of each to help forward the other. That a man of Mr. Brett's artistic attainments should have gone out of his way to pen this "form of

silliness" is to be regretted chiefly for his own sake. He has injured his reputation for common-sense, and this even a great genius cannot afford to do.

THE NATIONAL SCIENCE COLLECTIONS

THE following Report of a Committee appointed by the Government to consider the housing of the objects illustrating the physical sciences belonging to the nation has recently been printed and circulated. The Committee consisted of Sir F. Bramwell (Chairman), Lord Lingen, Colonel Donnelly, C.B., and Mr. Mitford, C.B. :—

1. We, the Committee appointed by the Lords Commissioners of Her Majesty's Treasury to consider certain questions that have arisen in regard to the Scientific and Technical Collections at South Kensington, now beg leave to present to their Lordships our Report thereon.

2. The appointment of the Committee included the name of Sir Francis Sandford, K.C.B. ; but this gentleman, in consequence of the pressure of other public business, has been unable to attend any of our meetings, and he has authorised the other members to proceed with the inquiry, and to report, in his absence.

3. Our instructions were conveyed in a letter, dated January 14, 1884, and a memorandum accompanying it, from Lord Richard Grosvenor to the Chairman, and were to the following effect :—

"It will be the duty of the Committee (1) to consider and report upon the scope of the Scientific and Technical Collections, including the Patent Museum, and the space required for them, immediately and prospectively ; (2) to suggest plans for housing these Collections in the existing galleries to the south of the Horticultural Gardens, or in new galleries to be built upon their site, and the adjacent ground now the property of the Government."

PRESENT DISPOSAL OF THE SCIENCE COLLECTIONS

4. Before we enter on the consideration of these questions, it will be convenient to explain how the collections are at present housed.

They are contained in five buildings which are shown on the accompanying Plan, Drawing No. I., and are marked A, B, C, D, E ; whereof A, B, C, and D are on the west, and E is on the east side of Exhibition Road.

The buildings A, B, E, coloured yellow on the plan, and their sites, are the freehold property of the Government ; the buildings C, D, coloured blue, and their sites, are the property of the Royal Commissioners of 1851, from whom they are rented by the Government.

5. C is a block forming the centre portion of the galleries to the south of the Horticultural Gardens. It is about 292 feet long, 55 feet wide, and two stories high. It contains 22,000 square feet of available floor-space.

This building is the property of the Royal Commissioners of 1851, and is at present leased from them by the Government for 1500*l.* per annum. The lease terminates in 1890 or 1897, with a power up to January 1888 of purchase for the sum of 30,000*l.*, or, at the option of the Commissioners, for such sum, not exceeding 35,000*l.*, as may be fixed by the President of the Institute of British Architects.

6. A and B are the southern wing-galleries, the former on the east, and the latter on the west side of the central block C, and having short returns or spurs, A' and B', to the northward, at their external ends.

These wing-galleries extend about 280 feet in length on each side of the central block ; they are about 26 feet wide, and two stories high.

The returns at each end are each 72 feet long, and one story high.

The whole contain about 29,500 square feet of available floor-space.

These buildings, and their sites, are the property of the Government.

7. D is a building known by the name of the West Gallery. It is 600 feet long, 33 feet wide, and two stories high. It contains about 36,560 square feet of available floor-space.

This building is the property of the Royal Commissioners of 1851, and is at present rented from them by the Government for the sum of 2000*l.* per annum. We believe, however, it is desired to give up the tenancy possible.

8. E is a temporary building one story high, abutting on the south end of the permanent buildings of the Museum on the eastern side of the Exhibition Road. It contains 7500 square feet of available floor-space.

It is the property of the Government, but we understand it must be pulled down before long, to make way for more permanent erections.

9. These buildings are not altogether devoted to the Science collections.

The National Portrait Gallery at present occupies 19,040 square feet, partly in the two floors of the eastern wing A (a portion of the freehold), and partly in the eastern section of the central block C (the leasehold portion), of the south galleries. A space of 7500 square feet in the upper floor of the central leasehold block C, is also reserved for examination-rooms.

A portion of the ground floor of the western gallery, D, has been, up to the present time, occupied by the Pitt-Rivers Loan Collection, but this collection is in course of removal to Oxford.

10. The Science collections are now contained in the western part of the ground floor of the leasehold central block C ; in the ground floor and in part of the upper floor of the western freehold wing B ; in the northern end spurs A' and B' ; in the two floors of the western gallery D ; and in an unsightly wooden passage K.

This passage runs outside the southern wall of the south gallery, and forms the only approach from Exhibition Road to the Science collections, it not being possible to allow the public to use the Portrait Gallery as a thoroughfare.

The "Patent Museum" is contained in the temporary building E.

11. The total floor-space now occupied by the Science collections is therefore about as follows

	Square feet
Total space in C	22,000
" " A, B, and A', B'	29,500
" " D	36,560
" " E	7,500
	95,560
Deduct Portrait Gallery	19,040
" Examination-Rooms	7,500
	26,540
Total occupied by the Collections	69,020

12. The Drawing No. I. also shows (marked G coloured red) the area of land which belongs to the Government south of the present south galleries, which land is implied in our instructions to be available for buildings to house the collections.

SCOPE OF THE COLLECTIONS, AND SPACE REQUIRED FOR THEM

13. We may now proceed to report on the first subject submitted to us, namely :—

The scope of the Scientific and Technical Collections including the Patent Museum, and the space required for them, immediately and prospectively.

14. A Museum of Science was contemplated as integral part of the Science and Art Department from its creation in 1853.

Objects were gradually collected, and when the Department was removed to South Kensington in 1858 these objects were, for the first time, arranged together in the Museum for public inspection. They were mentioned by a House of Commons Committee in 1860 as "well worth preserving."

These collections, however, were not developed as much as the Art collections. Some objects were sent away to other establishments; and for want of space in the South Kensington Museum, the greater portion of the remainder were removed to the galleries on the western side of the Exhibition Road, where they have remained till now.

But public attention was frequently called to the subject. The Royal Commission on Scientific Instruction and the Advancement of Science, in their Fourth Report (1874), treated somewhat largely of these collections; they noticed many interesting objects which they contained, but they pointed out the striking contrast between them and other British National collections. They expressed their regret that there was no National collection of the instruments used in the investigation of mechanical, chemical, or physical laws, although such collections were of great importance to persons interested in the experimental sciences. This defect in our collections was, they said, already keenly felt by teachers of science, and high authorities had assured them that, on the Continent, collections of scientific apparatus, when combined with lectures accessible to workmen, had exerted a very beneficial influence on the development of the skill of artisans.

The Commission suggested, in conclusion, that the collections should be completed and consolidated, and placed under the authority of a Minister of State.

In 1876 a Loan Collection of Scientific Instruments and Apparatus was exhibited in the galleries of the Horticultural Gardens. It excited much attention, and a memorial was presented to the Lord President, signed by 140 of the best known men of science in the country, suggesting that it might be utilised in the formation of a National Science Museum. Some of the objects were left in the care of the Department, but no general action was taken.

The question of the development of the Science Collections of the Department remained in abeyance till 1881, when the Lord President, Earl Spencer, stating that "the importance of having a Museum for Scientific Apparatus was amply established," set on foot a series of inquiries to which we proceed to refer.

15. For the purpose of these inquiries, the existing collections were divided into six heads:—Objects for the illustration of Science generally; Naval Models; Objects illustrating Building Construction; Objects bearing on Fish Culture; Educational Objects; and Mechanical Objects.

Committees, composed of persons having specific knowledge in each of these branches, were appointed to examine the several collections, and expressed opinions on their condition, on the development which it would be advisable to give to them, and on the space required.

As copies of the Reports on each head are reprinted in an Appendix (B), it will suffice to give here a general outline of the opinions and recommendations they contain.

Collections of Objects for the Illustration of Science generally

16. The Committee consisted of Mr. Wm. Spottiswoode, President of the Royal Society, Professors Frankland, Goodeve, Guthrie, Huxley, Judd, Chandler Roberts, and Warrington Smyth, Mr. Norman Lockyer, and the chief officers of the Science Department. They expressed the opinion that this question was of great importance in relation to the education, the industry, and the science of

the country; they reported that the present collection was suitable for a nucleus of the contemplated Museum, and they recommended an examination, by the several Professors and other members of the Council of the Normal School, of the various classes of apparatus and appliances relating to their own subjects respectively.

This examination was afterwards undertaken by a Committee of the various Professors, and the results, as already stated, are given in the Reports. Recommendations were made as to the objects in each department of science, and the following estimate was given of space necessary to be provided:—

	Square feet
Chemistry	6000
Physics	6000
Mechanics	5000
Metallurgy	2500
Geology and Mineralogy	2500
Astronomy, Meteorology, and Geography	7000
Agriculture	4000
Biology	4000
	37,000

The Committee also estimated that a further space of 3000 square feet (making 40,000 in all) would probably be sufficient for any reasonable increase within ten years.

Naval Models

17. A Committee consisting of Lord Ravensworth, Sir E. J. Reed, K.C.B., M.P., Mr. W. Baskcomb, Mr. J. H. Morrison, and Mr. Joseph D. A. Samuda, considered this collection, and reported on it on March 1, 1883. They expressed a strong opinion as to the utility of such a collection, gave some general suggestions upon it, and proposed to have it carefully examined in detail.

This examination was carried out, and on April 4, 1883, the Committee based upon it a statement that a space of 10,500 square feet was at once required, and that 10,000 square feet additional should be provided for the increase during the next ten years, making 20,500 square feet in all.

Structural Collection

18. The Committee for this consisted of Mr. (now Sir) Charles Hutton Gregory, Past-President of the Institution of Civil Engineers, Mr. G. E. Street, President of the Royal Institute of British Architects, Mr. James Abernethy, President of the Institution of Civil Engineers, and Major H. C. Seddon, R.E., Examiner for the Science and Art Department in Building Construction. They reported, in 1881, that this collection was of great value in many respects, and recommended its maintenance, revision, and development.

In July 1883 another Committee, consisting of Mr. C. H. Gregory, Mr. Horace Jones, President of the Royal Institute of British Architects, Mr. James Brunlees, President of the Institution of Civil Engineers, and Major Seddon, took up the matter. They put forward detailed proposals in regard to the constitution and arrangement of the collection, and gave an estimate of 15,000 square feet of floor-space for it, to be increased to 25,000 square feet in ten years.

Fish Culture

19. The Committee for this collection were Prof. Huxley (Government Inspector of Fisheries), Sir J. R. G. Maitland, Bart., Mr. E. Birkbeck, and Dr. Francis Day.

They expressed the opinion that it was highly desirable that the existing specimens should be developed into an economic Fish Museum, and they estimated about 5000 square feet as the space required.

Educational Objects

20. The Committee for this were Dr. J. H. Gladstone, Rev. J. W. Sharpe, Mr. J. S. Fitch, Mr. J. Iselin, and Mr. H. A. Bowler.

They stated that the collections would be of great value to School Boards, managers, and teachers, and they estimated 7000 square feet of surface as necessary, not including any allowance for the library.

Mechanical Collections

21. The Committee appointed to consider these collections were Mr. John Slagg, M.P., Sir W. G. Armstrong, Sir J. W. Bazalgette, Mr. James Brunlees, Mr. E. A. Cowper, Prof. T. M. Goodeve, Sir Charles Hutton Gregory, Mr. John Hick, Mr. James Howard, M.P., Mr. Charles Manby, Mr. J. Hinde Palmer, Sir E. J. Reed, M.P., and Mr. (now Sir) B. Samuelson, M.P.

They carefully examined the collections, including the "Patent Museum" (which, under the Patent Act, 1883, had been transferred to the care of this Department on January 1, 1884), and made a comprehensive report, embodying suggestions for the improvement and the arrangement of the whole.

They estimated that from 40,000 to 50,000 square feet of space would be required.

22. Considering that the members of these Committees were selected, on the responsibility of the Government, for their competence as authorities in their respective branches of science, and considering the detailed nature of their inquiries, we assume their conclusions as the basis of our recommendations.

We may also add that similar Committees are permanently retained, under the name of "Committees of Advice and Reference" for the several collections

23. We need not enlarge on the desirability that such a country as Great Britain should possess a thoroughly good and complete National Collection of Scientific and Technical objects, any more than that it should possess a Museum of objects of Art or of Natural History.

When it is considered how much the prosperity of the nation is bound up with industrial enterprises and occupations, and how largely these depend, for their success, on practical applications of science, it needs no elaborate reasoning to prove that the public exhibition of well-selected and judiciously arranged scientific and technical collections, particularly when used in connection with efficient courses of instruction, justifies its cost.

24. There has long been a National Scientific and Technical Museum in France, well known under the name of the Conservatoire des Arts et Métiers, and this has often been referred to as a type of the institution of a similar nature which ought to be established in England.

We reprint, in Appendix C, an article published in the *Times* newspaper of October 5, 1876, which gives a full account of the nature and scope of the Conservatoire, and we have also received, through the courtesy of the Directors, full information as to the present contents and arrangements of the Museum.

The premises are situated in an area contained between the four streets, Rue St. Martin, Rue Vaucanson, Rue du Vert Bois, and Rue Réaumur. This area is about 200 metres wide by 140 metres deep, thus containing 28,000 square metres, or about 7 acres. These 7 acres are not at present entirely occupied by the Conservatoire, but an enlargement of the buildings is in progress, which will extend them, including the necessary courtyards, passages, &c., over the whole area.

The objects exhibited belong to a great variety of subjects, the following being only a brief indication of their general classification:—

Motors.—Horse-machines, water-motors, wind-motors, steam-engines, hot-air engines. Details and accessories.

Hydraulic Machines.—Pumps, &c.

Descriptive Geometry.—Forms of curves; teeth of wheels. Machines for producing special forms.

Metallurgy.—Working of mines. Minerals. Metallurgical processes. Metals.

Calculating and Counting Machines.

Instruments for Surveying.

Astronomy, &c.—Almanacs and Calendars.

Chronometry, ancient and modern; movements; tools.

Arts of Construction.—Materials, processes, workmen's tools, &c. Constructions under water.

Kinematics.—Machinery. Mechanism. Elements of machines.

Dynamometers and instruments for mechanical observations.

Cranes and other constructions for lifting and removing weights.

Machine Tools of various kinds. Presses, &c.

Engraving, Lithography, Typography, Printing, &c., and paper-making.

Porcelain, Glass, and Pottery.

Physics.—Mechanics. Molecular actions. Heat. Magnetism. Electricity. Acoustics. Optics. Meteorology. Electro-chemistry. Telegraphy.

Agriculture.—Apparatus of all kinds.

Weights and Measures.—French and foreign. Weighing-machines. Instruments of comparison.

Locomotion and Transport on ordinary roads, on railways, and on rivers, canals, and the sea.

Manufactures, various.—Gunpowder. Arms. Chemicals. Bread. Sugar. Cements. Cutlery. India-rubber.

Spinning and Weaving.—Textile manufactures generally.

Preparation, Dyeing, and Printing of Fabrics.

Chemical Arts and Products.—Preservation of Timber. Gas. Distilling. Brewing. Tanning, &c.

Industrial and Fine Arts.—Prints; designs. Photography.

Pictures and Drawings, illustrative of Scientific and Technical matters; a very large collection.

There are in all about 10,000 objects. The collection is remarkably rich, both in historic apparatus and in the most recent inventions. The machinery is shown in motion two days in the week. The objects are used, when required, for the lectures given in the Conservatoire.

Nothing is added unless it can be utilised for teaching; sometimes orders are given for models to be made, and sometimes objects are purchased. When anything is offered as a gift, it is not accepted unless one of the professors will state that it is really required.

The collection is not in any way a Patent Museum. Formerly certain models of patented inventions were exhibited there, but this is no longer done.

(To be continued.)

NOTES

THE meetings held yesterday at St. James's Palace and the Mansion House, to which we have not time to refer at length this week, indicate that from the Prince of Wales downwards all interested in the proposed memorial are willing to allow the necessity of making the Institute one on a broad scientific basis. An admirable speech by Prof. Huxley at the Mansion House, following that of the Prince of Wales at the first meeting, shows that there is now no chance of the importance and of the necessity of collecting and arranging knowledge being overlooked.

FRENCH geologists have cause to regret the blow which their science has received in the premature death of the well-known geologist of Lyons, C. F. Fontannes, on December 29, at the age of forty-eight. He is best known by his important monograph on the "Stratigraphy and Palæontology of the Tertiary Deposits of the Basin of the Rhone"—a work of laborious research and of great value from the minuteness and accuracy of its details. He established a claim on the gratitude of geologists by the infinite pains he took in the organisation and working of the Inter-

national Geological Congress, the success of which has been in large measure due to his active help. His pleasant smile and cheery way of smoothing over personal friction will long be remembered by those who witnessed them at the meetings of the Congress.

SIR FRANCIS BOLTON died at Bournemouth on Wednesday, the 5th inst. He was born in 1831, and entered the army at the age of twenty-six. For some time he served on the staff as Deputy-Assistant Quartermaster-General, and in 1881 he retired with the rank of colonel. He was the inventor of the system of telegraphic and visual signalling which was introduced into the army and navy in 1863, and for these services and other improvements and inventions in regard to warlike material he received in 1883 the honour of knighthood. In 1870 he founded the Society of Telegraph-Engineers and Electricians.

LAST year some of the leading statisticians of Europe combined to form a new Society, the International Statistical Institute. If we may judge from its aims, as set forth in the first article of its statutes, the Institute is likely to do work which will be of the highest service to Governments. It proposes to foster the progress of administrative and scientific statistics: (1) by introducing as much as possible uniformity of method and classification and of handling statistical material, in order to make the results obtained in different countries comparable; (2) by calling the attention of Governments to those questions which require to be solved by statistical observation, and requesting from them information on subjects which have not yet been treated statistically, or have been only insufficiently treated; (3) by creating international publications intended to establish permanent relations among statisticians of all countries; (4) by striving, through its publications, and, if possible, by public instruction and other means, to promote the spread of sound ideas as to statistics, and to interest Governments and peoples in the investigation of the phenomena of society." The Institute intended to have held its first general meeting in Rome in September last, but was compelled by the spread of cholera in Italy to abandon its design. It has now decided to hold its first meeting in Rome in Easter week of this year, from April 12 to 16. Nearly fifty members have expressed their intention of being present, and it is expected that the attendance will be considerably larger. The Italian Government deserves the greatest credit for the generous and enlightened manner in which it is supporting the Institute. It allows Prof. Boris, the Director-General of the Statistics of the Kingdom of Italy, to act as Secretary, and in this capacity to use the services of his official staff. With the sanction of the Italian Parliament, it has granted a sum equal to 600*l.* to aid the Institute in printing its publications, and another sum of 400*l.* has been contributed to the expenses of the approaching meeting. Moreover, it has been arranged that for the benefit of members who attend the meeting the fares on the public railways to and from Rome shall be reduced by one-half. Signor Grimaldi, the Italian Minister of Commerce, is trying to induce other Governments to act in a similar spirit, and it may be hoped that his efforts will not be wholly unsuccessful.

ON Saturday evening last, Sir John Lubbock delivered, at Toynbee Hall, a lecture on "Savages," the first of a new course. He pointed out that modern savages do not in all respects reproduce the condition of our ancestors in early times. Even the Australians hold now a system of complex rules and stringent customs, which have grown up gradually, and cannot have existed originally. From the study of modern savages, however, we may gain a fairly correct idea of man as he existed in ancient times, and of the stages through which our civilisation has been evolved. The lecturer gave a remarkably

vivid and interesting account of some of the leading facts known about the customs, beliefs, and institutions of savage races.

ON Friday evening last the Drapers' Company set an admirable example to other City Companies by entertaining at its Hall in Throgmorton Street the students associated with the Whitechapel centres of the University Extension Scheme. The classes connected with this Scheme at Toynbee Hall are attended by no fewer than 631 students, who receive instruction in physiology, astronomy, history, and English literature. The fee for a course of twelve lectures is one shilling.

THE presidential address delivered at the annual meeting of the American Neurological Association in June last by Dr. Burt G. Wilder has been reprinted from the *Journal of Nervous and Mental Disease*. In this address Dr. Wilder discusses the question as to the need of some improvement in the nomenclature of the brain. He is convinced that the current nomenclature is to a large extent an obstacle rather than an aid to the advancement and dissemination of knowledge concerning a complex organ; and, with regard to the encephalic cavities in particular, he holds that it would be better for the student if the incongruous and misleading quasi-descriptive terms, *first*, *second*, *third*, *fourth*, and *fifth ventricle*, could be displaced by totally meaningless, but easily remembered, Chinese monosyllables, like *pran*, *pren*, *prin*, *pron*, and *prun*. Dr. Wilder has obtained an alphabetical list of nearly all the names which have been applied to the parts of the central nervous system, and, allowing for some omissions and duplicates, the numbers are as follows:—Latin, 2600; English, 1300; German, 2400; French, 1800; Italian and Spani-h, 900; total, 9000. The number of parts designated by these names is considerably less than 500.

REFERRING to the death of Sir W. W. Heughes, which took place near London on New Year's Day, the *Colomes and India* mentions that practically he initiated the Adelaide University by contributing 20,000*l.* in 1872 for the endowment of two professorships. He also contributed largely to the expedition under Colonel Warburton for the exploration of the interior of the Australian continent. He received the honour of knighthood in 1880.

M. JANSSEN, the Director of the Meudon Observatory, who has been nominated Vice-President of the Paris Academy of Sciences for 1887, will be President in 1888, according to the constant rule.

It is said that M. Chevreul will resign his membership of the Academy of Sciences, and will return to his native place to spend the last years of his life in retirement. He has already sent in his resignation of the Directorship of the Museum.

ONE of the last letters written by M. Paul Bert was read at the meeting of the French Academy of Sciences on the 3rd inst. In this letter M. Bert complained of the darkness in the town of Hanoi at night. Gas was too dear, and he had tried the use of petroleum. This, however, was a barbarous expedient, and he was anxious to know whether it would not be possible for him to make the Red River, which flows past Hanoi, produce the required illumination. "Would the expense be great?" he wrote. "Only think, if we succeeded we should be ahead of England and Japan!" "Answer," he added, "and answer quickly; my days are numbered." The Academy decided that the letter should be preserved among its archives.

A LARGE number of French scientific Societies are anxious that a building should be erected in Paris for their common use. A circular on the subject has been issued. The lead in the matter is being taken by the Geographical Society.

A GOOD deal of canvassing has been going on recently in Paris, in the Sorbonne, the Medical School, and the Academy

of Sciences, for professorships and seats in the Institute of France. Many superannuated professors have been removed, in consequence of the enforcement of a recent law; others have died. In the Medical School, Prof. Sappey's place has been given to M. Farabeuf, a distinguished anatomist, although entirely devoid of philosophical tendencies. Prof. Gavarret, whose well-known researches, conducted many years ago with Audral, have been of the utmost importance for the physiology of respiration, has seen his place filled by M. Gariel, who has been his assistant for a long time. Prof. Peter has taken the place of M. Hardy, in the Professorship of Clinical Medicine. He is an obstinate opponent of M. Pasteur's theories, but, nevertheless, a good physician, well trained, and skilled in his part of science. Prof. Pagot, the well-known Professor of Obstetrics, resigned his appointment on the day of his seventieth anniversary, and it is likely that M. Pinard will be his successor. M. Pinard is an able obstetrician, a good teacher, an original worker, and is much liked by students and professors. The vacancy caused at the Sorbonne by the death of Milne-Edwards has been filled by the appointment of M. Yves Delage, who has been for a short time Professor of Zoology in Caen. M. Yves Delage, although a very young man, has done a good deal of excellent personal work. His principal investigations bear upon the circulatory system of Crustacea, the life history and anatomy of *Sacculina*, a parasitic Crustacean, and the anatomy of the whale. In the Academy of Sciences, M. Sappey was elected soon after his removal from the Medical School. His personal work has been good, and bears upon human anatomy, upon the anatomy of the lymphatic vessels, of the air-reservoirs of birds, and many other points of comparative anatomy. M. Ranvier, the able histologist of the Collège de France, will very likely be elected to the seat of Ch. Robin. One of the competitors for Paul Bert's seat is M. Ch. Rochet, the physiologist, and editor of the *Revue Scientifique*.

A VERY good little guide to the most picturesque streets and buildings in the capital of Egypt, by Major E. T. Plunkett, R.E., has just been published. It is entitled "Walks in Cairo." Major Plunkett's object is to call attention to "sights" which have hitherto been neglected by the writers of guide-books, —out-of-the-way mosques, in which the most graceful Arabesque forms may be found, with choice bits of marble mosaic and fine specimens of cabinet-work, and street corners made picturesque by minarets, overhanging stories, and windows of lace-like lattice-work. If any visitor is in doubt whether he would or would not enjoy the "Walks" described, he is advised to try one of them, and if he finds that uninteresting to try no more.

ON July 28 last, Miss Eleanor A. Ormerod, F.E.S., Consulting Entomologist to the Royal Agricultural Society, received from Revell's Hall, Hertford, specimens of injured barley, which on examination precisely corresponded with the condition caused by attack of the *Cecidomyia destructor*, commonly known as the Hessian fly. A paper setting forth the results of her observations, with the opinions of high authorities in England and America, was read at the Entomological Society of London on December 1 last. An abstract of this paper will be found in the *Entomologist* for January.

IN the January *Zoologist* there is a very good representation of the Greater Horse-shoe Bat (*Rhinolophus ferrum-equinum*). It illustrates an article on "Horse-shoe Bats" by the editor, who remarks that as few really good figures of bats are accessible, those in Bell's work being almost too small to be of much use, it is very desirable that no opportunity should be lost of obtaining correct drawings of the rarer species whenever they can be procured alive or in a fresh condition, so as to secure an accurate delineation of the natural features before they become

distorted or shrunk in the process of drying. The plate which he offers as a first contribution to such a series is from a living specimen obtained by the Rev. H. A. Macpherson in South Devon in August last. This specimen weighed little more than half an ounce the day after death.

SEVERAL Arctic species of birds, which do not breed in England or Ireland, breed in Scotland. This fact is explained by Mr. Henry Seebohm in an article in the January *Zoologist*. Most, if not all, of the species in question breed in July, and, roughly speaking, they draw the line a few degrees below 60° F. They do not breed in any locality where the mean temperature for July is as high as 60°, the reason probably having relation to the supply of food. Now, in a map of the world, in Keith Johnston's "Physical Atlas," giving the mean temperature for July in various parts of the earth, the isothermal line of 59° is drawn. This line separates England and Ireland from Scotland, passes north of the Gulf of Bothnia, through the town of Archangel, extends nearly straight across Russia and Western Siberia, but, east of the valley of the Yenesei, again rises until it almost reaches the coast near the delta of the Lena. Farther east in Siberia it plunges south again, much more rapidly than it rose in Western Europe, and, passing south of Kamchatka, it embraces the Kurile Islands in the latitude of the Pyrenees. This line is almost exactly parallel with what is known of the southern breeding-ranges of the various Arctic birds under consideration. It is not, therefore, surprising that these birds should breed in Scotland; and there is no reason, Mr. Seebohm concludes, for attempting to explain by any other causes than the ascertained climatic cause, the interesting fact that British ornithologists are able to study the breeding habits of so many species which their Continental fellow-students can only observe by travelling 500 miles or more farther north.

THE Journal of the Society of Arts prints an interesting letter from Mr. T. F. Peppe, on the cultivation of the so-called wild silks of India. Mr. Peppe points out that in many parts of India the jungle consists of the plants on which the tussur worm feeds, and that the supply of labour is practically unlimited. At present the work is carried on only by a few tribes who have been accustomed to it from time immemorial; but nearly all the aboriginal tribes of India might be available, if their services were in demand. The chief obstacle to the rapid development of the industry is the difficulty of procuring seed-cocoons, which have to be sought for in the wild state in the jungles. This difficulty, however, Mr. Peppe thinks, will be gradually overcome, since in every cultivated tract there are always a few cocoons which escape detection and collection, and which add to the number of wild cocoons found in the next brood. The industry is precarious, but there are several crops in the season, and if one fails the others may succeed. Mr. Peppe has cultivated tussur for three years, yet he is not prepared to say how many broods are possible in a year. Each brood so overlaps the succeeding one, that it is very difficult to distinguish one brood from another.

A COURSE of five lectures on "Molecular Forces" will be delivered by Prof. A. W. Rücker, M.A., F.R.S., at the Royal Institution, beginning on Thursday, the 20th inst. The remaining lectures will be delivered on the 27th inst., and on February 3, 10, and 17.

MESSRS. W. WESLEY AND SON have issued the seventy-ninth number of their "Natural History and Scientific Book Circular." The most important part of the Catalogue appears under the heading "Ornithology."

We have received the "Year-book of Photography and the Topographic News Almanac for 1887," edited by Mr. Thomas Bolas, F.C.S. It contains, besides a calendar for the year and lists of photographic societies, a large number of notes and

icles likely to be interesting and useful both to beginners in otography and to advanced practitioners.

THE Severn Fishery Board has issued an Almanac for the ar 1887, which is intended to show the law as to fishing in the vern fishery district, and to indicate to water-balliffs, fishermen, and others interested in fishing, what they may look for in ferent months of the year. The information on which the tements in the Almanac are based was collected by the ard's officers.

THE seventh volume of the Transactions of the Sanitary Institute of Great Britain, 1885-86, presents a full report of the proceedings of the Congress of the Institute held at Leicester from ptember 22 to 26, 1885. The papers read at the Congress re divided into three sections—(1) Sanitary Science and Prentive Medicine; (2) Engineering and Architecture; (3) hemistry, Meteorology, and Geology. Mr. John F. J. Sykes, onorary Secretary for the first section, recommends that a ecial day, or part of a day, should be devoted to the consideraon of domestic sanitation and ambulance. In both of these bjects ladies take great interest, and Mr. Sykes is of opinion at his suggestion, if adopted, would add immensely to the success of future Congresses.

THE amount of the rainfall at Ben Nevis Observatory during 86 was 107·85 inches, the greatest monthly fall being 14·57 ches in November, and the least 2·84 inches in February. In 85 the annual rainfall was (see vol. xxxiii. p. 347) 145·50 ches, the largest monthly fall being 24·33 inches, and the least 97 inches, the rainfall of 1886 being thus very much less.

WE understand that complaints have been made to the ishery Board for Scotland that steam-vessels have been ecently prosecuting beam-trawling overnight in the waters osed by the Board's by-law against this mode of fishing. ome time since the Board instituted legal proceedings against arties who had infringed the by-law, some of whom were ned, and they also posted placards at the different harbours and eeks in the prescribed waters giving notice of the terms of the y-law, and it was hoped that the illegal practice would have een thereafter discontinued. The Board's cruiser *Vigilant* has one what she could to protect these waters, but owing to her sing a sailing-vessel she cannot do this so effectively as a essel with steam power. In the circumstances the Board have istricted H.M.S. *Fackal*, at present cruising on the west coast, t once to proceed to the east coast and protect the inclosed eas there, as well as to take a general superintendence of the heries. The prescribed waters include the Firth of Forth, t. Andrews Bay, and Aberdeen Bay. The present *Fackal* is new, powerful, and swift vessel, and is provided with the lectric light, which will enable her to sight vessels at a considerable distance on dark nights. The Board's cruiser *Vigilant* ill at once proceed to the west coast and take up fishery duty ere, assisted by H.M.C. *Daisy* tender.

THE Report of the Swiss Commission for the Reform of ymnasial Instruction has just been issued. The Commission ecommend that the teaching of Latin shall begin in the fifth lass, and shall be continued, for five hours weekly, up to the ighest class; that instruction in Greek shall depend upon the xpressed desire of parents or guardians, and shall begin in the urther class; and that all scholars who do not learn Greek shall arn either English or Italian. Two spare hours gained by upils in English or Italian are to be spent in the study of natural ience and mathematics.

MR. EDISON, the electrician, of New York, is reported to be riously ill.

THE additions to the Zoological Society's Gardens during e past week include two Barn Owls (*Strix flammea*) from

South Africa, presented by Mr. E. Hume; a Black-headed Gull (*Larus ridibundus*), British, presented by Mr. W. S. Rawlinson; two Eyed Lizards (*Lacerta ocellata*), European, deposited; four Bramblings (*Fringilla montifringilla*), British, purchased.

OUR ASTRONOMICAL COLUMN

THE SIX INNER SATELLITES OF SATURN.—Appendix I. to the volume of Washington Observations for 1883 contains an important memoir by Prof. Asaph Hall on the orbits of the six inner satellites of Saturn. Of these, the two innermost have been known to us about 100 years, but the other four for more than 200. Owing, however, to the difficulty of making accurate observations of them, their orbits were but rough approximations until the publication of Bessel's work on the orbit of Titan, which appeared in vols. ix. and xi. of the *Astronomische Nachrichten*, and from which that value of the mass of Saturn was derived which has been generally used up to the present time in computing the perturbations produced by this planet. Bessel likewise commenced, but did not live to complete, a memoir on the "Theorie des Saturns Systems," of which Prof. Hall justly remarks that it "is still the most comprehensive investigation we have of the differential equations of this system, and of the various forms of the perturbative function arising from the figure of the planet, the ring, the action of the satellites on each other, and the action of the sun." M. Tisserand has shown, however, in a short but important paper, "Sur le mouvement des apsides des satellites de Saturne et sur la détermination de la masse de l'anneau," that Bessel's determination of the mass of the ring from the motion of the line of apsides of the orbit of Titan was seriously in error, since he neglected the influence of the figure of the planet. We were, therefore, ignorant of the true value of the mass of the ring, but if the inner satellites moved in orbits which were decidedly eccentric, so that the motions of the lines of apsides could be accurately determined, the mass of the ring and figure of the planet could be deduced. It was therefore a matter of great interest to determine these orbits as accurately as possible; and Prof. Hall therefore undertook the observation of those satellites with the great refractor of the Naval Observatory, Washington. The observations of Titan, given in Prof. Hall's paper, were made at Washington during the eleven years, 1874 (in which year Prof. Newcomb observed the satellite) to 1884. During the years 1875, 1876, and 1877, Prof. Hall observed differences of R. A. and declination of Saturn and Titan at the same time and in the same manner as he observed Iapetus, to which satellite he found the method well adapted. Rhea, Dione, and Tethys were observed by Prof. Newcomb in 1874 and by Prof. Hall in 1875, whilst for Mimas and Enceladus observations extending over the years from 1874 to 1879 have been used. In the reduction of the observations of Rhea, Dione, and Tethys, the observed places have been compared with places computed from the elements for these satellites given by Dr. W. Meyer, of Geneva, and corrections to his elements are deduced therefrom. The corrected orbits show in each case a practically insensible eccentricity, and the observations of Mimas and Enceladus also can be satisfied within the limits of their probable errors by circular elements. Prof. Hall, however, draws attention to the fact that for the three innermost satellites the eccentricity of the orbit, and consequently the position of the line of apsides, cannot be determined with any certainty from the observations at his disposal. Some more accurate method of observation than that of the filar micrometer should be adopted; possibly observing the conjunctions of the satellites with the ends of the ring, the Cassinian division, and with the sides of the ball, might prove more efficient. A heliometer, if one existed of sufficient aperture, would probably furnish the most satisfactory means of all.

The orbits of the five inner satellites being thus sensibly circular, any consideration of the motions of their lines of apsides is placed out of the question. These five satellites also appear to move in the plane of the ring. It is therefore easy to furnish tables of their motions, and Prof. Hall supplies them for the period 1875-1950, together with the elements of the ring, at the close of his paper. For the mass of Saturn, from the motions of Titan, Rhea, Dione, and Tethys, he finds the reciprocal to be $3478\cdot7 \pm 1\cdot10$. The best previous determinations have been

as follows:—Bessel 3501'6, Leverrier 3529'6, Meyer 3487'45, and Prof. Hall, from the motion of Iapetus, 3481'3 ± 0'54.

Prof. Hall carefully searched for additional satellites moving in the remarkable gaps between Rhea and Titan, and Hyperion and Iapetus, but without result.

STELLAR PARALLAX.—The second Appendix to the Washington Observations for 1883, contains a second memoir by Prof. Asaph Hall, not less interesting and valuable than the above. It will be remembered that Prof. Hall published a volume in 1882, containing determinations of the parallaxes of Vega and 61 Cygni from observations made by himself with the great 26-inch refractor at the Washington Observatory. Prof. Peters, of Clinton, U.S.A., has since pointed out to Prof. Hall that the temperature correction to his observations had been applied with the wrong sign. Prof. Hall has therefore now reduced his observations afresh, and given a new solution of the equations of condition. For 61 Cygni, Prof. Hall now finds a parallax of 0''270 ± 0'0101 from 101 observations extending from October 24, 1880, to January 26, 1886. This value is notably smaller than he obtained before, viz. 0''4783, or than most other investigators have deduced. Thus Sir R. S. Ball had found 0''4756, Auwers 0''564, and Struve, Woldstedt, and others values closely according. Prof. Hall appears, however, satisfied with his results, and it should be remembered that Dr. C. A. F. Peters obtained 0''349 for his absolute value of the parallax, the others being only relative parallaxes. Prof. Hall's value for Vega is also rather small, viz. + 0''134 ± 0'0055 from 128 observations, but agrees very much better with other modern determinations: Brünnow in 1869 from the same comparison-star, but by measure of distance and position, and not of differences of declination only, having obtained $\pi = 0''212 \pm 0'0098$. Prof. Hall also attacked the parallax of two other stars, 6 (Bode) Cygni, the parallax of which has recently been determined at Dunsink, being one, and the curious star 40 (♁) Eridani the other. For the former he finds a negative value, whereas Sir R. S. Ball gave $\pi = + 0''422 \pm 0'054$, but only as a "merely provisional" value. The parallax obtained for 40 Eridani, $\pi = + 0''223 \pm 0'0202$ is in fairly close agreement with Dr. Gill's, viz. $\pi = 0''166$. In the early part of this important paper Prof. Hall gives a full discussion, in his usual thorough and painstaking manner, of the value of a revolution of the micrometer-screw employed in the observations.

ASTRONOMICAL PRIZES OF THE ACADEMY OF SCIENCES. The Paris Académie des Sciences have decreed the Lalande Prize to M. O. Backlund for his labours on the motion of Encke's comet; the Valz Prize to M. Bigourdan for his researches on personality in the observation of double stars; and the Damoiseau Prize, for the revision of the theory of the satellites of Jupiter, to M. Souillart, with an encouragement to M. Obrecht of a thousand francs from the Damoiseau fund.

ASTRONOMICAL PHENOMENA FOR THE WEEK 1887 JANUARY 16-22

(FOR the reckoning of time the civil day, commencing at Greenwich mean midnight, counting the hours on to 24, is here employed.)

At Greenwich on January 16

Sun rises, 8h. 1m.; souths, 12h. 9m. 58'8s.; sets, 16h. 19m.; decl. on meridian, 20° 56' S.; Sidereal Time at Sunset, oh. 2m.

Moon (at Last Quarter) rises, 23h. 47m.*; souths, 5h. 41m.; sets, 11h. 24m.; decl. on meridian, 4° 14' S.

Planet	Rises h. m.	Souths h. m.	Sets h. m.	Decl. on meridian
Mercury ...	7 23 ...	11 13 ...	15 3 ...	23 55 S.
Venus ...	8 39 ...	12 55 ...	17 11 ...	19 54 S.
Mars ...	9 4 ...	13 42 ...	18 20 ...	16 24 S.
Jupiter ...	1 23 ...	6 27 ...	11 31 ...	11 42 S.
Saturn ...	15 29 ...	23 35 ...	7 41* ...	22 1 N.

* Indicates that the rising is that of the preceding evening and the setting that of the following morning.

Occultations of Stars by the Moon (visible at Greenwich)

Jan.	Star	Mag.	Disap.	Resp.	Corresponding angles from vertex to right for inverted image
					h. m. h. m.
16 ...	65 Virginis ...	6 ...	2 5 ...	3 5 ...	61 193
16 ...	66 Virginis ...	6 ...	2 48 ...	3 57 ...	44 221
16 ...	12 Virginis ...	5 ...	7 44 ...	8 35 ...	44 318

Jan.	h.		
16 ...	21 ...	Mars at least distance from the Sun.	
17 ...	3 ...	Jupiter in conjunction with and 3° 40' south of the Moon.	
17 ...	4 ...	Mercury at greatest distance from the Sun.	

Variable Stars

Star	R.A.	Decl.	h. m.
	h. m.	h. m.	h. m.
U Cephei ...	0 52'3 ...	81 16 N. ...	Jan. 16, 23 2 m
Algol ...	3 0'8 ...	40 31 N. ...	21 22 40 m
and at intervals of 2 20 48			
λ Tauri ...	3 54'4 ...	12 10 N. ...	Jan. 16, 22 48 m
and at intervals of 20 21 41 m			
δ Libræ ...	14 54'9 ...	8 4 S. ...	20, 2 42 m
U Coronæ ...	15 13'6 ...	32 4 N. ...	20, 21 39 m
W Herculis ...	16 31'2 ...	37 34 N. ...	18, m
U Ophiuchi ...	17 10'8 ...	1 20 N. ...	20, 2 44 m
and at intervals of 20 8			
β Lyræ ...	18 45'9 ...	33 14 N. ...	Jan. 22, 21 0 m
δ Cephei ...	22 25'0 ...	57 50 N. ...	18, 23 0 m

M signifies maximum; m minimum; m₂ secondary minimum.

Meteor-Showers

Near γ Orionis, R.A. 72°, Decl. 4° N. From Coma Berenices, R.A. 181°, Decl. 35° N.; swift streak-bearing meteors. Near x Cygni, R.A. 295°, Decl. 53° N.; somewhat slow meteors.

GEOGRAPHICAL NOTES

THE opinions of Dr. Junker, who is now in Cairo, as to the best route by which to reach Emin Pasha do not help us much. Indeed, Dr. Junker does not commit himself further than to suggest that by the shortest route, through Masai Land, there would be difficulties as to food. Not more, we are inclined to think, than by any other route. Mr. Thomson passed through the country at an exceptionally bad time, when the cattle of the Masai were dying by hundreds from disease. The country is one of the richest game regions in Africa, and by any route an expedition must, as far as possible, be independent of local supplies. For an expedition of hundreds of men to attempt to cross the Victoria Nyanza in boats would be extremely hazardous. Meantime it is evident both from what Dr. Junker says and from the letter of Mr. Ashe, who has just returned from Uganda, that Emin Pasha is in an exceedingly perilous condition, and that every week's delay risks his life and the lives of those who are with him, for he has no ammunition. We hear, on good authority, that Mr. Stanley has decided to go by the Masai Land route; if so, it seems a pity that the only white man who has explored this route will not be in the expedition.

IT is said that great administrative changes are about to be made in Russian Central Asia. According to the St. Petersburg Correspondent of the Times, the whole system of arbitrary military mixed with native government, formerly considered necessary for high political purposes of further conquest, is to be gradually modified and almost abolished by the introduction of Russian civil administration and justice, and the subordination of the various departments to the Ministers in St. Petersburg. There is a proposal that Turkestan and the new Transcaspian province should be amalgamated, the reason alleged being that they will be closely connected by the Transcaspian railway, which, after passing through Bokhara, will terminate at Tashkend. The Transcaspian province will therefore, it is considered, be nearer to Turkestan than to the Caucasus. The scheme is said to have been suggested by General Rosenbach, the Governor-General at Tashkend. It is opposed by General Shepeleff, Director of the Chancery of the Governor-General of the Caucasus, who is of opinion that it would be highly inconvenient to remove the Transcaspian further from the control of the central Government, and that, if alterations are considered necessary, it would be better to make the newly-acquired territory an independent province.

ACCORDING to the *Novoe Vremya*, the trading caravan lately despatched by the Central Asian Commercial Company Koudrine has passed through Kashgar and entered Tibet. This company is likely to play an important part in Central Asia. It has established permanent agencies at Merv and Askabad and in the Persian cities of Kutchan and Meshed, and now it proposes to do the like in Tibet. It has received from the Ameer of

okhara a large tract of land on the banks of the Amu-daria, near the Chardjui station of the Transcaspian Railway, for the cultivation of cotton. In the Transcaspian there seems to be a great district suitable for cotton-growing, and there is a general opinion among the commercial classes of Russia that the development of this industry ought to be steadily encouraged by the Government.

THE *Bollettino* of the Italian Geographical Society for November contains an account of a second expedition by Signor E. Modigliani to Nias, which has proved much more successful than his first visit to that island, reported in NATURE, November 16, 1886, p. 60. His primary object was to discover and ascend the Mount Matsua, 600 metres high, seen by Von Rosenberg from the west coast, and figured on his map as the culminating point of the island. But, although no trace could be found of this mountain, the hitherto unexplored south-western district was traversed from Serombu on the west to Lagundi Bay on the south coast. This district was carefully surveyed, and the explorer succeeded in making rich zoological, botanical, and ethnological collections.

to the Natural History Museum of Genoa. They include no less than twenty-six human skulls (fifteen of which were obtained at Hili Hloro in exchange for a rifle), about 120 birds, 2000 butterflies, 1500 other insects, monkeys, fishes, reptiles, and plants. The journey was made during the summer of 1886, Signor Modigliani's last communication being dated August 10, and forwarded to Europe in Gununur Sitoli, in the north of Nias, where he was then stationed with the intention of continuing his scientific researches in the island.

ON Tuesday evening last Captain Cameron delivered at the London Institution a lecture on "Urua: its People, Government, and Religion." In closing his lecture Captain Cameron said that Urua would shortly come into great prominence, for lately some of the officers of the Congo Free State had followed the river due east, across the great bend of the Congo, showing that it was a navigable river, and that if followed up it would lead to Kasongo's capital. They were frequently hearing of the London Missionary Society's agents pushing up the new great tributary of the Congo on the south, so there could be little doubt that in a short time the Somami would be followed up to Urua, and that traders, missionaries, and others would soon come into the great kingdom of Urua, where there was a great work before them. However, they would have to bear in mind that they would not have to do with a little chief ruling over 200 or 300 natives, but with a powerful monarch who ruled absolutely over his people, and who would allow of no agreement which had not been approved by him. It was to be hoped that, as Stanley had been successful before, he might be successful in his expedition for the relief of Emin Pasha, and also that those who went into Urua would bring civilisation and peace, and be able to do away with the horrors of the slave trade which obtained there owing to the Portuguese and the Arabs. Urua was rich in many kinds of minerals and other products, and the people were a fine race. When the Europeans came into contact with them, if they were wisely managed, there would be a great future for them.

WAR AND BALLOONING¹

THE object which stimulated the practical invention of the balloon was its use in war. I say practical invention, because in theory the balloon was invented before the experiment of Montgolfier. Theory is ever the soil of practice. The idea of the balloon has its starting-point in the principle of the pressure of fluids elucidated by Archimedes, of Syracuse, 200 years before the Christian era. The discovery of hydrogen gas by Mr. Henry Cavendish, in 1760, led Joseph Black, the Professor of Chemistry at the University of Edinburgh, to suggest in one of his lectures that a weight might be lifted from the ground by attaching to it a sphere of hydrogen gas. A fruitful idea once expressed is rarely lost, however casual its first expression. Some years later, Tiberius Cavallo, an Italian merchant, remembered the remark of Dr. Black, and, in 1782, tested its truth by experiment. He first manufactured some paper bags, which he filled with hydrogen gas: to his disappointment, the subtle gas escaped through the pores of the paper. He then collected the gas in soapy water, and the bubble

of gas ascended. A soap-bubble filled with hydrogen was therefore the first balloon. The experiment seems to have been repeated by Cavallo at one of the meetings of the Royal Society, and described in the Transactions of that Society; but neither Cavallo nor his colleague pursued the experiment further, and there was still to be found the peculiar kind of energy that would transform the laboratory experiment into a practical reality. Books are indeed the carriers of thought. It is probably due to a work of Priestley, in which were described those discoveries of Cavallo, and which was translated into French, that Montgolfier, the paper-maker of Annonay, was fired to perform an experiment that is historical. He, as most of you know, filled a paper bag with heated air, the consequence being that the bag rose to the ceiling of the room. Montgolfier was not content with such trifling efforts: a patriotic motive stimulated him to attain greater results—the desire to make the invention of use to France in her wars; and the paper bag of 40 cubic feet capacity was succeeded by one of 680 cubic feet; this, again, by one of 23,000 cubic feet. Montgolfier seemed on the high-road to a brilliant success. There was, however, another brain actively employed in eclipsing the fame of Montgolfier—that of Charles, the Parisian, who realised that heated air would never become a satisfactory method of filling balloons, heated air being three-fourths the weight of the air at the ordinary temperature. He therefore took up the experiments with hydrogen gas where Cavallo had left off. Hydrogen gas being thirteen times lighter than air, its superiority in filling balloons was, to his mind, indisputable. He succeeded in making a material gas-proof, and consequently produced the first practical gas-balloon.

From the efforts of Montgolfier and Charles began the history of ballooning. I do not propose to discuss its general history this evening, with its startling incidents of adventure, nor to enumerate the good service the balloon has rendered to science in the hands of such men as Benedict de Saussure, Robertson, and Glaisher, but to make a few remarks upon its use as an adjunct of war.

By many persons, those who advocate its use in war are looked upon as enthusiasts. With many persons, an enthusiast is synonymous with a fanatic. Now, I agree that enthusiasm is sometimes expended on improper subject-matter—on wild incoherent schemes; but give enthusiasm proper subject-matter, truth, and coherency, and it becomes a noble thing; it is, in fact, the life-blood of science and art. It is, in other words, earnestness of purpose. I think the use of balloons in war is worthy of this earnestness of purpose.

I have to bring before your notice this evening, in particular, a somewhat new departure in balloons, in which electricity is so combined with a captive balloon as to render it valuable for signalling-purposes. Before I describe this special use for balloons in war, which I have had the honour of introducing to the English Government, and for which I hold patents in the principal foreign countries, I will say a few words concerning the general use of balloons in time of war.

The way in which balloons have been chiefly utilised in war is for taking observations of the enemy. In such cases the balloons are captive. As early as 1793 the French Government adopted the use of captive balloons. Such balloons were employed with great success in those wars which the French Government carried on soon after the French Revolution. There was a regular company formed, called "Aérostiers," and it seems to me that more practical work with captive balloons was done in actual war at this period than has been accomplished since. It was Napoleon who put an end to their career of usefulness in France, and who closed the Aeronautical School at Meudon.

It is this use of captive balloons for observations that has lately been revived by the English Government, and experiments are frequently carried on at Chatham under a Committee of the Royal Engineers. Notably amongst those who have been prominent in the revival of balloons for war purposes we may mention the names of Major Templer, Major Elsdale, and Lieut. Mackenzie, and the country, I think, has reason to thank these officers for the really good work they have done with the means at their disposal. At the Inventions Exhibition there was an exhibit of balloons in the War Department. Perhaps the more important feature of that exhibit was a balloon made of gold-beater-skin, such as was used in the war in Egypt. Gold-beater-skin is an admirable substance for forming balloons, on account of its lightness and capacity of holding gas.

The free balloon has its use in war as well as the captive one.

¹Lecture delivered by Mr. Eric S. Bruce, M.A. Oxon., at the London Institution, on December 28, 1886.

At the siege of Paris this use of balloons was demonstrated most efficiently. At the time when the Parisians found themselves cut off from all means of communication there were but a few balloons in Paris, but the successful escape of some aeronauts in these few was considered encouraging enough to establish an aerial highway involving a more wholesale manufacture of balloons than has ever been undertaken, the disused railway-stations being converted into balloon manufactories and training-schools for aeronauts. During four months 66 balloons left Paris—54 being specially made for the administration of Posts and Telegraphs—160 persons were carried over the Prussian lines, 3,000,000 letters reached their destination, 360 pigeons were taken up, of which, however, only 57 came back, but these latter brought 100,000 messages. These facts show that free balloons are useful in war. The utility of a free balloon would be largely increased if it could be steered against a considerable wind. Attempts have been made to navigate balloons on two principles: (1) by using the various currents of the air; (2) by some kind of mechanical propulsion. I will say just a word or two on each of these heads.

(1) As regards mechanical propulsion. There are some persons who, when they hear any suggestion regarding a steerable balloon, denounce the idea as impossible ever to be accomplished. I think it a wiser course to reserve a definite opinion as to whether such a thing is possible in the future, as the experiments worth anything which have been made in this direction have been few and far between, and it is unwise to draw conclusions on a basis of inadequate facts. I will, however, say this much, that those who have the task in hand have a difficult problem before them, and that the engineer who first steers a balloon against a strong wind by mechanical propulsion will deserve a high place amongst the heroes of science. I will enumerate some of the difficulties in the way of steering a balloon against the wind by mechanical propulsion, and then proceed to give you a short description of some of the latest experiments that have been made.

There is an essential difference of condition between navigating the water and navigating the air. In the former we have a body moving within the limits of two media, air and water. These two media have different densities and elasticities, consequently resistances. In air-navigation the body moves in one medium only, which renders the motion of a paddle-wheel entirely useless in that one medium—a paddle-wheel moving in the air would effect nothing—therefore, the only available means of propulsion in air-navigation is the screw: this cuts into the medium. Now it stands to reason that this medium must be in a state of comparative rest, or else the work of the screw will be overpowered. A moderate wind is sufficient to overpower a strong screw, hence the obstacle to air-navigation by mechanical propulsion. Capt. Renard has recently sent in to the French Academy an account of his experiments with his so-called navigable balloon *La France*, at Meudon. His experiments were decidedly interesting—in fact, they were in advance of anything yet accomplished in balloon guidance, but there has, I think, been a tendency to exaggerate the results obtained. I think anyone who reads carefully the accounts of those experiments which appeared in *La Nature* will see that the old difficulty with the screw still remains. The experiments to which I refer took place in comparatively calm weather. It is said that out of seven performances the balloon returned five times to the place whence it started. This is certainly more than most balloons do. To accomplish this, much care and ingenuity must have been exercised; but on reading the accounts, we find that great care was taken for the selection of that kind of weather that would not make the work of the screw *nil*. A whole month, in fact, had to elapse between the first ascent mentioned and the second, owing to unfitness of weather. On the day of the second experiment the wind blew from the north-north-west from Paris at a velocity of from 3 to 3.50 metres per second, starting from Meudon. The balloon was directed towards Paris at 4.25 p.m. It crossed the railway-line at 4.55, reached the Seine at 5 o'clock; at 5.12 the balloon entered the *enceinte* by Bastion 65. Then the aeronauts decided to go home. The balloon was easily turned, and, aided now by the aerial current, reached the exact spot whence it had started. The journey going had taken 47 minutes, the journey back took 11 minutes. Such experiments as these, to my mind, deserve praise, because they were conducted in a scientific manner, and because some results were attained; although the result of navigating a balloon against a wind of considerable power certainly did not come to pass. One must, it

seems, still be content with mere bread-crumbs of aerial navigation.

(2) As regards the second means of navigating the air, by a fit selection of those varying currents that are frequently overlying one another blowing in different directions over the same spot. I think a closer and more methodical study of those currents might lead to satisfactory results. Up to the present time but little has been ascertained concerning them. Unfortunately for aeronautical science its Glaireshers have been few, its mountebanks numerous. It is true there has always been a difficulty in the way of studying the aerial currents from a balloon, namely, the difficulty of keeping the balloon at a certain elevation. After expending ballast to make the balloon rise to a certain elevation for the sake of reaching a particular current, some change of temperature produced by the sun or clouds will often affect the delicately-balanced machine, and alter its altitude. If it has risen higher, gas must be sacrificed to reach the lower level; if it has descended, more ballast must be expended. In this way gas and ballast, which a celebrated aeronaut has called the "life-blood of the balloon," is quickly exhausted. It is these facts that make the successful experiment carried out by M. Lhoste last August so worthy of note. In his voyage across the Channel he made use of an apparatus which he called a "*flotteur frein*." This acted as a kind of floating anchor or brake. It was a cylindrical iron vessel with a conical air-chamber at the top, 1 metre 60 centimetres in length, 22 centimetres in width, weighing 10 kilogrammes when empty, and 60 kilogrammes when filled with salt water. The *flotteur* was attached to a bar underneath the balloon, on which a small sail was hoisted. The important function of this *flotteur* is, that by its means the same altitude of the balloon can be maintained when the favourable current is once found. By means of this *flotteur* the water itself can be drawn up into a reservoir in the balloon and utilised as ballast, after sunrise, when the expansion of the gas by the heat of the sun's rays would otherwise cause the balloon to shoot upwards. By this method of adjusting the altitude of the balloon, several important observations of the various currents of air about which we know so little might be taken, and it would, I think, be well if Governments organised experiments with these various currents, as well as with elaborate screws worked with power inadequate for the purpose of propelling a balloon against a powerful wind. Perhaps the aerial machine of the future may be directed by utilising in a thoroughly scientific manner these varying currents. In such a system of aerial locomotion perhaps the screw may be used as a kind of makeshift in a dead calm, when a change of level is not desirable, like the oars when there is no wind to fill the sails.

One of the most practical uses of balloons in war is for signalling. The utility of balloon-signalling consists in the elevation obtainable. Any accepted method of signalling may be used in the car of an ordinary captive balloon, e.g. flag-signalling or lantern-signalling. But signalling from the car of a balloon necessitates the use of a balloon of considerable size to secure the required lifting-power. This limits the practicability of such a method. About a year and a half ago it occurred to me to so apply electricity to a captive balloon that a method of flashing signals from a balloon is practicable while the operator remains on the ground. Thus the weight of the operator is obviated, and consequently the balloon can be of such a size as to be extremely portable. It is my wish to thoroughly explain to you this method. In the interior of a balloon which is made of a material that is perfectly translucent and filled with hydrogen or coal-gas are placed several incandescent electric lamps. The lamps are in metallic circuit with a source of electricity on the ground. In the circuit on the ground is an apparatus for making and breaking contact rapidly. By varying the duration of the flashes of light in the balloon, it is possible to signal according to the Morse or any other code. To thus place a source of light in the midst of the gas inside a balloon would not have been possible until the development of the electric light. Many persons even now seem to think the proceeding of showing a light inside a balloon a dangerous one. Therefore, before I describe my invention in detail, I will show you a few experiments, after which I think you will realise that the placing of the incandescent lamp inside a balloon is not attended with danger. [Experiment shown.] If I take a jar of hydrogen in my hands, and insert a taper at the mouth, the gas catches fire, but the taper goes out when I thrust it upwards in the jar. You see, hydrogen gas takes fire under certain conditions, but is incapable of itself of supporting combustion. The flame you have seen

urning at the mouth of the jar is the effect of the great affinity which exists between the atoms of hydrogen and the atoms of oxygen which, in the atmosphere of the room, borders upon the hydrogen of the jar. Further up in the jar the hydrogen atoms have no oxygen atoms wherewith to combine. Now, it may seem a surprising assertion to make, but it is nevertheless true that one could place a red-hot poker in the body of gas in a balloon without setting fire to it. If I were to ask anyone here so to do, I am sure he would decline, and say the gas would catch fire as he placed the poker in the mouth. That is quite true; and, to perform the experiment successfully, he would have to avoid the borderland altogether. Here is a puzzle I put to your friends:—How to put a red-hot poker into the body of a gas-balloon without setting fire to the gas. Now, I will show you how to do this. [Experiment shown.] Here is a glass globe, through which a continuous stream of coal-gas is passing. You see this must be so, for I have ignited the gas jet at the top of the globe. Now I have stretched a little piece of platinum wire across the terminals of an electric battery, and placed these terminals inside the globe. Now I will cause the electric current to pass through the piece of wire, and it becomes white-hot, and we have this condition of things: a piece of white-hot metal unprotected inside a globe filled with gas. Now, if we were to substitute a balloon for the globe, and have a battery of exceeding power, and if we were to place a poker between the terminals of the battery, the red-hot poker in a balloon would be a *fait accompli*. The incandescent lamps which we place inside the balloon consist of a thin filament of carbon inclosed in a glass globe exhausted to a high degree of air. This filament of carbon is raised to a white heat by the electric current. [Experiment shown.] I have thrown the image of a filament of carbon upon the screen, rendered thus incandescent. On my table I have another globe filled with gas inside, which is our incandescent lamp. This is the condition of things we have in the balloon. [Experiment shown.] Now, some person may say: "Suppose by accident you get an explosive mixture of oxygen and hydrogen inside the balloon, and that his fragile little bulb breaks." Well, if it does break, one lamp will be lost; that will be all the damage done, for the oxygen present will at once destroy the carbon filament. [Experiment shown.] I will show you this experiment by breaking an incandescent lamp in the midst of this inflammable piece of tow; you see, as I break the lamp, the light instantaneously goes out, as the action of the oxygen is to destroy that delicate carbon bridge which you have seen depicted on the screen. Now, one more of this series of experiments. [Experiment shown.] Here is another globe filled with gas; in this I discharge a naked electric spark between two platinum points. I perform this experiment to show you that, even if there were a bad connection in the electric arrangements inside the balloon, there would be no danger of firing the gas. However, in the special form I provide, I obviate all chance of any sparking, so that, in case of the contingency of there being an explosive mixture of oxygen and hydrogen inside the balloon, there would be nothing to determine it. That an electric spark can fire a mixture of hydrogen and oxygen in certain proportions I can show you by producing his respectable electric spark by means of this induction-machine, and then bringing near it a jet of coal-gas. [Experiment shown.]

A convenient size for one of these signalling-balloons is a gas capacity of some 4000 cubic feet, or, if required, they can be made smaller than this. Varnished cambric is a suitable material. I have two separate arrangements for suspending the lamps inside the balloon; the first consists of a holder made like a ladder, the lamps being placed one above the other in multiple arc. Here is this arrangement before you, with the lamps lit up. This arrangement is convenient because of the small breadth of the ladder, which is easily admitted into the neck of the balloon. The ladder arrangement casts a small shadow on the balloon. In my opinion this shadow is of no consequence whatever; but I have an alternative method which obviates the appearance of any shadow altogether. It consists of a ball, from which project lamps at various angles; the arrangement is protected from risk of breakage by a wire framework. [Experiment shown.]

The form of contact-breaker which produces the intermittent flashes of light is in form somewhat like a Morse key. In reality it is essentially different. An ordinary Morse key, such as is used in telegraphy, would not withstand the large currents used to light the lamps. In my latest form of contact-breaker I use

carbon-contacts. These can be easily renewed at trifling cost when worn away. [Experiment shown.] I have also on my lecture-table another form of contact-breaker [experiment shown], in which there is a rubbing contact faced with platinum. The leads which convey the electric current to light the lamps must be as light as possible, consistent with the current they have to carry, and [experiment shown] here is a special type of cable I have had manufactured for the purpose. By means of the model balloon before you, I will now show you the action of the key. We will flash the words "A Merry Christmas and Happy New Year to you all." [Experiment shown.] On the switch-board which contains the key I have an arrangement to switch on the lights in the balloon continuously, in this manner, because these portable balloons thus illuminated would be useful for other purposes than for flashing signals, viz. for a preconcerted signal, or as a "point-light" to guide advances or retreat.

The source of electrical power for working the lamps inside the balloon may be varied according to circumstances. It may be: (1) a small dynamo; (2) a storage battery; (3) a primary battery. Each of these three forms of power can be supplied in portable and convenient form. In some cases, where there is a stationary dynamo-machine in close proximity, storage-cells may be conveniently used, as they can be charged from this stationary dynamo, and brought into the field as required. I used storage-cells just now to light up that ladder of lamps and for working the lights in my model balloon. These storage-cells are, you see, arranged at the foot of my lecture-table. A portable way of obtaining power would be, I think, to use a little gas-engine with dynamo combined, such as, by the courtesy of Messrs. Crossley Brothers, I am enabled to show you this afternoon at work. [Experiment shown.] This might be fixed on the waggon, with all the other apparatus connected with the balloon. The engine would be worked by the gas, which is always a necessary adjunct to the balloon. The gas-supply might be a portable apparatus for generating the gas, or else the method of storing gas in steel bottles could be adopted. This has been done successfully by our own Government. At the Inventions Exhibition a bottle of compressed gas was exhibited in the War Department. I now wish to show you how easily gas may be compressed, stored up, and used when wanted. Here is a small bottle of compressed hydrogen, and I will soon transfer the gas from that to this goldbeater-skin balloon, which now rises to the ceiling. [Experiment shown.] There is another method of lighting these balloons—by using a primary battery. There is a very excellent primary battery now in the market, invented by M. Schanschieff. A good primary battery has long been a great desideratum. For some time I have searched to find one that was anything near the mark for electric lighting purposes. This battery which is before you is the best I have had in my hands, and I am applying it to several of my patent arrangements. I am glad to be able to show you one of these batteries in working order. [Experiment shown.] In this comparatively small compass we have 32 cells. The size of each cell is $3\frac{1}{2}$ inches by 2 inches. In the cells we have a single fluid solution—sulphate of mercury acidulated. There is a sample of the sulphur in this bottle. Now, with most single-fluid batteries we have what is technically called polarisation, which means diminution of electric power. Mr. Schanschieff has overcome this polarisation, and in overcoming it he has done a great deal towards the development of electrical appliances. There is one piece of apparatus connected with the balloon worth mentioning. This is the reel for winding the cable. [Experiment shown.] The electric connection is made, you see, as the cable unwinds.

The advantages which I claim for this method of signalling are, briefly: It facilitates night-signalling; it facilitates signalling to long distances; and in places where the ordinary methods would fail to be of any use, such places as hilly and wooded districts, the apparatus is portable and simple; the balloon shows a large body of light. In order that you may realise the use of a balloon in time of war in a place where ordinary signalling would be of no use whatever, I have prepared the illustrations which my assistants will now throw upon the screen. Here we have a mountainous region. There are supposed to be two friendly armies separated by chains of mountains, and wishing to communicate. Now these two armies might be possessed of every other modern appliance for signalling from the ground without being able to make a signal seen by either side. Therefore, in the scene before you, the signallers of one army are depicted as filling the portable signalling-balloon with gas

preparatory to the ascent for purposes of signalling. The army on the other side of the mountains has already sent up a similar balloon. The next scene shows a nearer balloon ascended to a certain height. Now the two balloons are about to communicate. You see the flashes of light from the balloon.

Although this invention is not two years old, it has already a short history. It was exhibited in model in the War Department of the Inventions Exhibition, and while on exhibition there the method was referred for Government trial under a Committee of the Royal Engineers at Chatham. During the time the model was being exhibited at South Kensington, some experiments were tried with a balloon of 4000 cubic feet capacity at the Albert Palace. In this balloon were placed six lamps worked to 16 or 20 candle-power. The six lamps took a current of some 9 amperes, and the electromotive force was 24 volts. The source of electric power then used was 25 cells of the Electrical Power Storage Company. During this Exhibition the value of the method for long-distance signalling was well tested, the flashes of light from the balloon being observed as far as Uxbridge, a distance of sixteen miles. This was effected by less than 100 candle-power. I used the same apparatus for the Government trial at Chatham, after which trial I received an order from the War Office to supply some of my apparatus to the Royal Engineers. The system was again tried at Aldershot under the Signalling Department. On the day fixed for the trial there was a snowstorm and a fog, two very unfavourable conditions in a system of signalling, but signals were read and answered from my balloon, in spite of snow and fog, by the signallers stationed some few miles off. As I mentioned the other day at a meeting of the Aeronautical Society, I wish, as the inventor of this system, to see it tried to its utmost capacity, and I purpose to put the system myself shortly to the most rigorous of tests. One of those tests will be, I hope, to signal over the Channel, *i.e.* to send up the balloon on some site on the English coast, probably Dover, and observe whether the balloon can be seen on the French coast. The Channel is by no means the most favourable expanse for signalling, for there are frequent fogs in it to obscure the view. The Channel, however, is a time-honoured and popular measure of distance, and I must repeat here the wish I expressed lately at the meeting of the Aeronautical Society, that, if the flashes of light can be observed over that expanse, I hope the public will look upon the accomplishment, not as a sensational feat, but as showing the practical value of balloon-signalling. Up till lately I have only considered my system as being useful to the army. I think, however, it would be also useful to the navy. I have schemed a method of employing these balloons on board ship. Their greatest use in the navy would be, I think, for coast-signalling—signalling round corners; I have been asked to submit this scheme to the Admiralty, and am preparing to do so. The picture now before you represents its use in the navy on board a ship stationed in a bay, which vessel wishes to communicate with another at the other side of the cliffs which form the bay. It is, as you see, night-time. The ship that is not visible to you sends up the balloon, and now the two balloons commence signalling to each other. [Experiment shown.]

You may perhaps be inclined to think that I ought to mention some one particular occasion in history when this balloon would have been useful. I do not think we need look far back to find one example. But a short while ago there was a brave general shut up in a besieged city with a few followers. Near at hand there were friends ready to help, but ignorant of the immediate necessity of that help. Need I name that general and that city? Now, if from Khartoum there could have arisen such an electric signalling-balloon as I have described to-day, its flashes of light

in the skies would have told the tale of the events below—a tale that would have been eagerly read—and perhaps that brave general would then have left Khartoum, a conqueror, and with his life spared for the future service of his country.

SOCIETIES AND ACADEMIES

LONDON

Royal Society, January 6.—“Preliminary Note on the Continuity of the Liquid and Gaseous States of Matter.” By William Ramsay, Ph.D., and Sydney Young, D.Sc.

For several years past we have been engaged in an examination of the behaviour of liquids and gases through wide ranges of temperature and pressure. The results of our experiments with ethyl alcohol have recently been published in the *Philosophical*

Transactions; those with acetic acid in the *Transactions* of the Chemical Society; and the Royal Society have in their hands a similar investigation on ether. We have also finished a study of the thermal properties of methyl alcohol.

In consequence of a recent publication by Wroblewski, of which we have seen only the abstract (*Berichte*, 1886, p. 728, abstracts), we deem it advisable to communicate a short notice of an examination in which we are at present engaged.

We find that with the above-mentioned substances, acetic acid excepted, whether they are in the liquid or gaseous state, provided volume be kept constant, a simple relation holds between pressure and temperature. It is $p = \beta T - a$. This is evidently a simple modification of Boyle's and Gay-Lussac's laws; for at

pressures, where volume is large, the term a approaches and finally equals zero, while b diminishes and finally becomes equal to the value of c , calculated from the ordinary equation,

$$p = \frac{cT}{v}$$

We have as yet only had time to apply this formula with ether ther to the liquid state; and as we are not yet quite certain whether the relation holds for volumes between 4 and 20 c.c. of gramme of ether, we are at present engaged in measurements of volumes and pressures at temperatures between 220° and 280°. Assuming the above relation to be true (and it is at all events a close approximation to truth), it is possible to calculate those portions of isothermals included within the liquid-gas area, and presented in Andrew's diagram by horizontal straight lines. We have calculated a few of these isothermals for ether, and find that the areas above and below the horizontal lines (see woodcut) are equal, when measured by a planimeter.

Reserving a full discussion of the subject until the completion of our experiments, we would here point out the similarity between the equation $p = bt - a$ and those proposed by Clausius and by van der Waals to represent these relations. Clausius's

formula is

$$p = \frac{RT}{v-a} - \frac{c}{T(v+\beta)^2}$$

and van der Waals'

$$p = \frac{RT}{v-b} - \frac{a}{v^2}$$

In these formulæ Clausius's a and c are equivalent to van der Waals's b and a respectively, but R has a different signification.

We find that a somewhat similar formula agrees better with experiment than either of the above; it is

$$p = \frac{RT}{v-b} - \frac{a}{T^2 v^2}$$

where R , b , and a have the same meaning as in van der Waals's formula. This formula expresses the results of experiments with great accuracy, where the volume of 1 gramme of ether occupies not less than 25 c.c.; but at smaller volumes it ceases to represent the facts.

It is to be noticed that both Clausius's equation and ours introduce T into the denominator of the second term; they evidently differ from our first equation $p = bt - a$, in which a is independent of temperature.

We shall soon be in a position to communicate the results of this investigation, giving full data.

PARIS

Academy of Sciences, January 3.—M. Gosselin, in the chair.—A new method of determining the constant of aberration, by M. Loewy. M. Nyren having shown that none of the methods hitherto adopted are free from systematic error, the author here proposes a process by which all instrumental errors may be avoided. It also eliminates the effects of precession and nutation, and enables the observer to take accurate account of the proper movements of the stars without depending on their approximate values drawn from the catalogues. Lastly, it neutralises the parallactic effect of the stars, dispensing with the numerous experiments needed to determine the instrumental constants. In a word, it calculates directly the phenomenon of aberration itself, without employing any physical constant.—On the relations of the lactiferous vessels with the fibro-vascular system, and on M. J. Vesque's aquiferous apparatus of *Calophyllum*, by M. A. Trécul. Further researches are described confirming the conclusion already announced by the author regarding the numerous points of contact between the milk-yielding vessels and the various elements of the fibro-vascular system in a large number of plants. It is further shown that the anatomical results described by him in the year 1865 are amply confirmed by M. Vesque's recent note on the aquiferous apparatus of *Calophyllum Calaba*.—Actinometric observations made during the year 1886 at the Montpellier Observatory, by M. A. Crova. The comparative study of these observations (made by M. Houdaille with the author's actinometer) with those of the three previous years confirms the conclusions already arrived at regarding the annual variations of calorific intensity in the solar rays.—Note on the diurnal nutation of the terrestrial globe, by M. Folie. The important consequences of the existence of this phenomenon for geology, astronomy, and

geodetics are pointed out, and it is shown that it places beyond doubt the fluid state of the interior of the globe surrounded by a relatively thin outer crust.—Note on the Maclaurin series in the case of a real variable, by M. O. Callandreau.—On a class of differential equations, by M. Emile Picard.—Observations relative to M. P. Serret's recent note on a geometrical theorem, by M. L. Lindelöf. A slight error is pointed out in M. Serret's calculation establishing the correspondence between the lines of curvature in two surfaces with reciprocal vector rays.—Note on the problem of electric distribution, by M. H. Poincaré. The author points out the defective character of the method proposed by MM. Neumann, Schwarz, and Harnack for solving this difficult problem.—Remarks respecting M. Hirn's observations on the flow of gases, by M. Hugoniot. The author returns with regret to this subject, and makes some final remarks on M. Hirn's paradoxical inferences, calling upon him to present a complete statement of his experiments, and of the causes of the errors he professes to have detected in the calculations of the upholders of the kinetic theory.—Note on the specific heats of a perfect gas, by M. Félix Lucas. On theoretic grounds it is argued that the two specific heats of a perfect gas become increasing functions of the temperature.—On the nature of the electric actions in an insulating medium (second communication) by M. A. Vaschy. These problems of electro-statics are brought into general relation with those dealing with the equilibrium of the ether regarded as an elastic body. It is hence inferred that the electric perturbations must be propagated with a uniform velocity, just as a mechanical concussion is propagated in an isotropic body, and this velocity must be that of light.—On electric pressure and on electro-capillary phenomena, by M. P. Duhem.—On a phosphate of hydrated silica, by MM. P. Hautefeuille and J. Margottet. From three analyses made with specimens obtained from different preparations it is shown that the formula of this substance is $\text{SiO}_2 \cdot 2\text{PhO}_2 \cdot 4\text{HO}$.—Action of sulphur on ammonia and on some metallic bases in the presence of water, by M. J. B. Senderens. These researches have been carried out in continuation of MM. Senderens and Filhol's studies in connection with the action of sulphur on the saline solutions and on those of soda and potassa.—Note on the maxima vapour tensions of acetate of soda, by M. H. Lescœur. M. Berthelot's conclusion that there is no isomery either between the solid salts or between the diluted solutions of the various acetates of soda, are fully confirmed by the results here obtained by a different process.—On the preparation of the isobutylamines, by M. H. Malbot. It is shown that the three isobutylamines are formed in proportions differing little from each other, the operation constituting an effective method of preparing all these amines simultaneously.—Isomery of the camphols and camphors, by M. Alb. Haller. Here the author deals with the camphols of madder, of Borneo (*Dryobalanops camphora*), and of yellow amber.—Heat of formation of some alcoholates of potassa, by M. de Forcrand. Determinations are given for the heat of formation of the propylate and isobutylate of potassa.—On some points relating to the action of saliva on the grain of starch, by M. Em. Bourquelot.—Experimental researches on mercurial intoxication, by M. Maurice Letulle. The paper deals especially with the paralytic accidents and lesions of the surface nerves caused by this intoxication (chronic hydrargyris).—Studies of the relations existing between the cranial nerves and the cephalic sympathetic nerve in birds, by M. L. Magnein.—Note on the red and white muscles in the rodents, by M. L. Ranvier.—Observations relative to M. Maupas' recent note on the multiplication of *Leucophrys patula*, by M. Balbiani. It is shown that the peculiar process of fissiparity in these organisms is not such a rare phenomenon as is supposed by M. Maupas.—On the line of development followed by the embryo of bony fishes, by M. L. F. Henneguy. The author's researches confirm the conclusions already arrived at by Kupffer and Cellacher.—On the amphipod crustaceans of the west coast of Brittany, by M. Edouard Chevreux.—Observations relative to M. Viguier's note on the so-called ophite rocks of the Corbières, and to M. Depéret's communication on the Devonian system of the Eastern Pyrenees, by M. A. F. Nogues.—Microscopic examination of the ashes ejected by the Krakatō volcano, by M. Stanislas Meunier.—A critical examination of certain rare minerals, by M. A. Lacroix. Descriptions are given of pterolite, villarsite, grängesite, and gammagrängite.—The death was announced of M. Francisque Pontannes, a distinguished geologist, who was awarded the Academy's Grand Prize for the Physical Sciences in 1883.

BERLIN

Physical Society, November 19, 1886.—Prof. du Bois-Reymond in the chair.—Prof. Liebreich reported on phenomena he had observed in the course of experiments respecting slowly-proceeding chemical reactions. If hydrate of chloral were mixed with an alkaline solution, then was chloroform formed in the shape of a white precipitate. This reaction occurred with all alkaline solutions, only the time varied according to the alkali. While, however, chemical reactions usually ensued in the whole mass of the reacting substances, it was here observed that, when the process of mixture was effected in a test-glass, the uppermost layer remained clear, no turbidity and precipitate formation occurring in it. This layer, which the speaker named the "lead space" ("todter Raum"), was bounded on the upper side by the meniscus of the fluid, and on the lower side by a sharp boundary, having, apparently, a curve opposed to the meniscus. In the capillary space between two glass plates, the dead space displayed itself in very beautiful formation. In horizontal capillary tubes the dead space came into shape at both ends, and in very short capillaries the reaction failed entirely. If from the dead space a little clear fluid were withdrawn and warmed, then did the reaction set in. This showed that in the dead space both fluids were contained, and that it was only their chemical action that was prevented. The dead space showed itself in drops at the edge of the curve. In the capillary space between two menisci was found an external ring, and the middle clear, while reaction occurred only in a small ring. If tubes were closed by a membrane above and below, and filled with the mixture of hydrate of chloral and alkali, then did the dead space appear both at the top and the bottom. The same phenomenon presented itself likewise in animal membranes—for example, in a rabbit's bladder or in an intestine. On the other hand, the dead space was observed neither in a gutta-percha alembic nor in a similar shaped glass retort. The speaker also discussed many other sorts of phenomena in respect of the dead space, both with the fluids already named and with other fluids, demonstrating a large part of them by experiments. In conclusion, he set up the hypothesis that, in the experiments referred to, the chemical reaction was hindered by phenomena of surface-tension, a matter which should be further investigated by additional experiments. A lengthy discussion followed this paper.—Dr. Weinstein then reported on a publication of the Normal Standard of Weights and Measures Commission, "Construction and Repeated Trial of the Principal Standards and the Control Standards" ("Die Herstellung und Wiederkehrende Prüfung der Hauptnormalen und der Controllnormalen"). He brought out that in this publication the idea of weight was officially defined by a mass, the unit of which, the kilogramme, was equal to a cubic decimetre of distilled water at 4° C. The trial of the normal metre of platinum resulted in the establishment of its invariability. The kilogramme of platinum was likewise unchanged, while, on the other hand, the control standard-kilogramme showed a slight increase of weight through oxidation. The examination of the dry measures resulted in showing a considerable diminution of volume, a fact which would have to be ascribed to elastic and thermal after-effects in the material that had been employed for the standard dry measures.

Physiological Society, November 26, 1886.—Prof. du Bois-Reymond in the chair.—After the re-election of the President and Council, in accordance with the statutes of the Society, and the disposal of several business motions, Prof. Falk communicated a case taken from his forensic practice, which was not without physiological interest. A boy was run over by a heavy van and in a few minutes died. A *post-mortem* showed a gaping rupture of the thyroid and of the cricoid cartilage, the entrance of blood into the air-passages—causing death by suffocation—and into the digestive organs. It was, now, a remarkable and physiologically interesting fact that the blood had penetrated not only into the stomach, but into the small intestine, and that, as far as the neighbourhood of the coccum. Seeing that the abdominal organs were perfectly intact, and the intestines even to a high degree anæmic, the blood must have proceeded from the stomach, and that during the brief time of the agony; for peristaltic movements appeared indeed after death, but in no case in the stomach, and the passage of the contents of the stomach into the intestine was never observed after death had set in. The speaker had, on the other hand, observed very violent

swallowing movements as well as increased peristaltic movement in the intestine and stomach in men, and especially in his experiments with animals during the agony of suffocation. In the discussion following, Prof. Zuntz corroborated the fact of the appearance of increased peristaltic movements, and of the abnormally far advance into the intestine of the contents of the stomach during death by suffocation, citing, as he did, some earlier experiments he had not yet published. By way of testing the assertion proceeding from the laboratory of Prof. Ludwig, that acid chyme was normally found in the small intestine of animals, he had instituted experiments in which very soon after death he opened the abdomen of animals, and by a ligature isolated the small intestine from the stomach; he then in every case found the contents of the intestine neutral or alkaline. If on the other hand he poisoned the animals, as in the case of Ludwig's experiments, with curare, then were the contents of the intestine acid. The cause of that, however, was that the animals had died from suffocation, and that the asphyctic blood had induced a lively peristaltic movement of the smooth intestinal muscles not paralysed by curare, and so, therefore, an abnormally rapid propulsion of the contents of the stomach into the small intestine.

BOOKS AND PAMPHLETS RECEIVED

Mind, January (Williams and Norgate).—The Cruise of the *Marchesa* to Kamchatka and New Guinea, 2 vols: F. H. H. Guillelard (J. Murray).—Proceedings and Transactions of the Royal Society of Canada for the Year 1885, vol. iii. (Montreal).—Journal of Anatomy and Physiology, January (Williams and Norgate).—Elements of Harmony and Counterpoint: F. Daventry (Longmans).—Bees and Bee-keeping, vol. 1, parts 11, 12, 13, vol. ii., parts 1, 2, 3, 4: F. R. Cheshire (Gill).—Journal of the Chemical Society for January, and Supplementary Number (Van Voorst).—Journal of the Scottish Meteorological Society, third series, No. 3 (Blackwood).—Le Mesure du Mètre: W. de Fonvielle (Hachette, Paris).—Annalen der Physik und Chemie, 1886, No. 12 (Leipzig).—Beiblätter zu den Annalen der Physik und Chemie, 1886, No. 11 (Leipzig).—Text-book of British Fungi: W. D. Hay (Sonnenschein).—Hand-book of Practical Botany: Strasburger and Hillhouse (Sonnenschein).—Historical Basis of Modern Europe: A. Weir (Sonnenschein).—The Primula: Report on the Primula Conference (Macmillan).—Resa till Grönland: Nik O. Holst.—Proprietà Industriale (Roma).—Beiträge zur Statistik der Blütschläge in Deutschland: Dr. G. Hellmann (Berlin).—History and Biology of Pear-Blight: J. C. Arthur.—An Address before the American Association for the Advancement of Science: T. C. Chamberlin (Salem).—Jahresbericht Am., 25. Mai, 1886, dem Comité der Nicolai-Hauptsterne (St. Petersburg).—Gründzüge einer Theorie der Kosmischen Atmosphären: W. Schlemmüller (Prag).—Ueber die Allgemeine Beugungsfigur in Ferrnröhren: H. Struve (St. Petersburg).

CONTENTS

PAGE

Science and the Jubilee, II.	241
Marine Engineering	242
An Arctic Province	243
Antiquities of Spain and Portugal	244
Our Book Shelf.—	
"Educational Exhibits and Conventions at the World's Industrial and Cotton Centennial Exposition, New Orleans, 1884-85"	245
Ziegler's "Text-book of Pathological Anatomy and Pathogenesis."—Dr. E. Klein, F.R.S.	246
Noble's "Hours with a Three-Inch Telescope"	246
Harley's "Lunar Science"	246
Letters to the Editor:—	
Mr. Wallace on Physiological Selection.—Dr. George J. Romanes, F.R.S.	247
Meteor of December 28, 1886.—W. F. Denning	248
The Production of Ozone.—W. H.	248
John Arthur Phillips, F.R.S.	248
Botanical Federation in the West Indies. By D. Morris	248
Art and Science in a New Light	250
The National Science Collections	252
Notes	254
Our Astronomical Column:—	
The Six Inner Satellites of Saturn	257
Stellar Parallax	258
Astronomical Prizes of the Academy of Sciences	258
Astronomical Phenomena for the Week 1887	258
January 16-22	258
Geographical Notes	258
War and Ballooning. By Eric S. Bruce	259
Books and Pamphlets Received	264

THURSDAY, JANUARY 20, 1887

THE IMPERIAL INSTITUTE

FOR some time before the scheme of the Prince of Wales's Committee was before the public, there was a feeling that it seemed only too probable that the Imperial Institute would be merely a show-place for the amusement of sight-seers and for the benefit of the showmen. Happily this danger has been averted. Prof. Huxley and others have sounded a note which has now brought the real basis of trade and commerce to the front. It is possible that the mere trade-product view will now give way, so that we may hope the scheme in its final form will be hardly less scientific than that sketched by us in the first of our articles on "Science and the Jubilee" (p. 217). If this anticipation is realised, the Institute will be in every sense a worthy memorial of the fiftieth anniversary of the Queen's reign, and will prove to be of enduring benefit to the whole Empire. There cannot be the slightest doubt as to the necessity for a vital change in our national way of regarding scientific as if they were opposed to industrial methods. There was a time when England, with her monopoly of coal and iron, had practically no competitors in the great markets of the world. By the splendid achievements of her inventors, and by the energy and promptitude of her manufacturers and traders, she had got so far—having such a monopoly of raw material—ahead of her rivals that the foremost place in commerce seemed to belong to her by a sort of natural right. Within the lifetime of the present generation all this has been changed. France, Germany, and other nations gradually became aware that they also, if they pleased, might play a prominent part in the industrial movement, and they set to work in the right way to fit themselves for the new conditions of modern life. Recognising that permanent success could be accomplished only by knowledge and organised effort, they provided for the education both of employer and employed by the establishment of schools, and by every means at their disposal encouraged the development of science. The consequence is that England has been driven from some markets in which she was formerly supreme, and that in others she finds it hard to maintain her ancient predominance. There is not the faintest chance that she will recover the ground she has lost unless she chooses to adapt herself to the altered circumstances by which she is surrounded. In commerce, as in all other relations, it is the fittest that survives; and if raw material fails, then greater knowledge alone can triumph; and the fittest commercial nation is the nation which equips its workers with the most exact knowledge, the most alert intelligence, and the most thorough technical skill. If the Imperial Institute is founded and carried on in accordance with the best and most characteristic ideas of our time, it may make Greater Britain greater yet, if it helps to bring British industry under the dominion of the scientific spirit; and to secure for it this magnificent position ought unquestionably to be the aim of all who undertake to press its claims on the attention of the public.

This aspect of the subject was kept prominently in view
Vol. xxxv.—No. 899

by all the principal speakers at the meetings in St. James's Palace and the Mansion House last week. The Prince of Wales laid the strongest emphasis on the fact that, in all parts of the civilised world, commerce and manufactures have been profoundly affected by the progress of science. "I have, on more than one occasion," he said, "expressed my own views, founded upon those so often enunciated by my lamented father, that it is of the greatest importance to do everything within our power to advance the knowledge, as well as the practical skill, of the productive classes of the Empire. I therefore commend to you, as the leading idea I entertain, that the Institute should be regarded as a centre for extending knowledge in relation to the industrial resources and commerce of the Queen's dominions. With this view it should be in constant touch, not only with the chief manufacturing districts of this country, but also with all the colonies and India. Such objects are large in their scope, and must necessarily be so, if this Institute is worthily to represent the unity of the Empire."

Prof. Huxley spoke at the Mansion House and, of all the speeches delivered there, his was the most striking. As the present needs of the nation, and how an Imperial Institute might be made to help us, are never likely to be more lucidly or more impressively stated, it seems to us that we shall do our readers good service by printing the speech in full. Seconding the resolution proposed by Lord Rothschild, "That this meeting pledges itself to take all practicable steps to assist in the formation of the Imperial Institute, and to support it when brought into existence," Prof. Huxley said:—

"He wished to state, very briefly, his opinion of the value of the proposed Institute from the point of view of a man of science. The epoch coincident with Her Majesty's reign was remarkable above all corresponding periods of human history that he knew anything about for two peculiarities. One was the enormous development of industry, and the other was the no less remarkable and prodigious development of physical science, which two developments, indeed, had gone hand in hand. The opinion which he was now expressing was not one formed *ad hoc* for the purpose of this meeting. It was one which he expressed two or three years ago when taking leave of the Royal Society. It was a matter which was perfectly obvious to any person who had paid attention either to the history of science or to the history of industry, that there had been nothing, not only in any period of fifty years, but in any century, in the slightest degree comparable with the magnitude and the importance of the growth of those two branches of human activity which had taken place since 1837. His memory went back far enough to call to mind with great vividness a period when industry, or, at least, the chiefs and the leaders of industry, looked very much askance at science. The practical man then prided himself on caring nothing for it, and made it a point to disbelieve that any advantage to industry could be gained by the growth of what he was pleased to call abstract and theoretic knowledge. But within the last thirty years more particularly that state of things had entirely changed. There began in the first place a slight flirtation between science and industry, and that flirtation had grown into an intimacy, he might almost say courtship, until those who watched the signs of the times saw that it was high time that the young people married and set up an establishment for themselves. This great scheme, from his point of view, was the public and ceremonial marriage of science and industry. I

THE BLASTOIDEA

Catalogue of the Blastoidea in the Geological Department of the British Museum (Natural History); with an Account of the Morphology and Systematic Position of the Group, and a Revision of the Genera and Species.
By Robert Etheridge, Jun., and P. Herbert Carpenter, D.Sc., F.R.S. Illustrated by 20 Lithographic Plates, &c. (London: Printed by Order of the Trustees, 1886.)

THIS important memoir is in all but in name a monograph of the interesting group of extinct Echinoderms first called Blastoidea by Thomas Say in 1825. It originated, the authors tell us, some seven years ago, in a desire to investigate the structure and relationships of this group by the light of the recent advances made in our knowledge of their living representatives.

Echinoderm structure owes much to the genius and labours of Johannes Müller, and a knowledge of the results of his inquiries largely influenced Prof. F. Roemer in preparing his classical work on the Blastoidea. Recent investigations have added enormously to our knowledge of the structure of the Stalked Echinoderms, so that a renewed morphological examination of their extinct allies was in every way desirable, and this we have now before us. The authors were indebted for much kindly aid in the examination of specimens to a whole host of friends, among whom it seems desirable to mention more especially Mr. Wachsmuth, who sent from America a selected series of forms from his fine collection of American Blastoidea, thus enabling the authors to form their own views on many points of structure. He also supplied them with recent information as to the progress of his own investigations among the American species.

The memoir begins with a chapter on the bibliographical history of the group, commencing with the paper by Say in the *Journal of the Philadelphia Academy of Natural Science* for 1885. Roemer's monograph appeared in 1852. Billings, in 1869, published a series of important memoirs, in which he suggested that the remarkable lamellar tubes beneath and between the ambulacra appeared to have served the function of respiration, and designated them as "hydrospires;" the summit openings in connection with them were called "spiracles." Wachsmuth's valuable contributions commenced in 1877, while in 1882 the present authors began a series of memoirs, which have now culminated in the present work. A second chapter treats of the Stem and Calyx. The stem of the Blastoidea would appear to be but little known, since individuals in which the stem remains attached to the calyx are rarely found. Mr. Wachsmuth has a slab of *Pentremites*, in which three specimens have stems of between 5 and 8 inches in length, and the best preserved stem examined by the authors is figured as occurring beneath the calyx of *Granatocrinus norwoodi*, where it is seen to consist of some small thin discoidal joints, which are so little characteristic, that if found isolated it could not be certainly said whether they belonged to a Blastoid or a Crinoid. Though all the Blastoids may have had stems in their early stages, some appear to have had no stem in their adult state. It will be remembered that the

adult *Comatula* shows no trace whatever of having at one time been a stalked form. The calyx is described at great length and with great clearness, and the views of Wachsmuth and others are criticised. Chapter III. is devoted to the study of the Ambulacra, and the fourth chapter to the Summit Plates. These latter were first discovered by Owen and Shumard (1850) forming a conical covering of small plates over the oral and ovarial apertures on a specimen of *Pentremites godoni*. With the exception of Hambach, no recent palæontologist disputes that these plates are an integral part of the organisation of a Blastoid. The chapter on the Hydrospires and Spiracles is full of interest. The former can in no way be regarded as a respiratory portion of the ambulacral system, while the analogy of recent Crinoids goes to show that the ambulacral groove of the Blastoids was a ciliated food-groove, and that it was not occupied by any portion of the generative system; but the authors adopt Ludwig's comparison of the marsupial pouches (genital bursæ) of Ophiurids with the Blastoid hydrospires. The zoological position of the Blastoids is still regarded as a subject of discussion, though it would seem that Say's opinion is correct, and that the Blastoidea may be regarded as a group intermediate between the Crinoidea and Echinoidea. As to the distribution in time, there is no certain evidence of the existence of true Blastoidea anterior to the Upper Silurian period, and it is curious that all the known species of this period are confined to North American strata. The Devonian rocks of the British Islands have yielded but imperfect traces of them. The Lower Devonian rocks in France and in Belgium have each yielded a single Blastoid, but the great centre of their development in Europe during this geological period was in the north of Spain. In North America they were, on the contrary, largely represented, both in generic and specific forms. Regarding the Blastoids of the Devonian system from a general point of view, the number of genera was largely increased at the close of the Silurian period, and all the families are to be found represented in the Devonian period. *Pentremites*, which is the type form of the class, did not make its appearance until the Devonian. The Carboniferous rocks of the British Islands are rich in Blastoid forms, which are also to be found in Belgium, and were well developed in the sub-Carboniferous rocks of North America. No Blastoid is common to America and Europe, and in Europe the range of specific forms is very limited, though one species is found common to the Devonian of Spain and Germany, and one to the Carboniferous rocks of Britain and Belgium.

A most useful stratigraphical list of all known species, arranged geographically, is given, and then follows the descriptions of the species, to which it is not needful to allude further than to state that the greatest care has been taken, not only with the diagnoses, but with the synonyms and the distribution. A copious index and twenty beautifully executed plates complete the volume. Some sixteen of the plates were drawn on stone by the aid of a grant from the Government Grant Fund of the Royal Society, and, with the approval of the Council, and certainly to the advancement of science, were transferred to the Trustees of the British Museum, by whose order this "Catalogue" has been published.

TEA-PLANTING IN CEYLON

The Tea-Planter's Manual. By T. C. Owen. Pp. 162, with Coloured Lithographed Plates of an Iron and a Wood and Stone Tea Factory drawn to scale. (Colombo, Ceylon: A. M. and J. Ferguson, 1885)

EIGHT years ago, on account of the depression in the coffee industry of Ceylon, the prospects of the colony were of a sufficiently gloomy character. A great improvement has, however, been effected by the partial substitution of tea and cinchona for coffee, and by the general attention given to cacao, cardamoms, and other subsidiary subjects. Ceylon has also been fortunate in possessing a practical scientific institution in the Botanical Gardens of the colony; and its local press is enterprising and well-informed.

It is well to mention here that the excellent growth made by tea plants at the Perideniya and Hakgala Gardens fully justified the advocacy of tea-planting in Ceylon by the late Dr. Thwaites in his Annual Reports, while it is also due to the Colonial Office to state that through Lord Blachford it warmly supported the introduction of Assam tea plants into Ceylon in 1867. In 1877 Ceylon tea in commercial samples was submitted, through the Royal Gardens, Kew, to the Indian Committee of the Society of Arts, and the Report of this Committee clearly foreshadowed the high place which Ceylon tea has since taken in the London market.

The present manual is one of a series issued by the *Ceylon Observer* press, and is intended to be a complete hand-book to all the multifarious duties of a successful tea-planter. Colonel Money's "Essay," and the "Tea-Planter's Vade Mecum," both publications having special reference to the circumstances of Indian gardens, have hitherto been the only books on the subject.

As stated in the preface, Mr. Owen's manual "is more a compilation of the opinions of others and the results they have arrived at than an original work." The very valuable notes of one of the earliest and most successful of Ceylon tea-planters, Mr. Armstrong, of Rookwood, form an important portion of the book. The compiler wisely avoids an extended disquisition on the original home of the tea plant and on the question whether the "Assam tea tree" and the "China bush" are specifically distinct. In the latest works on the subject they are both included under *Camellia theifera*, Griff. There is no doubt that the Assam tea tree—for in a wild state it often reaches 40 to 50 feet in height—is indigenous to the mountainous district lying between South-Western China and the River Brahmaputra. It is probable also, although not clearly proved, that the China tea plant—of a somewhat shrubby habit—is derived from the same stock; although, as we now know, it was greatly altered by persistent cultivation for several centuries in a soil and climate different from those of its original home. The China tea plant has been found wild in no part of China. Under cultivation in Ceylon the Assam variety is suited to the plains, a hybrid form is sought for mid-elevations, while the China variety is useful only for the highest elevations up to 6000 and 7000 feet. Mr. Owen recommends that for all new plantations the best "jat" of Assam or hybrid plants should be obtained, as "no amount of care or skill will make up for a bad class

of plant put into the garden at the outset." To a beginner in Ceylon, or to a planter in any other country unacquainted with the particular methods pursued on Ceylon estates, the book would prove at first somewhat perplexing. Too much knowledge is assumed on the part of the reader as regards the important questions involved in the selection of land, while as regards the details of cultivation the particular "fads" and "fancies" of individual planters are too largely dwelt upon. It would have been more to the purpose to present a clear and simple statement of the first principle upon which the growth and culture of the tea plant, as a plant, should be based, in order to produce the best results. As regards the details of the manufacture of tea quoting authorities is no doubt the best course, for the process of manufacture consists of a series of purely empirical operations, and a statement of principles alone would not meet the case. After discussing selection of land (Chap. I.), varieties of the tea plant (Chap. II.), seed and nurseries (Chap. III.), lining, holing, and planting (Chap. IV.), field cultivation (Chap. V.), topping and pruning (Chap. VI.), plucking (Chap. VII.), and manufacture (Chap. VIII.), the writer devotes the remainder of the book to buildings and machinery (with plans), and to statistical returns connected with yield and cost of production.

The rapid progress made by the tea industry in Ceylon is exemplified by the fact that, while in 1878 only 232 pounds of tea were exported, during the past year (1886) the exports reached over 7,000,000 pounds. The probable exports in 1887 are placed at 12,000,000 pounds, while in 1888 they are expected to reach 30,000,000 pounds. So far, the price of Ceylon tea has maintained a slight advantage over Indian teas—the average price during 1885 being 1s. 3½d. per pound for Ceylon tea, against 1s. 1½d. for Indian teas. The combined effect of large shipments of Indian and Ceylon teas will no doubt lead in time to a displacement of much that now comes from China. And while the general character of tea obtainable in European markets will improve, there obviously must come a fall in prices for which both Indian and Ceylon tea planters must be fully prepared. At the Colonial and Indian Exhibition, thanks to the energy of Mr. J. L. Shand, Ceylon tea was admirably brought before the English public. Tea from Natal, Fiji, and a small sample from Jamaica were also shown; but the tea from Fiji possessed such special qualities that we shall probably hear more of this promising article.

To return to the subject of this notice, the "Tea-Planter's Manual" is a useful summary of the knowledge gained respecting tea-planting in Ceylon, and it embodies much valuable information for the use of practical planters. What fault there is to be found is not with the book itself, but with the system of cultivation it inculcates—a system which unfortunately appears to be adopted in the treatment of most tropical economic plants by European planters. These plants are treated too purely as so many "rupee-making" machines. Too little attention is given to the characteristics and habits of the plants as living subjects, and too much to the details of an unsympathetic and essentially artificial system, already proved in Ceylon to be unsuited to the coffee plant, but into which there is now a strong tendency to force the

tea plant. As there are diversities of soils and climates, so there are also diversities of industrial plants exactly suited to them. Where all such considerations are ignored, there is danger both to the plants and the planter; and this danger ought in the present case to be avoided.

D. M.

GEOMETRY

The Elements of Euclid. Books I.-VI. and part of Books XI. and XII. By H. Deighton. (Cambridge: Deighton, Bell, and Co., 1886.)

Euclid Revised. Book I. with Additional Propositions and Exercises. Edited by R. C. J. Nixon. (Oxford: Clarendon Press, 1886.)

Euclid Revised. Books I. and II. (Same Editor and Publishers.)

First Lessons in Geometry, for the Use of Technical, Middle, and High Schools. By B. Hanumanta Rau. (Madras: Addison and Co., 1885.)

The Origins of Geometry. By Horace Lamb, F.R.S. (Manchester: Cornish, 1886.)

THE author of the first of these books attempts to "give a translation of the Greek text of a somewhat more modern form than the mere verbal ones [what does he mean?] in general use; and, whilst strictly adhering to Euclid's methods, to render his reasoning as clearly and concisely as possible." Hence our presentation of the title-page is supplemented in the original work by the words "newly translated from the Greek text with supplementary propositions, chapters on modern geometry, and numerous exercises." It will be evident that this is Euclid pure and, as far as the author is able to render it, unadulterated; there is no *revision* here such as Mr. Nixon provides for the reader. Mr. Deighton has, however, studied the "Syllabus" (of the A.I.G.T.) and has here and there introduced, with fitting acknowledgment, extracts from it. Further, the author is evidently actuated by the same motives as those which lead the Association to attach so much weight to the solution of geometrical problems as evidence of a student's grasp of the text. A strong feature is the large number of exercises (1419 in all, besides worked out examples), especially of an elementary character, in close proximity to the propositions upon which their solution depends. At the end of the first book are given the enunciations of several propositions which certainly should be mastered by anyone who wishes to gain a sound acquaintance with elementary geometry. Following, it may be, the example of other recent text-books, an excellent collection of the most important propositions on the radical axis, poles and polars, harmonic proportion and centres of similitude are given; there is also a chapter on transversals. The selection of exercises is not confined to Cambridge papers, but levies have been made on the well-known works of Catalan, Rouché, de Comberousse, and Spieker. There are also remarks on plane loci and on the solution of geometrical questions. The letterpress is clear, and the figures are in the main distinctly and carefully drawn, but several monstrosities appear in the third book, as of old, and the drawings on pp. 115, 153, 186 are incorrect as to relative measurements. Perhaps when Mr. Nixon

has examined the present book he will modify a statement in his preface (p. vii., we refer to the work reviewed in these columns, vol. xxxiv. p. 50, by R. B. H.) to the effect that "there does not exist a modern edition which gives *Euclid pure and simple*."

The second and third books are the corresponding portions of the larger work referred to above, reprinted page for page, with the addition of an appendix, in which are given proofs of omitted propositions, and also of i. 5 and of i. 8 as a deduction from i. 7. "This addition is made at the request of several teachers. It is of course a concession to the omnipotent examiner; and, as such, is made with much reluctance." One can only regret that a writer who has taken up so advanced a position should have yielded on this point.

The fourth book is interesting as giving evidence of how a modern movement has taken hold of able mathematical teachers of the mild Hindoo. Mr. Rau candidly repudiates all claim to originality for his matter, as in its compilation he has consulted the best English and French text-books both for pure as well as for practical geometry. "If 'Euclid's Elements' is unsuited for beginners who study it in their own native tongue, how much more so should it be in this country, where it is taught in classes consisting generally of lads between ten and twelve, before they have had time to master the difficulties of a foreign language, and before too, I may add, they can benefit by its rigorous logic. The result, as may be anticipated, has been highly prejudicial to the study of geometry and of mathematics in general. With a view, if possible, to remedy the evil, of which I had become painfully conscious in the course of my several years' experience as a mathematical teacher in schools and colleges, I had long been anxious to attempt a departure from the established route." The work consists of the notes he drew up for the pupil-teachers and students under his charge. "My success in the experiment is my justification for publishing this little volume." The figures are roughly drawn, and the cover is a paper one, but the contents are carefully arranged, and furnish a very fair amount of geometrical information for the class aimed at all the propositions being looked at with an eye to their practical utility. Such a class should know how to hold an object "in an oblique position, not permitting it to retrograde to the perpendicular."

"The Origins of Geometry" is an address delivered at the opening of the Owens College session, October 5, 1886. The Professor of Mathematics casts "a rapid glance over the early history of our science, more especially of that branch of it which was first cultivated with success, geometry." Taking Hankel as his guide, he glances rapidly at matters of which Dr. Allman has treated in much fuller detail; he then treats of what has proved "the most formidable obstacle to the further progress of Greek mathematics, the divorce between geometry on the one hand, and arithmetic and algebra on the other. This had its origin in the discovery of incommensurable magnitudes by Pythagoras and his successors." He, by the way, notes that "the greatest advances in mathematics have been made by men whose interest in the subject was of a speculative kind." The address winds up with the question, "What is likely to be the relation of mathematics to the science of the future?" Prof. Lamb

answers this question only as regards physical science, and his answer is "contained in that to another question, What is the object of the physical sciences?" The whole concludes with words of the late Prof. H. Smith on the function of mathematics in education.

ACOUSTICS

Hand-book of Acoustics. By T. E. Harris, B.Sc., Lecturer on Acoustics at the Tonic Sol-fa College. (London: J. Curwen and Sons)

A FEW years ago some wiseacre had the temerity to propound the idea that the scientific and historical data on which music is founded have no bearing on music itself, and need form no part of the knowledge to be acquired by a musician. It is quite true that a man may get through life very comfortably as a singer, a fiddler, or a pianoforte-player, without ever having heard of sound-waves or of the Greek modes: but as regards a knowledge of music in a higher sense the idea is absurdly untrue. The moment we approach the *theory* of music we find the scientific and historical elements confront us at every step, and all attempts to form an intelligible explanation of musical structure without reference to them have been, and must be, failures. In fact, no rational theory of music can exist unless founded on such a basis. This fact is now pretty generally acknowledged by those who have to do with musical education. All examining bodies of any weight require an acquaintance with the data referred to, and all well-constituted courses of teaching include them.

The book now before us is a remarkable instance of this. The Tonic Sol-fa movement is what we may call ultra-practical: its supporters aim at teaching music to the great masses of the people, and their system is purposely contrived to facilitate its practical acquirement, and to bring it down to the proverbial "meanest capacity." Yet the Tonic Sol-fa authorities think it right to have a Lecturer on Acoustics, and to publish a hand-book of the science for the use of their millions of pupils. This is certainly about the severest reproof that could be given to the foolish "practical" notion that would exclude intellectual topics from musical study.

There is not much to say about the book itself. It is an unpretending compilation of the most important facts of the science, gathered from various authentic sources, intelligently stated, and without any crotchetiness or affectation of originality. The peculiar feature, of course, is that the musical illustrations are, wherever possible, given in the Tonic Sol-fa notation. Perhaps, in the 286 closely-printed pages, there is more elaboration of detail than the students may care for; but this is to a certain extent counterbalanced by a condensed summary being added at the end of each chapter.

It would have been an advantage if more copious and complete references had been given to other and more original works, from which the matter has been taken. It is, or should be, one of the most important objects of a "hand"-book to enable students, if they desire it, to put more complete treatises on their study-table. There is no date either on the title or in the preface—a very bad habit of music publishers.

OUR BOOK SHELF

Old or New Chemistry: Which is Fittest for Survival
By Samuel Phillips, F.C.S. (London: Wertheim
Lea, & Co., 1886.)

THIS small book is a collection of essays more or less being on the subject indicated by the title, and may perhaps be also described as a sort of protest against a grievance. The elevating and spurring effect of the possession of grievance is well known, and it must be admitted that in this case it has, apparently at least, contributed to the production of a very entertaining little book, which we no doubt, as it is intended, "wake up" chemists generally to a clear perception of their absurd and useless theories of chemical constitution.

It is, however, doubtful whether the book will read do anything to forward the science of which the author professes to be such an ardent lover. As to Avogadro's law and the laws known as Dulong and Petit's, however scanty a basis they may have in experimental facts, they have been useful, and will be until they are supplanted by wider-reaching theories. It is exactly here that the author seems to be too conservative. We not only want more facts—as many facts as we can get—but we want theories as well, if they will only again lead to new facts. And, moreover, what is wanted in this country is for chemists to *work*. There is no lack of problems waiting to be solved.

What we do not want is any further multiplication of "fads." Nothing is gained by writing "Ph" for C_6H_6 and the "equivalent symbol" for "etholo-aceto-acetic acid," viz.,

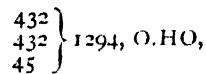

at page 19, is no advance but retrogression.

Lectures and Essays. By the late W. K. Clifford F.R.S. Edited by Leslie Stephen and Frederick Pollock. With an Introduction by F. Pollock. Second Edition. (London: Macmillan and Co., 1886.)

THIS collection of lectures and essays is already so well known that it is now necessary only to note the fact that a second edition has appeared. Two essays have been omitted as being rather mathematical than philosophical: namely, those on "Types of Compound Statement" and on "Instruments used in Measurement." They have found a more fitting place in the volume of "Mathematical Papers" published in 1882. The admirable biographical Introduction by Mr. Pollock has been revised and some additions and omissions have been made in the extracts there given.

Lives of the Electricians. By William T. Jewett (London: Whitaker and Co., 1886.)

AN extremely well-compiled and interesting book; but why did the author commence with the life of a living professor, who is not an electrician? Faraday, as the brightest electrical light of this or any other age, should have headed the series. The author has a rich store of names to draw upon—Gilbert, Coulomb, Arago, Savary, Harris, Franklin, Cavendish, Galvani, Volta, Henry, Davy, Ronalds, Oersted, Ampère, De la Rive, Ohm, Schilling, Gauss, Weber, Daniell, Crosse, Steinheil—without trenching on living celebrities. The work is very impartially written. The life of Morse might have been written by an enthusiastic American, while Wheatstone's friends cannot complain of the eulogy of their hero.

Some statements want revision. The inauguration of the cable system can scarcely be fairly narrated without mention of Messrs. Crampton and Wollaston. Various long artificial cables and great experiments shown at the Royal Institution are accredited to Prof. Tyndall (p. 9). The statement attributed to Sir Robert Inglis (p. 20)

that in 1847 England was behind America must surely be wrong. The Electric Telegraph Company in England was then in full swing.

As this is the jubilee year of the telegraph in England, it is well to be reminded that Cooke and Wheatstone made their first practical and successful trial on July 25, 1837, between Euston and Camden, while Morse did not file his *caveat* (i.e. did not apply for his patent) until October 5 of the same year.

We wish the book every success, and shall be glad to see further instalments.

LETTERS TO THE EDITOR

[The Editor does not hold himself responsible for opinions expressed by his correspondents. Neither can he undertake to return, or to correspond with the writers of, rejected manuscripts. No notice is taken of anonymous communications. The Editor urgently requests correspondents to keep their letters as short as possible. The pressure on his space is so great that it is impossible otherwise to insure the appearance even of communications containing interesting and novel facts.]

Normal School of Science and Royal School of Mines

I AM directed to request that you will be so good as to allow me to state, through the medium of your columns, that the number of applications for admission to the Normal School of Science and Royal School of Mines at South Kensington, at the commencement of the present session, having been considerably in excess of the accommodation which the School can afford, it has become necessary to adopt some process of selection for the future. Hereafter, applications for admission should be sent to the Registrar of the School before the end of May, accompanied by a statement of the studies which the applicant has already pursued, the examinations he has passed, and the name of a teacher (or teachers) to whom reference may be made. Such applications will be considered by the Dean and Council of the School, who will decide on them according to their merits. A knowledge of elementary mathematics, such as is required of all Royal Exhibitioners and national scholars, will be held to be of the first importance for those who desire admission to the course for the Associateship of the School; while for occasional students, who propose only to take up certain specific branches of science, some preliminary knowledge of them will have weight.

J. F. D. DONNELLY

Science and Art Department, January 14

The Cambridge Cholera Fungus

THE letter published by Dr. Klein in your issue of December 23 (p. 171) having incidentally referred to my views as to the nature of the fungus present in choleraic tissue, I should be glad to be allowed to make some further remarks upon the subject.

At an early stage of his investigation Prof. Roy brought for my inspection one of his preparations of intestinal mucous membrane, which clearly demonstrated the presence of certain foreign organisms, and especially drew my attention to a form which he took to be the more usual and typical one. Such a structure might perhaps best be described as consisting of a thin and somewhat moniliform filament which at one end exhibited a distinct nodular swelling. Being struck with a certain (and, as I now fear, a somewhat superficial) morphological resemblance to a group of the Chytridiaceæ, I suggested that the organism might possibly be a Chytridium, and this view was perhaps too confidently adopted by Messrs. Roy and Sherrington in their paper. The appearance of Dr. Klein's letter has naturally led me to carefully reconsider the whole question, and on further consideration I entirely abandon the idea of the organism being a Chytridium. I believe, on the contrary, that it is a Bacterium, and that the structure described by Prof. Roy and seen by myself is that particular phase in the life-history of the Bacterium which is known as an involution form. Such forms are described, for instance, in Zopf's article "Die Spaltpilze," in Schenk's "Ency-

clopædie der Naturwissenschaften," as *Bacterium aceti* and *Bacterium cyanogenum*. Indeed, the involution form assumed by the latter Bacterium recalls very vividly to my mind the structure shown to me by Prof. Roy.

In conclusion, I may assure Dr. Klein that the fungus is certainly neither a Penicillium nor of the nature of a mould, and that I do not believe it is in any way associated with *post-mortem* change.

WALTER GARDINER

Royal Gardens, Kew, January 11

Snowstorm of January 7, 1887

A MOST extraordinary snowstorm occurred here to-day (January 7). In fifty years' experience I have seen nothing like it, nor has anyone else in this neighbourhood seen any similar phenomenon. It would be impossible to realise the gigantic size of the snowflakes without seeing them. I can only compare them to a fall of oranges, though the diameter of an orange would be small in comparison with thousands of these snowflakes; in this immediate neighbourhood (i.e. within sight of the place of observation) at 50 yards off it produced a dense snow-wall. The wind was south, and almost calm, and the largest snow came down nearly perpendicularly. The temperature was 32°·6, and the air completely saturated with moisture. Before the storm the temperature was 34°·1. Snow had been falling with a slight thaw from 10 a.m., the snowflakes being small. Suddenly, at 12h. 12m. p.m. they became 2½ inches in length; at 12h. 14m. they had increased to 2¾ inches; and one flake that was caught measured 2¾ inches by 2½ inches, and was ⅓ of an inch thick. At 12h. 16m. the flakes had increased in size to 3½ inches (and several measured were 4 inches across, and there were several larger ones not near enough to be caught); at 12h. 19m. they were somewhat less, and at 12h. 20m. though large, were not gigantic. Fortunately I was measuring and weighing snow at the time, with two assistants, and had a number of flat circular glasses kept cold ready for the purpose of catching crystals, and for measuring the snow that fell upon these glasses. As is usual when very large flakes are falling, there were many of smaller size, though when the flakes were from 2½ to 3½ inches, the majority of the next size were about 2 inches, and the very large flakes would be within 12 inches of each other. A dozen of these large flakes were caught, each on a separate piece of glass, measured and removed under cover, my two assistants giving valuable aid. Of three of these flakes one yielded 14 drops of water, a second 15, and a third 16 drops; and these were not the largest flakes seen. The water from seven flakes weighed a quarter of an ounce within 2 or 3 grains. The weight of ten varied from 13 to 16 grains each; most of the flakes were about a third longer than broad, one flake that was 3½ inches long by 2½ broad was estimated (before it touched the glass) to be 1½ inch thick, when flattened by the force of its descent it was ¼ of an inch thick.

The flakes were not a mass of broken pieces, but were composed mainly of perfect crystals, and there must have been hundreds of these crystals in each flake; they were clinging together at every conceivable angle, though a much larger percentage were more horizontal than vertical. A terrestrial radiation thermometer, buried a fifth of an inch within this snow, marked a temperature of 32°·4.

The snow which fell during the last six minutes of this great storm was just under one-fifth of an inch in depth, and yielded 0·30 of an inch of water, falling at the rate of 1 inch of water in three hours and twenty minutes (yielding 1 inch of water from 6 inches of snow).

There was a great snow-storm here on December 27, 1886, which varied considerably in places near to each other, i.e.—

	Amount of rain and snow	Depth of snow Inches	Melted snow alone
Shirenewton Hall ...	1·55	7	0·97
Dennil Hill ...	1·07	5	0·71
Wirewoods Green ...	0·86	3	0·42
Piercefield Park ...	0·96	4	—
Chepstow (The Mount)	0·70	—	—

The drifts above here are very great, and a large number of men are still engaged in cutting through them.

The following measurements will show the number of inches

1 The breadth was less than the length, and the thickness less than the breadth; more or less flattened, and curled over on the edges.
2 Besides these drops, the wetted glass shall count for two more drops.

of snow required to yield an inch of water from observations taken here:—

1886, January 23, snow 2 inches, melted '063 (i.e. 33 inches for 1 inch of water); March 1, snow 7 inches, melted '800 (i.e. 9 inches for 1 inch of water); December 26, snow 7 inches, melted '967 (i.e. 7 inches for 1 inch of water). 1887, January 4, snow 3½ inches, melted '379 (i.e. 8½ inches for 1 inch of water); January 7, ½ inch, melted '030 (i.e. 6 inches for 1 inch of water).

The damage done on December 26 was unusually great, the snow being very heavy, as much as 5 lbs. weight on a square foot of a cedar-branch; this, when moved by the wind, caused much breakage.

January 8.—Since sending my note yesterday I find that at Chepstow and at Itton the snowflakes were larger than anyone

had before seen, so that probably the storm had an extended area; at all events it was 5 miles broad.

The present storm is a very similar one to that recorded by myself in January 1838, except that the largest flakes in 1838 did not exceed 2 inches. In that storm the largest flakes fell more rapidly and more perpendicularly. I then pointed out that large snowflakes were produced by two upper currents driving the flakes together; and afterwards, by the largest falling with increased velocity and more perpendicularly: they were thus able still more to augment their dimensions by adding smaller ones to their bulk. This was well seen on January 7, when an estimate was made as to the velocity and angle of their descent. Not only were a number seen to be added as they fell upon them, but it was thought that small flakes when near to the

Shape and size of snowflake. (There were more of a somewhat similar form to this than the more circular ones, though there were very many more circular and less indented.)

large ones were attracted to them. The flakes were, however, large whilst at a considerable distance from the ground.

Several flakes were sketched before they began to melt, and one of the sketches is sent as an illustration. The glasses were at a temperature of freezing, and therefore it was some time before the snow melted, and not thoroughly so until they had been 5 minutes in a hot-house.

January 13.—The snowflakes folded over on the edges, boat-like, and this curling over caused the thick look observed. There was a slight zigzag in their downward course of some 2° or 3°. This storm passed over Chepstow, Itton, and Monmouth in this county; Wirewoods Green, Tidenham, and Dennil Hill, all in Gloucestershire, and Bath: in all of these places the flakes are spoken of as the largest ever seen. One correspondent at Chepstow reports them as larger than the hailstones in the storm of May 1848, which were larger than hens' eggs, and broke the shop windows, and destroyed the glass of hot-houses near Chepstow.

Shirenewton Hall, near Chepstow

E. J. LOWE

Auroras

THE account, in NATURE for December 16 (p. 159), of a bright cloud "emitting brilliant rays of light," that suddenly appeared at Hamar, in Norway, on the night of November 3, recalls the fact that on November 2 there was at Lyons, New York, an aurora which at one time during the evening consisted entirely of detached luminous cloud, as was noted in NATURE for November 18 (p. 54). It is stated that on November 4 one of the finest auroras of the year was visible at Throndhjem, Norway.

M. A. VEEDER

Lyons, N. Y., January 3

A Solar Halo

IN the weather report issued on Friday evening, the 14th inst., a solar halo is recorded as "observed in Jersey during the day."

Between noon and 12.30 I observed a very complete and well-defined halo, of radius about $\pi/8$, in this neighbourhood. It was not perceptibly tinted, but the duskiest of the interior, as compared with the clear sky exterior to the luminous ring, was more pronounced than I ever remember to have noticed it on other occasions—so much as to suggest comparison with the "curtain" of the aurora: "Solem quis dicere falsum audeat!"

J. J. WALKER

Hampstead, N.W., January 15

THE NATIONAL SCIENCE COLLECTIONS¹

II.

25. REVERTING to this country, the "Patent Museum," now under the charge of the Science and Art Department, is a collection of a peculiar nature; and in order to explain its origin, and the objects it was intended to serve, we may make some extracts from the Report of a Select Committee of the House of Commons, appointed in 1864, to inquire as to the most suitable arrangements to be made respecting the Patent Office, Library, and Museum. The Committee said:—

The second point to which your Committee directed their attention was that of the Patent Museum, having regard especially to its formation, its present state, its relation to the Patent Office and Library, and the nature of its contents, so as to render it practically useful.

Your Committee found that the Patent Museum was formed by Mr. Woodcroft, the Superintendent of Specifications, by the request of the Commissioners of Patents, and that it consists of models and machines belonging partly to the Commissioners of Patents, partly to the Commissioners of the Exhibition of 1851, and partly to Mr. Woodcroft himself, and various private persons.

¹ Continued from p. 254.

This collection has been exhibited since 1857 in the iron building at South Kensington.

Your Committee are of opinion that the term Patent Museum (which is generally applied to this collection) tends to give an erroneous impression as to its character and object.

Various suggestions have been made by witnesses respecting the nature of a Museum connected with the mechanical arts, which may be summed up as follows:—

(a) That it should illustrate the history of those arts by a collection of original machines from an early period to the present time.

(b) That it should exhibit all known inventions respecting machinery and manufactures.

(c) That it should show the present state of all machinery and manufactures.

(d) Some of the witnesses suggested that the collection should be restricted to the machinery and manufactures of the United Kingdom; whilst others proposed that it should be extended to those of foreign countries.

(e) Some, again, proposed that the collection should contain all the objects of each class, whilst others proposed that a selection only of the most important objects should be exhibited.

(f) There was no less diversity of opinion respecting the primary purpose for which any collection or exhibition should be made; some of the witnesses considered that it should be for the purpose of conveying instruction in the mechanical arts, either in a cursory way to people who might visit the Museum, or to students in mechanics, or to persons desirous of applying themselves to the discovery of improvements in machinery and manufactures.

(g) Other witnesses deemed the Museum chiefly desirable for the information of persons intending to take out or purchase patents, in aid of the information afforded by books and specifications, to assist them in ascertaining whether the contemplated patent would be valid as a new invention.

(h) On the other hand, two witnesses, Mr. Carpmael and Mr. Johnson, gave it as their opinion that for all purposes of the patent law a museum of models would be practically valueless.

Your Committee are of opinion that any special collection of patented inventions made for the purpose of evidence, illustration, or record of patent rights is not so connected with a general museum of mechanical inventions as to render the neighbourhood of such a museum to a patent office and library, or law courts, necessary.

It appears to your Committee that the chief purpose of a general museum is to illustrate and explain the commencement, progress, and present position of the most important branches of mechanical invention; to show the chief steps by which the most remarkable machines have reached their present degree of excellence; to convey interesting and useful information, and to stimulate invention.

In forming an illustrative collection of inventions it would be necessary to adopt the principle of selection. This, however, does not appear to your Committee to be an insuperable objection, especially as no one proposed to substitute models for specifications, which for all the purposes of administering the patent law would still have to be consulted, and bear the stamp of authority.

Such a collection should contain a selection of models of moderate size, which should illustrate different departments of inventions, and also a selection of models of current patented inventions.

The Patent Collection, although it was placed in premises belonging to the South Kensington Museum, remained in the hands of the Commissioners of Patents until January 1, 1884, when, by the "Patents, Designs, and Trade Marks Act, 1883," 46 and 47 Vict. c. 57, it was transferred to the Science and Art Department.

The title "Patent Museum" was never accurate; the collection might with greater propriety have been called the "Woodcroft Museum," from the name of the gentleman, formerly Clerk to the Commissioners of Patents, who originated the formation of it. It contains objects illustrating steps in the history of mechanical inventions, and contrivances of importance and interest, without regard to whether they have been patented or not. Among these, for example, are the earliest locomotive and stationary steam-engines; the first engine used in steam navigation; the first reaping-machine; Arkwright's original spinning-machinery; all Sir Charles Wheatstone's original apparatus, showing a complete history of the various steps by which he perfected electric telegraphy; many of Edison's original electrical inventions; some old clocks dating from 1325; and other objects of similar interest.

Inventions embodied in future patents may be added to this Museum, pursuant to Sections 41 and 42 of the Patent Act above mentioned. These sections enact as follows:—

(41) The control and management of the existing Patent Museum and its contents shall, from and after the commencement of this Act, be transferred to, and vested in, the Department of Science and Art, subject to such directions as Her Majesty in Council may see fit to give.

(42) The Department of Science and Art may at any time require a patentee to furnish them with a model of his invention, on payment to the patentee of the cost of the manufacture of the model; the amount to be settled in case of dispute by the Board of Trade.

We do not consider it to be feasible to combine a complete museum of patented inventions with a methodical collection of objects illustrating practical science, and we infer from the language of Parliament in the provisions just quoted that this is the view taken in the recent Patent Act, which enables, but does not oblige, the Department of Science and Art to acquire specimens of patented inventions.

26. We conceive that it will be useful for the curators of all the collections to bear in mind that their primary and indispensable scope is to provide apparatus and specimens for the instruction given in the Normal College of Science, and for the teaching of science generally throughout the United Kingdom.

Cases may doubtless arise where the acquisition or reception of other objects may be expedient, in the interest of science or of the arts; but in these cases, in order to prevent the unnecessary occupation of space, we recommend that due regard be had to existing public collections elsewhere, so as not unnecessarily to duplicate the provision for illustrating science.

27. Referring now to the space required, we adopt the following figures given by the Reports of the different Committees, adding some estimates for the future where they have not been stated:—

	Space now required	Estimated increase of space required in ten years	Space required at the end of ten years
	Sq. ft.	Sq. ft.	Sq. ft.
Various science collections	37,000	3,000	40,000
Naval models	10,500	10,000	20,500
Building construction	15,000	10,000	25,000
Fish culture	5,000	1,000	6,000
Educational collection and library	7,500	1,000	8,500
Mechanical collections... ..	45,000	15,000	60,000
	120,000	40,000	160,000

In framing their estimates, the Committees generally took, as the basis of their computation, top-lighted galleries 30 feet wide, which afford a large amount of well-

articles which are either offered as gifts or are said to merit acquisition. We think that merit alone should be the ground of admission, and that even this ground must be subject, in the first place, to the consideration of space, and next, to that of scientific arrangement. If space is to be in any degree limited, and scientific arrangement to be maintained, it is evident that exclusion and depletion, as well as completion, must be kept in view; and that while the Department of Science and Art is left all possible freedom in determining what the contents of its collections shall be, it should be strictly confined to the area which is represented to be sufficient for the future.

In the due appropriation of this area we do not consider that, as a rule, and except in cases of historic interest, engines and machines of the original size should be acquired, or even accepted on terms implying that they will continue to be exhibited otherwise than in models.

29. Comparing now the estimates of space required with the area at present available, we find as follows:—

The total available floor-space in the present buildings, assuming the Western Gallery, D, to be given up, and the building F. to be abolished, is 51,500 square feet.

This is 17,480 feet less than the collections at present occupy, and less than half what the Committees estimate for them when fairly completed.

It is clear, therefore, that new buildings are absolutely required.

PROVISIONS FOR HOUSING THE COLLECTIONS

30. The second duty confided to us is:—

To suggest plans for housing the collections in the existing galleries to the south of the Horticultural Gardens, or in new galleries to be built upon their site, and the adjacent ground now the property of the Government.

31. In considering this matter, we have had the valuable assistance of Mr. Taylor, the Surveyor to Her Majesty's Office of Works, who has, in accordance with our suggestions, carefully examined the existing buildings, and prepared sketch-plans and estimates to meet the circumstances of the case.

32. We have already referred to the land available. It is shown on the Drawing No. I., marked G, and coloured red, and it consists of a plot of ground to the south of the South Galleries A, B, C, containing 4 acres and 23 square yards.

This land, as well as the site and ground of the Natural History Museum to the south of it, was purchased by the Government, in 1864, from the Commissioners of the Exhibition of 1851, and the particulars of the transaction are fully set forth in the Fifth Report of the Commissioners, dated August 15, 1867.

33. In this Report (p. 31) the Commissioners say:—

“We have set forth in detail all the circumstances connected with the sale by us to Her Majesty's Government of the site of the Exhibition of 1862, with the sanction of Parliament, and under the special condition that the site in question shall be permanently devoted to purposes connected with Science or the Arts.”

This condition is fully and strongly carried into effect in the deed of conveyance, which is published as an Appendix to the same Report; so that the appropriation of this land for the erection of a Science Museum is in strict compliance with the conditions of its acquisition.

35. Drawing No. II. shows a ground plan of a design which fulfils these conditions.

It provides for two three-storied buildings of ornamental elevation, forming frontages (with returns) to Exhibition Road on the east, and to Queen's Gate on the west; and for plain two-storied buildings adjacent to these east and west frontages. These buildings, together with the existing southern buildings (A, B, C) will afford the required space until the latter become unserviceable, and permanent structures have to be erected on their site.

These buildings would give room for the collections, with the necessary offices, for the Portrait Gallery, and, if desirable, for examination-rooms.

MEASURES RECOMMENDED

36. The measures we recommend are as follows:—

SECTION I.—*Alteration of Arrangements in the existing Galleries*

(a) Remove the collection from the upper floor of the Western Gallery, D, and place it temporarily on the lower floor of the same building, and in A, B, or C.

(b) Remove the Portrait Gallery into the upper floor of the Western Gallery, D; this floor has been used during former Exhibitions as a Picture Gallery, and has given great satisfaction to the artists. This gallery, as it exists, is more secure against accidents by fire than the building in which the pictures are now placed, and can be rendered, at a moderate outlay, practically incombustible.

(c) Clear out the ground floor of the Western Gallery, D.

(d) Then use this ground floor for examination-rooms. When this is done, the entire Western Gallery, D, will be occupied, and none of it will be further available for the collections.

(e) Make an opening through the wall which now shuts off the centre building, C, so as to give an approach from Exhibition Road to the western parts of the galleries, and thus do away with the unsightly gallery K.

(f) Proceed to arrange the rooms as they are set free.

(g) In addition to the access from Queen's Gate to the portrait gallery in D, afford access to it from Exhibition Road through the Science collections.

SECTION II.—*New Works to be undertaken*

37. The proposed new building is so designed that it may be carried out in separate portions progressively.

The portion to be first undertaken should be on the parts marked L and L', with the temporary entrances, all coloured yellow on the drawing No. II. These buildings may be completed in about eighteen months, and are estimated to cost about 43,520*l.*, which may be distributed over the financial years 1886-87, and 1887-88.

Before the end of 1887, also, the option must be exercised of purchasing the central building, C.

When the above-mentioned first portions of the new building are completed, they will add an available area of 28,700 square feet, which, with the areas already existing in the southern galleries, will make a total of 80,200 square feet.

This will provide, for the Science collections, about 14,000 feet more than they at present occupy, and it will admit of the Patent Museum being removed to the western side of Exhibition Road, and of the building E.

being abandoned. At the same time the temporary appropriation of the Western Gallery, D, to the Portrait Gallery and the examination-rooms, will give them an advantageous increase of accommodation. Hence, by this first instalment of the new works, a considerable improvement on the present state of things will be effected; but the space will still be much below what has been estimated as necessary by the Committees who have investigated the matter.

38. The next portion to be undertaken may be the building with façades at the eastern end, marked M' on the drawing, and coloured red. This is estimated to cost 54,183*l.*, and it will furnish 33,750 square feet of additional floor-space.

When this is built there will be, in all, 113,750 square feet available, *i.e.* enough not only to accommodate the present collections, with some increase, but also to receive the Portrait Gallery, and to provide examination-rooms, if required.

At this time, therefore, there will no longer be any need to hire from the Commissioners of 1851 the Western Gallery, D, and thus an expenditure of 2000*l.* per annum will be saved.

39. The accommodation can afterwards be extended from time to time, as and when means may be voted for the purpose, by the erection of the other portions shown on Drawing No. 11., as follows:—

	Additional space obtained Square feet	Estimated cost <i>l.</i>
Interior building at the east end, marked N ¹ , and coloured brown	28,350	32,930
Building with façades at the western end, marked M, and coloured red	37,950	59,240
Interior building at the west end, marked N, and coloured brown	28,350	32,930

40. The entire floor-space gained by the new buildings, when completed according to Drawing No. 11., will be 157,100 square feet. To this must be added the space in the existing southern galleries, which will be assumed still to remain available. They contain, at present (as we have already stated), 51,500 square feet; but, in the process of building the new erections, a portion of the old ones will have become absorbed therein, and the space will be reduced to 41,818 square feet. The total available space will therefore amount to 198,918 square feet.

The total estimated cost of the new work shown on Drawing No. 11. is 222,803*l.*

41. In submitting this Report to the Treasury, we desire to state to their Lordships that one of the principal considerations guiding us has been to prepare a plan which admitted of being executed in parts, but which, when completed, should suffice for as long a period as we think it necessary to foresee. We have taken as our starting-point the demand of 160,000 square feet of area, and we have shown how it may be provided without more than a strictly temporary use of the Western Gallery, which does not belong to the Government.

42. We have been invited to express an opinion as to whether there would be space, in the completed plans, to provide for the collections now housed in the Museum in Jermyn Street, and the instruction now given there. We believe that there would be space for the purpose.

We have the honour to be, Sir,
Your obedient Servants,

WILLIAM POLE,
Secretary,

FREDERICK BRAMWELL
LINGEN
J. F. D. DONNELLY

Westminster, July 27, 1885

P.S.—Mr. Mitford dissents, for the reasons appearing in a separate Report handed in by him on the 4th ultimo, which, with other documents relative to it, is inclosed in the letter covering our Report.—F. B.; L.; J. F. D. D.

TRANSMISSION OF POWER BY COMPRESSED AIR

A MOST interesting experiment is about to be tried in Birmingham. A Company, whose engineer is Mr. J. Sturgeon, has obtained Parliamentary powers to supply power from a central station by compressed air through pipes laid in the streets. The application to Parliament was supported by the Birmingham Corporation, and the powers extend over an area of between four and five square miles. It is at first intended to restrict operations to about one square mile and a half. This area will include twenty-three miles of main pipes. The central works are designed for the production of 15,000 horse-power, of which the engines laid down at first will supply 6000 horse-power. The authorised capital expenditure for the whole is 276,800*l.*, of which 150,000*l.* will be spent at once for the initial 6000 horse-power. In this journal we have nothing to do with the financial aspects of the project, but we mention these figures to show that within a short time the system may be expected to be in operation on such a scale as will very fairly test its mechanical efficiency. At a recent meeting of the directors it was determined to start clearing the ground and commencing the foundations for the central station at once, so that by next summer we may see considerable advance made towards the realisation of the project.

This is the first time that an experiment of this kind has been tried in Britain. Power is distributed from a central station at Hull by the hydraulic system, but transmission by air has hitherto only been tried in small installations at mines, quarries, in sinking piers, as at the Forth Bridge, and in tunnel-boring. In mines and tunnels it has very evident advantages, in that it keeps up a continual supply of fresh, cold air where ventilation is very much needed; and therefore its undoubted success at the St. Gothard works does not demonstrate its certainty of success for the distribution of power on a large scale to the workshops of a town where the atmosphere is bearably pure. Moreover, the pipe systems of these small installations have not been sufficiently long and complicated to test in any severe sense the liability to loss by friction, leakage, and variation of temperature.

The results of the present experiment will therefore be of the utmost scientific value to engineers, and will be watched with corresponding interest. No fairer field for such an experiment could be found than in Birmingham, which is marked out from all other towns by the enormous number of its small workshops requiring minute amounts of driving-power, and the total turn-over of each of which is too small to enable the owner to afford skilled tendance to his boiler and engine. In these small shops the power is required only intermittently throughout the day. At times the engine may actually stand altogether for an hour or two, while it is only rarely that it is called to exert more than a comparatively small fraction of its full power. Meanwhile the large loss due to furnace and boiler inefficiency—that is, to waste of heat by radiation and by hot gases passing up the chimney—goes on steadily at a pretty uniform rate. Under such circumstances, the advantages of generating the power at a great central station are so evident as not to require demonstration. The question of chief technical interest is really as to whether the best means of distribution is by air, by water, by electricity, or by cheap gas to be used in gas-engines. That question can only be finally settled by expensive experiment. In passing, the writer may indicate his own opinion that there lies in the future a magnificent field for enterprise on the part of the gas companies of large towns in supplying cheap gas for heating and the production of mechanical power, and it is most decidedly their interest to improve the efficiency and lower the prime cost of gas-engines.

The site of the central works is a triangular plot of ground adjoining Garrison Lane, at the intersection of the

London and North-Western and the Midland Railways. The Birmingham and Warwick Canal forms one boundary of this plot. The fuel to be used under the boilers is gas obtained from Wilson's eight-hundredweight producers. Eighteen of Lane's water-tube boilers will supply six engines to produce the 6000 horse-power aimed at at first. Air is admitted to the furnaces through gridiron sliding shutters, by means of which the supply is hand-regulated. It mixes with the gas in a mixing-chamber immediately below the front end of the furnace. The roof of this mixing-chamber is an arch of perforated bricks, and these bricks becoming highly heated the mixed air and gas is raised to a high temperature before being ignited. No special means have so far been considered necessary to prevent risk of lighting back into the mixing-chamber. The production of gas in the producers is controlled by the steam jet blown in at the foot of each. The steam for these jets is supplied from a special donkey boiler. The whole of the steam jets are throttled down by the action of a governor that runs, so to speak, in equilibrium with the air-pressure in the mains. The engine drives a small air-pump, which forces air into one end of a small cylinder, to the other end of which the air from the mains is admitted. If the pressure rises in the mains above standard, the piston of this cylinder is moved, and this movement is communicated by suitable gearing to the throttle-valve regulating the steam jet to the producers. The production of gas, and therefore the production of heat by its combustion under the boilers, are thus automatically regulated in accordance with the requirements, so that the air-pressure in the mains is prevented from varying outside certain narrow limits. In connection with this part of the scheme we may point out that it seems to be a mistake not to throttle the entrance-areas for the air to the furnaces automatically and simultaneously with the regulation of the gas supply. The chief advantage in using gas instead of solid fuel lies certainly in the power of obtaining perfect combustion by thorough admixture and careful proportioning of air to fuel. This advantage is sacrificed if the air supply is not diminished and increased simultaneously with, and in the same proportion as, that of gas. We suspect also that it will be found desirable not to rely solely on the throttling of the steam blast as at present intended; the more direct and rapid action of a throttle-valve between the producer and the boiler-furnace will be highly advantageous, if not necessary. By means of simple mechanical relays, actuated either by the steam or by the compressed air, there can be no difficulty in controlling these three sets of throttle-valves by the action of a single governor.

The steam-pressure is to be 160 pounds per square inch. Each set of three boilers supplies an engine of 1000 horse-power. The engine is of the triple-expansion type; the high-, intermediate-, and low-pressure cylinders having the diameters 20, 30, and 49 inches, and a common stroke of 48 inches. The areas of the three pistons are thus in the ratios 1, 2½, and 6. The cranks are at 120° to each other. The high-pressure and intermediate cylinders are steam-jacketed at the sides. The low-pressure cylinder is not jacketed, but a novel arrangement of steam-jacketing its piston is adopted. The piston is hollow, and steam is led into its interior by a tube which is parallel to the piston-rod, and moves to and fro through a stuffing gland in the cylinder cover, projecting into a larger tube screwed on the gland and supplied with steam direct from the boiler. The argument in favour of this arrangement is that side-jacketing of the low-pressure cylinder involves a large absolute waste of heat that goes towards heating the exhaust-steam as it leaves the cylinder on its way to the condenser; this loss of heat by the jacket steam being noxious, not only because it is pure waste, but also because it raises the back pressure against the piston. The fresh steam in the hollow piston sweeps over the inside surface of the cylinder just in front of the incoming working

steam, and thus heats the metal and prevents undue condensation of the working steam, while it is comparatively inactive in heating the back-pressure steam. In criticism of this argument, it may be remarked that towards the end of the stroke (during the last quarter of the stroke) the piston-jacket surface giving heat to the exhaust-steam is greater than a side-jacket would offer. For three-quarters of the stroke, however, it is less.

Each cylinder is connected with the fly-wheel shaft by a cross-beam. Over each end of each beam stands a single-acting, air-compressing cylinder of 26 inches diameter and 48-inch stroke. Each engine thus drives six of these air-pumps; and, since the speed is ninety double strokes per minute, the volumetric capacity of the compressors of each engine is close on 8000 cubic feet per minute.

The pressure in the mains is to be 45 pounds per square inch above the atmosphere, and the delivery-valves are expected to lift a little before three-quarters of the compressor-piston-stroke is finished. Thus the volume of air compressed to the above pressure delivered per minute by each engine is taken as about 2000 cubic feet.

The ratio of pressures is $\frac{59.7}{14.7} = 4.06$. Thus, if the compression curve were isothermal, the valves would lift, as above assumed, at 75 of the stroke. If it were adiabatic this pressure ratio would correspond to a ratio of final to initial volume of .367, and the valves would lift at .63 of the stroke. If the curve lay exactly mid-way between these two, or were according to the law $p \propto v^{-1.2}$, the ratio of final to initial volume would be .31, and the valves would lift at .69 of the stroke. In the latter case the volume delivered would be $.31 \times 8000 = 2480$ cubic feet per minute. Calculating simply from the product of this volume by 45 pounds per square inch pressure (*i.e.* from the work the air could do in an air-engine without clearance, without expansion, and without more than atmospheric back pressure), this would give about 487 horse-power delivered in the consumer's engines for each engine developing 1000 horse-power at the central station. Two indicator-cards taken from two air-compressing cylinders at Frood Colliery, near Wrexham, give very different results, possibly because one compressor was near the steam-engine cylinder, and was heated by it, while the other was not. The compression-curve from the one cylinder corresponds with the relation $p \propto v^{-1.27}$, while that from the other corresponds to $p \propto v^{-1.66}$. The latter curve is thus much steeper even than the adiabatic, and would indicate that the air was actually heated by conduction or radiation during its compression. Such heating could hardly have taken place to such an extent as to account for the above very high index, and the more probable explanation is that the air was steam-laden as it was taken in, and that the extra rise of pressure is really due to that of the steam in the mixture consequent on the rise of the temperature.

It is desirable to keep down the compression-curve as nearly as possible to the isothermal line, because by doing so the area of the compressor indicator-card, and therefore the work to be done by the engines, is kept down to its minimum; whereas no advantage can be derived from the increase of temperature obtained by adiabatic compression, because this is rapidly lost by cooling in the pipes long before the air is utilised in the air-engine drives. It is worth noticing that, because of the air being discharged from the compressors through valves which automatically lift when a certain designed pressure is reached, this loss of power due to cooling in the pipes is effected rather by a contraction of volume than by a diminution of pressure. The decreasing-pressure gradient along the pipes is very small, and is due solely to frictional and viscous resistance to the flow, and to variation of velocity consequent on variation of section.

In order to approximate to isothermal compression

r. Sturgeon has adopted very special cooling arrangements for his compressors. Firstly, the air used is all taken through the roof of the engine-house, and thus heating by contact with the boilers and engines below is avoided. It is filtered of deleterious dirt in entering through the roof. Secondly, the compressor cylinders are surrounded by ample water jackets, through which a continual fresh-water circulation is kept up. Thirdly, the delivery-valve—it is a single large disk of slightly greater diameter than the cylinder—is made hollow, and through a cold-water circulation is kept up, the water being read out in a thin radial stream across the valve face over which the air flows as it leaves the cylinder. This cooling-water is supplied to the hollow valve through a pipe sliding in a stuffing-box in the cylinder cover. A further development of this system would be a supply of cooling water to the face of the piston after the manner

that the steam is supplied to the piston-jacket of the low-pressure engine cylinder; but this refinement has not been deemed necessary in the design as at present adopted.

The compressor piston-face travels a little beyond the position assumed by the flat face of this delivery-valve when the latter is closed. During the momentary pause at the end of the stroke, the valve therefore falls into actual contact with the piston-face, and the two descend together until the valve is landed on its seat. Thus the clearance space is reduced absolutely to zero.

The suction-valves are somewhat similarly arranged so as to reduce the clearance at the other end of the stroke to a very small amount. The cooling-water is circulated by gravity from a tank giving a head of 20 feet. The water is pumped into this tank from the canal, and the power spent in pumping this water is a partial set-off

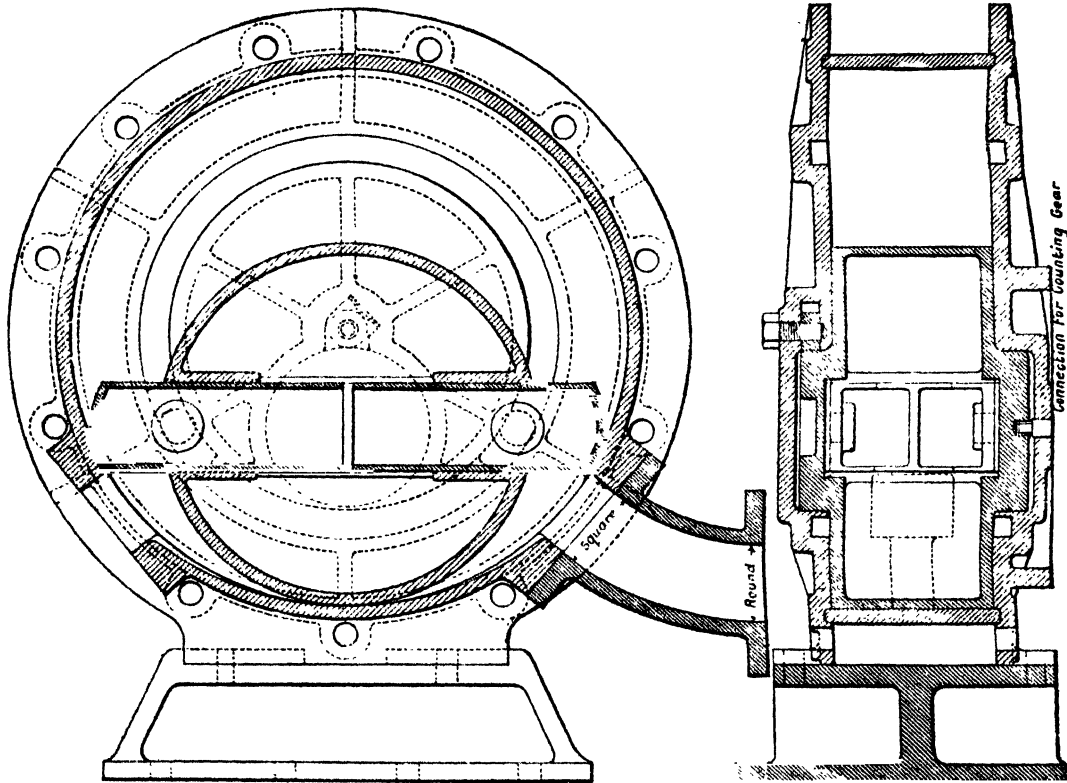

FIG. 1.

against the economy resulting from the approximation to othermal compression; but the power thus gained greatly outweighs the work spent in this pumping.

As at present designed, the air-pipes are of wrought-iron plate, riveted, but a new design for plate-steel tubes is being considered. The pipes are to be laid in concrete tunnels, which free them from all pressure of superincumbent soil or paving, and will always be very accessible for examination and repair. They are of 24 inches diameter near the central station, and diminish to 7 inches in the smallest ranches. The joints are given a small degree of flexibility. In one design they are formed by two angle-plates riveted to the outside ends of the two pipes, a hard rubber ring of circular section being placed between the angles thus formed, and the flanges being drawn together by bolts. In another design a sort of double-socket coupling-piece covers the ends of both pipes for a few inches; the end of each pipe has formed on it two slightly

projecting rings, and between these is poured, in the molten state, through a hole in the socket-coupling, a soft metal that expands during solidification. We rather doubt whether this last design will give sufficient tensile strength to the joint. Tensile strength is required simply because there are necessarily bends in the pipe here and there.

The air is supplied to the consumer through a registering meter. This meter is similar in construction to Beale's gas exhauster. It consists of two cylinders, one inside the other. Both are 4 inches long; the outer one has a diameter of 14 and the inner a diameter of 9 3/8 inches. The outer one is fixed, and is furnished with an inlet and an outlet opening. The inner cylinder revolves freely on a fixed axis, distant 1/2(14 - 9 3/8) = 2 1/8 inches away from the centre of the outer case, so that the two cylinders always touch along a fixed line. Two sliding shutters project from a slot through the centre of the revolving

cylinder. By means of a pin and a pair of sliding blocks running in circular grooves cut on the inner surface of, and concentric with, the fixed cylinder, these shutters are drawn out and in from the revolving cylinder so as always to keep in contact with the fixed one. During one revolution these shutters sweep through the meter a volume of air about '17 cubic feet.

This rotation is reduced three times by worm-gearing in being transmitted to the counter-box, so that a single dial with two concentric circular scales, which are read by two fingers like the hour- and minute-hands of a common clock, is sufficient to register up to a million cubic feet. Fig. 1 shows this meter. It is driven by a small difference of air-pressure between the inlet and outlet.

The Company intend to charge at the rate of 5*d.* per 1000 cubic feet at standard pressure of 45 pounds per square inch. If the air were used in an engine without expansion, without clearance space, and without back pressure above the atmosphere, this would correspond to a cost per hour per indicated horse-power of

$$\frac{60 \times 33000 \times 5}{144 \times 45 \times 1000} = 1.53 \text{ pence.}$$

Under the conditions of actual practice the writer calculates that at the above rate of 5*d.* per 1000 cubic feet, assuming intelligent and economical management, each

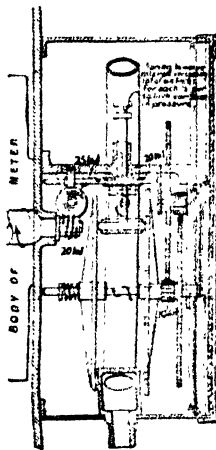

FIG. 2.

indicated horse-power will cost per hour from 2*d.* down to as low as 1½*d.*, excluding cost of engine attendance and depreciation, and interest on first cost of engine.

The standard pressure at which the air is sold at the above price being 45 pounds per square inch, a reduction of price per cubic foot has to be made if the pressure of the supply be less than this pressure. This is effected by introducing a variable velocity-gear between the volumeter and the dial-counter. This arrangement is shown in Fig. 2.

The rotation is transmitted to a small roller on a spindle capable of sliding in its bearings parallelly to its own axis. It drives a disk on the counter-arbour by rolling contact. The end of the roller-spindle is linked to the end of the tube of a Bourdon pressure-gauge. As the pressure rises, the roller is thus pushed nearer the centre of the disk, and gives this disk, therefore, an increasing fraction of a revolution per revolution of the roller. The roller really lies between two disks, but the one is "idle" and serves simply to support the roller in pressing against the driven disk.

This integrator is wholly wrong in principle, and it is badly designed in detail. The roller has a rubber tyre round it, and therefore touches the disk at different radii, and thus must rapidly wear away, owing to the want of

pure rolling action at one or other side of its tread. The wearing might not be of much consequence in itself, except that it gradually vitiates the accuracy of the indication; and besides, the velocity ratio is uncertain because of the contact taking place over a perceptible range of radius. There ought to be an idle roller between the disks opposite the driving roller, and both disks ought to be pressed inwards by springs, instead of one only. But the chief defect is in the principle of the construction, which does not make the dial-indication proportional to PV as it ought to do. If R_0 be the disk radius at which the roller would stand when zero pressure existed in the Bourdon tube, and if C be the inward movement per pound per square inch rise of pressure, and if r be the radius of the roller, then at pressure P the contact radius on the disk will be $R_0 - CP$, and the fractional revolution of the disk per revolution of the roller is $\frac{r}{R_0 - CP}$. This is not proportional to P as it ought to be. Its differential coefficient with respect to P should be constant, whereas it is really $-\frac{Cr}{(R_0 - CP)^2}$. The converse gearing ought to be substituted; that is, the volume-meter should be geared positively with the disk, and the disk should drive

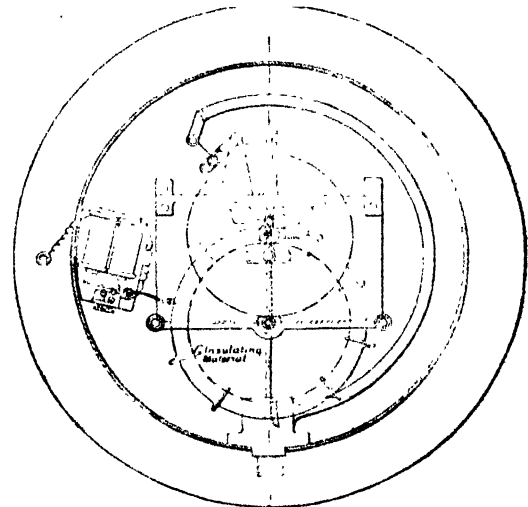

FIG. 3.

the roller, the point of contact for zero pressure coinciding with the centre of the disk. It also seems a pity, when a Bourdon tube that measures the pressure exists in any case in the meter, that its measurement of the pressure should not be made visible by the simple addition of a pointer and graduated dial.

The registrations of all the meters in the whole district are telegraphed to the central station and added up on one large central counter, so that the engineers in charge may have means of continually comparing the actual consumption with the duty of the engines, known from ordinary engine continuous counters, and of detecting any serious leakage that might occur in consequence of breakage of a main or branch pipe. The telegraphing apparatus is shown in Fig. 3. The counting disk is divided into ten equal divisions, each representing 1000 cubic feet, by small metal projections. As these come successively underneath a contact-maker, they allow the passage of a current, which moves the finger of the central counter through a corresponding division. One main wire, with branches to the separate meters, is sufficient for the whole district, the earth return being used. As the counter-disk moves slowly, special means must be taken to break the

contact instantaneously after it is made ; otherwise all but one of the indications of several meters, whose times of contact with the tooth on the disk overlapped, would fail to be registered at the central station, and should the stoppage of any one engine in the district happen to occur while this tooth of its meter was in contact the whole registering apparatus would cease to act for an indefinite time.

The contact-breaker is shown in Fig. 3, at the left-hand side. The momentary current caused on making contact magnetises an electro-magnet, which, by attracting its armature, draws the contact-maker (which is mounted on a piece of watch-spring) past the tooth into such a position that it catches behind a small plate of insulating material at the back of the tooth, which prevents it springing again into contact with the latter when the armature of the magnet is released.

Fig. 4 explains the calculation of the thermodynamic efficiency of this mode of transmission of power. It is drawn for unit volume of atmospheric air drawn into the air-pumps. The pressures are reckoned in atmospheres. A B C D E is the indicator-diagram showing the work done by the compressor-pump. The compression-curve C D is taken according to the law $p \propto v^{-1.2}$ because it seems probable that this index may be reached with the efficient water-cooling system adopted. The suction-line A B is

taken $\frac{1}{10}$ atmosphere below atmospheric pressure. The point F is taken on the same isothermal as C ; thus D F is the loss of volume consequent on the air cooling in the pipes down to atmospheric temperature. The diagram E F G H is the indicator-diagram for an engine driven by the air without loss of initial pressure below the compressor pressure, without clearance, without expansion, and with a back pressure $\frac{1}{10}$ atmosphere above atmospheric pressure. The same back pressure is used for all the other engine diagrams. The diagrams E F I K H, E F L M H, and E F N H are diagrams for engines with similar conditions, and with ratios of expansion $1\frac{1}{2}$, 2, and $2\frac{1}{2}$; that is, with cuts off $\frac{3}{4}$, $\frac{1}{2}$, and $\frac{2}{3}$, the last being that which brings the final pressure down to $1\frac{1}{10}$ atmosphere. The expansion-curve F I L N is taken as adiabatic. If $\frac{1}{3}$ atmosphere be lost in frictional and viscous resistance to flow through the pipes, by obstructions at bends, passage through meter, &c., or by sudden change of section of pipe, then the admission line is lowered to P Q. The effect of clearance is to cut off a part of the diagram by a vertical line at the left-hand end. This vertical line is not drawn in the diagram, because its position varies with the grade of expansion employed. In calculating the following results the clearance has in each case been taken as $\frac{1}{10}$ the volume of the cylinder. The area of the compressor-diagram is 1.6, and the efficiency is in each case obtained

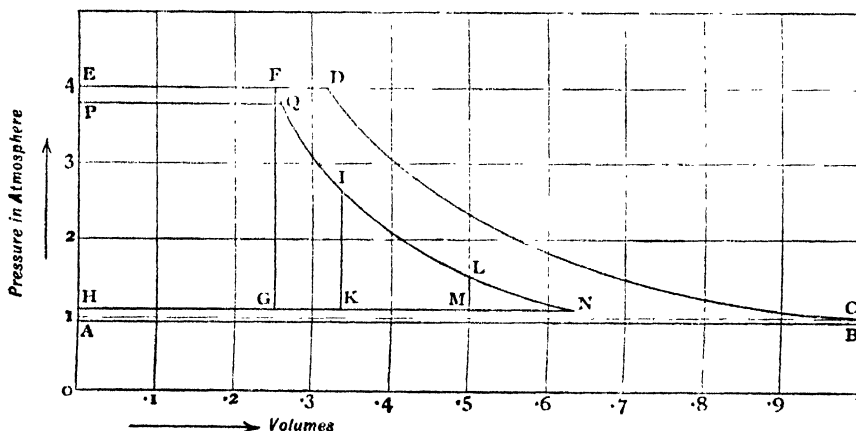

FIG. 4.

by dividing the engine-diagram area by 1.6, and multiplying this quotient by $\frac{10}{100}$. This $\frac{10}{100}$ is the ratio between the compressor-diagram and that of the central station engine which drives it, the mechanical inefficiency of this central plant being taken as $\frac{1}{10}$. The results are most clearly shown in tabular form.

Table of Efficiencies of Transmission of Power by Air compressed to 45 pounds per square inch

Ratio of expansion	Efficiency			
=	1	$1\frac{1}{2}$	2	$2\frac{1}{2}$
No loss of initial pressure	.45	.58	.67	.72
No clearance				
Back pressure 1.1 atmos.	.42	.54	.64	.69
Initial pressure 3.8 atmos.				
No clearance	.39	.50	.57	.60
Back pressure 1.1 atmos.				
No loss of initial pressure	.36	.47	.54	.57
Clearance $\frac{1}{10}$ vol. of cyl.				
Back pressure 1.1 atmos.				
Initial pressure 3.8 atmos.				
Clearance $\frac{1}{10}$ vol. of cyl.				
Back pressure 1.1 atmos.				

The last two sections of this table comprise the limits of practicable results. The highest efficiency shown is 60 per cent. This could only be obtained by avoiding absolutely all loss of pressure between compressors and air-

engine. This can hardly be accomplished even if the engine be situated close to the central works. It need hardly be pointed out that the expansion will not usually be carried so far as to bring the working pressure to near equality with the back pressure ; in fact, to do so is decidedly very bad practice, and does not lead to economy in the brake-power, especially when depreciation and interest on first cost of the engine is taken into account. With good management, from 30 to 50 per cent. efficiency may be expected.

In a paper read by Mr. Sturgeon before the British Association last summer, he gives a table of calculated efficiencies ranging from .32 to .84. These calculations include allowances of 2 per cent. for valve-resistance and leakage past compressor-piston ; 13 per cent. for leakage, friction, and wire-drawing in the pipes ; and 8 per cent. for clearance and back pressure in the consumer's engine. Except the last, these allowances are much more liberal than those that have been made in calculating the above table. On the same basis as ours have been made, Mr. Sturgeon's calculations would have given considerably higher figures than the above .32 to .84. But the higher figures in Mr. Sturgeon's table are obtained by supposing that the consumer heats the air by a gas-stove, before passing it into his engine, up to temperatures from 212° F. to 320° F. How the resulting figures can be in any sense

called "efficiencies" it is difficult to understand. The consumer is supposed to supply a large extra amount of power at his own cost by burning gas to heat the air, and it seems an extremely evident misuse of the word "efficiency" to apply it to the ratio of the diagram so got to the diagram of the central station engine. By a little more liberal burning of gas, the efficiency obtained by this method could quite easily be made higher than unity. On the same principle we might calculate the efficiency of a steam-engine by taking the ratio of the indicator-card from the steam cylinder to that taken from the feed-pump that supplies water to the boiler, and thus obtain an efficiency of, let us say, 50,000 per cent. This is a *reductio ad absurdum* of the method of calculation which is perfectly legitimate and logical.

R. H. S.

THE CLASSIFICATION OF THE CÆCILIANs

IN a paper on the structure and affinities of the Amphiumidæ, published in the newly-issued part of the Proceedings of the American Philosophical Society (vol. xxiii. No. 123), Prof. Cope has put forward some views as to the position of the Cæcilians or Apodous Batrachians in the Systema Naturæ, which are worthy of careful consideration. The Cæcilians, Prof. Cope observes, are generally regarded as representing a distinct order of the Batrachian class, which bears the name "Apoda," or "Gymnophiona." The definition of this order given by Mr. Boulenger in his recently published Catalogue of the specimens of these animals in the British Museum is: "No limbs; tail rudimentary; males with an intermittent copulatory organ; adapted for burrowing." Of these definitions Prof. Cope maintains that not one is of ordinal value. "The tail in some Cæcilians is distinct. The intromittent copulatory organ in such species as *Dermophis mexicanus*, *Gymnophis proximus*, and *Herpethochrocephala* is not a special organ, but merely the everted cloaca. The hard papillæ observed by Günther in *Ichthyophis glutinosus* are wanting in the above-mentioned species, and the protrusion of the cloaca is performed by two special muscles."

As regards the absence of limbs in the Cæcilians, Prof. Cope points out that the extremely rudimentary character of these organs in *Amphiuma* is well known, and that their non-existence has no greater claim to be considered as of ordinal value in the Batrachians than in the adjoining class of Reptiles, where it is in some cases not even a "family" character. Looking to these facts, Prof. Cope proposes to unite the Cæcilians with the Urodele Batrachians, and to class them only as a family, "Cæciliidæ," connected with the more typical forms of the group through the Amphiumidæ.

Messrs. Sarasin, who have recently published a most interesting account of their observations on the development of a species of Cæcilian in Ceylon,¹ seem to have come to nearly the same conclusions as to the correct systematic position of this group of Batrachians.

NOTES

THE Prince of Wales has requested the President of the Royal Society to join the Committee appointed to advise on the organisation of the proposed Imperial Institute.

WE have referred elsewhere to some of the possible results of the meetings held last week in favour of the Imperial Institute. Some very striking features which have been developed in connection with this movement during the last week are, first of all, the considerable desire which has been evinced, to enrich various localities with some jubilee memorial, and, again, the wisdom

generally displayed in selecting worthy local objects, such as museums, improved science schools, and the like. All this of course is admirable and entirely to be applauded, but believing as we do that there is a possibility of the Imperial Institute, if properly conducted, doing more good for the future development of science and commerce in Greater Britain than any other single organisation can possibly effect, we hope that it will not be starved in favour of merely local objects. We hear that the women of England have already subscribed a noble sum. This no doubt Her Majesty will hand over to the Institute, if it is organised so as to command the confidence and respect of the various leaders of opinion in this country and in the colonies.

MANY of our readers will attach much importance to Colonel Donnelly's letter, which appears in another column. A large increase in the number of students anxious to enter the Normal School of Science and Royal School of Mines was of course to be expected, and we are glad that this influx has induced the department to take steps to increase the accommodation, and at the same time to insist upon one of the best possible forms of entrance examination; a strict inquiry, namely, into the educational history of each candidate for admission.

THE Norwegian Government has presented a Bill to the Storting for fixing a standard time for the whole of Norway. The standard time proposed is Greenwich time *plus* one hour.

MR. W. BALDWIN SPENCER, Fellow of Lincoln College, Oxford, has been appointed to the Chair of Biology in the University of Melbourne, and will leave England in about three weeks. Mr. Spencer distinguished himself lately by his important memoir on the pineal eye in lizards.

A NUMBER of eminent men of science have addressed a memorial to the President, Vice-Presidents, and Council of the Royal College of Surgeons of England, suggesting that the legacy bequeathed to the College by the late Sir Erasmus Wilson might with advantage be devoted to the establishment of an institution having for its object "physiological and pathological research." It is pointed out that the want of such an institution in England has long been felt, and more especially of late, when we have had to look to Berlin for information respecting tubercle, and to Paris for experiments on the prevention of hydrophobia. That the Government will do anything in the matter no one is so sanguine as to believe; and it is hardly more probable that the want will ever be supplied by public subscription. There is, therefore, much to be said for the present proposal, and the authorities of the College of Surgeons will, no doubt, give it due attention. It seems strange that in London there should be nothing like the splendid laboratories which exist not only in the capital cities of Europe, but in comparatively small German towns, such as Bonn, Strasburg, and Leipzig.

UNIVERSITY COLLEGE, Liverpool, has reason to congratulate itself on having some remarkably generous and enlightened friends. On Tuesday last it was announced at a meeting of the College Council that Mr. Thomas Harrison, shipowner, of Liverpool, had endowed the Chair of Engineering with 10,000*l.* Only a few weeks ago Sir Andrew Walker, also a citizen of Liverpool, gave 15,000*l.* to build Engineering Laboratories.

ON Thursday last the honorary freedom of the City of London was conferred upon Mr. H. M. Stanley, in recognition of his services as a traveller and explorer in Africa. The presentation was made at a special meeting of the Court of Common Council in the new council chamber at the Guildhall. The City Chamberlain, in making the presentation, referred to the remarkable development of journalistic enterprise during the Victorian era," observing that Mr. Stanley was the first member of "the

¹Ueber die Entwicklungsgeschichte von *Epicrion glutinosum*, Arb. Zool. Inst. Würzburg, vii. p. 202 (1885).

lass of special travelling and war correspondents" whom the city had enrolled among its freemen. Mr. Stanley was evidently much pleased by the honour done to him, and declared that it would stimulate him to further exertions. After luncheon at the Mansion House, he spoke of the various routes which have been proposed for the expedition for the relief of Emin Pasha.

MR. ALFRED RUSSEL WALLACE lately delivered, at Boston, U.S.A., a course of "Lowell Lectures." He proposes to make a Western tour, in the course of which he will lecture on, among other subjects, "The Darwinian Theory: What it is, and How it is demonstrated," "The Origin and Use of the Colours of Plants," "The Permanence of Oceans, and the Relations of Islands and Continents," and "The Biological History of Continental Islands, Recent and Ancient." Mr. Wallace is thought by the Americans to be a more effective speaker than most of the eminent Englishmen who have lectured in the United States.

THE Indian Survey Staff seems to be considerably undermanned. The Government of the Straits Settlements recently applied to the Government of India for an experienced officer to advise them on the way of placing the system of survey in the colony on a satisfactory footing. As no qualified officer on the former establishment was available, Mr. J. B. N. Hennessey, now on the retired list, was offered the duty, but as he declined the Straits Settlements Government had to be told that the Government of India could render no assistance on a work so necessary to the development of the colonial resources, and likely to be of so much service to science.

A MOVEMENT is on foot at Gothenburg for the founding of a free University in that city. A large sum of money has already been subscribed.

THE results of the new censuses of France and Germany show marked falling-off in the rate of increase. In the case of France the rate of increase was low enough before; now it threatens to stop altogether, and in many departments there has been a considerable decrease. The addition to the population in five years is only been 213,857, bringing the total up to 37,885,905. This is equal to an annual rate of only 1 per cent. per annum. Germany is not quite so bad, but the rate of increase between 1870 and 1880 was abnormally high. The population by the latest returns is 46,844,926 as compared with 45,234,061 five years before; giving an annual rate of increase of 71 per cent. per annum in 1880-85, as compared with 114 per cent. per annum in the previous five years.

THE Lieutenant-Governor of the Punjab has proposed to the Government of India the establishment of a University at Allahabad, and has furnished a scheme for such an institution the capital of his province.

AT the afternoon sitting of the Association for the Improvement of Geometrical Teaching, held at University College, on the 14th inst., the President (R. B. Hayward, F.R.S.) in the chair, the Rev. G. Richardson, of Winchester College, read a paper on the teaching of modern geometry, in which he indicated the lines which, in his opinion, a Syllabus on the subject should follow. The draft, which covered an extent of ground so great, we think, for ordinary school-teaching, did not consist of a bare enumeration of the subjects of sections and chapters, it was rendered very interesting by the quaint humour which brightened up and pervaded the whole. The Rev. J. J. Milne read a short note on a part of the above subject, which had been omitted by the previous speaker, viz. the modern statement of maxima and minima; his strong point was the light to be derived from a symmetry in the search for cases of maximum and minimum. Mr. G. A. Storey, A.R.A., read a

paper on "Geometry from the Artist's Point of View." In this the writer introduced Euclid and Apelles in converse, and showed the agreement which exists between the purely geometrical method and perspective. The paper was illustrated by numerous drawings of triangles, squares, and cubes. A brief discussion of the several papers followed, and then Mr. E. M. Langley communicated a very simple proof of Feuerbach's theorem (that the nine-point circle touches the in- and ex-circles of the triangle). We may return to the consideration of one or more of the above papers when they have been printed in the Association's Report. Upwards of twenty new members were elected.

WE have received a hand-book entitled "Through the British Empire in Ten Minutes with C. E. Howard Vincent, Esq., C.B., M.P." It is intended to accompany a wall-map on which Mr. Vincent has brought together a large amount of useful information about the British Possessions. In his hand-book he glances at the leading characteristics of each of the great groups into which the Empire beyond the seas is divided.

A STATE weather-service for Pennsylvania is to be formed at Philadelphia by the Franklin Institute. The State Legislature will be petitioned for an appropriation of 3000 dollars for instruments and publications, and it seems to be assumed that so reasonable a request will be readily granted.

THE Americans also have a Society for Psychical Research. The Society proposes to issue the next number of its Proceedings as soon as sufficient material can be collected. Apparently it is not quite so easy to get startling evidence of the "psychical" kind in the New World as in the Old.

DESCRIBING in an American medical journal the influence of the recent earthquake shocks in Charleston upon the health of the inhabitants, Dr. F. Peyre Porcher, of that city, says that many persons experienced decidedly electrical disturbances, which were repeated upon the successive recurrence of the shocks. These disturbances were generally accompanied by tingling, pricking sensations, like "needles and pins," affecting the lower extremities. One gentleman was completely relieved of his rheumatism; another, who for months was nervous, depressed, and entirely unable to attend to business, regained his former activity and energy.

AN interesting sketch of the great Serpent Mound in Ohio is given in *Science* by Mr. W. H. Holmes. It is in the northern part of Adams County, somewhat remote from frequented routes of travel. The entire body of the serpent and the peculiar features of the enlarged portion are all distinctly traceable, and leave no doubt in the mind, Mr. Holmes thinks, as to their artificial character. He is decidedly of opinion that the work should be classed among the products of the religion of the aboriginal races.

MR. J. H. STEWART LOCKHART, of Hong Kong, has addressed, on behalf of the Folk-Lore Society of England, an appeal in the English and Chinese languages, through the press, to students throughout China to co-operate in investigating the folk-lore of that country. He points out that no attempt has been made to deal with this subject as a whole, the work done so far being for the most part of a local character. He now proposes to obtain collections of the lore peculiar to different parts of the empire and its dependencies. Each collection, he goes on, while in itself highly instructive, will be chiefly important as forming a link in the chain of facts from which a general account of the folk-lore of China may be deduced. The Chinese version of the appeal is intended for circulation amongst natives, who, "experience shows, evince a great interest in the subject when once they comprehend its aims and objects." Competent scholars are scattered over the greater part of China, and, as

Mr. Lockhart says: "If willing helpers can be found to assist in the work of collection, the success of the scheme is assured. Failure can only result from want of co-operation and support."

In a paper entitled "Thirty-six Hours' Hunting among the Lepidoptera and Hymenoptera of Middlesex," reprinted from the *Journal of Microscopy and Natural Science*, Mr. Sydney T. Klein has some interesting notes on the best methods of capturing Lepidoptera. He has found it very useful to take advantage of "the attractiveness of the ladies among the Lepidoptera gentry." To those who have not had experience, or have not persevered in, this art, he says, the result is truly marvellous, and will sound very much like a fairy tale. The good taste possessed by the males of Lepidoptera is shown to the greatest perfection among the Bombycidae. On several occasions, when on botanical excursions in Hertfordshire, Mr. Klein has taken with him a female of *Bombyx quercus*, or other Bombycidae, fresh from the pupa; and, in a wooded country, provided the sun was hot and a gentle breeze blowing, he was certain of having, within ten minutes, a dozen of the opposite sex flying round him, and from time to time even settling on his shoulders or hands. On one occasion, after remaining, as an experiment, for some time on the same spot, he counted over forty of these large moths within fifty yards.

NEGOTIATIONS are being carried on in Denmark for the holding of a Fisheries Exhibition in Copenhagen next year.

AN enthusiastic fish-culturist is trying to introduce scaleless fishes into English fresh waters. In a lecture on Fish, lately delivered at Worcester, and now published, Dr. Francis Day, C.I.E., expresses his belief that they will prove worthless for sport, almost, if not entirely, useless as food, and dangerous to handle on account of the spines with which they are protected. These fishes delight to eat other forms of fish-life. "I obtained," says Dr. Day, "a specimen of a common Indian catfish at Madras, which I placed in an aquarium that contained some carp. It rushed at one of my poor little fishes, and, before I could interfere, seized it by the middle of its back and shook it until it was dead, as a dog kills a rat."

AT the monthly meeting of the Council of the Sanitary Assurance Association on January 13, the Sanitary Registration of Buildings Bill was re-considered. A report on the draft Bill was submitted, with several clauses re-drawn. The Bill was further amended, and ordered to be printed for final consideration at the next meeting of the Council. It is proposed that the new Bill shall be compulsory with regard to schools, hotels, asylums, hospitals, and lodging-houses, and Clause 6 has been made much more stringent in the matter of qualification of persons entitled to give sanitary certificates.

BARON VON MUELLER, who retains the office of Government Botanist to the colony of Victoria, is about to issue a series of plates with descriptions of the acacias (wattles) of Australia. The work will be similar to the "Eucalyptographia," probably the best and most useful of his publications. For diagnostic purposes he makes use of two characters hitherto overlooked, viz. the number of divisions in the pollen-mass and the position of the seed. The retirement of Baron von Mueller from the direction of the Botanic Garden, some few years since, has enabled him to devote more attention to scientific botany and its applications to practical purposes.

DR. GILES, who was attached as scientific member to the Chitral-Kafiristan Mission, is now stated to be in Calcutta, engaged in writing a report on the geology of that region.

CAPT. PEACOCKE, R.E., is said to be preparing a report, with sketches, of his experiences with the Afghan Boundary Commission.

ON Thursday evening last the Society of Telegraph-Engineers and Electricians held the first general meeting of the session of 1887. Sir Charles T. Bright, the new President, delivered an address on the history of the electric telegraph. Speaking of the progress which has been made since the property of the Telegraph Companies was bought by the State, he said that in 1870, when the transfer was completed, there were 48,378 miles of land wires, and 1622 miles of cable wires (irrespective of railway wires), connecting together 2488 telegraph stations. Now the Post Office has 153,153 miles of wire (including submarine wires) in communication with 5097 offices. In addition, the railway companies have 70,000 miles of wire, making a total of 223,153 miles.

THE additions to the Zoological Society's Gardens during the past week include a Red-fronted Lemur (*Lemur rufifrons* ♂) from Madagascar, a Vervet Monkey (*Cercopithecus lalandii* ♂) from West Africa, presented by Mrs. Pawelzig; a Patas Monkey (*Cercopithecus patas* ♀) from West Africa, presented by Mr. George Ellis; a Common Otter (*Lutra vulgaris*), British, purchased.

OUR ASTRONOMICAL COLUMN

NEW VARIABLES IN CYGNUS.—A new variable of the Algol type (D.M. + 34°, No. 4181, R.A., 1887° 0, 20h. 47m. 32.5s., Decl. 34° 13' 59".5 N.), has been discovered by Dr. Gould. Its period is about three days in length, and it varies from 7.1 mag. to 7.9 mag. A minimum occurred at about 10h. 19m. G.M.T. on January 17. This discovery raises the number of stars of the type to eight, the other seven being Algol, period 2.49d.; λ Tauri, 3.95d.; S Cancri, 9.48d.; δ Librae, 2.32d.; U Coronae, 3.45d.; U Cephei (D.M. 81° No. 25), 2.49d.; and U Ophiuchi (DM + 1°, No. 3408), 0.839d.

Mr. S. C. Chandler, Jun., in a note in Gould's *Astronomical Journal*, No. 148, calls attention to a new short-period variable very close to the above. This star (Lalande 40383, R.A., 1875° 0, 20h. 38m. 30.2s.; Decl. 35° 8' 24".6 N.) varies from 6.3 m. to 7.6 m. in a little over fourteen days, the increase occupying about four days, the decrease ten days, with a halt in the latter about midway of its course. Mr. Chandler gives for first elements of the star, 1886 October 3.60 G.M.T. + 14^d.04 E.

NEW MINOR PLANET.—Prof. C. H. F. Peters, at Clinton, discovered a new minor planet on December 22. This will be No. 264, and the forty-sixth discovered by Prof. Peters.

A NEW METHOD FOR THE DETERMINATION OF THE CONSTANT OF ABERRATION.—In the *Comptes rendus*, tome civ. No. 1, M. Loewy explains how the principle of his method of determining the amount of astronomical refraction (NATURE, vol. xxxiii. p. 303) can be applied to the determination of aberration also. By means of the two reflecting surfaces forming the double mirror placed in front of the object-glass of an equatorial, the images of two stars situated in different parts of the sky appear, in the field of view, side by side; their angular distance is then to be measured in a known direction. To obtain the amount of aberration it is, of course, necessary to measure a properly chosen pair of stars at successive epochs. The first observation is to be made when the stars are at the same height above the horizon, and the second, after a certain interval, under similar conditions. The comparison of the two measures will give a multiple value of the aberration which is independent of instrumental errors. By a proper choice of the angle of the double mirror employed, of pairs of stars selected for measurement, and of the circumstances of observation, M. Loewy contends that, by attention to the details which he specifies, a more accurate value of the constant of aberration can be obtained by his method in an interval of three months than could be deduced by the methods hitherto in vogue, liable as these are to systematic error.

THE MADRAS OBSERVATORY.—In his Report for the year 1885, Mr. Pogson states that the volume of telegraphic longitude determinations in India, and the two volumes of hourly magnetical observations made at Singapore between 1841 and 1845, and at Madras between 1851 and 1855, which were men-

oned as ready for issue in the last Report, were distributed in 1885. Mr. Pogson's attention was chiefly directed, during the year, to the necessary preliminary investigations for the publication of the meridian-circle observations from 1862 to the present time. The formation of the star ledgers and the deduced catalogues of mean positions for each year were completed for the years 1862, 1863, and partly for 1864, which will form the first of the eight volumes about to be published. The star ledgers for the next three years—1865-67—are also in progress, and the second volume of the series. Except for time observations and determinations of positions of a few comparison stars or equatorial observations, the meridian-circle will be little used until the publication of its past results is accomplished. Only 52 complete positions of stars were determined in 1885, making 2,074 during the past twenty-four years. A few observations of minor planets were made with the equatorials during the year. We are glad to find that there is at length a prospect of the publication of the Madras meridian observations, the long delay in which has been a serious blot on the fair fame of the observatory.

ASTRONOMICAL PHENOMENA FOR THE WEEK 1887 JANUARY 23-29

FOR the reckoning of time the civil day, commencing at Greenwich mean midnight, counting the hours on to 24, here employed.)

At Greenwich on January 23

sun rises, 7h. 54m.; souths, 12h. 12m. 4'45s.; sets, 16h. 30m.; decl. on meridian, 19° 27' S.: Sidereal Time at Sunset, oh. 41m.

Moon (New, January 24) rises, 7h. 14m.; souths, 11h. 40m.; sets, 16h. 9m.; decl. on meridian, 18° 13' S.

Planet	Rises		Souths		Sets		Decl. on meridian
	h. m.	h. m.	h. m.	h. m.	h. m.	h. m.	
Mercury	7 38	11 34	15 30	23 0	15 30	23 0	S.
Venus	8 34	13 4	17 34	17 34	17 34	17 34	S.
Mars	8 49	13 36	18 23	14 36	18 23	14 36	S.
Jupiter	1 0	6 2	11 4	11 54	11 4	11 54	S.
Saturn	14 59	23 6	7 13*	22 6	7 13*	22 6	N.

* Indicates that the setting is that of the following morning

Occultations of Stars by the Moon (visible at Greenwich)

n.	Star	Mag.	Disap.	Reap.	Corresponding angles from vertex to right for inverted image	
					h. m.	h. m.
4	Ceti	6	19 16	20 13	179	290
5	Ceti	6	19 42	20 26	196	281

Variable Stars

Star	R. A.		Decl.		h. m.
	h. m.	h. m.	h. m.	h. m.	
Cephei	0 52'3	81 16 N.	Jan.	26, 22 21	m
Tauri	3 54'4	12 10 N.	"	24, 20 33	m
Gemini	6 57'4	20 44 N.	"	28, 19 25	m
Cancer	8 37'5	19 26 N.	"	29, 0 0	m
Virginis	12 32'8	7 37 N.	"	24, 0 55	m
Virginis	13 22'0	2 35 S.	"	26, 0	M
Librae	14 54'9	8 4 S.	"	23, 0	M
Coronae	15 13'6	32 4 N.	"	24, 18 23	m
Ophiuchi	17 10'8	1 20 N.	"	27, 2 15	m
			and at intervals of	20 8	
Scuti	18 41'4	5 50 S.	Jan.	27, 0	m
Lyrae	18 45'9	33 14 N.	"	26, 3 0	M
Cephei	22 25'0	57 50 N.	"	28, 1 0	M

M signifies maximum; m minimum.

Meteor-Showers

On January 28 a radiant near δ Coronae Borealis is in evidence. The meteors from this radiant are very swift, R.A. 6°, Decl. 25° N. Another radiant giving very swift meteors σ near σ Leonis, R.A. 168°, Decl. 7° N.

GEOGRAPHICAL NOTES

It is all but certain that Mr. Stanley will lead the Emin Pasha Relief Expedition by the Congo route. He will certainly go to Zanzibar, prepared to follow whatever route circumstances may indicate as likely to prove the most successful. At

Port Said he will meet with Dr. Junker, who may give him information of critical importance. At all events, Mr. Stanley and his staff and the whole of the baggage will proceed, in the first instance, to Zanzibar. If a steamer is handy, the Expedition, after recruiting a caravan and laying in a store of suitable goods for trade by the way, will sail round the Cape to the Congo; that at least is Mr. Stanley's present intention. All the available steamers belonging to the King of the Belgians will be placed at his disposal, and probably by the beginning of May he will be at the limit of navigation and ready for his land journey eastwards to Lake Albert Nyanza; if, indeed, he does not give the lake a wide berth westwards and go direct to Wadelai. A camp as a base of operations will be established, as far as safe from the Congo, and left in charge of a trustworthy member of the staff. About fifty donkeys will be taken to carry the heavy baggage, and the caravan will consist of about 100 men, with a few Egyptian soldiers to maintain discipline. The staff consists of half-a-dozen carefully selected men, among whom are two able engineer officers, under whose care the interests of science will be attended to. Four or five carefully rated chronometers and other instruments are being taken, so that we may expect some good results. It is probable that Mr. Stanley will endeavour to solve the Albert Nyanza and the Wellé-Mobangi problem, as well as other obscure points in African hydrography, on his return journey. It is to be hoped that Emin Pasha will not think of coming away, as Dr. Junker states he wishes to do; but if he does, then no doubt Mr. Stanley will be able to make arrangements to carry on the work which Emin has begun so well. Mr. Stanley leaves England to-morrow, and the good wishes of all will go with him. He is confident of being able to reach Emin Pasha by July 1, and possibly may be back in Europe about Christmas; in that case, we fear, he could not do much exploring work.

DR. LENZ has at last arrived at Zanzibar, having taken less than eighteen months to cross the African continent from the mouth of the Congo. A fortnight ago we gave some account of his journey up the Congo from Stanley Falls to Nyangwe and Kasonge; it will be interesting to know what route he followed after leaving the Upper Congo. It will be remembered that Dr. Lenz went out eighteen months ago for the purpose, if possible, of reaching Emin Pasha and Dr. Junker. From Zanzibar the late Dr. Fischer started through Masai Land on a similar errand. In both cases the object has not been accomplished, and no wonder, now that we know the real facts. Much good work, however, has been done by both men. Dr. Lenz is a man of scientific training and experience in African travelling, and there can be no doubt that the results of his just completed journey will be a gain to science. It is possible that Mr. Stanley may meet with Dr. Lenz on his way to Zanzibar; and if so may obtain some information that will be of service on his great expedition.

THE Rev. Thomas Brydges, a missionary in Tierra del Fuego, in the large island of Onisin, among the Ona and the Yagbons, mentions a curious circumstance with reference to the people, illustrating the influence of environment on the acquirement of habits. Between men and women there is a fair subdivision of labour. Among other things, the men make and fit up the canoes, but the women are the rowers. The result is that the women are good swimmers, but the men cannot swim at all. The reason is that often on the coast there is not a single tree to which to fasten the canoes. The women, therefore, after landing their husbands, have to row the canoes to a spot where sea-weed has been matted together, in order to moor the canoes thereon; after which operation they are compelled to swim back. So, also, when the canoe is wanted, the woman has to swim out for it and row back for her husband.

THE current number of the *Mittheilungen* of the Geographical Society of Vienna (Band xxix. No. 10) has a large map of the route from Ango-Ango to Leopoldville, made by Herr Baumann, of the Austrian Congo Expedition, with accompanying remarks, and a comparison with other recent maps of the same part of the river. There is an interesting note by Herr Baumann on the numerical systems of the Why or Wai Negroes and of the Mandingoes. The former, although they have a writing of their own—the Mandingoes use Arab letters—have no expression in their language for 100, and use the English, while the Mandingoes, Bantus, and other tribes can count with ease up to 1000. Herr Baumann also writes on the region around Stanley Falls,

and its inhabitants. The two remaining papers are mainly geological, one being on the geography of Persia, by Dr. Tietze, the other the conclusion of Dr. Diener's paper on the hypsometry of Central Syria.

EXPERIMENTAL SCIENCE IN SCHOOLS AND UNIVERSITIES

PROF. G. F. FITZGERALD, as Vice-President of the Dublin University Experimental Science Association, delivered an address at the opening meeting, held on November 23 in the Museum Buildings of Trinity College, under the presidency of the Rev. the Provost, on "Experimental Science in Schools and Universities."

Prof. Fitzgerald, at the outset of his address, dealt with the history of Universities, and showed how they gave such preponderance to book as against experimental knowledge. That had led, the Professor continued, to a dual system of education—the professional and the commercial. That gap between the classes was much to be lamented, and necessitated, from a political point of view, the desirability of having all classes educated in the same institutions. The commercial classes would not, however, enter the Universities at present, because they required to be taught useful subjects, and they would not learn the Latin and Greek now required in our Universities. From the political side of the question, he thought, they had got these results—that they must be content to have useful subjects taught in their schools and Universities if the schools and Universities were to be used by the large body in the country who were willing and able to pay for it. What they must have, if possible, was a single school and college system for all classes of the community who were able to spend the first twenty years or so of their life in education, and they ought to have a system that was complete, a training which gave both those who could not afford to go on the whole length up to twenty years, and which ought to be able to train those who desired to go on for the higher culture. Returning to the education side of the question, he insisted that almost the whole importance was as to how the subject was taught. He thought the use of the Latin Grammar had been reduced to a very good system, but he thought it was perfectly evident from the course that things were taking and the reasonableness of things, that they must teach their youth some knowledge of science. People who felt responsibility in the matter were being more and more convinced that it was not right for them to allow their children to grow up ignorant of the laws of the world in which they live. Others made answer to that that they left those laws of the world to the doctors. But how were they to know under what circumstances it was well to consult a specialist? It was very necessary for us to have a knowledge when we required to consult a doctor. Hundreds of people were killed by ignorance of the fact that dirt was the cause of disease. That was a very elementary subject. Nevertheless, people were dying every day from ignorance of that very fact; and, unless they were taught to believe in the fact that there were laws of Nature, they would not believe that dirt was the cause of disease, because they saw some people living in dirt and yet not the victims of disease. He thought that time for teaching science must be found for these two reasons—it was necessary that our youth should learn the laws of the world in which they live, and that they also should learn how to discover those laws. Unless our people were taught the laws under which plants and animals were best grown, the people of other countries would rival them in the manufacture of butter and beef, and the result would be that our people must starve. Another advantage of such training was to prevent superstition such as that of the people of Spain, who preferred the use of charms as a safeguard against cholera to the cleansing of their wells. All the classes of the country required this training—they would die without it, so they must have it.

Having shown that the cultivation of Latin and Greek was originally with the view of acquiring the information contained in the ancient books in those languages, the Professor combated the five reasons formulated by the German professoriate as to why they thought that the cultivation of Latin and Greek was so important, observing, with regard to the fourth reason—that these languages were the best varied exercise in thinking—that if the connection between words and ideas was a thing that must be taught in every system of education, his impression was that that would be a great deal better

attained by describing accurately and thinking out the consequences of physical experiment. In choosing the sciences that they should teach, there were three conditions that should be fulfilled. First of all, the sciences chosen ought to be within the grasp of children, because it was highly important that the science begun with childhood should be continued on in the University days; secondly, it ought not to require any expensive apparatus, because schools and people who trained children could not be expected to buy elaborate apparatus, and children could not be expected to work with them satisfactorily; and, thirdly, he thought the sciences should be chosen so as to be concerned with a large number of the laws of the world in which we live. There were two large branches of science which included nearly all the laws of the world, namely, the physical and the biological; and, therefore, he thought it would be desirable to choose two sciences—one on the physical and one on the biological side, so that children might learn something about the laws of living things, and something about the laws of physical things. He therefore suggested chemistry and botany, and he thought the whole weight of their efforts should be devoted to trying to get the children in schools to learn the elements of chemistry and the elements of botany, for there were no other two sciences the elements of which were almost similar, and at the same time there were no other two sciences that led up to a greater number of the laws of life, nor that gave a wider and more extended view of the laws of the world in which we live. The objections to the present system of teaching a knowledge of experimental science was that it almost entirely concentrated the person's attention upon phenomena instead of upon reasoning. Therefore, in choosing their system of teaching, all their weight ought to be thrown into making sure that their plan had the effect of making the child learn to think a good deal. Another thing they had to consider was the enormous time that children were made to remain in school without being engaged in anything except mischief. He thought a child should not spend more than four hours a day at literary work. Well, that occupied but a small part of a child's day; and one of the great advantages of having experimental subjects introduced into school teaching would be that they were subjects at which a child could work without experiencing very much fatigue. He could not help calling attention to the flagrant abuse of the teaching of experimental science in Irish schools. Experimental science in Irish schools was very nearly the same as snakes in Iceland. Having pointed out the fallacy of an examination—as exemplified in the Intermediate Education system—that was satisfied with a reading of the musical signs unwedded to a knowledge of the sounds they represented, the Professor said it would be an enormous advantage if the Intermediate Commissioners could be induced to keep up a peripatetic system of periodical examinations that would insist upon practical knowledge. That, however, should not interfere with the giving of papers also. After observing that it was at the present time impossible to carry out a proper examination in laboratory work, and stating that he considered it would be very desirable that the actual work in the laboratory and analyses in practical subjects should count towards the University prizes, Mr. Fitzgerald said he considered that the present system of analysis was not very satisfactory, and he urged the introduction of a system that would teach chemistry practically. Though that might be harder to teach than Latin and Greek, it would not be so if they had a system worked out and teachers to promote it, and it would have the inestimable advantage that, in addition to training the child to think—which he thought it would do equally well with Latin and Greek—it would teach him the laws of things, and how to see and learn the laws of things. It would also teach the child to use language to express real ideas, and not merely phrases. They would also learn a good deal more of the laws of language from a modern language that they learned with the grain than they would by learning an ancient language against the grain. He thought that literature and history were co-ordinate with science, and they certainly ought to be a large part of education. Literature and history were grievously neglected in the present day—practically they had no place, and that was substantially because Latin and Greek were supposed to be a literary education. One of the reasons was that those subjects were hard to examine in, but there was an easy way out of that difficulty in Universities. They need not examine, but they could require attendance at lectures—attendance on good lecturers; and the student would pick up more

ture and would be obtaining a better literary education from being a good lecturer and being inspired by his enthusiasm as he would get by learning off one of Shakespeare's plays, and answering it at an examination. Those two aspects of education, the literary and scientific, were often put in opposition, as was the freedom of the individual and the power of the State control the individual were very often set up in opposition to each other; but he did not think any one would believe that in opposition really arose, for the freest States were those in which the power of the State was the strongest. In conclusion, I would say that we must equip our youth for the battle of life physically and ethically. The present is a great crisis in Irish education. There is danger of science schools starting, and all the evils of dual education. There are a large body who like Latin and Greek, because they exclude literature and history. These are to be fought tooth and nail. There are those who would sacrifice the rising generation on an altar of so-called literature to starve and die, with their only comfort that they can describe their agony in well-expressed phrases. There are those who would grind all soul out of mankind in a mill of manual labour, constructed on scientific principles. All those are to be guarded against. We must have literature and history. We must have knowledge of the laws of the world in which we have to work. We can have both if we will but work out a reasonable system of education, instead of pretending that the lop-sided system that occupies our schools and Universities is a well-developed, symmetrical giant.

ABORIGINAL ART IN CALIFORNIA AND QUEEN CHARLOTTE'S ISLAND

In the fourth volume, recently issued, of the Proceedings of the Davenport Academy of Natural Sciences there is a valuable article by Dr. W. J. Hoffman on "Aboriginal Art in California and Queen Charlotte's Island." In the summer of 1884 Dr. Hoffman visited the Pacific coast for the purpose of continuing his researches on primitive art, and he was fortunate enough to find a number of localities in which there are painted and "etched" records, of considerable interest, made by Indians belonging to tribes now unknown. These records occur in groups. One group, the first described by Dr. Hoffman, is in the neighbourhood of Santa Barbara. The best preserved paintings in this series are in a cavity which measures about twenty feet wide and eight feet high. The rock consists of gray sandstone, but the ceiling and back portion of the cave have a yellowish appearance. The colours employed were red ochre, white, and bluish black. Some of the paintings Dr. Hoffman takes to be representations of gaudily-coloured blankets. In several instances a grotesque human figure is drawn over or in front of what seems to be a blanket, as if the latter were intended as a body blanket or serape. In the Azusa cañon, about thirty miles north-east of Los Angeles, Dr. Hoffman examined a second series of painted records. Rudely sketched human figures are represented pointing in certain directions, and the intention evidently was that they should serve as guides to travelling parties. For instance, the left arm of a figure on a white granitic boulder points towards the north-east. The precipitous walls of the cañon make egress in that direction impossible, but two hundred yards further on the cañon makes a sharp turn towards the north-east, and in rounding the point of land to the right the traveller comes to another boulder, on which are numerous faint drawings of various kinds. This boulder is on the line of an old trail leading from the country of the Chemehuevi, on the north of the mountains, down to the valley settlements of San Gabriel and Los Angeles. A third series of records was found in the southern part of Owens Valley, California, between the White Mountains on the east and the Benton Range on the west. They are "etched," not painted. The most common characters in this group are circles, either plain, nucleated, bisected, concentric, or spectacle-shaped, by pairs or threes, with various forms of exterior ornamentation. This group resembles etchings in the Canary Islands so closely that the illustrations given by Dr. Hoffman serve for both localities. On one of his plates he represents a number of circles with ornamented interiors, from a simple bisection to the stellate and cruciform varieties. Similar circles bearing cross-lines occur at Grevinge, Zealand; and other forms resembling some at Owens Valley are found at lieve-na-Calliagh, Grange, and Dowth, in Ireland. The spectacle-shaped variety resembles the mysterious symbol on

some Scottish monuments which has given rise to so much vague speculation. The reversed Z, however, is wanting in the Californian examples. Of the various outlines of the human form presented by Mr. Wallace from Brazil, and referred to more recently by Prof. Richard Andree in "Ethnographische Parallelen und Vergleiche," a considerable number are almost identical with etchings in the Owens Valley series. Many of the characters in these three Californian groups are similar to, and some are indistinguishable from, those made by the Moki and other tribes of the Shoshonian linguistic stock. Further research on the same lines may, therefore, enable anthropologists to determine the former geographical area of the Shoshonian family, as has already been done in the case of the Algonkian tribes.

In the neighbourhood of Los Angeles Dr. Hoffman obtained a portion of an old Indian gravestone. On this slab there are incised characters which seem to represent a whale-hunt, and no doubt they were intended to denote the occupation of the person to whose memory the tablet was erected. Honour is done to the dead in a similar manner by the Innuits of Alaska and by the Ojibwa. Among the Innuits, the posts erected for men usually bear rude drawings of weapons and animals; those for women have representations of household utensils and implements. On Ojibwa gravestones, as Mr. Schoolcraft has noted, the totem of the deceased is drawn in an inverted position.

Dr. Hoffman offers some interesting remarks on the subject of tattooing. In former times, in the vicinity of Los Angeles, every chief caused the tattooed marks upon his face to be reproduced upon trees or poles which indicated the boundaries of his land; and as these marks were well known to neighbouring chiefs, they were a sufficient warning that trespassers would be punished. A custom akin to this prevails in Australia, where the tattooed designs upon the face of a native are often engraved upon the bark of trees near his grave. Among many of the tribes west of the Mississippi there are still numbers of persons who bear tattoo marks upon the chin, the cheeks, and even upon other parts of the body, but the marks seldom occur in any forms other than narrow lines, except among the Haida Indians of Queen Charlotte's Island, where the art of tattooing has reached a higher degree of development than on the mainland. The Haidas tattoo upon the back, breast, fore-arms, thighs, and the legs below the knees; and women submit to the operation as well as men. The characters are totemic, and represent either animate or mythologic beings. They are usually drawn in outline, with interior decorative lines, red being sometimes introduced to form what is supposed to be a pleasant contrast. The ceremonies at which the tattooing is done are held in the autumn, and extend over a period of several weeks. Among the figures generally adopted are the thunder-bird, raven, bear, skulpin, and squid. A former Factor of the Hudson's Bay Company told Dr. Hoffman that when he first went to the country occupied by the Haida Indians he saw no tattooing upon the bodies of the older members of the tribe; and he contends that they have learned the art from natives of some of the South Pacific Islands, which they occasionally visit as traders.

The Haidas display considerable skill as carvers in wood and slate. Totem posts are often placed before the council-houses, and more frequently before private dwellings. When the posts are the property of some individual, the personal totemic sign is carved at the top. Other animate and grotesque figures follow in rapid succession down to the base, so that unless one is familiar with the mythology and folk-lore of the tribe the subject would be utterly unintelligible. On one post to which Dr. Hoffman refers there are only seven pronounced carvings, but they relate to three distinct myths. On household vessels, the handles of wooden spoons, and other objects, the Haidas often carve the head of a human being in the act of eating a toad. Sometimes the toad is placed at a short distance below the mouth. The idea is that in the wooded country there is an evil spirit who has great power of committing evil by means of poison extracted from the toad. The Indians are not willing to acknowledge the common belief in this mystic being, even when they are aware that the inquirer is in possession of the main facts.

UNIVERSITY AND EDUCATIONAL INTELLIGENCE

OXFORD.—The long-expected reform of the examination system which makes it unnecessary for men reading mathematics and natural science to pass any examinations of a non-scientific

character after coming into residence has at last been accomplished. The arrangement, which comes into force with the beginning of this year, is that candidates for degrees in mathematics and natural science take up responsions (or some equivalent examination at school) like other people, but by passing in one extra subject they are excused the second classical examination, in preparing for which they used to waste a good part of their first year of residence. The extra subjects from which candidates may choose include Greek, Latin, French, and German authors, Bacon's "Novum Organum," and the elements of logic. This alteration will be an undoubted benefit to science men, for, as the new examination involves no preliminary residence and occurs four times a year, they can proceed at once to take up the subject which they have chosen for their final schools.

The following courses of lectures and practical classes are announced for this term:—

Prof. Pritchard is to lecture at the Observatory on "Planetary Theory" and on "Astronomical Instruments and Methods," and offers practical instruction. Prof. Bartholomew Price lectures at the Museum on "Optics."

At the Clarendon Laboratory Prof. Clifton continues his course on "Electricity," and Mr. Walker lectures on "Double Refraction treated Mathematically." The practical work remains in the hands of the Professor, Mr. Walker, and Mr. Selby. Sir John Conroy, who has undertaken Mr. H. B. Dixon's work at Balliol and Trinity, lectures on "Elementary Electricity."

In the Chemical Department Prof. Olling will lecture on the "Benzoic Compounds"; Mr. Fischer and Mr. Watts continue their systematic courses on "Inorganic" and "Organic Chemistry" respectively. Mr. C. I. Baker and Mr. Marsh assist in the laboratory teaching. In Mr. Vernon Harcourt's laboratory at Christ Church and in the Balliol Laboratory the usual work is to be carried on.

The arrangements in the department of Morphology have been somewhat disturbed by the appointment of Mr. Baldwin Spencer to the Biology Professorship at Melbourne. Prof. Moseley is to lecture on the "Comparative Anatomy of the Vertebrata," and is to have Mr. G. C. Bourne as Assistant Lecturer and Demonstrator. Mr. Burchy Thompson lectures on the "Osteology and Distribution of the Ichthyopsida."

In the new Physiological Laboratory, Prof. Baden Santerson lectures on the "Physiology of the Nervous System," Mr. Dacey on "Histology," and Mr. Buckmaster gives an elementary course of Physiology for the newly-organised preliminary examination. Practical instruction is given in Physiology by Mr. Gatch, in Histology by Mr. Dacey, and in Physiological Chemistry by Mr. Haldane.

Quite a number of men are beginning to read for the new Medical School. The dissecting-room is under the charge of Mr. Arthur Thomson, who lectures on the "Digestive System."

Prof. Prestwich is to lecture chiefly on "Tertiary and Quaternary Geology," including the Glacial period and questions relating to the antiquity of man. Prof. Westwood lectures on the "Arthropoda."

At the Botanic Garden, Prof. Bayley Balfour lectures on "Vegetable Morphology and Physiology," and has both elementary and advanced instruction in practical Botany.

The Pitt-Rivers Anthropological Collection is now so far arranged that the formal opening will probably take place this term. All the cases on the ground floor of the new building have been arranged by Mr. Balfour. Dr. Tylor is to lecture on the "Development of Arts" as illustrated by the collection.

Next week the annual examination for a Radcliffe Travelling Fellowship begins.

SCIENTIFIC SERIALS

Bulletins de la Société d'Anthropologie de Paris, tome 6ème, 3ème fascic. 1886.—On the relations between the organs of touch and smell, by Dr. Fauvelle. In this paper the author considers the proposition advanced by M. Pozzi that the attitude of an animal is always in accord with the exercise of its predominant organ of sense. On this assumption the biped station would be the consequence of the predominance of vision over smell, and the attitude of quadrupeds the result of the relatively higher development of their sense of smell. In refutation of this view the writer argues that the relations between the organs of sight and smell in bipeds and quadrupeds are the result, rather than the cause, of their different stations, while he shows that wherever in the animal series the organs of sight would seem to

have lost their importance in proportion to the development of the sense of smell the latter is aided by delicate organs of touch situated on those parts of the body which form its anterior side when moving forward. Thus in the vertebrates all the organs of the senses are situated at the cephalic extremity of the body.—On a woman with a tail. The case, reported by M. Melikoff, was observed by Dr. Eliséeff, of St. Petersburg, author of an interesting work on men with tails. According to the statement of the woman, who suffered great pain from her caudal appendage, a similar abnormality had been observed in several female members of her family, in all of whom it had appeared between the ages of 12 and 17 years. Dr. Eliséeff refers this formation to embryogenic causes, such as an arrest of development in the fetus, and observes that such cases are more frequent in males than in females, the latter, according to him, presenting a much more advanced corporeal development than men.—A case of double uterus, by Dr. Landowski.—On short-tailed dogs, by M. Duval.—Observations on the crania of several insane subjects, by M. Manouvrier.—On the weight of Gambetta's brain, by M. Duval. This paper, and the discussion to which it gave rise, are especially interesting from the new light which they throw on the assumed relations between the large volume of the brain and intellectual capacity, the weight of Gambetta's being only 1160 grammes, or, according to M. Duval, 1246 after making all possible allowance for accidental diminution by faulty methods of preparation, while the mean for persons not gifted with more than ordinary intelligence is 1360 grammes.—On a new variation of the ossa wormiana, by M. Manouvrier.—A case of pilosity in a young Laotian girl, by Dr. Fauvelle.—On acclimatisation in reference to French colonisation, by Dr. Fauvelle.—On the anthropological characteristics of the Indo-Chinese peoples, by Dr. Maurel.—On the origin of the bronze and tin of prehistoric times, by Mme. Clémence Royer. The writer believes that Europe supplied the sources whence bronze implements were fabricated by early man, while M. Mortillet considers that both the material and the production of the weapons, ornaments, and other objects of this kind which belong to prehistoric times must be referred to India and the Far East.—Enumeration of the megalithic remains of Nièvre, by Dr. Jacquinot. The number of such remains in the whole of France, as certified by official inquiry, amounts to 6310, of which thirty-five belong to Nièvre. Among these special interest attaches to the horizontal slabs of Saint Agnan, which Dr. Jacquinot considers to have been altars for human sacrifices.—Summary of the answers given by New Caledonians to the interrogatories of the Society of Sociology and Ethnography, by M. Moncelon. These answers supply interesting materials for the ethnographic study of these races, and show the importance of following a definite plan in pursuing such inquiries.—Anthropological observations of the Khmer tribes of Cambodia, by Dr. Maurel. The writer, who supplies numerous anthropometric measurements, believes that these peoples belong to the Mongolian group.

Rendiconti del Reale Istituto Lombardo, November 11, 1886.—Meteorological observations made at the Brera Observatory, Milan, during the months of August and September.

November 25.—Results of the experiments carried out at the experimental farm of the Royal Milanese School of Agriculture against the mildew of the grape-vine, by Prof. Gaetano Cantoni. Of the various methods of treatment here described, the preparation of a sulphate of copper dissolved in water in the proportion of three per thousand is shown to be the most efficacious. The analysis of the wines obtained from crops so treated shows that they usually contain a scarcely appreciable quantity of the copper.

Bulletin de l'Académie des Sciences de St. Petersburg, tome xxi. No. 2.—Report on a memoir by M. Harzer on a special case of the problem of the three bodies, by O. Backlund. It is considered a most valuable work, being the first attempt to apply the method of Prof. Gylden.—New transcription of the Castrén's Koibal dictionary and Koibal poetry, made by M. Katanoff (who is himself of Sagai origin), from the Abakan, with a preface by W. Radloff.—Photometric researches on the diffusion of light, by O. Chwolson, being numerical data of new experiments mathematically treated.—Hydrological researches, xlv. to xlvii., by C. Schmidt.—Chemical analyses of water from lakes in North-west Mongolia and in North Tibet.—On a differential equation, by B. Ichmenetzky.

SOCIETIES AND ACADEMIES

LONDON

Royal Society, November 25, 1886.—"On the Dynamical Theory of the Tides of Long Period." By G. H. Darwin, L.D., F.R.S., Fellow of Trinity College, and Plumian Professor of the University of Cambridge.

Laplace sought to show that, as regards the oscillations of long period, called by him "of the first species," friction would suffice to make the ocean assume at each instant its form of equilibrium. His conclusion is no doubt true, but the question remains as to what amount of friction is to be regarded as sufficient to produce the result, and whether oceanic tidal friction can be great enough to have the effect which he supposes it to have.

In oscillations of the class under consideration, the water moves for half a period north, and then for half a period south. Now in systems where the resistances are proportional to velocity, it is usual to specify the resistance by a modulus of decay, namely, that period in which a velocity is reduced by friction to $1 \div 2.783$ of its initial value; and the friction contemplated by Laplace is such that the modulus of decay is about compared with the semi-period of oscillation.

The quickest of the tides of long period is the fortnightly tide, hence, for the applicability of Laplace's conclusion, the modulus of decay must be short compared with a week. Now it seems practically certain that the friction of the ocean bed would not much affect the velocity of a slow ocean current in a day or two. Hence we cannot accept Laplace's hypothesis as to the effect of friction.

This paper then gives a solution of the equation of motion when friction is entirely neglected. The method is indicated in a footnote to a paper by Sir William Thomson (*Philosophical Magazine*, 1875, vol. 50, p. 280), but has never been worked out before.

It appears in the result that with an ocean 1200 fathoms deep, covering the whole globe, the fortnightly tide has about $\frac{1}{7}$ th of its equilibrium value at the pole, and nearly a half at the equator. If the ocean be four times as deep we get analogous results, and it appears that with such oceans as we have to deal with the tide of long period is certainly less than half its equilibrium result.

In Thomson and Tait's "Natural Philosophy" (edition of 1883) a comparison is made of the observed tides of long period with the equilibrium theory.

This investigation was undertaken in the belief of the correctness of Laplace's view as to the tides of long period, and as intended to evaluate the effective rigidity of the earth's mass.

The present result shows that it is not possible to attain any estimate of the earth's rigidity in this way, but as the tides of long period are distinctly sensible, we may accept the investigation in the "Natural Philosophy" as generally confirmatory of Thomson's view as to the great effective rigidity of the whole earth's mass.

There is one tide, however, of long period of which Laplace's argument from friction must hold true. In consequence of the regression of the nodes of the moon's orbit there is a minute tide with a period of nearly nineteen years, and in this case friction must be far more important than inertia. Unfortunately this tide is very minute, and as is shown in a Report for 1886 to the British Association on the tides, it is entirely masked by oscillations of sea-level produced by meteorological or other causes.

Thus it does not seem likely that it will ever be possible to evaluate the effective rigidity of the earth's mass by means of tidal observations.

December 9.—"Note on a New Form of Direct-Vision Spectroscope." By G. D. Liveing, M.A., F.R.S., Professor of Chemistry, and J. Dewar, M.A., F.R.S., University of Cambridge.

December 16, 1886.—"Preliminary Account of the Observations of the Eclipse of the Sun at Grenada in August 1886." by Captain Darwin, R.E. Communicated by Lord Rayleigh, F.R.S.

The instruments allotted to me consisted of the coronagraph and the prismatic camera; the two instruments being mounted on the same equatorial stand.

The photograph obtained with the prismatic camera shows

several images of the prominences, and it therefore gives every promise of yielding good results when measured and examined.

The five- and ten-second photographs of the corona show signs of a slight vibration, but they will be useful for the inner part of the corona. As my main object was to obtain instantaneous photographs, these long-exposure plates had to be obtained by working the automatic shutter by hand; it was this probably that caused the vibration.

The instantaneous photographs of the corona when developed were complete blanks, proving that the exposure was too short. It should, however, be observed that this does not prove that the light of the corona was insufficient to cause an appreciable effect on the plate if combined with other light. More light energy is necessary to start photographic action than is required to produce a visible difference of shade when once the action is started.

Many of the photographs taken during partial eclipse show what may be described as a false corona, that is, an increase of density near the sun and between the cusps, or *in front* of the moon. In none of them can the moon be seen eclipsing the corona.

The results, therefore, are adverse to the possibility of obtaining photographs of the corona in sunlight; it is, however, I consider, by no means proved that the method is impossible. But at present I am inclined to consider that the result tends to show that a practical method of obtaining photographic records of the corona during sunlight is not likely to be obtained. The trial was not conclusive because the conditions were very unfavourable. In order to reduce the air-glare to a minimum, so that the light of the corona shall not be overpowered, the following points must be observed:—

- (1) The air should be clear and dry.
- (2) The sun should be near the zenith.
- (3) The station should be at a considerable elevation above the sea.
- (4) The corona, if it does vary in intensity, should be at its maximum brightness.

Now every one of these conditions was unfavourable. The air was saturated with moisture, the sky was of a hazy blue, the sun was low, the station was near the sea-level, and the corona, according to the general impression, was not so bright as on other occasions.

I hope, however, to deal more fully with these considerations on another occasion.

Mathematical Society, January 13.—Sir J. Cockle, F.R.S., President, in the chair.—Prof. G. B. Mathews was elected a Member.—The following communications were made:—Conjugate "Tucker" circles, by K. Tucker.—On the incorrectness of the rules for contracting the processes of finding the square and cube roots of a number, by Prof. M. J. M. Hill.—On the complex angle, by J. J. Walker, F.R.S.—Shorter communications were also made by Messrs. Heppel, Macmahon, and S. Roberts, F.R.S., in the discussion of which several members took part.

Victoria Institute, Jan. 3.—Dr. Wright read a paper describing the Hittite monuments which he had examined in the East, and giving an account of the present position of the question as to the age and extent of the country of the Hittites. Many afterwards joined in the discussion. Thirty members and associates were elected, and it was announced that 100 had joined during the past year, making 1200 members the Institute's strength.

EDINBURGH

Mathematical Society, January 14.—Mr. W. J. Macdonald, Vice-President, in the chair.—Prof. Chrystal gave a paper on the generation of any curve as a roulette; and Mr. William Renton contributed some mnemonics for plane and spherical trigonometry.

PARIS

Academy of Sciences, January 10.—M. Gosselin in the chair.—Note on the works of the late M. Oppolzer, Corresponding Member of the Section for Astronomy, by M. Tisserand. In this obituary notice reference is made more especially to the eminent astronomer's "Traité des Orbites," his determination of the orbits of the planets and many comets, and his theory of the movement of the moon.—On various phenomena presented by the artesian wells recently sunk in Algeria, by M. de Lesseps. The results are described of unusually successful operations undertaken in 1885 and last year in the region of the

minute of pure water at a temperature of 25° C., has already developed a considerable lake 10 metres deep, by means of which from 500 to 600 hectares of waste land have been reclaimed. Similar results elsewhere give hope that large tracts now uninhabited, but which supported a numerous population in the time of the Romans, will soon be again brought under cultivation.—On the theory of algebraic forms with p variables, by M. R. Perrin.—On the action of the chloride of carbon on the anhydrous oxides, by M. Eug. Demarçay. Schützenberger having shown that the tetrachloride of carbon reacts readily on the sulphuric anhydride, forming phosphene and chloride of pyrosulphuryl, the author here describes some experiments he has carried out for the purpose of ascertaining whether the same substance reacts on the oxides, and whether this reaction might not be utilised in the laboratory for facilitating the preparation of the anhydrous chlorides.—On erythrite, by M. Albert Colson. This substance should yield successively by oxidation a monobasic and a dibasic acid, the latter being tartaric acid, according to Henninger's formula. But no monobasic acid derived from erythrite has yet been described, nor has the transformation of this alcohol into tartaric acid ever given satisfactory results. The author here accordingly resumes the study of its oxidation, testing by the thermo-chemical process the formulas hitherto accepted for erythrite and tartaric acid. He also treats erythrite with the perbromide of phosphorus, obtaining a bromhydrine, $C_4H_8Br_2$, fusible at 112° C., and identical with the tetrabromide of crotonylene, described by Henninger.—On the glycerinate of potassa, by M. de Forcrand. Having already determined the heat of formation of the glycerinate of soda, and of its ethylic combination, and the conditions under which these compounds have their origin, the author here subjects the glycerinate of potassa to a similar process with analogous results.—On the substances derived from erythrene, by MM. E. Grimaux and Ch. Cloez. The object of the experiments here described is to ascertain whether erythrene and the carburet of gas oils are really identical, as supposed by Henninger. The result so far shows that the erythrene derived from the oils of compressed gas unites readily with hypochlorous acid, the product of the reaction being soluble in ether, alcohol, and water.—On the artificial production of zincite and willemite, by M. Alex. Gorgeu. The methods by which the author reproduces zincite are based on the decomposition of several salts of zinc by heat alone, or aided by the vapour of water. It is merely an application of the process by which M. Debray has obtained crystals of glucine, magnesia, &c. Willemite, $SiO_2 \cdot 2ZnO$, he produces by a method based on the action of silica on a mixture of alkaline sulphate and sulphate of zinc.—Observations on fishes inhabiting very deep waters (second communication), by M. Léon Vaillant. The really characteristic types of this class of deep-sea fauna are referred to the sub-order of the Anacanthini, which yields a considerable number of species, living at great depths. There is almost a total absence of Pleuronectes, the solitary exception being *P. megastoma*, Donov., fished up from a depth of 560 metres. A striking feature of this ichthyological fauna is its great uniformity, the same genera and even closely-allied species constantly reappearing and being evidently diffused over the widest ranges.—Researches on the mechanism of respiration in the Myriapods, by M. J. Chalande. Most zoologists suppose that the breathing process is the same in the Myriapods as in insects; but the author's researches show conclusively that this hypothesis is absolutely erroneous. In them respiration is effected by the rhythmical movements of the dorsal vessel, the air also penetrating by diffusion to the most delicate tracheæ.—On the age of the Bauxite formation in the south-east of France, by M. L. Collot. This formation, which in the Ariège district occurs between the Coralline and Urgonian deposits, is referred to the successive geological epochs between the Lower Lias and the Urgonian.—On the partial results of the first two experiments made to determine the direction of the North Atlantic currents, by Prince Albert of Monaco. Of the 169 floats cast overboard 300 miles north-west of the Azores in 1885, fourteen have been recovered, showing a general south-easterly direction and a mean velocity of 3.83 miles per twenty-four hours. Of the 510 floated in 1886 much nearer to the French coast, nine have reappeared, showing nearly the same direction, with velocities of from 5.80 to 6.45 miles.—Coincidence of certain solar phenomena with the perturbations of terrestrial magnetism, by M. E. Marchand. A comparative study of the solar observations made at the Lyons Observatory in 1885-86 with the curves of the

tion between the terrestrial magnetic disturbances and the placements of certain solar elements accompanying the spots and the faculæ.—On the actual value of the magnetic elements at Parc Saint-Maur Observatory, by M. Th. Moureaux.—Note the recent minimum of the solar spots, by M. A. Riccò. The minimum, which occurred between October and December, 1886, was specially remarkable for its intensity, no spots or pores being at all visible twice for eleven days and once for eight days during that period.—Remarks on the geological chart of Lake Baikal and the surrounding district, by M. Venukoff. A careful study of this map, drawn to a scale of 1:420,000, shows that the Baikal basin is not a *crevasse* in the Jurassic beds, as had been supposed, nor a subsidence due to plutonic or volcanic causes, but that its formation dates from pre-Silurian times and is still progress.

BOOKS AND PAMPHLETS RECEIVED

Practical Zoology: Marshall and Hurst (Smith, Elder).—The Gann vol. i. (Bowers, Walworth).—Massachusetts Institute of Technology Twenty-second Annual Catalogue of Officers and Students, and President's Report (Boston).—Folk-Lore and Provincial Names of British Birds: Rev. C. Swainson (Stock).—Flora of Leicestershire (Williams: Norgate).—Journal of the Franklin Institute, January.—Transactions of the Yorkshire Naturalists' Union, Parts 7, 8, 9 (Taylor, Leeds).—Precious Stones in Nature, Art, and Literature: S. M. Burnham (Trübner).—Hes at Schools: Dr. C. Dukes (Cassell).—Deviation of the Compass in Iron Ships: W. H. Rosser (Imray).—Sonnets on Nature and Science: S. Jefferys (Unwin).—Logia of the Lord: Historical Jesus; Paul the Gnostic Opponent of Peter; Devil of Darkness: G. Massey.—Report of the Observatory Committee for the Year ending December 31, 1886 (Harrison).—Explication des Taches du Soleil: M. Delauney (Paris).—Elementary Ideas, Definitions, and Laws in Dynamics: E. H. Hall (Cambridge, Mass.).—Studien über das Molekularvolumen einiger Körper: G. Hagemann (Friedländer, Berlin).

CONTENTS

	PAGE
The Imperial Institute	2
The Blastoidea	2
Tea-Planting in Ceylon	2
Geometry	2
Acoustics	2
Our Book Shelf:—	
Phillips's "Old or New Chemistry"	2
Clifford's "Lectures and Essays"	2
Jeans's "Lives of the Electricians"	2
Letters to the Editor:—	
Normal School of Science and Royal School of Mines.	
—Colonel J. F. D. Donnelly, C.B.	2
The Cambridge Cholera Fungus.—Walter Gardiner	2
Snowstorm of January 7, 1887.—E. J. Lowe. (Illustrated)	2
Auroras.—Dr. M. A. Veeder	2
A Solar Halo.—J. J. Walker	2
The National Science Collections, II.	2
Transmission of Power by Compressed Air. (Illustrated)	2
The Classification of the Cæcilians	2
Notes	2
Our Astronomical Column:—	
New Variables in Cygnus	2
New Minor Planet	2
A New Method for the Determination of the Constant of Aberration	2
The Madras Observatory	2
Astronomical Phenomena for the Week 1887	
January 23-29	2
Geographical Notes	2
Experimental Science in Schools and Universities	
Aboriginal Art in California and Queen Charlotte's Island	2
University and Educational Intelligence	2
Scientific Serials	2
Societies and Academies	2

Societies the publications of the Royal Society are sent gratuitously; there is no difficulty in obtaining access either to the libraries or to the reading-rooms when the members are in London, for the reason that all necessary knowledge as to how these privileges are to be obtained is of course possessed by those at home, whereas the member of a colonial Society who finds himself in England is in a very different position. He may know nobody, he may not know even of the existence of the facilities afforded, and he may leave England without having been present at any meetings of the Society, and without the knowledge that almost anyone who chooses can attend them. We are glad then on these and on other grounds that the question has been raised, and we believe that great good may be accomplished by acting on Prof. Huxley's suggestion.

SUPERNORMAL PSYCHOLOGY

Phantasms of the Living. By Edmund Gurney, Frederic W. H. Myers, and Frank Podmore. (London: Trübner and Co., 1886.)

UNDER the title "Phantasms of the Living," three of the leading members of the Society for Psychical Research have presented to the world at large, in two bulky volumes running to upwards of 1400 pages, the evidence they have collected in support of the hypothesis of telegermy and telepathy, or the influence of one mind on another, near or at a distance, without the intervention of the ordinary channels of sense. The division of labour, for such we may truly term it, seems to have been as follows: Mr. F. W. H. Myers writes an introduction and a concluding chapter on "A Suggested Mode of Psychical Interaction"; Mr. Edmund Gurney is responsible for the compilation of the body of the work, the presentation and criticism of the evidence; while in the collection of evidence and examination of witnesses Mr. Podmore "has borne so large a share, that his name could not possibly have been omitted from the title-page."

It is a matter of peculiar difficulty to do justice, in the space that NATURE can place at my disposal, to a work of such portentous bulk, one written in such obvious good faith, one on which the authors have bestowed so much time, labour, and thought, and yet one presenting views which no one who has learnt to believe in the parallelism or identity of neuroses and psychoses can accept without abjuring his scientific and philosophic faith. I hold it to be the duty of a reviewer not merely to air his own opinions, but to give his readers a sketch of the contents of the volumes before him. But how can one sketch in two or three columns so vast a mass of evidence, the chief value of which is, we are told, its cumulative nature? And if the reviewer owes it to his readers to present some sort of outline of the picture his author presents, he none the less owes it to himself, his author, and his journal, to endeavour to estimate the value of the original thus roughly outlined. Difficult as the task is, it must be faced.

The evidential part of the work opens with a record of cases which form, it is held, an experimental basis for thought-transference. The following description is given

by the Rev. H. M. Creery of experiments with his own daughters:

"Each went out of the room in turn, while I and the others fixed on some object which the absent one was to name on returning to the room. We began by selecting the simplest objects in the room, then chose the names of towns, dates, cards out of a pack, &c. I have seen seventeen cards, chosen by myself, named right in succession, without a mistake."

In similar experiments the investigating committee acted as agents. This excluded, in their opinion, the possibility of trickery. Tabulating the results thus obtained, they submitted them to Mr. F. Y. Edgeworth who applied to them the calculus of probabilities, obtaining "a row of *thirty-four nines* following a decimal point," or practical certainty in favour of their being due either to collusion or to thought-transference.

Details are given of experiments on the transference of tastes under conditions which, in the opinion of the authors, precluded the possibility of collusion or deception. The following are a few successive results:—

Substances tasted	Answers given
Vinegar	A sharp and nasty taste.
Mustard	Mustard.
Sugar	I still taste the hot taste of the mustard.
Worcestershire sauce	Worcestershire sauce.
Port wine (quality not stated !)	Between eau-de-cologne and beer.
Bitter aloes	Horrible and bitter.

Instances of the localisation of pains are given. "The percipient being seated, blindfolded, and with her back to the rest of the party, all the other persons present inflicted on themselves the same pain in the same part of the body. Those who took part in the collective agency were three or more of the following: Mr. Malcolm Guthrie, Prof. Herdman, Dr. Hicks, Dr. Hyla Greve, Mr. R. C. Johnson, F.R.A.S., Mr. Birchall, Miss Raymond, and, on one occasion, another lady. The percipient throughout was Miss Reif. In ten out of twenty cases the percipient localised the pain with great precision; in seven, the localisation was nearly exact; in two, no local impression was perceived; and in one, the last, the answer was wholly wrong."

Facsimiles are given of pictures reproduced by thought-transference. In a continuous series of six—none of which can be said to have been complete failures—two were reproduced by the percipient with great fidelity; even the comparative failures are instructive from their partial success. The position of the agent, we are told rendered it absolutely impossible that she should obtain a glimpse of the original.

Such is some of the experimental evidence for thought-transference. Readers of NATURE will understand why this section of the authors' work, giving results obtained under conditions within control, is noticed at greater length than can be devoted to other branches of the evidence.

The next chapter deals with cases transitional between experimental thought-transference—in which both agent and percipient are voluntarily taking part with a definite idea of certain results in view—and spontaneous telepathy where neither has voluntarily or consciously formed an idea of any result whatever. These transitional cases are

those in which the agent acts consciously and voluntarily, but the percipient is not consciously or voluntarily a party to the experiment. Of these cases, a single example must suffice. Two fellow-students of naval engineering at Portsmouth had been in the habit of making experiments in mesmerism. One, ere long, acquired mesmeric control over the other, who was able to see, in the mesmeric trance, places in which he was interested, if he resolved to see them before he was hypnotised. One day he expressed a wish to see a young lady living in Wandsworth. He was hypnotised; and when he came round, he said he had seen her in the dining-room. A few days afterwards, the experiment was repeated. He saw, as he lay entranced, the young lady in a room with her little brother; she fell back in her chair in a sort of faint. A letter was subsequently received from the young lady, dated the morning following the last experiment, beginning: "Has anything happened to you?" and stating that "she could have declared she saw him looking at her" on two occasions, on the latter of which she was so frightened that she nearly fainted. "Luckily," she adds, "only my brother was there, or it would have attracted attention." Although there is some discrepancy as to the date of the first appearance, the second (January 18, 1886) is accordant.

After the enumeration of fifteen or sixteen transitional cases, Mr. Gurney devotes a chapter to a general criticism of the evidence (to which is added an appendix on witchcraft), and then gives a chapter of specimens of the various types of spontaneous telepathy. For these types and their various sub-classes, the reader must be referred to the work itself. I must here again content myself with quoting a single case (which is both "reciprocal" and "collective") from among the 700 or so that are given.

"On the evening of, I think, March 23, 1883," writes a Mrs. Bettany, of Dulwich, "I was seized with an unaccountable anxiety about a neighbour. I tried to shake off the feeling, but I could not; and after a sleepless night, in which I constantly thought of her as dying, I decided to send a servant to the house to ask if all were well." (This is confirmed by the servant.) "The answer I received was, 'Mrs. J. died last night.' Her daughter afterwards told me that the mother had startled her by saying, 'Mrs. Bettany knows I shall die.'"

Mrs. Bettany adds:—"My cook, to whom I had not mentioned my presentiment, remarked to me on the same morning: 'I have had such a horrible dream about Mrs. J., I think she must be going to die.' She distinctly remembers that some one (she does not know *who*, and I think never did) told her in her dream that Mrs. J. was dead." (This is also confirmed by the cook.)

Of somewhat analogous cases of phantasms, presentiments, or dreams occurring to one or more percipients at or shortly after the death of the agent, there is a surprising but wearisome abundance.

So much for the evidence. The authors are fully alive to its liability to error. But they note that their "somewhat persistent and probing method of inquiry has usually repelled the sentimental or crazy wonder-mongers who hang about the outskirts of such a subject as this; while it has met with cordial response from an unexpected number of persons who feel with reason that the very mystery which surrounds these incidents makes it

additionally important that they should be recounted with sobriety and care."

We turn now to the theory; and though Mr. Gurney tells us that the character of the present work is mainly evidential, there is no lack of theory scattered up and down throughout its multitudinous paragraphs. The authors, it need hardly be said, regard their hypothesis as strictly scientific. "We wish distinctly to say," writes Mr. Myers, "that so far from aiming at any paradoxical reversion of established scientific conclusions, we conceive ourselves to be working (however imperfectly) in the main track of scientific discovery."

We must, however, carefully separate the views of Mr. Myers from those of Mr. Gurney. Both of them, of course, insist on the reality of experimental thought-transference and of spontaneous telepathy—the radical difference between which is well brought out. In the one an object or sensation kept steadily before the mind of the agent or agents is transmitted as such to the mind of the percipient; in the other the case is different: not the death-swoon of the agent, but the image of the agent as dying is transmitted. And here it is that our authors begin to part company. Calling to mind the facts (or supposed facts) (1) that the dying man may have in intervals of consciousness a vivid mental picture of himself and his surroundings; (2) that most of us have in the background of consciousness a tolerably well-developed conception of our own proper selves; (3) that there is some experimental evidence of collective telepathic influence, so that the percipient may be jointly influenced by the dying man as principal agent, and by the bystanders at the death-bed as subsidiary agents—taking these, avowedly or implicitly, into consideration, Mr. Gurney does not feel forced to go beyond the theory of thought-transference. Not so Mr. Myers. He rises boldly into what looks uncommonly like spiritualism, and accepts clairvoyance, where the percipient "seems to visit scenes, or discern objects, without needing that those scenes or objects should form a part of the perception or memory of any known mind." "*Correspondently with clairvoyant perception*," he says (the italics are his own), "*there may be phantasmogenic efficacy*," which in plain English means that the percipient may visit in spirit scenes he has never visited in the flesh, and that his spirit may be visible as a phantasm to the human occupants of these scenes. And in support of his view he adduces such cases as that of the two students which I have summarised above.

On the question of the physical aspect of the psychical phenomena, again, our authors do not agree. Mr. Gurney holds that "mental facts are indissolubly linked with the very class of material facts that science can least penetrate—with the most complex sort of changes occurring in the most subtly-woven sort of matter—the molecular activities of brain-tissue." And though he subsequently says: "Not only, as with other delicate phenomena of life and thought, is the *subjective* side of the problem the only one that we can yet attempt to analyse: we do not even know where to look for the *objective* side:" he rather advocates the limitation of the question for the present to the psychical aspect, than dismisses the physical as a piece of unwarrantable materialism. But Mr. Myers goes further: "The psychical element, I

repeat, must henceforth almost inevitably be conceived as having relations which cannot be expressed in terms of matter." And again: "I claim at least that any presumption which science had established against the possibility of spiritual communion is now rebutted; and that the materialist must admit that it is no longer an unsupported dream, but a serious scientific possibility, that, if any intelligences do in fact exist other than those of living men, influences from those intelligences may be conveyed to our own mind."

And now, in conclusion, what shall we say of these ponderous tomes? Shall we lightly dismiss the whole subject as a "pack of nonsense"? I do not think that this would be a wise or a scientific procedure. Speaking for myself, I must confess that, in my opinion, Mr. Myers's views are not "on the main track" of the science of to-day, whatever relation they may hereafter be shown to bear to the science of the future. Speaking for myself again, I am ready to accept experimental thought-transference as a working hypothesis, that is to say, a guide to future research on the subject. It may be that any physical explanation we can at present offer is no nearer the truth than was the Ptolemaic hypothesis in astronomy, and yet such a working hypothesis may be valuable in the existing state of psychology. With regard to spontaneous telepathy, notwithstanding the large amount of evidence so carefully collected and criticised, notwithstanding that I have first-hand evidence more convincing (to me) than anything recorded in these volumes, I prefer to credit the whole to a suspense account. The physical difficulties are enormous. We have to conceive the action of brain on brain across a whole hemisphere. Not that this must be pressed too far. There is much that is provisionally accepted by science (much aëther, and atoms, and modes of molecular action) that I find it exceedingly hard to conceive. And perhaps the distant action of brain on brain is not harder for us to conceive than would be the transmission of luminiferous waves to beings in whom the visual sense was not as yet recognised, and who, hitherto only acquainted with vibrations transmitted by the air, were called upon to conceive that waves could be transmitted by the ether itself. It is difficult to see how almost unchecked throes of matter could pass through solid material. Still, though the mass of matter is considerable, and though the physical difficulties must not be pressed too far, I am not prepared fully to accept the doctrine of spontaneous telepathy. At the same time, I hold that the evidence adduced by earnest workers is not to be met by easy and ignorant ridicule. I do not think that science is best served by those who are ever ready to throw the cold water of impossibility on the light of new ideas struggling into existence.

I am, moreover, strongly of opinion that normal psychology has much to learn from experiments on supernormal and abnormal "subjects." Beneath the threshold of consciousness there is a vast amount of sub-conscious and unconscious mental action. Of the multitudinous simultaneous neuroses only the superficial film (so to speak) emerge into the light of consciousness as psychoses. The study from the psychological standpoint of the underlying hypopsychoses, as I have elsewhere suggested that they should be termed, is as important as it is difficult. If the

result of such work as Messrs. Gurney, Myers, and Podmore have entered upon aids in throwing light upon these hidden mysteries, which are none the less realities, of the human mind, their labour will, in my opinion, not have been in vain.

C. LLOYD MORGAN

ELEMENTARY RESULTS IN PURE MATHEMATICS

A Synopsis of Elementary Results in Pure Mathematics, &c. By G. S. Carr, M.A. Pp. xxxviii. + 936 + 20 folding Plates of Figures. (London: Francis Hodgson, 1886.)

IN our last notice of this work (vol. xxxi. p. 100) we gave an account of Sections X., XI., and XII. The complete volume contains two additional sections. The first of these treats of plane co-ordinate geometry, under which heading we have systems of co-ordinates, analytical conics in Cartesian and trilinear co-ordinates (we miss the m equations for the parabola and the corresponding equations for chords, &c.). In the latter division we have, amongst the particular conics considered, the triplicate-ratio and seven-point circles (or, as they are more usually styled, the Lemoine and Brocard circles). The account is carefully drawn up from original authorities, and will help to bring this latest development of the geometry of the circle and triangle more into notice. At present this and Dr. Casey's books are the only source readily accessible to students. We are promised another presentment of these circles shortly, but of this more anon. The concluding portion of this section is devoted to the theory of plane curves. Here we have, *inter alia*, inverse and pedal curves, roulettes, and the various forms of transcendental curves. Considerable space is taken up with linkages and link-works: here we have accounts of Kempe's five-bar linkage, the six-bar inversor, the eight-bar double inversor, the quadruplane, the isoklinostat, the planimeter, and the pantograph (this Mr. Carr generally calls pentograph—evidently he has not consulted the "English Cyclopædia"—and in one place only, pantograph). The concluding section is mainly taken up with solid co-ordinate geometry, the final articles being devoted to Guldin's rules, moments and products of inertia, perimeters, areas, volumes, &c. Here we have the theorems which go by the names of Fagnani, Lambert, and Griffiths (not Griffith, as the "Contents" and "Index" print the name; the text, § 6096, is right).

We have in our former notices sufficiently indicated our opinion of the utility of such a book as this if thoroughly trustworthy, and have suggested that a student should have this synopsis by his side when he is carefully going through his subject, that so he may be able to spot any slight inaccuracy in the text. We believe the book is singularly free from errors, but it would be absurd to suppose that there are not several which have escaped even the notice of the author, who has imposed upon himself numerous guards for the prevention of such slips. For it must be remembered that this is no hastily-prepared work: it has occupied much of the writer's time since 1866, when the *magnum opus* was commenced. The author is to be heartily congratulated on the successful

termination of labours which must have occupied most if not all of his leisure time from other more regular work.

But Mr. Carr has not confined his work to the limits of his previous title-pages: he has "supplemented" it "by an index to the papers on pure mathematics which are to be found in the principal Journals and Transactions of learned Societies, both English and foreign, of the present century." Such indices have, in these busy times, great value for students in all branches of knowledge, and this one is, we think, very accurate for a first edition. There are, however, some defects. On p. 720 occurs an historical note on the cycloid; no reference is made to the exhaustive treatise, on the cycloid and all forms of cycloidal curves, by Mr. Proctor (Longmans, 1878). In the like case of Cartesian ovals there is no account taken of Prof. Williamson's paper on these curves in *Hermathena* (No. iv. p. 509; subsequently given in the author's "Differential Calculus"). For the length of an arc of an oval expressed by elliptic functions, Mr. Carr (p. 731) cites a paper by Mr. S. Roberts, F.R.S., in the London Mathematical Society's Proceedings (vol. v. p. 6), but does not mention that Mr. Roberts (vol. vi. p. 200) subsequently found that he had been anticipated by Prof. Genocchi (1855, see "Il Cimento," Turin). The name of Desargues, rightly given p. 917, is twice printed Desarques on p. 858. On pp. 913 and 935 we have "polyzonal," "zonal," and "tetrazonal": the author of the paper in question has "m" in place of "n" throughout. "Nicomaque" (p. 853), "implexe" (p. 859), "pseudosfera" (p. 915), are easily traceable; "coplanation" and "complanation" are also to be traced to the titles of the original papers. Cases of wrong spelling occur in the names of Hesse (p. 890), Kronecker (p. 890), Plücker (p. 916), Rodrigues (p. 921), Lissajous (p. 900), and there are various forms of MacCullagh; but "Tetra-tops" (p. 931) eludes us. These are trifling matters, and in the text in such parts of XIII. and XIV. as we have read we have not observed any errata of consequence.

It would be a boon to students if Mr. Carr would issue this supplement in a separate form, and add to his extensive list of thirty-two periodicals references to the papers on pure mathematics which occur in the *Philosophical Magazine*, *Lady's and Gentleman's Diary*, the *Mathematician*, "Reprint from the *Educational Times*" (a limited selection here of general results and the occasional papers), and *Mathesis*. For instance, on the "15-girl" problem there is a good article in the *Diary*, on the "chess-men" in the *Philosophical Magazine*.

Mr. Carr will understand that our remarks are made in no captious spirit: we are very grateful for the trouble he has taken, and desire only that a second edition may be made even more valuable from its increased accuracy and stores of information than the present one is.

He is to be congratulated on the arrangement of his text, the several different kinds of types which have been put at his disposal by the printers, and the excellent diagrams. It only remains to express the wish that what the author has done for one side of mathematics he may be encouraged to do for the other, *i.e.* for applied mathematics.

COMMERCIAL ORGANIC ANALYSIS

Commercial Organic Analysis. By Alfred H. Allen, F.I.C., F.C.S., &c. Second Edition, Revised and Enlarged. Vol. II. Fixed Oils and Fats, Hydrocarbons, Phenols, &c. (London: J. and A. Churchill, 1886.)

THIS work has been so much enlarged and so thoroughly revised that it has become almost a new book, and certainly its value has been greatly enhanced to all analysts and others interested in the special points discussed. These copious additions have rendered it necessary to divide the present edition into three volumes, the first of which appeared some little while ago, whilst the third (on Aromatic Acids, Tannins, Colouring Matters, Cyanogen Compounds, Organic Bases, Albumenoids, &c.), is now in course of preparation, and is promised shortly. Of the sections treated in the present volume it may be said generally that the author has collected together and systematically digested almost all the available information extant scattered about in text-books and numerous papers read before scientific Societies, and that he has largely contributed personally to the mass of information by means of experimental and observational work carried out in his own laboratory at the cost of much time and labour. Moreover, he has sought and obtained the aid of several well-known chemists possessing special knowledge and skill in certain kinds of work, by whose assistance many of the more important articles have acquired an almost exhaustive character. As a result, the treatise has become a most valuable hand-book and book of reference with respect to the class of matter coming within its scope; and it may now be fairly said to be an essential item in the list of works requisite in the library of an analytical chemist.

Amongst the numerous special points of research to which the author has devoted much personal attention, a notable one is the examination of various of the physical properties of fatty and oily matters with a view to their discrimination and identification, and more especially the methods in use in the determination of their specific gravity. In order to avoid complications arising from differences in physical state—some being solid, others pasty, and others fluid at the ordinary temperature—he recommends, as previously proposed by Estcourt, that comparisons should always be made at the temperature of boiling water, the melted fat or fluid oil being placed in a test-tube heated in a water-bath (of such construction that no steam escapes in the vicinity of the operator), and the indications of a Westphal's hydrostatic balance noted when the plummet is immersed in the hot oil. The figures thus obtained on repetition of experiments show very little divergence; and characteristic values are thus obtainable for certain kinds of fats, *e.g.* butter-fat when genuine. Owing to the fact that the Westphal balance as sold is constructed to give specific gravity indications at the ordinary temperature (*i.e.* that the plummet is adjusted so as to lose a particular weight, conveniently 5 or 10 grammes, when immersed in water at, say, 15° C.), it is obvious that the numerical values obtained on immersion in hot material at close upon 100° C. represent neither the true densities at 100° of the substances (weights per cubic centimetre) nor the ratios between

these densities and that of water at 100°, *i.e.* their specific gravities at 100°. But for any particular instrument, the different values obtained with different fatty matters exhibit the same differences as those obtained with any other instrument; whilst the indications of any two instruments are obviously comparable, provided that the mode of graduation and the coefficient of expansion of the plummet are the same; which practically is the case if a glass plummet be always used, as recommended. In a recent communication to the *Analyst* (January 1887, p. 18), the author suggests that the term "*indicated plummet-gravity*" should be employed to represent the apparent values obtained at such and such a temperature by means of the plummet-balance; which is clearly preferable to the use of either of the terms "specific gravity" or "density" in such cases. It may be noticed in passing that the "*indicated plummet-gravities*" of fats and oils at 100° or thereabouts by no means necessarily follow the same order as the so-called specific gravities obtained at lower temperatures, not only on account of difference of physical state, but also through the different rates of expansion possessed by the various substances.

Another point on which the author has worked with results of some interest is the determination of the amount of glycerol yielded by fats and oils on saponification. He concludes that there is no experimental basis for the suggestion put forth some time ago by Wanklyn and Fox that *isoglycerides* are present in such substances, these bodies yielding on saponification propionic (or other homologous) acid and water, instead of glycerol. Such a view is opposed not only to the author's laboratory experience, but also to that of manufacturers, who frequently recover 7.5 to 8.0 parts of glycerol per 100 of fatty matter, instead of less than 5 as stated by Wanklyn and Fox. Making allowance therefore for deficient saponification and loss of glycerol by evaporation during recovery, the theoretical amount of glycerol obtainable is satisfactorily accounted for, instead of being largely in excess of that actually produced. It is noticeable that, whilst the author obtained results reasonably concordant with the permanganate process for the determination of the glycerol produced during saponification as compared with the other ordinary methods in many instances, this was not always the case, the former process sometimes yielding figures far in excess, indicating the presence of other substances besides glycerol capable of forming oxalic acid by treatment with permanganate. An extreme case was afforded by linseed oil dried up to elastic skin, which gave 4.9 per cent. of impure glycerol directly isolated, and 15.5 per cent. by the permanganate process.

The author considers that the usually received molecular weight of linoleic acid, generally represented as indicated by the formula $C_{18}H_{34}O_2$, is incorrect, as the mean equivalent of the acids obtainable from linseed oil on saponification has been found by him to be considerably higher than that thus indicated. The formula $C_{18}H_{32}O_2$ agrees better with his results, and moreover is not at all incompatible with the analytical data obtained by previous investigators. The analogous determination of the mean molecular weight of the acids produced on saponification (by means of alcoholic potash and phenolphthalein) of fatty, waxy, and oily matters, and of the

fatty and resinous acids contained in soaps, is justly regarded by the author as a valuable criterion in judging of the nature of such substances, especially when taken in conjunction with other data (*e.g.* in the case of butter-fat, the amount of volatile acids capable of being subsequently distilled off along with water, working under particularly constant conditions as recommended by Reichert; and the proportion between acids soluble and insoluble in water, &c.); and a large amount of experimental work has been done by him in connection with such valuations. He has also made an excellent digest of recent researches in connection with fats, oils, waxes, soaps, and analogous bodies. In connection with toilet-soaps, he regards the addition of sugar to produce transparency as "simply diluting the true soap-material as so much water would do, without communicating any compensating property of value." This is a very mild way of putting the case, the fact being that soaps containing sugar are liable to produce, in sensitive subjects, a great amount of irritation of the skin (in fact, a mild kind of "grocer's eczema," traceable to the same cause), even though free from causticity and otherwise unobjectionable; and numerous persons are, to the reviewer's knowledge, unable to use certain widely-advertised soaps, in consequence of the large admixture of sugar therein contained, although the composition would otherwise be quite uninjurious.

The sections devoted respectively to hydrocarbons and phenols are equally comprehensive, including descriptions necessarily in some cases somewhat brief, of the leading points in the petroleum, coal-tar, and shale-oil industries and of the technical examination of the various products obtained on fractional distillation and subsequent further treatment of these and allied raw materials, *e.g.* wood-tar and the commercial examination of turpentine and resin: essential oils, camphors, and various miscellaneous substances, such as cantharidin and cholesterin. In these, as in the previous section, the value of the various *præca* given of other observers' work is frequently further enhanced by the comparative experiments and examination made in connection with different analytical methods, &c. by the author himself. Bone tar, obtained as a by-product of the animal charcoal manufacture, is not described probably on account of the limited uses to which, hitherto it has been put; whilst, for similar reasons, but little said of blast-furnace and coke-oven tars.

C. R. ALDER WRIGHT

OUR BOOK SHELF

Practical Dynamo-Building for Amateurs. By FRED W. WALKER, M.E. (London: Iliffe and Son, 1886.)

WOULD that all books for amateur guidance were written with as full a knowledge of proper principles as this unassuming little work. We are not saying that the machine which the author recommends amateurs to construct is the equal of the commercial dynamos of the current date. His field magnet cores are of cast iron, and not the best form; his armature might be improved by getting greater cross-section of iron into it. But there is nothing wrongly done. All instructions about the essential details of proper insulation and testing of the work progress are accurate and full; and an appendix of alternative constructions of field-magnets supplies in some degree the deficiencies of the earlier text.

Hand-book of Zoology, with Examples from Canadian Species, Recent and Fossil. By Sir J. William Dawson, LL.D., F.R.S., &c. Third Edition, revised and enlarged. (Montreal: Dawson Brothers, 1886.)

IN this little work, the President of the British Association for the Advancement of Science has concentrated into some 300 pages a very fair account of the principal divisions of the animal kingdom. It is specially adapted for Canadian students, inasmuch as the examples of every group are selected, as far as possible, from species found within the limits of the Dominion. The fact of the volume having reached a third edition shows that Sir William Dawson's plan and method have been appreciated. That the arrangement adopted is altogether unexceptionable, and that all the most recent discoveries in zoological science are taken advantage of, we could not fairly say. For example, *Eozoon* is still treated of as if it were without doubt an organic structure; the unquestionable affinity of the larval Ascidian to the Vertebrate embryo is but faintly alluded to; and the much-talked-about *Peripatus*—one of the most singular types of Arthropodal life—seems to have been altogether omitted from the list. Yet there is, in the main, an absence of the serious errors which are too often found in such manuals. The volume is well illustrated and well printed, and will, we have no doubt, be of much service as a text-book in Canadian schools of science.

Theory of Magnetic Measurements. By Francis E. Nipher, A.M., Professor of Physics in Washington University, President of the St. Louis Academy of Science. (New York: D. Van Nostrand; London: Trübner and Co., 1886.)

DURING the last twenty years there has been considerable activity amongst observers on land and at sea in adding to our knowledge of the magnetism of the earth, and it is certainly desirable, if not necessary, that those busy workers, who are only acquainted with the practical use of the instruments employed, should know something of the theory of the magnetic measurements upon which they may be engaged.

To those conducting magnetic surveys under English auspices, the article on Terrestrial Magnetism in the "Admiralty Manual of Scientific Inquiry" has proved a valuable aid in showing both what was required and the practical means of obtaining observations on land and sea, with the methods of calculating the results. The theory of the subject, however, is beyond the intended scope of the Manual.

The magnetic survey of the United States has, during the period under consideration, been continuously carried on under the Government and private enterprise, and Prof. Nipher has been one of the diligent workers, as shown by his survey of Missouri, published in *NATURE*, (vol. xxiii. p. 583). In the book before us he combines some excellent practical information for those undertaking the observation of the three magnetic elements on land, with the theory of the several magnetic measurements thus made.

A large portion of the book is necessarily occupied by the theory of the horizontal force magnetometer and its several parts. Here the reader will find some differences from the English notation. For instance, H is substituted for X when denoting the horizontal force, and I for K , as the moment of inertia of the deflecting magnet. A more important departure from the usual method of calculation will be noticed in the omission of the coefficient of induction μ , which has been so entirely rejected as not even to be discussed. The retention of this coefficient has already been challenged elsewhere, but the general support of European practice seems to forbid any change until its place in our formulæ has been proved unnecessary. In the concluding pages there is an article on the systems of

units adopted in magnetic measurements, and plates of the unifilar magnetometer and dip-circle generally used.

The appendix is devoted to a discussion of the method of least squares in the reduction of observations, an article on graphic methods, with the aid of which so much may be done to shorten the labour of computation, and some tables giving the times of the elongation of Polaris with its corresponding azimuth for the years 1886-95, from which the true meridian may be readily deduced for declination-observations. These tables will probably be found convenient in latitudes between the northern tropic and the Arctic circle.

The large domain of magnetic observations at sea is not touched upon, but intending observers on land should be pleased to possess a book of this kind, which might be included in their travelling equipment without fear of adding much to the weights to be carried.

The Coming Deluge of Russian Petroleum. By C. Marvin. (London: R. Anderson and Co.)

THIS pamphlet does not pretend to add to our limited knowledge of the origin of petroleum or of its connection with the Tertiary deposits and volcanic activity of the Caucasus. It is in reality an appeal to English enterprise to direct its attention to at least the carrying trade of a district so rapidly growing in industrial importance. The enormous figures given (*e.g.* more than a million gallons a day from a single well) are enough, however, to stimulate scientific as well as Stock-Exchange inquiries, and the development of communications between Baku and the West is sure to be, sooner or later, fruitful in geological results. G. C.

LETTERS TO THE EDITOR

[The Editor does not hold himself responsible for opinions expressed by his correspondents. Neither can he undertake to return, or to correspond with the writers of, rejected manuscripts. No notice is taken of anonymous communications. [The Editor urgently requests correspondents to keep their letters as short as possible. The pressure on his page is so great that it is impossible otherwise to insure the appearance even of communications containing interesting and novel facts.]

The Cambridge Cholera Fungus

I HAVE read with great surprise Mr. Gardiner's letter in your issue of January 20 (p. 271). We are there told that on reconsideration Mr. Gardiner has now come to the conclusion that the organism which he saw in Prof. Roy's preparations of the intestinal mucous membrane—which Prof. Roy took to be the more usual and typical form, and which Mr. Gardiner then thought to belong to the Chitridiaceæ—is probably the particular phase in the life-history of Bacterium known as an involution form, *i.e.* "a thin and somewhat moniliform filament which at one end exhibited a distinct nodular swelling." If Mr. Gardiner has studied the filaments of a growth of mould in animal tissues, he must have come across numbers of such forms. But granting for the sake of argument that what Mr. Gardiner saw in Prof. Roy's specimens bears a resemblance to and is in reality an involution form of Bacterium, how about the branched threads figured in the Report by Messrs. Roy, Brown, and Sherrington in No. 247 of the Proceedings of the Royal Society, on p. 179?

Each of these two figures introduced here, no doubt as typical representations of the organisms in the mucous membrane, shows unmistakably BRANCHED mycelial threads of a true fungus. If what Mr. Gardiner has seen in Prof. Roy's preparations is an involution form of some Bacterium, then the branched threads figured in Messrs. Roy, Brown, and Sherrington's Report are something else, unless somebody started the novel and extraordinary view that a Bacterium possesses branched mycelial threads like a true fungus.

I should be glad to hear Mr. Gardiner's opinion as to these branched mycelial threads figured on p. 179 of the Proceedings of the Royal Society, No. 247, in the Report by Messrs. Roy, Brown, and Sherrington. E. KLEIN

The Coal-Dust Theory

THOSE readers of NATURE who have followed the various phases of the coal-dust question will be interested to know that the following resolution was carried at the Conference of Miners, which concluded its sittings in Birmingham yesterday morning:—

“This Conference, believing that recent explosions have demonstrated that coal-dust is sufficient, without the presence of gas, to cause a serious explosion, is of opinion that a clause should be inserted in the new Mines Act, making it illegal to use blasting-powder, or other inflammable substance, in any part of the tram or trolley-way, unless the dust on the top, the bottom, and the sides of such tram or trolley-way has been properly damped or removed, for a distance of fifteen yards on each side of the hole in which the shot is to be fired.”

This practical method of dealing with part of the difficulty will doubtless lead to the happiest results, if properly carried out.

The use of *dust-tight* tubs, or mine-waggons, as a means of preventing the deposition of coal-dust in the first place, and thus avoiding the necessity for so many precautions in dealing with it afterwards, suggested itself to me while I was examining the scene of the explosion in the silkstone-pits at Altofts Colliery. In order to fulfil the condition of being dust-tight, the mine-waggons would require to have no crevices of any kind through which dust could be shaken, and they would require to be so filled that no pieces of coal would roll over their sides on to the floor.

This alternative method, which I propose to discuss at greater length elsewhere, showing practical results as far as they extend, might perhaps meet the case of those mines in which the use of water is objectionable, on account of its disintegrating effect upon the roof or floor.

W. GALLOWAY

Cardiff, January 15

Barnard's Comet at Perihelion

IN spite of the bad weather and the glare of twilight and moonlight, I have made a good number of observations and drawings of this comet; especially on December 16, 1886, the day of its passage at perihelion, and consequently of its shortest distance from the sun (nearly two-thirds of the distance of the earth from the sun).

The head of the comet was a large, brilliant, star-like nucleus, surrounded with a splendid, globular *chevelure*. From this sprang two tails: the larger, directed towards the North Pole, was straight, or but a little convex to the east (on which side it was also a little thicker), ending in an extremely faint nebulosity nearly 10° from the head. The smaller tail was much shorter, and directed 50° to the west of the other. The colour of the comet was a beautiful light blue.

The spectrum of the comet resulted from the ordinary three bands of the hydrocarbons; the green being the strongest, then the yellow, whilst the blue was the faintest. The bands were crossed by the linear spectrum of the nucleus, continuous, but strongly reinforced on the bands, and extended very little beyond the limits of the bands themselves.

Before the passage at perihelion the comet had the same form, but less developed; the spectrum also was the same.

On the morning of December 7 I followed the comet with the 10-inch refractor till twenty-five minutes before sunrise: this proves the great brilliancy of the comet.

A. RICCÒ

Palermo Observatory, January 9

Magnetic Theory

MAY I trespass upon your space to ask a question which I have never seen proposed, but which is so obvious that it must have occurred to many others interested in magnetic theory?

In a current field—with closed currents—we have the familiar equations—

$$F = \iiint \frac{udxdydz}{r}, \quad G = \&c., \quad H = \&c.,$$

$$\frac{du}{dx} + \frac{dv}{dy} + \frac{dw}{dz} = 0 = \frac{dF}{dx} + \frac{dG}{dy} + \frac{dH}{dz},$$

$$\nabla^2 F + 4\pi u = 0, \quad \&c.$$

And if *a, b, c* are the components of magnetic force—

$$a = \frac{dG}{dx} - \frac{dH}{dy} \quad \&c., \quad 4\pi u = \frac{dc}{dx} - \frac{db}{dy} \quad \&c.$$

In a magnetised mass, *A, B, C* being components of magnetisation, if we take

$$F = \iiint \left\{ B \frac{d}{dx} - C \frac{d}{dy} \right\} \frac{dxdydz}{r}, \quad G = \&c., \quad H = \&c.$$

We have at all external points a magnetic force of the components *a, b, c*, where $a = \frac{dG}{dx} - \frac{dH}{dy}$, &c.

If we introduce the vector whose components per unit volume, *u, v, w*, are $\frac{dB}{dx} - \frac{dC}{dy}$, &c., where *A, B, C* are continuous and per unit surface are $nB - mC$ over surfaces where *A, B, C* pass discontinuously to zero, we get $F = \iiint \frac{udxdydz}{r}$, &c.

$$\frac{du}{dx} + \frac{dv}{dy} + \frac{dw}{dz} = 0 = \frac{dF}{dx} + \frac{dG}{dy} + \frac{dH}{dz},$$

and all the equations of the current field are reproduced.

Only the components *a, B, γ*, of the magnetic force at internal points, being derivable from the potential

$$V = \iiint \frac{1}{r} \left(\frac{dA}{dx} + \frac{dB}{dy} + \frac{dC}{dz} \right) dxdydz,$$

are not identical with *a, b, c*, as they do not satisfy the equations $\frac{dc}{dy} - \frac{db}{dz} = 4\pi u$, &c.

My question is, what is the physical evidence in favour of the existence of *A, B, C* and *a, B, γ*?

All we know, and can know, about a magnetised mass is derivable from observations of the external field.

Everything, therefore, that we can know is satisfied by expressing the state of the mass in terms of *u, v, w*, and regarding these quantities as the ordinary electric current components. So that *a, b, c* are components of force everywhere.

My meaning is that if the order of our investigations had been reversed, commencing with current phenomena and so passing on to magnetic, it seems almost certain that we should have attempted to explain the latter in terms of the former.

Doubtless many of the observed facts of induced magnetism would present grave difficulties, but I do not think these difficulties would have driven us to the hypothesis of permanently polarised molecules, or that we should have derived any additional help from such hypothesis.

H. W. WATSON

Berkeswell Rectory, Coventry

Sounding a Crater, Fusion-Points, Pyrometers, and Seismometers

I HAD expected to see some confirmation of the remarks that form the chief part of the letter on this subject by Dr. H. J. Johnston-Lavis in NATURE of the 30th ult. (p. 197), but as no one has taken up the matter yet, perhaps you will allow me, as for years the chief assistant of the late Robert Mallet, to say that it is quite true that elaborate apparatus was devised by him and made by different instrument-makers, with a view to obtaining experimental information on the whole of the questions and more than those referred to by Dr. H. J. Johnston-Lavis. A preliminary report was presented by him to the British Association in 1863, in which the scope of his inquiry and nature of apparatus were mentioned, and other reports were written by him which I have not by me now. I am also able to say that the whole of the apparatus remained for years, through Prof. Guiscardi, in the University of Naples, and that Mallet wrote to him as to its disposition for the use of others, should occasion permit, just before his death.

W. WORBY BEAUMONT

Norwood Road, S.E.

Folkestone Gault

MR. JOHN GRIFFITHS, of Folkestone, the well-known collector of Gault fossils, is without resources, and is permanently disabled by rheumatism, brought on by exposure in his daily labours, which have not only enriched the museums of Europe and the United States, but have formed the groundwork of the investigations into the zones and fossils of the Gault made by myself and fellow-workers—the Rev. Prof. Wiltshire, F.G.S., before my own endeavours, and those of Messrs. F. G. H. Price, F.G.S., and Starkie Gardner, F.G.S., since. Mr. F. G. H. Price, of Messrs. Child's Bank, Temple Bar, W.C., has kindly undertaken to receive subscriptions.

H.M. Geological Survey

C. E. DE RANCE

Wolves, Mares, and Foals

When in The Asturias in 1885, I was told of a very curious case of animal instinct, which may be worth recording. Wolves are by no means unfrequent in The Asturias, and often attack the young foals which are sent up to pasturage with the mares in the mountains. The experienced danger seems to have begotten a precautionary instinct of a very intelligent kind. It is said that, on an alarm of wolves, the mares and foals congregate for mutual protection and common defence. The mares form themselves into a sort of cordon, heads outwards, surrounding a space inclosing the young foals, and are ready for attacking with their fore-feet the wolves on their approach.

My informant gave me a graphic account of such an attack, of which he was an eye-witness for nearly an hour, and described to me how the wolves circled round and round the defenders, first at some distance, then gradually approaching nearer and nearer, seeking an opening into the inclosure, till at last they came within striking distance, and he saw one wolf rolled over dead by a blow from the fore-foot of one of the mares.

The fore-foot is not commonly used for defence by any equine species; but it is obvious that the more powerful hind-leg blow would be of little service against the spring of a wolf from behind, without the directing eye to guide the stroke. What a long experience must this mutual protection have been the result of! We can scarcely understand it, without councils of war having been held, the dangers discussed, and signals for concerted action arranged; but now all this instinct may merely be the inheritance of the experience of former generations.

Benthall, Kenley, Surrey, January 6 GEORGE MAW

THE SUN'S HEAT¹

FROM human history we know that for several thousand years the Sun has been giving heat and light to the earth as at present; possibly with some considerable fluctuations, and possibly with some not very small progressive variation. The records of agriculture, and the natural history of plants and animals within the time of human history, abound with evidence that there has been no exceedingly great change in the intensity of the Sun's heat and light within the last 3000 years; but for all that, there may have been variations of quite as much as 5 or 10 per cent., as we may judge from considering that the intensity of the solar radiation to the earth is $6\frac{1}{2}$ per cent. greater in January than in July; and neither at the equator nor in the northern or southern hemispheres has this difference been discovered by experience or general observation of any kind. But as for the mere age of the Sun, irrespective of the question of uniformity, we have proof of something vastly more than 3000 years in geological history, with its irrefragable evidence of continuity of life on the earth in time past for tens of thousands, and probably for millions of years.

Here, then, we have a splendid subject for contemplation and research in natural philosophy, or physics, the science of dead matter. The sun, a mere piece of matter of the moderate dimensions which we know it to have, bounded all round by cold ether, has been doing work at the rate of four hundred and seventy-six thousand million million horse-power for 3000 years, and at possibly more, and certainly not much less, than that for a few million years. How is this to be explained? Natural philosophy cannot evade the question, and no physicist who is not engaged in trying to answer it can have any other justification than that his whole working time is occupied with work on some other subject or subjects of his province by which he has more hope of being able to advance science.

I suppose I may assume that every person present knows as an established result of scientific inquiry that the sun is not a burning fire, and is merely a fluid mass cooling, with some little accession of fresh energy by meteors occasionally falling in, of very small account

¹ Lecture on "The Probable Origin, the Total Amount, and the Possible Duration, of the Sun's Heat," delivered by Sir William Thomson, F.R.S., at the Royal Institution, on Friday, the 21st inst.

in comparison with the whole energy of heat which he gives out from year to year. You are also perfectly familiar with Helmholtz's form of the meteoric theory, and accept it as having the highest degree of scientific probability that can be assigned to any assumption regarding actions of prehistoric times. You understand, then, that the essential principle of the explanation is this: at some period of time, long past, the sun's initial heat was generated by the collision of pieces of matter gravitationally attracted together from distant space to build up his present mass; and shrinkage due to cooling gives, through the work done by the mutual gravitation of all parts of the shrinking mass, the vast thermal capacity in virtue of which the cooling has been, and continues to be, so slow. I assume that you have not been misled by any of your teachers who may have told you, or by any of your books in which you may have read, that the sun is becoming hotter because a gaseous mass, shrinking because it is becoming colder, becomes hotter because it shrinks.

An essential detail of Helmholtz's theory of solar heat is that the sun must be fluid, because even though given at any moment hot enough from the surface to any depth, however great, inwards, to be brilliantly incandescent, the conduction of heat from within through solid matter of even the highest conducting quality known to us would not suffice to maintain the incandescence of the surface for more than a few hours, after which all would be darkness. Observation confirms this conclusion so far as the outward appearance of the sun is concerned, but does not suffice to disprove the idea which prevailed till thirty or forty years ago that the sun is a solid nucleus inclosed in a sheet of violently agitated flame. In reality, the matter of the outer shell of the sun, from which the heat is radiated outwards, must in cooling become denser, and so becoming unstable in its high position, must fall down, and hotter fluid from within must rush up to take its place. The tremendous currents thus continually produced in this great mass of flaming fluid constitute the province of the newly-developed science of solar physics, which, with its marvellous instrument of research—the spectroscope—is yearly and daily giving us more and more knowledge of the actual motions of the different ingredients, and of the splendid and all-important resulting phenomena.

Now, to form some idea of the amount of the heat which is being continually carried up to the sun's surface and radiated out into space, and of the dynamical relations between it and the solar gravitation, let us first divide that prodigious number (476×10^{21}) of horse-power by the number (6.1×10^{18}) of square metres in the sun's surface, and we find 78,000 horse-power as the mechanical value of the radiation per square metre. Imagine, then, the engines of eight ironclads applied to do all their available work of, say, 10,000 horse-power each, in perpetuity driving one small paddle in a fluid contained in a square metre vat. The same heat will be given out from the square metre surface of the fluid as is given out from every square metre of the sun's surface.

But now to pass from a practically impossible combination of engines and a physically impossible paddle and fluid and containing vessel, towards a more practical combination of matter for producing the same effect: still keep the ideal vat and paddle and fluid, but place the vat on the surface of a cool, solid, homogeneous globe of the same size (697×10^8 metres radius) as the sun, and of density (1.4) equal to the sun's density. Instead of using steam-power, let the paddle be driven by a weight descending in a pit excavated below the vat. As the simplest possible mechanism, take a long vertical shaft, with the paddle mounted on the top of it so as to turn horizontally. Let the weight be a nut working on a screw-thread on the vertical shaft, with guides to prevent the nut from turning—the screw and the guides being all absolutely

frictionless. Let the pit be a metre square at its upper end, and let it be excavated quite down to the sun's centre, everywhere of square horizontal section, and tapering uniformly to a point at the centre. Let the weight be simply the excavated matter of the sun's mass, with merely a little clearance space between it and the four sides of the pit, and a kilometre or so cut off the lower pointed end to allow space for its descent. The mass of this weight is 326×10^6 tons. Its heaviness, three-quarters of the heaviness of an equal mass at the sun's surface, is 244×10^6 tons solar surface-heaviness. Now a horse-power is 270 metre-tons, terrestrial surface-heaviness, per hour; or 10 metre-tons, solar surface-heaviness, per hour. To do 78,000 horse-power, or 780,000 metre-tons, solar surface-heaviness, per hour, our weight must therefore descend at the rate of 1 metre in 313 hours, or about 28 metres per year.

To advance another step, still through impracticable mechanism, towards the practical method by which the sun's heat is produced, let the thread of the screw be of uniformly decreasing steepness from the surface downwards, so that the velocity of the weight, as it is allowed to descend by the turning of the screw, shall be in simple proportion to distance from the sun's centre. This will involve a uniform condensation of the material of the weight; but a condensation so exceedingly small in the course even of tens of thousands of years, that, whatever be the supposed character, metal or stone, of the weight, the elastic reaction against the condensation will be utterly imperceptible in comparison with the gravitational forces with which we are concerned. The work done per metre of descent of the top end of the weight will be just four-fifths of what it was when the thread of the screw was uniform. Thus, to do the 78,000 horse-power of work, the top end of the weight must descend at the rate of 35 metres per year: or 70 kilometres, which is one one-hundredth per cent. ($1/10,000$) of the sun's radius, per 2000 years.

Now let the whole surface of our cool solid sun be divided into squares, for example as nearly as may be of 1 square metre area each, and let the whole mass of the sun be divided into long inverted pyramids or pointed rods, each 700,000 kilometres long, with their points meeting at the centre. Let each be mounted on a screw, as already described for the long tapering weight which we first considered; and let the paddle at the top end of each screw-shaft revolve in a fluid, not now confined to a vat, but covering the whole surface of the sun to a depth of a few metres or kilometres. Arrange the viscosity of the fluid and the size of each paddle so as to let the paddle turn just so fast as to allow the top end of each pointed rod to descend at the rate of 35 metres per year. The whole fluid will, by the work which the paddles do in it, be made incandescent, and it will give out heat and light to just about the same amount as is actually done by the sun. If the fluid be a few thousand kilometres deep over the paddles, it would be impossible, by any of the appliances of solar physics, to see the difference between our model mechanical sun and the true sun.

Now, to do away with the last vestige of impracticable mechanism, in which the heavinesses of all parts of each long rod are supported on the thread of an ideal screw cut on a vertical shaft of ideal matter, absolutely hard and absolutely frictionless: first, go back a step to our supposition of just one such rod and screw working in a single pit excavated down to the centre of the sun, and let us suppose all the rest of the sun's mass to be rigid and absolutely impervious to heat. Warm up the matter of the pyramidal rod to such a temperature that its material melts and experiences enough of Sir Humphrey Davy's "repulsive motion" to keep it balanced as a fluid, without either sinking or rising from the position in which it was held by the thread of the screw. When the matter is thus held up without the screw, take away the screw

or let it melt in its place. We should thus have a pit from the sun's surface to his centre, of a square metre area at the surface, full of incandescent fluid, which we may suppose to be of the actual ingredients of the solar substance. This fluid, having at the first instant the temperature with which the paddle left it, would at the first instant continue radiating heat just as it did when the paddle was kept moving; but it would quickly become much cooler at its surface, and to a distance of a few metres down. Convection-currents, with their irregular whirls, would carry the cooled fluid down from the surface, and bring up hotter fluid from below, but this mixing could not go on through a depth of very many metres to a sufficient degree to keep up anything approaching to the high temperature maintained by the paddle; and after a few hours or days, solidification would commence at the surface. If the solidified matter floats on the fluid at the same temperature below it, the crust would simply thicken as ice on a lake thickens in frosty weather; but if, as is more probable, solid matter, of such ingredients as the sun is composed of, sinks in the liquid when both are at the melting temperature of the substance, thin films of the upper crust would fall in, and continue falling in, until, for several metres downwards, the whole mass of mixed solid and fluid becomes stiff enough (like the stiffness of paste or of mortar) to prevent the frozen film from falling down from the surface. The surface film would then quickly thicken, and in the course of a few hours or days become less than red-hot on its upper surface. The whole pit full of fluid would go on cooling with extreme slowness until, after possibly about a million million years or so, it would be all at the same temperature as the space to which its upper end radiates.

Now, let precisely what we have been considering be done for every one of our pyramidal rods, with, however, in the first place, thin partitions of matter impervious to heat separating every pit from its four surrounding neighbours. Precisely the same series of events as we have been considering will take place in every one of the pits.

Suppose the whole complex mass to be rotating at the rate of once round in 25 days.

Now at the instant when the paddle stops let all the partitions be annulled, so that there shall be perfect freedom for convection-currents to flow unresisted in any direction, except so far as resisted by the viscosity of the fluid, and leave the piece of matter, which we may now call the Sun, to himself. He will immediately begin showing all the phenomena known in solar physics. Of course the observer might have to wait a few years for sunspots, and a few quarter-centuries to discover periods of sunspots, but they would, I think I may say probably, all be there just as they are; because I think we may feel that it is most probable that all these actions are due to the sun's own mass and not to external influences of any kind. It is, however, quite possible, and indeed many who know most of the subject think it probable, that some of the chief phenomena due to sunspots arise from influxes of meteoric matter circling round the sun. The energy of chemical combination is as nothing compared with the gravitational energy of shrinkage, to which the sun's activity is almost wholly due, but chemical combinations and dissociations may, as urged by Lockyer, be thoroughly potent determining influences on some of the features of non-uniformity of the brightness in the grand phenomena of sunspots, hydrogen flames, and corona, which make the province of solar physics. But these are questions belonging to a very splendid branch of solar science with which we are not occupied this evening.

What concerns us at present may be summarised in two propositions:—

(1) Gigantic convection-currents throughout the sun's liquid mass are continually maintained by fluid, slightly

cooled by radiation, falling down from the surface, and hotter fluid rushing up to take its place.

(2) The work done in any time by the mutual gravitation of all the parts of the fluid, as it shrinks in virtue of the lowering of its temperature, is but little less than (so little less than, that we may regard it as practically equal to) the dynamical equivalent of the heat that is radiated from the sun in the same time.

The rate of shrinkage corresponding to the present rate of solar radiation has been proved to us, by the consideration of our dynamical model, to be 35 metres on the radius per year, or one ten-thousandth of its own length on the radius per two thousand years. Hence, if the solar radiation has been about the same as at present for two hundred thousand years, his radius must have been greater by 1 per cent. two hundred thousand years ago than at present. If we wish to carry our calculations much farther back or forward than two hundred thousand years, we must reckon by differences of the reciprocal of the sun's radius, and not by differences simply of the radius, to take into account the change of density (which, for example, would be 3 per cent. for 1 per cent. change of the radius). Thus the rule, easily worked out according to the principles illustrated by our mechanical model, is this:—

Equal differences of the reciprocal of the radius correspond to equal quantities of heat radiated away from million of years to million of years.

Take two examples:—

(1) If in past time there has been as much as fifteen million times the heat radiated from the sun as is at present radiated out in one year, the solar radius must have been four times as great as at present.

(2) If the sun's effective thermal capacity can be maintained by shrinkage till twenty million times the present year's amount of heat is radiated away, the sun's radius must be half what it is now. But it is to be remarked that the density which this would imply, being 11·2 times the density of water, or just about the density of lead, is probably too great to allow the free shrinkage as of a cooling gas to be still continued without obstruction through overcrowding of the molecules. It seems, therefore, most probable that we cannot for the future reckon on more of solar radiation than, if so much as, twenty million times the amount at present radiated out in a year. It is also to be remarked that the greatly diminished radiating surface, at a much lower temperature, would give out annually much less heat than the sun in his present condition gives. The same considerations led Newcomb to the conclusion "that it is hardly likely that the sun can continue to give sufficient heat to support life on the earth (such life as we now are acquainted with, at least) for ten million years from the present time."

In all our calculations hitherto we have for simplicity taken the density as uniform throughout, and equal to the true mean density of the sun, being about 1·4 times the density of water, or about a fourth of the earth's mean density. In reality the density in the upper parts of the sun's mass must be something less than this, and something considerably more than this in the central parts, because of the pressure in the interior increasing to something enormously great at the centre. If we knew the distribution of interior density we could easily modify our calculations accordingly, but it does not seem probable that the correction could, with any probable assumption as to the greatness of the density throughout a considerable proportion of the sun's interior, add more than a few million years to the past of solar heat, and what could be added to the past must be taken from the future.

In our calculations we have taken Pouillet's number for the total activity of solar radiation, which practically

agrees with Herschel's. Forbes¹ showed the necessity for correcting the mode of allowing for atmospheric absorption used by his two predecessors in estimating the total amount of solar radiation, and he was thus led to a number 1·6 times theirs. Forty years later Langley,² in an excellently worked out consideration of the whole question of absorption by our atmosphere, of radiant heat of all wave-lengths, accepts and confirms Forbes's reasoning, and by fresh observations in very favourable circumstances on Mount Whitney, 15,000 feet above the sea-level, finds a number a little greater still than Forbes (1·7, instead of Forbes's 1·6, times Pouillet's number). Thus Langley's number expressing the quantity of heat radiated per second of time from each square centimetre of the sun's surface corresponds to 133,000 horse-power per square metre, instead of the 78,000 horse-power which we have taken, and diminishes each of our times in the ratio of 1 to 1·7. Thus, instead of Helmholtz's twenty million years, which was founded on Pouillet's estimate, we have only twelve millions, and similarly with all our other time reckonings based on Pouillet's results. In the circumstances, and taking fully into account all possibilities of greater density in the sun's interior, and of greater or less activity of radiation in past ages, it would, I think, be exceedingly rash to assume as probable anything more than twenty million years of the sun's light in the past history of the earth, or to reckon on more than five or six million years of sunlight for time to come.

But now we come to the most interesting part of our subject—the early history of the sun. Five or ten million years ago he may have been about double his present diameter and an eighth of his present mean density, or 1·75 of the density of water; but we cannot, with any probability of argument or speculation, go on continuously much beyond that. We cannot, however, help asking the question, What was the condition of the sun's matter before it came together and became hot? It may have been two cool solid masses, which collided with the velocity due to their mutual gravitation; or, but with enormously less of probability, it may have been two masses colliding with velocities considerably greater than the velocities due to mutual gravitation. This last supposition implies that, calling the two bodies A and B for brevity, the motion of the centre of inertia of B relatively to A, must, when the distances between them was great, have been directed with great exactness to pass through the centre of inertia of A; such great exactness that the rotational momentum after collision was of proper amount to let the sun have his present rotational period when shrunk to his present dimensions. This exceedingly exact aiming of the one body at the other, so to speak, is, on the dry theory of probability, exceedingly improbable. On the other hand, there is certainty that the two bodies A and B at rest in space if left to themselves, undisturbed by other bodies and only influenced by their mutual gravitation, shall collide with direct impact, and therefore with no motion of their centre of inertia, and no rotational momentum of the compound body after the collision. Thus we see that the dry probability of collision between two of a vast number of mutually attracting bodies widely scattered through space is much greater if the bodies be all given at rest, than if they be given moving in any random directions and with any velocities considerable in comparison with the velocities which they would acquire in falling from rest into collision. In this connection it is most interesting to know from stellar astronomy, aided so splendidly as it has recently been by the spectroscopy, that the relative motions of the visible stars and our sun are generally very small in comparison with the velocity (612 kilometres per second) a body would acquire

¹ "On the Age of the Sun's Heat," by Sir William Thomson (*Macmillan's Magazine*, March 1862); and Thomson and Tait's "Natural Philosophy," 2nd edition, vol. 1, part ii., Appendix E.

² *Edin. New Phil. Journal*, xxxvi. 1844.

³ "On the Selective Absorption of Solar Energy," *American Journal of Science*, vol. xxv., March 1883.

in falling into the sun, and are comparable with the moderate little velocity (29.5 kilometres per second) of the earth in her orbit round the sun.

To fix the ideas, think of two cool solid globes, each of the same mean density as the earth, and of half the sun's diameter, given at rest, or nearly at rest, at a distance asunder equal to twice the earth's distance from the sun. They will fall together and collide in half a year. The collision will last for a few hours, in the course of which they will be transformed into a violently agitated incandescent fluid mass, with about eighteen million (according to the Pouillet-Helmholtz reckoning, of twenty million) years' heat ready made in it, and swelled out by this heat to possibly one and a half times, or two, or three, or four times, the sun's present diameter. If instead of being at rest initially they had had a transverse relative velocity of 1.42 kilometres per second, they would just escape collision, and would revolve in equal ellipses in a period of one year round the centre of inertia, just grazing one another's surfaces every time they come round to the nearest points of their orbits.

If the initial transverse component of relative velocity be less than, but not much less than, 1.42 kilometres per second, there will be a violent grazing collision, and two bright suns, solid globes bathed in flaming fluid, will come into existence in the course of a few hours, and will commence revolving round their common centre of inertia in long elliptic orbits in a period of a little less than a year. The quasi-tidal interaction will diminish the eccentricities of their orbits; and if continued long enough will cause the two to revolve in circular orbits round their centre of inertia with a distance between their surfaces equal to .644 of the diameter of each.

If the initial transverse component relative velocity of the two bodies were just 68 metres per second, the moment of momentum, the same before and after collision, would be just equal to that of the solar system, of which seventeen-eighteenth is Jupiter's and one-eighteenth the sun's: the other bodies of the system being not worth considering in the account. Fragments of superficially-melted solid, or splashes of fluid, sent flying away from the main compound mass could not possibly by tidal action or other resistance get into the actual orbits of the planets, whose evolution requires some finer if more complex fore-ordination than merely the existence of two masses undisturbed by any other matter in space.

I shall only say in conclusion:—Assuming the sun's mass to be composed of portions which were far asunder before it was hot, the immediate antecedent to its incandescence must have been either two bodies with details differing only in proportion and densities from the cases we have been now considering as examples; or it must have been some number more than two—some finite number—at the most the number of atoms in the sun's present mass, which is a finite number as easily understood and imagined as number 3 or number 123. The immediate antecedent to incandescence may have been the whole constituents in the extreme condition of subdivision—that is to say, in the condition of separate atoms; or it may have been any smaller number of groups of atoms making up minute crystals or groups of crystals—snowflakes of matter, as it were; or it may have been lumps of matter like this macadamising stone; or like this stone, which you might mistake for a macadamising stone, and which was actually travelling through space till it fell on the earth at Possil, in the neighbourhood of Glasgow, on April 5, 1804; or like this—which was found in the Desert of Atacama in South America, and is believed to have fallen there from the sky—a fragment made up of iron and stone, which looks as if it has solidified from a mixture of gravel and melted iron in a place where there was very little of heaviness; or this splendidly crystallised piece of iron, a slab cut out of the celebrated aërolite of Lenarto, in

Hungary;¹ or this wonderfully shaped specimen, a model of the Middlesburgh meteorite, kindly given me by Prof. A. S. Herschel, with corrugations showing how its melted matter has been scoured off from the front part of its surface in its final rush through the earth's atmosphere when it was seen to fall on March 14, 1881, at 3.35 p.m.

For the theory of the sun it is indifferent which of these varieties of configurations of matter may have been the immediate antecedent of his incandescence, but I can never think of these material antecedents without remembering a question put to me thirty years ago by the late Bishop Ewing, Bishop of Argyll and the Isles: "Do you imagine that piece of matter to have been as it is from the beginning; to have been created as it is, or to have been as it is through all time till it fell on the earth?" I had told him that I believed the sun to be built up of stones, but he would not be satisfied till he knew or could imagine, what kind of stones. I could not but agree with him in feeling it impossible to imagine that any one of these meteorites before you has been as it is through all time, or that the materials of the sun were like this for all time before they came together and became hot. Surely this stone has an eventful history, but I shall not tax your patience longer to-night by trying to trace it conjecturally. I shall only say that we cannot but agree with the common opinion which regards meteorites as fragments broken from larger masses, but we cannot be satisfied without trying to imagine what were the antecedents of those masses.

PROTOPLASM*

IT is a natural and beneficial result of the present energetic pursuit of biological science that every now and again some thinker comes forward to show us where we stand, and to what our thoughts are impelling us. Subordinate to the universal eminence and influence of a Linnæus or a Darwin, the critics of a decade exert no small effect on contemporary investigation by suggesting new modes of viewing or expressing things; and even though the originality is not always happy, and the generalisations are sometimes unfortunate, it is nevertheless a healthy sign that specialists of reputation, led to view matters with a severely critical eye as their work progresses, occasionally turn round and warn us that it would be as well to take stock of the facts, and see what are the chances of solving some large problem. Moreover, it has to be borne in mind that as various branches reach a certain stage their results need overhauling by specialists in other departments, and it becomes a question who is to prepare the problems of biology, for instance, so that the mathematician or the physicist may criticise them.

As much on this account as for his own contribution to the store of facts, we must welcome Dr. Berthold's clever "Studies" as an earnest and important attempt to contribute to a knowledge of the mechanics of life. Of course it is always a difficulty to decide how far a specialist may be expected to take an accurate view of a large problem to the direct solution of which his own researches can contribute but little; but experience has shown that more is to be looked for from the deep insight obtained by close investigation than from the few brilliant suggestions scattered through volumes of merely clever thinking. In the present case, the moderate tone of the book, and the easy earnestness of the writer, should at least insure careful reading of the 324 pages of text in which Dr. Berthold expresses his bold ideas; and whether the conclusions stand or fall, the reader will be amply repaid by the observations collected and the criticisms on several questions now agitating the minds of botanists.

¹ The three aërolites now exhibited belong to the Hunterian Museum of the University of Glasgow, and have been kindly lent me for this evening by the Curator, Dr. Young.

* "Studien über Protoplasmenmechanik." By Dr. G. Berthold, Professor of Botany in the University of Göttingen. (Leipzig: Arthur Felix, 1904.)

The title of the book must be taken in a comprehensive sense, for the whole "cell-theory" (if we possess one) is under review in the nine chapters into which the text is divided. This extensive aim is justified by the author's treatment of the subject, which affords an admirable survey of current botanical speculation.

Before proceeding to a closer examination of the work, we may state that there are seven well-executed plates, with descriptions which are too short. The index might have been more ample—it includes the names of plants and authors only—but the table of contents is very full and good.

An introduction of eleven pages leads us at once to the chief position assumed by the author. So long as we do not understand the *Amœba*, we must be in the dark as regards the mechanism of life in higher organisms. Nothing has been gained by regarding protoplasm as "living proteid," or as containing "living" as opposed to "dead" proteids, and so forth: moreover, no clearness, but rather the contrary, has so far resulted from hypotheses as to the "structure" of protoplasm, or from distinctions between "idioplasm" and other constituents. The author therefore inquired whether we are not perhaps treading an aimless path, and whether we should not go back and examine earlier views, and proceed anew. The consequence to his mind was the resumption of the old analogy between a drop of protoplasm and a drop of fluid, and he was led to inquire into the analogy more deeply, especially on finding that a detailed analysis of the problem had not before been seriously undertaken. As the general result of investigations begun in 1882, the author decides that protoplasm is to be regarded as a highly complex emulsion, differing in consistence in the different cases. There is nothing in the chemistry and metabolism known which need clash with this view of the fluid nature of the "physical basis of life," and the author decides that the forces upon which the changes of form, internal movements, and so forth, depend, are the same as those which determine whether a fluid shall assume the form of a drop, or drops, or spread out and wet another body, and so on—in fact, the forces concerned in surface-tensions.

The author frankly admits the difficulty, and even seeming impossibility, of imitating some of the conditions, or even of deciding whether the actions of protoplasm accord with the theory. This must naturally be the case; and of course no one expects him to imitate all the conditions experimentally. The method employed is essentially deductive and analytic throughout, and for this reason the greatest possible care must be employed in taking any step forward. Partly on this account, and partly owing to other circumstances, the book needs cautious reading, and great difficulties will be felt in regard to many points. This is apart from an undoubted (though perhaps unavoidable) blemish in the book, which consists in the author so often putting off for some pages the consideration of a subject commenced.

The key-note, as it were, of the work having been indicated, a few words must be said regarding some leading features in the various chapters. The first subject dealt with is the layered or stratified nature of the typical cell. A spore of *Equisetum*, for instance, may be regarded as a system of concentric layers. First there is a central nucleus; then various layers of protoplasm, of which the innermost is colourless and contains certain minute granules, the second is thicker and carries the chlorophyll-corpuscles, the third is hyaline and contains lenticular refractive bodies of peculiar nature; then follows the cell-wall, if nothing further. The cell-wall is usually composed of three or more layers.

If we consider the cells of a tissue, Berthold points out that a given partition membrane must be regarded as dividing and belonging to two symmetrical plasmatic systems, and as being their middle and innermost layer.

But all cells are not systems of concentric layers. Not only are excentric layers found, but a complexity is introduced as soon as the sap-vacuoles appear, in many cases making the cell not monocentric but polycentric. The normal order of the layers, as exemplified by the spore of *Equisetum*, or any simple cell with one large vacuole, &c., may be distinguished from the inverse order exhibited, for instance, by the cords in a *Caulerpa*, or the central mass in a cell containing raphides, or anywhere where the sap bathes the system of layers referred to.

It is then shown that in many cases where oil-drops, &c., have usually been regarded as lying free in a cell, they are inclosed in an ingrowth from the cell-wall, reminding us of cystoliths. An examination of intercellular spaces follows: the most interesting question is as to the existence of protoplasm in lacunæ between cells. Berthold quotes *Aconitum Napellus* as affording conclusive evidence, and confutes the contention of Gardiner and Schenck against Russow's statements. Berthold goes much further, however. He finds a thin layer of protoplasm overlying the cuticle of the epidermis and of spores, and, to put it shortly, concludes that the cell-wall is formed and embedded in protoplasm, and not excreted on its surface—the cell-wall is a supporting apparatus, not a protective one. Again, a cell forming part of a tissue cannot be forthwith compared with a unicellular Alga, for this reason: the latter may be regarded as consisting of two parts, (1) the inner protoplasmic system with its contiguous share of cell-wall, (2) the outer strata of cell-wall plus the hypothetical covering of protoplasm. Only the first of these two parts of the algal cell can be compared with a tissue-cell.

The relation of these ideas to Sachs's view, that we are to regard a plant as a whole cut up into cell-chambers, and not as a whole built up of single cells, is obvious to all who have followed recent speculations in botany.

It is, of course, impossible to go at any length into the contents of all the chapters. The second is concerned with the finer structure of the cell—nucleus, chlorophyll-corpuscles, and other cell-contents. Incidentally we may note the emphatic statement that starch is not formed in the *Melanophyceæ* (p. 57); that the word "microsome" has no definite meaning, and had better be discarded (p. 61). Later on the author expressly states his inability to confirm Strasburger's and Schmitz's conclusions that microsomes are employed in building up the cell-wall (p. 208), and even hints at confusion between crystalline particles and microsomes in the case of *Spirogyra*!

If protoplasm is an emulsion, it follows that the various processes of separation of sap-vacuoles, oil-drops, crystalline and other particles, have to be explained as according with similar separations in lifeless mixtures. Berthold finds no difficulties insuperable here, and even discusses the probable origin and disappearance of chlorophyll-corpuscles and nuclei on the assumption that they are part of the protoplasm. Although they now always arise by the division of those previously existing, they must have been formed from protoplasm in the first instance. The action of external stimuli offers a fertile subject for discussion. As regards geotropism, the author regards "the primary effect of gravitation" as consisting in the different rates of movement of substances of different specific gravity.

The supposition that anything is explained by regarding protoplasm as essentially "living proteid," is severely criticised on pp. 74 and 75, and the author agrees with Baumann that the arguments which exalt proteids into the position of being the most essential constituent of protoplasm would apply equally well to water. The "living substance of organisms" is always an extremely complex mixture. At the same time, it would seem that the author here raises some gratuitous difficulties, since no biologist really regards protoplasm as a simple substance, proteid or otherwise. One consequence of the discussion

might almost be foreseen: Berthold proposes to recast the definition of protoplasm, and to subordinate to it—the fluid mixture absent from no living cell—cytoplasm, nucleus, chlorophyll-bodies, vacuoles, tannin and oil-drops, &c., as so many parts, of the protoplasm as a whole. He urges that the introduction of the ideas cytoplasm, ectoplasm, and so on, have driven the time-honoured word protoplasm out of the field, whereas its usefulness as a comprehensive word—though with a somewhat different meaning from the current one—for the whole is undoubted. Moreover, it is to be insisted upon that the protoplasm is active as a whole.

The discussion as to the meaning of the term “organised” must be here passed over, with many other points of interest.

In the third chapter we have a long analysis of the movements of naked masses of protoplasm. All turns upon the tendency of a mass of protoplasm to assume the form of a spherical drop; this can only be due to the same causes which impel a drop of any accepted liquid to assume the drop condition. Justice could not be done by summarising this analysis, and the demonstration that cylinders of protoplasm, like cylinders of liquids, tend to break up in a definite way. The end result of a long argument is, that the amoeboid condition depends upon the degree of wetting of the environment by the fluid protoplasm and *vice versa*.

If three fluids which do not mix are in contact with one another, the tensions at their surfaces can be mathematically investigated, and Berthold maintains that the principles here concerned govern the behaviour of a drop of protoplasm as they do that of an ordinary liquid under the given conditions. The phenomena of spreading out, putting forth and withdrawing pseudopodia, rounding off, &c., are due to the same causes and ruled by the same laws as the flowing of one liquid over another, or its withdrawal from it (glycerine and alcohol *e.g.*), or its assumption of the drop form, and so on. Of course amoeboid movements are complex, because the liquid amoeba is not a simple fluid, but is undergoing rapid changes due to its metabolism and exchanges with the environment, processes which are acting with different energy at different places. It must be clearly understood that a rapid survey of Berthold's position cannot do justice to his argument: whether his position is accepted or rejected, there is no doubt that he clearly sees and provides for many important difficulties, some of which seem to have been overlooked. It will be regarded as a startling idea by some (though the idea is not altogether new) that fine pseudopodia are not the results of activity on the part of the amoeba: such pseudopodia must be looked upon as *drawn out* by the surrounding medium, not *put out into* it. Here, again, exceptions occur where blunt processes are driven forth by local contractions and other causes, but the sum total of all the argument is (as expressly stated again on p. 109) that the amoeboid condition is the symptom that the organism wets the substratum and displaces the surrounding medium, indicating that the intensity of the tension between the medium and the protoplasm is but small. The discussion as to the causes and effects of the internal movements in protoplasm must here be passed over, with the simple remark that the author sees no difficulty which cannot be explained from our knowledge of the mechanics of liquids. On p. 106 is proposed an explanation of the remarkable filaments observed by F. Darwin on *Dipsacus sylvestris*.

Chapter IV. deals with what is practically a continuation of the second chapter—the symmetry or arrangement of the cell-contents. The stratified or shell arrangement is again expressly referred to, and an attempt made to explain it on the main assumption of the book. The arrangement referred to is a consequence of exchanges (diffusion, absorption, &c.) with the environment: passive particles suspended in the cell would have to assume

positions which are definite; active particles (*i.e.* particles which themselves exchange with the layer in which they are embedded) might interfere with the simple shell arrangement, and we have systems within a system. After examining what occurs in the case of a spherical system or cell, the author extends the analysis to an ellipsoid and other anisodiametric systems, and finds the results accord with what is found in Nature. The question of the “Hautschicht” is then attacked, and De Vries' late statements as to the existence of a pellicle or “wall” around the vacuole are criticised. Berthold, to put it shortly, condemns this pellicle as an artificial product—a “precipitation-membrane”—in many if not in most cases. On p. 154 it is still more emphatically stated that the cell-wall inside the cell is formed “always in the interior of the protoplasm, never on its surface,” and it is probable “that the same is the case even when free masses of protoplasm surround themselves with a membrane.” The membrane stated to exist around the nucleus is condemned, with a certain reserve, as a probable precipitation-membrane. Other interesting points must be passed over.

The fifth chapter is practically concerned with showing that in spite of the great variety of forms exhibited by the chlorophyll-bodies of different plants, especially Algae, their position, consistence, changes in form, division, &c., can be explained in accordance with the view that they are parts of an emulsion. Other cell-contents are considered also—oil-drops, tannin, nucleus, vacuoles, &c.—but at less length. The chlorophyll-corpuses of higher plants are compared to drops resting on a substratum which they do not wet, their shape being in part due to radial pressures. When they are more extended and amoeboid, their actions are explained according to the principles (contact of three surfaces, &c.) employed before. *Spirogyra* and other Conjugatae present difficulties. While the “chlorophyll-apparatus” displays a relatively large surface, the converse is the case with nuclei and other cell-contents, and the form of the spherical drop (maximum cubic contents with minimum superficial area) is usual; though exceptions exist and are investigated.

The division of chlorophyll-corpuses is then examined, and this leads naturally to the division of the nucleus and cell, which is treated separately. A spherical mass of fluid must increase its surface if it divides: this implies a diminution of tension at the common surface (as with the formation of pseudopodia), and concentric shells in the medium or in the mass of fluid in question. All the conditions fulfilled, pseudopodia can be formed either from the medium into the mass, or from the mass into the medium. An annular pseudopodium would divide the spherical (or spheroidal) mass into two. This is, shortly put, the position as Berthold views it. He then again applies the analysis of dividing cylinders, and proceeds to apply the results to what is observed in a cell. The radial pressure, and growth in one direction of the cell, may be important factors. But the real difficulty is met with when considering the division of spherical bodies in the cells of the growing-points, for instance; and the same applies to cell-division. Why should a sphere—a stable form—pass over into an elongated body, which then divides? It must be assumed that “under the influence of its own metabolism, and that of its environment a bi-polar symmetry arises in the chlorophyll-corpuse, in consequence of which the division takes place equatorially.”

This leads to the sixth chapter, which is in many respects the most important, as it is the most interesting. After reviewing the process of cell-division generally, the author separates the essential from the unessential processes, and agrees with Strasburger that the division of the nucleus must be regarded as an accompanying phenomenon. The division of the ovum of *Echium* and *Ciona* is described: soon after the male and female

nuclei have fused, two centres appear in the egg, each with radii—the required bi-polarity is established. The exchanges and movements in the protoplasm are then allowed; the result is that certain constituents accumulate to excess in the equator between the two radiating centres, or “suns.” The chief points are illustrated by diagrams. The two “suns” are the centres of the future daughter-cells; the still single nucleus lies between them on a bridge of the same protoplasm as the “suns” (these “suns,” by the bye, are the *Attractions-Kugeln* of Van Beneden, and the *Pol-Kugeln* of others) are embedded in: the more peripheral protoplasm of the cell (ovum) has accumulated chiefly around the nucleus—*i.e.* in the equatorial plane. This equatorial protoplasm then begins to contract in two the nucleus, which has assumed the “karyokinetic” condition. Passing over many details, we may sum up the explanation shortly. The superficial shells of protoplasm are assumed to put forth pseudopodia between the “suns”—*i.e.* the author regards it as fundamentally a wetting process, due to changes at the surfaces. The processes are essentially of the same nature in vegetable cells, though it is impossible in a short space to summarise Berthold’s discussion as to the relative importance of the numerous details which occur in different cases. Obviously the stumbling-block which is best worth further attack is the origin of bi-polarity in a spherical mass: that Berthold’s suggestions do not satisfy the requirements will probably occur to everyone. The explanation offered to account for the complex karyokinesis cannot be regarded as fully satisfactory. At the same time some advantage may accrue from the new lights in which he puts the central figures of cell-division. We are here only half through the book however, and must proceed, confining our remarks still more closely.

Chapter VII. treats of the cell-network of plants, and the directions of cell-divisions, &c. It is in great measure a criticism of Sachs’s celebrated view of the structure of the higher plants, and deals at some length with several of his positions. Of course, Berthold assumes primarily that the plant is to be regarded as chambered—cut up into cells, not built up of them. Two main principles are then employed. (1) The cell-divisions are, as a rule (at least in growing-points, &c.), halvings—*i.e.* each daughter-cell has the same cubic contents. This leads to a discussion of very many cases. Of course the shape of a segment does not forthwith enable us to judge of its relative contents, and difficulty occurs sometimes on this account: it is impossible to summarise the remarks, and especially since reference to the figures is necessary. 2) The second fundamental principle is that which regulates the position of fluid lamellæ elsewhere—the principle of least areas. The rule is that the new cell-wall takes such a direction that its area is the smallest possible. There are exceptions, *e.g.* cambium cells; but at least one feature appears to indicate a tendency to follow the principle—cell-walls never abut in the angles of cells. Sachs’s law of rectangular division is comprehended as a particular case of Berthold’s more general law: it fails where simultaneous divisions result in the formation of polygonal cells—*e.g.* in the embryo-sac—with walls inclined at angles greater than the right-angle.

The eighth chapter deals with the sculpturing on the exterior of cell-walls, and allied phenomena; while Chapter IX. (the last) is devoted to “free cell-formation.”

Enough has been said to show the wide scope of the book, though full criticism of it will only be possible after some of Berthold’s test-cases have been worked over. Of course, from the nature of the work, it is open to the charge of being transcendental; but at the same time it must be allowed that we are getting into serious difficulties with protoplasm, and good, bold, shaking criticism is beneficial. In any case, several investigators will, no doubt, have something to say to Berthold’s statements,

for there is no lack of observations, old and new, as well as hypothesis, in the book we dismiss with this short review.
H. MARSHALL WARD

ON THE EXPLOSION OF METEORITES

WE have received from M. Hirn a *tirage à part* of a communication to *L’Astronomie*, in which he discusses the various phenomena accompanying the explosion of meteorites, with a view to explaining their causes.

M. Daubrée, a long time ago, pointed out how very striking and difficult of explanation the noises are which are often heard in connection with the passage of meteorites, and called in question the explanation which had been given of their being really due to a veritable explosion.

M. Hirn, in his paper, begins by considering the causes which are at work in the production of the thunder which accompanies electric discharges, and of this he writes as follows:—“The sound, which we call thunder, is due, as everybody knows, to the fact that the air traversed by an electric spark, that is, a flash of lightning, is suddenly raised to a very high temperature, and has its volume moreover considerably increased. The column of gas thus suddenly heated and expanded is sometimes several miles long; as the duration of the flash is not even a millionth of a second, it follows that the noise bursts forth at once from the whole column; but for an observer in any one place it commences where the lightning is at the least distance. In precise terms, the beginning of the thunder-clap gives us the minimum distance of the lightning; and the length of the thunder-clap gives us the length of the column. It must be remarked that when a flash of lightning strikes the ground, it is not necessarily from the place struck that the first noise is heard.” M. Hirn then gives an interesting case which proves the truth of this remark. He next points out that a bullet whistles in traversing the air, so that we can to a certain extent follow its flight; the same thing happens with a falling meteorite just before striking the earth. The noise actually heard has been compared to the flight of wild geese or the sound produced when one tears linen: it is due to the fact that the air rapidly pushed on one side in front of the projectile, whether bullet or meteorite, quickly rushes back to fill the gap left in the rear.

The most rapid cannon-shots scarcely attain a velocity of 600 metres a second, while meteorites penetrate the air with a velocity of 40,000 or even 60,000 metres per second; and this increased velocity gives rise to phenomena, which, although insignificant where cannon-shots are in question, become very intense and important when we consider the case of the meteorite. With that velocity the air is at once raised to a temperature of from 4000° to 6000° C. The matter on the surface of the meteorite will be torn away by the violence of the gaseous friction produced, and will be vaporised at the same time by the heat. This is undoubtedly the origin of the smoke which meteorites leave trailing behind them.

We have, then, precisely as in the case of lightning, a long narrow column of air, which is expanded, not so instantaneously certainly as by lightning, but at all events in an extremely short time and through a great length. Under these circumstances we should have an explosion in one case as in the other: a clap of thunder followed by a rolling noise more or less prolonged. If a cannon-ball could have imparted to it a velocity of 100,000 metres per second, it would no longer whistle, it would thunder, and at the same time it would produce a flash, as of lightning, and would be instantly burnt up. M. Hirn depends upon this line of reasoning to show that meteoric thunder need not necessarily have anything to do with an actual explosion. He then points out that the intensity of the noise produced in every point of its trajectory

depends, (1) on the height; (2) on the velocity of the meteorite; (3) on its size; and (4) on the configuration of the country over which it passes. He refers to the observation of Saussure that a pistol fired at a height of 5000 metres makes very little noise: he then points out that at a height of 100,000 metres the density of the air is reduced to the small value of 0.000,000,004 krg.; the temperature being supposed to be -200°C . In such a medium as this a meteorite could produce no sound, although it might give out a very brilliant light, because its temperature and light depend not on the absolute value, but on the rapid change of density.

SIR JOSEPH WHITWORTH

ON Saturday night last, Sir Joseph Whitworth died at the English Hotel, Monte Carlo. In the department of mechanical engineering there is, perhaps, no greater name, and his career was one upon which his countrymen may well look back with pride and pleasure. He was born on December 21, 1803, at Stockport, where his father was a schoolmaster. At the age of twelve he was sent from his father's school to Mr. Vint's academy at Idle, near Leeds, where he remained until he was fourteen, when he was placed with his uncle, a cotton-spinner in Derbyshire. Here he made himself familiar with the construction and working of all the machines then used in cotton-spinning. If he had chosen, he might perhaps have inherited his uncle's property, but he was already conscious of the true bent of his genius, and after six years' service, being unable to emancipate himself in a more regular manner, he ran away to Manchester. At Manchester he remained for four years, working in the shops of Messrs. Crighton and other employers, and obtaining a thorough mastery of the methods of manufacturing cotton-machinery. Recognising the necessity of wide experience, he went to London when he had secured all the practical knowledge that could be obtained in his special line at Manchester, and he was fortunate enough to be employed by Maudslay, who soon learned to appreciate his exceptional gifts, and took him into his own private workroom, and placed him next to Hampson, the best workman in the establishment. From Maudslay's, Mr. Whitworth went to Holtzapfel's, and afterwards to Clements's, where Babbage's calculating-machine was being constructed. During his residence in London, Mr. Whitworth began the splendid series of inventions which were to secure for him the foremost place among the mechanical engineers of his period. His first important self-imposed task was to construct the true plane, by which tool-makers might be enabled to produce, for all kinds of sliding tools, surfaces on which the resistance arising from friction would be reduced to a minimum. The work to be achieved was one of immense difficulty, and his fellow-workman, Hampson, used to laugh at him for having undertaken an impossible job. Mr. Whitworth, however, was a man of extraordinary tenacity of purpose, and did not allow himself to be discouraged. At last he succeeded, and showed his friend the perfect plane he had produced. "You've done it," said Hampson, who was astounded by a result which he had always thought to be beyond the reach of human effort.

In 1833, at the age of thirty, Mr. Whitworth, feeling that he might now safely turn to his own energies, returned to Manchester and opened a shop for the manufacture of engineers' tools. He was far from thinking that his first triumph had given the full measure of his powers. Already he had been working at another very complicated problem—how to do away with the inconveniences caused by variations in the pitch and thread of the screws used in the construction of machinery. In this enterprise he was as successful as in his first great undertaking. Obtaining specimens of the screws made

by leading manufacturers, he constructed one which, without being exactly like any one of those before him, was the average of them all. It was everywhere accepted, and its introduction marked an era in the history of the manufacture of machinery. The advantage derived from the invention is that every screw of the same diameter has now a thread of the same pitch and of the same number of turns to the inch, and that all screws of the same size are interchangeable. His next achievement was the construction of an instrument capable of measuring the one-millionth part of an inch. This instrument was so delicate that when a steel bar 3 feet in length was warmed by momentary contact with a finger-nail, it at once indicated the expansion due to this slight cause.

As a maker of engineers' tools Mr. Whitworth of course soon became famous, and in 1853 he was sent to America as one of the Royal Commissioners to the New York Exhibition. Afterwards he drew up a remarkable report on American manufacturing industry. On his return to England it was suggested by the late Lord Hardinge that the great mechanician, whose fame was now firmly established, should be asked by the Government to design and produce machinery for the manufacture of rifles for the army. The rifles at that time issued to the army were carefully examined by him, and he decided that if his services were to be of any avail it would be necessary for him to determine the form and dimensions which would produce the best results. With an alacrity very unusual in such matters, the Government consented to erect in his private grounds at Rusholme, near Manchester, a shooting-gallery 500 yards long. Here Mr. Whitworth laboured assiduously, trying many kinds of experiment, and at every stage of his progress making absolutely sure of his ground before advancing a step towards fresh conclusions. The result of his investigations was to revolutionise the manufacture of rifles. As the *Times* has said, "he determined, by absolute and precise experiment, the effects of every conceivable pitch and kind of rifling, and of every length of projectile, from the sphere to one of twenty diameters in length; and he settled once for all the conditions of trajectory and of accuracy of flight." The significance of his efforts began to be understood by every one when, at the first Wimbledon meeting, Her Majesty fired the first shot from a Whitworth rifle, placed on a mechanical rest sliding upon true planes. At 400 yards' range the bullet struck the target on its vertical diameter, one inch and a quarter above the intersection of the horizontal. What he established with regard to rifles he found to be in the main true with regard to weapons of a larger calibre, and he proved the importance of this fact by constructing a series of magnificent cannon.

In the course of his inquiries as to the principles which ought to be observed in the manufacture of rifled small arms and ordnance, Mr. Whitworth became penetrated by the conviction that a new material must be provided, since mild steel was apt to be rendered unsound by the imprisonment of escaping gases during the process of cooling from the molten state. He solved the problem by using great hydraulic presses for the squeezing of the molten metal in the act of cooling, so that the particles might be brought into closer contact and the gases liberated. The steel produced by this method is remarkable for its lightness, strength, and tenacity, and is largely used in the construction of boilers, screw-propeller shafts, and for other purposes.

In 1869 Mr. Whitworth was created a baronet, and he had already been for some years a Fellow of the Royal Society and a D.C.L. of Oxford. He had amassed wealth, and thoroughly appreciated all the advantages it secured for him. He was, however, a man of enlightened ideas and generous impulses, and early in 1869 he did splendid service to mechanical and engineering industry by founding the Whitworth Scholarships, which

he endowed to the extent of 100,000*l.* He was twice married—first, in 1825, to Fanny, youngest daughter of Mr. Richard Ankers; then, in 1871, to Mary Louisa, widow of Mr. Alfred Orrell. Notwithstanding his unwearied attention to business, he contrived to have some leisure time, and he spent it very agreeably at his estate of Stancliffe, in Derbyshire, where he devoted himself to landscape gardening. He also derived a great deal of pleasure from his horses and his herd of short-horns. For some time his health had been failing, and until lately he went every winter to the Riviera. Two years ago he made for himself at Stancliffe a winter garden, hoping that he might thus be able to spend the winter at home. Last year he went abroad again, and now, at the age of eighty-three, his long and great career has come to an end. The whole civilised world may be said to be familiar with his name, and he will always be remembered as the most illustrious English mechanician of the present age. Few men of his time have done more for the nation than Whitworth. His "Scholarships" have had the most important influence upon the knowledge and training of the rising generation of engineers. There are now nearly 200 Whitworth Scholars throughout the land, and they will doubtless be largely represented at his funeral.

NOTES

SINCE our last week's number was issued, Prof. Huxley has sent an important letter to the *Times* on the subject of the true functions of the Imperial Institute. From this letter we make the following extract:—"That with which I did intend to express my strong sympathy was the intention which I thought I discerned, to establish something which should play the same part in regard to the advancement of industrial knowledge which has been played in regard to science and learning in general, in these realms, by the Royal Society and the Universities. I pictured the Imperial Institute to myself as a house of call for all those who are concerned in the advancement of industry; as a place in which the home-keeping industrial could find out all he wants to know about colonial industry and the colonist about home industry; as a sort of neutral ground on which the capitalist and the artisan would be equally welcome; as a centre of inter-communication in which they might enter into friendly discussion of the problems at issue between them, and, perchance, arrive at a friendly solution of them. I imagined it a place in which the fullest stores of industrial knowledge would be made accessible to the public; in which the higher questions of commerce and industry would be systematically studied and elucidated; and where, as in an industrial University, the whole technical education of the country might find its centre and crown. If I earnestly desire to see such an institution created, it is not because I think that or anything else will put an end to pauperism and want—as somebody has absurdly suggested—but because I believe it will supply a foundation for that scientific organisation of our industries which the changed conditions of the times render indispensable to their prosperity. I do not think I am far wrong in assuming that we are entering, indeed have already entered, upon the most serious struggle for existence to which this country has ever been committed. The latter years of the century promise to see us embarked in an industrial war of far more serious import than the military wars of its opening years. On the east, the most systematically instructed and best informed people in Europe are our competitors; on the west, an energetic offshoot of our own stock, grown bigger than its parent, enters upon the struggle possessed of natural resources to which we can make no pretension, and with every prospect of soon possessing that cheap labour by which they may be effectually utilised. Many circumstances tend to justify the hope that we may hold our own if we are careful to 'organise victory.' But, to those who reflect

seriously on the prospects of the population of Lancashire and Yorkshire—should the time ever arrive when the goods which are produced by their labour and their skill are to be had cheaper elsewhere—to those who remember the cotton famine and reflect how much worse a customer famine would be, the situation appears very grave. I thought—I still think—that it was the intention of the Prince of Wales and his advisers, recognising the existence of these dangers ahead, to make a serious effort to meet them, and it was in that belief that I supported the proposed Institute." We are glad to see that in the pamphlet which is now being circulated by the organisers of the Imperial Institute it is acknowledged that in this communication Prof. Huxley "has clearly defined the functions of the Imperial Institute as recognised by the propounders of the scheme."

THE Royal Society of New South Wales offers its medal and a prize of 25*l.* for the best communication (provided it be of sufficient merit) containing the results of original research or observation upon any one of a list of subjects which it has published. Communications on the following subjects must be sent in not later than May 1 next:—On the silver ore deposits of New South Wales; origin and mode of occurrence of gold-bearing veins and of the associated minerals; influence of the Australian climate in producing modifications of diseases; and on the Infusoria peculiar to Australia. A year later the Society will receive papers on the anatomy and life-history of the Echinida and Platypus; the anatomy and life-history of Mollusca peculiar to Australia; and the chemical composition of the products from the so-called kerosene shale of New South Wales. The subjects on which communications must be sent in not later than May 1, 1889, are:—On the chemistry of the Australian gums and resins; on the aborigines of Australia; on the iron ore deposits of New South Wales; list of the marine fauna of Port Jackson, with descriptive notes as to habits, distribution, &c. The competition is open to all without any restriction whatever, excepting that a prize will not be awarded to a Member of the Council for the time being; neither will an award be made for a mere compilation, however meritorious in its way. The communication to be successful must be either wholly or in part the result of original observation or research on the part of the contributor.

THE Compagnie du Congo pour le Commerce et l'Industrie is organising an expedition, composed of geologists and others, for the exploration of the Upper Congo and its tributaries.

WE regret to announce the death of Mr. Edward Livingstone Youmans, a well-known American writer on science. Mr. Youmans was born in New York in 1821, and though suffering much from defective vision, prosecuted from his early youth the study of science. He became well known as a public lecturer. He planned the "International Scientific Series" in 1871, in connection with which he made several visits to Europe. In 1872 he established the *Popular Science Monthly* in New York. Mr. Youmans died on Thursday last, January 20.

IT is sometimes said that intellectually Scotland does not stand on so high a level as in former times. This may be true so far as literature is concerned, but it is certainly not true with regard to science. At a recent meeting of the Royal Society of Edinburgh Mr. John Murray, of the *Challenger*, one of the Vice-Presidents, declared that he questioned whether any country in the world, taking its size into consideration, could show a better record of scientific work or a greater mass of scientific literature than Scotland during the past ten or twenty years. In making this statement Mr. Murray's object was not to glorify his own country but to show that its scientific establishments have a solid claim to better treatment than they have hitherto received at the hands of the Government. Money grants, he stated, of considerable annual value are devoted to the maintenance of learned Societies in London and Dublin. In Scotland, according to Mr.

Murray, the only grant of the kind is 300*l.* annually to the Royal Society of Edinburgh, and this is repaid to a Government Department in the form of rent. With regard to London, Mr. Murray, we think, should verify his references, as we know of no Society which receives "a money grant of considerable value."

THE death is announced of M. Feil, the well-known glass-founder, who prepared so many disks for the large telescopes in use in several Observatories; and of M. Mercadier, Professor of Physics to the Polytechnic School of Paris, and author of the only French book on electrical measures. M. Feil was seventy-four years of age; M. Mercadier ten years younger.

THE French are making use of their occupation of Madagascar to gain a thorough knowledge of the natural history of the island. There have already issued from the national press several fascicules of a magnificent "Histoire physique, naturelle, et politique de Madagascar," edited by M. Alfred Grandier, to be completed in thirty volumes quarto. The subjects to be comprised in this work are: (1) physical and astronomical geography; (2) meteorology and magnetism; (3) ethnology, anthropology, and linguistics; (4) political, colonial, and commercial history; (5) natural history of mammals; (6) natural history of birds; (7) natural history of fishes; (8) natural history of reptiles; (9) natural history of Crustacea; (10) natural history of terrestrial and freshwater mollusks; (11) natural history of plants; (12) geology and palæontology. The various sections are intrusted to competent authorities; and the geological portion is to be illustrated by about 500 chromolithographs or coloured plates, the anatomical details being represented in lithography and photography. The total number of plates will not be less than 1200.

PREPARATIONS for the first general meeting, at Rome, of the International Statistical Institute are being made by the Executive Committee, consisting of Sir Rawson W. Rawson, K.C.M.G., C.B. (the President), M. E. Levasseur and Prof. von Neumann-Spallart (Vice-Presidents), Signor Luigi Bodio (General Secretary), and Mr. John Biddulph Martin (Treasurer). The arrangements will be announced by the Committee in due course.

ON Friday evening last an important lecture on "Modern War-Ships" was delivered at the Mansion House by Mr. W. H. White, Director of Naval Construction and Assistant Controller of the Navy. The lecture, which was illustrated by diagrams and models, was one of a series given by members of the Company of Shipwrights. Mr. White's object was to place before the meeting facts and figures illustrating the progress of war-ship building in recent years, and he confined his attention almost exclusively to the period between 1859, when the ironclad reconstruction of the Royal Navy began, and the present year. He presented a very lucid and interesting account of the extraordinary changes which have taken place during this time in the methods of war-ship building.

DR. HOPKINSON'S account of the electric lighthouses of Macquarie and of Tino, which was read before the Institution of Civil Engineers last month, has just been issued in pamphlet form, with a report of the oral and written discussion to which it gave rise.

IT is stated that the Lake District in New Zealand is showing signs of fresh disturbances. Tremors have been felt at Rotorua, and Tarawera has emitted dense volumes of steam. The Wahanga Peak appeared most active. No fire was visible, and after this outburst everything quieted down again.

WE have before us the first number of the "Bulletin of Miscellaneous Information," issued from the Royal Gardens, Kew.

The "Bulletin" will appear from time to time as an occasional publication, and will contain notes, too detailed for the Annual Report, on economic products and plants to which the attention of the staff of the Royal Gardens has been drawn in the course of ordinary correspondence, or which have been made the subject of particular study at Kew. These notes will serve the purpose of an expeditious mode of communication to the numerous correspondents of Kew in distant parts of the Empire, and they will be useful to members of the general public interested in planting or agricultural business in India and the colonies. The present number contains much valuable information about Teff, one of the cereals indigenous to Abyssinia, and about Oil of Ben.

MESSRS. GINN AND CO., publishers, Boston, U.S.A., are about to issue a *Journal of Morphology*, which will be devoted principally to embryological, anatomical, and histological subjects. Mr. C. O. Whitman, Milwaukee, Wis., will be the editor. For the present only two numbers a year will be issued. The agent for Great Britain is Mr. W. P. Collins.

MESSRS. DE LA RUE AND CO. have in the press the second volume of "A Treatise on Electricity and Magnetism (Methods of Measurement and Applications)," by E. Mascart, Professor in the Collège de France, and Director of the Central Meteorological Bureau, and J. Joubert, Professor in the Collège Rollin. The work is translated by Dr. E. Atkinson, Professor of Experimental Science in the Staff College.

MESSRS. CASSELL AND CO. have just issued the first part of "Our Earth and its Story," a serial which will be completed in thirty six parts, and they are about to publish "Practical Electricity," by Prof. Ayrton.

M. BÉCLARD has presented some interesting statistics to the Academical Council of Paris on the number of female students in the Faculty of Medicine in the University there. He reports that since Germany closed the doors of its Universities to women, the number in Paris has been constantly increasing. At present the numbers of the various nationalities are: Russians 83, English 11, French 7, Americans 3, Austrians 2, Roumanian 1, and Turk 1. The greater number of these do not pursue their studies as far as the doctor's degree. The large proportion of Russian ladies is due to the closing of the female medical school recently founded at St. Petersburg. M. Béclard thinks that the number of students has now reached the maximum, and will probably decline, since the preliminary studies of the Faculty for both sexes have been made alike.

ALTHOUGH the competition which takes place annually for the vacancies in the assistantships in the Paris hospitals is not over, it is known that among the *internes* whose names will be published in some days, there will be one woman. Miss Klumpke is the first woman who has successfully competed for the *concours de l'internat*. In the written examination she ranked second (*ex æquo* with one or two others). She obtained 27 marks, the maximum being 30, and the highest number secured being 28. A good deal of grumbling is going on among the students. The idea of being distanced by a woman is not agreeable to them. Miss Klumpke has done very good work in neuro-pathology, and her name is known to all who study this branch of medicine.

THERE are at present nine female students at the Upsala University, three of whom study medicine, five philosophy, and one jurisprudence.

THE Aquarium constructed by the Executive of the Fisheries Exhibition in 1883 has just been sold by the Royal Commissioners by public auction, the property realising 100*l.* in the aggregate. Until recently it was expected that this Aquarium would be maintained as a part of the Buckland Museum. Many

of the fish with which it made the British public familiar were hatched from ova of foreign fish. There were various Transatlantic forms; and fishes indigenous to India, China, Brazil, Austria, and many other countries were exhibited. Considering the fact that this Aquarium was the only one in London worthy of note, naturalists and the public have good reason to regret that it has been abolished.

Mr. Z. NUTTALL, of the Peabody Museum, Cambridge, Mass., has been led to some interesting results by the study of the Mexican codices. Familiarity with certain phonetic symbols of frequent recurrence in these picture-writings enabled him to perceive that identical symbols are reproduced on the so-called Calendar Stone, the Sacrificial Stone, and other equally well-known Mexican monoliths. The Calendar Stone was, he maintains, the Market Stone of the city of Mexico, and he thinks that from the fixed market days recorded on it the Mexican calendar system may have sprung. The so-called Sacrificial Stone seems to him to have been a Law Stone, recording the periodical collection of certain tributes paid by subjugated tribes, and by others whose obligation it was to contribute to the common wealth of Mexico. Mr. Nuttall expresses his belief that many of the large stone receptacles which are generally called "vessels for containing the hearts and blood of human victims," were in reality standard measures kept for reference in the market place.

WE regret to hear of the death of Dr. Julius Lüttich, the well-known astronomer, who died in Rome on January 3; also of Prof. Jean Louis Trasenster, who died on the same day. M. Trasenster was Professor of Engineering and Mining at the Liège University.

THE Report of the Kew Committee for 1886, lately published, shows that the well-known work of the Kew Observatory has been actively carried on during the year. To particularise in certain subjects, it may be mentioned that in the magnetic observations four notable magnetic disturbances were recorded, occurring severally in the months of January, March, July, and October, and that the diurnal range of the declination for the summer and winter seasons, as well as the whole year, is given in a table in the Appendix. In solar observations the results of sketches of sunspots in continuation of Schwabe's enumeration are also recorded in the Appendix. The adoption of a new graphic process for determining cloud heights and motions, devised by Prof. Stokes, has been very satisfactory in saving computation when reducing the photographic pictures. Whilst thus adding its valuable yearly contributions to science, the Observatory is becoming more and more useful in results of immediate utility to the general public. In this respect the rating of watches is a matter of growing convenience to those who require a good time-keeper accompanied with a trustworthy certificate as to the performance of the watch they are about to purchase. Chronometers are also now rated here, and from the 35 days' period of trial in a range of 30° of temperature to which these instruments are subjected by the staff of the Observatory, there is every reason to believe in the ascertained rates. It is encouraging to note that increasing good work points to the necessity for enlarging the existing accommodation afforded by the buildings.

WE have received the third volume of the Proceedings and Transactions of the Royal Society of Canada. It relates to the year 1885. Among the scientific articles may be mentioned "The Artistic Faculty in Aboriginal Races" and "Palæolithic Dexterity," by Dr. Daniel Wilson; "A Natural System in Mineralogy, with a Classification of Native Silicates," by Dr. T. Sterry Hunt; "The Mesozoic Floras of the Rocky Mountain Region," by Sir W. Dawson; "Illustrations of the Fauna

of the St. John Group, continued," by Mr. G. F. Matthew; "Catalogue of Canadian Butterflies, with Notes on their Distribution," by Mr. W. Saunders; and "The Skull and Auditory Organ of the Siluroid Hypophthalmus," by Mr. R. Ramsay Wright.

AN elaborate paper on "The Right Hand and Left-Handedness" was lately read before the Royal Society of Canada by Dr. Daniel Wilson, President of University College, Toronto. His final conclusion on this difficult subject, which he has repeatedly discussed from various points of view, is, that left-handedness is due to an exceptional development of the right hemisphere of the brain. Dr. Wilson, who is himself left-handed, concludes his paper with the expression of a hope that after his death his own brain may be "turned to account for the little further service of settling this physiological puzzle." "If my ideas are correct," he says, "I anticipate as the result of its examination that the right hemisphere will not only be found to be heavier than the left, but that it will probably be marked by a noticeable difference in the number and arrangement of the convolutions."

THE additions to the Zoological Society's Gardens during the past week include a White-whiskered Swine (*Sus leucomystox* ♀) from Loochoo Islands, presented by Mr. H. Pryer, C.M.Z.S.; two Blackiston's Eagle Owls (*Bubo blackistoni*) from Yesso, Japan, presented by Mr. J. H. Leech, F.Z.S.; two Schlegel's Doves (*Cathartopelia puella*) from West Africa, presented by Mr. H. C. Donovan; a Macaque Monkey (*Macacus cynomolgus*) from India, a Suricate (*Suricata tetradactyla*) from South Africa, deposited; a Red Kangaroo (*Macropus rufus* ♀), a Yellow-footed Kangaroo (*Petrogale xanthopus* ♀), born in the Gardens.

OUR ASTRONOMICAL COLUMN

THREE NEW COMETS.—The discovery of a great comet is telegraphed from several southern Observatories. So far as is yet known it was discovered by Mr. Thome at Cordoba on January 18. It was then situated in the constellation Crux; apparently not far from γ Crux. On the following evening the tail only was seen at Melbourne, projecting some 30° above the southwestern horizon. On January 20 it was remarked at Adelaide; here again the tail only was seen. In its physical appearance the comet strongly recalls the great southern comet of 1880, being long, narrow, and straight. It is not brilliant, though readily visible to the naked eye in the twilight. The tail was traced as far as a Toucani. It is expected that the comet will become very brilliant. The nucleus was observed at Adelaide and Melbourne on January 23. The Melbourne observation is as follows:—January 23d. 8h. om., R.A. 21h. 20m. 28s. daily motion + 7m. 44s., Decl. 44° 17' S., daily motion + 51'.

Another comet was discovered on January 22 by Mr. W. H. Brooks, of the Red House Observatory, Phelps, New York. Its place on that day at 6h. 54m. was R.A. 18h. om., Decl. 71° N. It was faint, and was moving slowly in an easterly direction. A third comet has been discovered by Mr. E. E. Barnard, Nashville, Tennessee; and observed at Harvard College as follows:—January 24d. 17h. 55.7m., R.A. 19h. 10m. 17.4s., daily motion + 2m. 36s., Decl. 25° 57' 45" N., daily motion - 0° 35'. The comet is faint.

NEW VARIABLES.—Mr. S. C. Chandler, Jun., writes in Gould's *Astronomical Journal*, No. 149, to state that the period of the new variable of the Algol type, D.M. + 34° No. 4181, the discovery of which we announced last week (p. 282), is not yet precisely known. It is either 5.997d. or some aliquot part thereof, but not either the third or fifth part. The approximate elements supplied by Mr. Chandler are as follows:—

$$1886 \text{ December } 9.458d. \text{ G.M.T. } + \left(\frac{5.997d.}{n} \text{ E.} \right)$$

where n can be neither 3 nor 5. The period may therefore be about three days, one day and a half, or a shorter period still. An examination of the relation which the duration of the oscillation in the light of the other stars of the type bears to the whole period leads Mr. Chandler to conclude

that the most probable period is one of 1d. 11h. 59m., or if not that, 20h. 34m., or possibly 18h. 6m. The following table shows that the shorter the period of the variable, the higher is the ratio which the period of oscillation bears to it. In the present star the oscillation probably occupies about six hours; a period so great as three days or much shorter than one day would make it, therefore, an exception to the rule followed by the other seven stars of the same order.

Star	Period h.	Oscillation h.	Ratio
U Ophiuchi ...	20.13	5.0	0.248
δ Libræ ...	55.85	12.0	0.214
U Cephei ...	59.82	10.0	0.167
Algol ...	68.81	9.15	0.134
U Coronæ ...	82.85	9.75	0.118
λ Tauri ...	94.87	10.0	0.105
S Cancri ...	227.63	21.5	0.094

The variable was discovered by Mr. Chandler and not by Dr. Gould as at first reported.

Mr. Espin, in Circular No. 12 of the Liverpool Astronomical Society, notes the variability of a star om. 35s. ρ and $o^{\circ} 8' \pi$ of δ Tauri. It is probably a variable of long period ranging from 9m. \pm to below 12m. Its place for 1885^o is R.A. 4h. 21m. 25s., Decl. 15^o 50' 7" N.

THE WASHINGTON OBSERVATORY.—The Annual Report of the U.S. Naval Observatory, dated October 30, 1886, has recently been issued. Commodore G. E. Belknap, who was Superintendent of the Observatory at the date of the last Report, retired from that post on June 7, and was succeeded by Commander Allan D. Brown, who therefore is the writer of the Report now before us. In connection with the Chronometer and Time-Service Department, under Lieut. S. C. Paine, it is remarked that the time-service continues to increase in popularity, and its usefulness is daily becoming more apparent to the public. The time-balls that have been established have been much appreciated, and are of great value to the shipping and commercial interests. Much attention appears also to have been given to the chronometer trials, it evidently being the desire of the Observatory to afford makers every assistance in its power in obtaining data that will tend to the improvement of chronometers. The 26-inch refractor, in charge of Prof. Asaph Hall, has been used in observations of satellites, of double stars, and of Saturn. Observations of stellar parallax have also been made. The reduction of the observations of Iapetus and of the six inner satellites of Saturn, as well as those for stellar parallax, have been completed, and the results published. The transit-circle has been employed in observations of stars of the American ephemeris, of the sun, moon, and planets, and such miscellaneous stars as were necessary to complete the data for the proposed transit-circle Catalogue. The whole number of observations since the last Report has been 5180. The reductions have also been proceeded with as rapidly as possible. The instrument remains in charge of Prof. J. R. Eastman. Photographs of the sun have been taken with the photo-heliographic apparatus lately belonging to the Transit of Venus Commission, whenever practicable. The work was commenced on January 11, 1886; and up to and including September 30, 1886, there have been obtained ninety-eight negatives showing spots on the sun's surface. Hitherto no photographs have been taken, except when the sun showed spots on his disk, and then one only near noon. This work has been intrusted to Ensign A. G. Winterhalter, who hopes that in the future the number of photographs in a given period will be considerably increased, better arrangements having been made for securing them between 10 a.m. and 2 p.m.

ASTRONOMICAL PHENOMENA FOR THE WEEK 1887 JANUARY 30—FEBRUARY 5

(FOR the reckoning of time the civil day, commencing at Greenwich mean midnight, counting the hours on to 24, is here employed.)

At Greenwich on January 30

Sun rises, 7h. 44m.; souths, 12h. 13m. 31.8s.; sets, 16h. 43m.; decl. on meridian, 17^o 39' S.; Sidereal Time at Sunset, 1h. 21m.

Moon (at First Quarter on February 1) rises, 10h. 23m.; souths, 16h. 50m.; sets, 23h. 27m.; decl. on meridian, 4^o 40' N.

Planet	Rises h. m.	Souths h. m.	Sets h. m.	Decl. on meridian
Mercury ...	7 46	11 55	16 4	20 56 S.
Venus ...	8 25	13 11	17 57	14 51 S.
Mars ...	8 31	13 29	18 27	12 40 S.
Jupiter... ..	0 35	5 37	10 39	12 3 S.
Saturn... ..	14 29	22 36	6 43	22 11 N.

* Indicates that the setting is that of the following morning.

Occultations of Stars by the Moon (visible at Greenwich)

Jan.	Star	Mag.	Disap. h. m.	Resp. h. m.	Corresponding angles from ver- tex to right for inverted image
30 ...	♄ Piscium	4½	21 24	22 15	185 289 ^o
Feb.					
3 ...	♃ 48 Tauri	6	1 15	2 9	150 300
3 ...	B.A.C. 1526	6	18 26	19 24	122 233

Variable Stars

Star	R.A. h. m.	Decl.	h. m.
R Andromedæ ...	0 18.1	37 57 N.	Jan. 31, 0 0 <i>m</i>
U Cephei ...	0 52.3	81 16 N.	31, 22 0 <i>m</i>
			Feb. 5, 21 39 <i>m</i>
Algol ...	3 0.8	40 31 N.	5, 4 23 <i>m</i>
♋ Geminorum ...	6 57.4	20 44 N.	3, 0 0 <i>M</i>
♌ Libræ ...	14 54.9	8 4 S.	3, 1 49 <i>m</i>
S Serpentis ...	15 16.4	14 43 N.	4, <i>M</i>
U Ophiuchi... ..	17 10.8	1 20 N.	Jan. 30, 4 16 <i>m</i>
			and at intervals of 20 8
♁ Lyræ... ..	18 45.9	33 14 N.	Feb. 4, 19 0 <i>m</i> ₂
♁ Cephei ...	22 25.0	57 50 N.	4, 1 0 <i>M</i>

M signifies maximum; *m* minimum; *m*₂ secondary minimum.

GEOGRAPHICAL NOTES

In connection with Major Macgregor's paper on his journey from Upper Assam to the Irrawadi, read at a recent meeting of the Royal Geographical Society, and printed in the new number of the Proceedings, Dr. G. Watt made some valuable remarks on his own observations in the Manipur district. Manipur is a small valley surrounded by mountain-ranges, and in this valley the rainfall was found to be only about 39 inches, but seventeen miles off, in the mountains which formed the north-east ranges, the rainfall was as much as 120 inches, and towards the Naga country to the north it became greater and greater in certain limited tracts. In the Khasia Hills 600 inches might fall in one place, and twenty miles off only 50 inches. Nothing in Manipur struck Dr. Watt so much, as a botanist, as the remarkable transitions of vegetation in that small region. Dr. Watt gathered twelve or more species of oaks, many of which were new to science, and ten or twelve species of rhododendrons, in Manipur alone. The *Rhododendron Falconeri*, found in the Naga Hills by Sir Joseph Hooker, is nowhere met with in the immense tract between the Naga Hills and Sikkim. This and the epiphytic *R. Dalhousiae*, which grows on a hill thirty miles north of Darjeeling, Dr. Watt found in the Naga Hills at an altitude of 6000 to 8000 feet, and these rhododendrons never occur in Sikkim below 10,000 to 13,000 feet. There were many instances of plants falling in their altitude as the traveller passed to the east and south-east from Sikkim, until at Moulmein a rhododendron was found growing near the sea, a circumstance which was not met with in any other part of Asia. There is something in that region which, apart from pure geography, is of vital interest. Sarameti, which is under 13,000 feet high, the natives said, had snow all the year round, whereas on the Himalayas the lowest point at which snow occurs is 17,000 feet. In Manipur, the whole valley, 3000 feet high, was covered with hoar-frost in December. Dr. Watt thought this was a point that should be thoroughly investigated: what is the cause of this falling in altitude in the vegetation? General Strachey, who was in the chair, considered that the peculiarities of the vegetation of Manipur compared with Assam were connected with the evident lowering of temperature indicated by the low snow-line. There could be no doubt that the warm currents of air coming up the valleys of the Irrawadi and the Salween and meeting the snowy mountains to the north produced an enormous precipitation of rain, which during winter fell as snow. The consequence seemed to be that there was snow there at a very much lower level than in the mountains further to the north. That an immense quantity of rain fell in the upper portions of the valley of the

Irrawadi there could be no question. Such a rainfall seemed in itself quite sufficient to account for the large volume of water that was drained off by the lower portions of the Irrawadi; and anybody who knew what Tibet was, General Strachey stated, must be aware that, even with a course of several hundred miles, the river would pick up but a small quantity of water in comparison with the enormous volumes which were collected from the rain which fell in Upper Burmah. General Strachey had roughly calculated that a monthly fall of rain of 18 inches over a square degree would mean 65,000 cubic feet per second for the whole month.

THE latest news from Dr. Bunge, chief of the Russian Polar Station at the mouth of the Lena, is encouraging. Telegraphing from Orkinga, a telegraph-station on the road to Yakutsk, Dr. Bunge informs the Academy of Sciences at St. Petersburg that his expedition has had a successful issue. They passed the summer in two islands of the New Siberia Archipelago; Bunge on Great Liakovsky, and Toll on Kotelnoy Island. During spring all the five islands of the group were explored, New Siberia especially by Toll. The mainland was reached at the end of October. The scientific results are very considerable, and, as we know so little about these islands, are likely to be novel.

MM. POTANIN, SKASSY, AND BÉRÉSOFSKY have lately returned from their expedition to China and Mongolia, bringing numerous collections in anthropology, zoology, and botany, besides maps of the country which they have traversed during their three years' journey (1884-86). The Russian Geographical Society has nominated a committee, consisting of MM. Stebnitsky, Tillo, Mushketoff, and Schmidt, to make inquiries as to the desiccation of Siberian lakes. It is expected that an expedition will be despatched to investigate the subject on the spot.

WE learn that the geographical results achieved by the Survey officers on the Afghan Frontier Commission extend over 100,000 square miles of country. The Indian Survey officers have been very busy in Upper Burmah. Captain Hobson's map, prepared from all available sources, in 14 sheets, is all published already. A reduction therefrom, on the scale of 16 miles to an inch, has been prepared in the Surveyer-General's Office, Calcutta, and published also. The Survey party, which has lately completed the Andaman Islands survey, left Calcutta on November 19, under the charge of Major G. Strahan, R.E., to undertake the survey of the Nicobar Islands.

THE ESKIMO

SPECIAL interest attaches to a paper on "The East Greenlanders in their relations to the other Eskimo Tribes," contributed by Dr. H. Rink to the current number of the *Deutsche Geographische Blätter* (Bremen, 1886). Hitherto these hyperboreans have been studied by independent observers, chiefly in Alaska at the eastern, and in Greenland and Labrador at the western extremity of their domain, while through lack of sufficient materials the intermediate branches thinly scattered round the Arctic shores from the Mackenzie to Baffin Bay have been mostly neglected. Here, however, we have for the first time a comprehensive ethnological survey of the whole field by perhaps the greatest living authority on the subject, based on the rich collections recently brought to Europe by Capt. Holm from East Greenland, by the brothers Krause and A. Jakobsen from Alaska, and by F. Boas from the central region of Baffin Land.

With these materials before him, and keeping in view the facts already determined by previous students, Dr. Rink is able to throw much light, if not on the origin, at least on the general line of dispersion, and still more on the social evolution and art history, of the Eskimo race. He makes it sufficiently evident that their primeval home must be placed in the extreme north-west, on the Alaskan shores of the Bering Sea, where they probably acquired a knowledge of some of the useful industries connected with navigation, fishing, and hunting from the neighbouring Indian tribes of Athabaskan stock. From this point the migratory movement appears to have been partly across the neck of the Alaskan Peninsula to the Copper River, where their further progress in this direction was arrested by the Thlinkit Indians on the coast and by the Athabascans in the interior. But their wanderings were chiefly directed towards the north and east, that is, along "the line of least resistance" around

the unoccupied Arctic seaboard down to Baffin Bay, which seems to have formed a fresh point of dispersion, southwards to Labrador and eastwards to East and West Greenland. Dr. Rink is inclined to accept the view of Capt. Holm, that the Angmagasliks, or East Greenlanders, found their way round the unexplored north coast of Greenland to their present homes, and that the West Greenlanders passed from Baffin Bay directly southwards, while a mixed race, most probably including old Norse elements, was developed at the southern extremity of the peninsula. In the extreme west there has also been a slight intermingling, with Thlinkits about the Copper River, and with Athabascans, back of Kotzebue Sound; but elsewhere the Innuvit and Karalik (Western and Eastern Eskimo) have kept entirely aloof, nowhere amalgamating with the Red Man, and keeping mainly to the seaboard throughout the whole extent of their domain, which, between the Copper River and Cape Farewell, Greenland, cannot be estimated at less than 7000 miles in extent, although scarcely anywhere exceeding 150 miles inland from the coast. This explains the curious fact that the social organisation of the Indian tribes in families, gentes, phratries, confederacies, and nations can nowhere be detected amongst the Eskimo, unless to it is to be attributed a certain restriction in the choice of a wife, and an obligation to lend each other mutual aid, universally recognised amongst all branches of the race. Even the general distribution into tribes, assumed by most writers, appears to be quite groundless, and the final syllable, *mūt*, *mīūt*, of the so-called tribal names, meaning "dweller," "inhabitant of," shows that they are purely topographical terms without any ethnical significance whatsoever. Thus, Angmagasalingmūt, Mahlemūt, Aglemūt = inhabitants of the *Angmagasalit*, *Mahle*, *Agle* districts, and so on; so much so, that a family migrating from one of these districts to another changes its name accordingly. Hence Dr. Rink considers it sufficient for all practical purposes to class the whole race into the following seven geographical groups:—(1) South Alaskan; (2) North Alaskan; (3) Mackenzie; (4) Central (Baffin Land, &c.); (5) Labrador; (6 and 7) West and East Greenland. Between these various groups there certainly exist differences, by which they may often be readily distinguished; but these are mainly of a social and linguistic, and to a less extent of a physical character; and such is the great uniformity even in the structure of the Eskimo tongue, that an East Greenlander and an Alaskan, if fortuitously thrown together, would soon begin to understand one another. It is noteworthy that in Greenland, where the language has been most carefully studied, greater differences are observed between the eastern and western than between the northern and southern dialects—a circumstance doubtless due to the different routes followed by the two streams of immigration from the central region. Compared with the West Greenland dialect, taken as the written standard, the Labrador is found to contain 15, the Central 20, the Mackenzie 31, and the Alaskan 53 per cent. of different root-words—relations which correspond remarkably well with the conclusions arrived at, on other grounds, regarding the general migratory movement from Alaska, the assumed cradle of the race.

But here an important exception is formed by the Aleutian Islanders, who are treated by Dr. Rink as a branch of the Eskimo family, but whose language diverges profoundly from, or rather shows no perceptible affinity at all to, the Eskimo. The old question respecting the ethnical affinities of the Aleutians is thus again raised, but not further discussed by our author. To say that they must be regarded as "ein abnormer Seitenzweig," merely avoids the difficulty, while perhaps obscuring or misstating the true relations altogether. For these islanders should possibly be regarded, not as "an abnormal offshoot," but as the original stock from which the Eskimos themselves have diverged. It is remarkable that in his new work on "Alaska and the Seal Islands" Henry W. Elliott discovers a striking resemblance between the Aleutians and the Japanese. They constantly remind him of "Japanese faces and forms in another costume," so much so that in his opinion they form "a perfect link of gradation," not between the Eskimo and Red Man, nor between the Eskimo and Asiatic hyperboreans, but "between the Japanese and Eskimo" (p. 173). Mr. Elliott may have here unconsciously hit upon the solution of a very interesting ethnological problem, for in his "Classification of the Varieties of the Human Species" (*Journal of the Anthropological Institute*, May 1885), Prof. Flower also connects the Eskimo with the Japanese:—"Every special characteristic which distinguishes a Japanese from the average of mankind is seen in

the Eskimo in an exaggerated degree, so that there can be no doubt about their being derived from the same stock. It has also been shown that these special characteristics gradually increase from west to east, and are seen in their greatest perfection in the inhabitants of Greenland, at all events in those where no crossings with the Danes have taken place."

The Aleutians would thus help to bridge over the somewhat abrupt gap still undoubtedly separating the Eskimo and Japanese groups. At the same time this view suggests a primeval line of migration from Japan through the Kurile Islands and Kamchatka to the Aleutian chain and Alaska, which again presents other difficulties of a somewhat formidable character. In the first place, the Japanese appear to be themselves only comparatively recent intruders in Nippon, whose primitive inhabitants were the Ainos, a people of totally different physical type. Hence it is not easy to understand how they could have thrown off an easterly branch, which has had time to develop into the Eskimo, probably the most specialised of all existing races. In the second place, in his "Tales and Traditions of the Eskimo," Dr. Rink himself advances some solid reasons for bringing the Eskimo, not from Asia at all, or at least not in the first instance, but from the interior of the North American continent. He holds in fact, with some other ethnologists, that they were originally inlanders, who, under pressure from the American Indians, gradually advanced along the course of the Yukon, Mackenzie, and other great rivers, to their present homes on the Bering Sea and Frozen Ocean. But a discussion of these contradictory theories, for which a solution may yet be found, must be deferred to another occasion. Meantime enough has probably been said to show the highly suggestive character of the paper under review.

A. H. KEANE

SCIENTIFIC SERIALS

L'Astronomie: Revue mensuelle d'Astronomie populaire, de Météorologie, et de Physique du Globe, January 1887.—We have received the January number of the above periodical, edited by Camille Flammarion. M. Flammarion has done a great work in popularising astronomy in France, and the success which has attended this review—for it is entering on its sixth year—proves how widespread an interest is now taken in the science in that country. The present number contains an "Annuaire astronomique pour 1887," by the editor, a series of descriptive notes of a general character on the principal objects of astronomical observation for the current year, the sun, moon, eclipses, occultations, and the planets. M. Daubrée follows with a paper on some recent meteorites. M. Flammarion gives an account of the storms of October 16 and December 8, and of the general principles of weather prophecy. The notes chiefly relate to the two comets of the season, those of Barnard and Finlay, three diagrams being given of the first, showing the position and character of the two tails, and one of the second. A sort of general observing ephemeris for the month January 15 to February 15, of a popular rather than of a scientific character, concludes the number. M. Flammarion and his co-workers frequently affect a somewhat magniloquent and sensational style, and deal principally with the more popular, easy, and interesting aspects of astronomy; the wonders of our own globe, earthquakes, volcanoes, &c., receive much attention, so that the field embraced is not confined to pure astronomy alone. But after every allowance is made and every drawback admitted, *L'Astronomie* has done much good in circulating astronomical information and in arousing and fostering scientific tastes, and it must be confessed that for an astronomical journal containing forty well-printed imperial octavo pages and, as in this case, more than thirty illustrations, to command a remunerative circulation at the price of a franc a number is highly creditable alike to editor, to publishers, and to the public which supports it. It may well be doubted whether such an enterprise would meet with the same success either here or in America.

Bulletin de l'Académie des Sciences de St. Pétersbourg, tome xxx., No. 4.—The appearance of Encke's comet in 1885 compared with its previous appearances, by O. Backlund. The paper is the first of a series, and contains, besides the numerical data of the observations made in 1885, an inquiry into the disturbances due to the attraction of the earth. The summer parallax of the earth is taken to be $8''\cdot80$, and the elements of the comet are determined accordingly.—On the formation of buds among the Phanerogams, by A. Famintzin.—The period of the

rotation of the sun, according to the magnetic disturbances, as observed at Pawlowsk, by P. A. Müller. The average value of $25\cdot66$ is deduced from observations made from August 1, 1882, to August 31, 1883.—Photography applied to astronomy; abstract of a lecture by Otto Struve.—On several new Trilobites and kindred forms from East Siberia, by Fr. Schmidt. The following species (nearly all new) are described, with plates:—From the Cambrian, on the Vilui River, *Anomocare pawlowskii* and *Liostracus (?) maydeli*; from the Cambrian on the Olenek, *Agnostus caekanowskii*; from the Lower Silurian of the Middle Tunguska, *Phacops lopatini* and *P. sibiricus*; from the Devonian limestone at Krasnoyarsk, *Proetus slatkovskii*, *Cyphasps sibirica*; *Eurypterus (?) caekanowskii*, and *E. punctatus* from the Devonian on the Angara at Padun.—A new form of *Opalina (spiculata)*, by Warpachowsky.—On a new form of *Otomela (bopdanovi)*, by V. Bianchi.—Remarkable hail at Bobruisk, by H. Wild (with plates). On November 28, 1885, with an absolutely clear sky, not a cloud being visible, hail fell for five minutes. The fall was quite local, and did not extend farther than five miles from Bobruisk. Many pieces were like broken pieces of ice, others apple-shaped, with conical depressions at the poles.—On the electromotory difference and the polarisation of electrodes on telegraphic lines, by P. Müller.

SOCIETIES AND ACADEMIES

LONDON

Royal Society, January 13.—"On the Crimson Line of Phosphorescent Alumina." By William Crookes, F.R.S., V.P.C.S.

In a paper which I had the honour of communicating to the Royal Society in March 1879 (Phil. Trans., Part 2, 1879, pp. 660, 661), I described the phosphorescence of alumina and its various forms when under the influence of the electrical discharge *in vacuo*, in the following words:—"Next to the diamond, alumina in the form of ruby is perhaps the most strikingly phosphorescent stone I have examined. It glows with a rich full red; and a remarkable feature is that it is of little consequence what degree of colour the earth or stone possesses naturally, the colour of the phosphorescence is nearly the same in all cases; chemically precipitated amorphous alumina, rubies of a pale reddish yellow, and gems of the prized 'pigeon's blood' colour, glowing alike in the vacuum, thus corroborating E. Becquerel's (*Annales de Chimie et de Physique*, vol. lviii. 1859, p. 50) results on the action of light on alumina and its compounds in the phosphroscope. . . . The appearance of the alumina glow in the spectroscope is remarkable. There is a faint continuous spectrum ending in the red somewhere near the line B; then a black space, and next an intensely brilliant and sharp red line to which nearly the whole of the intensity of the coloured glow is due. . . . This line coincides with the one described by E. Becquerel as being the most brilliant of the lines in the spectrum of the light of alumina, in its various forms, when glowing in the phosphroscope."

In the *Comptes rendus* for December 6 last (vol. cii. p. 1107) appears a brief note by M. de Boisbaudran, in which he announces, "to that date, that alumina, calcined and submitted to the electrical discharge in a vacuum, has not given him a trace of red fluorescence. This fluorescence, as well as its special spectrum, shows itself brilliantly when the alumina contains 1/100 and even 1/1100 of Cr_2O_3 . With the 1/10,000 part of Cr_2O_3 we still obtain very visible rose colour. . . . From these observations the presence of chromium appears to be indispensable to the production of the red fluorescence of alumina."

This statement being opposed to all my experience, I immediately instituted experiments with a view, if possible, to clear up the mystery. I started with aluminium sulphate which I knew to be tolerably pure, and in which ordinary tests failed to detect chromium. On ignition and testing in the usual manner in a radiant-matter tube the alumina line was brightly visible in the spectrum of the emitted light. Different portions of this aluminium sulphate were now purified by various processes for the separation of chromium. All gave as a result the absence of this impurity. The most trustworthy process being that devised by Wöhler ("Select Methods in Chemical Analysis," second edition, p. 124), I used it to purify the bulk. The salt was dissolved in water, and excess of caustic potash added till the precipitate first formed re-dissolved. Chlorine was now passed through till no

more precipitate fell down and the liquid retained a strong odour of chlorine. The whole of the chromium would now be in solution, whilst the alumina would be in the precipitate. The alumina was filtered off, well washed, and a portion tested in the radiant-matter tube. It gave as good an alumina spectrum as did the original sulphate; the crimson line being very prominent.

The alumina thus purified was a second time dissolved in caustic potash and submitted to the chlorine purification. Again in the radiant-matter tube the alumina gave its characteristic crimson line spectrum.

Many other experiments are given, and the paper concludes as follows:—

These experiments are perhaps too few to permit any important inference being drawn from them. There seems, however, to be four possible explanations of the phenomena observed:—

(1) The crimson line is due to alumina, but it is capable of being suppressed by an accompanying earth which concentrates towards one end of the fractionations.

(2) The crimson line is not due to alumina, but is due to the presence of an accompanying earth concentrating towards the other end of the fractionations.

(3) The crimson line belongs to alumina, but its full development requires certain precautions to be observed in the time and intensity of ignition, degree of exhaustion, or its absolute freedom from alkaline and other bodies carried down by precipitated alumina, and difficult to remove by washing; experience not having yet shown which of these precautions are essential to the full development of the crimson line and which are unessential.

(4) The earth alumina is a compound molecule, one of its constituent molecules giving the crimson line. According to this hypothesis alumina would be analogous to yttria.

Zoological Society, January 18.—Prof. W. H. Flower, F.R.S., President, in the chair.—The Secretary read a report on the additions that had been made to the Society's Menagerie during the month of December 1886, and called attention to a young male of the true Zebra (*Equus zebra*), purchased December 11; and to a young male Indian Rhinoceros, presented by H.H. the Maharajah of Cooch Behar, through the kind intervention of Dr. B. Simpson, and received December 25.—Mr. F. W. Styan exhibited and made remarks on a series of Chinese birds' eggs which he had collected at Kiukiang and Shanghai.—Mr. Howard Saunders exhibited and read some notes on a skin of the Mediterranean Black-headed Gull (*Larus melanocephalus*), killed on Breydon Water, near Great Yarmouth, and sent for exhibition by Mr. G. Smith, of that town. This was stated to be the first absolutely authentic occurrence of this southern species on the British coasts.—Mr. Selater exhibited and made some remarks on an example of a rare Amazon Parrot (*Chrysotis bodini*) from British Guiana.—Various other specimens were exhibited, and papers read.

EDINBURGH

Royal Society, January 17.—Sheriff Irvine, Vice-President, in the chair.—Mr. John Murray read a paper on the total rainfall of the globe, and its relation to the discharge of rivers. 2243 cubic miles of rain fall annually on areas with inland drainage. Such areas extend to 11,486,350 square miles. The land draining directly to the ocean has an area of 44,211,000 square miles. If from this quantity we subtract all areas having less than 10 inches of annual rainfall, we get 38,829,750 square miles. The mean discharge from this area into the ocean is 5569 cubic miles annually. The total weight of substances carried by this means to the ocean is rather more than 5,000,000,000 tons each year.—Mr. W. Durham read a paper on chemical affinity and solution.—The fourth part of a paper on thermometer-screens was communicated by Mr. John Aitken.—Prof. Armstrong read a paper by Mr. A. C. Elliot, containing an extension and improvement of Rankine's formula for the pressure of earth on a retaining wall.—Prof. Tait communicated the third part of his paper on the foundations of the kinetic theory of gases. In the first division of this part the author discusses the modifications which are introduced into his previous formulæ by the consideration of the effects of molecular attraction of small range, but great intensity, on the behaviour of a group of hard, smooth, impinging spheres. In the second division he makes the assumption that the spheres are not perfectly hard, but possess a definite coefficient of restitution. He then en-

deavours to make an approximation to the conditions of the liquid state by considering the action of spheres whose relative speed of approach is such that, after impact, they are unable to pass out of the range of molecular attraction in consequence of the loss of translational energy by impact.

DUBLIN

Royal Society, December 15, 1886.—The physical properties of manganese steel, by Prof. W. F. Barrett. The author pointed out that Mr. J. T. Bottomley had sent a brief note on the feebly-magnetic character of manganese steel to the Aberdeen meeting of the British Association, and had kindly furnished him with a specimen of this steel, and the name of the makers and patentees, Messrs. Hadfield and Co., of Sheffield. The steel contains 12 to 14 per cent. of manganese. Through Messrs. Hadfield, the author had obtained wire drawn from manganese steel, a process that first presented great difficulties, but was ultimately accomplished with ease by heating the steel to whiteness, and quenching in cold water after a reduction through every two sizes had been drawn. Sudden cooling softens this steel; slow cooling hardens it. A No. 19 S.W.G. wire (diameter 0.98 millimetre) was thus obtained of two kinds—hard and soft; the density was 7.808. The electric conductivity was found by Prof. Barrett to be very low. The No. 19 wire had a resistance of about an ohm per metre, the exact specific resistance in C.G.S. units being 77,000 for 1 cubic centimetre; ordinary iron is only 9800, and German silver 21,170 in the same units; so that some use might be made of manganese steel wire for resistance-coils in electric lighting. The variation of resistance with temperature is now being examined. The magnetic character of this steel was then carefully tested by the author. Mr. Bottomley found the intensity of magnetisation of this steel, after submitting it to the most powerful magnetising force, was 2.55 in C.G.S. units, or the magnetisation per gramme was 0.013 in C.G.S. Ordinary steel gives a number varying from 40 to 90, and even 100, C.G.S. units per gramme. So that, if ordinary steel of average quality be 100,000, manganese steel is 20. This represents the permanent magnetism. Prof. Barrett, by different methods, has determined the susceptibility—that is, the induced magnetisation—in a uniform field. Compared with iron as 100,000, manganese steel was found to be 300. In fact, it is very wonderful, judging by muscular sense, to find no sensible force required to move this steel, even in the most powerful magnetic field that could be obtained. Hence, as the author suggests, the use of manganese steel for the bed plates of dynamos and the plating of iron vessels is obvious. Ships built of such steel would have no sensible deviation of the compass. As excellent castings can be obtained from this steel, it ought to have many applications from its extreme hardness, enormous tenacity, and feebly-magnetic character. Dr. Hopkinson's important memoir on the magnetisation of iron contains a measurement of the magnetic susceptibility of manganese steel, of which Prof. Barrett was unaware until his paper had been written. Though Dr. Hopkinson's method of determination was wholly different, the ratio of the susceptibility of iron to manganese steel which he obtained is fairly accordant with the number obtained by the author, the composition of the specimen being the same in both cases. As regards the tenacity of manganese steel, the author had found the hard wire had the extraordinary tenacity of 110 tons per square inch, or 173.5 kilogrammes per square millimetre—a number confirmed by independent tests which the chief engineer of the Irish Great Southern and Western Railway Works had kindly made for Prof. Barrett. The tenacity of ordinary steel wire is from 80 to 100 kilogrammes per square millimetre, the best pianoforte steel wire alone showing a higher tenacity than the manganese steel wire. The soft manganese steel wire had a tenacity of only 48 tons per square inch, with an elongation of nearly 20 per cent. The modulus of elasticity was also determined by the author by direct stretching. It was found to be lower than wrought iron, the mean number for the hard manganese wire being 16,800 kilogrammes per square millimetre, the soft manganese wire having a still lower modulus. The modulus for ordinary steel wire is 18,810, and for iron wire 18,610 kilogrammes per square millimetre; so that, though hard manganese steel has an enormous tenacity, it "gives" more than steel under sudden stress, recovering itself, of course, if the limits of elasticity are not passed. Obviously this is a most useful property for many purposes to which the steel may be applied. Further experiments on this interesting material are in progress in the Physical Laboratory of the Royal College of Science.

PARIS

Academy of Sciences, January 17.—M. Gosselin, President, in the chair.—Obituary notices of M. Paul Bert on the occasion of his obsequies at Auxerre, by M. Janssen in the name of the Academy of Sciences, and by M. A. Chauveau on behalf of the Biological Society.—Observations of the minor planets made with the large meridian instrument of the Paris Observatory during the third quarter of the year 1886, communicated by M. Mouchez. Comparative observations are here tabulated for Electra, Altheia, Olympia, Juno, Pallas, Ceres, and several other minor planets. Those for the three last mentioned are referred to the ephemerides of the "Nautical Almanac," all the others to those of the "Berliner Jahrbuch." The observations were taken by MM. F. Boquet, O. Callandreaux, and P. Puiseux.—Study of the horizontal flexion of the telescope of the Bischoffsheim meridian-circle of the Paris Observatory, by MM. Lœwy, Leveau, and Henri Renan.—On the solar statistics of the year 1886, by M. R. Wolf.—Letter addressed to the Academy by M. Em. Barbier, thanking it for the Francœur Prize recently awarded to him, and submitting a means by which he has succeeded in converting an ordinary watch into a repeater. A process is also explained by which a person both deaf and blind may tell the time by this repeater.—On the accelerations of the points of an invariable system in motion, by M. Ph. Gilbert. Two cases are considered: (1) that of a solid revolving round a fixed point, O; (2) that of a free solid body.—On the laws determining the absorption of light in crystals, and on a new method enabling the observer to distinguish in a crystal certain absorption-bands belonging to different bodies, by M. Henri Becquerel. His researches in this branch of physics have led the author to several important conclusions here specified on the absorption of light in crystals. He finds generally that in different crystals the characters of the phenomena of absorption differ considerably from those that one might expect to observe, regard being had to the optical properties of the crystal.—Heat of formation of some alcoholates of soda, by M. de Forcrand. Having already determined the heat of formation of the methylate and ethylate of soda, the author passes here to the study of the alcoholates of soda formed by the propylic, isobutylic, and amylic alcohols.—On some combinations of the bioxide of tin, by M. A. Ditte. Sulphuric acid is known to readily dissolve the hydrates of the bioxide of tin derived from various sources, yielding a liquor soluble in water and alcohol. Here the author studies the products of this reaction, which have not yet attracted the attention of chemists.—Action of some metalloids on the nitrates of silver and copper in solution, by M. J. B. Senderens. The author deals here with powdered selenium, tellurium, sulphur, arsenic, phosphorus, and bromium.—Note on the composition of the grain of starch, by M. Em. Bourquelot. From his researches the author concludes that the grain of starch is formed neither of one nor of two chemical species (granulose and amylose) as has been hitherto supposed, but of a larger number of hydrates of carbon.—On the plastidogene body, or pretended heart of the Echinoderms, by M. Edmond Perrier.—On some new parasites of the Daphniidae, by M. R. Moniez.—On some Crustacea, parasites of the Phallusia, by M. Paul Gourret.—On the removal of Lamarck's Herbarium to the Museum of Natural History, by M. Ed. Bureau. After remaining for some fifty years in the University of Rostock, this famous historical collection, containing over 10,000 specimens in good condition, has just been purchased and transferred to the Paris Natural History Museum. The tickets, descriptions, and other accompanying documents are all in the handwriting of the illustrious naturalist.—On the genus *Plesiadapis*, a fossil mammal of the Lower Eocene from the neighbourhood of Rheims, by M. Lemoine. Various remains are described by means of which the author determines two sub-genera of the genus *Plesiadapis* (Gervais), presenting lemurian characters with a marsupial facies.—Note on giovanite, a new cosmic rock, by M. Stanislas Meunier.—On the deterioration of vaccine, by M. P. Pourquier. An experiment is described showing the deterioration of this virus, with suggestions on a means of preventing its attenuation.—Note on the copper detected in wines from vineyards treated with the sulphate of copper against mildew, by M. A. Andouard. An analysis of several samples shows that the quantity of copper detected in such wines is infinitesimal, and in no way injurious to health.

STOCKHOLM

Royal Academy of Sciences, January 12.—Prof. S. Lovén gave an account of the researches effected at the zoological station of the Academy at Christineberg, in the province of Bohus, during last summer.—Prof. Rubenson gave an account of a posthumous memoir by the late Col.-Lieut. Klercker on the so-called anomalous dispersion.—Determination of some physical constants of germanium and titanium, by Profs. Nilsson and Petterson.—On experiments on the electrical conducting power of the air, by Prof. Edlund.—On bryological researches in the province of Småland, by Herr R. Toiff.—Annotations on the vegetation in the west of Herjedalen, particularly as to the occurrence of the Hymenomycetæ within different formations of the vegetation, by Dr. E. Henning.—A comparative research on the monosulphon-combinations of benzol and toluol, by Dr. Weibull.—Construction of the curves of the fourth order and second kind by means of rules and compasses, by Prof. Björling.—On the pleochroism and light-absorption in epidote from Sulzbachthal, by Herr W. Ramsay.—On the amido-naphthaline-sulphon acid, by Herr S. Forsling.—On the sponges of the province of Bohus, by Dr. Fristedt.

BOOKS AND PAMPHLETS RECEIVED

Travaux et Mémoires du Bureau International des Poids et Mesures, tome v. (Gauthier-Villars, Paris).—Lease and Release, by Sea Verdure (Chiswick Press).—Folk-Lore Journal, vol. v. part 1 (E. Stock).—Notes from the Leyden Museum, vol. ix. No. 1 (Brill, Leyden).—The Auk, vol. iv. No. 1 (New York).—Palæolithic Man in North-West Middlesex: J. A. Brown (Macmillan).—Zeitschrift für Wissenschaftliche Zoologie, 44. Band. 1. Heft (Engelmann, Leipzig).—Proceedings of the Biological Society of Washington, vol. iii. (Washington).—Spolia Atlantica, 1885-86 (Dreyer, Copenhagen).—Botanische Jahrbücher für Systematik, Pflanzengeschichte, und Pflanzengeographie, Achter Band, ii. Heft (Engelmann, Leipzig).—Revue d'Anthropologie, 1887, No. 1.—Supplementary Catalogue to the Newcastle-on-Tyne Public Libraries: W. J. Haggerston.—Report of the Superintendent of the U.S. Naval Observatory for the Year ending June 30, 1886 (Washington).—Sulla Velocità del Suono nei Liquidi: Prof. T. Martini (Venezia).—Systematic Catalogue of Species of Vertebrata: E. D. Cope.—The Phylogeny of the Camelidae: E. D. Cope.—Vertebrata of the Swift Current Creek Region of the Cypress Hills: E. D. Cope.—Monthly Weather Report, July and August 1886.—Economic Problem of the Unemployed: W. Westgarth (Mathieson).

CONTENTS

	PAGE
Scientific Federation	289
Supernormal Psychology. By Prof. C. Lloyd Morgan	290
Elementary Results in Pure Mathematics	292
Commercial Organic Analysis. By Dr. C. R. Alder Wright	293
Our Book Shelf:—	
Walker's "Practical Dynamo-Building for Amateurs"	294
Dawson's "Hand-book of Zoology"	295
Nipher's "Theory of Magnetic Measurements"	295
Marvin's "Coming Deluge of Russian Petroleum"	295
Letters to the Editor:—	
The Cambridge Cholera Fungus.—Dr. E. Klein, F.R.S.	295
The Coal-Dust Theory.—W. Galloway	296
Barnard's Comet at Perihelion.—Prof. A. Riccò	296
Magnetic Theory.—Rev. H. W. Watson	296
Sounding a Crater, Fusion-Points, Pyrometers, and Seismometers.—W. Worby Beaumont	296
Folkestone Gault.—C. E. De Rance	296
Wolves, Mares, and Foals.—George Maw	297
The Sun's Heat. By Sir William Thomson, F.R.S.	297
Protoplasm. By Prof. H. Marshall Ward	300
On the Explosion of Meteorites	303
Sir Joseph Whitworth	304
Notes	305
Our Astronomical Column:—	
Three New Comets	307
New Variables	307
The Washington Observatory	308
Astronomical Phenomena for the Week 1887	
January 30—February 5	308
Geographical Notes	308
The Eskimo. By Prof. A. H. Keane	309
Scientific Serials	310
Societies and Academies	310
Books and Pamphlets Received	312

THURSDAY, FEBRUARY 3, 1887

HISTORY OF THE THEORY OF ELASTICITY

History of the Theory of Elasticity and of the Strength of Materials, from Galilei to the Present Time. By the late Isaac Todhunter, D.Sc., F.R.S. Edited and completed for the Syndics of the University Press by Karl Pearson, M.A., Professor of Applied Mathematics, University College, London. Vol. I. Galilei to Saint-Venant, 1639-1850. (Cambridge: at the University Press, 1886.)

THIS work was projected by the late Dr. Todhunter on the same lines as his well-known Histories of the Theory of Probabilities, of the "Figure of the Earth," and of the "Calculus of Variations," and will doubtless equal them in usefulness to the mathematical student.

The first object of a writer in the preparation of such work would be to draw up as complete a bibliography as possible of all books and papers relating to the subject, arranged in chronological order. Afterwards, in reading these memoirs, he would make copious notes, extracts, and criticisms; and then, on reaching the end of this self-imposed task, he would find his materials for a book like the present ready to place in the printer's hands. Incidentally, enough material and ideas would accumulate to form an independent treatise on the subject. Such a task was undertaken by Dr. Todhunter on the History and Theory of Elasticity, from the standpoint of the mathematician, but he did not live, unfortunately, to complete it.

Prof. Karl Pearson explains in the preface the circumstances in which he undertook to edit and complete the work, and, from his own account, the labour thus evolved on him would have been sufficient to enable him to complete the "History" *ab initio*.

The present volume, like the previous "Histories," carries the subject and commentaries only to the year 1850, although Dr. Todhunter had analysed the chief mathematical memoirs from 1850 to 1870. The preparation of the second volume, to carry the history from 1850 to date, is a task from which Prof. Pearson appears to recoil, with some justification; but it is to be hoped that he will enlist in his service some of the junior elasticians mentioned in his preface, and, by the application of the modern principle of the subdivision of labour, carry this valuable work to its proper conclusion.

At the outset Prof. Pearson gives the palm to Galileo Galilei (1638) as the founder of the subject of elasticity and the strength of materials, while Dr. Todhunter asserts in § 18 that "the first work of genuine mathematical value on our subject is due to James Bernoulli . . . 1695." Galileo treated only the question of the breaking moment of a beam, or rather what we should call the *bending moment*, exactly as is done now in calculating the *stresses* of a structure, before proceeding to determine the consequent *strains* and deformations.

At this point the law enunciated by Hooke (1678) must intervene, which goes by his name, "Ut tensio, sic vis," originally published by him, in the fashion of those times, in an anagram, *ceiino sssttuu*. Stated in the modern form, this law asserts that

extension = pressure / stress = modulus of elasticity,
tension / compression = strain

Vol. XXXV.—No. 901

and is the law universally employed to connect mathematically the corresponding stresses and strains in an elastic substance, as pointed out by Saint-Venant [8].

When the stresses and strains are large enough for variations on Hooke's law to become observable, a fresh set of phenomena depending on the ductility and viscosity of the substance came into play, and the previous mathematical investigations no longer hold. Much of the confusion pointed out by Dr. Todhunter in the treatment of the subject by experimentalists is due to the fact that in experiments it has been usual to test the strength of structures to the breaking-point, and hence the use of the term *breaking* instead of *bending* moment. The modern experiments of Wöhler show that this point, at which ductility manifests itself, is much sooner reached than was formerly supposed; consequently, modern engineering practice is much less bold than formerly in large iron structures like bridges. For this reason, the diagrams of the frontispiece, though physically extremely interesting, cannot be considered to bear on the mathematical theory.

Returning again to the treatment of the subject by the mathematicians, we find a picturesque diagram given by Galileo (p. 2) of a beam built into an old wall and supporting a weight, the cross-grained character of the wood of the beam being carefully shown; so that it is not surprising that Galileo does not attempt any molecular theory to account for the flexure of the beam. This theory, supplied by Hooke's law, was applied by Mariotte, Leibnitz, De Lahire, and Varignon; but they neglect the compression of the fibres, and so place the neutral plane in the lower face of Galileo's beam. The true position of the neutral plane was assigned by James Bernoulli in 1695, who, in his investigation of the simplest case of the bent beam, was led to the consideration of the curve called the "elastica." This "elastica" curve speedily attracted the attention of the great Euler (1744), and must be considered to have directed his attention to the elliptic integrals. Probably the extraordinary divination which led Euler to the formula connecting the sum of two elliptic integrals, thus giving the fundamental theorem of the addition equation of elliptic functions, was due to mechanical considerations concerning the "elastica" curve; a good illustration of the general principle that the pure mathematician will find the best materials for his work in the problems presented to him by natural and physical questions. The result obtained by Euler for the thrust at which a straight column begins to bend, when the corresponding "elastica" differs from a straight line very slightly in a curve of sines, is of the utmost importance to the architect and engineer; and, as Prof. Kennedy can testify, is employed with the greatest confidence in the design of the highest columns and pillars.

It is interesting to find that the complete treatment of the problem of lateral vibrations of elastic bars is also due to Euler, though the analytical difficulties of the *period equations* seem to have puzzled him. If we employ the modern notation of the *hyperbolic* functions, we shall find his period equations all reduced to the form—

$$\cos \omega \cosh \omega = \pm 1,$$

or, $\tanh \omega = \pm \sin \omega;$

and this again is equivalent to

$$\tanh \frac{1}{2} \omega = \pm \tan \frac{1}{2} \omega, \text{ or } \mp \cot \frac{1}{2} \omega,$$

whence a graphical determination of the values of α is easily inferred (pp. 50, 51, footnote).

Another interesting paper due to Euler is "De altitudine columnarum sub proprio pondere corruentium" (1778), investigating the height at which a mast or tree will begin to bend under its own weight. To this paper he might well have prefixed the old German proverb, quoted by Goethe in "Wahrheit und Dichtung":—"Es ist dafür gesorgt, dass die Bäume nicht in dem Himmel wachsen." We know now that the functions of Bessel are required for the complete analytical solution of this question, though the *Theorema maxime memorabile* enunciated by Euler, "Maxima altitudo, qua columnæ cylindricæ ex eadem materia confectæ, proprium pondus etiamnunc sustinere valent, tenet rationem subtriplicatam amplitudinis," is interesting as one of the first applications of the principle of mechanical similitude, showing why the proportions of the giant of the forest are stunted compared with those of the young tree, and also why it is hopeless to attempt the problem of human flight while g is 32.

Lagrange considered the same subject in "Sur la figure des colonnes" (1770), examining and disproving the dictum of Vitruvius that the *renflement* of a column was necessary for strength: the dictum can hardly be called an architectural fallacy, as the *renflement* corrects the tendency, due to *irradiation*, of a perfectly cylindrical column to appear attenuated in the middle; for a similar reason it is necessary to slightly blunt the neighbourhood of the point of a Gothic spire to avoid the appearance of concavity.

Coulomb, a well-known name to electricians, is mentioned by Saint-Venant as giving about this time (1780), in "Remarques sur la rupture des corps," the true position of the neutral line of a beam, although it is asserted by Dr. Todhunter that the ancient erroneous idea prevailed into the present century.

In Chapter II. the work of Young, Gregory, Eytelwein, Plana, Dupin, Belli, Binet, Biot, Rennie, Barlow, Tredgold, Fourier, Nobili, Bordoni, Hodgkinson, and others is analysed. Of these the English writers, who generally were experimentalists as well as theorists, are severely handled by Dr. Todhunter for their heresies on the neutral axis. Considering that the neutral axis is a mathematical fiction, depending on an ignorance of the shearing stress, and the consequent warping of the normal sections of a beam, this treatment of Dr. Todhunter is too severe, compared with the leniency with which he views the metaphysical speculations of the pure theorists. These experimentalists were trusted in their advice on important constructions, and took care their formulæ erred on the right side of strength.

To Navier (1821) we are first indebted for the general mathematical equations of the equilibrium and vibrations of an elastic solid, to be satisfied in the interior and at the surface, and henceforth the researches of mathematicians take a bolder flight from the treatment of the simple beam of former investigators.

Mlle. Sophie Germain's "Recherches sur la théorie des surfaces élastiques" (1821) appears to afford Dr. Todhunter gratification in showing that sex can make itself apparent even in mathematics. However, it is dangerous to argue from this instance, as hardly any mathematician has yet written on elastic surfaces without falling into error in the

boundary conditions, and the subject is even now not yet certainly settled.

The vibration of elastic surfaces is important in its bearing on acoustics and music, and received about this time experimental and theoretical treatment from Chladni, Strehlke, Pagani, and Savart.

Chapters IV. and V. give an account of the treatment of the subject by the celebrated mathematicians Poisson and Cauchy, who practically exhausted the soluble problems, if we except the torsion questions considered by Saint-Venant. Poisson's results are generally expressed by means of definite integrals, most of which we see now can be classified as Bessel's functions. Both Poisson and Cauchy appear to have considered the subject of elasticity principally in its bearing on the new theory of physical optics, then receiving such important experimental and theoretical treatment at the hands of Fresnel.

Henceforth the theory receives development at the hands of so many writers that it is possible only to specify the honoured names of Gerstner, Green, McCullagh, Poncelet, and Maxwell as having contributed important advance to the subject.

Lamé's "Theory of Elasticity," carefully analysed in Chapter VII., still remains a standard text-book, in conjunction with the treatises of F. Neumann and Clebsch.

The volume concludes with an account of Saint-Venant's researches before 1850, the subsequent work to be recorded in the second volume. Saint-Venant is the name most honoured by practical elasticians and engineers, inasmuch as he has developed his theories from the definite practical problems presented by the large and daring constructions in iron and steel which mark the middle of this century.

In the appendix Mr. Pearson has carefully analysed the conflicting notations of different writers, and proposed a very convenient terminology and notation, which would save great trouble if universally adopted. He has also given an account of experiments carried out by Prof. Kennedy in his mechanical laboratory, which have an important bearing on the limitations of the truth of Hooke's law, or, in the language of elasticity, the constancy of the ratio of stress to corresponding strain.

The present volume is an indispensable hand-book reference for the mathematician and the engineer, and the editing and printing must be considered a very fitting tribute to the wonderful industry and application of the projector, the late Dr. Todhunter.

A. G. GREENHILL

THE ENCYCLOPÆDIA BRITANNICA

The Encyclopædia Britannica. Vol. XX. Pru—Ros. Vol. XXI. Rot—Sia. (Edinburgh: A. and C. Black, 1886)

THE leading scientific articles in these two volumes are mainly biological. In Vol. XX. Prof. A. Newton contributes the articles on the various important groups of birds; and in those on the Quail, Screamer, Secretary Bird, Seriema or Cariama, it is truly surprising to find many facts condensed into so small a compass. Mr. T. Newton's article on Pterodactyles gives us the newest information on this strange group of fossil reptiles. In the article on Reproduction only the broadest aspects of the phenomena attending it are glanced at. Mr. P. Geddes treating of the Animal, and Mr. S.

Vines of the Vegetable, group; though, as was to have been expected, the early phenomena in the two kingdoms are to some extent the same. The facts mentioned are well up to date, and both portions of this article are worthy of their authors. Animal reproduction is illustrated by a few useful woodcuts; but this help to the understanding of the text is wanting in the section on vegetable reproduction. Mr. Vines very correctly criticises Strasburger's idea that the cause of sexuality in cells is purely quantitative. In the article on Reptiles Dr. Günther finds himself on familiar ground, and in the forty pages placed at his disposal he gives a most excellent account of the history and literature of the group, and of the evolution of their classification, from Linnæus to Cope, followed by a brief record of some of the more important systematic works on reptiles, in which the need of a general work on the subject is pointed out. The principal faunistic works are alluded to, and then follow the systematic portions, the anatomy of the chief forms characteristic of the orders, and a paragraph about the distribution of reptiles in time and space. Prof. A. Gamgee, in an article on Respiration, dwells chiefly on the phenomena attending this function in mammals, the phenomena to be observed in all the other groups of the animal kingdom being scarcely even alluded to. The articles on the Rhinoceros and the Seal, by Mr. Flower, are quite models of encyclopædic articles, for in them we have just the information a general reader would require, and this of a thoroughly trustworthy kind. The same may be said of an article on Rhubarb, by Mr. E. W. Holmes.

The article on Rotifera, in Vol. XXI., by Prof. A. G. Bourne, was probably printed ere the finely illustrated monograph of this group by Gosse and Hudson had made its appearance, but the classification given is based on that of Hudson. The account of the general morphology and anatomy is well done, and in a few very pertinent remarks on their affinities the author concludes that, while the high development of the mastax, the specialised character of the lorica in many forms, the movable spines in Polyarthra, the limbs of Pedalion, and the lateral appendages in Asplanchna, the existence of a diminutive male, the formation of two varieties of ova—all point to a specialisation in the direction of the groups of the Mollusca, Arthropoda, and Chætopoda; yet such phenomena would not justify the definite association of the Rotifera in a single phylum with any of them. The phenomena of rotifers being desiccated, and then coming into active existence, are mentioned as if actually proved by exact experiment; but is this so? It certainly does not always succeed, as, no doubt, numerous observers have often noted: too frequently, from inattention, all the water will evaporate from a slide with rotifers; and so far, general experience proves, that if this evaporation be carried to desiccation, not all the drops of water in the world will set up the rotifers that were on such a slide into life again. No doubt it is quite different with their ova.

Mr. J. T. Cunningham contributes an interesting article on Salmonidæ, in which he presents a pretty full synopsis of most of the genera and of all the British species. The life-history of the British forms is given, and some account of the legislation on the subject of our fisheries. The salmon-disease is described. From whence the fresh salmon gets affected would seem to be an, as yet, unsettled pro-

blem. Might not one source be frog-spawn? After the tadpoles escape, the gelatinous nidus remaining will sometimes be found permeated with *Saprolegnia ferox*, with ripe oosporangia.

The next biological article of importance in the volume is on the Schizomycetes, by Prof. Marshall Ward, including within this term all those Schizophyta devoid of chlorophyll. The history of these forms, though dating only from 1860, has of late years made rapid progress, and the epitome of this history as here given is full of interest. Most judiciously, while selecting the facts from writings of scientific worth, the author ignores a lot of the rubbish that has appeared in print on the subject. The section on the morphology is very ably written, and the illustrative figures are excellent. Very thoroughly do we agree with the author, that to deny the existence of species in this group is to deny the existence of species altogether. No doubt, before they can be properly defined, the whole life-history of any one of these forms must be known; and equally certain is it that immense advance in a knowledge of the life-history of many of them has been made since the date of Cohn's brilliant researches. As to the important question, Are the Schizomycetes accompaniments only of disease, or have they any causal relation to the diseased condition? no decided answer is given, the discussion as to details being still an active one. The theory that, by the growth and development of certain forms under certain conditions, the medium in which these forms live may be so atomically altered that new and deadly ptomaines may arise, is not alluded to. To the references to authorities given it may be useful to add Just's *Botanischer Jahresbericht*, which year by year laboriously works out the immense literature of this subject.

Dr. Günther's article on Sharks is well illustrated, and well up to date. There is a capital figure of that most interesting and novel form, *Chlamydoselachus anguineus*, S. Garman, from Japan, of which but two specimens are known, one of these being in the British Museum. In reference to the economic use of these fish, allusion is made to the oil abstracted from the larger forms. We may mention that the oil from the basking shark is of considerable commercial value, and that in the case of the immense *Rhinodon typicus*, which abounds during certain seasons in the seas around the Seychelles Islands, the oil is of excellent quality, and there is little doubt would pay well for collecting, although owing to the differences in the respiratory functions, the difficulty in capturing large fishes is vastly greater than in capturing big mammals.

When we turn from the biological to the mathematical and physical sciences, we do not find such a great wealth of articles, but on the other hand some of them are of the highest order, the only fault about them being, perhaps, their shortness. Such are the articles on "Quaternions" and "Radiation," by Prof. Tait. Prof. Dittmar writes on sea-water, and Prof. Ewing on seismometers. Mr. Herbert Rix, the Assistant Secretary of the Royal Society, gives an account of the history and doings of it, which will be read with interest by many. The chemists have their fair share of interest in the volumes; prussic acid, pyrotechny, salts, being among the subjects treated of in all their aspects.

Midway between pure science and its applications, we find an important article on screws by Prof. Roland, while in the various applications of science there is a great wealth of admirable articles: railways, river engineering, roads and streets, shipbuilding, public health, are among the subjects of this nature treated of; and always, so far as we can judge, by the best man.

Of the contributions relating to geography, ethnography, and statistics in these volumes, one of the most important is Prince Krapotkine's part of the article "Russia," in which he presents a very lucid account of the leading facts connected with his subject. Like all other races, the Russians are, of course, to some extent a mixed race. In the course of their history they have taken in and assimilated a variety of Finnish and Turco-Finnish elements. The author, however, points out that, notwithstanding this process, the Slavonian type has maintained itself with remarkable persistency, Slavonian skulls ten and thirteen centuries old exhibiting the same anthropological features as are seen in those of our own day. This he accounts for chiefly by the fact that the Slavonians, down to a very late period, maintained gentile organisation and gentile marriage. Dealing with the circumstances of Russia at the present day, Prince Krapotkine says that much still remains to be done for the diffusion of the first elements of a sound education throughout the Empire, and that the endeavours of private persons in this field, and of the *zemstvos*, are for political reasons discouraged by the Government. The Government also does what it can to check the movement in favour of secondary schools where instruction would be based on the study of the natural sciences. It prefers classical gymnasiums. As every one knows, the natural sciences are much cultivated in Russia; and now the scientific societies of old and recognised standing have to compete with a group of new societies which have sprung up in connection with the Universities.

The geography and statistics of Prussia are dealt with by Mr. J. F. Muirhead. Although somewhat hampered by the fact that the physical features of Prussia had already been fully described under "Germany," Mr. Muirhead has brought together much valuable and interesting information both about the country and about the Prussian people. He has, of course, a good deal to say about the flourishing condition of education in Prussia. Of the recruits levied to serve in the army in 1882-83 the proportion of men unable to read or write was only 2 per cent., the rate varying from 975 per cent. in Posen to 0.03 in Schleswig-Holstein, where there was only one illiterate recruit among 3662. Mr. Muirhead contributes several other geographical articles—among them, the one on the Rhine, of which he thinks that probably the Tiber alone is of equal historical interest among European rivers. After a full account of the physical aspects of the river and of its relations to industry and trade, he shows how its whole valley was probably occupied at one time by Celtic tribes, and how they were gradually displaced by the advancing Teutons.

The topography and archæology of Rome have been intrusted to Mr. J. H. Middleton, whose thorough knowledge of his subject has enabled him to make the most of the limited space at his disposal. The article is devoted mainly to those buildings of which some remains still

exist. The plan of the Forum and nearly all the *cu* were measured and drawn by the author specially to illustrate this article.

Mr. George G. Chisholm gives a clear description of the physical features, with an adequate account of the agriculture, mineral wealth, and trade, of Roumania and Servia. He has also a good article on Sardinia. There is an excellent article on the St. Lawrence, by Sir Charles A. Hartley, who points out that the great prosperity and growth of Canada are owing to its unrivalled system of intercommunication, by canal and river, with the vast territories through which the St. Lawrence finds its way from the far-off regions of the Minnesota to the seaboard. The statistics of Scotland have been carefully done by Mr. T. F. Henderson, but the scientific part of the article "Scotland" is remarkable chiefly for Dr. Archibald Geikie's masterly sketch of the physical features of the country and his summary of the facts relating to its geological formations. The article on Siam, by Mr. Coutter, contains all the information that ordinary readers are likely to want about the physical characteristics and resources of the country, and about Siamese law, education, religion, and art.

It will be evident from what we have said, that although the "Encyclopædia" has already reached its twenty-first volume, there is no falling off either in the care or in the zeal of the editors. If all goes well, it is expected that the whole work will be completed in four more volumes; and we may certainly say that the work has been conducted in such an admirable manner that science will be a great gainer by it, and that it is a production of which everybody concerned may be justly proud.

A TREATISE ON CHEMISTRY

A Treatise on Chemistry. By Sir H. E. Roscoe, F.R.S. and C. Schorlemmer, F.R.S., Professors of Chemistry in the Victoria University, Owens College, Manchester. Vol. III. "The Chemistry of the Hydrocarbons and their Derivatives, or, Organic Chemistry." Part II (London and New York; Macmillan and Co., 1886.)

IN the present instalment of the organic section of this valuable work the authors begin the consideration of the so-called aromatic compounds—the members of the benzene series.

The attention of chemists had long been directed to a group of organic compounds remarkable for their richness in carbon, and apparently unconnected in any way with the ordinary "fatty compounds"—richer in hydrogen, and correspondingly poorer in carbon—with which organic chemistry chiefly busied itself. Many of the compounds of this anomalous class occurred in Nature as odoriferous principles; this physical property was made the basis of a rough classification, and the name "aromatic compounds," originally employed in its strict sense, was extended so as to embrace the whole class, thus including compounds destitute of aroma. Much was known, in more or less disjointed fashion, concerning these aromatic compounds; but no attempt had been made to solve the problem of their constitution until Kekulé, in 1865, proposed his well-known benzene formula. This formula has at no time, since it was first introduced, met with universal acceptance; and although, at the present day

most chemists employ it, they generally write it in an elliptical form, shirking or ignoring the difficulties which the fully-expanded formula too obviously suggests. But, in spite of these drawbacks, we may say, without exaggeration, that no formula ever exercised such an influence upon the progress of organic chemistry. Right or wrong, final or only provisional, the benzene formula grouped round it the scattered facts: each member of the mysterious aromatic series found its proper place and appeared in its proper light; cases of isomerism were predicted, even to their exact number; and the synthesis of important natural compounds, so high in the scale of complexity as alizarin and indigo, was rendered possible. The obscure corner is now a vast field, cultivated alike by the scientific and by the practical chemist, and far exceeding in extent the whole of the rest of organic chemistry.

The present work opens with an account of the benzene theory. A very valuable feature in the mode of treatment is the way in which the historical method is employed. The much-enduring student of organic chemistry at the present day is generally loaded with facts; occasionally the teacher condescends to furnish him with reasons; but not one student in fifty has any idea of the historical genesis of the facts and reasons presented to him. The ordinary text-books do little or nothing to supply this want; the exhaustive records of facts, like Beilstein's "Handbuch,"¹ and the short text-books written for the student can neither of them, although for different reasons, spare the necessary space. Here the present work comes to our aid. Nothing could well be more instructive than the historical treatment of this very subject of the benzene theory as here given. The student is enabled to see how the views at present held have been evolved, step by step, from Kekulé's formula. And in this connection the earliest tentatives, however we may despise them now, are in their way as instructive as the latest and most carefully-considered deductions. Witness, for example, the historical tables which the authors give in illustration of "orientation in the aromatic series"—the determination of the position of the substituting atoms or groups in the derivatives of benzene. The reader can follow in detail the process by which errors of method or of experiment were gradually eliminated, until, ultimately, the present satisfactory condition of things was reached, in which the same problem, attacked by half a dozen independent methods, yields in every case the same result. The student who knows these things can give reasons for the faith that is in him, and he knows that, no matter how the theory itself may change, the relations worked out under the theory are permanent, and that when the new theory comes, these relations will find their places in it, differently expressed perhaps, but unchanged in their interdependence.

The descriptive portion of the work deals with benzene and its derivatives, using the latter term in its narrow sense, as excluding all derivatives which are homologous or derived from homologues. There are certain disadvantages in this arrangement; thus, it separates widely compounds which are closely related: toluene is not

treated of along with benzene, which it most closely resembles; the toluidines are separated from aniline, and so on. But no system of classification is perfect; and the authors, as practical teachers, have doubtless satisfactory reasons for adopting the foregoing arrangement.

There is little further to be said about the descriptive portion, the nature of which is sufficiently indicated by the above account of its scope. The information is very full. The interesting theoretical and historical discussions are continued throughout the volume, and impart to it a character of "readableness" rather unusual in a work of this nature. Finally, the student of technology will find the various manufacturing processes treated of in some detail.

OUR BOOK SHELF

Photography the Servant of Astronomy. By Edward S. Holden. (Reprinted from the *Overland Monthly*, November 1886.)

HALF a century ago the attention of astronomers was almost entirely confined to the study of the movements of the heavenly bodies; indeed, Bessel actually defined astronomy as consisting therein. But since then an entirely new department of astronomy has been developed, to which the name "Astro-physics" has been given, and this new department proceeds along three principal lines—spectroscopy, photometry, and photography. The great Observatory founded by the munificence of the late James Lick is to be chiefly engaged in the development of the third of these methods, though spectroscopy will also receive a large share of attention. Having therefore in view the chief purpose to which the great powers of his Observatory will be devoted, the Director of the Lick Observatory has here given a clear and concise account of the principal services which photography has rendered to astronomy in the past, and an analysis of those which may be expected from it in the future. A description of the facilities for photographic research possessed by the Lick Observatory completes this interesting and instructive paper. Prof. Holden mentions incidentally that Mr. Grubb's ingenious device for placing the observer in position for using the telescope, by raising or lowering the entire floor, will be adopted in the great dome of the Observatory.

Observations nouvelles sur le Tufeau de Cibly et sur le Crétacé supérieur du Hainaut. Par A. Rutot et E. Van den Broeck. (Liège: H. Vaillant-Carmanne, 1886.)

IN view of the stratigraphical gap that exists in this country between the Chalk with *Belemnites mucronata* and the Thanet Sands, the papers thus re-issued in a collected form have an interest considerably beyond the district with which they immediately deal. The value of passage-beds being that they blur over the hard-and-fast lines laid down by our earlier conceptions, it may seem ungrateful to define the exact upward limit of deposits such as those which close in the Danian series. The observations of the authors, however, go to show that the Tufeau de Cibly of the Mons basin, which has been hitherto referred to the Maestrichtian—a fact incorporated in ordinary textbook information—is in reality intimately connected with the Montian. A close examination of 3000 kilogrammes of the conglomerate that forms its base has yielded rolled *Thecidea* and Cretaceous Bryozoa; but the principal fauna, as indicated by casts of unrolled shells, is of distinctly Tertiary type, containing such representative forms as *Cerithium montense*, *Voluta elevata*, and *Turritella montensis*. The beds near St. Symphorien, correlated with

¹ *Handbuch* in German means, not a *hand-book*, but—*lucus a non lucendo*—an exhaustive treatise which in most cases it would be physically impossible to hold in the hand.

those of Cibly by MM. Cornet and Briart, are divided by the authors into the true Tufeau de Cibly, with its conglomeratic base, and the "Tufeau de St. Symphorien," with *Belemnitella mucronata*, *Thecidea* (*Thecidium*) *papillata*, &c., which is seen to rest, also with the intervention of a conglomerate, on the Senonian. The lower of these horizons is incontestably Maestrichtian; it remained to show that the Tufeau de Cibly, on the other hand, passes up continuously through the *Cerithium*-limestone of Cuesmes into the Calcaire de Mons. To outsiders, unfortunately, the evidence is not complete. The junctions in the field are still obscure, and even the lack of parallelism between the Tufeaux of Cibly and St. Symphorien is mainly based on palæontological arguments, both beds alike resting in places on the uppermost Senonian. The sharp distinction of the two faunas leaves, however, little room for doubt; and the alliance of the Cibly beds with the Montian is still further emphasised by the occurrence in them of large *Cerithia*, of which the authors record two new species, appropriately named *corneti* and *briarti*. It is probable, then, that when, by fortunate excavations in this phosphatic area, the necessary junctions become exposed, MM. Rutot and Van den Broeck may be congratulated on having added beyond recall some 20 or 30 feet to the Tertiary beds of Europe. The papers also include a revision of the classification of the Senonian of South-West Belgium. G. C.

LETTERS TO THE EDITOR

[The Editor does not hold himself responsible for opinions expressed by his correspondents. Neither can he undertake to return, or to correspond with the writers of, rejected manuscripts. No notice is taken of anonymous communications.]
[The Editor urgently requests correspondents to keep their letters as short as possible. The pressure on his space is so great that it is impossible otherwise to insure the appearance even of communications containing interesting and novel facts.]

On Two Jade-handled Brushes

SOME years ago, I purchased from Mr. Bryce-Wright, of London, two specimens of jade which I then presumed to be "brushes," the handle and sheath of each being of jade, of that faint greenish-gray so characteristic of the finest specimens of that mineral. I was not led to entertain any further opinion as to their true character until the appearance of a paragraph in *NATURE*, vol. xxviii. p. 207, being an extract from the *North China Herald*, respecting the foot-measures in China. I was particularly struck by the statement made that "in A.D. 274 a new measure exactly 9 inches in length was made the standard," and further "that the lengths of certain jade tubes used according to old regulations as standards" were employed as terms of comparison. It was further mentioned "that of the jade tubes above mentioned there were twelve, and these formed the basis for the measurement of liquids and solids four thousand years ago. . . . They are mentioned in the oldest Chinese documents, with the astrolabe, the cycle of 60 years, and several of the oldest constellations. It is likely that they will be found to be an importation from Babylon, and in that case the Chinese foot is based on a Babylonian measure of a span, and should be 9 inches in length."

This article led me to measure the lengths of the two jade instruments, which I found to be 9 inches, with some slight difference for one of them. I endeavoured to obtain further information as to the nature of these instruments and whence they came. Mr. Bryce-Wright could only tell me that to the best of his recollection he had procured them from the Chevalier von Siebold, son of Dr. von Siebold, and promised to make further inquiries. As I also learned that no such specimens exist in the British Museum, I was led to attach some importance to them in connection with their lengths. This was strengthened by an article which appeared in *NATURE*, vol. xxx. p. 565, "On the Connection between Chinese Music, Weights, and Measures," which seemed to confirm the statements made in the *North*

China Herald, while adding many others of very great interest for the determination of the real nature of the jade tubes.

The subject was treated by Dr. Wagener in a paper read before the German Asiatic Society of Japan some years ago, in which it was stated that the common origin of the Chinese weights, measures, and musical notes is based on native legends, and is also treated of in the Jesuit "Mémoires concernant les Chinois." Dr. Wagener says that there is not the slightest doubt that the Chinese system of weights and measures is more than four thousand years old, and that it possesses all the advantages for which the French metrical system is so much praised. The paper states that in the reign of the Emperor Hoang-ti, who ruled over China in the twenty-seventh century B.C., the scholar Lyng-Lun was commissioned to complete the musical system, which had been discovered two hundred and fifty years earlier, and particularly to lay down fixed rules for making musical instruments; that he betook himself to the province of Si-yung in North-West China, where, on the northern slope of a range of high mountains, a species of bamboo grew which, on account of its uniformity and its structure, being neither too hard nor too soft, was exceedingly suitable for a wind-instrument. This range appears to contain the head-waters of the Hoang-ho, the rippling of its waters producing a sound similar to the first or fundamental note which he obtained from the bamboo. He determined a scale of twelve notes: these are the notes which are called the six male and six female tones in the scale discovered by Lyng-Lun. Having reproduced the notes by means of bamboo pipes, he proceeded to lay down fixed rules as to the length of the pipes, so that thenceforth they could be easily constructed anywhere. For this he required a unit of length, and sought out an adequately small natural unit for his measurements. He selected for that purpose the seeds of the red millet (*Sorghum rubrum*), which present greater hardness and uniformity than the other kinds of millet. Lyng-Lun fixed the length of the pipe giving the key-note at 81 grains of the seed placed lengthways in a row: placed breadthways, it took 100 grains to give the same length. Thus the double division of 9×9 and 10×10 was naturally arrived at. Lyng-Lun also laid down rules for the breadth as well as the length of the pipe, because, although the note is essentially dependent on the length, it is nevertheless necessary for its purity that the pipe should be neither too broad nor too narrow. He therefore fixed the circumference on the inside at 9 grains laid lengthways. With these dimensions—namely, a length of 81 grains and an internal circumference of 9—the pipe which gave the key-note contains just 1200 grains, and this volume accordingly was made the unit of dry measure, and was called a *Yü*. Thus the units of length and dry measure were connected with the musical key-note. The twelve notes of the scale are all derived from the key-note. "Hence if the 1200 grains contained in the pipe are divided among the twelve notes it gives to each a hundred, and the weight of these hundred grains was made by Lyng-Lun the unit of weight" (as I understand this, it means that the twelve pipes were arranged to represent a series of cubical contents, commencing with 1200 and ending with 100 millet-seed contents). Dr. Wagener concluded by stating that this system of measures dates back 4600 years.

Analysing the statement made by Dr. Wagener, it is evident that the earliest form of pitch-pipe known to the Chinese was a bamboo tube, the sound being produced as in the Pandean pipes. The northern slope of a range of high mountains on the north-west frontier of China, in which lie the head-waters of the Hoang-ho, corresponds fairly well, as locality, with the district whence is supposed to come the jade so prized in China. The twelve bamboo pipes or tubes fixed as standards of musical notes by Lyng-Lun, correspond apparently with the twelve jade tubes mentioned by the *North China Herald* as having formed the basis for the measurement of liquids and solids four thousand years ago. The jade tubes were used as standards of length, and being spoken of as tubes, similarly as the bamboo tubes, it may be inferred that they were also standards of volume-measurement and of musical pitch, therefore that the hollow portion or tube had a depth corresponding to the particular note which it was intended to reproduce. Hence these twelve jade tubes would thus represent a set of Pandean pipes, while the requisite length, so as to allow of their being used each as standards of 9-inch length, could be attained by the addition or insertion of a stick or stop of sufficient length, just as is represented by the two "brushes" in question. The lengths of these were found

to be in millimetres, for the longer (which I will call A), 228.4; for the shorter (which I will call G), 227.3; the length of 9 English inches in millimetres being 228.6. The "handle" penetrates into the sheath about 17.7 mm. These handles are tapered to the end penetrating the sheath. The two "sheaths" are not alike in interior form: the sheath A is hollowed out conically to a depth of 46.5 mm., the remainder of its length having a hole drilled through it of about 2.6 mm. diameter; the sheath G is 70 mm. long, is hollowed out to a depth of 50.5 mm., and has no hole through the bottom or end part.

I was led to conjecture that these tubes or "sheaths" might be musical pitch-pipes; and on blowing across their orifices, the shorter produced the sound of high G, the longer or perforated one that of high A. By stopping with the finger the hole which passes through the bottom of the "sheath" A, the sound of high G sharp was produced. These notes I tested with a pitch-pipe.

This led me to further conjecture that they should present an interior diameter in accordance with the condition laid down therefor by Lyng-Lun; that is, such as to give an interior circumference equal to 9 grains of *Sorghum rubrum* laid lengthways. Having carefully calibrated the interior diameters, I obtained a series of values, giving for the interior circumference of the G sheath or tube a mean value of 28.32 mm., and for that of the A tube 28.44. Through the kindness of Messrs. J. Carter and Sons, of High Holborn, London, I obtained a sample of *Sorghum rubrum*, and operating on this, as also on a sample obtained in Dublin, I got for the length of nine millet seeds placed end to end the following values in millimetres: 26, 26.50, 27.10, 27.38, and 28. I took as mean the value 27 mm. (the exact mean being 26.995 mm.), so that the difference from that of the interior circumferences found is only 1.44 mm. in the mean. I may add that from a series of ten measurements kindly made micrometrically by Dr. McNab, it appears that the lengths of the grains measured by him vary, and would give for the lengths of nine placed end to end, the limits 28.804 mm. and 24.689 mm.

I consider therefore that, so far, the interior circumferences determined point to the "sheaths" being pitch-pipes having the standard interior dimension laid down by Lyng-Lun.

I thought it worth while furthermore to verify the cubical contents of the tubes in millet seeds. The pipe G gave a contents of 421 red millet seeds, and the pipe A of 375; or a mean capacity in seeds of 398. The white seed gave me for G 400.

What, however, is interesting, is that the end of the "handle" which penetrates the G sheath is hollowed out cylindrically, and this space holds 39 red seeds, and would seem to represent a standard of one-tenth volume. The corresponding end of the A sheath gives for two measurements 37 seeds, or as near as possible one-tenth the capacity of that sheath measured in seed contained.

With the measures of lengths of millet seed determined, we may attempt to fix the probable or approximate length of the fundamental pitch-pipe; that is, the length of 81 millet seeds placed end to end. Taking 27 mm. as the approximate length of nine grains, this length, or rather depth, would be $9 \times 27 = 243$ mm. Now there is found for the combined lengths of the "sheaths" and "handles" when placed end to end, the values:

	mm.	mm.	mm.
For the G tube,	227.3	+ 17.65	= 244.95,
" A tube,	228.4	+ 17.7	= 246.10;

both differing little from the approximate value found above.

Taking, on the other hand, the mean interior circumferences of the two tubes as probably representing the lengths of nine millet seeds, we have from the measurement

	mm.	mm.
Of the G pipe,	28.32	$\times 9 = 254.88,$
" A-pipe,	28.44	$\times 9 = 255.96.$

It is worthy of remark that by multiplying the mean, end or bottom, diameters of the two sheaths, $\frac{12.96 + 12.47}{2} = 12.715,$

by 20, the product comes out 254.3 mm.

Such coincidences can hardly be fortuitous, and to some extent justify the presumption that the two jade instruments which I originally took to be "brushes," are either original

standard measures of very great antiquity, or copies more or less exact therefrom. A further determination of the lengths of the Chinese red millet seed is evidently desirable as a matter of metrical and historical research.

J. P. O'REILLY

The Cambridge Cholera Fungus

IN reply to Dr. Klein's letter, I wish to state that although the specimens figured by Prof. Roy in the Royal Society's proceedings appear to be branched, the one shown to me differs.

Dr. Klein is of course perfectly right as to his statements concerning branching Bacteria; and his remarks, if he vigorously distinguishes between real and false branching, are true also of all the Schizomycetes. At the same time, the existence of such a form as *Cladotrix dichotoma* is not without interest, more especially since Cienkowski has described for it an involution form.

WALTER GARDINER

Clare College, Cambridge, January 31

As bearing on the subject of the "Cambridge cholera fungus," it may interest some readers to learn that methylene-blue has long been known as a good stain for fungi. My friend Mr. T. Hick, Botanical Lecturer at Owens College, showed me, some years ago, beautiful preparations of moulds stained with this substance, and I have frequently used it for the same purpose, as also chinoline-blue, known as "blue No. 13" of the aniline dyes. It is impossible to keep an aqueous solution of the latter for any length of time free from fungoid growth, the hyphæ of which, at a certain stage of development, exactly resemble the forms described by Messrs. Roy, Brown, and Sherrington, and my specimens, when grown on a slice of potato, developed into *Aspergillus glaucus*. Remembering the very varied appearances assumed by the barren hyphæ of fungi, depending on nature of substratum, relative amount of moisture, &c., I believe that morphological agreement of vegetative parts by no means proves specific identity, even when both can be examined in a fresh state—a great advantage, as the chemical and physical properties of the hyphæ can be compared; but an expression of opinion as to relationship based on the comparison of barren hyphæ with drawings is simply valueless, and only proves a very slender acquaintance with the characters of admitted specific value in the determination of fungi. Members of the Chytridiaceæ are common only in books; during years of practical mycological work I have only once met with a species belonging to this group, and this one I could not succeed in staining with either methylene- or chinoline-blue, but Bismarck-brown gave good results. I was inclined to attach a certain amount of value to this selective power exercised by fungi in connection with dyes, until I discovered that the hyphæ producing the zygospores of *Spygites megalocarpa* could not be stained with blue, but readily with methyl-green, while the hyphæ of the conidial stage (grown by us from the zygospore) readily absorbed methylene-blue, but had no affinity for green. Interstitial swellings and knob-like outgrowths are not uncommon on mycelium belonging to widely separated groups, especially when the spores are caused to germinate under abnormal conditions, as described in the *Journal of Botany* for October 1882. The protoplasm frequently becomes concentrated in these portions, which are then cut off from the thread by a septum, and serve as centres for a fresh growth, when placed under favourable conditions. The absence, presence, or relative number of septa vary much in the same plant at various ages and under different conditions of growth.

Kew

G. MASSEE

Earthquakes

IN NATURE of October 14 (p. 570) you published a letter from Prof. O'Reilly regarding the great earthquake of Carolina, and drawing attention to the tendency of earthquake-lines to assume the direction of great circles. So far his observations were identical with a theory I had myself elaborated, and which I embodied in a paper written at the beginning of the year 1884, now in the hands of the Committee of the Geological Society of London, but never presented to the Society. So long ago as

that period I had drawn attention to what I pointed out as the two principal earthquake great circles—one, the Japan and Rocky Mountain system, with one of its poles in 170° W. long., 25° S. lat.; the other, the Himalayic, with its north pole approximately in 45° N. lat., 160° W. long. The former has been frequently described, and Scrope ("Volcanoes," p. 303) suggested a theory to explain its occurrence. The latter is little less remarkable, and is at the moment even more interesting, as, with the exception of the Carolina earthquake, all the great earthquakes and volcanic eruptions of the last five years may be referred to it. I may instance the cases of Krakatō, Kashmir, the Caucasus, Spain, Cotopaxi, New Zealand, and the recent Mediterranean disturbance, all of which occurred within a few degrees of the line or actually on it. Now it is remarkable that this line is marked through a considerable portion of its course by the presence of disturbed Miocene rocks, so much so that I have felt justified in calling it the Miocene line.

The paper referred to contained a theory too long to be worked out in the compass of a letter, but founded on the changes in form which must occur when a plastic body falls by the action of gravity towards a primary. A little consideration will show that, as the action of gravity is inversely proportionate to the square of the distance, the forward portion of such a body will be continually pulled away from the posterior, and an original sphere will in its descent become deformed into a prolate spheroid. Now the result is, I believe, calculable for a body like the earth, even under the present conditions of its annual approach to the sun, in other words its fall from aphelion to perihelion. During periods of extreme eccentricity of the orbit the fall and consequent deformation were much greater. The main factors in the calculation are of course: (1) the distance from the primary of the commencement of the fall; (2) the diameter of the falling body; (3) the distance fallen; and (4) the comparative masses of the primary and the attracted body. Beyond this, consideration has to be given to what we may term the specific resistance to deformation of the particular body. The latter, indeed, seems to be the principal factor in determining the amplitude and periodicity of earthquakes.

It is difficult for the geologist at this remote spot in the Far East to keep in touch with the daily progress of geology at home, but there is one probably counterbalancing advantage—in the enlarged view he has to take of the mid-Tertiary epoch as a factor in geologic change.

THOMAS W. KINGSMILL

Shanghai, November 30, 1886

THE CALENDAR AND GENERAL DIRECTORY OF THE SCIENCE AND ART DEPARTMENT

THERE is a general impression on the Continent, and even in England, that English teachers of science carry on their work with little direct relation to one another. Twenty-five years ago this impression was not incorrect, but any one who will take the trouble to read the "Calendar and General Directory of the Science and Art Department for the year 1887," lately published, will see that it is no longer true, and that very important steps have been taken towards the establishment of an organised and efficient system of scientific instruction. At South Kensington we have now a School of Science, which maintains the most intimate connection with a vast number of science schools and classes in all parts of the United Kingdom. Here we have at least the germs of a proper system, and it depends upon the country itself whether we are to remain content with what has been achieved, or are to continue the work we have begun until it can be pronounced completely adequate to the needs of modern times.

The movement which has led to these results may be said to have begun in 1853, when the Department of Practical Art was expanded into the Department of Science and Art. The immediate object of this change was to secure that the advancement of practical science should be directly encouraged, and it was decided that the end could be most surely attained by "the creation in the metropolis of a school of the highest class, capable of affording the best instruction and the most perfect train-

ing," and by help rendered to local institutions for scientific education. For some time it seemed not improbable that the scheme would be, at least in part, a failure. No general system of making grants applicable to the whole country was devised until 1859. Experimental schools were established by special Minutes, the arrangement usually being that the teachers were to receive payments from the Department in the nature of certificated allowances, and that their incomes, from fees, subscriptions and other sources, were to be guaranteed by the Department for a certain number of years at amounts varying in different places. In this way science schools were opened at Aberdeen, Birmingham, Bristol, Barking, Leeds, Newcastle-on-Tyne, Poplar, Stoke-on-Trent, St. Thomas's Charterhouse, Truro, Wigan, and Wandsworth. It was found, however, that there were but few places where a man could earn his living by teaching science alone; and in 1859 the only science classes in operation under the Department, irrespective of the Navigation Schools, were those at Aberdeen, Birmingham, Bristol, and Wigan, the number of persons in attendance being 395. Then a new plan was tried. In 1859, when the late Lord Salisbury was Lord President, the first General Science Minute was passed, enabling any place to establish science classes, and to obtain State aid according to certain fixed rules. The effect of this measure surpassed the hopes of those by whom it had been suggested. A number of new schools and classes were rapidly formed so that, in May 1861, at the first general and simultaneous examination of classes, there were 38 classes with 1330 pupils, not including some 800 pupils in classes not under certificated teachers. Since that time there has been constant progress, as the following table will show:—

1862 ...	70 schools with	2,543 pupils in	140 classes
1872 ...	948 "	36,783 "	2803 "
1882 ...	1403 "	68,581 "	4881 "
1885 ...	1542 "	78,810 "	5649 "

In some schools there are classes both for science and for art, and in such cases it is interesting to note the relative proportion of the number of pupils in the two departments. At the School of Science and Art in Reading, for instance, there are 200 art students, and only 90 students of science. At the Central Board School, Rochdale, on the other hand, while there are only 50 students of art, there are 190 science students. In some instances the numbers are evenly, or almost evenly, balanced. At a school in Deptford there are in each department 160 students, and at another, in Bristol, art has 360 students, science 350.

The number of teachers varies, of course, very considerably. The following tables, compiled from the details presented in the "Calendar and General Directory," show the number of schools which have each three or more teachers:—

I.

Schools in which both Science and Art Classes are held

Schools	11	8	40	32	24	15	14	9	4	1	2	3	2	1
Teachers	3	4	5	6	7	8	9	10	11	12	13	14	15	16

II.

Schools in which Science Classes only are held

Schools	105	36	24	11	1	2	4	2	1	1	1	1	1
Teachers	3	4	5	6	7	8	9	10	11	12	13	14	

The progress of the central institution—the "school of the highest class, capable of affording the best instruction"—has been in its own way not less remarkable. The removal of some of the courses of the School of Mines to South Kensington greatly increased the

number of students, partly because the instruction was rendered more thorough and efficient by the addition of laboratory and practical instruction in physics, mechanics, biology, and geology, and partly because South Kensington was more convenient for students than Jermyn Street or Oxford Street. The school was also rendered more useful by the fact that, after the transfer, a few teachers, and promising students who undertook to become teachers, were brought up to London to be trained. This system has been developed, and now from fifty to sixty teachers are annually trained in different branches of science. A system of short summer courses for teachers has also been organised, and this opportunity of improving themselves is highly valued by the teachers, about 180 or 200 of whom are selected annually from some 500 or 600 applicants.

The affiliation of the School of Mines to the Normal School of Science in 1881 marked an era in the history of the institution and in the history of scientific work and education in this country. Students of all classes receive in these united schools systematic instruction in the various branches of physical science. The institution is primarily intended for the instruction of teachers and of students of the industrial classes selected by competition in the examinations of the Science and Art Department, but other students are admitted so far as there may be accommodation for them, on the payment of fees fixed at a scale sufficiently high to prevent undue competition with institutions which do not receive State aid.

All this is fully and clearly set forth in the "Calendar and General Directory," where also the reader will find ample details as to the Science Collections, the aid granted to local museums, the Committee on Solar Physics, the relation of the Government to scientific research, the Geological Survey, the Museum of Practical Geology, the Mining Record Office, and the scientific establishments of Edinburgh and Dublin.

In an article on "National Education in Science and Art," the *Times* on Monday last expressed a doubt whether, after all, any country can be much ahead of England in the number and excellence of its scientific institutions. The *Times* takes far too favourable a view of the relative position of the United Kingdom in such matters. Recent Consular reports have shown that our traders are being steadily beaten by German competitors in many great foreign markets; and the explanation is that, notwithstanding the progress we have made, our system of scientific instruction will not compare, in comprehensiveness and thoroughness, with that which has grown up in Germany. The *Times*, although unwilling to admit the superiority of our rivals, readily grants that as a nation we do not yet do enough for the promotion of science. It says:—

"When the general condition of popular artistic and scientific instruction is viewed, there can be no question that it is not in accordance with national responsibilities, whatever the average may be elsewhere. A primary result of the discovery is to abate some of the admiring content which study of the contents of the Science and Art Department's 'Calendar and Directory' is calculated to produce. To the Science and Art Department has been committed the task of imbuing the nation with those two extensive branches of human learning. The depreciatory estimates so freely offered in these days of the industrial attainments of the nation in each of them suggest either that the Department is not altogether equal to the enterprise, or that it has not been provided with the proper instruments."

The *Times* urges, with much force, that wealthy men have a magnificent opportunity of serving their country by following the example of the late Sir Joseph Whitworth in the endowment of scholarships, exhibitions, and prizes for students of science. With its remarks on this point all who are interested in science will agree; but it

is necessary to point out that, however generous private persons may be, they cannot possibly meet the wants of England, with regard to science, in our time. This task can be properly undertaken only by the community as a whole, acting through its organ, the State. If it is not undertaken on the scale which circumstances have rendered necessary, we must be prepared to pay the penalty in diminished commerce and industry. On the other hand, the success which has attended our efforts in the right direction in the past ought to encourage us to make further sacrifices. There cannot be the slightest doubt as to the eagerness with which increased opportunities for scientific education of the highest order would be taken advantage of. At South Kensington there is not nearly room enough for the large number of students who annually seek admission, and like pressure will probably soon be experienced at many less important centres of scientific training. Here the *Times* speaks out strongly and well:—

"If the industrial classes in England be more or less deficient in taste and technical intelligence, it is from absence, not of natural aptitude, but of educational opportunities. Keeness of Continental competition may be far from an unmixed evil if it frighten Englishmen who have the ability into using it for the remedy of the shortcoming. Dulness and mental lethargy are in themselves evils, apart from the danger they cause of a loss of trade. A workman without insight into the meaning of the work he is doing, and with no perception of its real capabilities, is a mere bondsman to his occupation, instead of its master. While we suspect, as we have intimated, the existence of an exaggerated tendency to extol foreign technical training, the British mechanic will have no reason to regret the propensity, if it conduce to his equipment with the means of industrial enlightenment needed to convert his vocation from base drudgery into an art."

That the working classes are becoming alive to the necessity of an improved system of scientific and technical instruction may be inferred from the resolution on the subject which Mr. Howell proposes to move in the House of Commons. This resolution we print elsewhere, and our readers will agree with us in wishing Mr. Howell all success in the admirable enterprise he has undertaken.

THE PROGRESS OF ASTRONOMICAL PHOTOGRAPHY

IN the *Annuaire* for the present year, published by the Bureau des Longitudes, is an important article by Admiral Mouchez, the Director of the Paris Observatory. The article is really a history of the various applications of photography used by astronomers up to the present time, and the history is very well done. The article contains many details relative to the work which has recently been going on in the Paris Observatory, which we think will be read with very general interest.

In the new instruments which the Brothers Henry have recently constructed at the Observatory, before a plate is taken the telescope is pointed approximately to a bright star, which is examined with an ordinary eye-piece, armed with a blue glass. In this way a slide can be placed very near the chemical focus, but in order to determine the focus exactly, an image of a star is made to run six or seven times along a very small plate at different marked distances inside and outside the focal point, as previously determined. An inspection by a magnifying glass of the different trails left by the star on the *cliché* shows which was the most exact chemical focus employed to produce them. This when once done really needs no repetition, but as a matter of fact the operation is repeated once a month.

Another point which the Brothers Henry have already settled is, that in the case of very many photographic plates of extreme sensitiveness the plates are practically

useless unless they are prepared almost immediately before they are required, so that as a matter of fact very sensitive plates are now avoided.

Another limit to the sensitiveness which can be utilised is the diffused light proceeding from the atmosphere, either from the gas of a large town, as in Paris, or from the presence of the moon. Very sensitive plates are liable to be fogged even by diffused light in the case of very long exposures.

We have before referred to the arrangements employed for enabling the images of stars to be differentiated from any accidental spots or dots on the plate. The plate is practically exposed three times to the region of the heavens, with such a small variation of position, however, that the three images of the star on the plate appear as one to an observer who looks at it casually, and a magnifying glass is really necessary to discover the triple nature of the image. This method of working has been found to have advantages which were not anticipated in the first instance; thus, for the same total time of exposure the images of much more feeble stars are recorded with the three successive exposures than with one alone. This arises from the fact that the stars of the lower magnitudes, only being represented by very small points from $1/30$ to $1/40$ of a millimetre in diameter, would escape all observation by the naked eye, and would not be visible at all on paper copies; while the three exposures give a larger image visible to the naked eye, and perceptible on a paper positive. Moreover, if a small planet is included in the region being photographed, the deformation of the small triangle would instantly betray its presence, even with an exposure of a quarter of an hour. Admiral Mouchez has calculated that a planet at twice the distance of Neptune would be easily recognised in three successive exposures of an hour each,—the motion of Neptune in half an hour quite destroying the triangle which it, like the stars, would make were it at rest.

The real and serious objection to the triple exposure is the wonderful patience and skill that are required to keep the instrument for three consecutive hours, without a moment's relapse, pointed rigorously towards the same spot in the sky. This is very trying work, and apt to overstrain those who perform it. Admiral Mouchez is alive to the fact that the way to obviate this difficulty is to increase the aperture of the object-glass, and this is what probably will be done before very long.

Some very interesting information is given regarding the microscopical appearances of the images of the stars seen on the negatives:—"The microscopical study of the *clichés* presents, moreover, much interest from many points of view, and the appearances of the images of the stars is so characteristic that it is impossible to confound them with accidental spots, as has been generally supposed; were this point of view alone regarded, it would perhaps be useless to multiply the exposures of the same plate. The stars appear on the plate, in fact, not under the simple form of a round spot of uniform black tint diminishing and becoming clearer as the star gets smaller, but as a mass of small, round, black points, very close together towards the centre for stars of the ten or twelve larger magnitudes, and more and more sprinkled, still retaining their blackness, for the fainter stars; and at the extreme limit beyond those stars which give a definite and certain image, there still appear on the *cliché* some small groups of little points scattered sparsely, but evidently recording still fainter stars, the existence of which can only be suspected without any means of further confirmation.

"Unfortunately, whatever progress we may make in optics or in photography whatever, penetrating and sensitive power we may hope to give to our instruments, it is evident that we shall never succeed in seeing the most distant stars, and that at whatever limit we may arrive, there will always be beyond it an infinity of others lost in

the profundity of the heavens which will always escape our knowledge, but it is by photography and the scientific study of negatives that we shall be able to go further than by any other means. From a chemical point of view also the microscopical examination of the stellar images will not be without interest, because it will help us to understand how the light acts upon the molecules of the insoluble salts of silver which are contained in the stratum of organic material which forms the sensitised plate. It is not, as I have already stated, in giving a uniform tint, more or less decided, according to the magnitude of the star, over the whole image, but really in decomposing a greater or less number of particles of salts of silver over this area, that the light works; so that we can define the image of a very feeble star as a resolvable nebula, and the others as insoluble nebulae surrounded by a resolvable portion. I have never seen around any of these images the rings referred to by several astronomers, which have the appearance of diffraction rings seen in telescopes.

"To establish the relationship between the scales of the optic and photographic magnitude of the stars, Bond has made a series of interesting experiments by varying the time of exposure and the aperture of the object-glass. These experiments have led him to an interesting result on the mode of action of light. He has found that a certain time elapsed before the action manifested itself at all, and then that it did so suddenly, ten or a dozen molecules of salts of silver in each superficial second of arc were attacked by the light; after this the number increased very rapidly according to the time of exposure. This mode of action seemed to him obscure and difficult to explain. But it seems to follow from these facts, and from the examination of our *clichés*, that in the manufacture of the bromide of silver, and the preparation of sensitive plates, it is of the highest importance to obtain the finest possible pulverisation of the salt."

As there is to be a Conference of Astronomers at Paris next Easter to discuss the whole question of astronomical photography, it is well that Admiral Mouchez and his staff are accumulating so many facts to help in the discussion.

METEOROLOGICAL CONDITIONS AT THE TIME OF THE ERUPTION OF MOUNT TARAWERA, NEW ZEALAND

IN the Government Sanatorium at Rotorua there is a self-registering barometer kept by Dr. Ginders. This shows that at 9 a.m. on June 9, the atmospheric pressure was 29.30 (at about 1000 feet above the sea). It decreased and reached its lowest point of 29.00 at 4 p.m. on the 9th. It then began to rise. At midnight it was 29.08, and at 1 a.m. on the 10th—just before the eruption—it was 29.10. This pressure was maintained all through the principal part of the eruption, after which the glass began to rise again, reaching 29.25 at noon on the 10th. The curve, elsewhere smooth and even, shows from 3.30 a.m. to 6 a.m. a number of small oscillations which treble its thickness. None of these oscillations are recorded before and none after 6 a.m. on the 9th, except a single one at 5 p.m. on Friday, the 11th. These oscillations are attributed to earthquakes, but, whatever may have been their cause, they certainly mark the outburst of Rotomahana and the crisis of the eruption.

Another barometer at Ohinemutu, belonging to Mr. Edwards, of the Native Lands Court, read as follows:—

June 9, 10 a.m.	29.30 inches
" 4.30 p.m.	29.00 "
" 10, 1.55 a.m.	29.20 "

The following is the rainfall at Rotorua:—

June 4.	1.26 inches
" 5	0.58 "

There was no rain at Rotorua between the 5th and the eruption, but it rained on the 9th at Wairoa and at Ateamuri, on the Waikato.

At Rotorua the slight mud-shower fell in directions from south-east to south-west, but most from the south-east, as ascertained by an examination of the telegraph poles. At Taheke, on Lake Rotoiti, the mud must have fallen with a south-south-east wind. At Galatea, eighteen miles east-south-east from Rotomahana, no mud fell; but the scoria was thicker on the north-west than on the south-east side of the houses: evidently no strong wind was blowing.

The night of the 9th was calm and fine. During the earlier portion of the eruption there was a slight south-westerly wind at Wairoa, which increased to a strong gale at 3 a.m. At Rotorua there was a slight south-easterly wind up to 4 a.m., when the south-westerly gale reached there from Wairoa. At Taheke, on Lake Rotoiti, the wind changed to south-west at 9 a.m., but there was no gale. At Napier a southerly gale commenced at 4 a.m.; at Gisborne, in Poverty Bay, a south-westerly gale was blowing; at Waiapu a strong north-westerly wind was blowing from 3.15 a.m. to 4.30 a.m., when it changed to the south-west. At the East Cape there was a strong southerly gale. It appears therefore that the south-westerly gale at Wairoa had no direct connection with the eruption, for it commenced about the same time all over the east coast from Napier to the East Cape.

I was surprised to find that the eruption had caused no great atmospheric disturbance, except in its immediate neighbourhood, and that there was no evidence at all of any indrawing currents. The reason for this, no doubt, is that the area over the openings which was violently disturbed is small, so that equilibrium was restored at very short distances around. For this reason a volcanic eruption has none of the effects of a cyclone. The eruption was, as usual, the cause of much electrical disturbance, but this did not affect the weather. F. W. HUTTON

A FEW OF OUR WEATHER TERMS

A RECENT skirmish in the *Times*, on certain words in common use among English meteorologists, and prevalent in our weather reports, suggests that a little overhauling of these and similar terms may be from time to time desirable. In a branch of knowledge which, simultaneously with its growth, becomes more and more popular, new terms expressive of new ideas should not only be accurately descriptive of facts, but should be adapted to popular imagination.

If we cannot have such terms as "helix" and "ant-helix," the Meteorological Department cannot be on safer ground than in their adoption of the terms "cyclone" and "cyclonic," "anticyclone" and "anticyclonic"; these words being precisely antithetical, and expressive of phenomena which are the opposites of each other in almost all their characteristics. To both of these words, however, objections have been raised, and these objections have been somewhat inconsistently based on different reasons. The word cyclone has been objected to because it terrifies our women; but its equivalent, "revolver," would produce at least as alarming an effect. They would soon, however, get accustomed to the use of either. The most unscientific people will quickly understand that when the laws which govern a particular kind of atmospheric circulation have once been proved to be identical, whether that circulation be violent, moderate, or feeble, it becomes desirable to have a single term descriptive of such a circulation. Such nouns as "hurricane," "storm," &c., can be employed, if we please, to denote that the disturbance is of a violent or severe character; while we have plenty of adjectives, strong or mild, to be employed at discretion. Perhaps this

will be still more fully realised when the public understands that, in any particular instance, the circulating winds may vary between the most violent and the lightest during the progress of the disturbance. As Mr. Abercromby clearly states it: "The same cyclone may develop the energy of a hurricane soon after its birth in the West Indies, and, after a long and stormy life in its passage across the Atlantic, die surrounded by gentle summer winds on the rocky coasts of Norway." The original use of the term "cyclone" was almost limited to the phenomenon in its acutest stage; and, owing partly to this fact, meteorologists have been disposed to apply the expressions "cyclonic system" and "cyclonic disturbance," &c., to the gentler instances or stages of this kind of circulation, rather than the word "cyclone" itself; but the latter word might now be used without hesitation, for it is most true that "a progressive science uses words provisionally to express provisional ideas, and as the ideas increase in clearness and precision" (and, we may add, in extension) "the word has to take on new meanings."

The term "anticyclone" has been recently objected to as possessing absolutely no significance, an objection which is not in itself worthy of discussion in these pages. This objection is, however, probably founded on one of a more serious nature, viz. that anticyclones are merely interspaces between cyclones. Such interspaces do, of course, exist, and they occasionally travel on without undergoing any very rapid change of form in company with the cyclones. But the interspaces between circles or ovals are not circular or oval; and further (as is more important to observe, and as has long ago been shown to be true) the anticyclone proper has characteristics of its own which distinguish it from these interspaces: its movements are often slow, or it is stationary for a considerable period, while in both hemispheres it has the power of deflecting the course of the cyclones moving in its vicinity more or less towards the right, except in particular positions.

Now let us look at the word "depression" and the ideas associated with it. It would probably be an impossible as well as an undesirable task to get rid of this term altogether, but for this reason it becomes all the more necessary clearly to define its meaning. Originally it signifies a lowering of the surface of the barometric column due to a diminution of pressure on the surface of the mercury in the cistern. It is equally well employed to designate a "taking off" or diminution of atmospheric pressure. In any case, it might be employed to designate such a diminution of pressure as takes place during the lessening or the passing off of an anticyclone. But by common usage it has come to be practically equivalent to cyclone, the only difference being (1) that it naturally refers to the diminution of pressure within the cyclone, and not the circulating winds, and (2) that it can be usefully applied to areas diverging considerably from the circular form. The ease with which the idea of a saucer-shaped hollow in the ocean of atmosphere is entertained, and the associations of the word "gradient" (a word valuable, suggestive, but figurative—a word for which I can find no substitute, unless it be a coined one), have certainly led to some misconceptions. Over the front or ascensional part of a cyclone, atmospheric pressure is greater at the level of four, five, or six miles above the earth's surface than over surrounding regions at the same level. It would be well for our storm-warnings if more people were careful to observe the violent north-westerly upper-current prevailing immediately in front of, and over, the southerly winds which we feel when a cyclonic disturbance is coming upon us from west-south-west. The few who have noticed this cannot fail to be struck by the fact that at the level of the cirrus the pressure must increase with extreme rapidity at the same time that pressure is decreasing at the earth's surface. It is true that in the rear of the disturbance an extension of the great

polar area of depression in the higher regions of the atmosphere is shown by the movements of the higher clouds. Any one who will be at the trouble to chart out these phenomena will feel that the neat little orographical maps of the atmosphere with which some of our popular writers on weather would present us are exceedingly different from the realities.

The terms "col," "ridge," "trough," &c., for a similar reason, while assisting the popular imagination, perhaps assist it in the wrong direction, and I would, though with much deference to better authorities, suggest that such terms as "arm," "band," "belt," "extension," &c., might be employed with a little more safety. To the terms "deep," "depth," "high," "height," might not my own respectable old words, "intense," "intensity," even now be found preferable? and for the word "shallow" the word "slight" in many cases be advantageously substituted? I am aware that in a magazine article or in a weather report some variation of terms and expressions is frequently desirable, but the cover has not yet been fairly drawn; and an abundance of useful words is still available, without recourse being had to terms either borrowed from foreign languages or expressive of incorrect ideas.

W. CLEMENT LEY

NOTE ON INSTANTANEOUS SHUTTERS

THE introduction of rapid dry plates having made a general demand for mechanical shutters, a large variety are now offered for sale by the various makers. Many of these shutters are neat and ingenious, but nearly all have a tendency to shake the camera during exposure, and in the only one which I have seen for sale in which this mistake has been avoided the photographic efficiency of the arrangement has been impaired by the opening being made to assume the form of a gradually expanding and contracting hole; the idea being, I am told, that while the opening is small it will act as a stop and secure definition. This, of course, is true to a certain extent—how far, I will inquire presently.

I do not know whether the general theory of mechanical shutters has been discussed, but if it has it is certainly not well known, and perhaps the following remarks, which point out what the photographic efficiency of the various classes of shutters is and their effect on the steadiness of the camera, may be of some use.

Shutters may be divided into two chief classes, viz. those in which the principal moving part consists of a single piece, and those where the moving parts are multiple; the great difference between them being that, while the first class must exert either a force or a couple on the camera during exposure, the second class may be so designed as to exert neither. The first class consists of drop-shutters and revolving disks with an aperture which passes across the lens, and of those shutters where a sliding piece rises and falls or a hinged piece opens and shuts. (Of the second class I only know of one as being in the market, though probably many amateurs may, like myself, have made them for their own use. In this shutter two plates, occupying the position of the ordinary stop in the lens, separate and come together again. Each plate has a deep V-shaped notch in it; the apex of each V when the shutter is closed being in the axis of the lens. The opening is therefore a quadrilateral figure which gradually expands and contracts.

The mechanical arrangements of nearly all the shutters, except those belonging to the revolving disk and drop-shutter class, are such as to make the motion of the shutter a simple harmonic function, or nearly so, of the time from the commencement of exposure, while in the drop-shutters and disks the aperture may be taken as moving across the lens with a nearly uniform velocity. This, of course, would not be true if the motion of the parts

was quite free under the action of the driving force, but friction enters largely into the account; and even if it did not, no large error will be introduced in calculating the photographic effect of shutters of this class by assuming that velocity of the moving part is uniform during exposure and equal to its mean velocity.

The photographic effect of a shutter is measured by the sum of the products of each element of aperture brought into action by the shutter and the time for which that element acts. This measures the total amount of light which passes through the lens during exposure, but it does not necessarily follow that the light should be uniformly distributed on the sensitive plate. This, indeed, only happens when the shutter is at the optic centre of the combination.

In mathematical notation, if the path of a point in the shutter be along a line x , and if U be the area of the lens expressed in terms of x , and T_x the time for which dU , the element of area exposed in passing from x to $x + dx$, acts, then the photographic effect of the shutter is $\int T_x dU$, taken between the proper limits of x .

The photographic efficiency of a shutter may be taken as the ratio of this quantity to the whole area of the lens, multiplied by the whole time of exposure, or $T'U'$.

The result of integrating the above expression may always be put in the form

$$aT'U'$$

where a is a numerical constant, which therefore expresses the efficiency of the particular shutter considered.

I subjoin a few results showing the efficiency of several different types of shutter:—

	Efficiency
(1) Drop-shutter with circular aperture (uniform velocity)	$a = \cdot 43$
(2) Harmonic opening from one side (x proportional to $\cos \phi t$)	$a = \cdot 5$
(3) Harmonic opening from centre, the opening being a circular hole of radius ρ (proportional to $\sin \phi t$)	$a = \cdot 5$
(4) ¹ Harmonic opening from centre, the aperture being formed by the edges of two plates which recede from a diameter of the lens and the boundary of the lens (x proportional to $\sin \phi t$)	$a = \cdot 764$

It will be seen that as far as efficiency goes the drop-shutter is lowest on the list.

The next two have the same efficiency, but while the second has a tendency to shake the camera the third has not. If, instead of assuming that the aperture in this case was circular, we had made it square, as in the shutter before referred to, the efficiency would not have been quite as great as $\cdot 5$.

No. 4 has the highest efficiency of any, viz. $\cdot 764$, and differs from the last merely in having no V-shaped notches in the plates which close the aperture, so that the opening begins as a slit instead of a point. Thus by the adoption of the square expanding aperture nearly 40 per cent. of possible efficiency is lost.

The gain in definition caused by the aperture acting as a stop may be estimated by comparing the amount of light (L_2) admitted while the opening is small enough to make the definition good, with the total amount of light admitted (L minus L_1), remembering that the greater the aperture up to which the shutter may open without sensibly impairing the definition the less is the possible gain in definition from the use of a stop. Thus, suppose the greatest aperture consistent with good definition to be $\rho^2 \times$ full aperture (R^2). Then the use of a stop of radius ρ can only reduce the radius of the circle of confusion about the image of a point by $\frac{R - \rho}{R}$ times what it would have

¹ This is the form which I use, but I am not aware of any shutter of the kind being in the market.

been had the whole aperture been employed. The improvement in definition, then, due to the expanding shutter acting as a stop is given by the expression—

$$\frac{R - \rho}{R} \cdot \frac{L_1}{L - L_1}$$

The curve below shows the improvement in definition calculated from this expression, the abscissæ being proportional to $\frac{\rho}{R}$. It has a maximum value of 1.5 nearly when $\frac{\rho}{R}$ is about .8, but falls away rapidly on either side of this value.

Thus when a stop of .8 times the full aperture is sufficient to secure definition, the square expanding aperture may be said to answer the purpose. But a better result with less exposure could be obtained by the use of shutters of type (4) with a separate stop of the right size; for it may be shown that with the square expanding aperture the amount of light admitted while more than eight-tenths open is not more than 8 per cent. of the whole, and not more than 8 per cent. of the light would be lost if a .8 stop were used. But a shutter of type (4) admits nearly 40 per cent. more light than the expanding square, so that there would be a gain of something more than 30 per cent. in light by using it.

This is rather understating the case, for the efficiency of a shutter as defined above is increased by the use of a stop,

$$\frac{R - S}{R} \frac{L}{L - S}$$

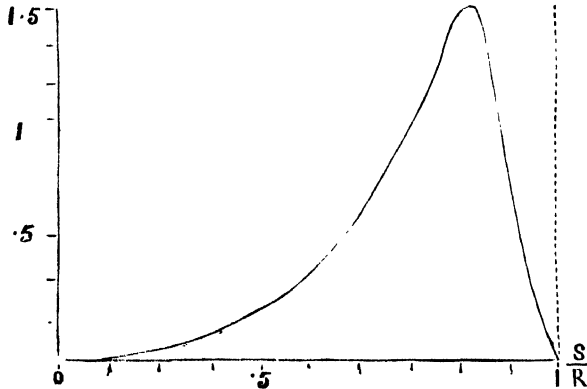

the whole aperture of the stop being uncovered for a finite time while the whole aperture of the lens is only uncovered for an instant.

To see what effect an unbalanced shutter has on the steadiness of the camera and definition of the image, the mass of the unbalanced moving part of the shutter, the mass of the camera, its period of vibration on its support, and its radius of gyration must be taken into account, as well as the time of exposure. The exact investigation of the motion is very much like that given by Helmholtz of the motion of a pianoforte-wire when struck by a hammer. But without entering into mathematical details it is easy to approximate to the required result in a large group of cases, viz. where the time of exposure is short compared with the natural period of the camera on its supports. This will apply to cameras held in the hand for all exposures which could be effectively used with such a support, and in most other cases when the exposure is less than a fiftieth of a second.

The camera and shutter may now be compared to a fly-wheel free to turn with a small load on its rim, which, by some mechanism on the wheel, can be made to vary its position. If the fly-wheel is at rest to begin with, the motion of the system when the load is caused to move is

given by the condition that the moment of momentum of the fly-wheel and load together is nothing, which implies that

$$\frac{\text{velocity of rim of wheel}}{\text{velocity of load}} = \frac{\text{mass of load}}{\text{mass of rim}}$$

Suppose that the camera is replaced by a fly-wheel which has the same moment of inertia and a radius equal to the distance of the centre of oscillation of the camera on its support from the shutter, the mass of the equivalent fly-wheel will be less than that of the camera on account of its distribution, so that the angular motion of the camera about the centre of oscillation will be somewhat greater than

$$\frac{\text{mass of shutter} \times \text{travel of shutter}}{\text{mass of camera} \times \text{radius of oscillation}}$$

As an example, suppose the ratio of the masses to be 1/100 and the travel of the shutter one inch, if the radius of oscillation lies between one foot and six inches, the angular movement of the camera will be between three and six minutes of arc, or from one-tenth to one-fifth of the apparent diameter of the sun or moon.

In the case of drop-shutters acting by gravity, the camera begins to move upwards at the moment the shutter is released, and will go on moving upwards until it is as much above the new position of equilibrium which it would assume on the removal of the weight of the shutter as it was below it when the latter was attached. So that if the time of exposure be half as long as the natural period of the camera, the whole extent of the angular motion will show on the sensitive plate.

I have recently made some experiments to see how, when the camera was held in the hand, the accidental motions of the support compared with those due to the action of the shutter. It would, I think, at first sight be supposed that the former were the more important of the two. The experiments were made by weighting a piece of looking-glass to represent the camera, and then, holding it as the camera would be held, reflecting the sun on a distant screen and noting the displacement of the patch of light. I found it in my own case to be continual, vibrating at a rate of something like four per second, through an angle of about one in six hundred to one in eight hundred, implying, of course, half this motion in the camera; that is, from three to two minutes of arc. The time of the whole vibration being about one-fourth of a second, if the time of exposure was as much as one-eighth of a second the whole of this would show on the plate, but for exposures of one-twentieth of a second the loss of definition from this source would hardly be appreciable. The weight of the camera in this case was small—little more than a pound—and so unfavourable for steadiness.

The general conclusions to be gathered from the foregoing remarks are: (1) That there is room for great improvement in the photographic efficiency of shutters; (2) that all the ordinary kinds shake the camera when the exposure is rapid; but that (3) for comparatively long exposures, say more than one-tenth of a second, almost any kind of shutter will do when the camera is mounted on a stand; and (4) that for cameras which are to be held in the hand, in order to secure fine definition the shutters must be dynamically balanced or exceedingly light.

A. MALLOCK

ON SOME PHENOMENA CONNECTED WITH THE FREEZING OF AERATED WATER

THE elimination in the gaseous form, on the freezing of liquids, of the air and gases held in solution presents some features in its process which may be worth recording.

Bubbles in ice are familiar; but their arrangement and progressive development in the process of freezing-over

present some points which I do not think have been generally observed.

Aquatic plants at the bottoms of ponds give off oxygen gas, and marsh gas is emitted from decaying vegetable matter. These two sources of supply will, to some extent, account for the entanglement of bubbles in ice on a pond surface, but only to a very small extent, and may be left out of consideration in dealing with the development of air-bubbles in ice. This takes place independently of any extraneous source of supply other than atmospheric air, and may be as well seen in a glass or earthenware vessel as over a weedy pond surface.

The following facts must be noticed:—

(1) Ice over deep water invariably contains fewer bubbles of included air and gas than ice formed over shallow water, and probably from this cause ice obtained from over deep water is more durable for storage than ice obtained from shallow pools.

(2) The upper or surface portion of a coating of ice invariably contains less included air than its under or lower portion, and this is more obvious in ice formed over shallow than in that over deep water. In each case there is a fairly regular gradation in the quantity of entangled air, increasing from the surface downwards. I ascertained that the included air from the upper surface (*a*, Fig. 1) of

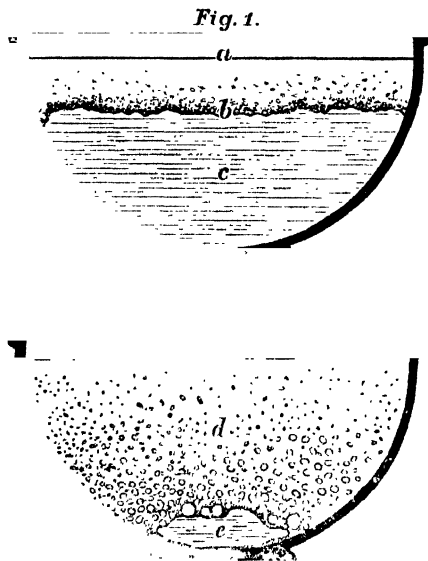

a thin coat of ice was scarcely appreciable in quantity, and one pound weight from its lower surface (*b*, Fig. 1) contained 0.08 of a cubic inch of entangled air.

(3) There is more included air in ice formed over water in a small vessel (Fig. 1) than in ice formed over a large body of water.

(4) There is more included air (weight for weight of ice) in an entirely frozen mass of ice (Fig. 2, *d*) than in surface ice from a partly frozen vessel of water. In an entirely frozen mass (Fig. 2, *d*) 1 pound of ice contained 0.59 cubic inch of included air; and surface-ice (*a*, *b*, Fig. 1), over unfrozen water, one pound weight contained 0.15 cubic inch.

(5) In freezing separately the water from which the first frozen coat of ice had been removed (Fig. 1, *c*), the ice contained a much larger proportion of included air (0.89 cubic inch) than either the surface ice (Fig. 1, *a*, *b*) or the ice obtained from entirely freezing a body of water (Fig. 2, *d*).

(6) On re-freezing water which had been frozen and thawed, there was but a very slight further release of air, which had been almost entirely released in the first

freezing: one pound of the second ice contained but 0.005 cubic inch of air.

(7) In completely freezing a vessel of water (Fig. 2), not only does the entangled air increase in quantity downwards, but at the base of the frozen mass occurs a large air-cavity (*e*, Fig. 2).

All these facts, and the results of the experiments, seem to point to the fact that, in the process of freezing, the elimination of the air and gases in solution is taking place in two directions: (1) a part of the air is taken into solution by the unfrozen water as it is progressively rejected by the thickening coat of ice; and (2), a part of it is extruded as bubbles of air, which become entangled in the ice.

If each stratum of ice eliminated the whole of its own proportion of air in solution in the gaseous form, the bubbles would be distributed with fair regularity throughout the collective mass, but their progressive increase in a descending direction exactly agrees with the continuous surcharging of the underlying unfrozen water with the air in solution rejected by the ice above, till, at the end of the freezing process of the mass, the remnant is extruded as one large bubble (Fig. 2, *e*) at its base.

The rejection of the air into continued solution would seem to take precedence of its extrusion in the gaseous form, and would go on as long as there was a sufficient body of adjacent water in a condition to receive it; but the gradual surcharging of a limited body of water with the rejected air is necessarily accompanied by its progressively increased extrusion in the gaseous form.

The comparative absence of air-bubbles in ice over deep water is accounted for by the fact of there being a sufficient body of adjacent water in a condition to receive the rejected air into solution in preference to its extrusion as gas.

To briefly recapitulate the experimental results:—(1) In a thin ice-coating, the upper or surface half contains barely a trace of eliminated air, whilst its under or bottom half contained 0.08 cubic inch of air in each pound of ice. (2) A surface coating of ice $1\frac{1}{2}$ inch thick contained 0.15 cubic inch of air in each pound weight, whilst an entirely frozen mass contained 0.59 cubic inch of air in each pound weight. (3) The freezing of a limited body of water which had been first frozen over and the surface ice removed points still more strikingly to the concentration of air in solution; for this contained 0.89 cubic inch of air in each pound weight, compared with 0.15 cubic inch in surface ice, and 0.59 cubic inch in an entirely frozen mass.

The water employed in these experiments was from the East Surrey Waterworks.

GEORGE MAW

NOTES

THE following notice of motion has been given by Mr. Howell, M.P.:—"To call the attention of the House to the subject of technical education, and to move the following resolution:—'That, in the opinion of this House, it is essential to the maintenance and development of our manufacturing and agricultural industries, in view of the rapidly increasing competition of other nations, both in home markets and abroad; and in consequence of the almost universal abandonment of the system of apprenticeship; that our national scheme of education should be so widened as to bring technical instruction, the teaching of the natural sciences, and manual training, within the reach of the working classes throughout the country.'"

It is stated that in consequence of the financial difficulties of the Bristol College, and lack of endowments, the salaries of all the Professors will be reduced by the Council, and some Chairs are to be abolished. The course pursued by the Council has given rise to much correspondence in the local papers during the past month. It is earnestly to be hoped that circumstances may yet

be found to cause the Council to reconsider their position, and that a course so disastrous to the College—an institution which, in spite of its insecure position, has done excellent educational work—and to the town itself, may yet be averted. Is Bristol so flourishing that the citizens can afford to neglect the only true foundation for prosperous trade and commerce at the present time, when we are trying to compete in the markets of the world with men more highly trained than ourselves?

THE Guthrie Memorial Fund, which will shortly be closed, has now nearly reached the sum of 1400*l.* As we explained some time ago, Prof. Guthrie was too exclusively devoted to teaching and scientific research to be able to make adequate provision for his family. The object of the fund is to place his children as nearly as possible in the position they would have occupied but for his untimely death; and subscribers have been glad to have this opportunity of expressing their appreciation of his personal character and scientific labours.

WE are glad to learn that the University Extension Scheme, which has led to such excellent results in England, is likely to be tried in Scotland. The question has been for some time under the consideration of the University Court of Glasgow, and now the matter has been taken in hand by some energetic University men in Edinburgh. The proposal is that the available lecturing power of the Scottish Universities shall be united, so that while any town would naturally in the first place be supplied as far as possible from the nearest University, any desired course might be drawn from a more distant one. It is hoped that in the larger towns Extension Colleges may be established. These institutions might be made permanent by means of small endowments, or towns might secure them as centres of regular teaching for a certain number of years by subscribing a few hundred pounds to make up the deficit from fees.

DR. LEUTHNER, of Vienna, author of a remarkable memoir on the Odontolabini, a subdivision of the Coleopterous family Lucanidae, published in the Zoological Society's Transactions in 1885, will shortly leave Europe on a collecting expedition to South Arabia and Socotra, where much work remains to be done, notwithstanding several recent excursions to the same district. Dr. Leuthner's expedition is of a private nature, but he has the full support of the Austro-Hungarian Government, and a free passage in their ships.

PROF. G. SÉE has recently published a new book, concerning diet in disease ("Du Régime alimentaire: Traitement hygiénique des Malades"). M. Sée, although he has never studied physiological questions in a special manner, always writes useful books, being familiar with English and German, and very well posted in all foreign experiments and work. The most interesting part of his book, from a physiological point of view, is that in which he discusses the question of foods and their constituents. Criticising the food-ration of the French army, he says that too much bread is allowed, and too little meat.

THE volume of the *Indian Antiquary* for the past year contains a most interesting series of papers by Mr. H. G. M. Murray-Aynsley, under the modest title, "Discursive Contributions towards the Comparative Study of Asiatic Symbolism." They commence in the March number, and, with the exception of the issues for June and July, are continued consecutively down to, and including, the November number, and are not yet completed. One feature of special value to the European student is the method of illustration adopted. The plates are numerous, and beautifully executed, and a large number describe objects collected by the writer himself in Northern India, which have probably never before been seen by the majority of Western scholars. It is to be hoped that Mr. Murray-Aynsley will ultimately collect these papers

into a volume; at present we can do no more than barely indicate the outlines of their contents. His chief object is to make a collection of facts bearing upon the subject of customs and symbols, and, after a general introduction, a chapter is devoted to each of the following divisions:—(1) Sun and cup (or moon) symbols; (2) sun-worship; (3) the *Svastika*, or emblem of fire; (4) stones worshipped in India, and their counterparts in Scandinavia and other parts of Europe; (5) the land of departed souls; (6) the trees which have been held sacred in the East and in Europe; (7) snake-worship; (8) amulets and charms; (9) the evil eye; (10) the wild huntsman of Northern Europe and his possible Asiatic origin; (11) Eastern architecture compared with certain old churches and houses in Norway; (12) Asiatic symbolism in Spain. While this may give a notion of the general contents of these papers, it gives none whatever of the mass of facts collected from different sources, principally by the author himself in India and Cashmere. The coloured illustrations of the *Svastika* symbol, showing the wide area over which it is employed, are very interesting. In addition to many others given, the author might well have added that it is almost universal in this country as a bordering to the commoner kinds of linoleum and other floor-cloths, the manufacturers having probably borrowed it from the designs on Central Asian carpets and rugs.

AN important addition has just been made to the Zoological Society's Collection in the Regent's Park, in the shape of three fine specimens of the sea-lion or eared seal of the Auckland Islands (*Otaria hookeri*). These animals, originally four in number, one having been lost during the transit home, were captured in the Auckland Islands, which lie in the Antarctic Ocean, some 900 miles south of Tasmania, by Capt. John Fairchild, master of the New Zealand Government steamer *Hinemoa*, and were sent to London in the steamship *Tongariro* by the Hon. W. J. M. Larnach, C.M.G., Minister of Marine of New Zealand, as a present to the Zoological Society. The Zoological Society's menagerie already contained specimens of the sea-lion of the Falkland Islands (*Otaria jubata*), and of the Cape sea-lion (*Otaria pusilla*), but no example of the present rarer species has been previously brought alive to Europe. There are, however, stuffed specimens of this animal in the Museum of Natural History in the Jardin des Plantes, Paris.

IN the Report of the Fish and Game Commissioners of Massachusetts for 1886, there is an interesting paper by Mr. George Dimmock on certain fish-destroying insects in the United States. The largest of them, and the most dangerous to fishes, are those which belong to the family called Belostomidæ. They are provided with powerful fore-legs, and strong, somewhat oar-shaped hind-legs for swimming; and, when full-grown, they have vigorous wings, and are capable of long-sustained flight. In seizing upon fishes or other small animals, they grasp their prey with their fore-feet, holding it firmly in their claws. Then they pierce it with their beak or proboscis, and suck its blood. They are strongly attracted by the electric light, and Mr. Dimmock suggests that it might be used as a means of destroying them, as it would be easy to contrive a trap that would retain them when they fall after striking the glass. An illuminated trap beneath the surface of the water might, he thinks, be more effective than one above the surface, for the Belostomidæ do not often leave the water, apparently, except when they quit it for the purpose of migration.

THE United States Fish Commission print in one of their recent Bulletins an excellent report by Mrs. Emma Metcalf Beckley, Curator of the Hawaiian National Museum, on "Hawaiian Fishing Implements and Methods of Fishing." The writer gives some curious details about octopus-fishing. The smaller kinds of octopus, which live in shallow water, are caught by women, who do their work with remarkable skill. They can

tell whether an octopus is in a hole whose entrance is no larger than a silver dollar, and, plunging their spears in, they invariably draw one out. The larger kind of octopus, which are always found in deep water, are caught by men with cowries, generally of the Mauritiana, but sometimes of the tiger species. An octopus will not rise to a large-spotted or ugly cowry, so the fishermen have to take care that the spots on the back of the shell are very small and red, breaking through a reddish-brown ground. Cowries with suitable spots, but objectionable otherwise, are slightly steamed over a fire of sugar-cane husks, a process which gives them the desired hue. The fisherman, having arrived at his fishing-grounds, first chews and spits on the water a mouthful of candle-nut meat, which renders the water glassy and clear; he then drops the shell with hook and line into the water, and swings it over a place likely to be inhabited by an octopus. The moment an octopus perceives a cowry, it shoots an arm out and clasps the shell. If the shell is of the attractive kind, one arm after the other comes out, and finally the whole body of the octopus is withdrawn from the hole and attaches itself to the cowry, which it closely hugs, curling itself all around it. The creature remains very quiet while being rapidly drawn up through the water. Just as it reaches the surface, the fisherman pulls the string so as to bring its head against the edge of the canoe, and it is killed by a blow from a club which is struck between the eyes. This must be done rapidly, before the animal has time to become alarmed; for if it lets go the cowry, it becomes a dangerous antagonist, and there is risk of the fisherman being squeezed to death. The cutting off of one or more of its eight arms does not affect the rest in the least.

WE have received *Studies in Microscopical Science*, vol. iv. No. 6, Sections 1-4. The text of the first three sections relates to botanical, animal, and pathological histology; that of the fourth to marine Algae. The plates are very delicately executed.

WE have also received the seventh, eighth, and ninth parts of the Transactions of the Yorkshire Naturalists' Union. Among the contents is an interesting presidential address on "The Fathers of Yorkshire Botany," delivered, in 1884, by Mr. J. G. Baker, F.R.S., President of the Yorkshire Naturalists' Union.

THE Selborne Society intend to issue letters, from time to time, on its objects and work. They will be written by members who have a special knowledge of the subjects discussed. The first of the series, which has just been published, is on the feeding and protection of wild birds in winter. The next will be on the Wild Birds Protection Acts of 1880 and 1881, and their bearing on bird-catching and bird-nesting during the close season. Other letters will follow on birds, trees, and plants, and it may be hoped that the scheme will be of considerable service in disseminating a knowledge of practical natural history.

THE French Government has purchased the hillock of Sansan (Département du Gers), which is famous for its richness in fossil animal remains. M. E. Lartet was the first discoverer of this palæontological treasure. M. Filhol, the naturalist, has recently examined the hillock; he was commissioned by the Professor of Palæontology at the Jardin des Plantes, Paris. This gentleman, supported by M. Cavaré, found fossil remains not only of Mastodons, Macrotheria, Chalicotheria, &c., but also of bears, stags, dogs, and cats. Noteworthy are some stags' horns, with two main branches, or so-called Dicroceri. All these fossils will be deposited in a museum to be built at Sansan, and will be described in a catalogue by M. Filhol.

PROF. W. J. TSINGER, at Moscow, is busily engaged in preparing his bulky work on the flora of Middle Russia, including the floras of the fifteen central provinces.

A LEARNED Society called the Società Italiana Asiatica has been formed in Italy for the investigation of Eastern languages and archæology. Prof. Amari has been elected Honorary President. The Society has obtained the collaboration of the best Italian Orientalists, and has nominated twenty-four foreign honorary members, among whom are Profs. Böhtlingk, Max Müller, Roth, Fleischer, Renan, Weber, Whitney, Rawlinson, Maspero, Legge, Brugsch, and Friedrich Müller.

THE Anthropological Society of Bombay, the establishment of which less than a year ago has been noticed in these columns, has already over 300 members, and has published the first number of its Transactions. Mr. Tyrrell Leith, the founder of the Society, has a paper on divination by Hazirat among the Indian Mussulmans; Dr. Dymock writes on the hairy man of Burmah, and Indian necromancy; Dr. Weir, on sacrifice in India as a means of preventing epidemics; and Dr. Basu, on embalming in Ancient India, and on Nisi, the night demon. There are other papers, but this list is sufficient to show the activity and utility of the new Society.

THE author of the paper on "Mexican Codices and Graven Inscriptions" inadvertently referred to in a Note last week as "Mr. Z. Nuttall," is "Mrs. Zelia Nuttall," one of two American ladies elected to the honorary position of "Special Assistant" of the Peabody Museum of Archæology, Cambridge, Mass. The paper in question was communicated to the American Association for the Advancement of Science in August last, when Mrs. Zelia Nuttall announced her discovery of "determinative signs," forming a key to Aztec phonetic manuscript records and graven inscriptions, and presented, in support of her statements, comparative tables of phonetic signs for inspection to the Section of Anthropology. Mrs. Zelia Nuttall has recently contributed to the *American Journal of Archæology* an account of the terra-cotta heads of Teotihuacan. These little clay heads, of most varied types, are frequently found in the vicinity of the great pyramids at San Juan Teotihuacan, about 30 miles north-east of the city of Mexico. They had been generally considered the work of different races of people, inhabitants of the valley of Mexico at successive periods, and were therefore held to be of considerable antiquity. Mrs. Zelia Nuttall's comparative researches prove them to be of Aztec workmanship, and thus of more modern date. She found that several of the most typical head-dresses modelled in clay were identical with those worn by Aztecs of different social grades, as depicted in Spanish chronicles at the time of the conquest of Mexico. Mrs. Nuttall adduces satisfactory proofs that these little clay heads were the portrait-models of dead persons adorned with the insignia of their rank. Attached to bodies of perishable materials, they served as effigies of the dead, and were placed on the coffers or jars containing the cremated remains, which were kept in the household dwellings of the relatives. Food and wine were offered before them, incense was burnt, and, at certain prescribed recurrent ceremonies, animals were sacrificed in their honour.

WE notice, in the last *Bulletin* of the St. Petersburg Academy of Sciences, a valuable preliminary sketch of the avifauna of the western spurs of the Pamir plateau and its northern border-ridge, the Altai Mountains, by V. Bianchi. The birds were collected by M. Grum-Grzimalo, and the collection includes 136 species, which probably represent about one-third of the species inhabiting the region. With the exception of nine species, the same were found by Dr. Severtzoff in Bokhara, and described in the *Journal of Ornithology*, 1875; and only five species are not yet known in Russian Turkestan. It thus appears that the avifauna of the Western Pamir is very similar to that of the region situated on the other slope of the Kashgar-daban Mountains. Nearly a hundred species out of the

above-mentioned 136 are also found in the Western Himalayas, but this last region has a number of endemic species which give it its special character. The poverty of the fauna of the Pamir plateau is obviously the consequence of its valleys being at a height of no less than 10,000 feet above the sea-level. The presence of the following species in the region will be interesting to zoo-geographers:—*Saxicola finschi*, *Cyanocula leucocyana*, *Herbivocula neglecta*, *Acanthopneuste nitida*, *Trochalopteryx lineatum*, *Microcichla scouleri*, *Cyanistes flavipectus*, *Rhodopechys sanguinea*, and *Nisaietus fasciatus*.

In the *Zeitschrift für Instrumentenkunde* for September 1886 there is a paper entitled "Ueber eine Methode zur Messung kleiner Winkeldifferenzen," by Herr Hugo Langner, of Breslau. It describes a method of measuring the angle between two plane reflecting surfaces when it is nearly an aliquot part of two right angles, by measuring the difference between the required angle and the nearest aliquot part. It is known that in looking into the angle formed by two such surfaces the image of any small object lying between them will be seen repeated. If the angle be nearly $\frac{\pi}{n}$ (say $\frac{\pi}{n} - \delta$), then when δ is positive, there

will be a certain portion of the space between the two reflecting planes where both n th images can be seen, but if δ be negative, there will be a space where neither can be seen. If, again, for a small object a scale be substituted, then when δ is + two images will be seen, and a certain portion of the scale will be seen in both images; while if δ be - there will be a portion which is in neither image, and this superfluous or defective portion will be a measure of δ . Herr Langner proposes to place in front of the angle, and at a considerable distance from it, a scale bent to a cylinder whose axis is the intersection of the reflecting planes. Observing with a telescope looking into the angle, the position where a division of one image of the scale falls on the other image can be read, and, if the radius of the scale be known, the angle subtended by the relative displacement of the images, and thence the difference between the approximate and real values of the angle between the reflecting surfaces found. Herr Langner gives as an example the determination of the angle of a right angled prism of glass, of which a single determination would seem not to be liable to a greater error than 4" or 5". And he suggests that the method might be applied advantageously to determine the movements of a magnet by determining from time to time the changes of the angle between a mirror fixed to the needle, and one which is absolutely fixed, and to measure small variations of an angle in other cases.

The little marine laboratory connected with the Johns Hopkins University is almost as old as the great laboratory at Naples. A sketch of its history is presented in a recent report by Dr. W. K. Brooks, Director of the Marine Laboratory, to the President of the Johns Hopkins University. In 1878 a small appropriation was made by the Trustees of the University to enable a party of biologists to spend a few weeks at the seashore in the study of marine zoology; and the scientific results of the season's work were printed in an illustrated volume, the cost of publishing which was borne by some citizens of Baltimore. The next year the appropriation was renewed, and in 1880 the Trustees voted that the laboratory should be continued for three years more, providing 4500 dollars for outfit and an annual sum of 1000 dollars for current expenses. The scheme worked so well that at the end of three years the institution was maintained. After an examination of all the available localities, the town of Beaufort, N.C., about 400 miles south of Baltimore, was selected as the site for the laboratory; and a vacant house, suitable for the accommodation of a small party, was found, and rented as a laboratory and lodgings. This house has been occupied during five seasons, and much good work has been done in

it. During the season of 1886 a party of seven students went, under the direction of Dr. Brooks, to carry on zoological investigation in the Bahama Islands.

THE additions to the Zoological Society's Gardens during the past week include three Hooker's Sea Lions (*Otaria hookeri* ♂ & ♀) from New Zealand, presented by the Government of New Zealand; a Blue Penguin (*Eudyptula minor*) from New Zealand, presented by Dr. Bernard Lawson; a Domestic Sheep (*Ovis aries* ♂, four-horned var.) from Cashmere, presented by Major Roland Poole; two Wood Hares (*Lepus sylvaticus*) from North America, presented by Mr. Walter Ingram, F.Z.S.; a Blotched Genet (*Genetta tigrina*) from South Africa, presented by Capt. J. Robinson; a Grey Ichneumon (*Herpestes griseus*) from India, presented by Mr. Stanlake Batson; a Spotted-billed Duck (*Anas pecilorhyncha*) from India, received in exchange; three Lions (*Felis leo*), an Axis Deer (*Cervus axis* ♂) born in the Gardens.

OUR ASTRONOMICAL COLUMN

THE NEW ALGOL-TYPE VARIABLE.—Mr. Chandler has been able (*Gould's Astronomical Journal*, No. 150) to secure some further observations of this star, which, so far as they go, tend to confirm the hypothesis of a period of about three days. Minima were observed on January 2 and 11, but these were inconclusive as to the period. The star was, however, observed on January 12, between 17h. 15h. and 18h. 5m., to be apparently of its normal maximum brilliancy, whereas the first rough elements formed would have given a minimum at 17h. 50m., had the period been 1.4992d. or 0.7496d. Further observations are much desired. It unfortunately happens, from the star's period being very closely commensurable with the mean solar day, that further observations of minima will be scarcely possible in Northern Europe or Eastern North America for many months.

GORE'S VARIABLE NEAR χ^1 ORIONIS.—Dr. G. Müller, from a series of observations extending from 1886 November 9 to 1887 January 8, finds that the star attained its maximum on 1886 December 12. Assuming the light-curve the same at the preceding maximum, it will have been at its brightest on 1885 December 13, so that the period will be about 364 days.

THE SOUTHERN COMET.—The following telegram has been received from Cape Town, from which it appears that the new southern comet resembles that of 1880 l. in its orbit as well as in its physical appearance:—"Cape Town, January 26.—No condensation observable; riband of light 35" long, narrowing towards sun, position narrowest part near as can observe, January 22.317 G.M.T., R.A. = 322° 31', N.P.D. = 135° 48'. The orbit presents a close resemblance to Comet 1880 l. Perihelion, January 11, noon." The comet is rapidly diminishing in brightness, and it is already invisible to the naked eye.

A SHORT METHOD FOR COMPUTING REFRACTIONS.—In the *Astronomische Nachrichten*, No. 2768, Mr. Schaeberle, of the Ann Arbor Observatory, explains a short and convenient method for computing astronomical refractions between 0° and 45° zenith distance. Let k and k_0 be respectively the true and mean refractions when $z = 45^\circ$, then for any other zenith distance less than 45° the approximate true and mean refractions would be given respectively by

$$r = k \tan z, \quad r_0 = k_0 \tan z,$$

from which is derived

$$r = r_0 - \frac{k_0 - k}{k_0} r_0,$$

an expression which, for the assigned limits of zenith distance, will give the true refraction within 0".01, provided the true value of r_0 is used in the second member of the equation. The factor $\frac{k_0 - k}{k_0}$ will, however, be constant only so long as the barometer and thermometer readings remain unchanged. To allow for changes in these quantities, let F_1 and F_2 denote respectively the values of these factors at the times T_1 and T_2 ;

the value of the factor at any intermediate time T will be given by

$$F = F_1 + \frac{T - T_1}{T_2 - T_1} (F_2 - F_1),$$

which can be easily taken from a table of double entry with the arguments barometer reading and thermometer reading. Such a table, together with one giving the values of the mean refractions computed to hundredths of a second of arc for every ten minutes of zenith distance, and a convenient multiplication table, are all that is required for the practical application of Mr. Schaeberle's method.

COMET BROOKS (1887 *b*).—A Science Observer Circular (No. 19) gives the following elements and ephemeris for this object

$$\begin{aligned} T &= 1887 \text{ March } 28 \cdot 63 \text{ G.M.T.} \\ &= 121 \quad 20 \\ \Omega &= 294 \quad 45 \\ i &= 94 \quad 17 \\ \log q &= 0 \cdot 1016 \end{aligned} \left. \begin{array}{l} \\ \\ \\ \\ \end{array} \right\} \text{Mean Eq. 1887} \cdot 0$$

1887		Ephemeris for Greenwich Midnight		R.A.		Decl.		Brightness	
Jan. 31	...	305	24	...	+ 79	5	...	1	41
Feb. 4	...	337	32	...	79	59	...		
8	...	8	39	...	77	41	...		
12	...	28	4	...	72	57	...	1	95

The brightness at discovery is taken as unity.

ASTRONOMICAL PHENOMENA FOR THE WEEK 1887 FEBRUARY 6-12

(FOR the reckoning of time the civil day, commencing at Greenwich mean midnight, counting the hours on to 24, is here employed.)

At Greenwich on February 6

Sun rises, 7h. 32m.; souths, 12h. 14m. 18' 5s.; sets, 16h. 56m.; decl. on meridian, 15° 37' S.; Sidereal Time at Sunset, 2h. 2m.

Moon (Full on February 8) rises, 14h. 54m.; souths, 22h. 49m.; sets, 6h. 37m.*; decl. on meridian, 18° 2' N.

Planet	Rises	Souths	Sets	Decl. on meridian
	h. m.	h. m.	h. m.	°
Mercury	7 46	12 16	16 46	17 38 S.
Venus	8 14	13 17	18 20	11 47 S.
Mars	8 14	13 23	18 32	10 39 S.
Jupiter	0 10	5 11	10 12	12 8 S.
Saturn	13 58	22 6	6 14*	22 16 N.

* Indicates that the setting is that of the following morning.

Feb.	h.	
6	6	Saturn in conjunction with and 3° 21' north of the Moon.
6	18	Mercury in superior conjunction with the Sun.
8	—	A partial eclipse of the Moon occurs in the morning, not visible in Europe.

Saturn, February 6.—Outer major axis of outer ring = 45"·8; outer minor axis of outer ring = 18"·8; southern surface visible.

Variable Stars

Star	R.A.	Decl.	h. m.
	h. m.	h. m.	h. m.
S Ceti	0 18' 3	9 57 S.	Feb. 11, 0 0 M
U Cephei	0 52' 3	81 16 N.	" 10, 21 19 m
Algol	3 0' 8	40 31 N.	" 8, 1 12 m
			" 10, 22 1 m
V Tauri	4 45' 5	17 21 N.	" 12, M
ζ Geminorum	6 57' 4	20 44 N.	" 8, 4 0 m
U Monocerotis	7 25' 4	9 33 S.	" 6, M
S Cancrī	8 37' 5	19 26 N.	" 12, 0 11 m
δ Libræ	14 54' 9	8 4 S.	" 10, 1 23 m
U Coronæ	15 13' 6	32 4 N.	" 7, 3 55 m
U Ophiuchi	17 10' 8	1 20 N.	" 9, 5 48 m
		and at intervals of 20 8	
δ Lyræ	18 45' 9	33 14 N.	Feb. 8, 0 0 M
			" 11, 6 0 m
S Vulpeculæ	19 43' 8	27 0 N.	" 11, m
χ Cygni	19 46' 2	32 38 N.	" 6, M
ν Cygni	20 37' 7	47 44 N.	" 8, M
δ Cephei	22 25' 0	57 50 N.	" 7, 19 0 m

M signifies maximum; m minimum.

Occultations of Stars by the Moon (visible at Greenwich)

Feb.	Star	Mag.	Disap.	Reap.	Corresponding angles from vertex to right for inverted image
			h. m.	h. m.	°
6	3 Cancrī	6	21 17	22 27	77 239
7	B.A.C. 2731	6½	2 13	2 47	172 239
7	54 Cancrī	6½	16 29	17 14	77 195
7	0' Cancrī	6	19 21	near approach	132 —
11	46 Virginis	6	23 17	0 19†	23 226
12	48 Virginis	6	1 43	2 7	336 299

† Occurs on the following morning.

GEOGRAPHICAL NOTES

VARIOUS rumours have been afloat during the past week as to difficulties having arisen between the Egyptian Government and Mr. Stanley and as to the escape of Emin Pasha. To these rumours Mr. Stanley has telegraphed a positive contradiction, and it should be remembered that there is a small party in Egypt opposed both to the expedition and to Emin Pasha. Mr. Stanley leaves Cairo this week for Zanzibar, and every preparation has been made for his taking the Congo route. Meantime important information has reached Europe from Dr. Junker as to his explorations in what is known as the Wellé-Makua region. Dr. Junker's furthest position on the River Wellé, according to the calculation of Dr. Schweinfurth, was the village of Bassanga, 22° 47' 40" E. of Greenwich, and 3° 13' 10" N. lat. This position, combined with what we already know of the course of the Wellé, leaves little doubt that it is an affluent of the Congo. But that it reaches the Congo through the recently-discovered Mobangi is by no means so certain. Taking into account the altitudes and the general lie of the country, it seems more probable that it reaches the Congo at some point between the Mobangi and the Aruwimi. However, this is one of the problems which it is hoped Mr. Stanley will be able to solve. And even if Emin Pasha has escaped, it is to be hoped that the expedition will proceed, if not to take possession of the Equatorial Province, at least to carry out the exploring work which Mr. Stanley has planned for himself. The attempt of the Balloon Society to get up a second expedition by the Congo it is impossible to treat seriously.

To the new number of the Proceedings of the Royal Geographical Society Dr. Edmund Naumann, late head of the Geological Survey of Japan, contributes a paper of great scientific value, on the physical geography of Japan, in which he gives the results of his own surveys. Considering the Japanese chain as one continuous mass, the lowest parts of which are submerged, this great wave of the earth's surface bears the same relation to the Pacific Basin, according to Dr. Naumann, as the Himalaya mass does to the Indian peninsula. The dimensions of the two colossal earth-waves are almost equal. The ocean-bed on the Pacific side of Japan really rises very gradually to the coast-line, making an angle of not more than 3°, while on the opposite side the inclination is very slight indeed. The general character of the Japanese earth-wave establishes its close relation to the Asiatic continent. In fact, it is nothing else than the advanced frontier of Asia, and not a chain of volcanic ejections accumulated over a fissure of the ocean-bed, as certain famous geographers of past periods conjectured. One of the most original and interesting parts of Dr. Naumann's paper is that in which he deals with the magnetic map of Japan, a reproduction of which is given in the Proceedings. On this map is perceived a most remarkable correspondence between the lines of equal declination (the trogons) and the leading lines of geological structure described by Dr. Naumann. In general, the magnetic lines exhibit very striking and quite unexpected irregularities, and these irregularities are found to be in most intimate connection with the abnormal curvature of the folds. No less than two hundred complete observations for magnetism, at a like number of stations, were made. The results seem extremely satisfactory. Across the centre of the main island is a great depression which Dr. Naumann calls the Fossa Magna, and the map shows that the magnetic lines are influenced in their course by this cleft, in the same manner as by the folds. He is even inclined to say that the deviations of the lines of equal declination and the fold lines coincide to a certain extent. Where one of the great lines of horizontal dislocation, separating two unequally advanced sections of the Japanese Archipelago, crosses the chain, the

trogones describe bends and sinuosities of a most peculiar character. As Dr. Naumann states, these results seem to open up a new field of research quite worth investigating.

A PAPER of unusual scientific interest was read at Monday's meeting of the Royal Geographical Society by Mr. H. J. Mackinder, B.A. (Oxford), on the field and methods of geography. Mr. Mackinder aimed at showing how geography could be made more than a mere cultivation of dry facts, and become indeed a department of scientific inquiry. He takes man as the centre of the field and defines geography as the study of man in relation to so much of his environment as varies locally; Mr. Mackinder thus takes geography to be the physical basis of history. He insists on a clear separation being made between physical geography and both geology and physiography. The physical geographer has to deal with only so much of the past as will enable him to interpret the present, whereas the geologist deals with the present, only that he may be able to interpret the past. So with other departments of science, as meteorology; from the new stand-point only so much of them is to be included as is pertinent to the geographical line of investigation. Mr. Mackinder illustrated his position by two sets of three maps—one of South-Eastern England, physical, geological, political; and the other of India, showing physical features in relation to rainfall and population. He attempted to show, on the basis of physical conditions, why, among other things, London should have become the metropolis of the Empire and why the three south-eastern counties should have had their existing boundaries. With reference to India, again, he showed how geographical conditions determined that Delhi and Calcutta should have become the ancient and modern capitals of India. Geography, when studied in this way, Mr. Mackinder thinks, might become a bridge between the physical sciences on the one hand and classical and historical studies on the other. The lecture was illustrated by some very fine and instructive maps and lantern views.

PHYSICAL NOTES

THE inverse electromotive force of the voltaic arc has recently been investigated by Prof. C. R. Cross, of the Massachusetts Institute of Technology, and by Mr. W. E. Shepard. It appears that with currents varying from 3 to 10 amperes the inverse electromotive force is about 39 volts when the arc is silent, and about 15 volts when it is hissing; but both these values show a diminution as the currents employed are increased. The transition from one state to the other is abrupt. Addition of volatile metallic salts to the arc always decreases the inverse electromotive force. In rarefied air the inverse electromotive force is unaltered, but the true resistance of the arc is diminished.

SENSITIVE hygrometers have lately been constructed upon a principle resembling Bregnet's metallic thermometer. A spiral composed of two substances having different hygrometric coefficients of expansion tends to curl or uncurl according to changes in the hygrometric state of the air. Some of these have been made by Prof. W. Holtz out of thin brass spirals with a thin coating of gelatine on one side. Independently, M. Nodon, of Paris, has constructed some recording hygrometers having spirals made of Bristol board coated on one side with gelatine (with a little salicylic acid), and on the other with bitumen. The principle is not new: in various collections of physical apparatus similar arrangements have existed for at least a dozen years.

LENSES which magnify, and yet are perfectly flat on both sides, have been constructed by Schott and Co., of Jena, the manufacturers of Abbé's optical glass. These lenses are mere curiosities. They consist of single disks of glass, such that the refractive index decreases in a regular manner from the surface inwards. The properties of this arrangement have been investigated by Prof. K. Exner, of Vienna.

QUADRANT electrometers have been lately described by M. Ledebor, in which the motion of the needle (often of very annoying duration) is damped so as to be aperiodic. This is achieved by making each of the four "quadrants" of steel highly magnetised. The needle is therefore damped by magnetic friction. The suspension is unifilar.

SEVERAL modifications have been lately introduced into the Leclanché battery. Mr. Sydney Walker proposes to substitute

sulphur for the manganese: it is cheaper, and less of it is required. Mr. A. Pollak does away with the manganese, but employs a special, porous, coarse, annular block of carbon, which stands half out of the liquid and absorbs oxygen from the air to depolarise. M. Germain introduces a novel material to hold the liquid, an absorbent preparation, chiefly cellulose, made from coco-nut fibre, and which has received the curious name of "cofferdam." It has truly remarkable absorbent properties, as it will suck up and hold from twelve to fourteen times its own weight of water. A "cofferdam" cell does not spill the liquid.

DRY portable cells appear to be coming into favour, gelatine being the favourite medium. They are claimed as novelties both in Paris and in Frankfort. Joule's "glue-battery"—a Daniell's cell, having a gelatinous mass impregnated with sulphates of copper and zinc—is the parent of all these later forms.

ELECTRIC welding is the latest of the industrial applications of electricity, and it would seem to have already reached a thoroughly practical stage. Prof. Elihu Thomson, of Lynn, Massachusetts, has shown that bars of iron, steel, copper, and brass can be welded firmly together in a few seconds by passing through their junction a very powerful electric current. He has invented a special kind of transformer or induction coil to enable him to accomplish this operation. It is possible thus to weld iron and brass together in a firm joint. Simultaneously, researches on the same subject have been made by two Russian gentlemen in the laboratory of M. Marcel Deprez in Paris, and they have announced their discovery under the name of "electrohephaest." If we are not mistaken, similar experiments were made before the Académie des Sciences some years ago by the late M. Ruhmkorff. Moreover, in Mr. J. P. Joule's papers he mentions the discovery of the practicability of electric welding by himself and Sir William Thomson.

ACCORDING to Olszewski, the critical temperatures of nitrogen and oxygen are respectively -146° , -118.8° , of the Centigrade scale.

ON THE MORPHOLOGY OF BIRDS¹

THERE are several things that go to increase the interest in the morphology of these culminating Sauropsida at the present time.

(1) The discovery by Gegenbaur, Huxley, and others, of the close relationship of birds and reptiles, especially of the extraordinary fact that the hind-limb and pelvis of even the most minute bird pass through a stage in which they correspond almost exactly with the hind-limb and pelvis of the most gigantic kinds of extinct reptiles—the Dinosaurs or Ornithoscelida.

(2) The recent discoveries of biologists as to the composition of the cheiropterygium in the various types of air-breathing Vertebrata. It is now well known that the five-fingered hand and the foot with five toes are the specialised modern representatives of hands and feet that had at least seven rays in their composition.

And (3) the study of the development and general morphology of birds is at the present time of great interest, now that we are looking to the study of metamorphosis for some initial elucidation of the mystery as to the origin of the various types of Vertebrata.

The labour of each succeeding day at this culminating class makes it more and more impossible for me to conceive of birds as arising *direct* from the Dinosaurians, or indeed from any other order or group of reptiles.

Long attention to the metamorphosis of the Amphibia has intensified this difficulty to me; for the newly-transformed frog or newt appears to me to be the true counterpart of a newly-hatched reptile—snake, lizard, turtle, or crocodile.

Each of these young creatures, whether it has undergone a true metamorphosis or has been the subject of pre-natal transformation, is evidently an imago, although an imago that continues to grow.

Now each amphibian has its own larva, for the larvæ of the various species have their specific differences.

The thousand known species of existing Amphibia—Anurans, Urodeles, and Cæcilians—and all the fishes that undergo meta-

¹ Paper by Prof. W. K. Parker, F.R.S., read before the Royal Society on January 27, 1887.

morphosis, are as truly, if not as remarkably, distinct from each other in their larval as in their imago form; as much so as is the case in insects, or any other of those invertebrate types that are truly metamorphic.

If many of the existing Vertebrata are metamorphic now, is it not very probable that they were all metamorphic once?

The fact that we have even now such forms as the larval lamprey (or *Ammocete*), the larvæ of Ganoids and Dipnoi, and the tadpoles of newts and frogs, suggests to me the possibility of the existence of huge swarms of low proto-Vertebrata in the early ages of the inhabited planet.

If such proto-vertebrate forms existed, then it is quite supposable that a metamorphosis may, from time to time, have taken place, of this and that quasi-larval form into archaic reptile, ancestral bird, or primitive mammal.

I am not afraid that anyone familiar with the development, structure, and habits of the existing Amphibia will see any difficulty in the passage of a metamorphic into a so-called non-metamorphic type, during time, and under the pressure of new outward conditions—when the dilemma offered to the supposed low vertebrate was *Transform or perish*.

To me it seems that the creature's necessity was Nature's opportunity; and that, during long ages, the morphological force had accumulated in those low forms an enormous surplusage of unused energy, which, in the ripeness of time, blossomed out into this and that new and noble type.

Of all the types of Vertebrata, there is none like the bird of high degree for illustrating what Prof. Huxley calls "the three-fold law of evolution,"¹ namely, overgrowth of some parts, starvation and even death of others, and fusion of parts originally distinct.

No kind of vertebrate whatever presents to the osteologist so hopeless an enigma in the adult skeleton, as that of the bird; in the overgrowth of certain parts, the abortion or suppression of others, and the extensive fusion of large tracts of skeletal elements.

Hence this class has largely acted upon the morphological mind; the "comparative anatomist" has, of necessity, undergone evolution into the "morphologist," and the latter has had to be refined and developed into the "embryologist."

In the bird class we meet with this remarkable phenomenon, namely, that the swiftest creatures by far that inhabit the earth have had, for the purposes of their most consummate mechanism, the greatest loss of freedom of the individual parts of the skeletal framework.

Between the pigeon, on one hand, above, and the emu, on the other, below, there are several families of related birds; but there is no direct superposition—they are obliquely above or below each other.

Amongst the Carinate, which lie in the intermediate space, there is none better for the purposes of study than the common fowl; to this type I have devoted most attention, and have now worked out the limbs in as many stages as I formerly did the skull.

I can now give an account of the vertebral column with the ribs and sternum, the limb-girdles and limbs, from the end of the seventh day of incubation; by which time the hyaline cartilage is perfect, and certain even of the bony tracts are begun.

The fowl is an intermediate form between the emu and the pigeon, but most akin to the latter. I shall now confine myself to what is seen in the development of the skeleton (excluding the skull) in this medium type.

The vertebral column, at the end of a week's incubation, is formed of hyaline cartilage; up to the end of the true sacra, the notochord is completely invested with cartilage; but, behind those four segments, only at the sides.

The notochord has its constrictions in the middle of each centrum, and is most dilated at the intercentra.

The neural arches do not nearly meet above; the atlas is in four pieces—a superficial and an inner piece to the centrum, and a pair of arch-rudiments; the inner segment of the centrum becomes the odontoid process of the axis.

Between the axis and the first true sacral, all the vertebrae have separate ribs; in the cervical region, except near the dorsal region, there are small styloid cartilages lying horizontally, which have their head, or thick end, wedged in between the upper and lower transverse processes. Near the dorsals they

are transversely placed, and then begin to develop a descending process.

The first vertebra of this stage with complete ribs becomes, by absorption of the lower part of the arch, the last cervical in the adult. Behind the twenty pre-sacra there are fifteen sacra, and this series has its subdivisions.

The first develops ribs (it is dorso-sacral), the next three develop minute but distinct ribs, like those near the lower part of the neck; these are lumbo-sacral. Then come the four sacra with no ribs, and then the seven uro-sacra, the first two of which have rib-bars that ossify separately, below the upper transverse processes, which latter form a complete series from the third cervical to the last free caudal segment.

Of those there are five; then come five more paired imperfect rudiments, clinging to the terminal part of the notochord.

At the end of the eighth day there are six of these, with the last elongated, and the notochord projecting behind far enough for three or four more rudiments.

At the end of the tenth day the vertebral chain has undergone a great change. The atlas is still composed of four distinct pieces of cartilages, but the ribs have become fused above and below with the transverse processes, and the notochord is now most constricted at the intercentra.

Besides this, in the pre-sacra, it is constricted in two places within each centrum; so that each centrum in the modern bird corresponds to three subdivisions of this axial chord.

For two or three days there is evidence of an archaic subdivision of the notochord into three times as many vertebral divisions as are made now in the modern bird.

In the sacral the constrictions are fewer; they are only at the intercentra, and in the middle of the centrum.

The only absolutely necessary part of the sternum is that where the sternal ribs are attached; that is a very small part, and the rest is for the attachment of the huge muscles that act upon the wings, and for the obliqui and recti abdominis.

The limb-girdles are each in three pairs of distinct cartilages. In front, the scapula, the minute pre-coracoid, the coracoid; behind, the ilium, pubis, and ischium; the pre-pubis is part of the ilium, and that has two regions, the pre-ilium and the post-ilium.

These parts in the bird are not continuous tracts of cartilages, ossified by several centres, but are distinct, first as cartilages, then as bony tracts; those of the shoulder keep distinct; those of the hip soon coalesce.

The wings at the end of the seventh day are three-toed webbed paws, with all the digits turned inwards. The rods that compose the main part of it are composed of solid cartilage: the humerus, radius, ulna, and first and second metacarpals have a bony sheath round their middle part; the ends of the digits and the carpals are but partly chondrified. Five carpal nuclei, however, can be made out, and the two proximal nuclei are known to be further subdivided, each into two, in other types; hence we can already account for seven carpals in the bird, which has only two in the adult, in a free state.

Moreover, the first digit has two, and the second three phalanges, the normal number, as in lizards; the third, which should have four, but in birds has as a rule only one, has now two, as in the ostrich, and a few other birds; there is no sign at the end of the seventh or even of the eighth day of incubation of any more than three digits, but we have in the wrist an intermedio-radiale, a centrale-ulnare, and three distal carpals, answering to the three developed metacarpals. The digits up to the end of the eighth day are rounded and flattish, and are quite like those of a young newt or frog. But in two days more, at the end of the tenth day, the wing has almost acquired the adult form; and one more bony centre, that of the first metacarpal, has appeared. The overgrowth of the second distal carpal and the second metacarpal, with its large and dilated digit, has arrested the distal carpal of the first or short digit, the "pollex." This is the last nucleus to chondrify. It is still a very small, limpet-like disk of cartilage, and is now only to be seen on the flexor face of the manus, inside the top of the second metacarpal; the distal carpal of the third ray is also small as compared with the large crescentic second distal nucleus. It is thrown on to the ulnar or outer side of the manus by the overgrowth of the middle rod and its carpal. The curve of the digits at their end is now, not inwards, or to the radial side, but outwards; and the two developed distal segments form now the core of two claws, that of the first, or pollex, being of considerable length.

¹ See his paper "On the Application of the Laws of Evolution to the Arrangement of the Vertebrata, and more especially of the Mammalia" (Zool. Soc. Proc., December 14, 1854, pp. 649-662).

Thus, by the end of the tenth day, the reptilian type or fore-foot has been attained, and the amphibian type lost, whilst the limb as a whole is now a fore-leg no longer, but a wing, thoroughly specialised by evolutionary transformation.

The fore-limb has not simply become modified into a wing by the shortening of the pollex and third ray, the enlargement of the second, and the abortion of the fourth and fifth of a fore-paw, like that of the lizard; but we have now the historical representatives of three more rays which have cropped up since the end of the eighth day.

I have repeatedly noticed that aborted parts, like over-shadowed plants, are late to appear, and soon wither, or are arrested in their growth. This is the case here, for the new rays are late, small, and scarcely functional in the fullest development. They are not lost, however, but, like certain larval structures to be found in the skulls of the highest types of birds, they are built up into the finished wing, although they form an unimportant part of it as far as function goes.

The first of these additional rays is the "pre-pollex"; this is a lunate tract of fibro-cartilage attached to the inner face of the first metacarpal. The other two are composed of true hyaline cartilage, and appear, one on the ulnar side of the second, and the other on the ulnar side of the third developed metacarpal.

I have described them as intercalary metacarpals, for they seem to be the starved twins of the second and third large rays; each distal carpal, very probably, in the archaic forms carried two rays. Thus there is supposed, for such a fore-limb, a digit inside the pollex of the modern bird, and then two pairs of rays, of which only the inner in each case has been retained.

The paddle of Ichthyosaurus shows this kind of primitive cheiropterygium admirably.

Thus we can account for seven carpals and six digits in the wing of the modern bird; in the legs the specialisation is not so intense, but is very great; the study of the embryonic stages shows in many parts that the adult bird gives no signs of whatever.

Instead of there being even two tarsals, free and functional, there is only one, and that has merely the function of a "sesamoid," and has been mistaken continually for a bone of that sort, that nucleus answers to our naviculare, morphologically termed the "centrale."

Notwithstanding the extreme diversity in the habits of existing birds, and the great difference seen in their shank bone, this part is always single, although composed of three metatarsals. As in reptiles, the joint at this part is not between the astragalus and tibia, as in mammals, but through the tarsal series; no sign of this structure is seen in the adult bird. That which appears to be the condyloid end of the tibia is a row of tarsal bones, the tibiale, fibulare, and intermedium: these have long been known as separate bones in young birds, but their distinctness in the early embryo as cartilaginous nuclei has only lately been made out.

I have been able, however, to demonstrate this repeatedly in different kinds of birds. The centrale also, although seen in the embryo as one of the tarsal series, was not properly identified; it is a constant element, but becomes degraded.

The distal series of tarsals exists as a single tract of cartilage, and then as a single plate of bone. But it is related to three metatarsals, and the middle or thick part is the first to chondrify in the embryo, and to ossify in the chicken or young bird; there are here three connate nuclei, with very slight signs of distinctness. The whole mass answers to our middle and external "cuneiform bones," and to the inner half of the "os magnum." Thus five tarsals can be always made out clearly, and two more accounted for.

The first metatarsal, which has been known, for some time, through the valuable researches of Morse, to have occasionally a proximal as well as a distal rudiment, has, I find, always a proximal rudiment as well.

Then, as Dr. G. Baur and Miss A. Johnson have shown, there is a fifth metatarsal; it is a small pisiform cartilage, which soon coalesces with the fourth, and with the great distal tarsal. I can only find a "pre-hallux" by turning to teratology, and this is not the lawful method.

There may, however, be some "reversion" or "atavism" in the polydactyle foot of the Dorking fowl, which has a well-developed "pre-hallux" and a double "hallux"; the twin digits of that part have a very ichthyosaurian appearance.

SCIENTIFIC SERIALS

Annalen der Physik und Chemie, xxix., No. 11.—B. Dessau, on metal films arising from the disruption of a kathode. Discusses the production of mirror-like films such as obtained by Plücker, Crookes, and Wright from the disgregation of the metal kathode in Geissler-tubes. With a pointed kathode and a flat glass surface as recipient, the film forms a flat conical deposit, showing interference-rings in reflected light, and proving also the presence of optical dispersive power in the metal. The dispersion in films of platinum, iron, nickel, and silver. It is anomalous in the case of gold and copper. The films are double-refracting, and, in the case of oxidisable metals, disappear on oxidation.—Ed. Hagenbach, propagation of electricity in telegraph-wires. Experiments made with chronographic apparatus on Swiss lines, together with a discussion of the results of Wheatstone, Walker, Guillemin, and others. Arguing from theory, the author compares, not the apparent speed, but the ratio of the time to the square of the length of circuit.—B. von Kolenko, reply concerning the pyro-electricity of quartz. Maintains, against Prof. Hankel, that the poles of a warmed quartz crystal are not altered during cooling by passing through a flame.—E. Edlund, remarks on H. Hoppe's communication on the theory of unipolar induction.—S. von Wroblewski, on the representation of the rotation between the gaseous and liquid states of matter by isopykhal lines. The transition of state is represented by curves drawn on a diagram having, for given definite densities, pressures as ordinates and temperatures as abscissæ; such curves being termed *isopykhal* or *isopykhal* lines. The result of examination of these curves shows that, though there is no such thing as an absolutely definite critical temperature or critical pressure *per se*, there is a critical density for every liquid.—K. Schmidt, on reflection at the surface of crystalline elliptically-polarising media. Experiments made with a crystal of cinnabar, and results compared with the formulæ of Voigt and that of Ketteler. The latter leads to closer correspondence than the former with the facts of observation.—H. Muraoka, on the deformation of metal plates by grinding. The radius of the curvature produced by grinding metal disks set in a bed of fusible alloy is proportional to the cube of their thickness.—K. Exner, validity of lens formulæ for non-homogeneous lenses.—E. Budde, a means of deciding between the electro-dynamic point-laws of Weber, Riemann, and Clausius. This gives the elementary theory of an experiment not yet made.—J. Kollert, on a new galvanometer. This is practically identical with Gray's form.

No. 12, 1886.—C. Fromme, on the galvanic polarisation evoked by small electromotive forces. This gives a first series of results with platinum electrodes in dilute sulphuric acid.—Edm. Hoppe, on the theory of unipolar induction; with a reply to Prof. Edlund.—F. Himstedt, on a determination of the quantity "*v*." The method was that of comparison of the two capacities of a condenser; the result $v = 3.0074 \times 10^{10}$ cm./sec.—R. Lamprecht, on the action of the magnet upon electric discharges in rarefied gases, concludes that the law of Biot and Savart holds good as the calculated trajectories agree with curves observed by Hittorf in 1869.—A. Foepl, the spread of the electric charge in conductors.—L. Boltzmann, remarks on the opinion of Herr Lorberg on a point in electro-dynamics.—W. Voigt, on the torsion of a rectangular prism of homogeneous crystalline substance; a mathematical investigation.—J. Kiewiet, on the elasticity of bending of pure zinc, copper, tin, and their alloys. The moduli of elasticity of alloys is not constant, but depends on the mode of preparation of the alloy as well as on its composition. Wertheim's rule for calculating the moduli of alloys from those of their components, according simply to the proportion of the constituents, appears to be inexact. The change of moduli of alloys with temperature is a simple linear function.—J. Stefan, on the relation between the theories of capillarity and evaporation.—A. Heritsch, on radiophony. The author combats Graham Bell's view that the condensed gases of a smoke deposit or carbon strip have something to do with its radiophonic properties. He finds that a coke plate heated to redness and then instantly placed in a tube and exposed to intermittent illumination from sunlight or electric light, emits tones. He further constructed a sort of flat glow-lamp, which, even when raised to brilliant incandescence, emitted tones when exposed to intermittent sunlight. No other source than sunlight was sufficient for this experiment.—G. Kobb, on the spectrum of germanium.—Greiner and Friedrichs, on a new mercury air-

pump; a modification of Geissler's form.—A. Grosse, a wire-tape rheostat. Fine german-silver wires are spiralled around cotton threads, which are then woven into a sort of tape, the warps being thereby insulated from one another. A piece 2 cm. wide and 4 metres long has 1000 ohms resistance.—W. Holtz, a Wheatstone's bridge for air and water flow. An illustrative apparatus of tubes such as has often been used.

In the *Scottish Geographical Magazine* for January there is an excellent bathy-orographical chart of the Clyde sea-area, constructed for Dr. H. R. Mill by Mr. J. G. Bartholomew. The colouring of the map is designed to show with special effect the area and depths of the Firth of Clyde and its inlets. For this purpose the land and sea have been treated separately, and coloured in strong contrast to each other. The system of colouring is, however, uniform, and in both cases the lowest or deepest areas are distinguished by the darkest tints, and graduated up to the lighter tints of the higher or shallower portions. The same number contains a paper on the configuration of the Clyde sea-area, which was read by Dr. Mill at the last meeting of the British Association.

SOCIETIES AND ACADEMIES

LONDON

Royal Society, December 16 — "Note on Specific Inductive Capacity." By John Hopkinson, M.A., D.Sc., F.R.S.

Consider a condenser formed of two parallel plates at distance x from each other, their area A being so great, or the distance x so small, that the whole of the lines of force may be considered to be uniformly distributed perpendicular to the plates. The space between the plates is occupied by air, or by any insulating fluid. Let e be the charge of the condenser and V the difference of potential between the plates. If the dielectric be air, there is every reason to believe that $V \propto e$, that is, there is for air a constant of specific inductive capacity. My own experiments ([1880] *Phil. Trans.*, vol. clxxii p. 355) show that in the case of flint-glass the ratio of V to e is sensibly constant over a range of values of V from 200 volts per cm. to 50,000 volts per cm. From experiments in which the dielectric is one or other of a number of fluids and values of V upwards of 30,000 volts per cm. are used, Prof. Quincke concludes (*Wiedemann, Annalen*, vol. xxviii., 1886, p. 549) that the value of e/V is somewhat less for great electric forces than for small. From the experiments described in that paper, and from his previous experiments (*Wiedemann, Annalen*, vol. xix., 1883, p. 705, *et seq.*) he also concludes that the specific inductive capacity determined from the mechanical force resisting separation of the plates is 10 per cent. to 50 per cent. greater than that determined by the actual charge of the condenser. The purpose of the present note is to examine the relations of these important conclusions, making as few assumptions as possible.

In words, the specific inductive capacity as determined by charge or discharge of a condenser at any given potential and distance between the plates is the arithmetic mean of the inductive capacities determined by the force resisting separation of the plates and that determined by lateral pressure, the potential and distance being the same. This is true whatever be the relation between charge and potential difference, but it is at variance with the experimental result that K_p and K_s are both greater than K .

The results obtained by Prof. Quincke are not easy to reconcile. For that reason it is the more desirable that their full significance should be ascertained. Full information is given of all the details of his experiments except on one point. It is not stated whether, in the experiments for determining K by direct discharge of the condenser, the capacity of the connection and key was ascertained. It would in most ordinary arrangements of key be very appreciable in comparison with the capacity of the condenser itself. If neglected, the effect would be to a certain extent to give too low a value of K , the effect being most marked when K is large.

The property of double refraction in liquids caused by electrification is sometimes cited as showing that electrification is not proportional to electromotive force. The fact that the double refraction in a liquid under powerful electromotive forces is very small would further show that there is a close approximation to proportionality, and that the deviation from proportionality would be insensible to any electro-static test. Such conclusions,

however, cannot be safely drawn in the case of bodies such as castor-oil, in which $K \pm \mu^2$. In such bodies, assuming the electro-magnetic theory of light, the yielding to electromotive force is much greater if the force be applied for such time as 10^{-4} second than when applied for 10^{-14} second, and it is quite possible that the law of proportionality might be untrue in the former case, but very nearly or quite true in the latter.

"On the Dielectric Constants of Fluids." (Addendum to Dr. Hopkinson's "Note on Specific Inductive Capacity.") By Prof. G. Quincke, For. Mem. R.S.

In investigating the properties of dielectric fluids (*Wiedemann's Annalen*, vol. xix. 1883, p. 707; vol. xxviii., 1886, p. 529), I found the dielectric constants with the electric balance or by the hydrostatically measured pressure of an air-bladder greater than when measured by the capacity of a condenser surrounded by air or the insulating fluid, and discharged by turning a key through a ballistic galvanometer.

The capacity of the key and of the short thin junction-wire connecting the key with the condenser was, however, in that calculation left out of account as being evanescently small.

In consequence of a written communication from Dr. John Hopkinson, I quite recently compared the capacity of the key and the junction-wire with the capacity C of the condenser by observations with the ballistic galvanometer with the same difference of potential between the surfaces, and thereby found the relation—

$$\frac{x}{C} = 0.1762;$$

greater, therefore, than I had conjectured.

Let there be subtracted from the observed galvanometer readings s_1 and s_{11} for the condenser in air and in the dielectric fluid, the deflection calculated for the electricity on the key and junction-wire, then there will actually be obtained from the ratio of the readings thus corrected (s_1) and (s_{11}) values of the dielectric constants (K) of the fluid almost exactly coinciding with the measurements of the electric balance. The agreement is indeed as perfect as might be expected, considering the difference in the methods of observation employed.

Thus, for example, it was found:

	Dielectric constants	
	Ballistic galvanometer (K)	Weighing K_p
Ether	4.211	4.394
Carbon disulphide	2.508	2.623
" " " " " "	2.640	2.541
Benzole	2.359	2.365
Petroleum	2.025	2.073

[Note added by Dr. Hopkinson.—Prof. Quincke's explanation sets the questions I have raised at rest. There can be little doubt that K , K_s , and K_p are sensibly equal and sensibly constant. The question what will happen to K_p and K_s if K is not constant has for the present a purely hypothetical interest.

Physical Society, January 22.—Prof. McLeod, Vice-President, in the chair.—Dr. F. Wormack was elected a Member of the Society.—The following papers were then read:—The permanent and temporary effects on some of the physical properties of iron produced by raising the temperature to 100° C., by Mr. Herbert Tomlinson, B.A.—On some new measuring-instruments used in testing materials, by Prof. W. C. Unwin, F.R.S. In most measuring-instruments previously used, it has been considered sufficient to make the measurement of elongation from one side of the bar, but this, the Professor showed, was liable to serious errors owing to the fact that test-bars are not always perfectly straight, and to the possibility of originally straight bars being bent by improper fixing in the testing-machine. In such cases the modulus of elasticity calculated from the apparent elongations are subject to considerable error. In endeavouring to overcome these difficulties the author has devised several new forms of measuring-apparatus, which are attached to two sides of the bar by steel points, and the mean elongation of the two sides determined. The first apparatus described consists essentially of sliding calipers read by microscopes to 1/10,000 of an inch. Another form has two clamps provided with sensitive levels. Each is attached to the bar by two steel points, the line joining which is

perpendicular to the direction of the stress, and the clamp can rotate in a vertical plane about this line as an axis. The lower clamp is levelled by a screw pressing against the surface of the bar, and the upper one by means of a micrometer-screw parallel to the axis of the bar, the nut of which is secured to the bottom clamp. By this means the elongation can be measured to $1/10,000$ of an inch. In a third form two similar clamps without levels are kept apart by a steel rod ending in knife-edges. One of the clamps carries a small roller, which turns about an axis parallel to the line joining the steel points above mentioned, and the axis carries a small plane mirror. The other clamp supports a projecting arm parallel with the axis of the test-piece, and which presses on the surface of the roller. When the bar is elongated the mirror is turned through a small angle and the elongation is determined by a reading-telescope and vertical scale to $1/100,000$ of an inch. A similar apparatus is used for testing the compression of stone, but in this the compression is multiplied by a lever and measured by a micrometer microscope to $1/100,000$ of an inch.—At the conclusion of the meeting Prof. Unwin invited the members to visit the Engineering Laboratory of the City and Guilds of London Central Institution, where he broke a bar of Staffordshire iron in the 100-ton testing-machine, the force and elongation being automatically recorded.

Royal Meteorological Society, January 19.—Mr. W. Ellis, President, in the chair.—Mr. J. Willis Bund was elected a Fellow of the Society.—The following papers by the Hon. R. Abercromby, F.R. Met. Soc., were read:—(1) On the identity of cloud-forms all over the world, and on the general principles by which their indications must be read; (2) On the cloud to which the name "Roll-Cumululus" has been applied.—After the reading of these papers the annual general meeting was held, when the Report of the Council was read by Dr. Tripe, which showed the Society to be in a satisfactory condition. The number of Fellows is 524.—The President, Mr. W. Ellis, then delivered his address.—The Officers and Council for the ensuing year were elected:—President: William Ellis; Vice-Presidents: George Chatterton, Charles Harding, Cuthbert Edgar Peek, George Mathews Whipple; Treasurer: Henry Perigal; Trustees: Hon. Francis Albert Rollo Russell, Stephen William Silver; Secretaries: George James Symons, F.R.S., John William Tripe, M.D.; Foreign Secretary: Robert Henry Scott, F.R.S.; Council: Hon. Ralph Abercromby, Edmund Douglas Archibald, Francis Campbell Bayard, William Morris Beaufort, Arthur Brewin, Frederic William Cory, Henry Storks Eaton, Richard Inwards, Baldwin Latham, William Marcell, M.D., F.R.S., Edward Mawley, Charles Theodore Williams, M.D.

Entomological Society, January 19.—Mr. R. McLachlan, F.R.S., President, in the chair.—This was the fifty-fourth anniversary meeting.—An abstract of the Treasurer's accounts was read by Mr. Stainton, one of the auditors; and the Secretary read the Report of the Council.—The following gentlemen were elected as Officers and Council for 1887:—President: Dr. David Sharp; Treasurer: Mr. Edward Saunders; Secretaries, Mr. Herbert Goss and the Rev. W. W. Fowler; Librarian: Mr. Ferdinand Grut; and as other Members of the Council: Messrs. Robert McLachlan, Gervase Mathew, R.N., George T. Porritt, Edward B. Poulton, Osbert Salvin, F.R.S., Henry T. Stainton, F.R.S., Samuel Stevens, and J. Jenner Weir.—The retiring President delivered an address, and a vote of thanks to him was moved by Mr. E. B. Poulton, and seconded by Prof. Meldola, F.R.S.—A vote of thanks to the Treasurer, Secretaries, and Librarian was moved by Mr. McLachlan and seconded by Mr. Stainton; and Mr. Goss and Mr. Grut replied.

Middlesex Natural History and Science Society, January 18.—Dr. Archibald Geikie, F.R.S., in the chair.—Mr. Robert B. Hayward, F.R.S., read a paper on the water in the Chalk, beneath the London Clay, of the London Basin. The geology of the area in question was described, and the water in the beds above the Chalk briefly referred to. Mr. Hayward then drew attention to the great extent of the Chalk area, to the rainfall, and other atmospheric conditions affecting the water-supply, and gave detailed chemical analyses of the waters of a large number of wells in and near London, which draw their supplies from the Chalk. Those of Harrow and the north of London, being well known to the lecturer, received special attention. The water-levels were described and elucidated by Joseph Lucas's hydro-geological maps, and the movements of the

underground waters fully treated of. A table of the above-mentioned chemical analyses was distributed to the members present. In the discussion which ensued, Dr. Geikie gave some interesting observations upon the probable origin of Harrow Hill, and the other hills of London Clay to the north of London, and was followed by Mr. Clement Reid, Mr. Mattieu Williams, and Mr. Klein.

PARIS

Academy of Sciences, January 24.—M. Gosselin, President, in the chair.—Fresh statistics of persons that have been treated at the Pasteur Institute after having been bitten by animals either mad or suspected of madness, by M. Vulpian. This report covers the whole period from October 1885 to December 31, 1886, the tabulated results showing 2682 subjects treated in the Institute, of whom only 31, or 1.15 per cent., succumbed.—On the direct fixation of the gaseous nitrogen of the atmosphere by vegetable soils, by M. Berthelot. The experiments are here described which the author carried on during the year 1886 at the Meudon establishment for agricultural chemistry. As a general result it appears that vegetable soil is incessantly fixing free atmospheric nitrogen, apart even from any vegetation properly so called. Nor can the phenomena be attributed to the exclusive action of rain-water, for it was shown that in some cases the rain carried off under the form of nitrates alone more nitrogen than it had contributed under the combined forms of ammonia and nitric acid. In a future paper the experiments will be described that have been carried on simultaneously on the same soil with the co-operation of plant life.—The mechanism of the flight of birds studied by chrono-photography, by M. Marey. This is a further application of the author's new chrono-photographic method, already so successfully applied by him to the study of human motion. The paper is provided with four illustrations, one of which shows fifty images per second of a bird on the wing. Measured by the metric scale, the distance traversed during one complete revolution of the wing was 1.37 metre, or 6.85 metres per second, and 24,660 metres per hour.—Solar observations for the second half of the year 1886, by M. P. Tacchini. The results, as here tabulated, show a progressive diminution of spots and faculae, with a very marked minimum in November. The phenomenon of protuberances also shows a falling off, although not to the same extent as that of the spots. This result appears to be in harmony with the fact that the maximum of protuberances always occurs after the maximum of spots.—On surfaces whose isothermal lines are constituted by a family of circles, by M. Demartres.—On the theory of algebraic forms with p variables, by M. R. Perrin. It is shown that a form of order m with p variables possesses a pure covariant, distinct or reducible, of $2p-3$ degree and order $(2p-3)m-2p$.—On the action of the tetrachloride of carbon on chlorochromic acid and the phosphates of sesquioxide, by M. H. Quantin. To the reactions of the tetrachloride of carbon already described by M. Demarçay, the authors here add two others, dealing fully with that produced by making this substance act on the oxygenated salts. They describe the action that it exercises, without previous decomposition, on the neutral phosphate of the sesquioxide of iron. They hope by the dry method to be able to apply this reaction to the separation of minute quantities of phosphoric acid.—Preparation, properties, and constitution of inosite, by M. Maquenne. This substance, hitherto unavailable in sufficient quantities for the purpose of experiments, the author has succeeded in producing by a process here described, very rapidly and easily. The analysis of anhydrous inosite yields carbon 40.00, and hydrogen 6.66, and its formula, $C_6H_{12}O_4 + 2H_2O$, is shown to be correct.—On the separation of mono- and di-isobutylamine by means of oxalic acid, by M. H. Malbot.—On the preparation of a silicostannate of lime corresponding to sphene, by M. L. Bourgeois. The object of this paper is to show the possibility of preparing a silicostannate of lime, CaO, SiO_2, SnO_2 , isomorphous with sphene, CaO, SiO_2, TiO_2 . In solving the question, the author has employed the same method by which Hautefeuille obtained some fine specimens of the latter mineral.—Description of a lamellary thomsonite from Bishopton, Renfrewshire, by M. A. Lacroix. This specimen, picked up by the author in 1884, shows the same optical properties as the substance known as Stirlingshire gyrolite, and contains a considerable proportion of aluminium. At 13°C. the density is 2.34.—Note on a white epidote from Beagle Channel, Tierra del Fuego, by M. A. Lacroix. This specimen, brought back by

Prof. Domenico Lovisato, of the Cagliari University, is remarkable for its richness in aluminium, and the highly oxidised state of the iron contained in it. Outwardly it strongly resembles zoisite, although its crystalline system and optical properties leave no doubt as to its true character.—On some peculiarities in the organisation of the Schizonemertians, by M. Remy Saint-Loup. The exact disposition of the cephalic fosses is here determined by a comparative study of three types of these organisms.—On the colonial vascular system of the Tunicata, by M. F. Lahille. A careful study of this system leads the author to the conclusion that there is no valid reason for separating the Monascidians and Synacidians into two distinct orders of Tunicata.—On the cranial nerves of a human embryo thirty-two days old, by M. C. Phisalix. Balfour's theory, based on negative grounds, that the cranial nerves are disposed on a type absolutely different from the spinal nerves, seems disproved by the anatomical study of this subject.—Researches on the physiological action of methylal, by MM. A. Mairet and Combemale. These researches show that, in whatever way introduced into the system, methylal always produces the same hypnotic effects, but more rapidly by hypodermic than by pulmonary injection.—On the existence of submerged valleys in the Gulf of Genoa, by M. A. Issel. From the recent hydrographic surveys of Capt. J. B. Magnaghi, it appears that the valleys of the Bisagno, Polcevera, Quiliano, and other Ligurian streams are continued seawards by submarine valleys, which retain the same fluvial direction, and are perfectly distinct to a depth of at least 900 metres.—On the Artesian wells and new oases created in the Wed Rir, South Algeria, by M. G. Rolland. Since 1859, the French have sunk 117 wells in this region, creating five new oases, and increasing fivefold the value of the land. In the same period the population has been doubled, and many thousands of date-palms planted.

BERLIN

Physical Society, December 3, 1886.—Prof. von Helmholtz in the chair.—Dr. König exhibited a von Kries colour-mixing apparatus, the third specimen of the kind hitherto turned out in the factory of Schmidt and Hänsch, and discussed in a searching manner the construction of this instrument. The instrument contained essentially two displaceable slits, the light of which was by a prism decomposed into two spectra falling on each other and producing the mixture of the colours. A second double slit, and a simple fifth slit allowed a comparison of the mixed colours and an admixture at pleasure of white light.—Dr. Weinstein reported on his deductions from observations of the earth's current in the telegraph lines of the German Empire. Among the results already elsewhere published of his calculations (*vide* NATURE, vol. xxxiii. p. 624) it may here be brought out that, apart from its disturbances, the earth's current showed a daily period with eight fluctuations, which, however, did not occur throughout the whole year, nor always in a similar direction. These fluctuations were least in the morning between five and seven o'clock. They were the cause that the statements respecting the daily maxima and minima differed so considerably among the different authors. The earth's current showed an intimate relation to the earth's magnetism, and especially to the declination. The speaker failed, however, to discover a relation in the earth's current to the period of the sun's rotation, although such a relation was asserted for the earth's magnetism. The latter, too, was a point which the speaker doubted, and that because he had been unable to confirm the relation, which was likewise affirmed, between the aurora and the sun's rotation. It was true he obtained an average period of about twenty-five days, but the minima amounted to twelve and the maxima to thirty-seven days, and between such extremes a mean was not allowable. For the earth's current likewise he found minima of twelve days and maxima of thirty-seven days, and this result appeared to him to conflict with the assumption of a connection between the earth's current and the sun's rotation. He conjectured that in the case of the earth's magnetism single values deviating too strongly from one another had been united into a mean. Be it further related that the intensity of the earth-current proved itself to be nearly proportional to the length of the lines. In the discussion following this address, Dr. Brix spoke of the earth plates which had been introduced in the lines used for measurements of the earth-currents, and which had hitherto proved so little disturbing that for the present the introduction of unpolarisable plates was desisted from.

CHRISTIANIA

Society of Science, October 15, 1886.—Herr Schöyen announced that through experiments carried out during the summer he had succeeded in demonstrating that the parasite *Tylenchus hordei*, described by him, which in the district of Lom causes the remarkable disease on rye termed "krok," also attacks *Elymus arenarius*, whereby his opinion that the parasite was transmitted from the latter to the rye-fields has been confirmed. He further stated that he had received samples of rye affected with the same disease from Heligoland; here, too, it extended along the coast in the proximity of *Elymus arenarius*.

BOOKS AND PAMPHLETS RECEIVED

Die Klimate der Erde, 2 vols.: Dr. U. Woelfog (Kostentoble, Jena).—The Factors of Organic Evolution: H. Spencer (Williams and Norgate).—Beiblätter zu den Annalen der Physik und Chemie, 1886, No. 12 (Barth, Leipzig).—The Electrician's Directory (Tucker).—Outlines of Classification and Special Morphology of Plants: Dr. K. Gould (Clarendon Press).—Travels in the Wilds of Ecuador: A. Simson (Low).—Meteorological Observations at Stations of the Second Order, for the Year 1882.—Hourly Readings, 1882, part iv.—Resultate der Polarlicht Beobachtungen angestellt im Winter 1882 und 1883: Dr. K. R. Koch (Asher, Berlin).—Gold Fields of Victoria: Reports of the Mining Registrars for Quarter ended September 30, 1886 (Ferre, Melbourne).—Report on the Administration of the Meteorological Department of the Government of India in 1885-86.—An Explanatory Arithmetic, 3rd edition: G. E. Spikernell (Griffin, Portsmouth).—An Elementary Treatise on the Differential Calculus, 6th edition: B. Williamson (Longmans).—Celestial Motions, 5th edition: W. T. Lynn (Stanford).—Year-Book of Pharmacy (Churchill).—Catalogue of Canadian Plants, part 3, Apetalæ: J. Macoun (Dawson, Montreal).—Archives Italiennes de Biologie, tome viii. fasc. 1 (Loescher).—Aluminium: J. W. Richards (Low).—Examples of Exercises given in the National Philosophical Class of Glasgow University: M. Maclean (MacLachlan, Glasgow).—Report on the Medusæ collected by the U.S. Fish Commission in 1883-84: G. W. Fewkes (Washington).—The Blue Hill Meteorological Observatory: A. L. Rotch (Boston).

CONTENTS

	PAGE
A History of the Theory of Elasticity. By A. G. Greenhill	313
The Encyclopædia Britannica	314
A Treatise on Chemistry	316
Our Book Shelf:—	
Holden: "Photography the Servant of Astronomy"	317
Rutot et Van den Broeck: "Observations nouvelles sur le Tufeau de Cipro et sur le Crétacé supérieur du Hainaut"	317
Letters to the Editor:—	
On Two Jade-handled Brushes.—Prof. J. P. O'Reilly	318
The Cambridge Cholera Fungus.—Walter Gardner; George Masee	319
Earthquakes.—Thomas W. Kingsmill	319
The Calendar and General Directory of the Science and Art Department	320
The Progress of Astronomical Photography	321
Meteorological Conditions at the Time of the Eruption of Mount Tarawera, New Zealand. By Capt. F. W. Hutton	322
A Few of our Weather Terms. By Rev. W. Clement Ley	323
Note on Instantaneous Shutters. By A. Mallock. (Illustrated)	324
On some Phenomena connected with the Freezing of Aerated Water. By George Maw. (Illustrated)	325
Notes	326
Our Astronomical Column:—	
The New Algol-type Variable	329
Gore's Variable near χ^1 Orionis	329
The Southern Comet	329
A Short Method for Computing Refractions	329
Comet Brooks (1887 <i>b</i>)	330
Astronomical Phenomena for the Week 1887	
February 6-12	330
Geographical Notes	330
Physical Notes	331
On the Morphology of Birds. By Prof. W. K. Parker, F.R.S.	331
Scientific Serials	333
Societies and Academies	334
Books and Pamphlets Received	336

THURSDAY, FEBRUARY 10, 1887

THE HISTORY OF HOWIETOUN

The History of Howietoun. Part I. By Sir J. Ramsay Gibson Maitland, Bart. (Stirling, N.B.: J. R. Guy, Secretary Howietoun Fishery, 1887.)

PROBABLY every one at all interested in fish-breeding has heard the name of Howietoun, and a great many people, especially in Scotland, have some knowledge of the character of the establishment and the operations there carried on. Occasional paragraphs in scientific periodicals, as well as in daily papers, announce some experiment in the artificial stocking of home waters with some kinds of trout or with salmon fry, or some successful exportation of salmonoid ova to America or to the colonies at the Antipodes. The name of Sir James Maitland or of Howietoun very often occurs in such announcements. Those who have given attention to the subject will find much to interest them in the account of the development of his fish-farm, and in the description of its present condition, which Sir James Maitland is now placing before the public. At present we have only the first part of the work, in which the history is brought down to the spring of 1879. A note on the fly-leaf informs us that the remaining part will be issued shortly. The present volume is of large quarto size, printed in large type, and liberally illustrated with excellent woodcuts.

The author states in the preface that the culture of Salmonidæ is now an achieved success, and he describes the gradual progress of the efforts which have culminated in this result at Howietoun, with the hope that his experience may prove of use to those who are working on the still larger question of our sea-fisheries. The first seven chapters contain a general description of the regular operations which are now carried on after thirteen years of practice and experimental ingenuity at the Howietoun farm. Sir James Maitland asserts emphatically that Great Britain is pre-eminent among all nations in matters pertaining to fisheries. He does not argue at any length in support of this patriotic claim, which he seems to found chiefly on the perfection of the Howietoun establishment, and the success of the system of Government supervision under which the Scottish herring trade is carried on. His eulogy of these two institutions is quite justified by facts, and there can be little doubt that the value of the fisheries of Great Britain, in proportion to the total population and total wealth, is greater than in many other countries. But there are other matters pertaining to fisheries in which the pre-eminence of Great Britain may well be disputed, and has been disputed very frequently of late years. The scientific study of the sea-fisheries, and the application of the results of such study, have undoubtedly been carried out to an enormously greater extent in other countries than with us. The reproduction of the cod was first investigated in Norway; oyster-culture as understood in Holland and in France is still unknown in Britain; and the organised scientific investigation of fishery matters, which has been commenced by the Scottish Fishery Board and is about to be instituted by the Marine Biological Association in England, has been, as

VOL. XXXV.—NO. 902

it were, forced upon us by the example of the United States. Perhaps no American salmon-hatchery is quite as efficient as the Howietoun farm, but the extent of piscicultural operations applied to Salmonidæ in the United States is certainly greater on the whole than in Britain. This is not the occasion, however, for a complete comparison of Great Britain with other countries with regard to pisciculture. The history of Howietoun shows how greatly Sir James Maitland, by his individual energy and enterprise, has advanced the art of breeding Salmonidæ, and we have to notice shortly some of the most interesting parts of his book.

Before considering particular points, we may remark that the "History of Howietoun" is a book that can not only be referred to with profit, but read with pleasure. The author's genial individuality has an interest of its own, and his pages are full of suggestions of healthy, cheerful, energetic out-door life which make them picturesque and refreshing. The use of the plural "ova" as a singular seems to be common among pisciculturists, and it is a pity that this small blemish was not remedied in the proofs.

The greater number of the ova hatched at Howietoun are from Loch Leven trout kept in ponds at the farm. Ova are collected from wild *Salmo salar* taken from different Scottish rivers, and small numbers of ova of *S. furio* and *S. fontinalis* are dealt with, but the greatest amount of space and attention seems to be devoted to *S. leuvenensis*. In the account of the "egg harvest" some interesting discoveries are mentioned which show a constant relation between feeding and breeding. If the fish are highly fed at an early date in the year, they begin to spawn earlier; the food used for this purpose is Pecten, and if this is given early in February, maturity is reached early in November. To obtain the eggs for the hatchery the females are stripped over large earthenware milk-plates, into which the ova fall. About 10,000 ova are stripped into one pan, and these can usually be impregnated by the milt of one male. After the milt has been added, only a tumblerful of water is poured into the pan; the eggs are then left to impregnate for 30 to 45 minutes. The ova, when first shed, are soft to the touch and inclined to adhere together; after impregnation they feel hard, and separate easily. The next process is to pour the ova into large pails full of water, which are held immersed in one of the inlets to the ponds, so that the milt is washed away; the ova are then carried in the pails to the hatching-house.

Collecting ova from fish in the wild state is a much more laborious process than from the fish in the ponds, and Sir James advocates strongly the advisability of Fishery Boards building proper ponds in which to retain the gravid fish until ripe. At Howietoun 20,000,000 trout (presumably *leuvenensis*) ova can be produced at a cost of little over 100*l.* a year.

The account of work in the hatching-house would naturally follow that of the egg-harvest, but the chapter on packing has been inserted between them. The work in the hatchery is described in detail. The eggs are poured with a glass measure over the centres of the glass tubes forming the *grilles*, and afterwards dressed into regular rows by "feathering," an operation performed by girls, as the eggs at this stage are easily killed by too

much handling, and a trained girl can give the slight motion which is required to the eggs without actually touching them with the feather at all. Each box is entered by a number in a book, and a record of the number of dead eggs daily taken from it is kept on a printed form, and afterwards entered in the same book. Two girls only are employed in attending to all the hatcheries at Howietoun. The stage in the development of the ova between the formation of the blastoderm and the appearance of the eyes is called the "spectacle" stage, and the health of the embryo can be estimated by certain signs at this period; but the description given of these signs is not easy to follow. Up to the eye stage the ova are very delicate, but as soon as the eyes appear the eggs can be handled, and this is the best age for packing for the Antipodes. Eggs for America or Europe are packed at a later period, when red blood has appeared. When the eggs are ready to hatch, the *grilles* are taken out, the boxes cleaned, and the eggs are emptied off the *grilles* on to the bottom of the box. The depth of water in the boxes containing the alevins is only 3 inches. The alevins congregate in dense masses in the corners and against the sides of the hatching-box, and the motion of the pectoral fins causes a continuous current to descend downwards through the mass. When the yolk-sac is nearly absorbed, the fry are fed with food prepared from fillet of beef or of horse, and yolks of hard-boiled eggs. The food is made into paste in a mortar, and rubbed through "feeding-spoons" of perforated zinc into the hatching-box.

Next follows an account of the method of despatching living fry. These cannot travel for more than twenty-four hours, and they are sent in tanks quite full of water, as motion of the water exhausts the fish at this stage. The greater number of the fry, after a short time in the hatching-house, are placed in ponds constructed of wood, 100 feet in length, where they remain throughout the summer, and where they are fed daily by hand for the whole time. It is stated that 100,000 trout eleven months old would consume between two and three horses a week.

A considerable amount of stocking is effected with yearling trout, which are carried in conical tanks. The fish must be starved some days before being despatched, as, if placed in travelling-tanks when fully fed, they rapidly make the water foul. In the bottom of the lid of the tank is an inverted cone perforated with holes and filled with ice; this keeps a constant temperature, and promotes aëration of the water. Two-year-old, and even larger, trout are also sent out; these are placed in larger tanks, provided with small wheels, but constructed on the same principle.

In Chapter III. an elaborate account is given of the methods of packing ova. The first operation is to transfer the ova which are to be packed from the *grilles* to peach netting stretched on square wooden frames. This step is carried out in a specially constructed sink, through which water is kept running. The ova are emptied from the *grille* into a wooden box, from which they pass into a leaden basin with a narrow bottom. One of the frames is then floated in the sink, and a glass measure containing 1100 eggs is used to measure the eggs from the basin on to the frame. The frames are placed in the packing-room in piles, one pile for each box. Next morning the frames are examined, so that any egg with an ill-developed

embryo may be picked out. Then, a square of swan's-down, contained in a special tray, is placed over the eggs on the frame, and, the two being suddenly reversed, the eggs rest on the swan's-down without altering their relative position; thus each egg lies separately on the swan's-down. The frame is removed, and the square of swan's-down with its burden placed in one of the travelling-trays. Above the eggs is next placed a square of felted moss (*Sphagnum*). Above the moss is placed another layer of swan's-down carrying a layer of eggs, and then another layer of moss, and so on, till the travelling-tray is filled. The bottom of the travelling-tray is made of perforated zinc, and before any eggs are placed in it, the bottom is covered with a thin layer of moss. The eggs thus rest on swan's-down, and are covered with felted moss, a layer of which also forms the lowest and uppermost layer of the tray when full. For journeys to the Continent or America, unbleached lino is substituted for the swan's-down, because swan's-down retains so much carbonic acid that advanced embryos are asphyxiated. For the Antipodes, an extra precaution has to be taken: a thin layer of moss is inserted between the layer of unbleached lino and the eggs, so that the latter are in contact with the moss above and below. The travelling-tray is 10 inches square and 2½ inches deep. The trays are packed in an inner box only ¾ inch larger than themselves, and this is placed in an outer box 4 inches deeper and 3 inches wider than the inner. Between the two is a layer of sawdust. The outer box or case measures 1 foot 4 inches square, by 1 foot 10 inches deep. This is the method of packing for short journeys within the United Kingdom. The boxes for foreign consignments are larger, and oblong in shape; there is a sawdust space as in the boxes already described, but the trays are separated by means of charred fillets, so that an air-space surrounds each tray: above the pile of trays is a large ice-tray, which occupies the whole of the top of the box. Ova can be safely kept in one of these boxes during a period of sixty days.

In the chapter on "breeders" we have an account of the most unique feature of the Howietoun establishment, —the feature which entitles the place to be called a fish-farm, and not merely a hatchery. Salmon and trout eggs have been artificially fertilised and kept in hatching-houses by a great many pisciculturists, but never before the institution of the Howietoun system has a species of *Salmo* been treated after the same method which is applied by agriculturists to domestic cattle. Sir James Maitland may be said to have domesticated the Loch Leven trout. He keeps them in a system of ponds, where they are placed under more favourable conditions than they meet with in the wild state, where they are supplied with a constant abundance of food, and are protected from enemies. The Howietoun trout have been rescued from the battle of life and subjected to the influences of cultivation and artificial selection. A flow of 5,000,000 gallons of water per diem is made to support a stock which produces 20,000,000 ova annually. The original stock of breeding-fish was raised from eggs taken at Loch Leven in 1874. As the fish grew older the size of their eggs increased, the fry from these ova were bigger and stronger each season, and it became evident that the ova of old trout were much the most valuable.

Time has not yet shown whether the new generation of breeders raised from selected ova of the largest trout, in their turn produce still finer ova and fry, but there can be little doubt that this will be the case.

The history of the gradual improvement of the piscicultural apparatus given in Chapters VIII. to XVII. is extremely interesting. A detailed account is contained in these chapters of the increasing amount of stock, and of the hatching operations in succeeding seasons. But enough has been said to show the character and value of the first part of the work. The second part will contain descriptions of the experiments which have been made at Howietoun since the establishment reached its present complete and efficient condition.

J. T. C.

HARMONY AND COUNTERPOINT

Elements of Harmony and Counterpoint. By F. Davenport, Professor of Harmony, &c., Royal Academy of Music. (London: Longmans, 1887.)

YEARS ago, when the laws of musical sounds, like the laws of Nature before Newton, lay hid in night, it was not unusual for clever and ingenious writers on music to invent what they called "systems of harmony." They found certain combinations and progressions in use by the best composers, and they conceived it to be their duty to explain, or account for, or justify these by some kind of imaginary natural principles, more or less fanciful, which they conjured up out of their inner consciousness, to fit the case. But, unfortunately, these writers widely disagreed among themselves as to the principles on which their theories should be based, and the result was such a mass of contradiction and confusion that the very name of theoretical harmony became a by-word and a scandal, until the Newton of musical acoustics, Helmholtz, arose, and, by explaining the real nature of musical sensations, swept away these fanciful inventions into deserved oblivion.

Among these systems, however, was one, published in 1845, by a Dr. Alfred Day, which had the great good luck to be admired and patronised by no less a personage than Sir George Macfarren, the Principal of the Royal Academy of Music. So far as we know, this admiration has not been widely shared by musicians in general; but it would be idle to ignore the great weight that such an opinion must carry, and it is this, no doubt, that has preserved for Dr. Day's work an existence which might otherwise have terminated long ago.

It is natural that Prof. Macfarren should wish this system followed at the famed institution over which he presides, and the little book before us appears to be intended as a cheap manual for the purpose. No one need object to this, for, when it comes to the practical teaching of harmony, it matters little whose system is followed so that the orthodox forms of writing are taught and recommended. That system is the best which renders this knowledge easiest to acquire. It is a feature of Dr. Day's book, that he lays down strict laws, pretty copiously and peremptorily, as to what ought or ought not to be done, and Mr. Davenport has conscientiously carried out this plan. His work bristles throughout with such rules, and we may safely say that if any

student can succeed, either with or without the professor's help, in mastering them, he ought to be competent to write very good harmony. If he is of an inquiring mind, and wants to know *why* he is strictly enjoined to do so and so, or strictly forbidden to do so and so, he should postpone his curiosity till he has finished his academical course, and in the meantime be content with the Dicta of Doctor Day.

We must do Mr. Davenport the justice to remark that he has added to the work an original feature of his own which is worthy of all praise, namely, the combination of *counterpoint* with harmony-teaching. It is the general custom to give the harmony examples in the form of pianoforte chords, and this produces the anomaly that when rules have to be stated affecting the motion of certain notes, an idea of part-writing must enter which is somewhat foreign to the general system. Our author has taken the bull by the horns, by requiring the student *ab initio* to write his harmony in separate parts, putting each part on a separate line with its proper clefs. This is an excellent idea. Counterpoint is the highest and most perfect style of musical writing, but it has been much neglected in late days, and Mr. Davenport has hit upon a happy mode of encouraging its cultivation, which cannot fail to benefit his pupils.

PEARLS AND PEARLING LIFE

Pearls and Pearling Life. By Edwin W. Streeter, F.R.G.S. (London: George Bell and Sons, 1886.)

THE book before us, according to the preface, and as far as we are aware, is the only work in the English language which is entirely devoted to the history of pearls. The introductory chapter is immediately followed by one which gives a brief historical account of pearls in connection with India, China, Persia, Palestine, Egypt, Ancient Greece and Italy, and Europe in the Middle Ages. This is succeeded by a *résumé* of the ancient ideas respecting the origin and supposed medicinal qualities of pearls, and by a few words on "breeding" pearls. The next chapter treats of the different kinds of pearl-forming mollusks, both marine and fluviatile. The writer then gives an account of the true mother-of-pearl shell, describing its geographical distribution, the different varieties, its structure, the parasites found within the shells, and their external enemies, their method of getting rid of extraneous substances (stones, small shells, &c.) accidentally introduced within the valves of the shell, and the uses to which the mother-of-pearl is put. The sixth chapter, although headed "The Origin and Formation of Pearls," also refers to the different kinds, such as *bouton* pearls, *baroque* pearls, and *coq de perle*, the mode of life of the oyster, the positions in which pearls are found, &c. It also treats of the qualities which regulate the value of pearls. The next chapter gives a short account of the Sooloo Archipelago, the natives as pearl-divers, and their method of dredging. Then follows a good description of the fisheries of North-West Australia and Torres Strait, and this is succeeded by an interesting chapter entitled "Pearling Life at the Present Day," which is practically descriptive of pearling expeditions made by Mr. Streeter's vessel, the *Sree Pas Sair*, from Singapore

to the North-West Australian coast and the Sooloo Archipelago.

Chapter XI. is devoted to a condensed account of the pearl-fisheries of Ceylon and Southern India, and this is followed by a *résumé* of what is known respecting the fisheries in the Persian Gulf, the Red Sea, on the west coast of North America, and at the West Indies. Pearls produced by shells which inhabit the rivers and lakes of Great Britain and foreign countries are described in Chapter XIV., and the artificial production of pearls by the Chinese is also here referred to. The different kinds of coloured pearls, and the mollusks which produce them, are then treated of. In the succeeding chapter the most famous pearls of both ancient and modern times are recounted, and the immense sums at which some of them were valued are stated. Chapter XVII. gives the history of the remarkable cluster of pearls known as "the great Southern Cross pearl," which was exhibited in the West Australian Court of the Colonial and Indian Exhibition, and valued by the owners at 10,000*l.* The next and concluding chapter is devoted to the value of pearls, and shows how their worth has varied in this country at different periods from 1671 to the present time.

A map is then introduced showing the principal pearling regions. In an appendix, the works bearing on the subject which have been consulted by the author are enumerated, and a full index completes the volume.

Mr. Streeter has brought together a large amount of information which will be of interest to the general reader, for whom especially, and not for the scientific, the work has been written. The most original material is comprised in the part extending from the seventh to the tenth chapter. The chapter devoted to the Sooloo Archipelago contains some details which, although interesting in themselves, are rather foreign to the subject of the work. The same observation applies to the account of the constellation *Cruce Australis*, or Southern Cross, introduced in the seventeenth chapter.

As far as we have noticed, the various opinions and statements set forth in the work are mostly accurate. It may, however, be questioned whether "there is perhaps no instinct implanted in the human breast more powerful than the love of admiration," for is not that of self-preservation supposed to reign supreme? We would point out that the term *Lamellibranchiata* is now superseded by that of *Pelecypoda*, and with good and sufficient reasons is adopted in the latest and best manuals on conchology. The bathymetrical range of bivalves far exceeds the stated limit—200 fathoms—specimens having been obtained by the *Challenger* and other deep-sea exploring expeditions in depths ranging as low down as 2900 fathoms.

The book is printed in good legible type upon toned paper, but the pictorial portion mars the rest. The plates illustrating the *Malleus*, the *Meleagrina*, the *Unio*, the *Pinna*, the *Strombus*, and the *Turbinella* are simply execrable. They are printed upon a fearful black ground (one almost expects to see "Sacred to the memory of," &c.), inclosed by a thin white line with ornamental corners, and seem to us to have a most common appearance. We cannot see one redeeming feature in them, the drawing and colouring of the shells being equally bad. If another edition is called for, fresh and accurate illustrations should be provided.

E. A. S.

OUR BOOK SHELF

The Definitions of Euclid, with Explanations and Exercises, and an Appendix of Exercises on the First Book. By R. Webb, M.A. Pp. 48. (London: G. Bell and Sons, 1886.)

THERE are some good points in this little book which will make it a useful help in many cases, especially with backward and dull pupils. The explanations are clear and precise; the exercises are very simple, and aim chiefly at insuring that the pupil really masters the idea involved in the definition illustrated; and good diagrams are supplied. We are sceptical, however, as to the advisability of representing "each of two or more lines which are parallel to one another by two straight lines close together." This is put forward as an assistance to the memory, but the assistance, such as it is, may be very dearly purchased.

The deductions at the end of the volume—three or four on each proposition of Euclid, Book I.—are nearly all very easy; they do not require any knowledge of propositions subsequent to the ones to which they are attached.

Berättelse om en Resa til Grönland. ("Narrative of an Expedition to Greenland.") By Nils O. Holst. (Stockholm: Norstedt und Söner, 1886.)

DR. HOLST'S object in visiting Greenland was to investigate the phenomena of glacial action as they are manifested in the varied geological formations of the Arctic regions, and to secure materials which might help to elucidate many of the questions still needing solution in regard to the Ice Age in Europe.

Having obtained permission from the Swedish King to absent himself from his labours in connection with the Swedish Geological Surveys, and having been allowed by the Royal Danish Greenland Trading Company—generally very chary of granting similar favours—to make the voyage in one of their ships, he embarked at Copenhagen on April 8, 1881, in the *Peru*, which after thirty-nine days sighted the west coast of Greenland. Here he found himself suddenly brought into immediate contact with the ice-formations which he had come so far to study, for the pack-ice, which is annually brought by the Arctic current to the coasts of Greenland between the months of March and September, was so unusually dense in that year that it required ten days' cautious navigation to penetrate the ice—which, with a depth of 10 feet and more, was in many parts from 8 to 10 miles in width—and to reach safe anchoring-ground. This was at length found at Smalle, in 61° 32' N. lat., far to the north-west of Julianehåb, for which the *Peru* was bound, and there Dr. Holst left the ship and engaged a native boat to carry him to the mouth of Arsuksfjord, and to the settlement of Tigssaluk, where he had the opportunity of examining several of the "horse-shoe" moraines described by Hornerup, and comparing the land and water ice-sheets with their respective crevasses, glaciers, packs, and floes, besides making as complete a geological survey of the coast which he visited as time and circumstances permitted. In the course of these expeditions he ascended several of the characteristic so-called "*nunatakkor*," or bare field-tops, some of which are between 3000 and 4000 feet in height. On these isolated hill-tops were found, amongst other plants, various *Cladonias*, *Silenes*, *Cetrarias*, and *Luzulas*, besides *Rhododendron lapponicum*, *Nephroma arcticum*, &c.

Dr. Holst was disappointed in his expectation of examining the kryolite mines of Ivigtut, orders having been received from headquarters in Copenhagen that strangers should not be allowed to see the works, but he was able to determine the geological character of the district, and the conditions under which the mineral is found. According to him, the predominant rock is a grey, finely-

granulated gneiss, in some places impacted together with green sandstone into a tolerably dense granitic breccia. At some points the kryolite is found in direct contact with the granite, at others pegmatite is interposed between the two, while here and there this mineral is embedded in a granitic ivigtite.

Great interest attaches to Dr. Holst's observations on the nature and appearance of the so-called "kryokonite," in regard to whose origin the most opposite views have been maintained. According to the writer, who mainly agrees with the opinions held by Danish geologists, this substance is nothing more nor less than moraine mud; in support of which view he gives the result of the careful analyses made, independently of one another, by Profs. La saulx, Zirkel, and Svedmark, who agree in maintaining that kryokonite contains nothing but the ordinary constituents of the native rocks. The evidence supplied by these and other carefully-conducted microscopical investigations is, it would appear, so conclusive as to the true constituents of all kryokonites, that it has considerably modified the views once held by Baron Nordenskjöld and others, who at one time maintained the cosmic origin of these bodies. In point of fact, Dr. Holst's observations of this substance, of which he collected various specimens between Kipissako, in 61° N. lat., and Illuliakik, 65° 25' N. lat., seem to show that the kryokonite of Greenland differs in no way in its nature from the loess of Europe, of which it may be considered as the Arctic analogue.

During his four months' stay in Greenland Dr. Holst visited various native settlements, and his descriptions of the numerous difficulties he encountered in securing boats and guides in the face of the Greenlander's habitual slowness and vacillation are not without interest, but the great value of his narrative depends upon the care and clearness with which he has recorded the results of his scientific investigations. In these particulars, indeed, geologists will find that he has ably fulfilled the purposes of his expedition, and there can be no doubt that the results of his diligent study of the various processes by which glacial action is manifested, and the effects which it produces, will prove of the greatest use in contributing new materials towards the interpretation of various problems connected with the Ice Age in Europe.

A chart of South Greenland, drawn by C. J. Kjellström, on which the inland ice beds are marked in green and the habitable land in white, enables the reader to follow the track of coast explored by the writer between Holstenborg, in 66° 50', and Kipissako, in 61° N. lat.

The Handy Natural History. By J. G. Wood, Author of "Homes without Hands." With 226 Engravings. (London: Religious Tract Society, 1886.)

MR. Wood is so well and so widely known for his many popular books on natural history, that the present one is sure to be welcomed by a large number of readers. The illustrations as a rule are most excellent, and care has been taken to make the text as simple as possible for even juvenile readers. The chapter on the monkey tribe is one of the longest and most interesting in the book. Mr. Wood is very careful to state in his first page that between the lower animals and man there is a great gulf fixed which neither can pass. Mr. Wood does not seem to see that the question which has been widely ventilated of late years is not whether there is a great gulf now, but whether there was originally any gulf at all. It is not necessary that this question should be discussed in a book intended chiefly for juvenile readers; but in the absence of a discussion, the statement to which we refer is one which had better not have been made.

There is no index to the book, but at the beginning of it an alphabetical list of animals mentioned is given, which practically serves the purpose of an index. The

number of animals mentioned may be gathered from the fact that the list occupies seven pages of closely-printed type in three columns.

Hand-book of the British Flora. By George Bentham, F.R.S. Fifth Edition. Revised by Sir J. D. Hooker, F.R.S. (London: L. Reeve and Co., 1887.)

IN the preface to the first edition of this book the author explained that he had often been asked to recommend a work which should enable persons having no previous knowledge of botany to name the wild flowers they might gather in their country rambles. His object in writing his "Hand-book" was simply to meet this demand, and experience has shown that it is well adapted for its purpose. Sir Joseph Hooker, we need hardly say, has revised his late friend's work with perfect tact and judgment, adding considerably to its value by bringing it into accordance with the latest knowledge, without making any essential changes. Mr. Bentham held that previous writers on our indigenous flora had exaggerated the number of distinct species. His opinions on this subject, Sir Joseph Hooker thinks, should not be dismissed hastily, since they were the views "of a great master of systematic and descriptive botany who had collected and studied a large proportion of the prevalent forms of British plants in a living state, not only in our three kingdoms, but in France, Scandinavia, Russia, Germany, Switzerland, and Turkey."

The Zoological Record for 1885. Being Vol. XXII. of the Record of Zoological Literature. Edited by Jeffrey Bell, M.A., &c. (London: John Van Voorst, 1886.)

BEFORE the close of 1886 the record of zoological literature for the year 1885 was in the hands of those interested in zoology, and the editor is to be warmly congratulated on this result. The difficulties in the way of such a result are very great; on the present occasion they have been overcome, and we confidently trust the same may be the case for the future. The recorders have accomplished much, but they would be able to do more if the writers of scientific memoirs would assist in so desirable a cause and promptly send to the editor copies of their writings when first issued from the press. All of the recorders seem to have done their share of the work with care and discretion, though to some the lion's share has fallen; the largest contributor being Dr. Sharp, who records all the Insecta with the exception of the Neuroptera and the Orthoptera, which latter groups are recorded by Mr. McLachlan. The large group for so many years recorded by Dr. von Martens is now divided between Prof. W. A. Herdman and Messrs. W. E. Hoyle and G. R. Vine. Dr. P. Bertkau records the Arachnida, including the new species and genera for 1883 and 1884. Numerous corrections and additions have been made in the list of works consulted, and this list now forms a very useful work of reference to the scientific publications of the world. To the records of the Mammalia and the Birds short introductory paragraphs are added, a practice which we would suggest to the other recorders. It is very expedient that they should follow this example, for, short though these paragraphs are, yet in them the reader gets some hint of what has been done in the group for the year. The Zoological Record Association is again able to record grants of 100*l.* each from the Government Grant Fund and the British Association, and one of 10*l.* from the Royal Irish Academy. Although these money grants are extremely well disposed of, we very much regret that so valuable and essential a publication should be to a large extent dependent upon them, and we would fain hope to see the list of subscribers greatly increased.

LETTERS TO THE EDITOR

[The Editor does not hold himself responsible for opinions expressed by his correspondents. Neither can he undertake to return, or to correspond with the writers of, rejected manuscripts. No notice is taken of anonymous communications.]

[The Editor urgently requests correspondents to keep their letters as short as possible. The pressure on his space is so great that it is impossible otherwise to insure the appearance even of communications containing interesting and novel facts.]

Lightning-Flashes

THE brief note (NATURE, vol. xxxv. p. 85) giving the results of the observations of Herr Leyst, of the Pawlowsk Observatory, on the anomalous forms of lightning-flashes, suggests several considerations relating to this class of phenomena.

Leaving out of view the exceptional and anomalous phenomena of slow-moving (ball or globular) lightning—which are very difficult to correlate with any purely electrical manifestation—it is questionable whether it is possible for the observer to determine the direction in which the electrical current moves. In ordinary cases the velocity of the electrical discharge is so great, and the duration of the luminous flash is so brief, that it is impossible for the unassisted eye to determine the direction of motion.

According to the experiments of Prof. Rood (*American Journal of Science*, third series, vol. i. p. 15, 1871; also *idem*, vol. v. p. 163, 1873), the duration of lightning-flashes varies from 1/1600 to 1/20 of a second. Even the maximum duration of 1/20 of a second is probably too small to be recognised by the unaided human eye. Hence simple observation by means of the eye cannot determine the direction in which the electrical current moves.

It is nevertheless true that the eye seems to perceive the direction of motion of the luminous tract from one point of the cloud-covered sky to another. But this seeming recognition of direction must be an illusion of judgment based upon our interpretation of the phenomena presented to the sight. In these cases, our judgment of direction of motion seems to be dependent upon two considerations:—

(1) When the flash bifurcates or forks, we imagine (probably from the analogy of a ruptured projectile) that the electrical discharge passes in the direction of the diverging branches.

(2) But the more common cause of illusion of judgment in relation to the apparent direction of motion of the electrical discharge arises from the difference of brightness of different portions of the luminous path; this gives rise to a difference of duration of the lingering visual impression on the retina. Thus, in the case of a flash several kilometres in length, one extremity will probably be much nearer to the observer than the other; and hence the light emanating from one end will traverse a shorter distance of absorbing atmosphere than that emanating from the other end. This would necessarily render one extremity the end where the visual effect lingered longer at a later period than the other extremity. In other terms, the light produced in the luminous path is really generated sensibly at the same instant of time along its entire length, and the apparent direction of discharge is an illusion of judgment arising from the varying duration of the visual impression, due to differences of brightness in different portions of the flash. It is evident that the refinements of modern methods of measuring indefinitely small intervals of time might render the actual direction of motion of the electrical discharge appreciable to our senses.

With regard to the zigzag and irregular branching forms of lightning-flashes, these are the natural results of electrical discharges through an interrupted and non-homogeneous medium. The enormous length of some flashes (eight or ten kilometres) indicates that the intervening non-homogeneous dielectric acts as an interrupted conductor. In such a medium the path of electrical discharge is along the line of least resistance, which is the line of best induction, which is likewise the line of best conduction. In the atmosphere these lines are irregular and are perpetually shifting, hence the path of discharge may be nearly rectilinear at one time, branching at another time, and even quadrilateral at another time.

Berkeley, California

JOHN LE CONTE

THE quotation from M. Him in your issue of January 29 (p. 303) suggests a few remarks. What may be the greatest length of a flash of lightning? In the year 1843 I attempted to answer this question by the following observations.

My Inarya hut had far-projecting eaves supported by rough posts, some black, others white, and thus easy to distinguish. On the first appearance of a storm in a brick-red cloud I took my seat near the three-hold, leaning my head against the door-post, and holding to my ear a pocket-chronometer. Among several flashes I noticed one nearly horizontal. It travelled northwards, and its thunder followed 54.4 seconds later. The thermometer being then at 19°C., I took that degree of heat, from want of better information, as mean heat of the whole trajectory, and got thus 343.7 metres for the velocity of a sound per second. This gave a distance of 18.7 kilometres for the commencement of the flash. It had begun before post A and ended beyond post D. As they were near me, I took care not to move my head before measuring with a small sextant the horizontal angle between A and D. I found it = 20° 30', and obtained thus 67.60 metres for the length of flash, supposing it horizontal and perpendicular to my line of sight. This result was a minimum, because the angle was evidently too small, and because moreover the flash, not quite horizontal, had travelled obliquely towards me. I drew the latter conclusion also from what appeared to me a fact on this and on other occasions, viz. my ear referred the thunder successively to different parts of the preceding flash. If an amanuensis had been at hand, I could have dictated to him at what beats of the watch the sound came from the direction of each post. It would then have been easy to get at least a rough estimate of the azimuth in which the flash travelled, and consequently its real length. In a similar way I measured on another day a flash more than ten times longer. I have not put down its particulars, because such an enormous result made me fear some mistake in time or angle. On my return to Europe, I mentioned these observations to the late F. Petit, then astronomer at Toulouse. He subsequently informed me that he had measured two flashes of lightning, one 13 and another 17 kilometres long. Should you publish the foregoing note you may induce other observers to follow this line of inquiry with improved appliances.

ANTOINE D'ABBADIE

Abbadia, Hendaye, February 2

Dr. Modigliani's Exploration of Nias

You have on two occasions given news of Dr. Elio Modigliani's recent exploration of this remarkable and interesting island. I believe it will therefore interest your readers if I endeavour to complete such information. Dr. Modigliani returned to Florence from Nias a short time ago, and at the last meeting of our Anthropological Society gave an able and graphic account of his visit to the island, and especially of his experience of the people; he illustrated his communication with an exhibition of the rich and very complete ethnological and anthropological collections he has made.

The natives of Pulo Nias are evidently Malesoid, judging from numerous interesting photographs taken by Dr. Modigliani. I face a Papuan skull had been fastened to his own; and looking at it you also some resemblance between the Nias people and some of the hill tribes of Southern India. No traces of stone or shell implements are found in use at Nias. The natives get their iron, brass, and gold from traders, principally Chinese, but work the metals themselves with a primitive forge, making axes (hafted in wooden, club-like handles, as those of some African tribes) lance-heads, and swords: the former, usually barbed, recall the Celebes ones; the latter are very like the *parangs* of the Borneo Dyaks. Their shields are often heavy and cumbersome, coated with buffalo-hide, very Bornean in shape; they make beside curious iron helmets of a common Asiatic pattern. The sword is sheathed in wood, and have in front a globular wicker or rotang basket, the size of a big orange, which contains curious and very various amulets, with which they never part willingly; the handle is often carved so as to represent a grotesque human face. The Nias people are inveterate head-hunters, and Dr. Modigliani showed one of their ghastly trophies procured while he was there, and preserved in spirits. The head is buried, and when the flesh has fallen off, the skull is hung up under the council-house. Every young fellow to be considered a man must have cut off at least one head—no distinction is made of sex

age; after that, he wears as special badge a collar made of a lashed section of the cocoa-nut palm stem with ends of brass. The women go about with a curious staff ornamented with as; the usual ornaments are armlets of brass wire, bracelets out of Tridacna-shell, and ear-rings of the same material or of tal, and beads. The clothes used to be, and in the southern tracts are still, entirely made of beaten bark. Their idols are roughly carved wooden figures, and both they I the still more primitive carvings representing dead relations idly recall the idols and the *Karwars* of the Western Papuans. ch village has its chief, and usually war to the knife is waging ween one village and the other. This renders a thorough loration of Nias far from easy. Dr. Modigliani certainly lost no time, and did his very best; I although quite new to such explorations, in a very short time, h rare energy and perseverance, surmounting many difficulties I not slight dangers, he has succeeded in bringing home most esting and ample information on the people, extensive nological and anthropological collections, important zoologi-series, and a most interesting sample of the local flora, ongt which are some new species. of the singular ant-plants (*ymecodia*) now being illustrated by Dr. Beccari. I must say in conclusion that I do not know of any traveller young and inexperienced who in so short a time (Dr. digliani was absent from Florence altogether just eleven nths) has succeeded in doing so much and so well.

HENRY H. GIGLIOLI

Royal Museum, Florence, January 22

"*Lepidosiren paradoxa*"

ZOOLOGISTS will be interested to hear of the capture of a fine cimen of this the rarest of the Dipnoi. Only a few weeks I received from my friend Dr. J. Barbosa Rodriguez, the med and energetic Director of the Museu Botanico do azonas, at Manaós, a very fine specimen of the *Lepidosiren*, tured some time last August in that neighbourhood. This cimen is well preserved in alcohol; it measures 85 centimetres in length, with a girth behind the pectorals of 28 timetres. On opening it I found that it is a female, the ries being well laden with well-developed ova; unfortunately alcohol had not been let into the visceral cavity, and none of internal organs were in a condition to be successfully invest-ed. I found the pericardium singularly large and thick. The ly is cylindrical, but quite flat along the abdominal surface, ere the scales are also bigger, thicker, and of a lighter colour. e short caudal region is much compressed. There are no e median fins except the irregularly rounded caudal, which ends merely as a slightly marked keel to about the middle of back. The fin-rays on the caudal portion are close together, tilaginous, and quite hidden by the skin; pectorals and trals without traces of membranous edging and rays; the ner are slender and compressed, the latter conical and con-rably stouter. The entire body, except the head in front of eyes and the paired fins, is covered with moderate cycloid s—thicker, as I obs-rved, on the *abdominal cuirasse*, ext- from the chin to the anus and composed of about ten titudinal rows of scales. Except along this ventral stripe, ch is of a whitish colour, the animal is generally of a dark wnish purple, with darker indistinct blotches. The double ral line is dark; it reticulates on the cheeks and around eyes. These are quite rudimentary, and show under skin as a whitish spot; they remind me of the eyes the two *Gymnotus* which I saw alive in the Insect House the London Zoological Gardens last October. The chial openings are very narrow, protected by a thick fleshy e; there are no traces of external branchial appendages, sed, even the internal branchiæ cannot be seen through deep, narrow, branchial slit. The mouth is terminal, e well-developed fleshy lips; there are two small conical rine teeth; the maxillary and mandibular dental plates are imilar in size and shape; fleshy pads fit into the spaces een the dental ridges. The tongue is thick, smooth, and y, with a rounded point. Four branchial clefts can be made on each side in the pharynx, the fourth is much reduced; the e free branchial arches are fringed with conical papillæ. The e and mucous membrane of the mouth is white and quite oth; the pads along the dental plates are papilous. The e is exactly 10 millimetres on the left of the mesial line; it

is 8 millimetres in diameter, and surrounded with a border in deep folds. I had forgotten to mention the nostrils: both pairs are inside the mouth; the anterior ones, just within the upper lip, are ovoid, transverse, without flap or valve; the posterior pair are situated just outside the hinder ridge of the maxillary dental plate, they are ovoid and longitudinal.

I need hardly insist on the importance of the capture of this new specimen of *Lepidosiren*. As far as I am aware, this is the fourth known; there are, besides, Natterer's two preserved at Vienna, and Castelnau's one in the Paris Museum. More recent explorers have utterly failed to find any, although an active search was made by several. Only recently I heard from a high authority the expression of a doubt as to the existence of such a creature as the South American *Lepidosiren*!

I may finally state that, evidently prompted by his friendship for me, Dr. Barbosa Rodriguez, seeing, as he believed, distinctions in his specimen, sent a brief description to a Rio scientific periodical, naming it *Lepido.iren gigliolina*; this before forwarding the specimen to me. I have not yet seen his description, nor am I in a position to decide as to any distinction existing between this and the other three existing specimens. I can only say that I consider such a difference very unlikely. I suppose that, like *Ceratodus*, *Lepidosiren* is liable to considerable individual variation. Lastly, I believe it not unlikely that *Lepidosiren* may be on the verge of extinction; that would account for its rarity.

HENRY H. GIGLIOLI

Royal Museum, Florence, January 22

The Coal-Dust Theory

SOME of the facts elicited at the adjourned inquest on the bodies of the twenty-eight persons who lost their lives in an explosion at Elemore pit on December 2 last, appear to have a direct bearing upon the coal-dust theory, and are therefore worthy of being recorded. It will be remembered that the inquest was adjourned until January 18, when it was re-opened; it was concluded on the following day. The verdict of the jury was as follows:—

"That Ralph Fishburn and others met their deaths by an explosion in the George Low Main seam, Elemore Colliery, on the morning of December 2, 1886; that the said explosion occurred between the Daleway end and the greaser; but what caused the ignition there is not sufficient evidence to show."

One of the victims, named Luke, who afterwards died from his injuries, made a statement to the effect that a shot was fired in one of the main intake airways not far from the bottom of the down-cast shaft, at the instant the explosion took place. The person who, according to Luke's statement, ignited the shot, still survives, and denies having done so, although he admits having fired a shot near the same place a short time previously. Some of the experts, including the two inspectors of mines, came to the conclusion that Luke's statement was the more probable; others were unable to concur with them in this. The evidences of violence point to the place indicated by Luke as having been the origin of the explosion. A good deal of discussion took place between some of the examining counsel and solicitors and some of the witnesses, as to whether coal-dust alone in the absence of fire-damp could originate and carry on an explosion, but nothing new was elicited in this respect. All agreed that there could not have been any gas present at the point where the shot was said to have been fired. Mr. G. Baker Foster was "quite of opinion that there had been no gas; . . . he could not imagine that in such an intake, with such ventilation, and such a position, gas could accumulate for a minute." Mr. Bell, the Inspector of Mines for the district, said:—"The ventilation throughout the pit was good. It was a well-managed pit, and the last in which he would have expected an explosion to take place." Mr. W. M. Atkinson, the Assistant-Inspector, said:—"The explosion was confined to those parts of the pit least likely to contain gas, and where there was the most coal-dust. It was highly improbable that there was any fire-damp where the explosion originated. He once examined the place when the barometer was as low as 27.5 inches, and no trace of fire-damp could be detected." (The barometer stood at 29.55 inches at 1 a.m., two hours before the explosion.) "He believed the explosion was entirely due to the combustion of coal-dust in pure air, and that its ignition was caused by a shot fired by Johnson. A blown-out shot would not be necessary. Wherever there had been coal-dust in the mine the explosion had gone; but wherever there was an absence of coal-dust,

there the explosion ceased." The last statement was not called in question by anyone, and stands unimpeached.

Those witnesses who would not go the length of saying that coal-dust alone in the absence of fire-damp had caused the explosion, had no explanation of their own to offer. The "outburst of gas," the cry which used to be so often adopted in similar cases, was not entertained by anyone in this case. Some of the witnesses were unable to accept the coal-dust theory on account of preconceived notions regarding it; others had read in books and papers certain statements which prevented them from adopting it; and one (Mr. Lishman, the manager of Elemore Colliery) had made experiments, with an apparatus similar to one of mine, which did not lead to conclusive results. With these conflicting opinions before them, the jury arrived at the conclusion that the men had been killed by an explosion, but, with the characteristic caution of men of the North, they refrained from stating what it was that had exploded.

Cardiff, February 3

W. GALLOWAY

Abnormality in the Urostyle of the Common Frog

ATTENTION has recently been drawn to abnormalities in the vertebral column of *Rana*. (See Burne, *Quarterly Journal of Microscopical Science*, January 1884; Hoates, *Anatomischer Anzeiger*, 1 Jahrgang, 1886, Nr. 11; Lloyd Morgan, *NATURE*, November 1886.) One form of such abnormality is the addition of a supernumerary (tenth) vertebra.

I wish here to record the occurrence, in the skeleton of a large *Rana temporaria*, of an abnormal urostyle, bearing at its anterior end a larger (right) and a smaller (left) transverse process. These are shown in the accompanying figures. Fig. 2 shows a tendency,

in the dorsal moiety, towards a segmentation of the urostyle and the separation of a supernumerary vertebra. The coccygeal foramina lie just behind the transverse processes.

This case is interesting as showing an incompletely separated tenth vertebra, and as bringing an abnormal *Rana* into relation with a normal *Discoglossus*.

C. LLOYD MORGAN

University College, Bristol

The Cambridge Cholera Fungus

I HAVE read with much interest the correspondence on the above subject in your issue of January 27 (p. 295). In the new edition of my work on bacteriology, to be issued, I hope, before many days, will be found the following statement:—

"At a meeting of the Physiological Society, held May 15, 1886, at Cambridge, a preliminary communication was made upon the investigations in Spain, referred to in the first edition of this work. The observations made by Roy, Brown, and Sherrington rather tend, in the opinion of the author, to confirm Koch's views. Comma-bacilli were found to be present in some cases in enormous numbers, and the frequency of their occurrence led these observers to believe that they must bear some relation to the disease. At the same time, as they failed to find them in all cases, they regarded the existence of a causal relation as not proven. They failed to find the Naples bacterium or the small straight bacillus noted by Klein, but they drew attention to certain peculiar mycelium-like threads in the mucous membrane of the intestines. These organisms, however, judging from a preparation stained with methylene-blue which was exhibited at the meeting, appeared to the author to much more closely resemble some of the involution-forms of comma-bacilli, *filaments à masses globuleuses*, figured by Van Ermengem, than anything else he had seen. Yet assuming these peculiar structures to belong, as described, to some species of Chytridiaceæ, it is very doubtful whether they can be considered to be of any significance. Methylene-blue has been employed by Koch and

others, including the author, for staining sections of the intestine from cholera cases, and had they been constantly present, it is hardly possible that such striking objects could have been overlooked. Again, we must bear in mind that hyphomycetous fungi have been found occasionally to occur saprophytically in the intestinal canal, as well as in the lungs, external auditory meatus, and elsewhere. We must, however, wait before expressing a more definite opinion, until the Report of these observers is published in full."

This, I think, may explain Mr. Gardiner's difficulty. Very probably the same preparation was shown to him, as his second opinion coincides with the conclusion I arrived at last May. I have now before me the Proceedings of the Royal Society, No. 247, and I am greatly puzzled by the illustrations, for they certainly appear to represent a branching mycelium, and do not in the least recall to my mind the preparation which I had an opportunity of examining.

EDGAR CROOKSHANK

Eastbourne, January 31

Low Barometric Readings

IN A Note in *NATURE* of December 16 (p. 157) you observe that the barometric reading of 27.333 inches (reduced to sea-level) recorded at Ochertyre, Perthshire, on January 26, 1884, is the lowest observed by man anywhere on the land surface of the globe. This, however, is not the case. The cyclone which on the morning of September 22, 1885, swept over False Point, on the coast of Orissa, gave the lower readings 27.135 at the beginning of the central calm, and 27.154 half an hour later (both readings reduced to 32° and sea-level). These readings are perfectly authentic, the instrument being a Casella's observatory standard (on Fortin's principle) that has been verified with the Calcutta standard and is corrected to that standard, which is 0.011" higher than the Kew standard. Its elevation above the sea, 20.6 feet, has been determined by spirit-level; and the observer, Mr. Workman, is one of the best of those who keep a regular meteorological register for this department. The above are the lowest of a series of readings, taken at intervals throughout the storm, which was then travelling at the rate of thirteen miles an hour.

The storm will be long remembered as that in which the settlement of Hookeytollah, six miles to the north of False Point lighthouse, together with its inhabitants, was swept away by the storm-wave accompanying the cyclone. At False Point station the water rose 22 feet above mean sea-level directly after the passage of the storm centre. The country inundated lay to the north of the lighthouse, and is a low-lying alluvial tract from 4 to 5 feet above mean sea-level, intersected by a network of salt-water tidal creeks.

The destruction that ensued was very great. Including the small settlement of Hookeytollah, some two thousand households were swept away, representing a loss of from six to ten thousand souls. Crops valued at ten lakhs of rupees (100,000/.) were irretrievably damaged and lost; the wells and tanks of drinking-water were rendered unfit for use; and about 60,000 acres of land rendered unfit for cultivation for two or three years to come. But even this is very small in comparison with the destructive effects of the Calcutta cyclone of October 5, 1864, and those of the Backerganj cyclone of November 1, 1876.

HENRY F. BLANFORD

Indian Meteorological Office, Calcutta, January 6

Magnetic Theory

MR. WATSON asks, What is the physical evidence in favour of the existence of *A, B, C*, and *a, β, γ*? With regard to the former the evidence, derived from the permanence of the magnetisation in a small piece of a hard steel magnet, seems to me almost conclusive; while the following consideration tells very strongly in favour of *a, β, γ*.

To determine the mechanical force and couple acting on a magnetic element placed in a magnetic field in air, we treat it as consisting of two equal and opposite poles very near together, and find the resultant of the forces on the two poles. It may be proved without difficulty that the same process may be used to find the mechanical force and couple, arising from magnetic causes, acting on an element within the mass of a magnet. In the first case we may, of course, employ either *a, β, γ*, or *a, β, γ*, as the forces acting on a unit pole. But in the second case we

must employ α, β, γ , as defined in Mr. Watson's letter in your issue of January 27 (p. 296). These mechanical forces cannot, I believe, be expressed in terms of the values of a, b, c, u, v, w , and their differential coefficients at the point. This is a definite physical argument in favour of the existence of α, β, γ , within a magnet.
St. Moritz, Engadine
JAMES C. MCCONNELL

"Phantasms of the Living"

NOTHING in your last week's notice of "Phantasms of the Living" gratified me more than the attention paid to our experimental results. The grounds of our own confidence in them are (1) that the conditions were in many cases such as completely to exclude unconscious physical signs, and (2) that, if the success was due to fraud, it was not fraud which the investigators failed to detect, but fraud in which they must actively have shared. But, where the scientific presumption against new phenomena is so strong, it is best to recognise that no line can be drawn at which the evidence for them *ought* to be found convincing, and that, till it actually *is* found convincing, it is incomplete. Meanwhile it *ought* to be sceptically approached—not with the impatient scepticism which denies that such facts can ever be proved, but with the cautious scepticism which perceives that they require a very great deal of proving. The object of this letter, then, is to urge the paramount importance of extending the area of experiment. This cannot be done without an amount of public spirit which it is very hard to evoke. The "percipient" faculty, even though possessed in a high degree, is very unlikely to reveal itself spontaneously: our only hope of discovering it is that trials in thought transference shall be very widely made—which means that a large number of persons shall spend some time and trouble in a manner which will often appear to have been fruitless. It is difficult to press this on anyone as a duty; but it is at any rate worth while to point out how simple and rapid the process of experimentation may be made. Especially anxious am I that a great many pairs of persons should carry out experiments of the very simple type described in "Phantasms," vol. 1, pp. 32, 33. If any of your readers are willing to do this, will they kindly, *before beginning*, send me their names and the number of the trials that they propose to make, to guard against any selection of results?
EDMUND GURNEY

14 Dean's Yard, S. W., February 3

University College, Bristol

MY attention has been called to a paragraph in your issue of the 3rd inst. (p. 326), referring to this College. Will you kindly grant me space to correct the statement made therein, which is inaccurate in some important points, and is calculated, as it stands, to injure our reputation?

No general reduction of the salaries of the Professors has been made, nor is it contemplated. Notice to terminate our engagement with two Professors has been given them, as it was believed that more advantageous arrangements could be made in their departments without affecting the quality of the instruction given. It is too true that the College greatly needs more liberal pecuniary support than it has hitherto received, but efforts are being made to procure it; and as yet the Council have no intention of limiting the subjects hitherto taught, or of requiring a lower standard of attainment than that which has distinguished so many of their Professors.

ALBERT FRY,

Chairman of the Council

University College, Bristol, February 7

A Rule for escaping a Danger

SUPPOSE a weir, AB, across a river, and first let it be at right angles to the direction of the current. Suppose a man in the stream above the weir, nearer to B than to A. Let O be his position, and OX a perpendicular on AB. Then he cannot

escape if his velocity, v , is $< \frac{OB}{OX} \cdot u$, where u is that of the stream. If his full speed has this critical value, or if there is any uncertainty about his safety, he must swim at right angles to OB.

The rule is obviously correct, for to escape he must clear the nearer end of the weir, and must therefore exert his strength in the direction mentioned. Geometry puts it clearly: Reduce the stream to rest so that the weir is advancing on the man with

velocity u . Let P be the point at which the man is overtaken, then, if PN be perpendicular to AB,

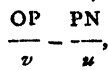

so that P is on a conic for any given velocity. Varying v , he will escape if the conic reaches the bank. The first to do so touches at the end C of the minor axis, and since CB is a tangent, the angle COB is right. Also now

$$v : u = OC : CB = BX : OB.$$

If the weir slants across the river, the direction of safety is still at right angles to the line joining O to A or B. The swimmer must decide, by looking in both directions, to which bank to direct his efforts. The locus of points for which both directions give the same distance is, to axes through the middle of the weir up and at right angles to the current, of the form

$$(y^2x - 2aby + b^2x)(y^2a - 2bxy + ab^2) = by(x^2 - a^2)^2,$$

a quintic having cusps at A, B.

The rule fails if the change of velocity as one approaches the bank be considerable. One would then strike more across.

If one were being charged by any insensate object, the rule would of course apply.

FRANK MORLEY

Bath College

Abnormal Cats' Paws

IN reference to the recent articles in NATURE on six-toed cats, allow me to remark that the experiment about to be tried on one of the small islands off the English coast has *apparently* been anticipated at the village of Morrishes Centre, on Long Island, where nearly all the cats have at least one supernumerary digit on all feet, and are currently called, in the place, "double-footed." I have a specimen showing the abnormality distinctly. I say "apparently," because there can be little doubt that at some time a single individual was introduced, which has become the ancestor of all the "six-toed" cats in the village.

E. W. CLAYPOLE

ABNORMALITIES in cats' paws occur rather frequently in Massachusetts. They are called mitten cats, and are much in demand because they are considered to be good mousers. The first I ever saw was a male yellow tiger, whose four paws had two extra toes strongly developed. A little stray fe male kitten which was brought up at my house had two abnormal fore-paws with four extra toes on each. As there are no male cats in our neighbourhood with any abnormality I was very anxious to see whether her young ones would inherit the shape of their paws from the father or mother cat, and whether some abnormality would also appear in the hind-paws. She had eight, and only one of them with four normal paws; all the others inherited from the mother the abnormal fore-paws, some even having five to seven extra toes, with perfectly developed claws and pads. I did not pay attention to the sex, but brought one up on account of its strong build, which turned out to be a male, and another for its beautiful stripes, which was a female. The old cat rested nearly a year, and then again had eight three times in succession, in April, June, and October, and every time only one with normal paws. The mother is a pale grey tiger, and each one of the young ones was differently spotted, and, as I believe, had a different father, as I recognised the marked resemblance to the various visitors to our garden. I paid no attention to the sex, but brought up from the last litter the strongest looking, which turned out to be a male, and two others—the one selected by a child, the other because it had seven extra toes. Both these were females.

H. A. HAGEN

Harvard University, Cambridge, Massachusetts, January 5

The Cross as a Sun Symbol

THE use of the cross as a sacred symbol dates from the earliest times, and is almost universal. It occurs upon the monuments and utensils of every primitive people from China to Yucatan. In many, perhaps in a majority of, instances it is used as a symbol of the sun. One of the oldest and most widely occurring forms is the cross with *crampons* turned to the right or left, the *svastika* and *sauvastika* of India, the "Thor's hammer" of Western Europe. Prof. Max Müller thinks that the *svastika* represents the vernal sun, and is hence an emblem of life.

health, and creative energy (Schliemann's "Ilios," p. 348). Mr. Edward Thomas (*ibid.*) believes it to have arisen from the conception of the sun as a rolling wheel. The Chaldean sun symbol was first a circle, then a circle with an inscribed cross. The symbol of the sun-god at Sippara is a small circle with four triangular rays, the four angles between being occupied by radiating lines, and the whole circumscribed by a larger circle. The same symbol occurs repeatedly upon the shell gorgets of the mound-builders (Second Annual Report of the U.S. Bureau of Ethnology, plates liii., lviii., and lix.). The peculiar figure repeated upon the *façade* of the "House of the Nuns" at Uxmal seems to be a conventionalised circle and cross with rays. The Moqui symbol for the sun is a Greek cross with a small circle at the centre, in which are three marks to indicate the eyes and mouth of a face (First Annual Report of the U.S. Bureau of Ethnology, p. 371). It is needless to multiply examples: the important question is, How has the cross come to be a symbol of the sun? If anyone will observe carefully a lamp, or other bright light, with partially closed eyes, the answer will be obvious. The rays which appear to proceed from the luminous point always form a cross of some kind. A little experimenting will show that this appearance is due to reflection from the eyelashes and edges of the eyelids. The same experiment may be tried with the sun itself: if observed when considerably above the horizon, squinting will be unavoidable. If the head is erect, the downward arm of the cross will be much the strongest, and the upward arm may be obsolete; but if the head is thrown back, the arms will be nearly equal. The evolution of the sun symbol seems to have been as follows: He was first represented by a circle or disk as he appears when near the horizon; observations made when he was shining brightly revealed the crossed rays. This led to a combination of the circle and cross. If this hypothesis be correct, the *svastika* was originally neither a rolling wheel, nor, as Burnouf supposes, the crossed sticks from which our ancestors elicited fire; but it is a modification of the circle and inscribed cross.

It is not claimed that the cross has in every case originated in this way; but since sun-worship is known to have been an almost universal form of primitive religion, and since the unscientific observer would be sure to regard the crossed rays as an essential part of the sun, this hypothesis furnishes a reasonable explanation of the universality of the symbol. Anything bearing the cross would be regarded as sacred; hence the Egyptian worship of the scarab, as noticed by Mr. R. G. Haliburton (*NATURE*, vol. xxxiv. p. 610), and the spider-gorgets of the mound-builders (Second Annual Report of the U.S. Bureau of Ethnology, plate lxi.). Not the least remarkable feature of the subject is the fact that the most ancient and universal symbol of the physical sun should, for entirely independent reasons, continue in use as the sign of "the Sun of righteousness" and "the Light of the world."

CHARLES R. DRYER

Fort Wayne, Ind., U.S.A., January 12

Clausius's Formula

In the report of our preliminary communication to the Royal Society, reported in your issue of the 13th inst. (p. 262), we give Clausius's formula intended to express the relation between the gaseous and liquid states of matter as

$$p = \frac{RT}{v-a} - \frac{c}{T(v+\beta)^2}$$

We should have mentioned that this formula has been amended by Clausius to

$$p = \frac{RT}{v-a} - \frac{c}{\Theta(v+\beta)^2}$$

where $\Theta = aT^{\alpha}$. As Θ is a function of T , it is evident that this latest form also is not in agreement with the simple relation pointed out by us for ethyl ether,

$$p = \delta T - a.$$

WILLIAM RAMSAY
SYDNEY YOUNG

January 20

Notes on Certain Traits of Infant Navajos

As we know, the Navajos are an American tribe of Indians, scattered for the most part over the Territories of New Mexico and Arizona. Quite a number of them live with their families,

in the curious little habitations they erect, about the front military station of Fort Wingate, New Mexico. It is in the latter place that I have had the opportunity, for over two years past, of studying many of their ways and customs. And it was here, too, that, a few days ago, I went out among them with photographic camera, armed with an English instantaneous shutter, with the view of taking a few pictures of them while they were actively engaged in some of their very interesting games.

After having obtained four or five more or less satisfactory plates, the Indians became quite restive, as they rather object to that sort of a thing; and, as if by common consent they gradually disappeared, a few at a time making for one of their low, conical-shaped mud huts, where they entered through the single small door at its side. In less than half an hour there were none of them to be seen outside at all, and, knowing full well that they would not appear again so long as I remained upon the ground, I shouldered my instrument and prepared to come away. At the time, I was standing between two of their huts, situated some three hundred yards apart, with a well beaten, though narrow footpath passing from one to the other. There were no trees within a quarter of a mile, the plain being sparsely covered with sage-brush, the plants being from 2 to 3 feet high. Just then one of their babies toddled out of the doorway of the upper hut; the child could not have been over ten months old, and wore only a very dirty little shirt, which came about half way down to its knees. It looked more like an infant Eskimo than any child, not white, that I know anything about; and it started right down the path with a very unsteady baby-waddle, making for the lower hut, where I imagine its mother had taken refuge from my mercile camera. I had often longed for a good picture of a Navajo baby in its native plains, and here was an opportunity not to be lost. So, stepping a few feet out of the way, in an instant I had my instrument in position, focused on the path, and, with instantaneous snap ready, I stood quietly for my subject to pass. Or he toddled, until he came within about 30 feet of me, where he suddenly stopped, and, to my surprise, seemed to fully take in the situation.

At this stage, I feel quite sure that one of our babies, especially at this tender age, would have begun to cry, and more than likely retraced its steps to the hut from whence it had issued. Not so, however, this infant Navajo; and, mark the difference. He steadily watched my every movement, and was evidently determined to reach the lower hut. Very cautiously leaving the path on the side furthest from me, he was, in the next instant, behind one of the sage-brushes, which was something over a foot taller than the baby. From this position he peered through the leafless twigs at me, to see what I would do about it. A little annoyed at this turn in affairs, I threw the focusing-cloth over my head, and turned the instrument on him. Taking advantage of this temporary concealment of my head, he ran, thoroughly baby-fashion, to the next lower brush, a distance of some 10 feet, where, hiding as before, he crouched down, and stared at me like a young lynx through the twigs. He now looked, for all the world, the young Indian cub at bay, with all the native instincts of his ancestors on the alert, and making use of all the strategy his baby mind could muster. It was a wonderfully interesting picture to study; but, fearing that I would lose a permanent memento of it, I turned to lift my instrument, with the view of taking a much nearer position, when, again facing the brush where I had last seen the baby, it was, to my great surprise, not there, but had scampered to the next lower one, in the direction of the hut for which it was bound. A full-grown buck of the tribe could not have possibly managed this last movement any better. As it ran to the still next lower brush, I was astonished beyond measure (for, I take it, I am a good stalker myself) how it took advantage of everything that lay in the short intervening distance, and how, after it arrived at the brush, it immediately took a position on the opposite side of it, from where it could make another quick start, and yet not lose sight of my movements. And, mind you, all this from a baby only ten months old at the most. As it was rapidly gaining its point and approaching the lower hut, in sheer desperation I ran up on its last place of concealment, holding my camera in such a way that I could immediately place the tripod in position, which I succeeded in doing, with the lens levelled directly at its head, and not 3 feet from it. It now stood up to the full extent of its baby height, and, giving vent to a genuine infantile howl, it made a break for the final point of its destination, for there

was nothing else left for it to do. It is almost needless to add that, before I could focus and insert a plate, my Navajo baby was out of range. And, fearing that its angered mother might appear at any point, at the cry of alarm of her child, I immediately forsook the ground.

My object in making a record of such an interesting case as this is to simply draw attention to the fact that the native instincts of these American Indians are exhibited in their young at a wonderfully tender age; and in this particular they differ vastly from our own children at a corresponding time of life, and reared, as they have been for ages, in a civilised environment.

R. W. SHUFELDT

Fort Wingate, New Mexico, January 11

LONG-LOST REEFS

A REMARKABLE instance of the manner in which small reefs in the ocean may elude search has recently been brought to light, and may be of interest to some readers of NATURE.

In June 1768 M. de Bougainville, in the frigate *La Bouteuse*, having left Espiritu Santo, in the New

Hebrides, was sailing west over the Coral Sea, south of New Guinea, near the parallel of 15° S. At midnight of the 4th he sighted a sand-bank, and waited till daylight to examine it, when it proved to be a very small patch of sand only just out of water, with apparently no reef around it. This he called Bâture de Diane.

Resuming his course west, he, on the 6th, having run by his reckoning 137 miles from the sand-bank, sighted a reef on which the sea broke heavily, and closing it, at noon obtained its position. After a zig zag course of five hours, another reef was seen ahead, and as this might be but the prelude to more, the project of exploring further westward was given up, and *La Bouteuse* steered northward, making New Guinea at a bay to which the name of Cul de Sac de l'Orangerie was given. Bougainville thus lost the honour of discovering the eastern coast of Australia, which the celebrated Cook explored two years later. On the last reefs seen no name was bestowed, but they have always been known as the Bougainville Reefs.

Time passed, but these dangers were not again seen.

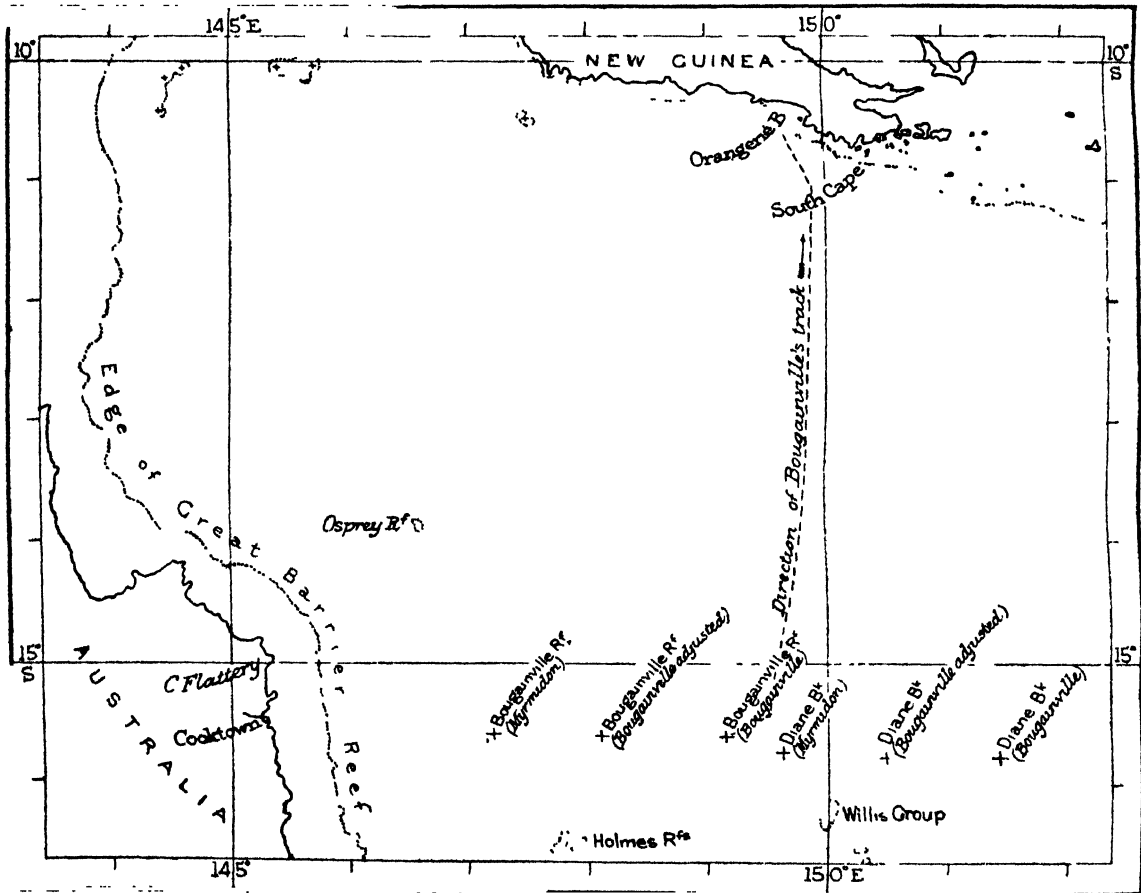

The subject of their existence was much discussed, and on the longitude of Espiritu Santo being revised, it was recognised that M. de Bougainville's discoveries should be also moved to the westward about sixty miles—the amount of error in longitude of Espiritu Santo in his time. The Diane was therefore placed in longitude 150° 28' E., and the reefs in 148° 6'. In this position they were searched for by Capt. Denham in H.M.S. *Herald*, who spent fifteen days in traversing in every direction an area of forty miles radius round each danger, but without success. As a result of this search, seeing that Bougainville's description was so circumstantial that the existence

of the dangers could scarcely be doubted, they were removed back to their original positions on the charts. These positions, though manifestly too near to Espiritu Santo, agreed better with the land-fall made in New Guinea by *La Bouteuse* after leaving the last reef, as it seemed impossible that the bay generally supposed to be the Cul de Sac de l'Orangerie could have been reached on the course steered by M. de Bougainville from any position westward of longitude 149° 8' E., Bougainville's own position of the reef.

Many ships passed in fear and trembling over the long line in which it was thought these dangers might yet

exist, and the records are full of remarks as to their non-existence, especially with regard to the Diane, which lay near the main track to Torres Strait from Sydney. They were, however, retained on the charts, with notations as to the doubt in their positions.

At length, in 1884, two reports were made by small trading-vessels from Queensland to New Guinea, one of a small bank in lat. 15° 41', and long. 149° 43', the other of a submerged reef in lat. 15° 28', long. 147° 6'. It was at once observed that the latitudes of these, and their distance apart, agreed with those of Bougainville's discoveries, though they were far to the westward, and it seemed as if the long-lost reefs were at length again found, since it was not at all improbable that the westerly current had caused the reckoning in longitude, uncorrected by chronometers, to be over-run by *La Boudeuse*. Capt. Denham's searches, minute and painstaking, and apparently sufficiently extended as they had been, just fell short of the positions of these new reports, the limit of his examinations passing within ten miles of both of them.

One link, however, was missing to insure certainty in the identification, viz. the second reef of Bougainville.

During the past year H.M.S. *Myrmidon* has been scouring the Coral Sea, and in the course of her cruise made this one object of search. It was, however, unavailing; clear sea was alone seen in the direction of the second reef. But her description both of sand-bank and reef reported in 1884 tallied precisely with Bougainville's detailed accounts. More accurate observations, moreover, showed that the latitudes were in each case almost exactly identical with his, and that the distances apart, as before stated, agreed.

But what of the reef still missing?

A closer examination of Bougainville's journal revealed that the second reef was sighted from aloft at 5.30 p.m., at an estimated distance of five miles. The sun set at 5.35, behind the reef; twilight is short in those latitudes, and it seems improbable that *La Boudeuse* could have been near enough to see the reef clearly before night closed in. It is therefore believed that the delusive appearance of reflection misled the voyagers, and that Bougainville, so accurate in his other reports, was in this instance mistaken.

A further difficulty remains. How could *La Boudeuse* steering the course reported have made the land 100 miles to windward of her direct track? Here, again, the explanation seems to be that later voyagers re-bestowed the name of Orangerie on that one of the numerous bays on the New Guinea coast which corresponded to Bougainville's longitude. These are assumptions; but the other evidence is so complete that it is believed that the mystery of 120 years is cleared up, and that the dangers which have so long been a source of anxiety to the navigator have at length found their true places on the charts.

The three positions these reefs have occupied are as follows:—

	By Bougainville		Bougainville corrected for the position of Espiritu Santo		By <i>Myrmidon</i>	
	S.	E.	S.	E.	S.	E.
Diane ...	15° 46'	151° 26'	15° 46'	150° 28'	15° 43'	149° 37'
Bougainville Reefs } ...	15° 35'	149° 8'	15° 35'	148° 6'	15° 33'	147° 12'

W. J. L. WHARTON

THE CROCUS¹

MANY splendidly printed and illustrated monographs of special genera of flowering plants have been published, but few surpass in merit or interest Mr. Maw's

¹ "A Monograph of the Genus *Crocus*." By George Maw, F.L.S., &c. With an Appendix on the etymology of the words "*Crocus*" and "*Saffron*," by C. C. Locusta, M.A., M.P., F.L.S. (London: Dulau and Co., 1886.)

monograph of the species of the genus *Crocus*. This work, the author tells us, has pleasantly occupied his spare hours for the last eight years. In collecting the material for it, he has travelled far and wide over the *crocus* region; he has enlisted the services of a whole host of friends, who, on the borders of the Mediterranean, of the great Basin of the Black Sea, and along the shores of the Caspian, have collected the species peculiar to these localities, and forwarded them for culture and description to Mr. Maw. Perhaps never before has a monograph been written so entirely from the study of living plants. At the same time, no information that was to be gleaned from the dried specimens in herbaria has been neglected.

The monograph opens with a chapter on the life-history and physiology of the forms belonging to the genus. As the minute structure of the various parts of the plants has not been made a special study by the author, this portion of the subject leaves a good deal to be done by future workers. The strange phenomenon of dissepiments on the pollen-tube is figured as existing, on the authority of Prof. Martin Duncan. In the chapter on classification and sequence, we find that the author adopts the division of the species indicated by Dean Herbert, into those with, and those without, a basal spathe. These larger divisions are, again, subdivided into sections, characterised by the form assumed by the bundle tissue or the corm tissues, and these, again, into groups arranged according to the period of flowering. The third chapter is a most interesting one, on the geographical distribution of the species. Confined to the Old World, the species of *crocus* are therein only to be met with in the northern hemisphere, where they reach a northern limit at about 50° N. latitude. Westwards, they reach their limit at the coast of Portugal; southwards, the limit extends to Morocco, though no species appear to be endemic to Africa, and none have been found in the region between Tetuan and the Nile Delta. In Asia, on the borders of Syria, *Crocus hyemalis* has the most southern range of all the species. The eastern limit of the species is at present uncertain, for it seems pretty certain that one or more species have been found in Afghan Turkestan. Of the sixty-nine known species, thirty occur in 40° N. latitude, which is far in advance of any other district as a line of growth, but the metropolis of the genus is a district including Greece, the Greek Archipelago, and Asia Minor, for in these regions it forms a more important feature in the flora than in the outlying countries to which it extends. The genus is also remarkable for the wide range in altitude of the majority of the species, those that are essentially alpine or lowland being comparatively few in number; and Mr. Maw does not know of a single species which is not perfectly hardy, that is to say, capable of enduring any of the extremes of cold or heat to be met with in our climate. There do not appear to be distinct areas for the spring and autumn flowering forms, and Mr. Maw has been unable to detect any instances of wild hybrid forms, notwithstanding the close relationship of some of the species, and the fact that their areas of distribution constantly overlap.

In a fourth chapter the history and literature of the genus are treated of. Two centuries before the days of Linnæus the *crocus* was known in England as a garden plant, and in Gerarde's "*Herball*" (1597) eleven forms are figured and described. Most of the famous pre-Linnaean writers on plants have added to our knowledge of the species, such as Parkinson in his "*Paradisus*" (1629), and Ewart in his "*Florilegium*" (1612); but Linnæus contented himself with making but two species, one *C. vernus*, and the other *C. (Bulbocodium) bulbocodium*. The first important attempt to classify the genus was made by A. H. Haworth in 1809, followed by Goldbach's monograph in 1817, Gay's in 1827, and Sabine's in 1830. Dean Herbert in 1847 and Baker in 1873 added much to our scientific knowledge of the group, and now in this beautiful monograph

we have the history of the genus, written in a manner that, except for the anatomical student, will not for very long indeed be surpassed.

Hints on cultivation and on species not yet introduced to cultivation, and remarks on saffron, its cultivation and uses, form Chapters V. and VI. Saffron would appear to have been cultivated in England prior to 1582, and from its importance as an article of commerce gave its name to Saffron Walden. It is very strange that after having been grown as an economic plant in England for three or four centuries its production has died out, and that it is an extremely difficult thing to get the saffron crocus to flower in this country. The author says that saffron was used as a royal dye in the olden time in Ireland, but this is a very doubtful statement.

Into the descriptive portion of this work it is needless that we should enter in detail. All the species and their chief varieties are most carefully described, full synonymic lists are given, and ample details as to the geographical distribution of each and its period of flowering. The description of each species is accompanied by a plate illustrating the corm, flower, leaves, fruit, and structural details; and, as if to add to the attractiveness of this splendid volume, there is a series of very exquisite woodcuts, introduced as head-pieces, of some of the more remarkable districts where the rarer species are found. Some of these are from original sketches, by Mr. Danford, of the remote mountain region of the Taurus and of other parts of Asia Minor, where, with Mrs. Danford, journeys were made in quest of crocuses. The volume is dedicated to Mr. and Mrs. Danford.

The appendix, by Mr. Lacaita, on the etymology of the words crocus and saffron, is of great interest, and tells of the almost world-wide use of the terms.

NOTES

LAST week, Sir William Armstrong paid to the bankers of the Royal Society a cheque for 7800*l.* for the Scientific Relief Fund.

THE Council of the Geological Society have awarded the medals to be given at the anniversary meeting of the Society on February 18, as follows:—The Wollaston Gold Medal to Mr. J. W. Hulke, F.R.S., the Murchison Medal to the Rev. P. B. Brodie, the Lyell Medal to Mr. S. Allport, and the Bigsby Gold Medal to Prof. C. Lapworth. The balances of the Funds at the disposal of the Society are awarded as follows:—The Wollaston Fund to Mr. B. N. Peach, the Murchison Fund to Mr. R. Kidston, and the Lyell Fund to the Rev. Osmond Fisher. We believe that the President's address at the anniversary meeting will deal mainly with the relations between geology and the mineralogical sciences.

THE Geographical Society of Australasia has been authorised by the Queen to prefix the word "Royal" to its title.

THE recent death of General Hazen, the chief of the Army Signal Service in the United States, which is responsible for the meteorology of that country, has raised the question whether or not meteorology should be dealt with by a civil rather than a military bureau. It will be remembered that when the present meteorological system was established in the United States it was connected with the Signal Service, in order to utilise the time of the officers and men during peace. There is no doubt that the work done by the American Signal Service has been done with a thoroughness and vigour which have not been equalled elsewhere; and the eminent men of science who have been associated with the Chief Signal Officer have taken care that the mere forwarding of weather information should not be the whole of their duties. A Committee of the National Academy of Science has already been appointed to consider the matter, and

has recommended separation of the work from the War Office. Whatever decision is arrived at, it is to be hoped that the service in its new form (if it is to have one) may not be less efficient than it has been in the past. This question is of course part of the general question now being seriously discussed in the United States, as to whether a purely scientific service should be controlled and directed by scientific men. In the abstract there can be of course but one answer to this question, but it must at the same time be pointed out that to make a man of science responsible for large administrative and executive work is to destroy him utterly as a man of science. This is a good reason for having some one other than a man of science for the carrying out of such work. It is, however, no argument for placing the man of science in a subordinate position to any mere administrator, and it would perhaps be best to intrust such inquiries on a very large scale to a small Committee, one of whom should be the man responsible for the science and the other the man responsible for the administration.

VERY enlightened ideas prevail among the influential classes of India with regard to the manner in which the Queen's Jubilee should be celebrated. On the motion of Dr. Hunter, the Vice-Chancellor of Calcutta University, the Jubilee Committee at Calcutta decided some days ago that the fund which is to be raised in India for a permanent memorial, shall be devoted partly to the Imperial Institute in London, partly to a scheme for the placing of technical education in India on a sound and lasting basis. It is said that the provincial cities are resolved not to be outstripped by the capital. The people of Patna propose to found an industrial school, and the Calcutta Correspondent of the *Times* says their example is likely to be followed in many places. The native princes have also begun to see the importance of technical education, and the Maharajah of Mysore has determined not only to contribute largely to the Imperial Institute in London, but to form an Institute of a similar kind in his own dominions. All this promises well for the material progress of our great dependency, and it should tend to strengthen the movement among ourselves for the establishment of closer relations between science and industry.

NEARLY four years ago we were able to announce that a vote had been passed at Oxford authorising the Curators of the University Chest to spend a sum of 7500*l.* in building an annex to the east side of the University Museum, to contain the splendid anthropological collection which General Pitt-Rivers had most munificently offered to the University, and in providing the requisite cases and fittings. The collection has now been partially arranged in the hall built for it, and is thrown open to visitors. It has been enriched by objects transferred from other University Museums, such as the Ashmolean, and by numerous donations from other sources. The opening of the collection ought to mark an epoch in the history of anthropological study at Oxford. Its importance arises less from the value of the objects (although that, of course, is very great) than from the manner in which they are grouped. The arrangement brings out with astonishing clearness the working of the law of evolution in the development of all kinds of implements and weapons.

It is proposed that a Medical School shall be formed in connection with University College, Dundee. There can be little doubt that the scheme will be successful, for not only has Dundee an important hospital, but medical students at the new school would have the advantage of being able to take the degrees of the University of St. Andrews. Some time ago Mr. T. H. Cox offered 12,000*l.* as an endowment for a Chair of Anatomy, and now the sons and daughters of the late Mr. J. F. White, of Balruddery, have given 6000*l.* to found a Lectureship or Chair to be associated with their father's name.

ABOUT 2000 delegates, including about 300 from Europe, are expected to be present at the ninth triennial meeting of the International Medical Congress at Washington in September next. An effort is being made to secure the hall of the House of Representatives for the opening meeting. After this meeting the Congress will be divided into seventeen sections, assembling in the different halls of the city.

MR. G. T. RYVES, F.R.Met.Soc., wrote the other day to the *Times*, from Stoke-on-Trent, presenting the results of an independent comparison of the daily forecast issued by the Meteorological Office for the Midland District with the actual weather experienced in 1886. The number of forecasts sent out by the Office during the year was 310. Of these, 309 were tested, and Mr. Ryves found that there were 247 absolute successes, 26 absolute failures, and 36 partial or doubtful successes. That is to say, omitting small fractions, there were 80 per cent. of successes, $8\frac{1}{2}$ per cent. of failures, and $11\frac{1}{2}$ per cent. of doubtful cases. Mr. Ryves understands that a similar result has been arrived at in other places where the forecasts have been submitted to an examination extending over a period of sufficient length to make it possible to strike a fair average.

THE French Minister for Public Instruction has nominated a Commission, under the presidency of M. Bertrand, the Secretary of the Académie des Sciences, which will award a prize of 50,000 francs (2000*l.*) to the inventor of a cheap method for the application of electricity to the purposes either of heating and lighting, chemical or mechanical force, telegraphy, or the treatment of the sick.

THE Royal Scientific Society of Göttingen offers a prize of 500 marks (25*l.*), in 1889, for a complete review of the literature of the Arabs and the Arabian-speaking tribes of the Islam and Christian kingdoms up to the time of the conquest of Egypt by Turkey. Further particulars can be obtained of the Society.

MR. MACLEAN, the official assistant to the Professor of Natural Philosophy in the University of Glasgow, has just published a little book containing examples of exercises given in the natural philosophy class during recent years, with indications how to answer them. The exercises deal largely with dynamics and properties of matter, and include sound, light, magnetism, electricity, and heat. The exercises, especially those on dynamics, are very interesting, and indicate distinctly the thoroughness of the instruction given. Several of the hints for solution will be found also of great value to students.

WE have frequently had to refer to the scientific *renaissance* now going on in Italy. Another indication of this has just reached us, in the shape of a volume of some 500 pages, on "Geological Evolution: Inorganic, Animal, and Human," by Signor Enrico del Pozzo di Mombello. The book is published by Sgariglia, of Foligno. It exhibits a wide philosophical grasp of the subject. The first chapter is almost confined to an analysis of Herbert Spencer's "Principles of Evolution." The writer then discusses the nebular hypothesis, and the new views as to the inorganic evolution now going on in the sun. Geological climates, with full references to the works of Lyell and Croll, follow; and after a chapter on vulcanism are chapters on practical geology. The rest of the work deals with life, including a full statement of Darwinism and human evolution, while the last chapters are devoted to prehistoric man. Such a book as this will be of the greatest service to science in Italy.

WE have received the fifth edition of "Celestial Motions," a handy book of astronomy, by Mr. W. T. Lynn, formerly of the Royal Observatory, Greenwich. In this last edition a chapter has been added on the refraction, propagation, and aberration of light. The treatment, however, is necessarily so limited, that the chapter is practically useless for educational purposes.

WE have received also the fifth edition of Prof. Bentley's "Manual of Botany." The physiological part of the subject has been largely revised, with the assistance of Mr. J. D. Groves, Demonstrator of Practical Biology at King's College, London. Many alterations have been made in the part treating of the properties and uses of plants; but the most marked change is in those chapters relating to the classification of plants. The book is now adapted in all essentials to the arrangement adopted in the "Genera Plantarum."

A STRONG shock of earthquake was felt in Venice on the night of January 24. No damage seems to have been done. At Aquila, in Lower Italy, seven shocks of earthquake were noticed on January 26, three of which were rather strong. They occurred between 2.30 p.m. and 7.45 a.m. of the next day.

ON the night of January 31 a shock of earthquake was felt in Zurich and the neighbourhood, and in the cantons of Zug and Schwyz. The district affected was about 80 kilometres in diameter.

UNDER the auspices of the Geological and Natural History Survey of Canada, Prof. J. Macoun, of Ottawa, has now completed the first volume of his "Catalogue of Canadian Plants." The third part, just published, comprises the *Apetalæ*, *Conifera*, and a long list of additions and corrections to parts 1 and 2, carrying the work down to the end of *Exogens*.

A CONSIGNMENT of German carp has been forwarded to Portugal by the National Fish-Culture Association, for the purpose of acclimatisation in the waters of that country. The experiment is being made by Messrs Broughton and Frietas, who have also made arrangements to import a quantity of salmon and trout ova, and hatch them out for a similar purpose. The National Fish-Culture Association have intimated their intention of supplying *Salmonidæ* fry this year gratuitously to public bodies desirous of repopulating depleted waters. One million and a half of whitefish ova (*Coregonus albus*) arrived from the American Government at the hatchery of the Association on January 31.

THE National Fish-Culture Association have just issued the first number of their quarterly Journal, edited by Mr. J. W. Willis-Bund. The objects of this publication are not only to chronicle the operations of the Association, but to collect information concerning the fish, fish culture, and fisheries both of the United Kingdom and abroad. The present number includes articles by Dr. Francis Day, Mr. J. W. Willis-Bund, Mr. W. Oldham Chambers, and Mr. Anderson Smith.

HERR RICHARD ANDREE, of Leipzig, who has for some years past made a special study of cannibalism and its prevalence in ancient and modern times, has recently published (Beit: Leipzig) a pamphlet on the subject, which is full of interest to others besides the ethnologists for whom it is, of course, mainly intended. He treats first of the practice of anthropophagy in prehistoric times, discussing traces of it in popular tales, legends, and superstitions. To this section also belong the investigations into the remains found in caves and ancient burial-places in Europe, which Herr Andree thinks prove beyond doubt that cannibalism existed at this remote epoch in countries which are now the most highly civilised on the globe. The next part deals with the geographical distribution of the practice at the present day. The mass of information brought together is drawn from the literature of many countries, ancient and modern, and is enormous in amount. The writer attributes the origin of cannibalism to hunger and want in the first instance, until it developed into a settled practice, from which the step to human sacrifice, whether of single individuals, such as prisoners, or of holocausts of victims, as in ancient Mexico, is not a long one.

THE death is announced of Dr. Philip Fischer, the well-known mathematician and Professor at the Polytechnic Institution at Darmstadt. He died on January 22.

IN a recent issue, *Science* comments on the fact that the number of lectures delivered by professors at Oxford and Cambridge falls considerably below that which it is usual for a professor to give in the United States. *Science* is by no means of opinion that the American plan is best. American professors are, it says, compelled to teach and lecture so much that few of them have an opportunity of doing justice to their abilities as investigators and writers. Our American contemporary counsels governing Boards in the United States to take this fact into serious consideration. "They value a professor according to the number of lectures he delivers and the number of students he attracts. They fail to perceive that scientific research is the peculiar duty, and should be the peculiar privilege, of the University professor. Oxford and Cambridge professors do more original work than our professors, simply because they are given the time for it."

CAPT. DUTTON, of the U.S. Geological Survey, is making rapid progress with the preparations for his Report on the Charleston earthquake. With regard to the velocity of the propagation of the earth-wave, the final computations have not yet been made, but the evidence is said to indicate with certainty a velocity somewhat in excess of three miles per second.

WE have received the new number of the *Annuaire* of the Royal Observatory of Brussels, by M. Folie, Director of the Observatory. This periodical has appeared every year without interruption since 1834. The present number, like its predecessors, contains much useful astronomical information. The section on physical units and constants has been enlarged, and here are valuable notes on the geography and statistics of Belgium.

MESSERS. RIVINGTON will shortly have ready a "Text-book on Animal Biology," by Prof. C. Lloyd Morgan, of University College, Bristol. The first part of the volume deals with the anatomy and physiology of vertebrates, as exemplified by the frog, the pigeon and fowl, and the rabbit. In this part there are special chapters on histology, embryology, the genesis of tissues and organs, and animal metabolism. The second part is occupied with the structure and life-history of some invertebrate types, viz. the crayfish, cockroach, earthworm, liver-fluke and tapeworm, snail, freshwater mussel, hydra, vorticella, and amoeba. Numerous outline woodcuts have been drawn specially for this work. It aims at satisfying the requirements of those who are preparing for the immediate science and preliminary scientific examinations of the London University, and for the Oxford and Cambridge Local Examinations.

IN a report on the working of his department during the past six years, which has just been laid before Parliament (C-4943), the Controller of the Stationery Office refers to the publication of the Report of the scientific results of the exploring voyage of the *Challenger*. This was much delayed, Mr. Pigott observes, by his long illness and death of Sir Wyville Thomson in 1882, but it now approaches completion. The original estimate of the bulk of the work has already been very largely exceeded, "owing," writes Mr. Murray, the present editor, "to the enormous wealth of the observations and collections made during the expedition not having been at first realised." Twenty-seven quarto volumes, illustrated by about 2000 full-sized lithographic plates (many of them exquisitely finished in colours), by some eighty charts and diagrams, and by many hundred photographs and woodcuts, either already have been, or in the course of a few weeks will be, published. The editor (continues Mr. Pigott) estimates that another seven volumes at least will be required to complete the work, but hopes that with perhaps the exception of the last, in which it is intended to show the bearing of facts stated in the previous volumes on theories hitherto accepted, all

will be before the public before the end of the coming financial year (March 31, 1888). The Controller thinks that perhaps it is fortunate for science that the Lords of the Treasury, when considering whether the publication of the results of the voyage should be undertaken at the public expense, were necessarily imperfectly informed of the cost. The amount paid from Stationery Office votes alone has already reached nearly 25,000*l.*, of which about 12,000*l.* only has been recovered by sales. To the balance of this account in calculating the actual cost of the book must be added the sums granted annually by Parliament for the expenses of the commission since the return of the ship—something over 40,000*l.*, making the net cost of the publication up to the present time, roughly, 53,000*l.*—a larger sum perhaps than has ever been spent by any Government on a single work. On the other side, however, Mr. Controller Pigott is good enough to add that the value of the Report can scarcely be exaggerated, and in a few lines he gives his estimate of the work of the expedition.

LIEUTENANT W. H. EMORY, of the U.S. Navy, who commanded the *Bear* in the Greely Relief Expedition, has been ordered to the *Thetis*, and will shortly sail for Alaska. He is to investigate the seal-fisheries, and has received special instructions regarding the boundary-line between Alaska and British territory.

THERE seems to be some need for a scientific examination of medals granted in America for distinguished services. The "fine, large, gold medal," given to General Grant for the part he played in the Mexican war, is now in the National Museum, Washington, and, according to *Science*, it is "bugus," having a specific gravity of only 7 instead of 16.

IN a recent Report, Mr. J. R. Dodge, Statistician of the U.S. Agricultural Department, shows that the amount of beetroot-sugar produced last season exceeded the cane-sugar by 162,000 metric tons. The manufacture of beet-sugar is wholly a European industry, and Mr. Dodge says its success in Europe is largely due to the fact that each shareholder in the stock of a beet-sugar factory is required to furnish so many beets per share. The farmers are in reality the manufacturers, and, since they obtain the profits of the manufacture, it is their interest to raise good beets at a nominal price. Mr. Dodge states that the sugar consumed in the United States amounts to about one-fourth of all the sugar reported from the places of principal production, and that within twenty-five years the country will require as much as the whole of the present supply of the cane-sugar of commerce, and nearly as much as the present production of beet-sugar. Mr. Dodge expresses surprise that Americans "scour the world for food-products costing more than 200,000,000 dollars per annum, the larger portion of which should be produced in the United States." What is needed, he thinks, is "a more skilful, scientific, and inventive agriculture."

THE introduction of the electric light is not always, apparently, an unmixed benefit. Some time ago electric lights were placed in front of the Treasury and other public buildings in Washington, and a fine and striking effect is said to have been produced. Unfortunately, however, spiders discovered that game is plentiful in the vicinity of the new lights, and that they may there ply their craft successfully both day and night. In consequence, as Mr. G. Thompson writes to *Science*, their webs are so thick and numerous that portions of the architectural ornamentation are no longer visible, and when the webs are torn down by the wind, or fall from decay, the refuse gives a dingy and dirty appearance to everything it comes in contact with.

WE notice in one of the morning papers that considerable progress is being made at the great Lambeth factory of Messrs. Maudslay, Sons, and Field, with the large compound engines which are being prepared for the new Italian armour-clad *Il Re Umberto*. According to the contract, these engines are to be of 19,500 horse-power, which is about 7500 horse-power more than that of any vessel yet designed for the British Navy. It is stated that they will actually indicate 21,000 horse-power, or 9000 more than any vessel in the British Navy. These engines, completely made of steel, are expected to drive the *Il Re Umberto*, fully equipped, about 20 knots per hour.

MR. C. C. LACAITA is taking charge of the Sanitary Registration of Buildings Bill in the House of Commons. The Bill introduced in 1886 consisted of ten sections, and, it will be remembered, made the sanitary registration of all buildings compulsory in towns of 50,000 inhabitants and upwards. The new Bill consists of seventeen sections, and is to apply to all towns or districts of 2000 inhabitants, but it is only to be compulsory in the case of schools, colleges, hospitals, asylums, hotels, and lodging-houses. An important feature of the new Bill is that the local authorities will have to keep a Sanitary Register, in which any building certified in accordance with the proposed Act may be registered, so that a stranger visiting any district would be able to ascertain at the office of the local authority whether any particular house was or was not certified as in a satisfactory sanitary condition. The new Bill will, no doubt, be more acceptable to sanitary experts, seeing that all persons entitled to certify must first obtain a license from the Local Government Board, and provision is made for the appointment of examining Boards. Persons entitled to sign certificates are designated Licentiate in Sanitary Practice.

THE town of Baku was recently threatened with destruction by the sudden outburst of a natural naphtha fountain. This was soon followed by a volcanic eruption from Lok Botan, close to the Ponta railway station, and about ten miles from Baku. The eruption began on the night of January 15, when the inhabitants of Baku were alarmed by a shock like that of an explosion, which made all their window-panes tremble violently, while towards the south-west the sky was illuminated by an intense light, as of some terrific conflagration. The following information, furnished by the railway officials of the Ponta station, appeared in a telegram from the St. Petersburg Correspondent of the *Times* on Monday last:—"Quite suddenly, at eleven o'clock at night, the noise of an explosion was heard, and the summit of Lok Botan shot up an enormous column of fire some 350 feet high. The whole country was instantly lit up brighter than day, and the heat could be felt at nearly a mile from the crater. There was scarcely any wind, so that the column continued to ascend quite vertically, carrying with it, as could be seen, large dark substances which appeared to fall again into the volcano. This lasted with short intervals of subsidence all through the night and the following twenty-four hours, but luckily the matters ejected did not reach the railway station." The *Times* Correspondent says that the volume of muddy liquid thrown out is estimated at half a million cubic *sojens*—the Russian *sojens* equalling 7 feet—and has spread itself over more than a square mile to a depth of from 7 to 14 feet.

ON the night of January 26 a brilliant meteor was observed at Holmestrand, on the south-east coast of Norway. It went from south-west to north-east, at a rapid pace, and disappeared below the horizon. The light was an intense white, illuminating for a few seconds the whole town as in broad daylight.

A STATUE is to be erected at Christiania in honour of the celebrated mathematician Abel, subscriptions being raised towards it from all parts of Europe.

THE Council of the Royal Meteorological Society have arranged to hold, at 25 Great George Street, S.W. (by permission of the Council of the Institution of Civil Engineers), on March 15 to 18 next, an Exhibition of Marine Meteorological Instruments and Apparatus. The Exhibition Committee are anxious to obtain as large a collection as possible of such instruments; and they will be glad to show any *new* meteorological instruments or apparatus invented or first constructed since last March, as well as photographs and drawings possessing meteorological interest.

MR. JOHN MURRAY, of the *Challenger* Expedition Office, Edinburgh, writes to us that the passage placed within inverted commas in one of our Notes on Jan. 27 was not a quotation from his address to the Royal Society of Edinburgh. We may explain that the passage was quoted from what professes to be "a condensed report of the address" in the January number of the *Scottish Geographical Magazine*. In this "condensed report" Mr. Murray is represented as having said that "money grants of considerable annual value are devoted to the maintenance of learned Societies in London and Dublin." Our only object was to point out that so far as London is concerned this statement is misleading.

THE additions to the Zoological Society's Gardens during the past week include a Black-winged Peafowl (*Pavo nigripennis* ♀) from Cochin China, presented by Mr. John Marshall; a Cayenne Lapwing (*Vanellus cayennensis*) from South America, purchased; six Long-fronted Gerbilles (*Gerbillus longifrons*), born in the Gardens.

OUR ASTRONOMICAL COLUMN

COMET BROOKS (1887 *b*).—This object was observed at Paris on January 27 as a circular nebulosity of about 1'5 in diameter, with a small but fairly bright nucleus, almost stellar in appearance, and situated not quite in the centre of the coma. The comet was estimated as of the 12th magnitude.

Dr. Rud. Spitaler, Vienna Observatory, has computed the following elements and ephemeris:—

T = 1887 March 23 01985 Berlin M.T.

$$\begin{matrix} & 80 & 26 & 17 \\ = & 283 & 0 & 15 \\ & 102 & 25 & 29 \end{matrix} \left. \begin{matrix} \\ \\ \end{matrix} \right\} \text{Mean Eq. 1887}^\circ$$

log q = 0.19021

Error of middle place ($O - C$).

$d\lambda \cos \beta = + 9''$, $d\beta = - 5''$

Ephemeris for Berlin Midnight

1887	h.	m.	s.	R.A.	Decl.	log Δ	log r	Brightness	
Feb. 12	1	59	34	+ 73	5'6	0.07734	0.21040	1.39	
	16	2	35	23	68	19'5	0.08193	0.20660	1.39
	20	2	59	23	63	27.4	0.09016	0.20314	1.36
	24	3	16	58	58	41'5	0.10154	0.20007	1.31
	28	3	30	42	+ 54	9'1	0.11553	0.19744	1.25

The brightness on January 25 is taken as unity.

COMET BARNARD (1887 *c*).—Barnard's comet was observed at Paris on January 26, and seemed to be of much the same brightness and dimensions as Brooks's comet appeared on the following night, but it differed somewhat as to its nucleus, there being a central condensation forming a diffused nucleus about 4" or 5" in diameter. The comet is steadily diminishing in brightness. The following elements and ephemeris are by Prof. E. Weiss:—

T = 1886 November 23.6302 Berlin M.T.

$$\begin{matrix} \pi = 284 & 27 & 58 \\ \Omega = 257 & 14 & 17 \\ i = 85 & 22 & 5 \end{matrix} \left. \begin{matrix} \\ \\ \end{matrix} \right\} \text{Mean Eq. 1887}^\circ$$

log q = 0.15454

Error of middle places ($O - C$).

$\Delta\lambda \cos \beta + 4'' - 3''$, $\Delta\beta - 1'' - 9''$.

Ephemeris for Berlin Midnight

1887	R.A.	Decl.	log Δ	log r	Bright- ness
	h m s	° ' "			
Feb. 12	20 4 1	+ 37 25' 2"	0'33827	0'26127	0.83
16	20 16 44	39 50' 3"	0'34157	0'26929	
20	20 29 54	42 12' 3"	0'34566	0'27733	0.74
24	20 43 32	44 30' 2"	0'35051	0'28538	
28	20 57 38	+ 46 43' 4"	0'35638	0'29341	0.66

The brightness on January 24 is taken as unity.

THE ROUSDON OBSERVATORY.—We have received Mr. Peek's report on the astronomical work done at the Rousdon Observatory, Lyme Regis, in 1886. During the year, 146 nights were available for observation, the most cloudy month having been February, and the clearest December. Selected lists of long-period variable stars are under systematic observation with the 6.4-inch equatorial. The following comets have also been observed: 1885 *d* and *e*, 1886 *a*, *b*, *c*, *e*, and *f*. The great nebula in Andromeda is under regular observation. We would suggest to Mr. Peek the propriety of publishing the observations of cometary positions at as early a date as is possible; their value is much increased by speedy publication.

MINOR PLANET No. 264.—This asteroid has been named *Libussa* by Prof. Peters, of Clinton, U.S.A., the discoverer.

ASTRONOMICAL PHENOMENA FOR THE WEEK 1887 FEBRUARY 13-19

FOR the reckoning of time the civil day, commencing at Greenwich mean midnight, counting the hours on to 24, is here employed.)

At Greenwich on February 13

Sun rises, 7h. 20m.; souths, 12h. 14m. 25.5s.; sets, 17h. 8m.; decl. on meridian, 13° 21' S.; Sidereal Time at Sunset, 2h. 42m.

Moon (at Last Quarter February 15) rises, 22h. 48m.*; souths, 4h. 27m.; sets, 9h. 55m.; decl. on meridian, 7° 5' S

Planet	Rises		Souths		Sets		Decl. on meridian
	h. m.	h. m.	h. m.	h. m.	h. m.	h. m.	
Mercury	7 43	12 38	17 33	13 7 S.			
Venus	8 1	13 22	18 43	8 28 S.			
Mars	7 56	13 16	18 30	8 33 S.			
Jupiter	23 43*	4 44	9 45	12 11 S.			
Saturn	13 29	21 37	5 45*	22 19 N.			

* Indicates that the rising is that of the preceding evening and the setting that of the following morning.

Occultations of Stars by the Moon (visible at Greenwich)

eb.	Star	Mag.	Disap.	Reap.	Corresponding angles from vertex to right for inverted image
	h.		h. m.	h. m.	
3 ...	94 Virginis	6	5 26	6 22	38° 30'
4 ...	ξ' Libræ	6	1 4	2 6	52 20'
13 ...	12		Jupiter in conjunction with and 3° 43' south of the Moon.		

Variable Stars

Star	R.A.		Decl.		h m
	h. m.	h. m.	° ' "	° ' "	
Cephei	0 52' 3"	81 16 N.	Feb. 15,	20 58 m	
Piscium	1 11' 7"	8 20 N.	" 18,	M	
Arietis	2 9' 7"	24 32 N.	" 15,	M	
Argol	3 0' 8"	40 31 N.	" 13,	18 50 m	
Geminorum	6 57' 4"	20 44 N.	" 13,	4 0 M	
Boötis	14 32' 2"	27 14 N.	" 17,	M	
Libræ	14 54' 9"	8 4 S.	" 17,	0 57 m	
Coronæ	15 13' 6"	32 4 N.	" 14,	1 37 m	
Coronæ	15 45' 5"	39 55 N.	" 14,	M	
Ophiuchi	17 10' 8"	1 20 N.	" 15,	2 41 m	
and at intervals of 20 8					
Herculis	18 4' 8"	31 0 N.	Feb. 18,	M	
Lyræ	18 45' 9"	33 14 N.	" 20,	22 0 M	
Lyræ	18 51' 9"	43 48 N.	" 13,	m	
Cephei	22 25' 0"	57 50 N.	" 13,	4 0 m	
Cassiopeiæ	23 52' 7"	50 46 N.	" 15,	M	

Meteor-Showers

On February 17, a radiant near ν Herculis, R.A. 238°, Decl. 48° N. On February 20, from Coma Berenices, R.A. 180°, Decl. 35° N.; and another from near ρ Herculis, R.A. 263°, Decl. 36° N. Other radiants of the week:—Near λ Draconis, R.A. 165°, Decl. 73° N., and near β Ophiuchi, R.A. 260°, Decl. 0°.

GEOGRAPHICAL NOTES

IN a private letter from Mr. H. M. Stanley, published yesterday, he says that when he reached Cairo he found that all the political authorities and experts there were opposed to the idea of his taking the Congo route. They thought that as the Expedition was to be armed with several hundred Remingtons and a machine-gun of the latest invention it was to be an offensive force, conducted after strict military rules, and that Mr. Stanley would therefore meet with no insuperable difficulties either by the Karagwé or by the Masai route. On this point he undeceived them, and he also showed that if serious fighting were necessary his men would be wholly unable to meet great masses of native warriors. Besides, the probable result of a struggle with Uganda would be that Mr. Mackay, the missionary, and the French Bishop and Père, now in Mwangá's power, would be murdered. The total length of each land journey is given by Mr. Stanley as follows:—Congo route: Mataddi to Stanley Pool, 235 English miles; Stanley Falls to Lake Albert, 360 English miles—total 595 English miles. Karagwé route: Zanzibar to Lake Albert, 950 English miles. Masai route: *via* Taveta, Kenia, and Turkan, 925 English miles. Mr. Stanley also calculates the length of the various routes by days, assuming that only an average of six miles could be made daily. Congo route: land journeys, 99 days; Zanzibar to Congo, by steamer, 20 days; Lower Congo, by steamer, 3 days; Upper Congo, by steamer, 35 days. Total, 157 days. Karagwé route: land journey, 156 days. Masai route: land journey, 154 days.

THE most important contribution to the new number of the *Bulletin* of the Paris Geographical Society is the series of maps of the River Ogové in West Africa, by Lieut. Mizon. These maps, which are on the scale of about 1 kilometre to an inch, and refer to the whole course of the river as surveyed by Lieut. Mizon, are executed with much care. In the brief text which accompanies the maps, the author describes his method of observation, and gives the positions of some of the more important points. M Jaunkowski contributes an article on Fernando Po, in which he gives some welcome information on the curious people known as Bubis, who inhabit the mountainous districts of the island. Other papers in this number are on the "Ksour" of Bouda (West Sahara), by M. Chatelier; two papers on Tonquin, by Lieut. Gouin; and a paper on the expedition of General de Bussy in the Deccan in the eighteenth century.

IN the Bulletin of the American Geographical Society, No. 2, 1886, Commander H. C. Taylor, U.S.N., describes the various projects which from time to time have been advanced for the construction of a canal across Nicaragua, and attempts to show that this is the most favourable route for a canal between the Atlantic and Pacific. Dr. G. E. Ellis gives an interesting *résumé* of the history of the Hudson's Bay Company, 1670-1870.

LAKE TAHOE, long regarded as the deepest fresh-water lake in the United States, must now take the second place. Capt. C. E. Dutton, of the U.S. Geological Survey, made, in July 1886, a series of soundings at Crater Lake, Oregon, with unexpected results. The mountain wall that surrounds the lake is 900 feet high; the average depth is 1500 feet, and the maximum 1996.

TO the January number of *Petermann's Mittheilungen*, Dr. Theobald Fischer contributes the first part of a study of the coasts of North Africa, in which he attempts to account with precision, on geological and meteorological bases, as well as by the action of the sea, for the various features of the North African coast. The present instalment deals mainly with the Algerian and Tunisian coast, and the investigation forms part of a detailed study which Dr. Fischer is making of the whole Mediterranean coasts. The paper is accompanied by maps, while another map illustrates the distribution of languages in Germany and Austria, the accompanying text being by Prof. F. Held. Dr. Possowitz contributes a paper on the laterite

THE new number of *Appalachia* contains, among other things, a series of useful data, by Prof. E. C. Pickering, on "The Heights of the White Mountains," and a valuable paper by Prof. W. Morris Davis, on "Mountain Meteorology."

It may interest both geographers and ethnologists to know that in the current numbers of *Les Missions Catholiques* the Rev. Jules Brunetti describes his recent journey up the River Maroni, in French Guiana, giving many details concerning the Negro population which is settled on its banks.

THE Austro-Hungarian Expedition for the investigation of Central Africa, which was organised last year by Count Samuel Teleki, and reached Zanzibar last June, has left for the interior.

A GERMAN Expedition to Brazil sailed from Bremerhafen on January 25. The gentlemen are: Dr. Karl von den Steinen and his cousin Wilhelm, Dr. P. Vogel (Uelfeldt), and Dr. Ehrenreich (Berlin). Both Dr. K. von den Steinen and Dr. Vogel took part in the German Polar Expedition to South Georgia, and the former gentleman and Dr. Clauss were with the celebrated Expedition for the investigation of the Xingu River in Central Brazil, while Dr. Ehrenreich was on a journey in the Amazon district.

THE new number of the *Mittheilungen* of the Vienna Geographical Society contains Dr. Lenz's map of the Congo between Stanley Falls and Kasonge, to the journey up which we referred in a recent number of NATURE. The map gives much information as to the character of the country along the banks of the river, and the people who inhabit them. As it is only six months since Dr. Lenz arrived at Kasonge, one cannot but remark the rapidity with which the journey between the coast and the centre of Africa can now be made. As a matter of fact, the London Missionary Society has a monthly mail between Zanzibar and Lake Tanganyika, and letters from their missionaries on the west shore of that lake reach London in three months.

THE same number contains the conclusion of Herr Baumann's very valuable description of the country and people on the Middle and Lower Congo; a paper on the high lakes of the Eastern Alps, by Dr. August Böhm; and a collection of recent statistics on the population of Bosnia and Herzegovina.

HERR P. LANGHAUS has been endeavouring to form an estimate of the native population in the Cameroons territory recently acquired by Germany. He confines himself to the coast region between the Rio del Rey and the Rio Campo, and gives 480,500 as the population on 26,000 square kilometres, or only 18 per square-kilometre. The people mostly belong to the north-west branch of the Bantu stock, and Herr Langhaus gives some useful details as to their distribution and subdivision in the *Deutsche Rundschau* for January.

A NEW exploration of the districts on the Upper Meikong, inhabited by the Laos tribes subject to Siam, has attracted considerable attention in Paris. Towards the end of 1885, the Siamese Government found it necessary to undertake an expedition against these tribes (the principal of them being the Ho). An Italian officer, Capt. Pinson, who was a military instructor in the Siamese service, accompanied the expedition, which ultimately arrived at Muen-Son, fourteen days' march to the north-east of Luang-Prabang, in the centre of a region wholly unknown to Europeans, for these Hoes had prevented Dr. Neis from completing his famous exploration of the whole of the Laos States. The expedition, owing to frontier complications with Tonquin, was not a success, and now M. Pinson has determined to explore the country for himself, partly with the object of discovering commercial routes along the Meikong into Yunnan and into Tonquin, both starting from Luang-Prabang, and also for geographical purposes. He has arrived in Paris to lay the project before the President of the Council and the various mercantile bodies. To the former he has presented a memorial asking to be despatched on the mission by the French Government. In this document he describes briefly the divisions of the Siamese Laos, the nature of the soil, the commercial situation of Great Britain in Burmah in regard to the Laos States, the alternative trade routes for Upper Laos—which he describes as by the Meinam to Bangkok (which appears the natural route), by the Ho country into Tonquin, or by the Meikong—and other details. He expresses the determination to return without delay to Luang-Prabang, and, if aided by the French Government, (1) to penetrate into Yun-

nan in order to study the peoples on the route and their commercial wants, and (2) to explore and study in like manner the two routes from the same town into Tonquin and Annam. The projected exploration, it will be observed, is mainly through unknown territory, Dr. Neis not having been able to penetrate a large part of this region.

IN the last number of *La Gazette Géographique* M. Kaltbrunner publishes an interesting article entitled "L'Indicateur Géographique." He first gives statistics of the various Societies for geography and the allied sciences in the world. According to continents, the number of these is as follows:—Europe 91, Africa 5, America 9, Asia 9, Australia 2, giving a total of 115. France heads the list with 28, then comes Germany with 23, then Italy with 8, Switzerland with 7, Austria with 6, and Great Britain with 4. The total number of periodicals treating of geography as a principal or accessory subject is 263, of which 214 are published in Europe, 14 in Africa, 19 in America, 15 in Asia, and 1 in Australia. France again heads the list with 79, Germany has 42, Great Britain 18, Italy 13, Austria and the United States 11 each. Many other interesting details respecting membership, amount of subscriptions, of Government assistance, &c., are given. In Great Britain, Germany, and France the average subscriptions per member are 70, 35, and 15 francs respectively. The writer complains that, notwithstanding the great number of French Societies and publications, no one publication similar to *Petermann* in Germany and the Proceedings of the Royal Geographical Society in England exists. He proposes, therefore, that a geographical indicator should be published containing the title, place of publication, summary of contents, price, and, where desirable, a critical review of all the geographical journals, as well as of new books, maps, &c. The editor of *La Gazette Géographique* promises to carry out the idea as far as possible by giving these details respecting such of the publications as have reached his hands since the beginning of the New Year.

DR. VON KLÖDEN recently published a list of 374 rivers, with their lengths, and other data, in which he gave the Nile as the longest river, with a length of 6470 kilometres, the Missouri-Mississippi coming second with 5882 kilometres. General von Tillo revises these estimates, and from more exact measurements concludes that the Missouri-Mississippi is the longest river in the world, with 6750 kilometres, the Nile coming next, with 6470 kilometres as in Von Klöden's list. Other rivers given both by Von Klöden and Tillo with the same measurements are the Ta-Kiang, 5083 kilometres; the Amazons, 4929; the Yenisei-Scelenga, 4750; the Amur, 4700; the Congo, 4640; and the Mackenzie, 4615. In connection with this subject *Petermann's Mittheilungen* states that a new curvimeter is being practically tested in Perthes's geographical establishment; if the results are satisfactory it will be of great service to those who have much to do with maps.

THE Geographical Society of Mexico is about to resume the publication of its proceedings, which has been interrupted since 1882.

Cosmos announces the forthcoming publication of an important work on the geography of the interior of Madagascar, by a French Jesuit, Père Roblet, who has explored the greater part of the island. It will be accompanied by various topographical maps, especially of the provinces of Imerina and Betsileo.

AT a recent meeting of the Geographical Society of Paris, a note was read from M. Cervera, who is charged by the Madrid Geographical Society with a journey in Eastern Africa, on his itinerary. M. Raffray, the Consul of France at Zanzibar, sent a report on the results of Dr. Junker's last journey. M. Chiffanjon, writing from San Fernando, announced his approaching departure for the exploration of the Orinoco; and Dr. Chervin read an interesting paper on the increase of the populations of France and the principal States of Europe during the present century. In France the urban population was only 24 per cent. of the total in 1843, while now it is 35 per cent. The writer referred to the very slow increase of the population in France, although the average mortality is less than in other European countries. In some of the departments the population is even less now than it was in 1801. He thought colonial extension was one of the most efficacious remedies for a state of things which threatened to place France in a position of numerical inferiority towards other States. New colonies, he says, open new fields to future generations. The process suggested, however, appears like that of putting the cart before the horse.

THE INSTITUTION OF MECHANICAL ENGINEERS

THE Institution of Mechanical Engineers held its meeting in the Theatre of the Institution of Civil Engineers on Thursday and Friday of last week. The paper on "Triple Expansion Engines," read at the last meeting, of which we then gave an abstract, was discussed. The remainder of the papers on the programme were read and discussed.

Mr. E. P. Rathbone's paper on "Copper-Mining in the Lake Superior District" comprised a general description of the district, the method pursued in mining, and the system of ore-dressing and machinery employed. The ore employed is what is known mineralogically as "native copper." It does not occur in true fissure veins, but rather in beds, or, as they are not inaptly termed in the district, "belts," dipping at the same inclination as the "country" or rock inclosing them.

From exhaustive scientific investigations into the origin and derivation of the copper in these deposits, it appears probable that it was infiltrated into them in the form of an aqueous solution of copper, which also appears to have had a strong chemical affinity for special constituents of the rocks, thereby giving rise to a series of chemical reactions, whence resulted the precipitation of native copper in a more or less concentrated state, according to the proportion and the even distribution or otherwise of the precipitating or displacing agent present in the original rocks. In the amygdaloidal trap-rocks the displacing agent appears generally to have been less evenly distributed than in the conglomerates; in certain places the concentration of the displacing agent has been so excessive as to give rise to the formation of large masses of copper. Whether or not the precipitating action was connected with some natural process of lixiviation, influenced by terrestrial electrical currents, it is impossible to decide. In the amygdaloidal trap-rocks the vein-stone is frequently composed largely of epidote, a mineral whose presence is regarded as favourable or "kindly" to copper. Other minerals found in association with the hornblende and augitic porphyries that constitute the vein-stone proper, are quartz, calc-spar, and many varieties of the zeolite group. The commercial copper smelted from these ores being entirely free from deleterious matters, such as arsenic, bismuth, antimony, &c., is especially valuable for electrical purposes, as the conductivity of copper is reduced by the presence of foreign matter even in the minutest proportions, a trace of arsenic reducing the conductivity 20 per cent. In the manufacture of brass, again, the presence of antimony is most deleterious: one-tenth of 1 per cent. converts first-rate "best selected" into the worst possible; one-fortieth of 1 per cent. renders it unfit for anything but inferior brass; one-eighth of 1 per cent. changes "best selected" into "tough ingot"; one-tenth of 1 per cent. of either bismuth, arsenic, phosphorus, nickel, or cobalt, is sufficient to turn "best selected" into tough metal.

There are two methods pursued: "mass mining," where copper is found concentrated into masses varying in weight from a few hundred pounds up to many tons; and "stamp-rock mining," where the copper occurs in a more or less divided state, and usually pretty evenly disseminated throughout the whole vein-stone, so that its separation from the matrix or gangue can be economically effected only by stamping and by the subsequent processes ordinarily employed in mechanical ore-dressing. The more evenly the copper is distributed throughout the vein-stone, the more valuable is the latter, and hence it is that vein-stone producing only 0.75 per cent. can be worked profitably at the present low price of copper.

The object of ore-dressing is to separate as far as possible the small percentage of valuable metal occurring in the ore from the worthless matrix or gangue, and concentrating it to the highest degree of purity practicable. The main feature of the process may be said to consist in applying to copper ore the principles and the machinery already employed elsewhere in the dressing of tin and lead ores.

In the Lake Superior copper-mining the features which appear to the author most worthy of special attention are:—(1) The care with which the exploratory workings are kept in advance of the stoping. (2) The general use of machine drills, which admits of opening up the mines at a rate otherwise impracticable. This is one of the few localities where drills are employed for stoping, and it has been found that two or three times as much rock can be stoped in the same time by drill as by hand. (3) The care bestowed upon the separation of the copper from the gangue by dressing.

M. Marc Berrier-Fontaine's paper was descriptive of his portable hydraulic drilling-machine, by means of which holes are drilled in a single operation through all the superposed thicknesses of metal without stopping the drill, which insures that all the holes are quite true. By its use 25 per cent. more holes are drilled than can be drilled by stationary machines in the shops.

Mr. H. Teague's notes on the pumping-engines at the Lincoln Water-works, which the Institution visited at its summer meeting last year, are mainly of a technical character. It is interesting to learn that when in 1884 still further pumping power was required, the author, from experience gained at Grantham, Maidstone, and other places, decided to revert to the Cornish pumping-engine, as he had been convinced that the cost of coals and repairs had been reduced in some instances to as low as only one-sixth of the annual expenditure pertaining to rotatory pumping-engines previously in use there.

THE SCOTTISH METEOROLOGICAL SOCIETY

THE Journal of the Scottish Meteorological Society, which has recently been published, contains, in addition to copious tables of the meteorology of 1885, several papers of more than usual interest. Prof. Piazzi Smyth leads with a suggestive paper on hygrometric observation, based chiefly on observations made by him in the neighbourhood of Malvern in the summer of 1885, on fifteen successive days, at 9 a.m., in June, at a height of 125 feet; and subsequently for twenty successive days at the same hour but at a height of 350 feet. Scrupulous care was taken to have the dry-bulb surrounded with air as nearly as possible of the same quality as that of the free atmosphere outside, by placing a large and tall black iron chimney on the top of the Stevenson screen, according to Mr. Aiken's idea of promoting a current inside the screen; and to have the wet-bulb as perfect as possible by enveloping it in thin muslin, tightly drawn over its surface, and by securing that it was always thoroughly wet for each observation. The results gave for the lower station a mean depression of 3°.4 of the wet-bulb below the dry-bulb; and 6°.4 for the upper station. It is probable that these results would be found to be higher than what obtained at the three or four stations in Central England nearest to Prof. Smyth's at the same dates; and without a doubt the value of the inquiry would have been enhanced if such comparisons had been made and recorded in the paper.

An important point would be gained if such inquiries led meteorologists more earnestly to consider the necessity of improving the means and methods of observing and reducing the observations of this most important element of the atmosphere, it being by its aqueous vapour that the disturbing influences at work are called into play, giving rise to winds, storms, rain, snow, hail, electric displays, and other atmospheric phenomena.

Mr. Omond, in an interesting paper on the wind and rainfall of Ben Nevis in 1885, based on the hourly observations at the Observatory, shows that the direction of wind with which most rain fell was a little to the north of west, and that the quantity diminishes round the compass in both directions from this until the driest point is reached a little to the south of east: east winds having a very low value. As regards the rate of fall with each wind during the time it lasts, north-westerly winds are the wettest and easterly and south easterly winds the driest. Since south-easterly winds mostly occur when an anticyclone is moving off and a cyclone approaching, the fact of their dryness at the Observatory, 4406 feet high, is a valuable contribution to our knowledge of storms, since the same winds under the same conditions at lower levels are notoriously wet.

A hopeful inquiry is being carried on at the Ben Nevis Observatory by Mr. Rankin, first assistant, on rainband observations; and from the results already obtained there can be little doubt that when a complete low-level observatory, with hourly observations, has been established at Fort William, much light will be thrown on the vertical distribution of vapour in this part of Great Britain, and its important bearing on forecasting the weather. The observations for seven months are discussed, and the means show that a heavier rainband indicates with steady regularity a larger rainfall as determined by the hourly observations.

But the most important contribution of new facts in the Journal are thirty-nine pages of temperature observations made on the Firth and Lochs of the Clyde from March to November 1886, by

the staff of the Scottish Marine Station on board the *Medusa*; the trips having been made in April, June, August, September, and November. The observations were made at all depths of the sea, from the surface to 107 fathoms. The novelty and, in not a few cases, the unexpectedness of the results render it advisable to delay a full discussion till more observations have been made and the densities worked out. In the meantime a provisional report on the results of the April and June trips, by Dr. H. R. Mill, will be read with interest. Among the unexpected results was the discovery in June in Loch Fyne of a lenticular mass of water with temperature below 43° floating between two warmer strata, the cold area being most definite at its upper surface and more diffused below. The greatest thickness of the mass of water colder than 43° was 180 feet, off Inveraray. Its lower bounding plane ran along the bottom from the head of the loch to Dunderave; then where the water deepens it dipped down again at the same angle until off Inveraray, where it bent up again and met the upper bounding surface at Furnace, 120 feet under the surface of the loch.

In a paper by the secretary on the meteorology of Ben Nevis, it is shown from the three years' observations at the low-level station and the high-level observatory that the mean decrease of temperature with height is at the rate of 1° F. for every 270 feet of ascent, the lowest monthly rate being 1° for every 284 feet in winter and the most rapid rate 247 feet in spring. A table of the barometric corrections for height for the different sea-level pressures and air temperatures that occur has also been prepared directly from the observations themselves. The importance of the results of these two inquiries rests on the fact that the Ben Nevis pair of stations alone supply, owing to their great difference in height, close proximity horizontally, and the positions of their thermometers, the physical data of observation which satisfy with sufficient closeness the requirements of these fundamental problems of meteorology. The science has now passed that stage when Great St. Bernard with Geneva, Mount Washington with Portland and Burlington, Hochobir with a station in one of the neighboring deep valleys, or brief continued observations with balloons or at different heights on the slopes of the Faulhorn, can be accepted as affording the data required for dealing seriously with these questions.

REPORT ON THE BOTANICAL GARDEN, SAHARUNPUR

MR. DUTHIE'S "Report on the Progress and Condition of the Government Botanical Gardens at Saharunpur and Mussoorie for the Year ending March 31, 1886," which has recently reached us, contains, besides the usual routine matter, inseparable from such Reports, on the state of the Garden itself, much that has a wider range of interest. As usual, the cultivation of new plants of economic value appears to have occupied a considerable amount of attention during the year. Where so many useful plants have been introduced and reported upon, it is not an easy matter to select one or two for an example of the work in which Mr. Duthie is engaged. The character of this work is now, however, pretty well known, though the following extracts will show that plants of very varied character and uses are yearly being experimented with in our Indian and colonial botanic gardens.

Under the head of New Zealand spinach, a quantity of the seed of this vegetable is reported to have been received and planted, germinating freely and yielding a continuous crop of leaves, which, when cooked, is said to much resemble in flavour that of English spinach. The plants, Mr. Duthie says, seed freely, and he has no doubt that it will readily acclimatise; though, as he says, the introduction is not one of much importance, except for variety, as it comes into season at the same time as English kinds, and it can hardly compete with them in popular estimation. This so-called New Zealand spinach many of our readers will remember as *Tetragonia expansa*.

The Oca-quina (*Ullucus tuberosus*) is another food-plant upon which experiments in cultivation have been made. It is a native of South America, and the tubers, which are about the size of a walnut, and similar in appearance to a potato, are eaten, when cooked, by the people. Its cultivation in this country as a substitute for the potato was at one time proposed and attempted. Mr. Duthie says that twenty-eight tubers were received by him from the Royal Gardens, Kew, four of which were sent to the Arnigarth Garden, and the remainder were planted at Saharunpur. Up to within a few weeks of the date of the Report,

these latter plants had made good growth, but after the commencement of the hot weather they became sickly, so that it is evident it will not suit the plains of India, but may succeed very well in the climate of Arnigarth, where it was intended that the majority of the plants should be sent.

Of the Japanese varnish-tree (*Khus vernicifera*) the seedlings are stated to be making rapid progress. The growth for the two years after germination did not average more than a foot, which, however, has been doubled since the commencement of the hot season, and there is now no reason to doubt that this useful tree will thrive in the climate of Saharunpur. Mr. Duthie further says a small plantation will be made next rainy season, and it will then be a question of time as to when the plants will be ready for tapping.

Mr. Duthie makes the following interesting report on the subject of spider silk, which had previously attracted some attention. He says:—"I arrived from British Garwhal just in time to superintend operations at the commencement. The men employed on this work were provided with small sticks about a foot long, and they were told to collect as many clean webs as possible during the day. There was not much to show at the end of the day, as the silk takes up very little space when wound round these sticks, and the weight is inappreciable. The total weight of webs collected during the season did not exceed 10 lbs., the bulk of which was despatched to Mr. Wardle, of Leek. The cost of collecting the above, and the carriage from Bhim Teel to Saharunpur, and from Saharunpur to Bombay, amounted to Rupees 33-7-0. At this rate the export of spider silk to England would, of course, never pay, but expenses might be reduced very considerably: for instance, this first consignment included the weight of the sticks round which the silk was wound. The silk is removable after immersion in hot water. During my stay at Indalpur, in the Sháhjahanpur district, I saw some fine clean webs of the same kind in a forest about eight miles to the north of Indalpur."

Judging from the remarks of Mr. Duthie, there seems but little chance of spider silk ever becoming an article of commercial value.

The Report includes some interesting notes on some official tours made by Mr. Duthie during the year, and a valuable list of plants collected, the names of which have been verified at the Royal Gardens, Kew.

SCIENTIFIC SERIALS

Bulletin de l'Académie des Sciences de St. Pétersbourg, tome xxxi. No. 3.—Corrections and additions to the Syrian-German and Votyak-German dictionaries, published in 1880, by F. J. Wiedemann. These emendations are based on the following recent works: "The Land and Language of the Syrians," by Lytkin; the publications on the Votyak language issued by the Kazan Mission; "Votyak Tales and Proverbs," collected by Dr. Aminoff, and published in the works of the recently instituted Finnish-Ugrian Society; Dr. Max Buch's ethnographical sketch of the Votyaks in the "Actæ Societatis Scient. Fennicæ," vol. xii.; and M.M. Koshurnikoff and Miropolsky's monographs on the Votyaks.—On the Ornis of the western spurs of the Pamir and Alai, by V. Bianchi.—On "Claudii Galeni Pergameni Scripta minora," by L. Nauck.

Nyt Magazin for Naturvidenskaberne, vol. xxx. Nos. 3 and 4, Christiania, 1886.—This number of the Norwegian *New Journal of Sciences* contains:—Continuation of Herr Brøgger's paper on the geological history of the Christiania Fjord. According to the writer, it may be assumed that the bed of the fjord has been raised by eruption to the surface of an older bed, which consists of depressed strata of the earth's crust, whose depression had been connected with active processes of dislocation, crumpling, and folding in the post-Silurian period. The evidences of erosion and eruption are considered at length, with special reference to the action of glaciers in the formation of the fjord.—Dr. Lang concludes in an exhaustive paper his contributions to the study of the eruptive rocks of the Silurian beds of Christiania, and thus completes an important chapter in the geological history of South Scandinavia.—Notice of *Regalecus glesne ascanius*, by Herr J. Grieg. This specimen, a female, with well-developed ovarium, is the fourteenth that has been taken off the Norwegian coasts since 1740.—Report of the various attempts made within the last four years to introduce new plants into Iceland, by Dr. Schierbeck. The results of these efforts to

large the meagre flora of the island are scarcely encouraging. But, although hopes are entertained that some kinds of maples may thrive in sheltered spots, conifers, from whose introduction great expectations were entertained, have not given promise of success, while poplars, oaks, apple and pear trees have without exception died. Common red- and black-currant bushes thrive as far as to set fruit, but this does not ripen except in the warmer summers. Potatoes, which would be invaluable to the islanders, have not yet been successfully cultivated, but rhips, rhubarb plants, and several of the hardier cabbages, together with lettuce and chamomile, do well. The great question, whether cereals can be cultivated, as would appear to have been the case in the times of the Sagas, does not seem to admit of a satisfactory solution, and, according to the writer, the present regular supply of corn from the mother-country by means of rapid steamers, no longer makes the attempt necessary or desirable from an economic point of view. An interesting list of the various plants introduced, with the times of sprouting, sowing, &c., adds to the value of Herr Schierbeck's paper.

Revue d'Anthropologie, troisième série, tome ii., Paris.—On cephalization, by M. Topinard, of the Society's instructions regarding the colour of the eyes and hair in France, with facsimiles of the printed papers distributed to intending observers, and directions how they should be filled up.—On a quinaryomenclature for the nasal index in the living subject, by Dr. Collignon. The writer, who considers a correct and systematically determined nasal index as the most important anthropometric determination, not excepting even the cephalic index, proposes to divide the ordinarily accepted nasal groups into hyper-leptorhinian, leptorhinian, mesorhinian, platyrhinian, and hyper-platyrhinian, including under the platyrhinian section all the black races, under the mesorhinian the yellow race—generally, and under the leptorhinian most of the white races. The paper gives a clear and concise description of the instruments in general use, and of those best adapted for making the required measurements, which he regards as of paramount value in determining racial characteristics.—Contributions to the sociology of the Australian races, by Elie Reclus. This paper, which is principally concerned with the system of clanships and cousinships existing among these peoples, has comparatively little interest for English readers, who have long been familiar with the curious questions involved in the principles of inter-tribal relationship. Indeed, M. Reclus has drawn so largely from the writings of Brugh-Smyth, Eyre, Howitt, Taplin, Morgan, McLennan, and other British writers, that this first part of his paper is a mere *résumé* of some of the more sensational details of information contained in their several works.—Anthropological observations in Guiana and Venezuela, by Dr. Ten Kate. These observations chiefly refer to the differences between the native Caribs, the so-called "wood Negroes," and half-castes. The first of these present two distinct types, reminding the anthropologist of the Red Indians in some respects, and of the Mongolian races in others; the second are a specially vigorous black tribe, the descendants of runaway slaves domiciled in the forests of Surinam. Most of these men are of herculean strength and stature. Numerous anthropometric and other tables illustrate the paper.—On the depopulation of France, by M. de Lapouge. This subject, which has lately been attracting renewed attention through the appearance of the second edition of M. de Nadaillac's interesting pamphlet "On the Decline of the Birth-Rate in France," is considered by the author from an anthropological as well as a social and moral point of view. After drawing attention to the fact that while between 1770 and 1780 there were 380 births for every 10,000 of the population, this number has gradually fallen to 235 for the present decade, and is thus lower than that of Switzerland, which had been assumed to have the lowest birth-rate in Europe, and less than half that of Russia. According to the writer, the population of France has reached a stationary point, its annual increase of 80,000 admitting of no comparison with the hundreds of thousands, and even millions, annually added to the populations of Germany, Russia, the United States, and the British Empire, while, moreover, this slight increase is solely to be referred to the constantly increased immigration into France of foreigners, who now constitute one million of the population, and who predominate so largely at some points as to have reduced the French language to a secondary place in such districts. The writer discusses the various causes, such as the adoption of Malthusian principles, alcoholism, Catholicism, immorality, want of patriotism, self-interest, &c., to which the

present low birth-rate has been referred. And rejecting these as inadequate, he insists that the main source of the increasing depopulation in France is the gradual obliteration since the great revolution of the blond dolichocephalic type, to which he considers most of the distinguished Frenchmen of earlier times belonged, while the representatives of the brachycephalic races, who have never distinguished themselves in science, art, or letters, have been able to take the lead through superiority of numbers. By their cupidity, narrow range of interests, and indifference to the traditions of family and national glory, he holds them responsible for the anomalous condition of the country, in which an unprecedented accumulation of wealth and great prosperity are associated with physical degeneration and diminished births. In the re-introduction of the dolichocephalic element through immigration the author sees the surest means of effecting a substitution of national type and the best prospects of securing renewed vitality to the French race.

Rendiconti del Reale Istituto Lombardo, December 1886.—Obituary notice of the late honorary member of the Institute, Signor Marco Minghetti, by the Editor. Reference is made more especially to the illustrious statesman's great merits as a political economist and art critic.—On the liquors employed in the artificial cultivation of Bacteria and other minute organisms, by E. L. Maggi. The various gelatinous, albuminous, and other solutions now in general use are described, with remarks on the best means of preparing and rendering them sterile.—On the geometry of linear spaces in a space of n dimensions, by Prof. E. Bertini. The author's theorem for ordinary space of three dimensions—"A necessary and sufficient condition for three straight lines to exist in a plane is that all straight lines meeting two of them at arbitrary points shall also meet the third"—is here generalised for a linear space S of any number n dimensions.—Meteorological observations made at the Brera Observatory, Milan, during the months of October, November, and December, 1886.

Rivista Scientifico-Industriale, December 1886.—Determination of the weight of the mercury contained in a thermometer, by Dr. G. Gerosa. Clayden having recently determined the volume of the mercury contained in a thermometer (Proceedings of the Physical Society of London, vol. vii. p. 367, 1886), Dr. Gerosa here gives a determination of its weight, which he had already worked out in the *Rendiconti* of the R. Accademia dei Lincei, vol. x., 1881.—On the electric transmission of force, by Dr. Gerosa. The paper gives a critical appreciation of the work done by M. Marcel Deprez at Creil and by M. Fontaine in the Atelier Gramme. He considers the latter experiments the more successful of the two, M. Fontaine showing that with more economic means the same results may be realised as were obtained in the experiments at Creil.—On the development of electricity in the condensation of aqueous vapour, by Dr. Franco Magrini. In reply to Prof. Costantino Rovelli the author again shows that there is no perceptible development of electricity during the condensation of the vapour of water. A description follows of M. A. Nodon's hygrometer, already reported in the *Journal de Physique* for October 1886.

SOCIETIES AND ACADEMIES

LONDON

Royal Society, January 13.—"Supplementary Note on Remains of *Polacanthus foxii*." By J. W. Hulke, F.R.S.

In a paper published in the *Phil. Trans.* 1881 the author described some remains of a large Dinosaur, remarkable chiefly for its dermal armour, discovered some fifteen years previously in Brixton Bay by the late Rev. W. Fox, and then in his collection. These have since become national property; and the large shield, which, for facility of transport, had been broken up by its discoverer into innumerable small pieces, having been recently reconstructed in the workshop of the British Museum, the author now describes this singular armature, and also some parts of the pelvis formerly obscured by rock. The pieces, which, in their very fragmentary condition, had been thought scutes, are now seen to be parts of a continuous osseous shield which protected the rump and loins, having its anterior surface ornamented with closely-set tubercles, and in each lateral half four longitudinal rows of keeled eminences. The ischium has its long axis directed transversely to that of the trunk, and not roughly parallel to it as in the *Iguanodonts*.

January 20.—“A Study of the Thermal Properties of Methyl Alcohol.” By William Ramsay, Ph.D., and Sydney Young, D.Sc.

The writers have investigated the properties of the above substance, and obtained numerical values for the expansion of the liquid, the vapour-pressure, and the compressibility of the vapour; and from these results the densities of the saturated vapour and the heats of vaporisation have been deduced. The range of temperature is from -15° to 240° C., and of pressure from 11 mm. to 60,000 mm. The apparent critical temperature is 240° , and the pressure 59,660 mm. The pressures were corrected by means of Amagat's results, and the temperatures are those of an air thermometer.

January 27.—“On a Perspective Microscope.” By G. J. Burch.

In 1874, the author, while trying to devise means whereby the different planes of an object should be visible under the microscope without the adjustment of the focus to each, discovered that, when two lenses are separated by a distance equal to the sum of their focal lengths, the optical conditions are such that the magnitude of the image bears a constant ratio to that of the object, no matter where upon the optic axis it is situated—the ratio being that of the focal lengths of the two lenses; that a given displacement of the object along the axis causes a displacement of the image in the same direction, but in the square of the ratio.

Further, that a picture drawn with the camera lucida under these conditions has the perspective of an object magnified in the square of the ratio, when it is brought within the proper distance of the eye.

The field of view of the perspective microscope is small, but may be increased by using more than two lenses, and the author's researches gave him reason to believe that, with glasses of wide angle specially constructed, a high power, with sufficiently large field, might be obtained. Several uses, other than microscopic, were indicated, to which the instrument can be applied.

The paper was accompanied by diagrams showing, in two different ways, the changes of position of the principal foci and principal points, &c., of a system of two lenses as the distance between them is varied.

A piece of moss was shown under the instrument, in magnified perspective.

“On the Thermo-dynamic Properties of Substances whose Intrinsic Equation is a Linear Function of the Pressure and Temperature.” By Geo. Fras. Fitzgerald, F.R.S.

Prof. Ramsay and Mr. Young have found that within wide limits several substances in the liquid and gaseous states have the following relation connecting their pressure (p), temperature (T), and specific volume (v),

$$p = aT + b,$$

where a and b are functions of v only.

Now in this case the following are the forms that the thermo-dynamic equations assume: T is temperature, and ϕ is entropy, and I is the internal energy.

$$\text{Then } I = \gamma + \lambda,$$

where γ is a function of temperature only, and λ a function of volume only.

$$\text{Also } \phi = \Gamma + \alpha,$$

where Γ is a function of temperature and α of volume only.

Also, the specific heat at a constant volume is a function of the temperature only.

It would be most important if by some method, König's for instance, or by inserting a small microphone into a tube, the velocity of sound in substances in various states could be accurately determined, as that would enable us to determine separately the specific heats at constant pressure and constant volume.

Linnean Society, January 20.—W. Carruthers, F.R.S., President, in the chair.—Mr. J. Benbow and Mr. F. S. J. Cornwallis were elected Fellows of the Society.—It was announced from the chair that H.R.H. the Prince of Wales had officially entered his name on the roll of the Society.—The President made the presentation of an oil-portrait of Francis Masson, F.L.S., elected 1796.—Prof. Bayley Halfour exhibited specimens and showed the microscopic structure of the “ginger-beer plant.” He pointed out that, although well known and used by many people as a means of manufacturing an acid drink out of sugar solution and ginger, yet no scientific account of the organism

had appeared except a short note by Worthington Smith in the *Gardener's Chronicle*. It has the appearance of a white No. 100, and is composed of a Bacterium (passing through all forms of rods, coils, and filaments), which apparently constitutes its greater part; and associated with this is a sprouting fungus. Judging from descriptions and figures by Kern of the “Kephir,” used in the Caucasus to induce fermentation in milk, the ginger-beer plant closely resembles this; but there are many points of difference. The plant is said to have been introduced into Britain by soldiers from the Crimea.—A letter was read from Mr. Benj. Lowne referring to an exhibition by him of photographs from microscopical specimens of the retina of insects. One section represented the retinal layer detached from the optic; other sections showed the basilar layer: thus practically affording evidence that the nerves terminate in end organs, rods placed in groups beneath the optic—a view promulgated by Mr. Lowne in his memoir published in the Society's Transactions.—Mr. J. W. Waller exhibited a block of wood, part of an oak grown in Sussex containing an excavated tunnel and live larva of the longicorn beetle *Trionus corivius*.—Mr. Thielton Dyer showed and made remarks on two sheets of Arctic Alpine plants from Corea.—Mr. F. Darwin and Miss A. Bateson read a paper on the effects of stimuli on turgescent vegetable tissues, of which we hope to give an abstract in an early issue.—Mr. J. R. Vaizey read a paper on the morphology of the sporophore in mosses. According to his researches, the seta of mosses consists of an outer sclerenchyma, within which is parenchymatous tissue, and in the middle the “central strand”; this latter being surrounded by a single layer of cells, forming the endoderm, derived from the outer meristem of the growing apex. It consists of two forms of tissue, one being of thin-walled prosenchymatous cells destitute of protoplasm, their function being to conduct water: this the author terms *proxylem*. Surrounding this is a second cylinder of elongated cells with thickened walls, containing granular protoplasm; this tissue he terms *prophloem*. On tracing the proxylem downwards, it is found that it gradually encroaches on the other tissues by the “foot,” until it takes on the character of conducting tissue. The stomata on the theca are confined to the hypophysis: the form of stomata in which the guard-cells communicate is internally typical only of Polytichaceae and *Funaria*. In the young sporogonium five distinct meristems occur with different laws of cell-division; one form with an axial solid cylinder he terms “endomeristem.” It gives rise to the central strand in the seta, and in the theca to so much of the tissue of the columella as lies within the sporogenous zone, the cells round this being derived from the “epomeristem,” whilst the sporogonium layer is itself derived from the endomeristem. The hypophysis is an absorbing and assimilating organ, and performs all the functions of a leaf, and should be classed as a phyllone. The water-conducting tissue of the sporogonium only differs from the xylem of Vasculares in the absence of spiral thickening and lignification of the cells. The prophloem differs even less from the phloem of some Vasculares, and though no sieve-like tubes have been made out, yet they are wanting also in some Vasculares, e.g. *Selaginella*. The author compares the development of the sporogonium in some respects to certain parasitic plants; and he draws the conclusion that the Muscinæ are descended from an ancestor common to them and Vasculares, similar to the Anthocerathæ, finally hoping in a future paper to deal with their phylogeny, specially referring to the vascular system and its homologue, the central strand of the Musci.

Anthropological Institute, January 25.—Anniversary Meeting.—Mr. Francis Galton, F.R.S., President, in the chair.—The following were elected Officers and Council for the ensuing year:—President: Francis Galton, F.R.S. Vice-Presidents: Hyde Clarke, J. G. Garson, M.D., Prof. A. H. Keane. Secretary: F. W. Rudler. Treasurer: A. L. Lewis. Council: G. M. Atkinson, Sir W. Bowman, Bart., E. W. Brabrook, Sir George Campbell, M.P., C. H. E. Carmichael, A. W. Franks, F.R.S., Lieut.-Colonel H. H. Godwin-Austen, F.R.S., Colonel J. A. Grant, C.B., T. V. Holmes, Prof. A. Macalister, F.R.S., R. Biddulph Martin, Prof. Meldola, F.R.S., Prof. Moseley, F.R.S., C. Peek, F. G. H. Price, Charles H. Read, Lord Arthur Russell, H. Seebohm, Prof. G. D. Thane, M. J. Walhouse.

Chemical Society, December 16, 1886.—Dr. Hugo Müller, F.R.S., President, in the chair.—The following were duly elected Fellows of the Society:—Messrs. Horace Edward

others, Francis J. H. Coutts, Tamemasa Haga, Henry John ardy, Michitada Kawakita, Walter Leach, Stephen James sntecost, Henry Joshua Phillips, P. Yehwant Sheshadri, etsukichi Shimidzu, Joseph Stapleton, Willi am Phillips Thomn, Hikorokuro Yoshida.—The following papers were read :— eesearches on the constitution of azo- and diazo-derivatives ; (1) iazoamido-compounds, by R. Meldola, F.R.S., and F. W. reatfeild.—The influence of silicon on the properties of iron id steel, part 1, by Thomas Turner.—The distribution of nitring organisms in the soil, by R. Warington, F.R.S.—Isomeric ange in the phenol series ; the action of bromine on the di- omomnitrophenols, by A. R. Ling.—Some azines, by Francis . Japp, F.R.S., and Cosmo Innes Burton.

January 20.—Dr. Hugo Müller, F.R.S., President, in the air.—The following papers were read :—Some silicon com- ounds and their derivatives, by J. Emerson Reynolds, M.D., .R.S.—Chromo-organic acids ; part 1, certain chromoxalates, y Emil A. Werner.—Note on the constitution of the double yromic oxalates, by W. N. Hartley, F.R.S.—Remarks on cent papers by A. Baeyer and J. Thomsen on the constitution f benzene, by Alex. K. Miller, Ph.D.

Royal Microscopical Society, January 12.—Rev. Dr allinger, F.R.S., President, in the chair.—Mr. J. Mayall, Jun., irected the attention of the meeting to eleven photo-micrographs ent by Dr. van Heurck, and which the latter thought showed :sults of exceptional merit. The one of *A. pellucida* by trans- itted light was rather striking ; it showed apparently two ries of lines which were resolved into dots, and, so far as he as aware, this was the best of the kind which he had yet seen. ut Dr. van Heurck did not say whether it was taken from a ecimen mounted in a dense medium or not, and he thought so that several important questions of technique were omitted hich it would have been very useful to have had mentioned. n the pamphlet which accompanied the photographs, Dr. oyston-Pigott was quoted to the effect that they were quite free om what used to be called "diffraction-spectra," which now ere have no existence whatever ; but on examination, unless he as much mistaken, they had been painted out, or otherwise otted out, from the negative, so that Dr. Royston-Pigott, in his marks upon this supposed fact, had made what the French alled a *boulette*. If it was desired to give each photograph a al value, the background should not be interfered with, and ach impression should have the particulars as to magnification, ounting, and other data for identifying the object, the posses- ion of which was essential in order to form any reliable opinion. As regards the longitudinal lines of *A. pellucida*, as shown in he untouched negatives of these photographs, Dr. van Heurck aid he had submitted them to Prof. Abbe, who replied that, as hey appeared closer than the diffraction-lines, that was a satis- actory demonstration of their existence in the object. As to the otograph of *P. angulatum*, in which a central spot was shown, ll who were familiar with the object were aware that they could et the appearance of a central spot or not, according to how hey looked at it : it was a question of change of focus. *Virirella gemma*, he thought, was not better shown than n Dr. Woodward's photographs. Then there were photo- raphs of Nobert's lines, which were said to be of the 8th and 19th bands ; but here again there was nothing to nable one to identify them or to say that they were not the 14th nd 15th bands.—Mr. M. Pillischer exhibited his new "Kosmos" icroscope.—Mr. T. Charters White read a note on tartar om teeth of the Stone Age.—Mr. Crisp exhibited a cylinder f glass, which, though it had plane ends, acted as a concave ens, and solved some of the questions which had been raised as o the images formed in insects' eyes. He also explained Prof. Exner's method of preparing similar cylinders from celloidin and elatine, when the effect of convex lenses was obtained.—Mr. Crisp directed the attention of the meeting to the figures of nrmous microscopes in Schott's "Magia Naturalis," 1657. hese had long puzzled microscopists, who were at a loss to nderstand what could be the object in making microscopes of he large size which was indicated by the comparison with the bservers as looking through them. In Traber's "Nervus pticus," what was undoubtedly meant for drawings of the same icroscopes, the mystery was solved, for if Schott's figures were ubbed out, and single eyes were substituted for them, as Traber id in his drawings, the scale of the microscope represented as, of course, strikingly altered, and it was seen that they ere small hand microscopes after all.—Mr. J. Medland ex- ibited and described his portable cabinet for microscopic slides.

—Mr. Crisp exhibited Stein's electric microscope.—Mr. A. W. Bennett gave a *résumé* of his paper on freshwater Algæ (including chlorophyllaceous Protophyta of North Cornwall), with descrip- tions of six new species, illustrated by coloured diagrams.—Mr. J. Mayall, Jun., gave a very interesting account of a recent visit to Jena, where he had been afforded every facility for examining all the processes of manufacture as carried out in the factories of Dr. Zeiss. He also described his interviews with Prof. Abbe, and the way in which they had together tested numerous objec- tives which he had taken for the purpose.—Dr. A. C. Stokes's paper, on some new American freshwater Infusoria, was read.— The nominations for the new Council were read, and auditors appointed.

PARIS

Academy of Sciences, January 31.—M. Gosselin, Presi- dent, in the chair.—On the commensurability of the mean movements in the solar system, by M. F. Tisserand. The object of this paper is to throw some light on the delicate ques- tion, how far exact commensurability is compatible with the stability of two or more bodies revolving round a common centre, as maintained by Gauss, and more recently by Gylden and Harzer, and denied by W. Meyer in his memoir on "The System of Saturn," Geneva, 1884.—Metals and minerals from ancient Chaldaea : on the sources of tin in the Old World, by M. Berthelot. The analysis of certain metallic remains from the Palace of Sargon at Khorsabad and from Tello in Babylonia, combined with recent reports of tin mines now being worked in various parts of Khorassan, suggests the question whether tin may not have been derived from that region by the Assyrians and Chaldeans long before its arrival from the more remote Sunda Islands and Malay Peninsula in the East, or from Corn- wall and one or two other parts of Europe in the West.—Ex- periments on the effects of transfusions of blood in the head of decapitated animals, by MM. G. Hayem and G. Barrier. The results are described of experiments on the head of dogs im- mediately, and some time after separation from the trunk, such as those studied some thirty years ago by M. Brown-Séquard, but not since renewed by physiologists. The authors conclude generally that the extinction of feeling and will is extremely rapid, if not instantaneous, after decapitation ; that conscious life may be sustained by the immediate injection of arterial blood from any animal of the same, or even of a different species ; and that such transfusion, made after some minutes' delay, may stimulate certain automatic and multiple reflex movements, but is powerless to re-awaken either sense or will.—Observations of the new comets of Brooks and Barnard, made at the Paris Observatory (equatorial of the West Tower), by M. G. Bigour- dan.—Observations of the same comets made at the Observatory of Bordeaux with the 0.38 m. equatorial, by MM. G. Rayet and Courty.—On a method for determining the constant of aberration, by M. J. C. Houzeau. The author points out that the fundamental principle of this method, as recently submitted to the Academy by M. Loewy, had already been indicated by him in a paper on the study of the movements of the stars, pub- lished in 1871, in vol. xxxviii. of the Mémoires of the Belgian Academy.—On the mean periodicity of the spots in Jupiter, by Dom Lamey. By a careful study of older maps of this planet (which is still in a state of incandescence analogous to that of the sun), combined with more recent observations at the Obser- vatory of Grignon, the author deduces a mean peri-odicity of 5.43 ± 0.07 years for its spots.—On the theory of algebraic forms with p variables, by M. R. [Perrin.—Researches on the trans- mission of electricity of feeble tension through the medium of hot air, by M. R. Blondlot. This is a summary of the author's researches on the transmission of an electric current through heated air, which form the subject of a memoir presented by him to the Academy. It is shown that hot air has, properly speaking, no resisting power, and he feels inclined to attribute the phenomenon to the principle of *convection*, as described by Faraday.—On the variable period of the currents in the case of circuits containing an electro-magnet, by M. Leduc.—On a halo accompanied by parhelia, observed at Fontainebleau on January 28, by M. A. Bouisson. This phenomenon, observed between 9.30 and 10 a. m., presented the appearance of a luminous circle, with a radius of about 23° , concentric with the sun, passing from a light brown in the centre to a greyish-yellow on the periphery. A second luminous circle, concentric with the preceding, with a radius of about 47° , showed in its upper segment the colours of the rainbow, red on the inner side. Tangential to both circles were vividly coloured arcs, the brilliancy of the latter decreasing

rapidly towards the extremity, while a luminous horizontal band passing through the centre of the sun stretched across the firmament, showing three parhelia—two very bright on the small, one faintly illumined on the large, circle.—Combinations of the glycerinates of soda with the monatomic alcohols, by M. de Forcrand. This paper deals with the glycerinates of methylic, ethylic, propylic, isobutylic, and amylic soda.—On the comparative actions of solar heat and light, by M. E. Duclaux. It is shown that all the effects of combustion produced by heat may also be produced by light; but the reverse does not hold, there being a large number of reactions, which light alone seems capable of determining. All these reactions are resumed in the displacement of the primitive molecule, which becomes decomposed in a few simpler elements, such as the formic, acetic, and butyric acids, the methylic and ethylic alcohols, &c.—On the properties of inosite, by M. Maquenne. Continuing his study of this substance, the author shows that in its transformation it may give rise to several well-defined aromatic compounds. Its other properties, he considers, may now be anticipated theoretically.—On a combination of paratoluidine and chloride of copper, by M. E. Pomey.—On the composition of the grains of *Idcus sorgho*, and their application to the agricultural industry in the south of France, by M. Bordas. The analysis of this grain shows a mean of 42 per cent. of starch, 100 kilogrammes yielding 26 litres of good alcohol at 33° above proof.—On the jugal and pterygoid stems in the vertebrates, by M. A. Lavocat.—On the heterogamy of *Ascaris dactyluris*, by M. Macé.—Reply to M. Balbiani on the subject of *Leucophrys patula*, by M. E. Maupas. The author shows that he has in no way exaggerated the novelty and interest of his observations on the various reproductive processes of this organism, as asserted by M. Balbiani.—On diurnal and nocturnal physiological variations of the cerebral pulse, by MM. Rummo and Ferrannini. The authors' observations establish a complete cycle or periodicity in these variations, from which they hope to deduce the biological theory of normal sleep.—On the secreting ducts and aquiferous apparatus of *Calophyllum*, by M. J. Veque.—On certain phenomena of linear corrosion in the limestone formations of Couzon, Rhone Valley, by M. Ferdinand Gonnard.—On the epoch when the submerged valleys of the Gulf of Gen a were formed, by M. A. Issel. All these riverain valleys along the coast of Liguria appear to have been submerged towards the close of the Messinian and during the Astian epoch.

BERLIN

Meteorological Society, December 7, 1886.—Prof. von Bezold in the chair.—Dr. Hellmann stated that he had examined the observations of the County Fire Insurance Society in Schleswig-Holstein for the years 1874-83 for the purpose of investigating the question of lightning flashes in this province, and communicated the results of that investigation. As is the case in every other locality in which investigations of this description had been carried out, it was shown that generally over the whole province of Schleswig-Holstein there is an increase in the amount of damage wrought by lightning for the decade in question. On a comparison, however, of the different districts, it was found that the territory to the south of the Eider had experienced an abatement of damage by lightning, while to the north of the Eider, along the North Sea, and especially in the marshes, there had been a considerable increase. A computation of damage from lightning for one year demonstrated a very decided maximum in August in the continental, southern, and south-eastern districts, whereas in the north and west a summer maximum of less intensity and two still weaker maxima in May and October became apparent. In respect of a daily period it appeared that in the case of the first group of districts a maximum appeared in the hours from noon to 3 in the afternoon, while in the remaining part of the province the maximum was attained from midnight to 3 in the morning. This night maximum was specially characteristic of winter. The frequency of thunderstorms had no relation to the danger from lightning. The number of destructive lightnings depended in large part on the way in which the houses were roofed. The number was considerably greater in the case of soft than of hard roofs. In the case of churches the danger from lightning was 39 times, in the case of windmills 52 times, as great as in the case of houses having hard roofs. In regard to the cause of the different degrees of danger from lightning in the different districts, investigation indicated two points as determinative: first, the way in which the ground was built upon, and second, the geological nature of the ground. Whilst in the west, which was

very liable to destructive strokes of lightning, the farmsteads were detached and scattered over the whole land; in the east and south they were grouped together into villages, and the danger from lightning was always considerably less for large collections of houses than for scattered houses forming the only prominent objects throughout wide spaces. In point of fact, the danger from lightning was everywhere considerably less for towns than for rural districts. With reference to the geological bearings of the question, the danger from lightning was least for calcareous sand and greatest for clay. Dr. Hellmann had likewise discussed the statistics of lightning for Baden and Hesse Darmstadt, with the result that he found during the period investigated a considerable increase of damage by lightning for the southern part of Baden, and a decrease for the north of Baden and for Darmstadt. Besides a confirmation of the results arrived at for Schleswig-Holstein there appeared in the Baden-Darmstadt region a decided preponderance of danger from lightning in the Rhine plain as contrasted with a very low degree of danger in the mountains.

BOOKS AND PAMPHLETS RECEIVED

Notes of a Naturalist in South America: J. Ball (Kegan Paul and Co.).—United States Commission of Fish and Fisheries, Report, 1884: (Washington).—Berichte von dem Erzbischöflich-Haynaldschen Observatorium zu Kalocsa in Ungarn: C. Braun (Münster).—The Steam-Engine: G. C. V. Holmes (Longmans).—The Eccepiad, No. 13, vol. iv. (Longmans).—Quarterly Journal of Microscopical Science, January (Churchill).—Brain, January (Macmillan and Co.).—Journal of the Statistical Society, December (Stanford).

CONTENTS

	PAGE
The History of Howietoun	337
Harmony and Counterpoint	339
Pearls and Pearly Life	339
Our Book Shelf:—	
Webb: "The Definitions of Euclid"	340
Holst: "Narrative of an Expedition to Greenland"	340
Wood: "The Handy Natural History"	341
Bentham: "Hand-book of the British Flora"	341
"The Zoological Record"	341
Letters to the Editor:—	
Lightning Flashes.—Prof. John Le Conte; Antoine d'Abbadie	342
Dr. Modigliani's Exploration of Nias.—Prof. Henry H. Giglioli	342
<i>Lepidosiren paradoxa</i> .—Prof. Henry H. Giglioli	343
The Coal-Dust Theory.—W. Galloway	343
Abnormality in the Urostyle of the Common Frog.—Prof. C. Lloyd Morgan. (Illustrated)	344
The Cambridge Cholera Fungus.—Edgar Crookshank	344
Low Barometric Readings.—Henry F. Blanford	344
Magnetic Theory.—James C. McConnell	344
"Phantasms of the Living."—Edmund Gurney	345
University College, Bristol.—Albert Fry	345
A Rule for escaping a Danger.—Frank Morley	345
Abnormal Cats' Paws.—E. W. Claypole; Dr. H. A. Hagen	345
The Cross as a Sun Symbol.—Dr. Charles R. Dryer	345
Clausius's Formula.—Prof. William Ramsay and Dr. Sydney Young	346
Notes on Certain Traits of Infant Navajos.—R. W. Shufeldt	346
Long-lost Reefs. By Capt. W. J. L. Wharton, F.R.S. (With a Map)	347
The Crocus	348
Notes	349
Our Astronomical Column:—	
Comet Brooks (1887 b)	352
Comet Barnard (1887 c)	352
The Rousdon Observatory	353
Minor Planet No. 264	353
Astronomical Phenomena for the Week 1887	
February 13-19	353
Geographical Notes	353
The Institution of Mechanical Engineers	353
The Scottish Meteorological Society	353
Report on the Botanical Garden, Saharanpur	356
Scientific Serials	356
Societies and Academies	357
Books and Pamphlets Received	360

THURSDAY, FEBRUARY 17, 1887

THE ORIGIN OF MOUNTAIN RANGES

The Origin of Mountain Ranges considered Experimentally, Structurally, Dynamically, and in Relation to their Geological History. By T. M. Reade, C.E., F.G.S. (London: Taylor and Francis, 1886.)

THAT the skin of our mother Earth's face is wrinkled and shrivelled, is one of the common facts of geology. True it is that with fine feminine instinct she strives to hide the ravages of time beneath a fair covering of grass, moss, and herbage, and gracefully does her best to make her old age comely; and we love her for her skill in covering up the signs of her years. But we are fain, directly we look below the surface, to admit that the wrinkles are there. And the parallel is not a fanciful one, for it has long been a favourite theory among geologists that the wrinkled skin of old age, and the foldings and bendings which are everywhere to be discerned in the layers of the skin of the earth, are due to similar causes. In both cases, something underneath the skin, which in youth kept it stretched and tense, has shrunk away, and the skin has shrivelled up. In the case of the earth it is the gradual contraction of the interior as it cools, which has caused it to draw away from the outer shell; and the crust, as it follows down the shrinking nucleus, has to pack itself into a smaller space, and consequently becomes crumpled up. This explanation is known as the "Contraction Hypothesis." Numbering as it does many supporters, it has had at the same time some vigorous opponents. In his "Physics of the Earth's Crust," the Rev. Osmond Fisher was led to the conclusion that the contraction hypothesis would not furnish anything like the amount of elevation that has actually occurred in the case of the earth. We admire the ingenuity and elegance of Mr. Fisher's mathematical work, but we cannot help recollecting Prof. Huxley's warning, that mathematics is like a mill, and that what you get out of it depends entirely on what you put in. Mr. Fisher puts in a supposition made by Sir W. Thomson, as to the way in which the earth cooled. There have been people bold enough to think that in making this supposition a great master of physics for once lent his name to an hypothesis which is in itself physically not very probable; and these same people are inclined to hold that probably Mr. Fisher's calculations tend to show that this is the case, rather than that the contraction hypothesis is inadequate.

Capt. Dutton, of the United States Geological Survey, is another doughty opponent of the contraction hypothesis. His notion as to what that hypothesis is appears in the following passage, which is quoted in the volume before us (p. 126, note):—

"The line of argument which is relied upon to sustain a cooling globe proves, when pushed to its consequences, that the great interior of the earth has not as yet undergone any sensible amount of cooling. The only cooling which that argument admits of has been located in a thin external shell. . . . In short, the cooling would be only skin deep, while the nucleus is about as hot as ever."

This may be called "pushing an argument to its consequences"; but if it be, that phrase certainly means, in

plain English, putting, of course unintentionally, into your opponents' mouths, statements which they never made. If it is asserted that the crust cools faster than the nucleus, which is all the supporters of the contraction hypothesis ask for, is this the same as saying that the nucleus does not cool at all?

Now Mr. Mellard Reade joins the attack, and in an elaborately illustrated volume of some 300 pages gives us his reasons for dissenting from the contraction hypothesis, and for preferring a modified form of the explanation put forward originally by Scrope and Babbage. These geologists pointed out that whenever a great thickness of sedimentary deposits was laid down the subterranean surfaces of equal temperature would necessarily rise, the increase in temperature would cause expansion, and as a result of this a rise in the surface would follow. Mr. Reade maintains that vertical elevation would not be the only result, but that pressures would be set up in the mass competent to produce folding, contortion, inversion, crushing, and all the violent disturbances which are found in mountain-chains and other disturbed portions of the earth's crust.

The book has two merits: it takes nothing for granted, and it does not err on the side of assuming too much knowledge on the part of its readers. But it is a question whether virtue may not run to excess, and there is reason to fear that this has been the case here, for a very large part of the volume is taken up with the establishment and illustration of physical facts of the most elementary character, and of geological truths which are to be found in every text-book. For instance, Chapters III. and IV. are devoted to the establishment of the facts that metals and stone expand when their temperature is raised; that, when they are prevented by constraint from relieving themselves by lateral expansion, they buckle up; and that if their elasticity, or, as the author prefers to call it, their tensile strength, is small, they do not return to their original shape on cooling. The cases quoted, and the experiments which are illustrated by six full-page plates, are apt and to the purpose; they would be admirably suited for illustrating class-teaching in an elementary school. But it is hard to believe that any one could have seriously thought they would be required by the class of readers to whom the book is presumably addressed.

Chapter V. opens with the statement that "It has been a subject of remark and wonder to more than one eminent geologist that all the greatest mountain ranges are, geologically speaking, so comparatively modern." A broad generalisation like this deserves to have stress laid upon it, but it has been so long one of the common truths of geology, that it has ceased to be, if it ever was, a source of wonder to any one who has an elementary knowledge of the science. Indeed, there is an air of *naïve* surprise running through the book which now and again moves a kindly smile as we read, and we feel it refreshing to discover that truths, which have grown somewhat hackneyed to the majority of geologists, still retain a certain charm of novelty for the author. Thus Mr. Reade seems in more than one passage to take a little credit to himself for having discovered that what are generally called "anticlinals" are really elongated ellipsoidal domes—a fact which is rapidly brought home to any one who happens to work for a few weeks in a

country where the rocks are moderately folded, and which was insisted on and fully illustrated in a manual of geology published fourteen years ago, and then could hardly have been said to be new. The distinctive characters of mountain chains are treated of in the same spirit. Little, if anything, is here added to the masterly summary of these characters which Dana gave us years ago, but much space is taken up with illustrations of truths which every one admits, in the form of long quotations from sundry sources. All this speaks to much reading and patient industry, and we cannot but admire the conscientious care with which Mr. Reade has striven to inform himself of all that has been said and done on the subject of which he is treating; but we cannot help asking ourselves whether it was necessary to print at length the contents of his note-books. This accumulation of evidence, where it is not needed, has brought with it an attendant evil: it has swelled the book to an undesirable size. Now in these busy days, and in the interest of readers, if there is one thing against which, more than anything else, a resolute stand ought to be made, it is unnecessary printing. The day is yet far distant when every page of printed matter shall contain something that is new, and nothing that is not new; but this is the impossible ideal, the asymptotic consummation, which all writers should ever keep prominently in view.

But we would not press this point, because, even if the author has given us rather an excess of matter that is not new, what he has given is good of its kind; and it is of more importance to weigh his arguments against the contraction hypothesis, and in favour of the Scrope-Babbage explanation with the additions he suggests to it. Holding as he does that expansion by heat is the main factor in producing the disturbances of the earth's crust, he made experiments to determine the coefficients of expansion of sundry rocks. He arrives at a mean which agrees very nearly with that found by Mr. Adie. Mr. Reade's experiments ranged from temperatures of 60° to 220° F., and he assumes that the coefficient of expansion will be the same for the enormously higher temperatures with which he has to deal when considering the case of the earth—a risky proceeding, to say the least. But he has fallen into a far more serious mistake: he has assumed that rocks weighted with a thickness of twenty miles of overlying strata will expand to the same extent for a given increase of temperature as rocks under atmospheric pressure. The oversight involved in this assumption so thoroughly vitiates all his numerical results that no conclusion can be drawn from them.

In Chapter XI. we have the objections to the contraction hypothesis succinctly stated. The numerical results we put aside for reasons just given, but in his general argument the author does not seem to us to realise the full meaning of the hypothesis. He seems to hold that according to the contractionists crumpling is produced by unequal contraction *in the solid shell itself*, which certainly is not their view. And he entirely omits all reference to the one fact which is the life and soul of the hypothesis, that the earth's crust is not strong enough to stand by itself without support, a fact which admits of rigid mathematical demonstration. It is a decided case of a seriously mutilated representation of the play of "Hamlet."

We cannot therefore admit that Mr. Reade's arguments are very damaging to the hypothesis against which they are directed; and we cannot see how expansion due to rise of temperature could alone produce the results which he attributes to it. The strains produced in this way would tend to be relieved by yielding in the direction of least resistance—that is, vertically; and if there were no impediment to the perfect transmission of strain, the yielding would be wholly in this direction. In the actual case a certain amount of deformation would doubtless be produced within the heated mass itself, but hardly enough, it would seem, to cant over a huge anticlinal, and lay it nearly flat on its side. The machinery invoked by the contraction hypothesis may or may not have been the means by which such overthrusts were brought about, but it is the only machinery yet suggested which seems competent to produce them. "Seems," we say throughout, for the question between rival hypotheses is as only one of probability.

And we think no one will contend that the Scrope-Babbage hypothesis ought to be entirely put on one side when we speculate on the cause of earth-movements, great broad folds, such as those of the plateau-region of Utah, described by Capt. Dutton, and figured on Plate 39 of the book, may have been caused by the bulging up of heated masses below, though they can be explained equally well by the contraction hypothesis.

It remains to notice that the book is rich in figured illustrations. A number of the plates are devoted to somewhat diagrammatic landscapes of contorted rocks, and these bring out well the points they are intended to illustrate; but they do not add to the stock of our knowledge. They would be serviceable to a geologist, if such a one there be, who had never stirred out of the fen-country, but he of course would do still better if he took an excursion ticket to some of the localities from which the views are taken.

A. H. GREEN

ORGANIC EVOLUTION

The Factors of Organic Evolution. By Herbert Spencer. (London and Edinburgh: Williams and Norgate, 1887.)

MR. HERBERT SPENCER has done well to reprint in a permanent form his two articles on the "Factors of Organic Evolution," which were published last year in the *Nineteenth Century*; for, although they present substantially the same doctrines as are to be met with upon this subject in his "Principles of Biology," they do so in the light of fuller knowledge and more matured judgment.

The object of the essay is that of taking stock, so to speak, of natural selection as compared with other "Factors." Mr. Spencer's treatment of this subject is admirable, and ought to be read by all working naturalists who have any interest in the problems of evolution. The literature of Darwinism has now become so extensive that even first-rate naturalists who are engaged on other lines of work are apt to get left behind, or, with respect to Darwinism, themselves to become examples of what are now called "vestiges"; their ideas are the superseded survivals of some previous phase of evolutionary science. And most of all is this true with regard to the funda-

mental question so ably discussed by Mr. Spencer. As he remarks, "Nowadays most naturalists are more Darwinian than Mr. Darwin himself," by which he means that most naturalists attribute more to the agency of natural selection than was attributed to it by the final judgment of its discoverer. The reason of this is that most naturalists have neither read with any care the later editions of Mr. Darwin's works, nor probably even so much as heard of the sundry essays which led him to modify his views upon the comparative importance of natural selection and other factors of organic evolution. Such naturalists, therefore, are not true Darwinians. Still believing in natural selection as almost the only factor of organic evolution, they are archaic enough to suppose that distinctions of specific value are almost universally of an adaptive kind. In this respect, indeed, they share what is no doubt still the popular impression of Darwinism, but an impression, nevertheless, which does a great injustice to the genius of their master. In order that there may be no mistake upon this matter, we will here supply a few quotations from the latest editions of Mr. Darwin's works, over and above the numerous extracts which Mr. Spencer has selected for the same purpose.

"I now admit, after reading the essay by Nageli on plants, and the remarks recently made by various authors with respect to animals, more especially those recently made by Prof. Broca, that in the earlier editions of my 'Origin of Species' I perhaps attributed too much to the action of natural selection, or the survival of the fittest. I have altered the fifth edition of the 'Origin' so as to confine my remarks to adaptive changes of structure; but I am convinced, from the light gained during even the last few years, that very many structures which now appear to us useless will hereafter be proved to be useful, and will, therefore, come under the range of natural selection. Nevertheless, I did not formerly consider sufficiently the existence of structures, which, so far as we can at present judge, are neither beneficial nor injurious; and this I believe to be one of the greatest oversights as yet detected in my work." ("Descent of Man," 2nd edition, p. 61. He goes on to explain how he was led to the "tacit assumption that every detail of structure, excepting rudiments, was of some special, though unrecognised, service," and concludes by remarking that "any one with this assumption in his mind would naturally extend too far the action of natural selection.")

"In the earlier editions of this work I underrated, as it now seems probable, the frequency and importance of modifications due to spontaneous variability" ("Origin of Species," 6th edition, p. 171). "It appears that I formerly underrated the frequency and value of these latter forms of variation, as leading to permanent modifications of structure independently of natural selection. But as my conclusions have lately been much misrepresented, and it has been stated that I attribute the modification of species exclusively to natural selection, I may be permitted to remark that in the first edition of this work, and subsequently, I placed in a most conspicuous position—namely, at the close of the Introduction—the following words: 'I am convinced that natural selection has been the main but not the exclusive means of modification.' This has been of no avail. Great is the power of steady misrepresentation; but the history of science shows that fortunately this power does not long endure" (*Ibid.* p. 421).

"When, from the nature of the organism and of the conditions, modifications have been induced which are unimportant for the welfare of the species, they may be, and apparently often have been, transmitted in nearly the same state to numerous, otherwise modified, descendants.

. . . A structure, whatever it may be, which is common to many allied forms, is ranked by us as of high systematic importance, and consequently is often assumed to be of high vital importance to the species. Thus, as I am inclined to believe, morphological differences, which we consider as important—such as the arrangement of leaves, the division of the flower or of the ovarium, the position of the ovules, &c.—first appeared in many cases as fluctuating variations, which sooner or later became constant through the nature of the organism and of the surrounding conditions, but not through natural selection; for, as these morphological characters do not affect the welfare of the species, any slight deviation in them could not have been governed or accumulated through this latter agency" (*Ibid.* pp. 175, 176).

These quotations are added to those which have been supplied by Mr. Spencer, in order still further to advance the "motive" with the expression of which his essay concludes. After directing attention to the present views of Prof. Huxley upon the subject—viz. "How far natural selection suffices for the production of species remains to be seen"; and "Science commits suicide when it adopts a creed"—Mr. Spencer closes with the following remarks:—

"Along with larger motives, one motive which has joined in prompting the foregoing articles has been the desire to point out that already among biologists the beliefs concerning the origin of species have assumed too much the character of a creed; and that while becoming settled they have become narrowed. So far from further broadening that broader view which Mr. Darwin reached as he grew older, his followers appear to have retrograded towards a more restricted view than he ever expressed. Thus there seems occasion for recognising the warning uttered by Prof. Huxley as not uncalled for. Whatever may be thought of the arguments and conclusions set forth in this article and the preceding one, they will perhaps serve to show that it is as yet far too soon to close the inquiry concerning the causes of organic evolution."

Of these two articles the first is devoted to a consideration of use and disuse as causes of such evolution, while the second treats of the influence of surrounding conditions. The latter is the more highly speculative, and therefore may be here considered in fewer words. The idea is that all external parts of organisms, being exposed to different physical conditions from the internal parts, must be differently affected thereby: natural selection apart, there must here be recognised the differentiating agency of a direct or purely physical kind. Hence a certain rough analogy is drawn between a cell-wall, or cuticle, and the oxidised exterior of an inorganic body. Many of the differentiations undergone by the epiblast in the course of organic evolution may, it is argued, be best explained by the immediate action of external agencies—just as we know that a surface of mucous membrane, when brought into permanent relation with such agencies, changes from cylinder epithelium to squamous epithelium: "the effect of the medium is so great that, in a short time, it overcomes the inherited proclivity, and produces a structure of opposite kind to the normal one." Many other examples of the same general principle are given; but the essay as a whole is ingenious rather than convincing. Not, of course, that we dispute the principle—which, indeed, is recognised by Mr. Darwin, in one of the passages above quoted, and elsewhere—but it is of too general a kind to

admit of being clearly traced in particular instances, where we have to do with all the other elements in the complex of living material.

The main question, however, with which Mr. Spencer is concerned is as to the place which should be assigned to use and disuse as factors of organic evolution. This long-standing question is one of fundamental importance to the whole philosophy of evolution; and as it has now reached a critical phase, the publication of Mr. Spencer's essay furnishes a fitting opportunity for considering its present position in all its bearings. This, therefore, we shall endeavour to do at an early date, in the form of a general article dealing with all the more important literature upon the subject. GEORGE J. ROMANES

TEXT-BOOK OF BRITISH FUNGI

An Elementary Text-book of British Fungi. By William Delisle Hay, F.R.G.S. Royal 8vo, cloth, illustrated. (London: Swan Sonnenschein, Lowrey, and Co., 1887.)

WE have little sympathy with such publishers as produce books written "to order" for the purpose of utilising illustrations, or matching. Still, we cannot help feeling some sympathy with, and pity for, the poor unfortunate who is called upon to perform such an unthankful office as the preparation of "copy." In so far as the book before us corresponds with such conditions our author commands our sympathy, perhaps he deserves it, for even in the preface he seems to fall on his knees, and sue, *in formâ pauperis*, for pity from readers and critics alike. There is doubtless a history connected with this volume. The woodcut blocks which accompany the text, but do not illustrate it, formerly did duty in the "Hand-book of Fungi" published more than fifteen years ago. In the way of business they were transferred, and, in order to utilise them, the "Text-book" seems to have been projected. There are 64 pages of figures and 238 pages of letterpress, but only about 16 pages of the plates have anything to do with the letterpress, and are not even mentioned, so that there are no less than upwards of 40 plates which are supplementary to the letterpress, and have nothing whatever to do with it, except to increase the bulk of the book. We do not know what purchasers would expect to meet with in "an elementary text-book of British fungi," but we suspect that they would scarcely be satisfied with a "treatise on edible and poisonous fungi," or, as set forth in the preface, an attempt "to cover as comprehensively and accurately as possible the entire subject of fungi, considered as aliment." Indeed, it would have been more correct to call this "An Elementary Text-book of some Species of British Fungi."

The professed object of this book, in so far as its writer was concerned, was to present a guide, which above all things should be safe and trustworthy, on the subject of fungus-eating—"so far as toadstool-eating goes," he writes, "I believe I have a right to speak with authority"—and hence if this professed object is not attained, the book must be confessedly a failure. "For the most part," he says, "subsequent authors have added little to what Dr. Badham had advanced." The inference must be that

he was ambitious of making a considerable advance, "directed and inspired by a wide acquaintance with mycological literature." After this spontaneous confession it is surprising to find him stating as a fact that "some four hundred and fifty species of the genus *Agaricus* are recorded as occurring in Great Britain," on the faith of a work published now sixteen years ago; his knowledge of mycological literature having stopped short of the fact that nearly 700 species have already been figured, and the latest work on British fungi records 782 species as British, so that the total is nearly double that which his "wide acquaintance with mycological literature" had revealed to him. Leaving, however, such trivial details, let us turn to the "Comprehensive Catalogue of Esculent British Fungi." The first thought is naturally one of order. To assist in reference, and in producing favourable results, one would have hoped to see some method in the grouping of the 221 supposed esculent species. Scientific method there is none, for the white-spored, pink-spored, and brown-spored *Agarics* are jumbled together in glorious confusion. This would be tolerable if in compensation the species had only been grouped in sequence, or in sections according to their esculent value, but even this has not been done. In two or three instances, however, the species of a given genus are classed in the alphabetical order of their specific names.

Space will not permit of our remarking upon all the individual species included in this miscellaneous list of fungi recommended for common consumption by one who "believes he has a right to speak with authority." For ourselves, we should not have recommended *Agaricus asper*, for with considerable experience we do not remember to have met with it but once in thirty years; nor *Agaricus caesareus*, for we venture to declare that it has never been found in the British Islands at all, and the same must be said of *Polyporus corylinus* and *Polyporus tuberastrer*. Why, then, are they included in a "Catalogue of Esculent British Fungi"? Worse still—because far more dangerous—why are such species included as *Agaricus sinuatus*, which nearly killed Mr. Worthington Smith, and *Lactarius piperatus*, *Lactarius turpis*, and *Lactarius torminosus*? If there are such things as dangerous fungi at all, these are of them. If this writer is really acquainted with these species, and pronounces them edible, let him eat them and enjoy them, but not recommend them to an unsuspecting public. It is our firm and conscientious belief that a book which seriously recommends such things as articles of food might produce calamitous results, if widely circulated, or even, if not, in the event of other books or journals repeating upon its authority that these may be eaten. We read in the preface these significant words: "It has never been my privilege, as yet, to meet with any person versed in mycology from whom I could derive instruction." When the writer meets with such persons we advise him to propose to them an experiment in eating *Lactarius piperatus*, or *Lactarius torminosus*, or even *Agaricus sinuatus*, and we rather fancy that such mycologists will have but little faith in his practical mycology. We sincerely hope that he will not meet with "persons versed in mycology" for the first time in a coroner's court, over a case of poisoning induced by his recommendations. It would have given infinitely more satisfaction, and been far safer for his reputation,

had the list of esculent fungi been confined exclusively to species known to be good eating and worth the trouble of collecting, excluding such minute species as *Agaricus clavus*, and *Agaricus esculentus*, and *Agaricus griseus*, with a cap as large as one's little finger nail, and a stem but little thicker than a horsehair, and including *Agaricus elvensis* and *Agaricus hemorrhoidarius*, with a few others, large, fleshy, and as safe and delicious as the finest mushroom ever cultivated. But perhaps, though known to mycologists, they were disregarded by the writer of the "Text-boo'k," or contemptible in his eyes beside such delicacies as *Agaricus sinuatus* and *Lactarius piperatus*. Perchance some mycologist, hesitating whether to purchase or not, may read this notice. Let us state for the information of such a one that the hard, woody *Polyporus fomentarius*, which grows on old trunks, and the equally well-known *Polyporus squamosus*, are with all seriousness and gravity introduced into the "Catalogue of Esculent British Fungi;" that the excellent *Agaricus sylvaticus*, which we are only too glad to get the chance of eating, is condemned to the "Catalogue of Poisonous British Fungi," together with *Agaricus lacrymabundus*, which is at least a considerable ingredient in the modern "mushroom catsup," as sold in the shops; and, if he seeks further evidence of "vast experience," he will find it in the novel information that *Agaricus mucidus* is rare, that *Cortinarius cinnamomeus* may be used as a substitute for cinnamon, that the difference between *Agaricus giganteus* and *Agaricus maximus* is only nominal, that *Lactarius subdulcis* is easily confounded with *Lactarius rufus*, that *Lactarius camphoratus* smells of camphor (when?), and that *Russula decolorans* is common under beeches and is "a good comestible."

Finally, we must protest against the wholesale manufacture of new names, many of them barbarous enough, and some of them ridiculous, under the vain supposition that they will become popular names for the species of edible and poisonous fungi. The old "fairy-ring champignon" is to be called the "oread," the common mushroom is the "white pratelle." The *Russula emetica* is "the sickener," and *Russula fragilis* is the "sickener's sister." In one place we are told "how to prepare parasols," but not whether this includes umbrellas, or whether it is based on the principle that "it's never too late to mend." Earnestly we hope it is, for there is vast scope for amendment in this book, and the sooner it is commenced the better. As it stands, it is difficult to determine whether it should be classed with comic literature, novels, or ancient history.

M. C. C.

OUR BOOK SHELF

The Structure and Life-History of the Cockroach (Periplaneta orientalis). An Introduction to the Study of Insects. By L. C. Miall, Professor of Biology in the Yorkshire College, Leeds, and Alfred Denny, Lecturer on Biology in the Firth College, Sheffield. (London: Lovell Reeve and Co., 1886.)

THIS volume forms the third of a series of studies in comparative anatomy, the object of the authors being to lead the student, by the investigation of some one animal form, to an interest in, and a comprehension of, other

kindred forms. While it will be generally conceded that this is a sound method of research, it is evident that its success will very much depend on the special forms selected, and we think that it may be open to some doubt whether, in selecting the cockroach for an introduction to the study of the Insecta, the authors have not selected a too little specialised form, since they have been obliged to omit the investigation of so characteristic a feature of insect life as that of metamorphosis. Nevertheless, they have given us a very fully detailed and interesting account of an easily obtained insect, and we hope it may be the means of encouraging many others to follow up the subject for themselves. As an introduction to this volume, we have a short account of the writings of those wonderfully patient pioneers in the field of minute anatomy—Malpighi, Swammerdam, Lyonnet, and Straus-Durckheim. This is followed by a sketch of the zoological position and the life-history of the cockroach. In this latter there is a brief record of the internal parasites of this insect—a record that might be greatly extended. The chapters on the outer skeleton, the myology, the neural system, the alimentary canal, and the organs of circulation and respiration, are well written and illustrated. The section relating to the respiratory movements of insects is written by Prof. Felix Plateau; that on the embryonic development, by Joseph Nusbaum, who very pertinently remarks that the inexperienced embryologist will find it more profitable to examine the eggs of bees, of Aphides, or of such Diptera as lay their eggs in water. Indeed, the difficulties in the way of the investigation of the eggs of the cockroach are so great that even the author has had to pass over the early stages of segmentation. A chapter on the cockroach of the past, from the able and experienced pen of Prof. S. H. Scudder, concludes a volume which, though not exhaustive of its subject, nor yet quite even in its treatment of all the branches of that subject, may be placed with the greatest safety and advantage in the student's hands. The authors tell us, in their preface, that, from the description of the cockroach in Huxley's "Anatomy of Invertebrated Animals," came the impulse which has encouraged them to write the present work. We hope that it will in its turn encourage many another to undertake equally honest researches.

The Administration Report of the Meteorological Department, India, 1885-86.

MR. BLANFORD'S Report, as usual, gives a good account of work. It commences with the actinometric observations. The records from Leh for twenty-three months were not found to be as valuable as had been expected, the climate having turned out unfavourable. The results have been sent home to the Solar Physics Committee, and meanwhile the observations are being continued at Dehra Doon and Mussooree, under the superintendence of Colonel Haig.

In the matter of forest observations, considerable activity is recorded; pairs of stations, on the system devised by Ebermayer for Bavaria, have been established at Dehra Doon and Ajmere. These observations have, however, been going on for too short a time for the results to be worth quoting, but much is to be expected from these investigations in India.

Mr. Blanford gives an account of his forecast of the character of the monsoon rains of 1885 from the character of the Himalayan snowfall, and he shows that the facts fully carried out his theory. The Report goes on with a brief notice of the theory of the South-west Monsoon, which, Mr. Blanford says, he is in a position to show, by his forthcoming Indian Ocean wind-charts, is not the South-east Trade simply drawn across the equator.

The remainder of the Report is occupied by details of the observational system, which seems to be in a good state of efficiency.

LETTERS TO THE EDITOR

[The Editor does not hold himself responsible for opinions expressed by his correspondents. Neither can he undertake to return, or to correspond with the writers of, rejected manuscripts. No notice is taken of anonymous communications.]

[The Editor urgently requests correspondents to keep their letters as short as possible. The pressure on his space is so great that it is impossible otherwise to insure the appearance even of communications containing interesting and novel facts.]

Mr. Romanes on Physiological Selection

I HAVE just seen Mr. Romanes's article in the *Nineteenth Century*, and his letter specially replying to myself in your issue of January 13 (p. 247). I do not propose to continue the discussion, but ask leave to make a few observations on some features of his reply in both the article and the letter.

On the question of the "inutility of specific characters," he appeals to authority against me, and especially to Darwin's very cautious remarks, which seem to me to support my view much more than they do those of Mr. Romanes; but in any case this is a matter in which I decline to accept authority as an infallible guide. The impossibility of proving a negative is proverbial, but my opponent declares that his negative—the uselessness of specific characters—wants no proving. It must be accepted till in every case the affirmative is proved. Here, again, is a canon of criticism the validity of which I wholly deny.

As to the swamping effects of intercrossing, there is again an appeal to authority, and Mr. Romanes now explains away (in the *Nineteenth Century*) what he had said about "simultaneous variations," by asking me to show such variations as the occurrence of an incipient spur on a duck's foot or horn on the head of a racehorse, in the belief, apparently, that these are the class of characters which are distinctive of closely-allied species! Such a demand, seriously made, appears to me so preposterous as to render further discussion of the matter with such an adversary out of the question.

The argument to show that the supposed physiological variations would be perpetuated, seems to me as weak and unsatisfactory as ever. The question is really not worth further discussion till the required variations are proved to exist in the requisite abundance and possessing the peculiar relations to each other and to the rest of the species which would alone give them any chance of survival.

I now leave the question, as between myself and Mr. Romanes, to the consideration of those naturalists who may be able to bestow upon it the requisite time and attention.

ALFRED R. WALLACE

Washington, U.S.A., January 30

Instantaneous Shutters

IN reference to the interesting paper by Mr. Malloué in *NATURE* (February 3, p. 325), I quite agree with him in his condemnation of a drop-shutter of any form.

But I would point out a form of shutter that I have myself found of the greatest value—one, namely, working horizontally across the lens. It has the very great advantage in landscape work that it can carry an aperture of this form ∇ or any modification thereof, the advantage gained thereby being that the sky receives a far shorter exposure than the foreground, a point of much importance in landscape photography. The ∇ piece is loose, and any shape cut out of black cardboard or paper can be inserted. Of this power I have frequently availed myself when photographing snow-clad mountains.

The shutter can be made to pass across the lens at any speed, from the most instantaneous flash to slower motions, and it has the further advantage of working immediately behind the lens—the proper place, I think, for a shutter.

H. STUART-WORRELEY

South Kensington Museum, February 4

Svastika Cross and Sun

Is there any evidence that the *svastika* represents the sun? and is it not a simple conjecture? (*NATURE*, February 10, p. 345).

The *svastika* 卐 is a complex emblem, and there is a possible origin which has not been investigated. It decomposes into

two L , and this is a character to be found extensively distributed throughout the syllabic and alphabetic systems. If L is a symbol for man and fish, it will not be related to sun immediately.

The theory of Mr. Haliburton and others, and mythological conformity, give the cross or Tau as naturally derived from the Pleiades, and not from the sun. The cross is also a symbol for the nose in prehistoric sculpture.

HIVDE CLARKE

32 St. George's Square, S.W., February 12

Life-Energy, or the Dynamics of Health and Disease

SINCE it is admitted that matter is indestructible, it is obvious that life can be only the manifestation of that energy which is set free by the reduction of compounds embodying more energy to states of combination which embody less energy.

Life therefore is the result of the continuous interchange of partners between the compound molecules constituting chemical and organic compounds.

"In any transformation which takes place without the application, or the giving out, of work, the heat developed is the equivalent of the excess of the original over the final potential energy due to the chemical affinities involved; the final state of every combination is that in which the potential energy of chemical affinity is a minimum" (Lait).

If these words formulate the law which governs those combinations of elementary substances known as inorganic compounds, how much more must they refer to the combinations of the same elementary substances which go to form organic compounds?

Life thus becomes an expression for the sum of the difference between the original potential energy of the food and the final potential energy of the excretions. All change in the configuration of matter, whether physical or chemical, must be accompanied by either the evolution of, or the absorption of, energy.

Energy, as far as is known, has but one source, the sun.

Whether that energy act by direct impingement of solar rays producing the ascending scale of effects from genial warmth to fatal stroke, or whether it be second-hand, from the decomposition of vegetable matter, or third-hand, from the decomposition of animal substances which obtained it from vegetable substances its origin is still the same.

Assuming then the universality of this energy, which shows itself in all the intangible forms of life, and growth, and all organic change, it will be the effort of the writer to adduce evidence to prove that much which is still mysterious in both health and disease is due to its subtle action too.

The vibrations of direct solar energy which fall upon the optic nerve give rise to those molecular disturbances which produce the subjective sensation of light.

Physical change is thus originated by an immaterial agent. Work is done, and cannot continue to be performed without renewal of the material acted on.

But when the vibrations of direct solar energy fall upon the tissues of a growing plant, energy is incorporated into those tissues. This energy so attunes the atomic vibrations in the plant molecules as to bring them into combining harmony with the carbon and hydrogen atoms present in the forms of carbonic acid and water.

The hydrocarbon compound, starch, is formed, and embodied within itself the energy which made it starch.

Each molecule of starch maintains its individuality as starch only so long as it retains within itself that solar energy under the influence of which it became starch; as soon as part of that energy is lost the starch is degraded to its original condition of carbonic acid and water. Yet that energy which works such molecular miracles is sought for among the products of decomposition in the form of heat only, and if not recognisable as such is put out of count in the world's work.

While it is thus evident that the vegetable kingdom lives a constructive life, storing up energy from an extra-terrestrial source, it is equally demonstrable that the animal kingdom lives a destructive life, unable to add aught to the sum of energy required for the work of the planet. Consequently an approximate expression for the value of the energy incorporated in the plant may be found in the work done, as a result of its consumption, by the animal.

4500 grains of plant carbon are daily excreted by every average man in the form of carbonic acid. Carbon and oxygen independently embody a greater sum of original energy than

found in the compound formed by their union; therefore the result of their combining together must be a loss of energy: the value of this energy is estimated by the heat evolved. The heat recognisable on the combination of 4500 grains of carbon with the required equivalent of oxygen amounts to 118 units, and represents in foot-pounds the raising of 40 tons one foot high.

Such, then, is the enormous supply of solar energy obtained by a man when he compels the elementary atoms of carbon and oxygen to enter into a combination of greater stability and less energy, and to surrender their surplus energy that he may live.

But the converse of this is also true, viz. that when a plant proceeds to utilise this carbonic acid for the reproduction of 4500 grains of carbon, it can do so only by obtaining from some external source energy equivalent to the raising of 40 tons one foot high and adding this to the rates of vibration already existing in the carbonic acid. Thus the condition of energy of the carbonic acid is altered till finally the oxygen and carbon atoms are compelled to dissociate themselves and to resume their elementary forms of less stability and greater energy. They then become available for plant assimilation, and fix in its tissues the energy which forced them apart.

If, then, the union of oxygen and carbon in the human body sacrifices such energy that man can live thereby, is it not obvious that under whatever circumstances that union takes place the same energy must appear? If that be so, the question must arise whether in estimating the effect of vegetable decomposition upon the health of man too much notice has not heretofore been taken of the carbonic acid and kindred stable products given out, and too little attention paid to the energy evolved,—in fact, whether from the surface of every seething swamp there be not poured forth streams of that powerful energy which originally fed the growing plants, and which when eliminated within the body of man is known by the name of Life. To assume that such energy is powerless is to assert that the mother's heat is not the force that hatches out the egg.

That the theory which attributed all noxious influence to the gaseous resultants of decomposition did not satisfy the requirements of science is shown by the greedy acceptance of the germ theory which now prevails. But this, after all, is but coming one step nearer to the action of that universal energy which is the inseparable concomitant of all material interchange. For has not Dr. Burdon Sanderson well said, "Bacterial life is a middle term between chemical antecedents and consequents"? They reduce all unstable compounds in the world to final stable products, and live with vigour or in apathy in proportion to the effect upon themselves of the energy evolved from the medium they destroy. Thus, too, is produced much of that form of secondary energy recognised as heat of decomposition, and while this heat is known to possess marvellous influence over vegetable germination it has up to the present been credited with but little action on the life of man.

The gaseous consequents and the bacterial agents have borne the blame of every human ill, while that energy which ruled the universe before the first vegetable cell had varied towards animal functions is allowed to go unchallenged.

If, then, suspicion can be legitimately directed towards this heat as a factor in physiological change hitherto overlooked, it becomes necessary to pursue the subject of heat in all its latest developments.

Dr. Doherty, in his "Organic Philosophy," says: "Light is nothing but the velocity of a force which in slow motion is called heat." From the facts that are known in relation to light it may be possible to deduce by analogy much that is yet unproven with regard to heat.

It has been shown that light consists of certain colours which, when taken together, produce the sensation of light; each of these colours acts upon certain specialised molecules of the optic nerve and not upon the remainder, just as Professor Tyndall has shown that the invisible heat rays, "powerful as they are, and sufficient to fuse many metals, can be permitted to enter the eye and to break upon the retina without producing the least luminous impression."

May it not therefore be inferred that heat consists of a series of velocities of force which when taken together produce the sensation of heat, yet each of which is capable of acting upon certain specialised molecules of the nerves of sensation, while being unperceived by the remainder?

Light has been proved by Captain Abney to be the visible velocities of wave-lengths from 38,000 to the inch to 60,000, and within this range from 38,000 to 60,000 to the inch all the varied

sensations of colour are produced; nevertheless, by the higher velocities, from 60,000 to 120,000 wave-lengths to the inch, the great chemical actions of the world are performed. Is it not evident, then, that if the recognition of wave-lengths from 38,000 to the inch and upwards depended solely upon the subjective sensation of light all appreciation of them must cease at the 60,000 wave-lengths, and that the great powers of the ultra-violet wave-lengths must have remained in darkness for ever?

But Captain Abney has also shown that there are measurable wave-lengths extending downwards from 38,000 to 10,000 to the inch; if, therefore, these are credited with such action only as is recognisable by the subjective sensation of heat, is it not equally possible that powerful influences which change for good or ill the configuration of the molecules of the nerves of sensation may be left unregistered?

It is therefore allowable to infer from this analogy that in the dark region descending from the fading red to the cold of zero there may be many rates of velocity, some of which, harmonising with some phase of life, produce the most potent physiological effects without at the same time exciting the molecular resistance which corresponds to the sensation of heat.

In other words, is it not probable that in estimating the actions of the forces of Nature upon the animal system some most subtle influences have been overlooked because unrecorded by the index of the thermometer?

Profes or Tait says: "The energy of vibrational radiations is a transformation of the heat of a hot body, and can be again frittered down into heat, but in the interval of its passage through space devoid of tangible matter, or even while passing unabsorbed through tangible matter, it is not necessarily heat." And Mr. Pattison Muir in his work on "Thermal Chemistry" asks: "Must all energy which is lost by a changing chemical system during a definite operation make its appearance in the form of heat? Energy appears in chemical operations in forms other than that of heat, electrical energy for instance; we must distinguish in chemical processes between that part of chemical energy which is freely changeable into other forms, and that which can leave the system only in the form of heat."

The most recent researches thus point to the probability that while the bacterium carries on through Nature its never-ending work of reducing chemical antecedents to chemical consequents it must as continuously set free energy in forms other than that of heat.

One of the most pregnant discoveries made of late is that which demonstrates that, even in the case of the powerful friction requisite for boring iron, heat ceases to be recognisable as heat when the iron operated on is strongly magnetised; that is, that heat developed by friction in a magnetic field disappears in some form other than heat. By this the idea is suggested that heat energy impinging upon the sentient extremity of a nerve in action may be taken up and carried in a form other than heat to the central brain, just as sound is conveyed in a form other than sound across the interval between the telephone and the receiver; and if the multiple wave-lengths which produce the subjective sensation of heat can be thus transferred from the surface to the centre, why not fractions of that multiple which when taken together make the whole?

Since, then, science cannot specify the difference between the energy contained in dead carbonic acid and that of the living hydrocarbon, neither can it draw a line more definite than the equator between the series of decompositions which on the one side are termed life, and on the other are designated death. In each and all the compound descends from instability towards stability, and in every degradation is energy evolved.

Yet that energy, no matter in what companionship it may be found, or through how many existences it may have transmigrated, has still but one original source, and consequently it is impossible to conceive a condition in which that energy, primarily possessed of such "phenomenal modes of action," can be regarded as absolutely inert.

So far, then, it is claimed that grounds have been established for asserting that from the surface of every decomposing swamp forms of energy must be momentarily poured forth, the potency of which is as yet unknown.

Again, while it is at present impossible to isolate the fractions of energy the sum of which make heat, still it would contribute vastly to the proof of their independent existence if it could be shown that the nerves of sensation are specialised in sections, each reacting separately, to different gradations of heat.

This has been apparently accomplished.

"Dr. Goldscheider at a meeting on April 9 of the Physiological Society of Berlin discussed the action of menthol on the sensory nerves; he therefore concluded that the sensations in some places of cold and in other places of heat, produced by menthol, were purely subjective, and consequent on the direct stimulation of the special nerves of temperature, those usually cognisant of cold being far more sensitive to its influence than were those adapted to receive impressions of higher temperatures."—*Brit. Med. Journ.*, August 21, 1886.

Here, then, is strong evidence that the sentient nerve-endings over the surface of the body are graduated to respond to the various rates of energy that may impinge thereon; and if so, how can it be admitted that the varieties of energy by which these nerve-endings are stimulated must be limited to those already identified?

That some such idea has shaped itself in the minds of observers may be gathered from the independent opinions expressed by several of the members of the Cholera Commission of 1885.

Prof. Aitken sums up his valuable contribution in these words:—

"Some influence (as yet unknown, and therefore so far mysterious) seems to create in cholera times and places an epidemic activity. It is probable that this may be due rather to some meteorological condition—some peculiar state of the atmosphere, electrical or other—combined with unwholesome conditions of surroundings, and conditions of life; a co-existence of physical phenomena rather than anything in the individual. It is well known that electrical conditions such as prevail in a thunderstorm will cause milk to become sour, the formation of the acid being associated with, or due to, the formation of the bacterium lactis, and thus confined to very definite areas."

In the last paragraph lies the key to some of the foregoing mystery.

The mode in which to use it can be learned from the marvelous researches of Pasteur.

It is obvious that if the cause of sourness be the bacterium, the cause of greater sourness will be the bacterium still, and that the reason for the increased reduction by the bacterium of chemical antecedents to chemical consequents, which produces the additional sourness, must lie in some condition affecting the life of the bacterium too.

Pasteur has shown that a fundamental difference exists in the mode of action of the beer and grape ferments when "the introduction of the free oxygen of the atmosphere is permitted and when such introduction is prevented." When free oxygen is admitted, "the ferment shows an activity even more extraordinary than it did in the deep vats; the life of the ferment is singularly enhanced, but the proportion of the weight of the decomposed sugar to that of the yeast formed is absolutely different in the two cases: while, for example, in the deep vats a kilogramme of ferment sometimes decomposes 70, 80, 100, or even 150 kilogrammes of sugar; in the shallow troughs 1 kilogramme of the ferment will be found to correspond to only 5 or 6 kilogrammes of decomposed sugar. In other words, the more free oxygen the yeast ferment consumes the less is its power as a ferment; the more, on the contrary, the life of the ferment is carried on without the presence of free oxygen the greater is its power of decomposing and of fermenting the saccharine matter."

Here, then, is the clue to the cause of the increased sourness of milk during electrical conditions such as prevail in a thunderstorm. The bacterium lactis evidently finds itself in a situation in which the free oxygen of the atmosphere has, owing to some atomic disturbance in its molecules, become less available as an energy-provider.

The organism is consequently compelled to revert to the condition of the ferment in the deep vats, and to find in the increased decomposition of the constituents of the milk that energy which is necessary for its existence.

Further, it is known that electricity does affect the condition of oxygen, that the conversion of its molecules from the di-atomic to the tri-atomic state can be brought about by its influence, and that this latter state has been recognised as ozone.

If, then, it can be thus proved that the presence or absence of oxygen so materially alters the mode of existence of microscopic organisms, is it not reasonable to accept changes in the lives of the organisms as evidence of the altered condition of oxygen? and since certain conditions of free energy are thus found to interfere with the mode of nutrition of the minutest forms of life, can it be doubted that similar forces may exercise a material influence

upon the most complex being, who, after all, is but a larger multiple of the original protoplasmic element?

Thus it becomes possible that energy existing in forms other than those of light or heat exerts a power which has up to the present been ignored.

By this reasoning too, based on the altered mode of nutrition of the bacterium lactis during a thunderstorm, much that has been hitherto obscure in the history of the diseases, or blights, of the vegetable world becomes intelligible.

When it is found that all the bacteria lactis over a considerable area at the same moment change their mode of existence, and, from leading a comparatively sluggish life in the milk substance, suddenly break up almost the whole of that substance at a time when electrical disturbances are present, it is easily conceivable that in the case of potato-blight, which is almost invariably accompanied by obvious atmospheric changes, like conditions may arise; in fact, that the universally present bacteria, which, under ordinary circumstances, continue to exist without apparent injury to the tuber and leaves with which they are in contact, may, when driven by the stress of altered atmospheric conditions, turn upon the tissues of the plant for nutrition as the bacterium lactis upon the milk.

If, then, these effects of certain unrecognised forms of energy be established, it will go far to help the elucidation of the mysterious subject of cholera.

Dr. Bryden, from prolonged study of the cholera statistics of India, arrived at the following conclusions: "That the disease was endemic in the Soonderbunds, and that its cause was earth-borne and air-borne;"—to repeat the words of Prof. Aitken, "due rather to some meteorological condition, some peculiar state of the atmosphere, to a co-existence of physical phenomena;" and Deputy-Surgeon-General Marston has added: "Cholera spreads along rivers, but against their current in Bengal. It invariably advances from Bengal proper to the Himalayas, and never the reverse."

Here, then, are the conclusions arrived at by some of the most skilled observers on this subject.

It is thus admitted that cholera is endemic in the Soonderbunds, and that its track from thence lies in a north-westerly direction; that is, that its home is a surface of 12,000 square miles of decomposing tropical vegetation, and its direction that from whence the Ganges and its tributaries flow.

From this it may be inferred that its cause is such that it can be carried atmospherically, and that its course is the line of the least resistance.

Were the cause of cholera solid or liquid, it would doubtless long ere this have been demonstrated. Were it gaseous, it must follow the law of the diffusion of gases. What, then, remains to be sought for over the surface of the Soonderbunds? Naught but some form of that universal energy which fell as a sunbeam upon the growing plant, but which, when filtered through its substance, is evolved in a less vivid but still a potent form from its decaying structure.

That such returned energy has the power of incorporating itself with water, till it passes upward as a vapour, every steaming dung-heap shows; and in what prodigious force it can be again eliminated may be understood from the calculation of Prof. Haughton, that the condensation of vapour sufficient to afford one gallon of rainfall gives out sufficient heat to melt 45 pounds of cast iron.

From this may be estimated the enormous output of bottom heat which must day and night pass from a decomposing surface of 12,000 square miles to the vapour-carrying air above.

To comprehend the distance to which this energy may be transported before doing visible work it is only necessary to consider the Gulf Stream, which is described by Prof. Tait as "a vast convection current whereby the solar heat of the tropics is carried into the North Atlantic;" and to measure the work done thereby it needs but to weigh the luxuriant vegetation of the United Kingdom against the frigid barrenness of Labrador.

If, then, such vast stores of force can be transported from the tropics to England, it cannot be irrational to assert that from the surface of the Soonderbunds, and like places, much of the energy of decomposition must ascend with the rising vapour, and that whether drawn landward by the heated earth-surface, or pushed inward before the advancing monsoon, this vapour must follow the line of least resistance along the course of the river beds.

Again, when it is remembered how intense are the effects on

the nerves of the animal body of the chemical affinity evolved as electricity from a few square inches of decomposing zinc, it may well be contended that the energy of chemical affinity evolved from so great an area of decomposing organic substances cannot be innocuous, and that the fact of its action not being acknowledged by the subjective sense of feeling is no proof that it is non-existent.

Thus it becomes conceivable how the energy evolved in the Soonderbunds may, when vapour-borne across the interval, affect the inhabitants of Oude, and so alter the individual condition as to admit of local causes producing foreign effects.

Many of the most careful observers have asserted that malarious fevers arose from chill; yet, while this did not solve the question, it at least established one fact, that malarious fevers arose under circumstances which necessitated vapour condensation, one gallon of which would set free energy sufficient to melt 45 pounds of cast iron.

Familiarity with malaria will furnish many arguments in support of the contention that fever infection is at least coincident with vapour condensation. A boat's crew ashore at night on a West African station will often be affected, while those but a few miles seaward will remain exempt.

In the deep valleys of Zululand leading from the St. Lucia swamp, fever is contracted at a distance of many miles inland, while high ground much nearer to the swamp may be occupied with impunity. In the Terai, at the foot of the Himalayas, a night's sojourn brings to the unseasoned traveller certain fever, while a day journey is almost free from risk.

Since, then, the search for a material cause of cholera and of malaria has been as unsuccessful as if one sought a material cause for sunstroke, it may legitimately be suggested that, as the more rapidly fatal affection is the result of the action of direct solar energy upon the sentient nerve-endings, so the less rapid maladies may result from subordinate rates of the same energy acting upon subdivisions of the nerve-endings, which, as Dr. Goldscheider has shown, are specialised to respond to lower velocities of that force, and that the chill to which so many attribute the origin of fever is really the acknowledgment, by what Dr. Goldscheider terms "the special nerves of temperature usually cognisant of cold," of that obscure energy hitherto unregarded as a factor in the production of disease, but which the investigations of thermo-electricity may one day bring within the ken of man.

NATHL. ALCOCK

Military Prison, Dublin

THE CRUISE OF THE "MARCHESA" 1

THIS is one of the most interesting books of travel that it has been our good fortune to meet with for several years. Apart from its excellent maps and wealth of illustration, it commends itself by a charm of style not usually to be met with in works of this nature, and by the judgment shown in the narrative. Many countries were visited which lie in the well-beaten track of every tourist round the world, but these have not even been alluded to. The attention is riveted to the details of discoveries among little-known scenes, and sometimes in quite unexplored regions.

The *Marchesa*, an auxiliary screw schooner of 420 tons, Mr. C. T. Kettlewell, captain and owner, was commissioned in the Clyde in November 1881, and left Cowes on the 8th of the January following. She reached Colombo on April 24, having touched at Socotra and Oolegaum Island, one of the Maldivé group, on her way from Aden. From Ceylon she proceeded *via* Singapore to Formosa; and, coasting along the south-eastern side of Formosa, she visited the small Island of Samasana. While she was running nearer to the coast at Chock-e-day, the stupendous cliffs of this part of Formosa were seen rising, to a height of some 5000 feet, upright from the water's edge.

The little-known islands of the Liu-Kiu group were next visited. These lie some 250 miles to the east-north-east of Formosa; they are partially volcanic, and lie just north of the tropic. The account of the short sojourn at Napha,

¹ "The Cruise of the *Marchesa* to Kamschatka and New Guinea; with Notices of Formosa, Liu-Kiu, and various Islands of the Malay Archipelago," by F. H. H. Guillebard, M.A. M.D. (Cantab.), &c. With Maps and numerous Illustrations. Two Volumes. (London: John Murray, 1886.)

and of the wonderfully successful visit to Shiuri, the capital, where are the ancient palaces of the Liu-Kiu kings, will be found in Chapters II. and III. Some time was spent at Japan, then the yacht's head was turned northwards for Kamschatka, and on the morning of August 13, when the fog lifted, the sharp peak of Vilutchinska Volcano enabled them to steer for Avatcha Bay, within which lies the once well-known little harbour of Petropaulovsky.

"Avatcha Bay is one of the finest harbours in the world, if not actually the finest. Rio and Sydney have no mean claims for this position of honour, but those of us who had seen both were unanimous in awarding the palm to their Kamschatkan rival. A nearly circular basin of some nine miles in diameter, and within a narrow entrance opening to the south-south-east, it is roomy enough to accommodate the navies of the world. It is entirely free from dangers, has an even depth of ten or twelve fathoms, and owing to its affording excellent holding ground and being well protected from all winds it is perfectly safe in all weathers. But the ordinary traveller will be struck not so much with its nautical excellences as with the superb scenery with which it is surrounded. To the south rises the Vilutchinska Volcano, now quiescent, a graceful cone of about 7000 feet; and a little farther eastwards a huge flat-topped mass exceeding it in height by a thousand feet or more obtrudes itself, as a rare exception to the rule of cone-shaped mountains which seems to obtain throughout the country. It is nameless in the charts, for we are in the land of volcanoes and it is only 8000 feet in height! On either hand on entering are the two secondary harbours, Rakova and Tareinska—the latter nearly five miles in length—and within them again are others on a still smaller scale. Nature here at least has treated the mariner right royally. The iron-bound coast without may be as bad a lee shore as any skipper need wish to see, and the Pacific Ocean may too often belie its name, but here he can rest quietly, and sleep *sur les deux oreilles*, until such time as he weighs anchor for the homeward voyage" (vol. i. p. 67).

In spite of its imposing name, it did not take the explorers long to see all the sights of Petropaulovsky, and a plan was soon formed to make an expedition into the interior. Travelling northwards from Avatcha Bay, they soon struck the head waters of the great Kamschatka River, on which they floated down to the sea. The well-known naturalist Dr. Dybowski gave them great assistance in their undertaking. The yacht was to remain in harbour for some six weeks, and then to proceed, as it did, to the mouth of the river to await their arrival. Of this delightful river journey our space will permit us to give no details. As far as Narchiki, where they met the river, they journeyed on ponies, and then they floated down its stream, sometimes in boats, sometimes on rafts, until, after many an adventure, and, indeed, many a trial, they reached Ust Kamschatka in safety. In places, the river swarmed with salmon; bears were in abundance; the weather, though not always of the best, was generally bright and clear; but the natives were very difficult to deal with—always exorbitant in their charges, and often placing the travellers in sad dilemmas; and constant rows took place about the hire of the canoes. One morning, after a harder fight than usual with the Mashura men, with much time and some temper lost, they came in sight of the magnificent range of volcanoes on the lower reach of the great river. The five already-known volcanoes have elevations of from 11,700 to nearly 19,000 feet, and there were two much lower cones, now first described, which they called after Gordon and Herbert Stewart. The account of the travellers' first view of these mighty peaks must be told in their own words.

"We floated silently down stream for a couple of hours or more, thinking over the discussions that we knew only too well would be renewed at the earliest opportunity,

when turning a sudden corner we found ourselves face to face with a view that banished all thought of past and future annoyances in a moment. Before us, eighty miles or more away, stood one of the grandest groups of volcanoes in the known world. Others there are, it is

true, that are higher, although in most cases the elevation of the ground from which they take their rise detracts in no little degree from their apparent height. But here, from a base elevated scarce a hundred feet above the sea, a series of cones of the most exquisitely symmetrical shape



The Volcano of Kluchefskaya.

rose in heights varying from twelve to seventeen thousand feet. They were three in number. Nearest us was Tolbatchinska, dog-toothed in shape, with its apex on the western side, a long thin puff of white smoke drifting from its shoulder; and beyond, apparently in close prox-

imity to one another, rose the twin peaks of Kojerevska and Kluchefskaya, perfect in their outline, pyramids of the purest snow, before which one felt how poor was all language to express the sense of their perfect beauty. Snow mountains were no novelty to us. We had seen the

Andes and the Alps, and had watched the sun rise on Cotopaxi, on Etna, on Fujiyama, and a dozen other mountains of equal note. But here all questions of comparisons would have been a sacrilege; and floating noiseless over the unruffled surface of the river, we sat spellbound drinking in the view. The sun sank slowly as we crept along, and slope and peak, at first a dazzling white, turned slowly to a glowing gold. On either hand the fast-approaching night had changed the glories of the autumn tints to a sombre shade of violet, and behind us the river was a mere streak of light. The glow of the fire upon the other raft lit up the bearded faces of our Russian guides around it; and when the daylight had fairly waned, the head of Kluchefskaya stood out a pale greenish white—a spectral mountain against the fast-darkening sky. Come what might, even if we were never again to get a glimpse of them, we had seen the great volcanoes, and we felt that the sight was one that we should not easily forget for many years to come" (vol. i. p. 149).

After rejoining the yacht the party visited the well-known breeding-places of the fur seal at Bering Island; from thence back to Kamschatka, and then to Yokohama to refit and repair. A brief history of Russian discovery in these seas, and a record of a little-known defeat of the allied forces of England and France in 1854 at Avatcha, will also be found in this volume.

In Volume II. the scene changes from the snowy north to the tropics, where for a long time the *Marchesa* wandered from one island of the Indian Ocean to another. The little-known Island of Cagayan Sulu is described as perhaps the most beautiful of all tropical islands. A revised chart of the island is given; and its three crater-lakes, one of the most interesting phenomena to be met with in the Eastern seas, were visited and described. The third lake had escaped the notice not only of Admiral Keppel, who had twice visited this island, but also of Captain Chimmo, who had in 1871 surveyed Cagayan Sulu. This lake was of rather smaller size than the others, being two-



Brunei.

fifths instead of three-fifths of a mile in diameter; but the basin was perfectly circular, and filled with water to about the level of the second lake. Thick jungle clothed its precipitous sides, but the latter, instead of running sheer down into the water, left room for a small beach on which wild bananas were growing.

The islands of the Sulu Archipelago are described in Chapters II. to IV. of this volume. Natural history rambles were made over Sulu; and the Sultan, with and without his wives, visited the yacht. Some days were spent with the Spaniards at Jolo, a fortress on the northern side of the island. The fauna and flora of the Philippines and Borneo are contrasted with those of Sulu, and the Sulu Archipelago is determined to be, zoographically, purely Philippine, the Sibutu Passage forming the boundary line.

The newly-acquired territories of the British North Borneo Company were next visited, and some details are given of the existing state of things in this new colony. The colony at Labuan was found to be retrogressing. The

Sultan was interviewed; and Brunei, the Venice of the East, in which, except its market, there is little of interest, was explored. The great dexterity of the boatmen in the use of their paddles is noted. "From a rapid and beautifully clean stroke of forty or more to the minute, they would drop instantaneously to a long steady swing of twenty, without any apparent signal having been given, and without a hair's-breadth of deviation from the perfect time."

We pass over the chapter on Sumbawa, and next find the yacht at Celebes. Macassar is the Hong Kong of the Dutch, and is not attractive from the sea.

"The town is much as other Dutch Malayan towns. A row of white shops and merchants' offices lines the sea; and dust of a lightness and powderiness that is not excelled even in California or the Diamond Fields covers the streets to the depth of an inch or more. These are otherwise clean enough, and the spare time of the native servants, and they appear to have plenty of it, is occupied

in perpetual watering. There is of course a fort, and equally of course a 'plein.' The cemetery is significantly full. Almost all the tombs are kept whitewashed, and as many of them are curious chapel-like erections with flying buttresses, the effect at a distance is something between an ice palace and a clothes-drying ground. The houses of the Dutch residents, shadowed in peepul or galela trees, stand back a little distance from the road, long, low, and cool, with thick white posts at their entrance gates. A long avenue of magnificent overarching trees leads eastwards from the pier, adown which the Governor may be seen driving any afternoon in a four-in-hand, with sky-blue reins. It is lighted by means of lamps hung midway between the trees, for the Hollander, even although gas may be unattainable, considers civilisation incomplete without these adjuncts. Then too there is the club, with its zinc-topped tables set out *café*-fashion beneath the trees. It is called the 'Harmonie,' as is every Dutch club in Malaysia, and within all is dark and deserted and cool during the mid-day heat. The servants are curled up asleep behind the bar or in the corners of the rooms, and would stare in dumb astonishment at the apparition of a European: for the early business of the day over, and the *rijst tafel*, or lunch, despatched, the white residents get into their *pyjamas* and take a siesta till three or four o'clock. A couple of hours or so are then devoted to business, and towards sunset the male portion of the population meet at the 'Harmonie' to chat and drink *pijljes*. Billiards is the most violent exercise taken; cricket, bowls, and lawn-tennis are unknown" (vol. ii. p. 156).

Among the pleasant reminiscences of the travellers about their travels in the north of Celebes will doubtless be those of their visits to the Tondano Lake with its pretty waterfall; to Talisse Island, where at "Wallace Bay" the habits of the maleo (*Megacephalon malco*) were observed, and a good store of their eggs and bodies were collected; and to Kema, where a great babiroussa hunt was held.

The name Moluccas, at one time restricted to the little chain of volcanic islets lying off the western coast of Gilolo, of which Ternate is the chief, now includes all the islands between Celebes and the Papuan group. As regards magnificence of scenery, Ternate is perhaps the finest harbour in the Dutch Indies. The Resident, Mr. Morris, kept a large aviary of rare birds, amongst which the gems were two superb specimens—both full-plumaged males—of the twelve-wired bird of paradise. These exquisite creatures were fed on the fruit of the pandanus, with an occasional cockroach as a *bonne bouche*. "The feelings of admiration with which I watched these birds, which are among the most beautiful of all living beings, I need not," says the writer, "attempt to describe." The concluding chapters of this volume bring us to New Guinea, the very home of paradise birds. The portion of this great island visited was the western half, that claimed by the Dutch; which, from the variation in species from island to island, and the peculiarity of these birds of paradise, is perhaps the most interesting to a naturalist. A safe anchorage was secured at the extreme east end of the Island of Batanta, in "Marchesa Bay." The first ramble on shore was unsuccessful. Scrambling over the mangroves' slimy roots, and struggling up to their knees in liquid ooze, they found that the land was hard to reach; and the shore rose steeply from the sea, and the dripping wet jungle made progress all the more difficult. The party returned disappointed to the yacht, to find that some of the hunters were already back, equally empty-handed. Presently, however, "Usman and his *compagnon de chasse* appeared triumphant, carefully carrying a prize that we had hoped, but hardly expected, to obtain—the curious and exquisitely lovely little *Diphylodes wilsoni*, smallest of all the birds of paradise. Behind the head, a ruff of canary-coloured feathers stands

erect above the scarlet back and wings. The breast is covered by a shield of glossy green plumes, which towards the throat are marked with metallic green, and violet spots of extraordinary brilliancy. The two centre feathers of the tail, prolonged for five or six inches beyond the other cross one another, and are curved into a complete circle bright steely purple. But the chief peculiarity of the bird is the head, which is bald from the vertex backwards, the bare skin being of the brightest imaginable cobalt blue (the figure in Gould's 'Birds of New Guinea' gives no notion of the extreme brilliancy of the colouring of this part). The *bizarre* effect thus produced is still further heightened by two fine lines of feathers which, running lengthways and from side to side, form a dark cross upon the brilliant azure background. I could hardly make up my mind to skin this little ornithological rainbow, whose exquisite plumage it seemed almost a sacrilege to disarrange, but the climate of New Guinea allows of but little delay in this operation, and I set about my task at once. The bird had been scarcely injured by the shot, and I succeeded in making a perfect skin of it" (vol. ii. p. 254).

Dorei Bay, well known as the settlement of the Dutch missionaries, and the residence of Mr. Wallace in 1858, was the next station. Some few miles south of Dorei Bay is Andai, a small village nestling at the foot of the Arfak Mountains. The dense forests that clothe these mountains are the favoured haunts of such magnificent paradise birds as the great velvet-black Epimachus, with its tail a yard in length; the *Astrapia*, in its uniform of dark violet, faced with golden-green and copper; and the orange-coloured *Xanthomelus*. There D'Albertis had shot his *Drepanornis*, with its two fan-like tufts, one flame-coloured, the other tipped with metallic violet; and there Beccari braved the climate and made such splendid collections. The summits of the mountains were less than ten miles from where the yacht was, and yet this land of promise could not be entered. Our readers must seek the reason why in the narrative: here we can only add that the homeward voyage had begun.

In so short a sketch it is simply impossible to do more than give the reader an idea of what he may expect to find within the pages of these volumes. Students of geography, ethnology, and, above all, zoology, will discover therein a great deal that is of interest, and also much that is novel; and every reader will be pleased by the writer's freshness of style and keen enjoyment of Nature. To enjoy travelling, especially in the tropics, one must be of an equable, not to say of a cheerful, frame of mind. We close the perusal of Dr. Guillemard's delightful volumes with the impression that the company on board the yacht *Marchesa* was certainly of this kind.

In several appendixes to Volume II. there are lists of the birds met with in the various regions visited, and of the shells. There is also a list of the Rhopalocera collected in the Eastern Archipelago, and of the languages of Sulu, of Waigiou, and of Jobi Island. Tables are given of the total export in 1884 of the chief articles of produce in the Netherlands India, North and South Celebes, Amboyna, and Ternate.

THE SMITHSONIAN INSTITUTION

THE annual Report of Prof. Baird, Secretary of the Smithsonian Institution, has just been issued. It relates to the period from July 1, 1885, to the close of June 1886, and includes, in addition to the account of the operations of the Institution itself, a summary of the work done by the branches of the public service placed by Congress under its charge, namely, the National Museum and the Bureau of Ethnology. To this is added a sketch of the work of the U.S. Fish Commission, which is also under Prof. Baird's charge, and of that of the U.S. Geological Survey, which, although independent of the Smithsonian Institution, is in close relation with it by

ason of its field of exploration, and especially through the valuable accessions of material furnished by it to the National Museum.

With regard to the Smithsonian Institution itself there is not much to be said, except that its usual operations are steadily carried on during the year, with a marked increase in routine work. In the way of explorations there was less activity in the year 1886 than there has been in some previous years, but important collections of objects of scientific interest were received from various parts of America and Asia. Of the different classes of works issued by the Institution, the most valuable are the quarto "Contributions to Knowledge." A work in this series, entitled "Researches upon the Venoms of Poisonous Serpents," by Dr. S. Weir Mitchell and Dr. E. T. Reichert, was printed during the past year, and will soon be ready for distribution. Among the "Smithsonian Miscellaneous Collections" of 1885-86 may be mentioned "A Catalogue of Scientific and Technical Periodicals (1665-1882), together with Chronological Tables, and a Checklist," "The Scientific Writings of Joseph Henry" (not yet published, but entirely stereotyped), "Index to the Literature of Uranium, 1789-1885" (one of a series of bibliographies especially directed to the indexing of chemical literature), and "Accounts" of the progress of astronomy, chemistry, physics, geography, anthropology, and other sciences in 1885. The Smithsonian Institution has also issued the Bulletin and Reports of the Proceedings of the National Museum, and valuable publications of the Bureau of Ethnology.

It is well known that in bequeathing to the United States the fund with which the Smithsonian Institution was established, Mr. Smithson stipulated that his bequest should be devoted to "the increase and diffusion of knowledge among men." The Institution has always complied with this condition in a most liberal spirit, and now its system of "free exchanges" has reached vast proportions. In the year ended June 30, 1886, the receipts for foreign transmission were 94,093 packages, weighing 195,404 pounds. The transmission filled 764 boxes, having an aggregate bulk of 5208 cubic feet. For domestic exchanges the number of parcels received and distributed during the fiscal year was 14,496, of which 2533 parcels (or about one-sixth) were received for the library of the Institution. Twenty years ago the Institution was made by law the agent of the United States Government for conducting the international exchanges of public official documents between it and foreign Governments, and during the past year 29 boxes, containing 56,229 packages, were received for Government exchanges, and 114 boxes were sent abroad. The exchange system of the Institution is found to be of so much public service that Congress supports it by an annual grant of 10,000 dollars.

Perhaps the most interesting part of the report is that which relates to the National Museum. It is five years since the work of moving into the new Museum building was begun. Two years ago the Director reported that the packing-boxes, several thousand in number, containing the accumulations of many previous years, had for the most part been unpacked, and that the entire floor space of the building would soon be occupied by exhibition collections. During the past year this result was attained, and with the exception of one corner of one of the central halls still occupied by one or two collections received at the close of the New Orleans Exhibition, and which have not been opened on account of delay in preparation of cases for their reception) the entire floor space of about 100,000 square feet is open to the public, and the collections arranged in accordance with the provisional plan of installation. The work of mounting and labelling is still in progress, and each month shows marked advances.

The development of the Museum during the past year was unexpectedly great. About fifteen hundred separate lots of specimens were received. A certain proportion of

these were obtained from Government expeditions and surveys, and material of perhaps equal value through exchange, but by far the largest part of the increase, both in quantity and value, was in the form of gifts.

A census of the collections made in 1884 showed an estimated total of 1,471,000 "lots" of specimens in the Museum. The number at the present time is 2,420,934. The total number of "lots" of specimens received during the year and separately entered on the record of accessions was 1496, including 6890 separate packages. The construction of cases was constantly in progress, and during the year there were received and fitted for use and placed in the exhibition halls 84 cases, chiefly of the standard patterns. Forty-five storage cases were made for use in the laboratories, 5400 wooden drawers and trays, and 54,000 pasteboard trays. There were also purchased 3504 glass jars, for storage and exhibition of alcoholic specimens, and 24 barrels (1115 gallons) of 98 per cent. alcohol.

The distribution of duplicates was much the same as in previous years. About twenty-four thousand specimens were sent out to 118 institutions and societies: those to institutions in the United States are generally gifts, though many were sent in the way of exchange. For all foreign sendings, equivalents in the way of exchange were received or promised.

Many interesting details are given as to the various Departments in which the collections of the Museum are grouped. In the Department of Arts and Industries a prominent place is held by the section of textiles, which includes a very full series of the animal and vegetable fibres used throughout the world, together with good representations of devices for spinning and weaving, and of the various products of the textile industries. This collection is nearly all permanently installed, provided with printed labels, and illustrated by diagrams. For lack of room, fully half of the material ready for exhibition has been stored away, and the cases prepared for its display are in boxes in the Armoury building. The space assigned to the exhibition series is still so crowded that the objects cannot be satisfactorily examined. To the collection of food substances, in the same Department, is assigned a large quantity of unsorted material. The few cases now on exhibition contain the foods of the North American Indians, of Japan and China, and some of the more curious and unusual articles of diet. There are also two cases of educational importance, which exhibit graphically the composition of the human body and its daily expenditure of tissues, and the manner in which this is compensated for by daily rations of food. This collection is modelled after the famous collection of a similar character prepared by Dr. Lankester and others for the Bethnal Green Museum in London. It is, however, based upon an entirely new series of analyses, and upon a revised plan prepared by Prof. W. O. Atwater, of the Wesleyan University, and corresponds to the latest views in physiological chemistry. The collections in chemical technology already have a good nucleus, and the increase during the year in the collections of materia medica was greater than during any previous year except the first. The fisheries collection was opened to the public in May 1884, and since that time there has been constant improvement in the condition of the material exhibited. Some gaps in the series of illustrations of foreign fisheries have been filled by collections received from the Governments of Siam and Japan, and by the extensive collections from Great Britain, Sweden, Spain, France, Holland, and Greece, acquired at the close of the London Exhibition.

Of the collection of historic relics in the Department of Arts and Industries, we learn that it includes several hundred objects of national interest connected with the history of soldiers, statesmen, and important events. Closely related to the historical collection is the series illustrating the history of steam transportation, under the

charge of Mr. J. E. Watkins, of Camden, N.J. The "John Bull" engine, imported from England in 1831, the model after which all subsequent American engines have been constructed, has been given to the Museum by the Pennsylvania Railroad Company, and placed on exhibition; and adjoining this is a case in which there are already assembled about forty objects illustrating the beginnings of the American railroad system. The collection of scientific instruments owes its interest at present chiefly to the historical associations of most of the apparatus displayed, including, as it does, instruments used by Priestley, Henry, and Hare. The original telegraphic instrument of Morse and Vail is also here shown. The collections of musical instruments, modern pottery, and porcelain, lacquer, and the process of engraving are partially displayed, and when cases and floor space shall become available, will soon develop into important features.

The Department of Ethnology, although one of the youngest, is one of the largest in the Museum; and its growth during the last year was very great. Certain large classes of objects, such as weapons of war and the chase, implements of agriculture, and other primitive industries, have been carefully grouped. In addition to these great series of objects, classified according to function, other groups of objects have been arranged in accordance with another idea of classification, which is deemed of equal importance, namely, that of race. The Eskimo collection, for instance, has been arranged in table cases in one of the exhibition halls, in accordance with the ethnic idea, although, in the minor details of classification, function and form, as well as geographical distribution, have been followed. A preliminary study of the collection of basketry has been completed. A paper upon the baskets of uncivilised peoples, with numerous illustrations, was published in the Museum Report for 1884, and a representative series placed on exhibition with provisional labels. The throwing-sticks and sinew back-bows have been the subject of papers, and are now on exhibition. The curator has in progress investigations upon several groups of objects, notably the history and technology of archery; upon transportation as effected by man without the aid of domestic animals or mechanism; upon the peculiar industries of several handicrafts; upon the Hoopah Indians of California. The underlying ideas in these investigations, a first instalment of which was published in the last Report of the Museum, are (1) that the methods of strict classification and nomenclature already applied in the other natural sciences are equally applicable to anthropology; (2) that a trustworthy and minute study of modern savage and barbarous *technique* is absolutely requisite to the archaeologist and technologist in reconstructing the history of civilisation.

The collections in the Department of American Aboriginal Pottery have continued to increase with astonishing rapidity, and the extensive accessions which have been received through the Bureau of Ethnology, and from other sources, have been of the greatest scientific importance and popular interest. One of the four large central halls of the Museum is devoted entirely to this subject, and the removal of the collections of South American aboriginal pottery and of the extensive collections from the mounds which have for many years been accumulating in the Archaeological Hall of the Smithsonian building, have filled it up to such an extent that it is difficult to find room for the new material as it comes in. During the year a portion of the hall was thrown open to the public. The exhibition case surrounding the walls of this room is probably the largest in existence in any museum, being 260 feet in length, 4 feet 9 inches in depth, and, being double throughout, its entire length is virtually 520 feet. Double the space now allotted to this Department is necessary for its proper display, and the value of the material here concentrated is practically inestimable; since even the modern

tribes, who are still making pottery similar in its general character to that which is here preserved, have deteriorated to such a degree in their artistic capacity or skill that their products are not an exponent of their original artistic capabilities. So exhaustive is this collection that it is impossible that any thorough work can be done upon the American aboriginal pottery which shall not in great part be based upon it.

The total number of accessions in the Department of Antiquities was 2751; and all excepting eighty-four were of sufficient importance to be added to the exhibition and study series, which now include over 40,000 specimens. Dr. Rau, the Curator of this Department, is engaged upon the preparation of an illustrated work on North American prehistoric objects, which is designed to serve as a guide for visitors to the Department, and as an explanation of the terminology of North American archaeology. This will bear the title, "A Classification of the North American Prehistoric Relics in the United States National Museum." This book will be fully illustrated, and, it is hoped, will be published in the ensuing year.

The most important accessions to the Department of Mammals, as in previous years, were in the shape of single specimens sent from zoological gardens and menageries, which have shown a great deal of liberality to the Museum in this respect.

The growth of the Department of Birds during the year was very satisfactory, the number of specimens added to the collection being 4147. The largest single accession was the collection made by the U.S. Fish Commission steamer *Albatross* in the Bahamas, of 1000 specimens and about 75 species, of which 5 were new to science. Another valuable collection, 243 specimens, 81 species, 1 new to the fauna of North America, was obtained in Alaska by Mr. Charles H. Townsend, while on a mission for the Fish Commission. Mr. Henry Seebohm, of London, gave to the Museum 171 specimens, 68 species, chiefly from Siberia, and of great value to the collection. The number of specimens in the collection is now 55,945, 7000 of which have been set apart for the exhibition series.

Very much was accomplished during the year in the classification and arrangement of the collection of eggs and nests of birds. The total number of specimens added is 2556, in 253 lots, and there are now more than 44,000 specimens in the collection, of which 1491 are in the exhibition, and 31,124 in the reserve collection, the remainder having been set aside as duplicates.

The remaining Departments of which accounts are presented are those of Reptiles, Fishes, Mollusks, Entomology, Marine Invertebrates, Comparative Anatomy, Invertebrate Fossils, Fossil and Recent Plants, Minerals, Lithology and Physical Geology, and Metallurgy and Economic Geology. In dealing with the Department of Entomology, the author of the Report has to record a fine instance of the generosity and public spirit for which the best class of American citizens are famous. In October last, Dr. C. V. Riley formally presented to the Museum his private collection of North American insects, representing the fruits of his own labours in collecting and study for over twenty-five years. This collection contains over 115,000 pinned specimens, and much additional material unpinned and in alcohol. This generous gift to the Government had long been contemplated by Dr. Riley, who wishes to be, as far as possible, instrumental in forming a national collection of insects. In his letter of presentation he remarked:—"While the future of any institution dependent on Congressional support may not be so certain as that of one supported by endowment, I make this donation in the firm belief and full confidence that the National Museum is already so well established in public estimation that it must inevitably grow until it shall rival, and ultimately surpass, other institutions in this country, or the world, as a repository of natural history collections."

here shall in the future result the concentration here at national capital of the extensive entomological material which naturally comes here, and which in the past has been scattered among specialists in all parts of the country, that in the future the student may find valuable material further his work in any order, I shall feel amply rewarded for the action I have taken."

The Curators of all the Departments complain that the new Museum building there is not nearly room enough for the display of the treasures placed under their care, and Prof. Baird presses upon the attention of the Board of Regents the urgent necessity of "additional quarters." One of the arguments used to him may, perhaps, not be without effect on public opinion. Efforts are being made to secure that in 1892—the four hundredth anniversary of the discovery of America by Columbus—there shall be an exposition, presenting a complete illustration of the New World at that date, and of its progress in the arts and industries in the 400 years intervening. Prof. Baird points out that the collections of the National Museum for the most part tend towards such a display, and expresses his belief that the new building for which he asks were erected it would be a very easy matter to organise and arrange it with this object in view, without unnecessary labour or great expense, and by the date mentioned, as the result of the current work of the Museum, without any spasmodic or unusual effort.

Of the Bureau of Ethnology we need only say that, during the fiscal year 1885-86, it continued its ethnographic researches among the North American Indians. Enthusiastic investigators carried on mound-explorations, explorations in ancient and modern stone villages, and general field studies. Much good office work was also done. This was, as usual, to a large extent the supplement and discussion of, the results obtained by exploration, and was executed by the same officers who had previously sought for materials and information in the field.

We have not space for further details, but probably we have said enough (as far as possible in the words of the report itself) to indicate the very flourishing condition of the Smithsonian Institution and the establishments associated with it. The Institution is one of which Americans have good reason to be proud, and we cannot doubt that the claim for a new building, advanced by Prof. Baird on behalf of the National Museum, will be promptly and carefully considered by Congress.

NOTES

PROF. BÉCLARD, Dean of the Medical School of Paris, died a few days ago of pneumonia. He was buried with great ceremony on the 12th inst. A large number of professors and students attended the funeral. His best work is on the rhythmic phenomena accompanying muscular contraction. He is a pleasant man, of fluent and happy eloquence, and a good writer. His place will probably be filled by Ch. Richet, editor of the *Revue Scientifique*.

THE Academy of Vienna intends to have a special meeting for the celebration of the centenary of the death of Father Scovich, the astronomer. A similar ceremony will take place at Ragusa, his native place.

WE have received a proof copy of the annual address of the Asiatic Society, Calcutta, delivered by Mr. E. T. Atkinson, the President, on the 2nd inst. It is an able and very interesting survey of the work done by the Society in the past year, and the progress made outside the Society in the subjects to which the attention of its members is directed.

THE sixth annual meeting of the Sanitary Assurance Association was held at the offices of Arundel Place, W. on Monday

last. Mr. Joseph Hadley, Secretary, read the annual Report, from which it appeared that the business of the Association during 1886 was much greater than in any previous year. The Report said that, of all the properties inspected, in only two cases of first inspection had the arrangements been such that the Council could certify the sanitary condition of the property without alteration. The Executive Council reported having held several meetings for the purpose of revising the Sanitary Registration of Buildings Bill of 1886, and a new Bill had been prepared for presentation to the House of Commons. In the new Bill, the principle of compulsory registration would be restricted to schools, colleges, hospitals, asylums, hotels, and lodging-houses. On the motion of Mr. Mark H. Judge, seconded by Mr. H. Rutherford, the following resolution was unanimously passed:—"That, as soon as the Sanitary Registration of Buildings Bill, 1887, is in the hands of members of the House of Commons, the President of the Local Government Board be asked to receive a deputation in support of the Bill."

ON Tuesday last the forty-first session of the General Medical Council was opened, and an address was delivered, as usual on such occasions, by the President, Dr. Acland, F.R.S. Starting with a reference to the jubilee, he traced some of the changes which have taken place during the last fifty years in medicine and in the methods of medical education.

LORD RAYLEIGH will begin a course of six lectures on "Sound" on Saturday, February 26, at the Royal Institution.

IN the latest of his annual reports, President Eliot, of Harvard University, refers to the present position of science in the secondary schools of America. "A serious difficulty," he says, "in the way of getting science well taught in secondary schools has been the lack of teachers who knew anything of inductive reasoning and experimental methods. This he attributes in part to the fact that "good school methods of teaching the sciences have not yet been elaborated and demonstrated," and he urges that "it is the first duty of University departments of science to remove at least this obstacle to the introduction of science into schools."

WE have received the third part of the first volume of "The Proceedings of the Linnean Society of New South Wales," second series. It contains the papers read at the meetings held in July, August, and September 1886, and there are four plates. Among the contents are the fifth part of a "Catalogue of the described Coleoptera of Australia," by Mr. George Masters, an elaborate paper on the "Revision of Australian Lepidoptera," by Mr. E. Meyrick, and "Miscellaneous Entomologica: No II. The Genus *Liparetrus*," by Mr. William Macleay.

IN the United States there is a very much larger number of female than of male teachers. According to the *Woman's Journal*, men are hardly ever employed in elementary schools in cities, save as principals or as teachers of some special branch. In the ten cities of Baltimore, Boston, Brooklyn, Chicago, Cincinnati, New Orleans, New York, Philadelphia, San Francisco, and St. Louis together, there are 12,719 public-school teachers, of whom 11,540 are women. The average percentage of male teachers in these cities is 9.

DR. M. TREUB, Director of the Botanical Gardens in Buitenzorg (Java), will be on furlough in Holland from the beginning of March till the end of November. In Dr. Treub's absence Dr. W. Burck will serve as Acting Director of the Gardens. Only the correspondence about the *Annales du Jardin Botanique de Buitenzorg*, together with private correspondence, is to be addressed to Dr. Treub himself (Voorschoten, near London, Holland).

A FRENCH translation has just been issued of Preyer's "Physiology of the Embryo." This book is a valuable one, dealing with a very obscure subject, and also one of great interest to the physician as well as to the psychologist and physiologist. All the functions of the adult being are in turn considered in the embryo, the differences and similitudes being well pointed out. M. Preyer understands the value of a good method.

MM. CHARCOT AND RICHER have issued an interesting book on "Les Démoniaques dans l'Art," that is, on hysteria studied in art manifestations of the past. The book contains quite a number of pictures after the old masters, which show that all the convulsions and attributes due to hysteria had been noticed and accurately pictured, although the manifestations were ascribed to diabolical influence. The scenes figured in this book relate especially to exorcising and similar feats, and very well illustrate the power of observation of many of the old painters.

A NEW medical paper is to be published shortly in Paris, under Prof. Grancher's direction, at a very low price, containing much matter and appearing twice a week. It will be called the *Univers Médical*, and the editor intends to devote a much larger part to foreign news than is usually given in French papers.

M. DUCLAUX, Professor in the Faculty of Science, issued on February 12 the first number of a new scientific periodical, the *Annales de l'Institut Pasteur*, of which he is editor, with a Committee comprising Messrs. Chamberland, Grancher, Nocard, Roux, and Straus. This periodical is to be published monthly, and will contain papers on bacteriology, physiologically and clinically considered. The first number contains a letter from Pasteur, giving very encouraging and positive facts concerning the efficacy of preventive inoculations, obtained in his own laboratory and in those of Russia and Italy.

HERR W. ENGELMANN, of Leipzig, has issued the first number of a monthly scientific periodical called *Zeitschrift für physikalische Chemie*. The editors are Profs. W. Ostwald, of Riga, and J. H. van't Hoff, of Amsterdam.

ACCORDING to the *American Meteorological Journal*, an attempt is about to be made at St. Augustine, Fla., to sink a 12-inch artesian well to a depth sufficient to obtain water hot enough to heat buildings, pure enough for domestic purposes, and with pressure enough to run heavy machinery. Water can be found in Florida by boring 250 feet; and it is known that the artesian wells in that State have considerable pressure, and from a depth of 600 feet send water of warm temperature to a height of 45 feet when piped. The earth's internal heat is already forced into practical service at Pesh, where the deepest artesian well in the world is being sunk to supply hot water for public baths and other purposes. This well supplies daily 176,000 gallons of water heated to 158° F., and the boring is to be continued until the temperature of the water is raised to 176°. Heavy machinery is run by artesian well power in many parts of France, and the experience of the French shows that the deeper the well the greater the pressure and the higher the temperature. At Grenelle, a well sunk to the depth of 1802 feet, and flowing daily 500,000 gallons, has a pressure of 60 lbs. to the square inch, and the water from this well is so hot that it is used for heating the hospitals in the vicinity.

THERE is now ample evidence that the use of oil may be of considerable service in lessening the effect of dangerous seas. In one case the "slick" made by the oil extended 30 feet to windward, and the U.S. Hydrographic Office concludes that the oil is of use when the vessel is reaching ahead at the speed of eight or nine knots, with a beam wind and sea.

HERR SCHILLER, a well-known German architect, reports some facts which are of interest as indicating the radius of the circle of protection of good lightning-rods. On June 17 last, at the village of Mottingen, lightning struck a pear-tree 33 feet high. On one side, 115 feet away, was a school-house, with a rod 56 feet high. On the other side was a church, 328 feet away, and having a lightning-rod reaching up 154 feet. Both rods are well placed, and had worked well when tested, and the level of the foot of the tree is about the same as that of the two buildings. It is evident, then, if the facts have been accurately reported, that the radius of the circle of protection is not more than twice the height of the rod.

ANOTHER earthquake is reported from Aquila. On the night of February 3, three shocks were felt, two of which were accompanied by strong undulatory motion.

EARTHQUAKES are also reported from the Vilayet Konia, in Asia Minor. On January 8, a subsidence of the ground was noticed at Holan Gola (Feneke district), accompanied with loud subterranean noises; many landslips took place in the adjacent hills. The shocks continued for six days, and the inhabitants of Feneke and the neighbouring villages took refuge in the fields. The earthquakes have destroyed seven villages.

On January 15 the Hawaiian volcano Mauna Loa began to discharge. Frequent shocks of earthquake were felt. A letter written on January 19 says:—"There have been thirty-six hours' continuous earthquakes. The lava flows down the south slope, and if its course be unchanged it will flow into the sea without doing much damage."

THE Russian traveller M. Ogorodnikoff was told at Meshed that there are tin mines near that city and in various parts of Khorassan. In an article in the *Revue Scientifique* M. Berthelot points out that this accords with a passage in Strabo, who speaks (book xv. ch. ii. 10) of tin mines in Drangiana, the ancient name for the region now called Southern Khorassan. If there really have been tin mines in this district from time immemorial, there can be little doubt that they supplied the tin for the bronzes of ancient Egypt and Assyria.

THE first zoological station in the tropics has been founded by Dr. Sluiter, at Batavia. This gentleman is already well known by his works on the fauna of the Sunda Islands. The Natural History Society of the Dutch Indies has presented Dr. Sluiter with sufficient means to establish three work-tables with the necessary apparatus, and to purchase a sailing-boat.

MR. ABBOTT KINNEY writes to the Los Angeles *Weekly Tribune*: that the floods in Southern California are becoming every year more violent and destructive. The testimony on this point, he says, is uniform, complete, and unimpeachable. The streams now nearly all bring down more sand, gravel, and boulders, rise more rapidly, cut away more land, and dry up more quickly than formerly. Valuable valley lands are thus cut away or covered up, and in some cases the streams have spread out and deposited great fan-shaped mounds of sand and boulders. Mr. Kinney attributes the change chiefly to the destruction of forests. The brush and forests on the hills and mountains have been to a large extent swept away, and the result is that there is nothing to hold the water back. The rains do not penetrate into the soil and rocks which supply the springs, but rush suddenly off the mountains as from a roof, carrying the soil first, and then the gravel and boulders with them. The springs, deprived of their supply, diminish. The principal agent in the destruction of the natural verdure and protection of the mountains has been fire. Fires accidentally lighted, fires made by stock-men, bee-men, and fools, are, according to Mr. Kinney, producing effects that must eventually make Southern California a desert.

It is proposed that a school of hygiene shall be established at University of Michigan, and the State Legislature is about to be asked to authorise the necessary expenditure. The scheme suggested by the State Board of Health. The school would include in its curriculum climatological studies, air analyses and ventilation.

LAST week there was a Convention of Photographers in the Hall of the Society of Arts, and the attendance was good and representative. The proceedings in the morning were opened by a few remarks from Capt. Abney, the President, who, in the afternoon, delivered a more elaborate address, projecting on a screen a succession of diagrams and pictures illustrative of his statements. At a dinner in the evening the toast of the Camera Club was proposed by Mr. V. Blanchard, who, in recalling the time when he made his first practical acquaintance with photography by watching a friend develop a paper negative, expressed his opinion that photographers might perhaps return to the use of paper negatives.

PROF. LIVERSIDGE, of the University of Sydney, who is about to return to England on leave of absence, has been requested by the Minister of Public Instruction of New South Wales to inquire into and report upon the mode of teaching natural science in the elementary schools of Great Britain and Ireland.

NEW SOUTH WALES will be represented at the Conference of Astronomers to be held in Paris in April next, by Mr. H. Cassell, the Government Astronomer.

A VALUABLE "Report on the Medusæ collected by the U.S. Fish Commission Steamer *Albatross*, in the Region of the Gulf Stream in 1883-84," by Mr. J. Walter Fewkes, has lately been printed, at the Government Printing Office, Washington, from the Annual Report of the Commissioner of Fish and Fisheries for 1884. Mr. Fewkes is not sure that certain of the Medusæ ordered by the *Challenger* from great depths do not also live and flourish at or near the surface. There is need, he thinks, of greater accuracy in the determination of the exact depth in which a deep-sea Medusa is taken, and for an improvement of the apparatus used in this kind of collecting. In the case of fixed hydroids, or such Medusæ as *Cassiopeia* and others, which live upon the bottom, the determination of the depth at which they live is an easy task. With such genera as *Atolla*, *Rhizophysa*, and others, this determination is more difficult. Mr. Fewkes points out that it is of great importance, from a morphological stand-point, that the question whether Medusæ are confined to certain depths, should be definitely answered. "I can at present," he says, "imagine no place on the globe where the uniformity of conditions under which Medusæ are placed can be the same as at great depths of the ocean. I do not mean necessarily on the floor of the ocean, but that may be raised or depressed, and the varieties of conditions which come from such motions may result, but in the depth of the sea, separated from the surface by a wall of water of great depth, and from the ocean-bed by a similar wall of equal amount. Here, if anywhere, may we look for the continuance of ancestral features unmodified by environment. On this account the determination of the bathymetrical limits of the Medusæ, no less than that of those animals which inhabit the bottom, is a most important thing, and from it should be eliminated all possibility of error."

DR. OTTO HERMES has just published the results of some interesting investigations concerning the phosphorescence of marine fish. He wished to ascertain whether the phosphorescence was caused by the same Bacillus which Dr. Fischer, an eminent authority on Bacteria, has discovered and brought from the West Indies. Marine fish are easily rendered phosphorescent or death by being moistened with a little sea-water. Dr.

Hermes took a fragment of a specimen of *Gadus callarias*, which had been made strongly phosphorescent in this manner, to the laboratory of Councillor Koch; and Dr. Frank, a pupil of the latter, was enabled to isolate it after a few days. This is undoubtedly a new species. Like Dr. Fischer's Bacillus, it can be transferred upon sterilised fish, and after forty-eight hours it emits an emerald-green light; the sea-water is also rendered phosphorescent. A point of difference is that the Bacillus of Dr. Fischer develops best in a high temperature (20°-22°), while that of Dr. Hermes develops better in a low one. Examined microscopically, the latter is much smaller than the former. Dr. Hermes has given it the name of *Bacterium phosphorescens*.

THE German Fishery Association lately asked the German Chamber of Commerce to put a premium on seals, it being maintained that these animals are most destructive to the fisheries. The petition was refused. The Association, in support of its views, stated that a full-grown seal requires 10 lbs. of fish a day for its food, making 3650 lbs. in a year. At the same rate, 1000 seals would consume the enormous quantity of 3,650,000 lbs. a year. As the seal is a faithful attendant upon herring-shoals, it causes enormous havoc among a species of fish which is one of the greatest sources of revenue to the fishermen on the North German coast. It is maintained that these depredations have greatly decreased the quantity of fish in recent years. Complaints of the serious destruction of fish by seals have also lately been made by Swedish fishermen in the Baltic.

THE additions to the Zoological Society's Gardens during the past week include a Green Monkey (*Cercopithecus callitrichus* ♂) from West Africa, presented by Mr. Charles W. Dempsey; a Bonnet Monkey (*Macacus sinicus* ♂) from India, presented by Mr. G. S. Copeland; a Common Otter (*Lutra vulgaris*), British, presented by Mr. John Hall; two Rufous Tinamous (*Rhynchotus rufescens*) from Brazil, presented by Mr. Francis Monckton; two White-throated Finches (*Spermophila albobularis* ♂ & ♀) from Brazil, deposited; a Collared Fruit Bat (*Cynonycteris collaris*), born in the Gardens.

OUR ASTRONOMICAL COLUMN

A METHOD FOR THE DETERMINATION OF THE CONSTANT OF ABERRATION.—Referring to M. Lœwy's plan for the determination of the constant of aberration by measuring the relative positions of stars situated in distant parts of the sky at successive epochs by means of a double mirror placed in front of the object-glass of an equatorial (NATURE, vol. xxxv. p. 282), M. Houzeau points out (*Comptes rendus*, tome civ. No. 5) that the same idea occurred to him some years ago, and that the fundamental principle of the method, and an enumeration of the advantages attending its application, were published by him in 1871, in a paper entitled "Considérations sur l'Étude des petits Mouvements des Étoiles," which appeared in tome xxxviii. of the Mémoires de l'Académie de Belgique. It appears, therefore, that M. Lœwy's method cannot, strictly speaking, be considered a new one, though we believe it has never been put into actual practice—a work which we hope to see before long accomplished at the Paris Observatory.

THE APPLICATION OF PHOTOGRAPHY TO THE DETERMINATION OF STELLAR PARALLAX.—In the *Monthly Notices* for January 1887, Prof. Pritchard publishes the results of his measurements of the photographs of 61 Cygni and neighbouring stars, taken on fifty nights ending December 7, 1886, with a view to the determination of the parallax of this well-known star. Using measures of distance only, the relative parallaxes of each of the components, referred to each of four comparison-stars, are:—

Star	Parallax of 61 ¹ Cygni	Probable error	Parallax of 61 ² Cygni	Probable error
a ...	0'4412	... 0'0154	0'4204	... 0'0229
b ...	4529	... 0330	4139	... 0185
c ...	4433	... 0197	4721	... 0215
d ...	4158	... 0161	4574	... 0252

The means for the parallaxes thus obtained for the four-independent sets of measures of 61^1 and 61^2 Cygni respectively are as follows:—

For 61^1 Cygni, $0''\cdot438$; for 61^2 Cygni, $0''\cdot441$.

Prof. Pritchard explains that this determination is to be regarded as provisional only, and that the work will be continued to the end of the annual cycle. The method certainly appears to be a most promising one, and the publication of the full details of the Oxford researches will be awaited with interest.

OBSERVATIONS OF VARIABLE STARS IN 1885.—No. 151 of Gould's *Astronomical Journal* contains Mr. Edward Sawyer's observations of variable stars made in 1885. The following epochs of maximum brightness were observed:—R Andromedæ, 1885 January 10; R Leonis, about 1884 December 24; R Leo. Min., 1885 June 26; R Bootis, 1885 May 16; R Ursæ Majoris, July 1; S Ursæ Majoris, May 7; U Herculis, July 8; α Herculis, June 4, August 2 (?), October 16; S Coronæ, May 11; χ Cygni, 1885, January 10; R Scuti, 1885 June 17, August 10 (?), and November 16; Mira Ceti, February 10; R Aquarii, January 4. β Pegasi and α Cassiopeie appeared constant, and ρ Persei nearly so, during the observations. R Coronæ was well observed, and showed numerous but slight fluctuations of light. An unusually bright phase, $6\cdot2$ m., occurred on August 15, followed by a rather faint minimum, $7\cdot4$ m., on October 13. T Monocerotis was well observed: last minimum, April 20, 15h. 26m. Camb. M.T.; last maximum, April 27, 15h. 55m. U Monocerotis was observed at minimum on April 1, and at maximum on April 14. W Cygni was observed at maximum on August 20 and December 16, giving a period of $118 \pm$ days, and at minimum on October 30.

THE ALLEGED ANCIENT RED COLOUR OF SIRIUS.—Mr. Lynn, in the current number of the *Observatory*, shows that the evidence for this star having formerly been of a red colour is much less strong than has frequently been supposed. Prof. Schjellerup had pointed out in his notes on his translation of Sûfi, that the designation $\delta\rho\delta\alpha\beta\beta\delta\sigma$ applied to the star in our editions of Ptolemy was probably an error of transcription for $\alpha\epsilon\lambda\pi\sigma$; whilst it had been suggested long ago that, for the word "rub r" which we find used in reference to it by Seneca, we should really read "fulgor." It certainly has always seemed improbable that a star of such vast dimensions as Sirius must be should have so entirely changed its colour in less than 2000 years.

BRIGHT LINES IN STELLAR SPECTRA.—Mr. O. T. Sherman, in No. 149 of Gould's *Astronomical Journal*, brings together various observations of the bright lines which have been observed by Vogel or Copeland in the spectra of β Lyre, γ Argûs, R Geminorum, and some smaller stars, and compares them with Haselberg's observations of the low-temperature spectrum of hydrogen and the high-temperature spectrum of oxygen, and draws the inference that the stellar bright lines belong to these spectra. The inference seems scarcely warranted, however, for, on the one hand, the lines in the spectrum of hydrogen are so numerous that, wherever the star-lines lay, it would be easy to find lines near them, so that the accord would have to be very close for any such deduction to be safely based upon it; and, on the other, the observations of the lines in the stellar spectra are less accurate than Mr. Sherman seems to think. The slight differences in the recorded positions of the bright lines as given by different stars are probably indications simply of a roughness in the readings, and the lines are most likely the same in general in the different spectra. The following may be taken as rough mean positions for the bright lines in these interesting spectra—600 mm., 581, 568, 540, 466, together with the F line of hydrogen, and, in some cases, D_3 and the third line of hydrogen at 434, assuming that the lines are the same in the various spectra of the type. The close correspondence of the bright lines in R Geminorum to those observed by Cornu in Nova Cygni, 1876, indicates that we probably have there the coronal line 1474 K, the principal chromospheric lines, and the typical nebular line at about 500.

ASTRONOMICAL PHENOMENA FOR THE WEEK 1887 FEBRUARY 20-25

(FOR the reckoning of time the civil day, commencing at Greenwich mean midnight, counting the hours on to 24, is here employed.)

At Greenwich on February 20

Sun rises, 7h. 6m.; souths, 12h. 13m. $56^{\circ}78'$; sets, 17h. 21m.; decl. on meridian, $10^{\circ} 55' S.$; Sidereal Time at Sunset, 3h. 22m.

Moon (New on February 22) rises, 5h. 52m.; souths, 10h. 25m.; sets, 15h. 2m.; decl. on meridian, $17^{\circ} 6' S.$

Planet	Rises h. m.	Souths h. m.	Sets h. m.	Decl. on meridian
Mercury ...	7 33 ...	12 58 ...	18 23 ...	7 34 S.
Venus ...	7 49 ...	13 27 ...	19 5 ...	4 59 S.
Mars ...	7 38 ...	13 9 ...	18 40 ...	6 23 S.
Jupiter ...	23 16* ...	4 17 ...	9 18 ...	12 11 S.
Saturn ...	12 59 ...	21 8 ...	5 17* ...	22 23 N.

* Indicates that the rising is that of the preceding evening and the setting that of the following morning.

Feb.	h.	
20 ...	2 ...	Jupiter stationary.
22 ...	— ...	Annular eclipse of the Sun; visible only in parts of South America, Australia, and the South Pacific Ocean.
24 ...	17 ..	Venus in conjunction with and $1^{\circ} 17'$ north of the Moon.

Variable Stars

Star	R.A.	Decl.	h. m.
U Cephei ...	0 52.3 ...	81 16 N. ...	Feb. 20, 20 38 m
Algol ...	3 0.8 ...	40 31 N. ...	" 25, 20 17 m
W Virginis ...	13 20.2 ...	2 48 S. ...	" 25, 6 5 m
δ Libræ ...	14 54.9 ...	8 4 S. ...	" 22, 23 0 M
U Coronæ ...	15 13.6 ...	32 4 N. ...	" 24, 0 31 m
S Libræ ...	15 14.9 ...	19 59 S. ...	" 20, 23 19 m
U Ophiuchi ...	17 10.8 ...	1 20 N. ...	" 21, m
		and at intervals of 20 8	
β Lyre ...	18 45.9 ...	33 14 N. ...	Feb. 24, 4 0 m
W Cygni ...	21 31.8 ...	44 52 N. ...	" 24, m
T Pegasi ...	22 3.4 ...	11 59 N. ...	" 20, M
δ Cephei ...	22 25.0 ...	57 50 N. ...	" 23, 21 0 m

M signifies maximum; m minimum.

Meteor-Showers

February 23-25, near β Trianguli, R.A. 30° , Decl. $35^{\circ} N$
Also from Monoceros, R.A. 120° , Decl. $5^{\circ} S.$

GEOGRAPHICAL NOTES

It would seem that Dr. Oscar Lenz is only to leave Zanzibar this week. The *Times* Vienna Correspondent is mistaken in thinking that the Royal Geographical Society expects Dr. Lenz to come direct to London. He must, of course, first render his account to the Vienna Society, which sent him out; but after that, it is hoped, he will come to London and tell his story. It is possible that before leaving Zanzibar he may have an opportunity of giving Mr. Stanley the benefit of his experience. Mr. Joseph Thomson, in a letter to the *Times*, endeavours to show that Mr. Stanley is taking a too rosy view of the prospects of his expedition. Mr. Thomson naturally insists on the superiority of the Masai Land route over all others. Certainly Mr. Stanley exaggerated the difficulties of this route, and we are inclined to believe that, had it been selected, the expedition might have reached Emin Pasha sooner than by the Congo. It should be remembered that, even if all the vessels on the Middle and Upper Congo are available, they could not possibly convey a thousand people in one journey—a good authority assures us that there must be at least three journeys; so that, unless Mr. Stanley starts on his land journey with only one-third of his caravan, instead of 35 days after leaving Stanley Pool it will take 100 days to reach the mouth of the Aruwimi. At the same time we must believe that Mr. Stanley knows what he is about, and is not likely to lay himself open to the reproach of being so far out in his calculations.

In the official report, just issued, on the administration of Lower Burmah during 1885-86, and Upper Burmah during 1886, there are some interesting passages relating to the resources of the new British provinces. Agricultural products, such as rice, wheat, maize, and other cereals, are grown in large quantities. The country is believed to be rich in mineral resources, and the subject is at present under the examination of the Geological Survey. Meanwhile it is known that the country to the north-east of Mandalay is the richest, if not the only, ruby-

lucing tract yet discovered. As to gold and silver, nothing worthy is known. Jade and amber are found in parts, the most valuable of the Upper Burmah minerals is likely to be coal, of which there are certainly four fields, one of which already yielded excellent fuel.

DR. HOLUB, whose murder to the north of the Zambesi doubtfully announced, may be remembered as the author of "even Years in South Africa," published about six years ago. He set out some three years ago to march from the Cape to Cairo, partly for purposes of exploration, and partly to open up markets in Central Africa for Austrian commerce. He does not seem to have made much speed.

PROF. MIGUEL MARAZTA has made what seems a curious ethnological discovery in the valley of Rebas (Gerona) at the foot of the Eastern Pyrenees. There exists in this district a somewhat numerous group of people, who are called *Nanos* (dwarfs) by the other inhabitants, and as a matter of fact are not more than four feet in height (1'10 to 1'15 metres). Their features are fairly well built, hands and feet small, shoulders and chest broad, making them appear more robust than they really are. Their features are so peculiar that there is no mistaking them among others. All have red hair; the face is as broad as the forehead, with high cheek-bones, strongly developed jaws, and flat nose. The eyes are not horizontal but somewhat oblique, like those of Tartars and Chinese. A few straggling weak hairs are found in place of beard. The skin is pale and flabby. Men and women are so much alike that the sex can only be told from their clothing. Though the mouth is large, the lips do not quite cover the large projecting incisors. The *Nanos*, who are the most numerous of the other inhabitants, live entirely by themselves in small huts. They intermarry only among themselves, so that their peculiarities continue to be reproduced. Entirely without education, and without any chance of improving their condition, they lead the life of pariahs. They know their own names, but do not remember those of their parents, can hardly tell where they live, and have no idea of numbers.

JOHN HUNTER

THE Hunterian Oration was delivered on Monday afternoon in the theatre of the Royal College of Surgeons by the President, Mr. Savory, F.R.S., Senior Surgeon to St. Bartholomew's Hospital. After a few introductory remarks, Mr. Savory proceeded to say that surgeons with one voice have proclaimed the supremacy of Hunter above all who have ever studied surgery. Students of science have acknowledged him to be among the greatest of those who have in any age advanced human knowledge. He was, and is, beyond and above all surgeons, a philosopher in surgery. His idea of the subject of his thoughts was far more adequate than that of other men. He was supreme in the scientific method of his work. He understood much better than those around him how to engage in the interpretation of Nature; he knew best how to approach and to disclose truth. For he not only understood that the problems which lay immediately before him were, of all, the most complex and difficult to solve, but he could see also that they were not isolated but dependent ones. He saw in the necessary relation in which they stood to others only means by which they could be worked out; and on this understanding he resolved to investigate the questions desired to answer. Mr. Savory next spoke of the collection of the Museum of Hunter for collecting. His museum included, he said, not only—to use the words of Professor Flower—illustrations of life in all its aspects, in health and in disease; specimens of botany, zoology, palæontology, anatomy, physiology, and every branch of pathology; preparations made according to all the methods then known; stuffed birds, mammals, and reptiles, fossils, dried shells, corals, insects, and plants; bones and articulated skeletons; injected dried and varnished vascular preparations; dried preparations of hollow viscera, mercurial injections, dried and in spirit; vermilion injections; dissected preparations in spirit of both vegetable and animal structures, natural and morbid; undissected animals in spirit, showing external form or awaiting leisure for examination; calculi and various animal concretions; even a collection of microscopic objects, prepared by one of the earliest English histologists, W. Swanson; but it extended to minerals, coins, pictures, ancient utensils of mail, weapons of various dates and nations, and other objects called 'articles of vertu.' Hunter's labours in surgery were not referred to. He was ever searching for principles, but

strove to reach them only through facts. Facts always first, but never facts only; from facts to principles. He understood that all progress mainly depends on the power of grouping and uniting for some new purpose facts that have been discovered independently and that are daily being revealed, yet with little or no reference to the principles they are found to support. He saw that surgery, in his time, was but a rude, empirical art, consisting of little else than a knowledge of many facts which stood in no visible relation to each other, and of many more opinions which, for the most part, had no relation, or but a very distant one, to any facts whatever. He held that surgery should be raised from a collection of such creeds to the rank of a science, but this could be only by founding its practice upon some principles. The discovery of some, at least, of these principles was Hunter's final aim. But those principles could not be reached by guessing. They could be approached only through the orderly investigation of facts. But then an explanation of these facts themselves could be only through the truths of physiology. The signs of disease could be understood only by him who had studied the laws of life and health. An intelligent interpretation of the one could be only in proportion to a previous knowledge of the other. But the problems of life, of health, are presented to us in man in their most complex form—in a form so difficult that even Hunter could not solve it. They must be reduced to simpler terms through a study of the lower forms of life. Thus, with the ultimate aim of relieving human suffering, Hunter studied the phenomena of motion in plants. Nay, he went further, to crystals and other forms of inorganic matter; and he says: "The better to understand animal matter, it is necessary to understand the properties of common matter, in order to see how far these properties are introduced into the vegetable and animal operations." The singleness of purpose with which Hunter worked is made evident, Mr. Savory continued, not only in the actual result of his labours, for no human being with divided interests could rival such achievements, but in the record, as we have it, of the life he led. He gave not only the whole of his time—yes, the whole of it in no mere conventional sense—and all his great powers, his mind and body alike, to the one object of his life; but to this he sacrificed all that he possessed, all that he could gain. To this he devoted, without stint or scruple, his money, his friendships, all his other interests. What any other man would have considered impossible, he made practicable. And this to no personal end. He was careless of all rewards save that which was to him paramount, the discovery of truth. A noteworthy point in the character of Hunter appears to be found in the relation which, in him, thought bore to action. He combined in himself in a singular degree the power of conception and of execution. He not only saw much further, but he was able to do much more than most others. He saw as Bacon saw—and the idea was probably as original with him as with Bacon—that the systematic and thorough examination of facts was the first thing to be done in science, "and that, till this had been done faithfully and impartially, with all the appliances and all the safeguards that experience and forethought could suggest, all generalisations, all anticipations from mere reasoning, must be adjourned and postponed; and further, that, sought on these conditions, knowledge, certain and fruitful, beyond all that man then imagined, could be obtained." But he went immeasurably further than the great prophet of science in putting his conceptions to the proof in imperishable work on the lines he had laid down. "I only sound the clarion," said Bacon, proudly, "but I enter not into the battle." Hunter sounded a clarion the echoes of which are reverberating still, but he entered into the battle also, and was always found where the blows fell thickest, and we are in possession of the spoils. In his museum there is, at once, the clearest evidence of the idea and the richest fruits of execution. In speaking of Hunter's general education, Mr. Savory proceeded to say that if Hunter had received a good general education in early years he would have been all the better for it. He would have lost nothing. His mental powers could have been in no way impaired; on the contrary, enhanced. He would have recorded the results of his labours in better order, with more light and greater effect, and we should have had the advantage of a clearer revelation of his thoughts. But all this is very far from saying that Hunter was, not, in the strictest sense, an educated man. He was not, indeed, a scholar. If the subtle rendering of a Greek poet, or the skillful turning of a Latin verse be the sole test of culture, he gave no sign of it. Of ancient lore he was sadly destitute. In *Literis Humanioribus* he could have

had no place. But if a transcendent knowledge of Nature and her ways, if a firm and ample grasp of her noblest truths, be accounted education, if the devotion through a lifetime of gigantic intellectual powers and of a truly loving heart to the reverent study of God's works be culture, then Hunter, though not a man of letters, was surely a highly educated man. The fame of Hunter, after all, falls far short of him. It may, without exaggeration, be said that he is really greater than to most men, even to most surgeons, he appears to be. It is only after a review of the whole of his vast labours, in their mutual relation, not merely after a study of the merits of his numerous papers, each taken by itself, but in an attempt to apprehend the scheme to which all his labours were subservient, that we are in any measure able to realise the strength of Hunter's genius. Then, as the chief merit of his work is not of a character to catch at once the eye, even of one who searches for it, so his subject is not one of widespread or popular interest. Of all men who have achieved greatness, Hunter requires to be studied with most diligence, the more so because of the absence of all literary skill. And there can be no doubt that he shared the fate of all those who have been, like him, in advance of their time. He was so far beyond his contemporaries as to be, for the most part, out of their reach, and therefore they left him alone; and even his successors have not always found him out. It may, indeed, be said to have been almost by an accident that, in association with the possession of his museum, we have periodically a festival in honour of his memory. Such, then, at least in the eyes of one who, though from afar, has long and earnestly looked up to him, was John Hunter. Beyond all cavil, if the word have any meaning for us, he was a man of genius—a man supremely endowed with power and faculties for the discovery of truth. With little education at the outset of life, without the advantage of the schools, he found himself face to face with the deepest and most mysterious problems of Nature, and he was forthwith able to take full measure of the magnitude of the task. It seems never to have occurred to him that he could snatch an answer by surprise; that a solution could be reached by any short or sudden means. But his survey assured him that upon one plan only, but by that abundantly, could success be made certain. So with patience, which of itself has been called genius, he went back to the beginning. It was genius too, and that of the highest order, to discern, at so vast a distance, where the beginning lay. But there he placed himself, and from that point went forward only when he had made each footstep sure. Who shall say that his imagination was not fertile, or that he faltered in the use of it? Yet no seductive theory tempted him into undue haste, and though sometimes drawn aside by a specious speculation, he seems hardly ever to have been lost in an unsound conclusion. And when he fell, the treasures he had won were found not only in the multitude of facts he had garnered, or even in the principles which, by virtue of the facts he had discovered, were made plain, but also in the very plan and purpose of his work. For, from the height on which at length he stood, not only can the path he trod be clearly traced, but the highway thenceforward is disclosed. So is the greatness of John Hunter to be estimated, not only by what he discovered, but rather by the lesson and example of his work. Truly it may be said of him that he did much. Truly it may be said of him that he showed how much more there is to be done. "He being dead yet speaketh," still speaks to us as no other man before or since has spoken. But when and where can his voice be heard most plainly? Are the spirits of those who have shaken off "this muddy vesture of decay" permitted to revisit the scenes of their earthly labours? Can they still be with us on our way? If the soul of this mighty son of science is ever in our midst, surely his favourite haunt must be now within these walls—in the museum which will soon almost surround us, at once his most graphic and glorious monument. The memory of Hunter, like the memory of the greatest men of every age, is imperishably enshrined. Art, in her noblest efforts, has striven to make his form familiar to us. His name is stamped in indelible characters on the records of human progress. But, before all, he lives in, and draws the breath of life from, his own immortal works. And of these none can be so truly a memorial of the very man as this; no other can so resemble him, can possess so much of him, can tell so fully of what he was; can so perpetuate him in the vast store of facts, in the purpose for which they are set forth, in the illustration of principles, in the suggestion of truths beyond those it

can show, above those it can reach—in all this, I say, no memorial, however majestic, can rival our museum. The foundation of this with his own hand and his whole heart he laid; it has grown, and still is growing, from his strength, and it must be made for ever worthy of his name.

UNIVERSITY AND EDUCATIONAL INTELLIGENCE

OXFORD.—The following new Examiners have been appointed in the Natural Science School: Mr. V. H. Veley (Chemistry), Dr. W. H. Gaskell and Prof. Ray Lankester (Biology), Mr. J. V. Jones (Physics), Mr. W. W. Fisher and the Rev. F. J. Smith are to be Examiners in the Pass Schools.

The Sibthorpe Professorship of Rural Economy is now vacant, and candidates for it are requested to send in their applications to the Registrar of the University before March 10.

The Board of the Faculty of Medicine has issued a list of subjects to be offered in the first examination for the B.M. degree under the new medical statute.

Scholarships in Natural Science are announced for competition at Merton, Corpus, and Queen's, and at New College.

SCIENTIFIC SERIALS

American Journal of Science, January.—The Muir glacier, by G. Frederick Wright. The paper contains an exhaustive study of this interesting glacier, which lies in the Alpine region of Alaska at the head of Muir Inlet, Glacier Bay, in 58° 50' N. lat., 136° 40' W. long. It forms a frozen stream some 5000 feet wide by 700 deep, entering the inlet at a mean rate of 40 feet, or 140,000,000 cubic feet, per day, during the month of August. The vertical front at the water's edge is from 250 to 300 feet, and from this front icebergs are continually breaking away, some many hundred feet long, with a volume of 40,000,000 cubic feet. The glacier appears to be rapidly retreating, there being indications that even since the beginning of this century it has receded several miles up the inlet, and fallen 1000 or 1500 feet below its former level.—On the age of the coal found in the region traversed by the Rio Grande del Norte, by C. A. White. The carboniferous beds occurring at various points in this region vary greatly in quality, but none of them appear to be earlier than late Cretaceous age.—The viscosity of steel and its relations to temper (continued), by C. Barus and V. Strouhal. Among the chief results of the authors' further experiments, as here described and tabulated, is the light thrown on the crucial importance of the physical changes which steel undergoes during annealing at high temperatures between 500° and 1000° C. Within these limits occur several nearly coincident phenomena: such as Gore's sudden volume expansion; Tai's sinuously broken thermo electric resistance; Gore-Baur's sudden disappearance of magnetic quality; the passage of carbon from uncombined to combined; Jean's critical cementation temperature; and the authors' own unique maximum of viscosity.—On the nature and origin of lithophysæ, and the lamination of acid lavas, by Joseph P. Iddings. The data upon which the conclusions here stated are based were obtained from a study of the various forms of structure and crystallisation assumed by acid lavas in cooling, as observed while prosecuting the work of the United States Geological Survey in the Yellowstone National Park under Mr. Arnold Hague. The lithophysæ, composed of prismatic quartz, tridymite, soda-orthoclase, fayalite, and magnetite, appear to be of aqueo-igneous origin, having been produced by the action of the absorbed gases upon the molten glass from which they were liberated during the crystallisation consequent upon cooling. It also seems highly probable that the differences in consistency and in the phases of crystallisation producing the lamination of this rock were directly due to the amount of vapours absorbed in the various layers of the lava and to their mineralising influence.—The latest volcanic eruption in Northern California, and its peculiar lava, by J. S. Diller. The volcanic district here described is that of the so-called "Cinder Cone," near Snag Lake, North California, where the recent character of the eruptive phenomena is most striking as compared with other outbursts in the same region. The lava field, some three square miles in extent, is of basaltic type, but remarkably anomalous in containing numerous grains of quartz, and very high percentages of silica and magnesia with correspondingly low quantities of the oxides of iron.—On the texture of massive rocks, by

orge F. Becker. From his researches the author infers that porphyries may form at any depth and no matter how slowly the temperature of the magma may sink, while granular rocks can rarely ever have been thoroughly fluid or homogeneous, but are often consolidated at pressures extremely moderate compared with those at which it is certain that porphyries would form.—A fifth mass of meteoric iron from Augusta County, Virginia, by George F. Kunz. This specimen, which comes from the same place where was found the largest of the three masses described by Prof. Mallet, yielded, on analysis: iron 90.293; nickel, 8.848; cobalt, 0.486; phosphorus, 0.243; carbon, 0.177; traces of copper, tin, sulphur, silica, manganese, chromium, and chlorine.—Note on the origin of comets, by Daniel Kirkwood. It is argued that, although most comets are of interstellar origin, some of short period may have had their rise within the solar system.—The bichromate of soda cell, by Iwyn Lewis Harding. The experiments here described tend to show that this is a most efficient cell, whose effectiveness, as far as its constancy is concerned, might be materially increased by interchanging the positions of the electrodes with their surrounding liquids, after the fashion of the Fuller cell.

SOCIETIES AND ACADEMIES

LONDON

Royal Society, January 13.—“Supplementary Note on the values of the Napierian Logarithms of 2, 3, 5, 7, and 10, and the Modulus of Common Logarithms.” By Prof. J. C. Jamieson, F.R.S.

In vol. xxvii. of the Proceedings of the Royal Society, 1884-85, the author has given the values of the logarithms referred to, and the value of the modulus, all carried to 260 places of decimals.

The calculations in that paper were carried to several more decimal places, but the application of an equation of condition which supplied the means of testing the accuracy of the whole work, showed that errors had crept into the work which vitiated the results beyond 263 places of decimals.

Through inadvertence, however, the results were printed in the above paper exactly as they were given by the calculations, though several of the later decimals, especially in the value of the modulus, were known to be wrong.

The author has now succeeded in tracing and correcting the errors which occurred in the former calculations, and the equation of condition which tests the accuracy of the work is now satisfied to 274 places of decimals.

The present paper gives the parts of the several logarithms concerned which immediately follow the first 260 decimal places already given in the former paper, and likewise the corrected value of the modulus, which is found to be—

= 4.3429	44819	03251	82705	11289	13117	00508	22945	97005	80366
65661	14453	78316	58640	49238	87077	47217	24949	73843	17483
18706	10674	47063	03773	64167	92371	58953	90656	92210	64662
81226	58521	27086	56807	03295	97370	86965	88266	88331	16360
77384	90514	28443	48666	76864	65360	85175	50113	21234	76553
43543	43573	17253	83562	21864	25				

which is true to 272 or 273 places of decimals.

February 10.—“Contributions to the Metallurgy of Bismuth” by Edward Matthey.

“An Inquiry into the Cause and Extent of a Special Colouration between certain Exposed Lepidopterous Pupæ and the surfaces which immediately surround them.” By Edward B. Boulton.

Linnean Society, February 3.—W. Carruthers, F.R.S., resident, in the chair.—Dr. M. C. Grabham and Capt. G. Lingate were elected Fellows of the Society.—Mr. G. Maw exhibited a *Narcissus cyclamineus* grown by him from bulbs sent by Mr. A. W. Tait, of Oporto. The plant in question as known to Parkinson (1640), afterwards was lost of, and re-discovered by Mr. Johnston, near Oporto, in 1885.—Mr. Maw showed a drawing of *Crocus Karducharum*, and another, for comparison, of *C. somatus*, from the Taurus, to which it is allied.—Brigade-Surgeon J. E. T. Aitchison read a paper on the fauna and flora of the Afghan boundary. The zoological collection obtained comprised, in round numbers, 20 species of mammals, 130 species of birds, 35 species of reptiles, 7 species of fish, and over 100 species of insects. Among these, many are new to science. Of special interest is the mole-like rat, *Hobius fuscicapillus*, hitherto only known from the type ob-

tained forty years ago at Quetta. In certain places the ground is riddled with the burrows of this and other rodents. The geographical range of the tiger goes east and north to Bala Murghab; that of the cheetah to the valley of the Heri-rud. A pheasant (*Phasianus principalis*) and woodpecker (*Greenus gorii*) are new. With some exceptions, the birds are chiefly migratory, their arrival in spring following each other in quick succession. The Biahmini duck (*Casarca rutula*), unlike its congeners, nests and remains throughout the year. The most abundant species of birds are, among the genera *Saxicola*, *Lanius*, *Sylvia*, *Motacilla*, and *Emberiza*. An adult fine example of *Nata oxiana* is a museum acquisition, as the species heretofore has only been recognised from young undeveloped specimens. Regarding the insects, 20 are new, though, taken as a whole, the insect fauna resembles that of Arabia and North Africa, rather than that of India proper. The botanical collections amount to 800 species, and probably 10,000 specimens of plants. Over 100 are new to science. The author gave some account of the physical features of the districts traversed, and of the climate. Taking these into consideration, he states that the plants do not represent what is generally recognised as an Oriental flora, being chiefly composed of northern Persian and Arabian forms, augmented by Central Asian and Siberian types, with a few West Himalayan or Tibetan, and still fewer representing the Punjab or Scind. Beside these are a fairly representative local flora; say, one-sixth of the collection. *Funiperus excelsa* is the only indigenous conifer; neither oaks nor species of *Esculus*, *Olea*, or *Myrtus* were met with. *Populus Euphratica* forms forests in the river-beds, but as long as the tree is situated near water it is indifferent to altitude. Out of 75 natural orders, Compositæ and Leguminosæ greatly preponderate over the others, containing 81 and 80 species respectively. In Compositæ, *Cousinia* heads the genera with 18 species; *Centaurea* has 10 species. Of 80 species of Leguminosæ, 39 belong to the genus *Astragalus*, 14 of these being new. Of 61 species of Gramineæ, all are well known. The Cruciferae collected number 56 species; several are new. Chenopodiaceæ follow with 39 species, Labiatae with 35, Boraginaceæ 32, Umbelliferae 30, Caryophyllaceæ 30, Rosaceæ 27, Liliaceæ 26, Euphorbiaceæ 16, Polygonaceæ 15, Ranunculaceæ 14, Rubiaceæ and Cyperaceæ each 13, Scrophulariaceæ and Plantagineæ 10 and 11 respectively. The orchards at some of the villages are surrounded with high walls, inside which is a row of mulberry-trees grown for the breeding of silkworms. In the Afghan gardens, beet-root, carrots, turnips, cabbages, radishes, and tomatoes are raised, and these are of excellent quality. In the fields, besides wheat, rye, and barley, opium, tobacco, melons, and certain oil-seeds are cultivated. Cotton is grown, but the quality of the fibre is poor. Several plants of pharmaceutical value flourish—Galbanum, Ammoniacum, &c., and of these the author gave a full account.

Zoological Society, February 1.—Dr. St. George Mivart, F.R.S., Vice-President, in the chair.—Mr. F. Day exhibited and made remarks on a hybrid fish supposed to be between the pilchard and the herring, and a specimen of *Salmo purpuratus* reared in this country.—Mr. W. L. Sclater exhibited and made remarks upon some specimens of a species of *Peripatus* which he had obtained in British Guiana during a recent visit to that country, and added some general observations on the distribution and affinities of this singular form of arthropods.—Mr. A. Thomson read a report on the insects bred in the Society's Insect House during the past season, and exhibited the insects referred to.—A communication was read from Dr. B. C. A. Windle, containing an account of the anatomy of *Hydromys chrysogaster*.—Mr. Martin Jacoby read a paper containing an account of the Phytophagous Coleoptera obtained by Mr. G. Lewis in Ceylon during the years 1881, 1882. About 150 new species were described and many new generic forms.—Mr. F. E. Beddard read some notes on a specimen of a rare American monkey, *Brachyurus calvus*, which had died in the Society's Gardens.—Mr. Oldfield Thomas read a note on the mammals obtained by Mr. H. H. Johnston on the Camaroons Mountain.—A paper was read by Capt. Shelley, containing an account of the birds collected by Mr. H. H. Johnston on the Camaroons Mountain. The collection contained thirty-six specimens referable to eighteen species, and of these four were new to science.—Mr. G. A. Boulenger read a list of the reptiles collected by Mr. H. H. Johnston during his recent visit to the Camaroons Mountain.—Mr. Edgar A. Smith read a paper on the Mollusca collected at the Camaroons Mountain by Mr. H. H. Johnston,

and gave the description of a new species of *Gibbus*, proposed to be called *Gibbus johnstoni*, of which specimens were in the collection.—A communication was read from Mr. Charles O. Waterhouse, containing a list of some coleopterous insects collected by Mr. H. H. Johnston on the Camaroons Mountain.

Geological Society, January 12.—Prof. J. W. Judd, F.R.S., President, in the chair.—The President announced the sad loss which the Society had sustained since the last meeting by the death of Mr. John Arthur Phillips, F.R.S., who had been for several years a valuable member of the Council, and one of the Vice-Presidents of the Society.—The following communications were read:—The Ardtun leaf-beds, by J. Starkie Gardner, with notes by Grenville A. J. Cole. The description of these beds by the Duke of Argyll thirty-five years ago indicated that enormous tracts of trap in the Inner Hebrides were of Tertiary age. Prof. Edward Forbes, who described the leaves, inclined to the idea that they might be Miocene; but in estimating the value of this conjecture, we must remember that at the time the existence of Dicotyledonous leaves of similar aspect, but of undoubtedly Cretaceous age, was quite unsuspected, and that no typical Eocene flora had then been properly investigated or described. Prof. Heer adopted the opinion that the age of this formation was Miocene, and unfortunately extended its application to formations containing similar floras in Greenland and elsewhere. The writer of the present communication tried to show that instead of belonging to the Miocene, these floras are of Eocene age, and in fact older than the Thanet beds. He also re-described the plant-beds, and maintained that they are part of a rather extensive series of sedimentary rocks intercalated among the traps.—On the Echinoidea of the Cretaceous strata of the Lower Narbadá region, by Prof. P. Martin Duncan, F.R.S.—On some Dino-aurian vertebræ from the Cretaceous of India and the Isle of Wight, by R. Lydekker.—Further notes on the results of some deep borings in Kent, by W. Whitaker.

January 26.—Prof. J. W. Judd, F.R.S., President, in the chair.—The following communications were read:—On the correlation of the Upper Jurassic rocks of the Jura with those of England, by Thomas Roberts.—The physical history of the Bagshot Beds of the London Basin, by the Rev. A. Irving. The author, in reviewing the position taken up by him, attempted to estimate the value of such palæontological evidence as exists, and insisted on the importance of the *physical* evidence in the first place. He gave reasons for considering the evidence of pebbles, pipe-clay, derived materials, iron concretions, percentages of elementary carbon (ranging in the more carbonaceous strata up to nearly 2½ per cent.) taken together with the evidence of carbon in combination, as adduced in former papers, *fresh-water Diatoms* (now, perhaps, recorded for the first time in the Middle and Lower Bagshot), and the microscopic structure of the sands and clays, as furnishing such a cumulative proof of the fluvial and delta origin of the majority of the Middle and Lower Bagshot Beds, as can hardly be gainsaid; while he regarded the wide distribution of the Sarsens as indicating, along with the fauna, a much greater areal range formerly of the Upper Bagshot than of the strata below them.

Mineralogical Society, January 11.—Mr. L. Fletcher, President, in the chair.—Messrs. A. Pringle, G. T. Prior, and J. M. Thomson, were elected Members.—The following papers were read:—On a specimen of meteoric iron found at Yundagin, West Australia, in 1884, by Mr. L. Fletcher, President.—Additional notes on the feldspar from Kilima-njaro, by Mr. L. Fletcher, and Mr. H. A. Miers.—On the occurrence of greenockite in a new locality, by Prof. M. F. Heddle.—Note on a form of calcite from Heilim, Sutherlandshire, by Prof. M. F. Heddle.—Note on the occurrence of bismutite in the Transvaal, by Mr. H. Louis.—Notes on celestine from Gloucestershire and on apatite from East Cornwall, by Mr. R. H. Solly.—Note on the presence of lead in calcite from Leadhills, by Mr. J. Stuart Thomson.—On the use of gnomonic projection, by Mr. H. A. Miers.—Prof. Judd exhibited a specimen of a new terre-trial alloy of iron and nickel (Ni_3Fe) discovered in New Zealand by Prof. Ulrichs.—Colonel MacMahon exhibited a crystal of sapphire from a vein which had been revealed by a landslip in the south-east of Cashmere, about the year 1880.

PARIS

Academy of Sciences, February 7.—M. Gosselin, President, in the chair.—Movements of a bird's wing represented according

to the three dimensions of space, by M. Marey. In continuation of his first communication on the flight of birds, the author here shows, by a series of chrono-photographic images, how the movement of the wing is made according to the three dimensions of space. One of the illustrations gives a synoptic view of the projections of the wing on three different planes at ten successive instants of a single revolution, thus containing all the elements necessary to determine the continuous action of the wing. Further chrono-photographic experiments are promised, which will convey a complete representation of all the alar movements, and in general of all notions relating to the kinematics of flight.—On the red fluorescence of alumina, by M. Lecoq de Boisbaudran.—On the composition of the ashes of cider, by M. G. Lechartier. The study of the composition of the ashes which ciders yield by incineration is here undertaken, both for its scientific interest and on account of the indications it may give of their purity. The author inquires whether this composition presents uniform distinctive characters whatever its local origin, and finds that the ashes of the cider apple are in no way modified by the nature of the soil. He also shows the differences existing between the ashes of the fruit, the leaf, and the wood of the apple-tree.—Experiments relative to the anti-phyloxeric disinfection of the grape-vine, by MM. Georges Couanon and Etienne Salomon. The varying results of M. Balbiani's already described process are here reported from various districts throughout France for the year 1886. Although generally satisfactory, the remedy was found in some cases to be as bad as the evil, the failure being attributed either to the unhealthy state of the plant or to climatic or other local conditions.—Fresh researches on the action exercised by cuprous preparations on the development of the Peronospora of the vine, by MM. Millardet and Gayon. These experiments, carried out last September, fully confirm the conclusion already anticipated by the authors, that in these mixtures the essential prophylactic agent is the copper dissolved by rain-water and dew.—Memoir on the developments of naval geometry, with application to the calculations of stability, by MM. Guyou and Simart. The authors consider their method as a distinct improvement on those of their predecessors, Charles Dupin, Bravais, Rankine, Reech, Leclert, and Daynard. Thanks to their new formulas, the still laborious calculations which are required even by Daynard's method (recently crowned by the Academy) are much shortened.—Geographical co-ordinates of Punta-Arenas, by M. Cruls. For this important station the following values have been recently determined: Latitude $53^{\circ} 9' 38''$ S.; Longitude $4h. 43m. 36''$ 09s. west of Greenwich.—Equatorial observations of the new comets, Brooks and Barnard, made at the Observatory of Algiers with the 0.50m. telescope, by MM. Trépied and Rambaud.—On entire algebraic series, by M. L. Lecomte.—Some experiments on aerial eddies, by M. Ch. Weyher. The experiments here described deal with waterspouts in the open air, with whirlwinds in an inclosed space, with the attraction produced by vortices, and with the variation of temperature in an eddy.—On the electrolysis of alkaline solutions, by M. Duter. In the electrolysis of aqueous solutions of potassa, soda, baryta, or lime, the volume of oxygen liberated on the positive electrode is considerably less than half that of the hydrogen liberated on the negative electrode. But with a wide platinum plate for positive and a fine platinum wire for negative electrode, the author obtains one volume only of oxygen for four of hydrogen. In the electrolysis of alkaline solutions there appear to be formed small quantities of a superoxygenated compound combined with an alkali in such a way that it cannot be liberated by ebullition but only by an acid. This appears to be a peroxide of hydrogen, by the existence of which M. Berthelot explains various reactions, such as that of the permanganate of potassa on oxygenated water.—The principle of maximum labour and the laws of chemical equilibria, by M. H. Le Chatelier. It is shown that under a single law may be reduced all the phenomena without exception of vaporisation, allotropic transformation, and dissociation from -200° C., boiling-point of oxygen, to $+1000^{\circ}$ C., point of dissociation of the oxide of iridium.—Action of the oxide of lead on some dissolved chlorides, by M. G. André. Some true oxychlorides are here described, which the author has obtained by studying the action of certain oxides on the solutions of the alkaline earthy chlorides.—Combinations of the glycerinate of potassa with the monatomic alcohols, by M. de Forcrand. The glycerinates here studied are those of methylic, ethylic, propylic, amylic,

THURSDAY, FEBRUARY 24, 1887

THE OWENS COLLEGE

The Owens College: its Foundation and Growth, and its Connection with the Victoria University, Manchester. By Joseph Thompson. (Manchester: J. E. Cornish, 1886.)

THE future historian of the progress of education in England during the nineteenth century will regard the foundation of the Owens College, Manchester, an event of the first importance. The idea of establishing, in the midst of our great manufacturing towns, institutions devoted to the higher learning was not new. The experiment had been tried in various forms in Manchester itself, but had always failed. A College of Arts and Sciences was founded in 1783 by some of the leading men in the town and county, but, owing to "a superstitious fear of a tendency of a taste for knowledge to fit young men for ordinary business, this excellent institution had not a long existence." In 1836 meetings were held, and a scheme was drawn up for the establishment in Manchester of a College for general education. In the spring of 1837 it was proposed to elect a Medical Faculty in connection with the College; but, before another year passed, the scheme was abandoned, as very few pupils came forward.

Institutions which aimed chiefly at the preparation of candidates for the Nonconformist ministry were more successful. The Manchester Academy, and the Lancashire Independent College, founded in 1786 and 1840 respectively, are active now; but while the latter is in close alliance with the Owens College, the former has migrated to London. It was not the desire of business men for culture or for technical education, but a demand on the part of Nonconformist professional men for a training which the tests imposed by the older Universities barred them from obtaining there, which enabled these institutions to survive when others failed. Nay, more; the strongest argument which George Faulkner brought to bear on his friend John Owens, to persuade him to enter the will by which he had made him his heir and to found a College, was "that as he had such strong prejudices against the tests imposed at the older English Universities, he could enable young men to obtain an education equal to that of the favoured institutions, without these hindrances."

But, whether or no Owens was influenced mainly by feeling of indignation at an injustice which has now been long removed, his benefaction has produced results even wider than those which have followed the abolition of the tests he disapproved. The Owens College was the first example of the successful establishment of a manufacturing town of an institution which gave to its comers a University education. When Manchester had proved that success was possible, others were not slow to follow where she had led. The Owens College was opened in 1851. For some years it seemed that it was to share the fate of its predecessors. At length the scheme turned, and the passing of the Owens Extension Bill and the passage of the Owens Extension Bill Act in 1870 marked the attainment of assured success. In that year Newcastle established a College

of Physical Science, the Yorkshire College was founded in Leeds in 1874, and now no large town considers its educational equipment complete if it cannot point to a "University College" in its midst. The importance of this result can hardly be exaggerated. In the midst of a great democratic movement, it has been practically proved that culture and learning need not be the exclusive property of the few. The provincial Colleges have made it possible for the young artisan to obtain instruction from, and to test his own abilities by contact with, teachers who are masters of the subjects they profess. The Owens College is, no doubt, as far as its day classes are concerned, a middle-class institution. But its authorities have also developed a system of evening lectures, by means of which many a working-man has made his first step upwards from the ranks.

At first, the Council and Staff of the College had to face the difficulties which beset pioneers. The religious difficulty met them at the outset. An early attempt at amalgamation with the Medical School failed. The Professors one and all complained that, through lack of a sound elementary training, their students were unable to profit by the instruction they gave. "The worst that can be said of [the College]," remarked the *Manchester Examiner* of July 20, 1858, "is that it is too good for us. It is out of place here, just as a missionary may be said to be out of his place on the coast of Africa. He offers the Gospel, and the people want Sheffield blades. . . . The crowd rolls along Deansgate, heedless of the proximity of Plato and Aristotle. . . . And where is poor learning all the while? Going through its diurnal martyrdom of bootless enthusiasm and empty benches."

The men who had the fate of the College in their hands were not, however, daunted by cold comfort such as this. Gaps in the Staff were promptly filled up. Principal Scott resigning on account of ill health, his place was filled by Prof. Greenwood, and Mr. Roscoe was selected to fill the vacant Chair of Chemistry. Nor was this confidence misplaced. Almost contemporaneously with these appointments, the dwindling number of students began to increase, and within some half-dozen years the difficulty of preventing failure was followed by the difficulties of providing for success. In 1864 we hear of the "insufficient or unsuitable accommodation furnished by the College buildings." In 1865 Prof. Clifton reported that the percentage of carbonic acid in the air of his lecture-room at the conclusion of a lecture was more than four times the maximum consistent with health. Students of the biological sciences complained of the difficulty of finding admission to well-arranged and complete collections of natural history.

It would take too long to follow step by step the advance of the College, but in reading Mr. Thompson's full account of the way in which each difficulty was overcome, the reader cannot but be struck with the fact that the work of the Council and Staff was essentially that of pioneers. Everything had to be discussed; nothing was determined by precedent. In 1860 it was decided that a Professorship of Physics should be founded, but before this step was taken it was thought necessary to inquire not only whether the students were numerous enough and the College rich enough to warrant the change, but

whether a Professorship of Physics was in itself a desirable thing. Professors De Morgan and Stokes were asked for formal written opinions on this knotty point. The new Chair was only established when it was held to have been proved that the field of mathematics and natural philosophy was wide enough for the employment of two labourers in different parts. There can be no doubt that the College was remarkably fortunate in the members both of its Council and of its Senate. The Neilds—father and son—Mr. Ashton, Mr. Oliver Heywood, and many others, worked as though their personal interests were all bound up in the success of John Owens' bequest. They succeeded in filling the Chairs with men of the most brilliant abilities. To mention only some of those whose connection with the College has now ceased, it is evident that an institution which has within a few years commanded the services of men like Sir Henry Roscoe and Professors Frankland, Clifton, Jevons, Jack, and Gamgee, must have deserved the success it has won.

Nor is it uninteresting, regarding the Owens College as the pioneer in a great movement, to observe how largely that movement has been and is being directed by men who themselves owe much to the Manchester institution. By glancing only at the list of those who have held the office of demonstrator in the physical or chemical laboratories, or of lecturer on mathematics, we observe that the Professorships of Physics in the Mason College, Birmingham; of Chemistry in Anderson's College, Glasgow, the Yorkshire College, Leeds, the College of Physical Science at Newcastle-upon-Tyne, and the Firth College, Sheffield; and the Professorships both of Chemistry and Physics in the Normal School of Science, South Kensington, and in University College, Dundee, are or have been held by *alumni* of the Owens College.

When once the College began to grow, it grew rapidly. The change wrought in fifteen years was remarkable. Besides the establishment of numerous new professorships, the Manchester Natural History and Geological Societies handed over their collections to the College as the recognised centre of scientific learning in Manchester. The College and the Medical School were fused into one institution. The handsome buildings in Oxford Road were erected upon land, and partly also with funds, furnished by an Extension Committee, which numbered among its members many of the best-known men in the town, and of which Dr. Watts, whose death Manchester has recently had to deplore, was secretary.

When this was accomplished, the College proceeded to claim the status and powers, as it had already proved its capacity for doing the work, of a University. This question affected interests other than those of Manchester itself. The Yorkshire College, Leeds, then very recently founded, and immature, had sufficient faith in its own future to claim a share in determining the conditions on which a new University was to be established in the North of England. This claim was at first enforced by a formal opposition to the Owens College scheme, on certain specified grounds. Whether a Leeds historian would agree with Mr. Thompson that the opposition "was not based upon accurate knowledge" may be open to question. It may be that the mistake was on the other side, and that the Owens College authorities had not as yet

fully recognised the magnitude of the movement to which they themselves had given so great an impulse. However this may be, the controversy seems to have been conducted with fairness and good temper, and to have resulted in an agreement which left none but kindly feelings behind. The Council of the Owens College received satisfactory assurances that their Leeds friends did not desire to share the advantages to be conferred by the Charter of the University till they had made their College worthy of representing it in Yorkshire. On the other hand, they conceded the demand of Yorkshire that the name of the University should not be that "of a town or of any person whose claims to such distinction are merely local." A compromise was arrived at on the other point to which importance was attached. Leeds desired that the Governing Body of the University should be separate and distinct from that of the Owens College, and that it should have power "to incorporate the Owens College and such other institutions as may now or hereafter be able to fulfil the conditions of incorporation laid down in the Charter." This condition was agreed to, with the modification that the Owens College should be named in the Charter as the first College of the University, and that thus its incorporation should be simultaneous with and not posterior to the foundation of the University itself. Finally, a joint deputation from Lancashire and Yorkshire petitioned the Crown in favour of the establishment of the new University. The Charter was granted in 1880. The Owens College was constituted the first College of the University, and though the Yorkshire College has not yet joined it, University College, Liverpool, has recently been admitted as the second member of the federation.

Mr. Thompson's work appropriately ends with the flattering tribute paid by his fellow-citizens to Sir Henry Roscoe by his election as Member of Parliament for one of the divisions of Manchester, and with the expression of the regret of the Council at the severance of his connection with the College. The success of the Owens College is due to no one man, but to no one man more than to Sir Henry Roscoe. His withdrawal may fitly mark the termination of the period of struggle with initial difficulties. The main work of organisation is over. The chief outlines of the scheme for bringing industry into contact with culture and with technical education are drawn. It remains for the Owens and her sister Colleges to fulfil the task on which they are now fairly embarked.

We believe it is not unlikely that in carrying on their work the authorities of the Victoria University may find it necessary to appeal to the Government for a contribution towards the University funds. It will of course be easy to say that as Manchester and Liverpool have done so much they may be left unaided to do more. In forming an opinion upon this question it will be well for the public to remember that, whereas the Universities or Colleges in Edinburgh, Glasgow, Aberdeen, St. Andrews, Aberystwith, Bangor, Cardiff, and the Queen's Colleges in Ireland receive subventions from the State which amount in some cases to between 40,000*l.* and 50,000*l.* per annum, English higher education in provincial towns has been entirely provided by unselfish private enterprise, with some assistance in Newcastle from the University of Durham, and

elsewhere from the Clothworkers' Company and others of the City Guilds. As far as help from Parliament is concerned, England as usual has to find its share of the money and reaps none of the advantage. It is surely not too much to hope that, if 8000*l.* a year is allotted from the public funds to Colleges which supply the wants of Aberystwith and Bangor, it will not be considered impolitic to help from the National Exchequer the magnificent and national work which has been and is being done in the North of England.

But to return to the book before us. It is fortunate that while the memory of the men who initiated the undertaking is still fresh, and while most of those who carried it out are still with us, an historian such as Mr. Thompson has been found for the Owens College. He has given, not merely the public story of the institution, but short histories of many of those who were closely connected with it and who have now passed away. He has evidently had access to authentic documents and other sources of accurate information, and he has produced a work which will be read with interest by many who have in the past known but little of the Owens College and its founders.

ANDERSON ON HEAT AND WORK

On the Conversion of Heat into Work. By W. Anderson, M.Inst.C.E. (London: Whittaker and Co., and George Bell and Sons, 1887.)

VERY few modern books on Engineering contain what can truly be called accurate science; one of whose special characteristics is the use of each term *in one definite sense only*. In other words, take at random a work on any branch of Engineering, and you find, in every page, more than one sentence which, if it be read as a scientific statement, is simply inaccurate. Of the exceptional works the majority consist of those written by the late Prof. Rankine. He seems to have left no successor, so far as this department of applied science is concerned; and the book before us strongly supports the notion. It gives, in a succinct but comprehensive form, an introduction to the modern Dynamical Theory of Heat, treated almost entirely from the practical Engineer's point of view. It is obviously written by a man who knows his subject, and it is therefore presumably written in terms intelligible to those for whom it is designed. It thus affords a good opportunity of making some further remarks upon the strange line of separation which has unfortunately been drawn between the vocabularies (or, rather, the dictionaries) of Pure and of Applied Science. In using this opportunity, for the purpose stated, we do not attack the present work in particular; we attack the mass of works on Engineering, of which it is a high-class specimen.

From the purely scientific point of view there are two prominent faults in the majority of such works as that before us. The first is the habitual use of a special "vernacular"; not so outrageous, perhaps, as "pidgin" English, but quite on a par with a "wire," a "cable," an "aniline," and such-like monstrosities of recent American origin. Were the words of this vernacular different from those of strict science, our only complaint against their use would be that we should have to learn what would

be practically a new language before we could read an Engineering book. But they are, in the main, the same words; and yet each stands for other than the usually accepted meaning. Thus we constantly find pressure given as so many tons per square inch (sometimes the word "square" is omitted). Now, tons per square inch, or pounds per square foot, refer to matter and not to force. They measure, in fact, what is called surface-density. This is altogether "most tolerable, and not to be endured."

The second fault is more grave. It consists in the fundamental misuse of well-settled scientific terms, which the author of an Engineering book usually perpetrates whenever (for a moment) he deserts his vernacular and passes from the applied to the pure part of his subject. We remark in passing that, in the very first page, our author speaks of Mayer's EXPERIMENTAL demonstration of the equivalence of heat and work! This shows how deep a root has been taken by the extravagant laudations of Mayer, which were so common twenty years ago, but which have long since been thoroughly exploded.

Now, to faults of the first class mentioned above. We quote only a few of the more racy passages we had marked; and here, as in the subsequent examples, we introduce (to save comment) Italics where they seem desirable.

"Accelerating forces, *that is* forces acting steadily for a time." This may be the Engineer's vernacular, but it has no necessary connection with the use, in English, of the term "accelerating force."

"Dividing (3,912,400 *foot-pounds* per minute) by 33,000 *foot-pounds*, we get 119.4 *horse-power*!" Put this in the form "dividing 500*l.* a year by 50*l.* we get 10*l.* a year," which contains essentially the same absurdity, and we can scarcely fancy that our author would have let it stand; although in its above form it is put as Engineers too commonly put it.

"The heavenly bodies, *moving at uniform velocities for ever* are instances of *potential energy*." This is the Engineer's way of saying that since there is no change of kinetic, there can be no change of potential, energy.

"When we speak of perfectly elastic substances, we do not mean those which, like india-rubber, have a great range of elasticity." But, though this is true of Engineers, it is not true of purely scientific men. Think of air, for instance.

"Endowed with energy competent to produce the *sensation of 100° Fahr. of heat*." Here the Engineers pick a quarrel with the Physiologist as well as with the Physicist.

As explained above, all this is merely the licence which practical men take with scientific terms. As the book is written for such men, perhaps we ought not to complain. But the faults of the second class, some of which we proceed to give, can only be explained by the practical men's using scientific words in a wrong sense. From the following, and others too numerous to be quoted, a new science (!) could be founded, having nothing in common with that which Galilei and Newton have handed down to us, (of course on the supposition that all the words employed are to be taken as they are understood in pure science.)

"Hence the *potential energy* of each gallon of water is

1/330 of a horse-power." Our author would surely have thought twice before writing "the distance from London to York is 200 miles per hour." But this, to which we invite his careful attention, would have involved no greater blunder.

"If the bodies are elastic . . . , the whole of the energy of the striking body is expended in producing motion in the body struck." After this it will not, perhaps, surprise the reader to find that we are furnished with a calculation of "the total heat from absolute zero resident in exploded powder, at an atmospheric temperature of 50°, or 510° absolute."

The work may be made, even as a whole, thoroughly useful to those habituated to the persistent inaccuracies of the "vernacular":—but, to effect this, it must be carefully purged of statements analogous to the three last-made quotations.

P. G. T.

A FIELD NATURALIST IN EASTERN BENGAL

Letters on Sport in Eastern Bengal. By Frank B. Simson, Bengal Civil Service, retired. (London: R. H. Porter, 1886.)

THIS book is essentially a record of sporting scenes, and the author has ostensibly written it for the purpose of giving instruction in the art of shooting and hunting wild birds and beasts of various kinds, from quail and snipe to tigers and rhinoceroses. Yet it contains so many good observations on the haunts and habits of wild animals, and the author shows himself so capable a field naturalist, that a reader who looks for zoological information will probably be disappointed at not finding more novelty. The scene of Mr. Simson's principal adventures, Eastern Bengal, a vast plain (traversed by mighty rivers, a country of rice fields and cane brakes, and great grass jungles, of "bheels," or marshes, and "churs," or temporary islands and sand-banks in rivers, has by no means been rendered too familiar by description. Fertile and peaceable, with never-failing rains and magnificent water communication, it furnishes few sensational paragraphs for newspaper correspondents or other manufacturers of periodical literature. The region is as little known to Anglo-Indians in general as the Highlands of Central India, so vividly described by Forsyth, or the wild Mysore country, of which the elephants, tigers, and other wild beasts found an historian in Sanderson. Why is it that the additions to our zoological knowledge made by Mr. Simson are so much less important than those made by Sanderson and Forsyth?

The explanation is probably twofold, if not threefold. All the three writers named were enthusiastic sportsmen and good observers, but Forsyth and Sanderson related events of more recent date, the details of which were naturally more vivid, whilst the present work is a series of reminiscences, written out long after the incidents described took place. The avocations of the different writers, too, were very dissimilar. Those of the two authors first named led them to pass weeks and months amongst the haunts of wild animals, whilst Mr. Simson, a Bengal civilian, could only spend an occasional holiday at a distance from his office, or avail himself of a few hours at a time during the cold season's tour. Another

reason, perhaps of even more importance, is the difference in the nature of the country, and the different system of hunting rendered necessary. The great grass of the Gangetic plain, even when reduced to patches the fires of the spring, conceal the movements of the inhabitants, from rhinoceroses and buffaloes downwar far more than do the jungles of Central and Southern India, especially after their much less luxuriant grass have been burnt. The process of beating out a patch thick grass 10 to 20 feet high with a line of elephants differs widely in the opportunities afforded for observation from the tracking, chiefly on foot, of the animal sou after, through the burnt glades of the Satpura hills the comparatively thin undergrowth of the Sahyad forests.

It must not be supposed that Mr. Simson's work contains no novel observations. A very large proportion our acquaintance with the habits of animals, especially the larger Mammalia, is due to sportsmen, but the value of their observations varies. A few sportsmen are deliberately untruthful,—these are easily detected; but many more are unqualified for accurate observation. There is no better test of a writer's truthfulness and capacity than his snake stories. In America it commonly said that there is no subject on which ordinary mortals are so prone to what may euphemistically be termed "romancing." Indian experience corresponds to American, and whatever may be the deficiencies of the Bengali peasant, no one ever credited him with want of imaginative power. The Europeans in India, as a rule, know nothing about snakes. In the work under review, two of the best letters (the whole is written in epistolary form) deal with snakes, and the account of the poisonous species, all of which are correctly named and described, is excellent. To have picked out the grains of truth, and disregarded the chaff shows judicial acumen worthy of one who has, in the administration of the law, had much experience of conflicting evidence. One of the most interesting facts mentioned is the use made of cobra venom in poisoning arrows used for the destruction of wild animals.

Another interesting observation may be noted: the shooting of a tiger "whose paunch was crammed full of grasshoppers or locusts." Hitherto, although tigers were not thought to be very particular, they were supposed to draw a line at frogs, and were not suspected of condescending to devour insects.

The plates are good on the whole, the elephant excellent, and the lithograph entitled "A scrimma with a tiger," is one of the best representations of the animals and men depicted to be found in any Indian sporting work. But the pigs—with one exception, in which the animal looks as if he had been shaved—are far too shaggy, and resemble the European boar, *Sus scrofa*, rather than the Indian *S. cristatus*.

W. T. B.

THE MEASURE OF THE METRE

La Mesure du Mètre. By W. de Fonvielle. (Paris: Hachette, 1886.)

M. DE FONVIELLE'S little volume is truly national. From one end to the other it rings with applause for those brave men of France who, in 1792 and the

following years, under extraordinary difficulties—political, social, and geographical—determined the measure of the arc of the meridian from Dunkirk to Barcelona; from the 1/10,000,000th part of which arc the measure of the metre was then derived.

The author in stirring language recounts the dangers and disappointments of the scientific men engaged in this work during the Revolution—Méchain, Delambre, Berthémie, Biot, Arago, Lenoir, and Lavoisier. He endeavours to awaken a warm and genuine admiration for their labours, and to show that the love of science is in some way natural to France. In pathetic words he recounts the dangers in the field: Méchain's work in Spain, his troubles at home, his recall, and return to Spain; his fears that the great measurement might never be accomplished; and at last the sad end—Méchain's death in 1807 at Plana, a victim to yellow fever. Then follows the appointment of Biot and Arago, and the account of their doubts and difficulties in completing the measurements, of the capture and imprisonment of Arago and Berthémie, of their detention in Algiers, and of their ultimate ransom and release.

M. de Fonvielle traces the development of the new system of weights and measures from the proposal of Buffon in 1790 to take as a unit the length of the seconds pendulum, to the report of the completion of the measurement of the metre in 1809. He refers to the invitation given by France in 1790 to our country, to join in an international effort to adopt one weight and one measure for all nations. This invitation, as experience has shown, ought not to have been declined, but even now, owing to the reluctance of English-speaking nations to abandon their traditional units, a similar proposal might possibly not be warmly received.

M. de Fonvielle reminds his readers that the French metric system must not be altogether regarded as a French innovation, for the Chinese long ago adopted a decimal system. It is to Shun, the sage, when Regent of the Chinese Empire, B.C. 2287, that China owes its decimal system, based on a so-called natural constant, the length of the musical standard lü, or bamboo pitch-pipe.

Of course this little volume is intended for popular reading, particularly in France. For the true account of the circumstances and results of the measurement of the arc of the meridian which passes through Paris, we must go to the "Mémoires" published by Méchain and Delambre in 1806, and to the observations of Biot and Arago issued in 1821.

OUR BOOK SHELF

Histoire Générale des Races Humaines. Introduction à l'Étude des Races Humaines—Questions Générales. Par A. de Quatrefages, Membre de l'Institut. (Paris: A. Hennuyer, 1887.)

PROF. DE QUATREFAGES and M. E. T. Hamy propose to edit a general history of the human race, and the present volume, by Prof. de Quatrefages, is intended for an introduction to a series of monographs by various authors. The dark races will be described by M. E. T. Hamy; the yellow races by M. J. Montana; and the red races by M. Lucien Biart. These volumes are in course of publication, and the first volume of the series, on the *Aztecs*, by M. L. Bert, has already appeared. There will

be a volume on the Mongols, by M. J. Deniker, and one on the Foulahs, by Dr. Tautain.

In the present volume the general questions of ethnology are treated of, and the subject of the classification of the human race is passed in review. With that charming style which characterises the writings of this author, and which has for long made him one of the most popular writers on scientific subjects in France, he here gives a *précis* of the chief works treating on ethnology, and decides that the human race must not be placed in the same category with the animal race, because it exhibits the presence of two additional phenomena, those of morality and religion.

On the question of the unity of the human species, too often one of mere words, the *pros* and *cons* are placed before the reader in a tabular form. In the chapter on the first appearance of man, the various transformistic theories are passed in review, and the views of Darwin, Huxley, Vogt, and Haeckel are alluded to; but the author for himself believes that any certain knowledge on this point is beyond our actual powers. In other chapters, the antiquity and geographical origin of the race are treated of, as well as the subject of the peopling of the globe and the acclimatisation of the species. Primitive man is regarded as of distinct ethnic types, and from these the races took their rise. Lastly, the physical, the intellectual, and the moral and religious characters of the races are discussed in some detail. The work is supplied with numerous and excellent illustrations; it is printed in clear type on royal octavo paper, and forms a handsome volume of nearly 300 pages.

Grundzüge einer Theorie der kosmischen Atmosphären mit Berücksichtigung der irdischen Atmosphäre. Von Wilhelm Schlemmüller. (Prague.)

IN this pamphlet the author introduces a modification into the ordinarily accepted dynamical theory of gases by assuming that the molecules of a gas at uniform temperature are all affected with absolutely the same linear velocity as regards magnitude, instead of the temperature being dependent on the mean or average velocity. This of course greatly simplifies the labour of deducing the fundamental relations between pressure, density, temperature, and the potential of external forces; and he claims to be able to deduce the relation, which for the terrestrial atmosphere gives Bessel's refractions to 90° (*sic*) zenith distance; agreeing with the formulæ found by Bauernfeind in 1862-64. We may remark that the convertible equations are reproduced in some cases with almost wearisome frequency, and that Joule is twice called Jonle.

Manual of Physical Geography of Australia. By H. Beresford de la Poer Wall, M.A. (Melbourne: Robertson.)

THIS little manual is written for Australian schools, and may be accepted as a fair and trustworthy account of the physical geography of Australia. For an exhaustive treatment of the subject the material is still wanting for a large section of the continent; on others, again, there is abundance of material, and of these Mr. Wall has made creditable use. It is a pity the book should be burdened with such terrible lists of names as those on pp. 9 and 10: the author would have done much better had he shown the relations of the leading capes to the general relief of the land.

An Intermediate Physical and Descriptive Geography, abridged from the Physical, Historical, and Descriptive Geography of the late Keith Johnston. (London: Stanford, 1886.)

THE late Keith Johnston's larger geography is on the whole the best general text-book of the subject in English. The present abridgment for middle-classes in schools seems to us judiciously done.

LETTERS TO THE EDITOR

[The Editor does not hold himself responsible for opinions expressed by his correspondents. Neither can he undertake to return, or to correspond with the writers of, rejected manuscripts. No notice is taken of anonymous communications.]

[The Editor urgently requests correspondents to keep their letters as short as possible. The pressure on his space is so great that it is impossible otherwise to insure the appearance even of communications containing interesting and novel facts.]

Mr. Wallace on Physiological Selection

SEEING that Mr. Wallace has now changed front with regard to some of the points at issue between us, I must once again address you upon this subject.

(1) He appears to have forgotten that the whole plan of his original impeachment consisted in representing me as an arrogant heretic. This impeachment was published under the heading "Romanes versus Darwin," and point by point it laboured to show that I was deserving of excommunication as a rebel against the highest authority. In my reply, therefore, I was obliged to show that the charge was misdirected; and this I did by simply quoting passages from that highest authority himself. It is needless to say that I am now as much satisfied as surprised to find this charge, not only abandoned, but reversed. Whereas I was previously accused of presumption for disregarding authority, now the remonstrance is—"he appeals to authority against me," and "I decline to accept authority as an infallible guide." So do I. But I quoted my authority merely for the avowed purpose of defending myself from the specific charge of my opponent. It was he who appealed to Cæsar, and cannot therefore now complain if to Cæsar he had to go. Truly, if I may employ his own mode of expression, "further discussion of the matter with such an adversary is out of the question."

(2) But, as regards one of the points, he says that my quotations appear to him to support his own view rather than mine. The shortest way of testing the value of this judgment will be to print in succession three passages, which I have selected as serving in each case most concisely and most fully to embody the opinion of its writer. The point in question is as to whether specific characters are "invariably" adaptive, or "frequently" not so, and the italics are mine.

"When, from the nature of the organism and of the conditions, modifications have been induced which are unimportant for the welfare of the species, they may be, and apparently often have been, transmitted in nearly the same state to numerous, otherwise modified, descendants." (Darwin, "Origin of Species," p. 175.)¹

"I believe, therefore, that the alleged utility of [many] specific characters claimed by Mr. Romanes as one of the foundations of his new theory, has no other foundation than our extreme ignorance" (Wallace, *Fortnightly Review*.)

The matured judgment of Mr. Darwin clearly recognised the distinction between the origin of *specific* and the origin of *adaptations*, distinction, indeed, which necessarily follows from his repudiation of the doctrine of utility as universal. . . . Therefore, with him I believe that an incalculable number of specific characters are of an adaptive kind, and that many more which now appear to us (in our ignorance) to be useless, will hereafter be proved to be useful. But with him also I believe that a large proportional number of such characters actually are destitute of utility, having been due, as he says, to 'fluctuating variations, which sooner or later became constant through the nature of the organism and of surrounding conditions, as well as through the intercrossing of distinct individuals; but not through natural selection.'" (Myself, *Nineteenth Century*.)

(3) "The impossibility of proving a negative is proverbial, but my opponent declares that his negative—the uselessness of specific characters—wants no proving, but must be accepted till in every case the affirmative is proved." Now, I have made no such declaration. My statement was: "It is too large a demand to make upon our faith in natural selection to appeal to the argument from ignorance, when the facts require that this appeal should be made over so large a proportional number of instances." It is really Mr. Wallace who declares that his affirmative—the invariable usefulness of specific characters—wants no proving, but must be accepted till in every case the negative is proved,

¹ By a curious and undesigned coincidence, the same issue of NATURE which contains Mr. Wallace's letter also contains my review of Mr. Spencer's essay on the "Factors of Organic Evolution." In that review several other passages are quoted from Mr. Darwin's works to the same effect.

notwithstanding that, as he allows, "the impossibility of proving a negative is proverbial." Of course, if it has been previously assumed that natural selection is the only factor of organic evolution, we are entitled to conclude that the doctrine of utility universal requires no further proof, since it follows deductively from the assumption. But where the very question in dispute is as to the validity of this assumption, it becomes an almost comical instance of circular reasoning to construct our biological catechism thus:—Why do you believe that natural selection is the only factor of organic evolution? Because I know that in organic Nature utility is universal. But how do you know this, seeing that "our extreme ignorance" renders it impossible to suggest, in a vast number of cases, what the utility can be? I cause I have already proved that natural selection has been only factor at work.

(4) Mr. Wallace imports from the monthly periodicals part of our discussion on the swamping effects of intercrossing. Here, therefore, I must follow him. In my Linnean Society paper I had urged that natural selection must be seriously handicapped in its action by the swamping effects of fortuitous variations intercrossing with their parent forms. This statement Mr. Wallace contradicted on the ground that Mr. J. A. Allen had furnished "a complete demonstration of individual and simultaneous variability by a series of minute comparisons and measurements," with the result of showing that, whatever modification might be required, "we always (italics his) find a considerable number, say from 10 to 20 per cent. of the whole, varying simultaneously, and to a considerable amount, on either side of the mean value." Now, in my reply I pointed out that all the variations thus recorded by Mr. Allen were of a kind which had "nothing to do with the difficulty," seeing that they had reference only to such features as "size, strength, fleetness, colour, relative proportions of different parts, and so on, all of which—as we well know without going beyond the limits of our own species—are so highly variable as never all to be precisely the same in any two individuals." Then, by way of illustration, I said: suppose "it were required to produce a breed of race-horses with horns upon the frontal bone, . . . or a fighting spur on a duck, clearly it could not be done by natural selection alone" in the latter case, or by artificial selection in the former; the principle of selection would here require to be assisted by "some common cause [of variation] acting on a number of individuals simultaneously." But there was nothing in the use of this illustration to provoke the remark that it indicates "the belief, apparently, that these are a class of characters which are distinctive of closely allied species"—although such does happen to be the case as regards certain allied genera. I merely requested Mr. Wallace to show me his "considerable number of specimens diverging from the mean condition," as regards either of these structures, however incipient—or as regards any other structures, save those the general variability of which as to relative size, &c., no one would dream of disputing. And this I still hold he is obviously bound to do, if he is to sustain his sweeping statement that whatever modification of type may be required, we always find from 10 to 20 per cent. varying in the needful way. Thus, as a mere matter of dialectic, I confess it appears to me a somewhat unaccountable expedient to affirm that my *reductio ad absurdum* is "preposterous"—such happening to be the very quality which this mode of refutation is ordinarily designed to present.

(5) Lastly, my critic says:—"The argument to show that the supposed physiological variations would be perpetuated, seems to me as weak and unsatisfactory as ever." This may well be. Indeed, I never supposed that anything would be likely to influence the judgment of Mr. Wallace where natural selection is concerned. But I did not write with any such object. I wrote merely to dispose of a particular criticism which he had advanced, and there can be no two opinions as to the result. For I have shown that whatever may be thought about the truth or falsehood of my theory,¹ at least it is certain that it cannot be affected by the criticism of Mr. Wallace; and this for the simple reason that he has run a tilt, not against my theory at all, but against a completely different theory, which, like a figure of straw, he had himself set up. Now that he can no longer have any doubt as to what my theory is, I willingly conclude that he must still have some reasons for thinking it improbable that the supposed physiological variations (if they occur) should be perpetuated. But I am free to confess that it passes my powers of conception to divine what these

¹ I call it my theory, because I now understand that it differs widely from that of Mr. Catchpoll (see NATURE, vol. xxiv. p. 677).

reasons can be: I only know that they must be of a totally different order from those which constituted the substance of his published criticism.

Of course the question whether or not these physiological varieties *do* occur is quite distinct; and I most heartily agree with Mr. Wallace that this is a question of fact which ought to be decided, before it can be worth anybody's while to attack my suggestion upon any other grounds. If Mr. Wallace had seen this in the first instance, he might have saved both himself and me a good deal of trouble; but at the same time he would have deprived me of no small amount of encouragement. For I am now more than ever satisfied that the suggestion does not admit of being assailed on any grounds of general reasoning; but, on the contrary, that as a theory it is antecedently probable, and can only be refuted—if it is to be refuted—by an appeal to fact in the form of experiment. And as I cordially hope that this may be the last time that I shall have to address you upon this subject, I should like to neutralise the discouraging influence on experimental verification which may have been exercised by premature criticism in your pages. This I hope in some measure to effect by making two remarks. The first is that my own estimate of the antecedent probability of the theory is shared by some of the highest "authorities" on the Continent. The second is that, in all the lines of inquiry hitherto pursued, I find striking evidence of the actual occurrence of the physiological varieties in question. But as this evidence requires to be largely supplemented by experiment, and as every experiment requires at least three years to perform, those biologists who think with Mr. Wallace may be glad to hear that it will be a very long time before I shall have occasion again to trouble them with the theory of physiological selection.

GEORGE J. ROMANES

The Alleged Ancient Red Colour of Sirius

WITH reference to your paragraph last week (p. 378), in the "Astronomical Column," on "The Alleged Ancient Red Colour of Sirius," it does not seem to have been noticed that the early observations of Sirius were made at its heliacal rising. Under these circumstances the sun is a red star.

F. R. S.

A Green Light at Sunset

AT sunset to-night I observed a phenomenon which has, I believe, been seen from on board ship, but never probably from a place with such a distant sea-horizon as we have here—some seventy miles. The sky for a short distance above the point where the sun set was perfectly clear of cloud or haze, and I watched carefully the last portion of its disk disappear into the sea. As soon as the last speck of the yellow vanished, a momentary bright green flash shone out. This was quite different from the complementary green seen after looking at the setting sun; brighter and bluer in tint. I have seen it stated that the cause of this green light is the sun shining *through* the water that hides it, and would be glad to know if such is the true explanation.

R. T. OMOND

Ben Nevis Observatory, February 12

Sunset Phenomenon

ON February 21, at 5.25 local time, my attention was attracted by a bright red glow reflected from the earth outside a window having an eastern aspect.

On going out of doors to the Observatory, it was evident that this crimson light proceeded from a band of cloud about 10° in width forming a great circle in the heavens, and intersecting the horizon at points, as well as I could estimate, 145° W. and 35° E. of true north, the inclination of this great circle to the horizon being about 15° or 20°.

In less than three minutes, before I could reach the Observatory, the magnificent spectacle had completely vanished, and in the place that it had occupied were merely some streaks of cirrus and cirro-stratus, the latter being nearest to the place where the sun had set, and in half an hour the entire heavens were cloudless.

Will reflection, or refraction, or both, suffice to explain the above?

WENTWORTH ERCK

Shankhill, Co. Dublin

Aspects of Clouds

IN Mr. Ruskin's "Modern Painters" (i. Part 2) I have noticed the following passage amongst the author's remarks on the aspects of clouds:—

"I have often seen the white, thin, morning cloud edged with the seven colours of the prism. I am not aware of the cause of this phenomenon; for it takes place not when we stand with our backs to the sun, but in clouds near the sun itself; irregularly and over indefinite spaces, sometimes taking place in the body of the cloud. The colours are distinct and vivid, but have a kind of metallic lustre upon them."

And again, the author describes the "scattered mists rallying in the ravines and floating up towards you along the winding valleys till they couch in quiet masses, *iridescent* with the morning light, upon the broad breasts of the higher hills."

Dr. Johnstone Stoney recently read a paper to the Royal Dublin Society entitled "The Iridescent Phenomena in Clouds," wherein he explains the cause of a somewhat similar appearance which clouds at times present. Their outer portions are suffused with soft shades of colour like those of mother-of-pearl, a lovely green being generally conspicuous. The tints are usually distributed in irregular patches as in mother-of-pearl, but in some cases they form a regular fringe. Dr. Stoney explained that these phenomena are due to particles of ice, in the form of crystals of various sizes and shapes, and according to their position and character the sun's rays are reflected through them in various colours, thus producing the beautiful effect.

Would this be an explanation of the appearances to which Mr. Ruskin refers?

ROBERT JAMES REILLY

Boyle, Ireland, February 17

A Recently-Discovered Deposit of Celestine

IT may, perhaps, be worth mentioning that a large and valuable layer of celestine has been lately found at Yate, in Gloucestershire. It lies just below the sub-soil upon a bed of red Triassic marl, which rests unconformably upon the coal-measures, just at the eastern edge of the Bristol coal-field in that district.

The deposit is, for the most part, about half a metre or more in thickness, and consists chiefly of loose nodules which, when broken, are seen to be masses of white, crystalline, nearly pure celestine. Geodes are occasionally found, one of which, about 15 cm. in diameter, lined with fine clear crystals, is now in our school museum. Beautifully transparent, though not well crystallised masses of selenite also occur in the deposit, and in these are sometimes inclosed single detached crystals of celestine. I picked out one crystal (though it seemed almost sacrilege to break up the fine specimen of selenite), which is about 7 × 4.5 × 1.5 cm., doubly terminated, fairly clear, and showing very perfect, well-developed faces. Its density is 3.95, and it shows very perfectly the characteristic light-bluish tinge of celestine.

It would, I think, be quite worth while for any mineralogist who happens to pass near Bristol to pay a visit to the place, which is only about twelve miles distant on the Midland Railway to Gloucester. The extent of the deposit is not known, but when I was there in October last, and again at Christmas, it was being worked in several fields north-east of the church, about a mile and a half from the station. Large quantities are being sent away, of course for the purposes of sugar-refining and adulterating white-lead paint.

H. G. MADAN

Eton College, February 21

"Culminating Sauropsida"

IT is with satisfaction that I note in NATURE of February 3 (p. 331), that Prof. W. K. Parker finds it more and more impossible "to conceive of birds as arising *direct* from the Dinosaurs, or indeed from any other order or group of reptiles." The sentence, no doubt, suggests an indirect origin of birds from reptiles; but, further on, Prof. Parker explains that if proto-vertebrate forms existed it is quite supposable that a metamorphosis may "have taken place of this and that *quasi-larval* form into archaic reptile, ancestral bird, or primitive mammal." We must therefore conclude, either that there were two kinds of protovertebrates, namely, piscine and reptilian—or ichtyopsidan and sauropsidan, as Prof. Parker would probably prefer to call them—fundamentally distinct or preceded by common ancestors,

The West Indian Seal (*Monachus tropicalis*)

IT will probably be of interest to the zoological portion of your readers to learn of the re-discovery—or the full discovery—of the West Indian seal (*Monachus tropicalis*). The history of this pinniped is in brief as follows.

It was first noticed by Columbus in his account of his second voyage (1494) as having been found in some numbers on the rocky isle of Alta Vela, off the southern shore of Hispaniola, where his sailors killed eight of them for food. Later—in 1675—Dampier found this seal in abundance on the Alacran reefs, about 80 miles north of Yucatan. At that time it was killed there in great numbers for its oil.

The seal then remained unnoticed for over a century and a half, having no place whatever in the writings of zoologists until 1843. Then Mr. Richard Hill published an account of it in the "Jamaica Almanac," calling it the Pedro seal, from the Pedro Keys, some 60 miles south of Kingston, Jamaica, where he had found it. A few years later Mr. P. H. Gosse obtained an imperfect skin (without skull) which he sent to the British Museum, where it was described by Dr. Gray in the Proceedings of the Zoological Society of London, 1849. Dr. Gray gave it then no name, probably by reason of its imperfect characters. Later—in 1850—(Catalogue of Mammals in the British Museum) he described this same specimen as *Phoca tropicalis*, and afterwards (Catalogue of Seals and Whales, 1866) as *Monachus tropicalis*. But so imperfect was the specimen on which the description was founded, and the animal itself was so little known, that even its generic relations were in doubt, and its reference to the genus *Monachus* was considered provisional. From thence on to the present, rumours of the existence of this seal have been not unfrequent, but nothing seemed trustworthy and positive, and no specimens were obtained, if we except a young skin, without bones or skull, which came from Cuba to the National Museum at Washington, in 1884, without any indication as to locality.

It has long seemed to the writer—as, doubtless, to many others—that the certain presence in our waters of so important a mammal lying *perdu* in regions which our naturalist collectors are yearly visiting, was the opprobrium of American zoologists. We made inquiries, and collected notes from many sources, which showed clearly that this seal existed at isolated points—on small islands and keys—not only in the Caribbean and among the Bahamas, but also in the Gulf of Mexico. Last summer, while on a visit to the western shore of the Gulf of Mexico, we were so fortunate as to *locate* this seal with much certainty. This was upon the Triangles (Los Triangulos), three little keys, hardly above the water-level at high tide, and lying some 100 miles north-west off the Campeachy coast, in latitude N. 20° 50', and longitude W. 92° 10'. Following this clue, my son, Mr. Henry L. Ward, last December visited the Triangles in company and partnership with Señor F. Ferrari Perez, naturalist of the Mexican Geographical and Exploring Expedition. His hunt was highly successful, and he has during the present month returned with nearly twenty specimens—skeletons and skins of all ages, from a suckling to the fully adult male, 7 feet in length. This ample material has just been carefully studied by Prof. I. A. Allen, the well-known zoologist, and author of the

sponding in position to the vesicula seminalis, which had been moved forwards. The various parts on the left side, as well as the female organs, were quite normal.

R. J. HARVEY GIBSON
Biological Laboratory, University College, Liverpool,
February 14

Instinctive Action

SOME years ago I was about to drown a terrier pup of about a month old. I held it across the palm of my open hand over a large tub of water. It lay quite still on my hand as I gently lowered it. When within 4 inches of the surface, but not yet touching the water, it deliberately began, and continued as long as I held it there, the paddling motion with its feet peculiar to dogs when swimming, and quite unlike that of walking, although I am perfectly certain this puppy had never seen or touched water before. We know almost all animals swim when first placed in water, but how could this puppy know before it touched the water that this peculiar action would be necessary? Has a similar case been observed by any of your readers?

Birmingham, February 17 D. W. C.

THE RELATIONS BETWEEN GEOLOGY AND THE MINERALOGICAL SCIENCES¹

I.

THE realm of Nature has been recognised from time immemorial as consisting of three kingdoms: dealing with the affairs of these three kingdoms, respectively, there have grown up side by side three departments of natural knowledge—zoology, botany, and mineralogy. But in recent years new and, I cannot help thinking, regrettable relations have sprung up between these sister sciences. Zoology and botany, having developed a method of classification, and a nomenclature, based on common principles, have been drawn together by bonds so close and firm that many regard them as indissolubly one—the science of biology. Mineralogy, thus isolated, has been driven to seek new and unnatural alliances—with chemistry, with physics, or with the mathematical sciences. For my own part I confess that I regard this threatened "Repeal of the Union" of the natural sciences as alike a misfortune and a mistake.

It is sometimes assumed that the objects dealt with by zoology and botany are so different in their essential characters from those treated of by mineralogy, that the science of "organic" Nature must always follow a different path from that pursued by the science of "inorganic" Nature. The structures commonly known as *organic*, and the processes usually called *vital*, are asserted to be so entirely different, alike in their origin and in their essence,

¹ Address to the Geological Society at the Anniversary Meeting on February 18, by the President, Prof. John W. Judd, F.R.S.

from anything existing in the mineral kingdom, as to warrant the establishment and perpetuation of a fundamental distinction between the sciences dealing with "living" and "non-living" matter respectively.

In the year 1854 a very acute thinker, who at one time occupied this chair, made a serious attempt to formulate the distinctions which are supposed to divide living from non-living matter; but at a subsequent date, admitting with characteristic candour that he had altogether outgrown these ideas, Prof. Huxley argued, with great skill and cogency, that "vitality" is merely a general term for a set of purely physical processes, differing only in their complexity from those to which "inorganic" matter is subject.

It is a circumstance of no small significance that no definition of *life* which has yet been proposed will exclude the kind of processes which we can now show to be continually going on in mineral bodies. "Life," said the late George Henry Lewes, "is a series of definite and successive changes, both of structure and composition, which take place in an individual without changing its identity." Mr. Herbert Spencer prefers to define life as "the definite combination of heterogeneous changes, both simultaneous and successive, in correspondence with external co-existences and sequences."

If either or both of these definitions of life be accepted as satisfactory, then, as I hope to demonstrate to you, the minerals which build up the crust of our globe unquestionably live. At all events I am confident of being able to show that "in correspondence with external co-existences and sequences," or, in other words, as the conditions to which they are subjected vary, they undergo "a series of definite and successive changes, both in structure and composition, without losing their identity."

It may seem paradoxical, but it is nevertheless true, that the "vitality" of minerals—I really do not know what other term to use to convey my meaning—is much greater than that of plants, and, *a fortiori*, than that of animals; and this is the direct and necessary consequence of their less complex and more stable chemical situation.

The zoologist regards as a case of remarkable vitality the recovery of snails which had been long affixed to a museum-tablet, upon their immersion in warm water. The botanist cites the germination of seeds taken from ancient Egyptian tombs as a striking illustration of how long life may remain dormant in the vegetable world. Let us now turn to the mineral kingdom. A quartz-crystal develops to certain dimensions, in accordance with the natural laws of its being, and when the necessary conditions of growth cease to environ it, its increase is arrested. But the crystal still retains its "vitality," that is, the power of further development which is dependent on its particular "organisation" or molecular structure. We may destroy that "organisation" and the "vitality" which is dependent upon it in a single instant, by subjecting the crystal to the action of hydrofluoric acid or of an oxyhydrogen flame. But unless its "organisation" and "vitality" be thus brutally stamped out, the crystal and, indeed, every fragment of it retains, not the "promise" only, but the very "potency of life." It may be worn by wind and wave into a rounded and polished sand-grain; it may be washed from the beds of one formation, to form part of the materials of a new one, and this process may be repeated again and again; but after countless wanderings and unnumbered "accidents by flood and field," extending over millions on millions of years, let but the necessary conditions of growth again environ it, and the battered and worn fragment will re-develop, in all their exquisite symmetry, its polished facets, it will assume once more the form of a quartz-crystal, having at least as much claim to *identity* with the original one, as a man has with the baby from which he has grown.

"Life!" "Vitality!" These terms are but convenient

cloaks of our ignorance of the somewhat complicated series of purely physical processes going on within plants and animals. "Organisation!" Why should the term be applied to the molecular structure of an *Amaba* or a yeast-cell, and refused to that of a crystal? But even if we choose to insist on such distinctions as these, must we also make them a basis on which to establish our classification of the sciences?

Unquestionably there are differences between the cycles of change which take place in animals, plants, and minerals respectively. As the animal differs from the plant in not being able to build up its tissues from the simple compounds of the mineral kingdom, so both animals and plants differ from minerals in their power of growth by intussusception.

But perhaps the most striking difference of all between the "vital" processes in animals, plants, and minerals, is found in the *rate* at which they take place. Animals, in consequence of the instability of their chemical constitution, are distinguished by an almost ceaseless activity and a consequent brevity of existence. Plants, in the slower rate at which their vital processes take place, bridge over to some extent the tremendous gap between animals and minerals. In these last the vital processes are so prolonged in their manifestations, owing to the stability of their chemical composition, and they are not unfrequently interrupted by such enormous intervals of time, that they are only recognised by the geologist.

The cycles of change which take place in an ephemera are rapid indeed as compared with those going on in the oak-tree, among the branches of which it lives; but in the rocks among which the oak thrusts its rootlets, other processes are going on compared with which the life of the oak-tree is as "fast" as that of the ephemera compared with its own.

Nevertheless the three forms of life seem to start pretty much on a level. A solution of nitre in which crystallites are uniting, in obedience to the laws of polarity, to build up crystals, with their regular forms, their molecular structure, and their powers of further development; a solution of sugar, in which the cell of a yeast-plant is living and growing; and a third liquid with floating vegetable particles, in which an *Amaba* is increasing and multiplying;—these three may surely be compared with one another, however unlike may appear to be the higher developments in the three kingdoms to which they respectively belong.

I do not, of course, for one moment wish to suggest that it is practicable, or even desirable, to attempt an extension of the conventional use of the terms "life" and "organisation." But I do think that it is of the first importance that we should clearly recognise the fact that the distinctions between living and non-living matter are not essential and fundamental ones, that cycles of change exactly similar in almost every respect to those occurring in the animal and vegetable kingdoms are equally characteristic of the mineral kingdom; though, in the latter, they are more difficult to follow on account of the extreme slowness with which they take place.

When this great truth is fully recognised, the separation of the biological and the mineralogical sciences will be at an end, and mineralogy will begin to profit by that revolution in thought and in method which has already done so much for her sister sciences.

The temporary divorce between biology and mineralogy has arisen, not from any inherent differences between their aims, their methods, or the objects of which they treat, but from the circumstance that, while the former has in the last half century advanced with the stride of a giant, the latter has during the same period tottered on with the feeble steps of infancy. Mineralogy is still in the "pupa-stage" of its development; it is a classificatory science, with its methods imperfect, its taxonomy

undeveloped, and its very notation undefined. Its cultivators, absorbed in the Sisyphean task of establishing new species and varieties, too often treat their science, with all its glorious possibilities, as though it were but akin to postage-stamp lore!

How is it, we may profitably ask, that the biological sciences have made such prodigious advances, while the mineralogical ones have lagged so far behind? We must ascribe the result, I believe, to two causes:—

In the first place, improvements in the construction of the microscope, and more especially the perfecting of methods of study by means of thin sections, have immeasurably enlarged the biologist's field of observation; histology and the cell-theory, embryology with all its suggestiveness, and many important branches of physiological research, must have languished, if, indeed, they could ever have seen the light, but for aid afforded by the microscopical methods of inquiry.

In the second place, the growth of geological and palæontological knowledge has been the leading factor in that profound revolution in biological ideas which, sweeping before it the superstition of fixity of species, has endowed this branch of natural science with the transforming conception of evolution.

Now these two causes, which have done so much for biology, are already working out the regeneration of mineralogy; and I doubt not that the fruits brought forth by the latter science will be equally satisfactory with those of the former.

The application of the microscope to the study of minerals has proved less easy than in the case of animal and vegetable structures. More than a century ago, it is true, several French geologists employed the method of crushing a rock, and of picking out from its powder the several minerals of which it was composed, for microscopic study; and in 1816, Cordier endeavoured, by systematising the methods followed by his predecessors, Daubenton, Dolomieu, Fleurian, and others, to elaborate a scheme for the mineralogical analysis of rocks by the aid of the microscope. In recent years the French geologists, with M.M. Fouqué and Michel Lévy at their head, have shown how, by the employment of the electro-magnet, of fluids of high density, and of various chemical reagents, this work of isolating the several minerals of a rock for microscopic study or chemical analysis may be greatly facilitated.

But the great drawback to this method of microscopic study of rocks, as devised in France, was found in the circumstance that it began by destroying the rock as a whole, and hopelessly obliterating the relations of its mineralogical constituents. Delesse and other observers, it is true, succeeded in obviating this difficulty, to some extent, by studying the structure of rocks as seen in polished surfaces under the microscope by reflected light.

The greatest step in advance in connection with the microscopic study of rocks was undoubtedly made, however, when it was shown that transparent sections of minerals, rocks, and fossils can be prepared, comparable to those so constantly employed by biologists in their researches. William Nicol, of Edinburgh, was the first to discover, in the year 1827, how the mechanical difficulties in the way of the preparation of such sections could best be surmounted; while Mr. Sorby, in a memorable communication to this Society, in 1858, showed us the first-fruits of the wonderful harvest of results to be obtained by the employment of this method.

But if the birthplace of the one method of microscopic study of rocks was France, and of the other Britain, it must be confessed that a large part of the merit of developing and improving these methods of inquiry is due to the Germans. To the labours of the numerous, patient, and accurate students in that country must be ascribed much of the perfection to which the methods of microscopic

mineralogy have now attained; though we must not forget in this connection many most valuable contributions to the study from Scandinavia, Holland, Italy, and the United States.

As in the case of biology the results attained by the geologist have been the means of awakening new interests and inspiring a new philosophy, so in the case of mineralogy other problems have been suggested, and entirely fresh conceptions of the scope of the science have followed from the development of geological thought. We are thus led to regard minerals, not simply as a set of curious illustrations of mathematical and chemical laws, but as important factors in the evolution of the globe. Mineral collections in the past have resembled greenhouses, wherein only beautiful, though often abnormal growths are admitted; but in the future they will be like the herbaria of the botanist, where mere beauties of form and colouring are subordinated to the illustration of natural relationships and to the elucidation of the great problems of origin and development. Far be it from me to undervalue those wonderful crystals, the choice flowers of the mineral kingdom, which adorn our museums; but as there are many plants of extreme scientific interest which happen to possess only inconspicuous flowers, so there are not a few microscopic minerals, the study of which may lead us to the recognition of some of the most important laws of the mineral world.

I believe that what geology has already done for biology she is now accomplishing for mineralogy; it may, indeed, be instructive to point out how, in every one of its departments, the employment of micro-copic methods and the suggestion of new lines of thought is causing mineralogy to develop in just the same directions as biology has already taken before her. In this way we may perhaps best convince ourselves that mineralogy is once more asserting her position in the family of the natural sciences.

Every natural-history science presents us with four distinct classes of problems. With respect to the objects of our study, we may make inquiries concerning their forms, their actions, their relations, and their origin. The answers to the first class of questions constitute *Morphology*, to the second *Physiology*, to the third *Chorology* or *Distribution*, and to the fourth *Ætiology*. The great problems of the mineral world, as I shall proceed to show, fall under precisely the same categories; and we may perhaps gather some useful hints by a comparison between the immature results of the mineralogist in each of these departments and those more perfect ones which have been attained by the botanist and zoologist.

The morphology of minerals was for a long time studied to the exclusion of all other branches of the science; for the problems connected with form and structure were those which naturally first attracted the students of the "inorganic" world.

Few generalisations of science are so beautiful, and at the same time so suggestive, as those which have been arrived at by a discussion of the accurate measurements of crystal-angles. The constancy, within certain narrow limits, of corresponding angles, amid the almost infinite diversity of form assumed by crystals of the same mineral, is not less striking than the simplicity of the mathematical laws by which all these varied forms can be shown to be related to one another.

But the study of the morphology of minerals, which cannot be carried beyond a certain point by the aid of the goniometer, is capable of being pushed infinitely farther when we investigate the internal structure of their crystals, as illustrated by their optical and other physical properties. Not only do we find the minutest details of their external form to be correlated with peculiarities of molecular structure, as revealed by their action on a beam of polarised light, but delicate differences in internal

organisation which the goniometer is powerless to detect, become clearly manifested under the searching tests of optical analysis. For the mineralogist, indeed, the polariscope with its accessories has supplemented the goniometer, in the same way as the spectroscope has the balance of the chemist.

What has been stated concerning the optical characters of minerals is equally true of their other physical properties; for the researches of recent years have shown all these properties to be intimately related to the symmetry of the crystal in which they are displayed. In every crystal, the faces of each group bearing the same relations to its axes exhibit characteristic peculiarities in their lustre, in their hardness, and in the manner in which they are acted upon by solvents; and these serve to distinguish such groups of faces from others in the same crystal having different relations to its axes. The elasticity of crystals, their power of conducting heat and electricity, and their phosphorescent, electric, or magnetic properties, whether natural or induced, are all manifested in varying degrees along certain directions which can be shown to be related to the particular symmetry of the crystal. And the more carefully we study both the forms and the physical properties of minerals, the more are we impressed by the conviction that the most intimate relations exist between these characters and the chemical composition of the minerals.

The phenomenon of "plesiomorphism," as Miller proposed to call it, that is, the slight variation in the angular measurements of crystals in the same species or group, when any of the constituents are replaced by vicarious or isomorphous representatives, very strikingly illustrates this conclusion. And the exact study of the optical properties of minerals shows that the slightest variation in the relative proportions of these vicarious constituents makes its influence felt by changes in their colour, in their pleochroism, in the nature and amount of their double refraction, in the position of their optic axes, and, indeed, in the whole assemblage of the properties of the crystal.

To the admirable investigations of Tschermak on the feldspars, the amphiboles and pyroxenes, the micas, and other groups of minerals, we are largely indebted for the establishment of this conclusion; while Doelter, Max Schuster, and other mineralogists, have contributed many striking observations which serve to extend and fortify it.

The application of the microscope to the study of the internal structure of minerals—their histology—has led to the recognition of many beautiful and unsuspected phenomena. Examined in this way, the seemingly homogeneous masses exhibit many interesting intergrowths and inclosures; and the study of these, as shown by Sorby, Vogelsang, Renard, and Noel Hartley, may serve to throw new and important light upon the conditions under which the crystals were originally developed. Cavities containing carbonic acid and other liquids, with bubbles in constant and, seemingly, spontaneous movement, serve to awaken the interest of the naturalist not less powerfully than the mysterious creeping of protoplasm in the hair of a nettle, or the dance of blood-corpuscles in the foot of a frog!

Others among these histological peculiarities of crystals must be regarded as having a pathological significance; they are abnormal developments resulting from unfavourable conditions to which the crystals may have been subjected during their growth, or in the course of their long and chequered existence.

The variability exhibited in crystals of the same mineral is sometimes very startling. In addition to the varieties due to the combinations of many different forms, or to the excessive development of certain phases at the expense of others, we have the complicated and diversified structures built up by twinning according to different laws. Again, by oscillatory tendencies in the same crystal towards the assumption of different forms, or by the

existence of causes calculated to interfere with the free action of the crystallising forces, we may obtain varieties with curiously curved or striated faces. Not unfrequently large quantities of extraneous materials, solid, liquid, or gaseous, may be caught up in the crystal during its growth, and these foreign substances may be so far affected by the polar forces operating around them as to be made to assume definite and symmetrical positions within the crystal.

Even in the case of minerals of identical chemical composition and similar crystalline form, marked variations in physical properties may result from differences in the conditions under which they have originated. In lustre, density, and other characters, *adularia* differs from *sanidine*, and *elæolite* from *nepheline*. Dr. Arthur Becker has shown that quartz exhibits marked variations in its specific gravity, according to the particular conditions under which it has been formed.

There is one kind of morphological variability in minerals which has during recent years attracted a great amount of attention, and excited much discussion among mineralogists. Soon after his memorable discovery of the relations between the crystalline forms of minerals and their optical properties, Brewster detected certain apparent exceptions to his important generalisation; and since his day many additions to these curious anomalies in the optical behaviour of minerals have been made by other observers. So greatly, indeed, have these been multiplied in recent years, that it is doubtful whether any mineral crystallising in the cubic, the tetragonal, or the hexagonal system could be cited in which the optical properties are precisely what they ought to be according to theory; and similar anomalies are also found in crystals possessing lower degrees of symmetry.

The attempts which have been made by some crystallographers to account for these optical anomalies in crystals, by assuming that they possess only a pseudo-symmetry, the result of very complicated twinning, ingenious as they undoubtedly are, remind one of the wonderful addition of eccentrics and epicycles by which astronomers so long sought to maintain the credit of the Ptolemaic theory. But as, in the latter case, complexities and difficulties alike vanished when the centre of the system was shifted from the earth to the sun, so have the discoveries of Klein, Rosenbusch, and others removed the necessity for the painfully elaborate crystallographic hypotheses to which we have referred.

Most mineralogists will now be prepared to admit, as the result of these researches, that the perfection alike of form and of optical properties which characterises a crystal when first formed, is liable to slight modification, as the conditions of temperature and pressure under which it exists vary. In consequence of this, almost all natural crystals are found, when we study them with sufficient care, to exhibit slight but very striking and significant differences in form and optical behaviour from what they ought theoretically to possess.

While our knowledge of the ordinary mineral varieties promises to be vastly extended by the improvements which have been made in the methods of optical and chemical diagnosis under the microscope, there is, at the same time, reason to hope that the relationship of these numerous varieties will, by the same means, be made more clearly apparent. As the existence of well-defined natural groups of minerals becomes more clearly established, through the study of interesting though inconspicuous links, we shall obtain a basis for a much-needed reform in mineral taxonomy and nomenclature.

The more carefully we pursue our researches among the diversified forms of the mineral world, the more are we impressed by the conviction that each mineral, like each plant or animal, possesses its own individuality. Nature does not make *facsimiles* in the mineral, any more than in the vegetable or the animal kingdoms. All the

sciences of Nature must be content to recognise individuals as the only real entities, and to accept species, like genera, families, and orders, as convenient but purely artificial conceptions.

The geological study of minerals leads us to regard each specimen that we examine as possessing a distinguishing combination of properties, some of which are impressed upon it by causes operating when it came into being, while others are no less clearly the result of the long series of vicissitudes through which it has since passed.

Of all the branches of mineral morphology there is none from the study of which the geologist has gained more in the past, or from which he has greater reason to look for future aid, than that of the embryology of crystals.

In the year 1840 Link showed that the first step in the formation of crystals in a solution consists in the separation of minute spherules of supersaturated liquid in the mass; and subsequently Harting in Holland, and Rainey and Ord in this country, obtained a number of interesting experimental results, by allowing crystallisation to take place slowly in mixtures of crystalloids and colloids.

Valuable contributions to the same subject were made by Frankenheim, Leydolt, and others; but it is to Hermann Vogelsang that we owe the greatest and most important contributions to mineral-embryology. By the ingenious device of adding viscous substances to solutions in which crystallisation was going on, he succeeded in so far retarding the rate at which the operation took place as to be able to study its several stages. He thus showed how the minute "globulites," gathering themselves into nebulous masses or ranging themselves according to mathematical laws, gradually build up skeleton-crystals, by the clothing of which the perfect structures arise.

Since the early and regretted death of Vogelsang, the subject of the development of crystals from their embryos, the so-called *crystallites*, has been successfully prosecuted by Behrens, Otto Lehmann, Wichman, and other investigators.

Now in all glasses—whether of natural or artificial origin—in which the process of primary devitrification is going on, we have examples of the growth of crystals in a viscous and retarding mass, and in these, as Leydolt, Zirkel, and Vogelsang clearly saw, admirable opportunities are afforded to us for studying the formation of crystallites, and the laws which govern the union and growth of these into crystals. Two years ago, my predecessor in this chair submitted to you the interesting results of his own researches upon the devitrification of artificial glasses and slags; and the subject has since been pursued by Velain in France, and by Hermann and Rutley in this country.

The igneous rocks supply us with admirable opportunities for studying mineral embryology. In the same rock-mass we may sometimes find every possible gradation, from an almost perfect glass to a holocrystalline aggregate. By the study with the microscope of the several transitions in different parts of the mass, we obtain data for the most important conclusions concerning the phenomena of crystal-development.

There is another line of research in connection with mineral-embryology, which appears to be full of promise, and which has not yet received all the attention it deserves. In the "contact-zones" around great igneous intrusions, we find the curious so-called "spotted slates," which under the microscope are seen to contain nebulous patches, the mere ghostly presentments of crystals, struggling into being in the amorphous mass. The development of these nebulous masses into perfect crystals, exhibiting the characteristic external forms and optical properties of andalusite and kyanite, of garnet and epidote, of hornblende and mica, may be traced in some cases with the greatest facility.

More complicated still are the phenomena exhibited along the foliation-planes of the rocks, which have been made to flow in the act of mountain-making. There, the old minerals are destroyed, new ones build themselves up from their elements. The study of all the steps of the process is an undoubtedly difficult one, but the results already obtained by Reusch, Lossen, Heim, and Lehmann by Lapworth, Teall, Roland Irving, and Williams, lead us to look hopefully forward to the full solution of the grand but complicated problems of regional metamorphism.

The field of mineral-embryology is indeed a promising one, and its diligent cultivators may hope to gather harvest no less rich than that which has been reaped by the workers in the same department of the biological sciences.

(To be continued.)

TABASHEER

I HAVE often wondered that this curious substance has never attracted more attention. But scanty reference to it are to be found in books, and yet it seems to me that few more singular things are to be met with in the vegetable kingdom.

In Watts's "Dictionary of Chemistry" (vol. v. p. 653) exactly six lines are devoted to it. It is defined to be "Hydrated silica, occurring in stony concretions in the joints of the bamboo. It resembles hydrophane, and when thrown upon water does not sink till completely saturated therewith." It is further stated to be the least refractive of all known solids, and an analysis by Rost von Tonninge of a specimen from Java gives a composition of 86.39 per cent. silica soluble in potash, 4.81 potash, 7.63 water, with traces of ferric oxide (to which I suppose its occasional yellowish colour to be due), lime, and organic matter.

There are several specimens in the Kew Museum, partly derived from the India Museum. All consist of small irregular angular fragments, varying from the size of a pea downwards, and opaque white in colour. It is obvious that these fragments are the debris of large masses.

Now, the presence of considerable solid masses of so inert a substance as hydrated silica in the plant-body is a striking fact. At first sight, one might compare it to the masses of calcium phosphate which form the endo-skeleton in the higher animals. These, however, serve an obvious mechanical purpose, which cannot be attributed to the lumps of tabasheer in the hollow joints of a bamboo. The presence of silica may sometimes serve an adaptive purpose, as in the beautiful enamelled surface of cane. And according to Dr. Vines ("Physiology of Plants," p. 21 "Struve found that it constitutes 99 per cent. of the dry epidermis of *Calamus Rotang*."¹

In a few other groups of plants, such as *Equisetum* and the *Diatomaceæ*, it is a characteristic constituent. In a case it principally occurs in the cell-wall (Vines, *loc. cit.* p. 137). This has suggested the highly ingenious speculation that, seeing the intimate chemical relationship which obtains between silicon and carbon, there might be silicon-cellulose. I notice that Count Castracani in his Report on the *Diatomaceæ* collected by the *Challenger*, speaks of its "having been already shown that silica is sometimes substituted for carbon in the formation of cellulose" (p. 7). Judging from ash-analysis it might be supposed that silica was an essential constituent of gramineous plants. But by the method of water culture Sachs has found that maize, for example, will grow with only a trace of silica. I must confess to ignorance of all that may have been done in the matter recently. But Ladenburg thought, and I think with reason, that the indifference of the plant to silica was

¹ Sachs's remarks ("Text-book," second edition, p. 700) that silica accumulates chiefly in the tissues exposed to evaporation, though this clearly does not apply to the case of diatoms.

ong argument for a silicon-cellulose in which silicon ght or might not with equal physiological convenience ay the part of one or more atoms of carbon. Fascinat- g as this hypothesis is, I am bound to say that the olonged investigation which he devoted to the question on the whole adverse to the idea of silicon playing any rt of the kind.

It still remains then an unsolved problem why, when no laptive end is involved, plants should take up such rel- vely enormous quantities of silica. The case of the frus- les of *Diatomaceæ* is peculiar, as there the silicious wall is pparently a continuous plate of inorganic matter capable resisting without impairment treatment by the most ructive and disintegrating agencies known. Yet astracane adduces evidence to show that such walls can ow; and as this can only be by interstitial growth, a olecular constitution is implied quite different from any- ing physical, and precisely similar to that of a cellulose embrane. He quotes, indeed, von Mohl for the opinion at the wall is not simply inorganic, "but only an organic embrane which is impregnated with silex."

Now, in the case of tabasheer, it is quite evident that e plant takes up an amount of silica beyond its powers use, and so it is exuded into the hollow cavities of the imboo stem. I do not mind confessing that, in so far as had reflected on the matter at all, I had pictured to yself this as taking place by some process of secretion, that the mass of tabasheer ultimately accumulated from ccessive portions of thrown-off silica. I was obliged, owever, to give a little more serious thought to the matter hen Prof. Cohn, of Breslau, wrote to me that he proposed investigate the whole subject, and asked for help in the ay of specimens and information. It then struck me hat a very singular thing the phenomenon of the occur- ence of tabasheer really was. I set to work to hunt up the literature of Indian botany some rational account of e matter. The only ray of light I got was from the Forest Flora of North-West and Central India," by Dr. randis, late Inspector-General of Forests to the Govern- ent of India. Everyone who knows Dr. Brandis knows at he gave to administration the energy he would more illingly have devoted to scientific pursuits. I was not at I surprised to find, therefore, modestly hidden in his ook (p. 566) the key to the riddle. He says: It is not all impossible that the well-known silicious deposit *abasheer*) which is found in the joints of this and other ecies [*Bambusa arundinacea*] may be the residuum of e fluid which often fills the joints." I communicated is to Prof. Cohn, and he was good enough to tell me that e quite agreed that this was the correct explanation. I at e same time wrote to Dr. King, the distinguished Super- tendent of the Royal Botanic Garden, Calcutta, to know it were possible to procure specimens of tabasheer *in situ*, s we possessed in our Museum nothing but broken frag- ments. I extract from several letters he has written me e following particulars:—"January 11. I have inquired f several old workers as to the situation tabasheer occu- ies. They all say it is found either on the floor of the int, or if (as is so often the case in *B. Tulda*) the stem ans over, it is also found on the lower wall. It is never und on the roof of a joint. . . . Tabasheer is not ommon in bamboo grown near Calcutta. And, besides, is apt to be forced out of its natural position by the rced used in breaking a joint open. There is no eternal mark by which a tabasheer-bearing joint can e recognised prior to being opened." "January 18. I have ot a specimen of tabasheer *in situ* for you. It concretes a jelly, and is now being carefully dried off."

I think that these extracts (in which the italics are mine) lly confirm the explanation as far as I know first put at by Dr. Brandis. The rapidity of growth of a bamboo oot is well known to be enormous. The root-pressure probably equally great. The joints, at first solid, become ollow by the rending apart of the internal tissues, and

water containing silica in solution is poured out into the cavities so formed. When the foliage is developed, trans- piration is active: the water taken up from the ground is rapidly got rid of; not merely is the root-pressure compensated, but the water poured out into the joints is re-absorbed. It is not easy to see why the silica should not be always taken with it, as in the vast majority of cases it no doubt is. But in the cases in which it is left behind it has apparently simply undergone a process of dialysis. The determining causes of the occasional deposit of tabasheer are, I think, still obscure. But, as Prof. Cohn intends to investigate the subject, I think we may pretty confidently look forward to an exhaustive explanation.

It is a well-known fact that a large proportion of the ash-constituents of plants may have but little significance in their nutrition. The chemical constitution of plants, as far as their ash is concerned, to a large extent varies with the nature of the soil in which they are grown. It is quite certain that they will in consequence take up a vastly larger proportion of certain constituents than they can turn to any physiological account. Tabasheer is a striking instance of one such case. The calcareous masses found in the wood of many Indian trees mentioned in NATURE, vol. xxi. p. 376, affords another.

W. T. THISELTON DYER

ON THE EARLIER TRIPOS OF THE UNIVERSITY OF CAMBRIDGE

I HAVE read with great interest the papers by Mr. Glaisher in NATURE of December 2, 18, and 30, 1886 (pp. 101, 153, and 199), entitled "The Mathematical Tripos." Through the period common to Mr. Glaisher's notes and my recollections, I believe that we are strictly in agreement. I am able, however, to supply some little histories (I wish these had been more numerous and more certain) relating to transactions several years earlier than those known, personally, to Mr. Glaisher, and I am desirous that their memory should not be totally lost. There are now few persons, perhaps none, whose recollections of the University of Cambridge and of Trinity College go so far back as my own.

I first advert to the official course of undergraduates' life.

Shortly after introduction to the College in the October Term of 1819, I attended, with all other freshmen, in the Senate House or in the College Hall (I believe the latter) to take the oaths of allegiance and supremacy. With great ardour I renounced the "damnable doctrine" that the Pope of Rome could absolve subjects from their allegiance, with several similar declarations; and I also disclaimed all connection with other Universities and Colleges, and in particular with Wolsey's College at Ipswich. I believe (but have no certain knowledge) that these puerilities terminated a few years afterwards.

The undergraduates were arranged in "sides," divided under the official tutors under whom they were entered in the College Lists. There were then two "sides"; subsequently there were three. The lectures on each side were held in the College rooms of the tutor or his assistant tutor. The lectures consisted, naturally, in proposals of theorems and problems (in writing) and oral discussion of the answers in a friendly style.

The annual College examinations of the undergraduates of all sides (collected), of each year of undergraduateship, were held in the College Hall at the practical termination of the May Term. The order of merit in each year, as determined by these examinations, was published by lists of names suspended in the College Hall. Small sums of money, to be expended in honorary prizes, were assigned to the First Class of each year.

In the third year of undergraduateship arrived the time

of "keeping Acts and Opponencies." These, as Mr. Glaisher has explained, were formerly the only public exhibitions of students' merits in the University; and, possibly, were still considered in the University as more important than would be gathered from Mr. Glaisher's account. The three Opponents met to take tea and to arrange their arguments; the Act also was invited, with an intimation that he was not to stop long. I have seen the "Schools," in which the disputations were held, quite filled with undergraduates of all Colleges, who came to listen to the disputations, or rather quibbles, held in the Latin language, of the argumentative quarrel. If my memory is correct, each of the undergraduates (selected, I believe, by the Moderators) appeared twice in the character of "Act" (asserting the correctness of some doctrine in the printed books), and twice or more in the character of "Opponent" (denying that correctness). The President of the School was one of the Moderators. The assertion of the Moderator that the argument failed was given by the words "Probes aliter." The discussion was usually closed by a complimentary address of the Moderator, as, for instance, "Magno ingenio argumenta tua et construxisti et defendisti." I do not think that the form lasted many years after this time.

At length came the October Term, the last term (the tenth) for undergraduates, of which I remember only one characteristic, namely, that in the College Hall a separate dinner-table was established for the "Questionists" (as those were called who were to proceed to the B.A. degree in January). To this table all Questionists were removed from whatever tables they previously occupied. Among others, the "Scholars" of the College (Trinity) were removed from their table, where they had formed agreeable acquaintances, to a collection of strangers, naturally disagreeable to the "Scholars." We much dislike this change. I think that in this term the character of the College lectures was changed almost entirely to problems and questions; some of them in the evening, in the College rooms of one of the Fellows.

At length arrived the Monday morning on which the examination for the B.A. degree was to begin. A breakfast was given by the "Father" of the College (one of the Fellows of the College) in the College Combination Room, and then we were all marched in a body to the Senate House and placed in the hands of the Moderators. How the "candidates for honours" were separated from the *οι πολλοι* I do not know. I presume that the Acts and Opponencies had something to do with it. The honour-candidates were divided into six groups; and of these Nos. 1 and 2 (united), Nos. 3 and 4 (united), and Nos. 5 and 6 (united), received the questions of one Moderator. No. 1, Nos. 2 and 3 (united), Nos. 4 and 5 (united), and No. 6, received those of the other Moderator. The Moderators were reversed on alternate days. There were no printed question-papers: each examiner had his bound manuscript papers of questions, and he read out his first question; each of the examinees who thought himself able proceeded to write out his answer, and then orally called out "Done." The Moderator, as soon as he thought proper, proceeded with another question. I think there was only one course of questions on each day (terminating before 3 o'clock, for the Hall dinner).

The examination continued to Friday mid-day. On Saturday morning, about 8 o'clock, the list of honours (manuscript) was nailed on the door of the Senate House.

The ceremonies and customs of conferring degrees in the middle of the day, I believe, have not been altered. The Vice-Chancellor was seated in the centre of the Senate House. The Father of that College of which the Senior Wrangler was a member led him to the Vice-Chancellor. The roar of acclamation from the undergraduates in the

Senior Wrangler, will not be forgotten by one who has heard it. The Father presented him with the words: "Dignissime Domine, Domine Procancellarie, et tota Universitas, præsento vobis hunc juvenem, quem scio tam moribus quam doctrinâ esse idoneum ad respondendum Quæstioni; idque tibi fide meâ præsto, totique Universitati." The candidate knelt before the Vice-Chancellor, who pressed the candidate's hands between his own, and answered: "Auctoritate mihi commissâ, admitto te ad respondendum Quæstioni, in nomine Patris, et Filii, et Spiritûs Sancti." I am not able to say how much of this was repeated for each candidate. Then followed some petty quibbles with some Master of Arts concerning questions which nobody professed to understand, but which were inessential. The undergraduate gown was then changed for a B.A. gown.

On a certain day following, at a Congregation of the Senate, the list of names of those who were thus admitted was read to the Vice-Chancellor, who (as I understood) solemnly recognised the rights of the first to the privileges of Bachelor of Arts, and to each of those following only repeated the words "et ei," finally declaring that they were "actualiter in Artibus Baccalauros."

It is evident that there must have been some relation between the various ranks which no longer exists; and, in particular, that the *Quæstio* was once important, and is now totally lost. And connections existed between the Colleges and the University which can scarcely be traced at the present day.

I now advert to the mathematical subjects of study and examination.

In the October Term, 1819, the only books on pure mathematics were: Euclid generally; "Algebra," by Dr. Wood (formerly Tutor, but, in 1819, Master, of St. John's College), Vince's "Fluxions" and Dealtry's "Fluxions," Woodhouse's and other Trigonometries. Not a whisper passed through the University generally on the subject of differential calculus, although some papers (subsequently much valued) on that subject had been written by Mr. Woodhouse, Fellow of Caius College; but their style was repulsive, and they never took hold of the University. Whewell's "Mechanics" (1819) contains a few and easy applications of the differential calculus. The books on applied mathematics were: Wood's "Mechanics," Whewell's "Mechanics," Wood's "Optics," Vince's "Hydrostatics," Vince's "Astronomy," Woodhouse's "Plane Astronomy" (perhaps rather later); the first book of Newton's "Principia." I do not remember any others. These works were undoubtedly able; and I do not conceal my opinion that for the great proportion of University students going into active life books constructed on the principles of those which I have cited were more useful than those exclusively founded on the more modern system. For those students who aimed at the mastery of results—more difficult and (in the intellectual sense) more important—the older books were quite insufficient.

More aspiring students read, and generally with much care, several parts of Newton's "Principia," Book I. and also Book III. (perhaps the noblest example of the geometrical form of cosmical theory that the world has seen). I remember some questions from Book III. proposed in the Senate House Examination, 1823.

In the October Term, 1819, I went up to the University. The works of Wood and Vince, which I have mentioned, still occupied the lecture-rooms. But a great change was in preparation for the University course of mathematics. During the great Continental war, the intercourse between men of science in England and in France had been most insignificant. But in the autumn of 1819 three members of the Senate (John Herschel, George Peacock, and Charles Babbage) had entered into the mathematical society of Paris, and brought away some of the works on

mechanics (principally Poisson's). In 1820 they made a translation of Lacroix's "Differential Calculus," and they prepared a volume of "Examples of the Differential and Integral Calculus." These were extensively studied; but the form of the College examinations or the University examinations was not, I think, influenced by them in the winter 1820-21 or the two following terms. But in the winter 1821-22 Peacock was one of the Moderators; and at the Senate-House Examination, January 1822, he boldly proposed a paper of important questions entirely on the differential calculus. This was considered as establishing the new system in the University. In January 1823 I think the two systems were mingled. Though I was myself subject to that examination, I dare not say that I have forgotten many of the details, except that I well remember that some of the questions referred to Newton, Book III., on the lunar theory. To these I have already alluded. No other work occurs to me as worthy of mention, except Woodhouse's "Lunar Theory," entirely founded on the differential calculus. The style of this book was not attractive, and it was very little read. From this time to the times of which Mr. Glaisher writes, there were successive books on the new system, but none, I think, which can be cited as producing a marked effect in the University. G. B. AIRY

NOTES

THE University of Bologna has decided to celebrate its eight hundredth anniversary in the spring of 1888. The exact date of its foundation cannot, indeed, be determined, but all authorities on the subject agree that an important school was established at Bologna in the eleventh century. Afterwards the University took a great place as the chief centre for the study of jurisprudence, and there also anatomy was for the first time scientifically studied. The foremost Universities of Europe and America will no doubt be glad to take an opportunity of testifying their respect for so ancient and famous an institution.

At their meeting on February 3 the President and Council of the Royal Society adopted the following resolutions concerning the publication of the Philosophical Transactions:—That the transactions be published in two independent series, one (a) containing those papers which are of a mathematical or physical character, the other (b) those of a biological character; that the papers in each series form a yearly volume, pagged continuously though issued in parts if the Secretaries find it convenient, but that each paper be also published separately in paper covers as soon as it is ready for publication; and that Fellows have the option of receiving one or both of the yearly volumes, or should they prefer it, each separate paper of either or both series, or the whole of one series and any separate paper of the other series, immediately on publication. These resolutions are to take effect from the volume for the present year.

A COMMITTEE, lately appointed by the College of Physicians in Edinburgh, has reported in favour of the establishment and maintenance, by the College, of a laboratory for the prosecution of original research. The Committee proposes that the College should vote from its capital 1000*l.* for the establishment of this laboratory, and, year by year, a sum not exceeding a third of the clear surplus of annual income over annual expenditure for maintenance, including the payment of salaries. The superintendent, it is thought, should devote his time wholly to the direction and prosecution of scientific research in the laboratory; it is suggested that an assistant experienced in microscopic work should be engaged to reside on the premises. The Committee is of opinion that the laboratory should be open without fee to Fellows of the College, to members, and to any licentiate.

medical man, or investigator who may, by testimonial or otherwise, be able to show that he is a fit person to use the laboratory for purposes of scientific research. Moreover, the Committee recommends that, if there should be sufficient funds after payment of expenses, a medal and money-prize (not exceeding twenty guineas) should be offered for original work. It is understood that this admirable scheme will be adopted, and we may hope that the example set by the Edinburgh College will soon be followed by the English College of Surgeons and College of Physicians.

A CORRESPONDENT writes to us from Tashkend that on November 29 last, at 9.12 a.m., a violent shock of earthquake was felt there, accompanied by a great noise like thunder. The people were much frightened, and the majority of the buildings were more or less injured. Light shocks were felt also on December 3, and on January 9 and 16.

ON the 15th of January last there was in some parts of Japan the most severe earthquake that has been experienced there since February 22, 1880. It fetched down a number of chimneys and parts of roofs in Yokohama, but in Tokio (eighteen miles distant) it only broke a few vases and created alarm. The important and peculiar feature of the disturbance was that it had a long period and large amplitude. At the Imperial Observatory at Tokio, where a number of "Gray-Milne seismographs" are employed, the pointers of the instrument were seen to move for nearly ten minutes. We learn from the *Japan Gazette* that the disturbance was felt at Tokio at 6h. 51m. 59s. p.m., commencing in a series of small waves. The greatest horizontal movement was 19.2 mm. (about $\frac{3}{4}$ inch). The time taken to describe the largest wave was 2.3 seconds. The vertical motion had a range of 5.5 mm. (about $\frac{1}{4}$ inch), and its period was .8 seconds. Altogether there were 60 distinct waves, and the maximum velocity with which the earth moved to and fro was 26 mm., or about 1 inch per second. At Tokio people felt the motion as if they had been on a slowly-moving floating pier, and in many cases it provoked a sensation of nausea. The general distribution of destruction at Yokohama was similar to that which took place in 1880. The *Japan Gazette*, however, points out that many chimneys standing on ground which in 1880 suffered severely were this time uninjured. This "anomaly," it thinks, may be explained by the fact that the owners of these chimneys took advantage of the experience they gained in 1880, and rebuilt their chimneys with a special view to their safety.

THE Right Hon. G. Selater Booth, M.P., has accepted the Presidency of the Congress of the Sanitary Institute of Great Britain, to be held at Bolton in September next.

ON March 6 a century will have elapsed since the birth of the celebrated optician, Joseph von Fraunhofer, at Straubing, in Lower Bavaria. Preparations are being made in Munich for the due celebration of the day.

IN the eleventh annual Report of the President of the Johns Hopkins University, Baltimore, Dr. Gilman is able to give a very satisfactory account of the progress made by the institution since its establishment in 1876. Much of its success, he thinks, is due to the system of Fellowships. Every year twenty young men who have given evidence of their attainments and of intellectual promise are selected by the authorities as Fellows, and are encouraged to devote all their time to the study of some branch of knowledge in which they have already shown proficiency. During the first ten years this honour has been bestowed upon 130 persons. Their names and the stations to which they have been called have been frequently printed, and Dr. Gilman says a scrutiny of the list will show that it contains the names of many excellent scholars. While resident at the University, the Fellows are

recognised as holding an intermediate position between the Faculty and the great body of pupils. They are efficient members of the various literary and scientific associations, and occasionally give lectures on topics which they have specially studied.

A NEW quarterly journal, to be entitled the *American Journal of Psychology*, will soon be issued. Dr. G. Stanley Hall, Professor of Psychology and Pedagogics in the Johns Hopkins University, will be the editor. The *Journal* will contain original contributions of a scientific character; and articles of unusual importance will be translated from other languages, or even reprinted from other English and American publications, in full or in abstract, if not generally accessible. An attempt will be made in each number to give a conspectus of the more important psychological literature of the preceding three months, and to review significant books, bad as well as good.

A SCIENTIFIC and industrial Exhibition will be opened at Ekaterineburg in May next. The mining industries of the Ural Mountains will be well represented. Special interest will attach to the department of ethnography, as it has been arranged that there shall be in the Exhibition a number of families belonging to semi-barbarous tribes of the Ural Mountains and Siberia. Their dwellings will be exactly like those in which they usually live, and they will have with them the weapons and implements used by them in hunting and fishing. Another important element will be a collection of ancient objects in stone, bone, clay, and metal, found in Siberia and among the Ural Mountains. These objects have never before been publicly exhibited.

A CAUCASIAN Agricultural Exhibition will be held next year in Tiflis. Products of the animal, vegetable, and mineral kingdoms will be exhibited.

FISH-HATCHING operations have begun at the Buckland Museum, where consignments of trout ova, presented by Sir James Maitland, have been laid down in the incubating apparatus used by the late Mr. Frank Buckland. The system upon which the ova are hatched at the Museum is that known as the "overflow," the water passing over the eggs, which are placed in slate boxes lined with gravel. The new system is called the "underflow," the water passing underneath the eggs, which are deposited in perforated zinc trays without gravel. Much diversity of opinion exists as to the efficacy of the two systems.

THE other day some workmen, while removing brickwork that had surrounded a tank in the late South Kensington Aquarium, found ten eels secreted in a crevice of the masonry, which was perfectly dry. The tank had been removed eighteen days before, when the Aquarium was dismantled, so that the fish must have been without water during the whole of that time. When placed in water they appeared to have been in no way injured by their terrestrial experience.

IN the debate on the appropriations for the support of the U.S. Coast Survey, the Senate, according to *Science*, pared the items down in a parsimonious spirit. Afterwards the Senate Appropriations Committee addressed a letter to the Secretary of the Treasury, inquiring whether the estimates as submitted by the Superintendent of the Coast Survey were satisfactory to that Department. The answer was that they were perfectly satisfactory, and a communication from the Superintendent of the Coast Survey was submitted, showing the reasons for each item of expenditure, and the present condition of the service. "From these communications," wrote the Secretary, "it appears that the estimates made provision for the efficient and economical prosecution of the Survey during the ensuing year; it also appears that the provision made by the House Bill will not secure such results. Consequently the arrangement made is not satisfactory to this Department."

WE learn from Italy that the idea of boring a tunnel between the peninsula and Sicily has been revived. The estimated cost is said to be seventy-one millions of francs, and the time required for completing the work would be from four to six years. It is stated that the depth of the sea is 160 metres.

THE number of foreigners at present residing in France, and settled there, is 1,115,214, against 37,103,689 Frenchmen. The parts of France in which the foreigners are most numerous are of course the frontier departments, those of the Nord, Alpes Maritimes, Var, Bouches du Rhône, &c. In the Seine Department there are 213,529 foreigners; in the Nord 305,524, most of whom are Belgians.

OYSTER-PRODUCTION, although carried on to a large extent in France, is not yet a profitable investment. The reason is that the rates for transportation from the oyster-beds are too high. In Auray, for instance, oysters are worth nine francs per thousand; in Paris they cost more than fifty francs. An attempt is being made to secure transportation at less cost.

A MOVEMENT is on foot in the North Sea towns of Germany for promoting oyster-culture along the coast, supported by Government grants. At present there are fifty-one banks in the North Sea, viz. twenty-six at Fanø, Romo, and Sylt, and twenty-five at Fohr, Amrum, and Hallingerne. In the Baltic, on the other hand, all attempts at oyster-culture have failed. "Holstein" or "Flensburg" oysters—considered the best in Germany—are really English or Dutch. All the German oyster-banks are the property of the State, and leased to private individuals.

WE regret to announce the death of Dr. Walfried Marx, Professor of Descriptive Geometry at the Technical High School at Munich. He died on February 10.

THE first International Horticultural Exhibition will be held at Dresden on May 7.

HERE is a case in which even a little knowledge of physics would not have been out of place. A man was summoned for making use of the communication between passengers and guard without reasonable and sufficient cause. Being in a third-class compartment alone, he was frightened by the singing noise of his foot-warmer, caused by the contraction of metal due to the reduction of temperature. Thinking it an infernal machine, he immediately threw it out of the window, and, not content with this drastic proceeding, he incontinently proceeded to stop the train by using the excellent mode of communicating with the guard and engine-driver which exists on the South-Eastern Railway. A little more science and a little less energy would have saved everybody a little trouble, but as his *bona fides* was as obvious as his ignorance, the magistrate dismissed him with a caution. The magistrate might, perhaps, have done some good if he had told the man what happens when an ordinary kettle is filled with ordinary water and placed on an ordinary fire.

IN a recent number, *Science* referred to a supposition that "it is change of diet which is the most potent remote cause of consumption among the Indians." Mr. H. C. Wyman, of Detroit, writes to that journal that, in his opinion, another cause is change of dress. "If," says Mr. Wyman, "a live rabbit be dipped in a solution of glue, so as to cover its body with a coating impervious to air, it is surprising how quickly the frequency of the respiratory movements increases, showing that the work of the lungs is increased by depriving the skin of free access to the air. The process of civilisation has a somewhat similar effect upon the Indian, though to a less degree. One of the first lessons in the effort to civilise him teaches him to envelop himself in clothing of a kind that tends to impede and impair the normal action of the skin, the pores of which are organs of excretion—a mechanism by which morbid and waste material may be thrown out of the system. Deprived of the assistance

forded under previous conditions by the skin, the work of the lungs is greatly increased, rendering them peculiarly susceptible to bronchitis and pneumonia—ailments which are commonly the byrunners of consumption. If we accept the theory of Koch, they make the lungs a suitable habitation for the *Bacillus tuberculosis*." Mr. Wyman contends that, in the case of civilised races, the liability to consumption from overworked lungs has been tempered by hundreds of generations of ancestors habituated to the use of clothing.

IN the Report of the U. S. Geological Survey on the mineral resources of the United States for 1885, it is stated that the total mineral product is valued at 428,521,356 dollars, an increase of 15,306,608 dollars over 1884. Among seventy mineral substances cited, coal is the most important, showing a total value of 159,019,596 dollars. An increase is shown in the production of coke, natural gas, gold, silver, copper, zinc, quick-silver, nickel, aluminium, lime, salt, cement, phosphate rock, manganese, and cobalt oxide, while the production of coal, petroleum, pig-iron, lead, precious stones, and mineral waters decreased. According to the Report, it is probable that the total output of 1886 was much greater than that of 1885, and even larger than that of 1882.

WE have received the *Annuaire* for 1887 of the Académie Royale des Sciences, des Lettres, et des Beaux-Arts de Belgique. It contains a full account of the organisation of the Academy, and of the means by which it seeks to encourage science, literature, and art. Among the biographical notices are articles on the late François Lenormant and Edouard Morren.

AN illustrated work, entitled "Les Civilisations de l'Inde," by Dr. Gustave Le Bon, is being issued in weekly parts by Firmin-Didot et Cie. Dr. Gustave Le Bon is the author of a work on "La Civilisation des Arabes."

THE Calendar of the Imperial University of Japan for the current year, which we have just received, deserves special mention, for it is the first that has been issued since the amalgamation of the well-known College of Engineering and the University of Tokio into the single institution which forms the new University. This incorporation was made the occasion for several organic changes, one of which is the almost total elimination of Europeans from the teaching staff, their places being taken by Japanese. To understand the full extent of the change in this respect, it is necessary to remember that five or six years ago all the professors in the College of Engineering, and nearly all in the University, were Europeans. An examination of the Calendar shows how the new University stands in this respect. By the Imperial decree, which is the charter of the institution, the Council of Professors regulate the studies and generally look after the interests of the University and each of its Colleges. There is not a single Western amongst the nine Councillors. In the Law College, three out of thirteen professors and lecturers are Westerns; in the Medical Faculty, out of thirty-four professors and assistants, there are three Europeans; there are three Europeans amongst twenty-four professors and assistants in the Faculty of Engineering; two in twenty-six in Science; and three in nineteen in Literature. It is probably not too much to say that, where one European is teaching now, there were six Europeans five years ago. It was only to be expected that ultimately the Japanese would have their own men ready to take the places vacated by Europeans. They had at vast expense sent abroad large numbers of youths to be educated for the various professions in Europe and America, who, on their return, were competent to teach their countrymen; and in looking down the lists of the Japanese professors we see that most of them have foreign degrees and other qualifications. They come from almost every German, French, British, and American University, and in some instances

have taken high honours. They may therefore be presumed to be competent for the work which they have undertaken, and there is no special reason to believe that the step taken by the Minister of Public Instruction in placing the higher education of the country in the hands of his countrymen is premature. Be this as it may, it is clear that the day of Europeans in Japanese education is past, and this fact is only emphasised by the few familiar names amongst a host of unfamiliar ones in the list of the University. Moreover, even where there are one or two foreign professors, the direction is all in Japanese hands. The Director and the chief Professor in every Faculty are Japanese, so that if the individuals are fewer in number, the functions and status of each one remaining have also diminished. Time alone will show whether the experiment—for undoubtedly the Imperial University is at present in the experimental stage—will be successful or not. He would be a bold man who, for example, prophesied that the Faculty of Engineering in the new University will maintain the high position won for the old Imperial College of Engineering in the world of science by a body of brilliant European professors, some of whom are now in the front rank at home. In the Calendar there is certainly evidence of much activity. An Astronomical Observatory has been fitted up for the instruction of the students; there is also a Seismological Observatory, with horizontal pendulum and vertical-motion seismographs. By the aid of a complete set of these instruments now in the Observatory, it is possible to measure earth-movements of different grades of magnitude. In addition, a system of telegraphic communication with different parts of the city extends the area of observation. A Botanic Garden and a small Marine Biological Laboratory are likewise attached to the Science Department.

THE additions to the Zoological Society's Gardens during the past week include a Green Monkey (*Cercopithecus callitrichus* ♀) from West Africa, presented by Mr. Julius Wilson; a Secretary Vulture (*Serpentarius reptilivorus*) from South Africa, presented by Capt. Larmer, s.s. *Trojan*; a Crowned Hawk Eagle (*Spizactes coronatus*) from Natal, presented by Colonel H. Bowker, F.Z.S.; a Spotted Eagle Owl (*Bubo maculosa*) from South Africa, presented by Mr. H. Justice; a Brazilian Hangnest (*Alercus jamaicai*) from Brazil, presented by Mr. W. G. Little Gilmour; two Crossbills (*Loxia curvirostris*), British, presented by Mr. W. H. St. Quintin; two White-fronted Lemurs (*Lemur albifrons*) from Madagascar, deposited; a — Capuchin (*Cebus* —) from South America; two Chimachima Milvagos (*Milvago chimachima*) from Brazil, purchased.

OUR ASTRONOMICAL COLUMN

THE BINARY STAR δ EQUULEI.—This close and rapid binary, which was discovered in 1852 by M. O. Struve, and measured on a number of nights between that time and 1874, was supposed by its discoverer to have a period of between 6 and 7 years or one of about 13 years. More recently, Mr. Burnham, who observed the star between 1880 and 1883, concluded from an examination of all the measures that the period was about 10.8 years. It is therefore the most rapid binary now known. At the request of Prof. Glasenapp of St. Petersburg, Herr Wrublewsky (*Astron. Nachr.* No. 2771) has computed a set of elements from all the available observations. He finds the time of periastron passage to be 1892.03, with eccentricity = 0.2011, mean distance, = 0".406 and period = 11.478 years. These elements do not, however, represent the observed position-angles satisfactorily, and it is desirable that the possessors of sufficiently powerful telescopes should pay some attention to this very interesting object, especially at the present time, when the components are about at their maximum distance apart. Herr Wrublewsky's orbit gives, for 1887.24, position-angle = 204°.9, and distance = 0".48.

THE TEMPLE OBSERVATORY.—From the Report of Mr. Seabroke, honorary Curator of the Temple Observatory, Rugby,

we learn that during 1886 Mr. Percy Smith continued the measurement of position-angles and distances of double stars, 88 sets of measures having been secured. These stars have been divided into three categories for future re-measurement, viz. rapid binaries, to be observed every year; slower binaries, to be observed every 4 years; and long-period binaries, to be observed every 10 years. Mr. Seabroke himself has continued the measurement of the motion of stars in the line of sight with the spectroscope on the reflector, and has completed 100 sets of measures. These observations, together with the corresponding ones for previous years, have been published in the January number of the *Monthly Notices*.

DISCOVERY OF A NEW COMET, 1887 d (BARNARD 2).—A new comet was discovered on February 15 by Mr. E. E. Barnard, Nashville, Tennessee. It was very faint, and was moving rapidly in a north-westerly direction. At midnight (local time) its position was R.A. 8h. 4m., Decl. 16° 10' S.

PROBABLE NEW VARIABLE.—We learn from Circular No. 15 of the Liverpool Astronomical Society, that Mr. Backhouse finds 28 Andromedæ to be probably variable within small limits. The observations yet obtained are insufficient to fix the period, which must, however, be short. It is possible that the star is of the Algol type.

NAMES OF MINOR PLANETS.—Herr J. Palisa has named Minor Planet No. 256 Walpurga.

BRIGHTNESS AND MASS OF BINARY STARS.—The current number of the *Observatory* contains an article on this subject by Mr. W. H. S. Monck, in which he attempts to deduce the relative brilliancy of those binaries for which the orbits are best determined. Assuming that the mass of the companion-star is very small as compared with that of its primary, he shows that the relative brilliancy of any two pairs of binaries may be found by the following formula:—

$$\frac{k_1}{k_2} = \left(\frac{I_1}{I_2}\right) \cdot \left(\frac{P_1}{P_2}\right)^{\frac{3}{2}} \cdot \left(\frac{a_2}{a_1}\right)^3,$$

where I_1, I_2 stand for the total amount of light, as determined photometrically, which we receive from the two pairs respectively; P_1, P_2 for their periods; and a_1, a_2 for the angular radii of their orbits.

By, apparently, a printer's error, the index of $\left(\frac{P_1}{P_2}\right)$ is omitted

in the formula in the *Observatory*. Adopting ξ Ursæ Majoris as his unit of comparison, Mr. Monck finds the brilliancy of γ Leonis 93.29; of Castor, 38.24; δ Cygni, 35.52; of Sirius, 7.17; 42 Comæ, 2.79; 6 (ρ) Eridani, 0.20; and 61 Cygni, 0.08. It is noteworthy that Prof. E. C. Pickering, in a paper which appeared in the Proceedings of the American Academy of Arts and Sciences, vol. viii. No. 1, obtained very similar results for many of the same stars, but by a somewhat different process. In both lists γ Leonis figures at the head, followed by Castor and δ Cygni, whilst the smallest values are found for ρ Eridani and 61 Cygni. The weak point in Mr. Monck's computation is the assumption that the mass of the smaller star is comparatively insensible; the near equality in magnitude of many of the binaries selected would seem to indicate that the assumption was not a safe one. Mr. Monck repeats Prof. Pickering's suggestion that series of careful measurements should be made between each component of the binary systems and some neighbouring stars, so that the ratio of the masses of the two components may be determined. It is to be hoped that some double-star observers may be induced to take up this interesting subject, now that attention has again been called to its importance. The research might also possibly supply us in some cases with a determination of the distance of the binary.

THE LIVERPOOL ASTRONOMICAL SOCIETY.—The Pernambuco branch of this Society now numbers more than eighty members, and has been accorded permission to elect a local executive. The Emperor of Brazil has been elected a member of the Society.

ASTRONOMICAL PHENOMENA FOR THE WEEK 1887 FEBRUARY 27—MARCH 5

(FOR the reckoning of time the civil day, commencing at Greenwich mean midnight, counting the hours on to 24, is here employed.)

At Greenwich on February 27

Sun rises, 6h. 52m.; souths, 12h. 12m. 56'os.; sets, 17h. 34m.; decl. on meridian, 8° 21' S.; Sidereal Time at Sunset, 4h. 3m.

Moon (at First Quarter March 3) rises, 8h. 50m.; souths, 15h. 30m.; sets, 22h. 21m.; decl. on meridian, 7° 9' N.

Planet	Rises	Souths	Sets	Decl. on meridian
	h. m.	h. m.	h. m.	
Mercury ...	7 17 ...	13 13 ...	19 9 ...	1 36 S.
Venus ...	7 34 ...	13 31 ...	19 28 ...	1 23 S.
Mars ...	7 19 ...	13 1 ...	18 43 ...	4 11 S.
Jupiter ...	22 48* ...	3 49 ...	8 50 ...	12 8 S.
Saturn ...	12 30 ...	20 39 ...	4 48* ...	22 25 N.

* Indicates that the rising is that of the preceding evening and the setting that of the following morning.

Occultations of Stars by the Moon (visible at Greenwich)

March	Star	Mag.	Disap.	Reap.	Corresponding angles from vertex to right for inverted image
			h. m.	h. m.	
2 ...	Aldebaran ...	1 ...	17 47 ...	18 4 ...	182 210°
4 ...	130 Tauri ...	6 ...	2 30 ...	2 38 ...	43 25

March	h.	
3 ...	3 ...	Mercury at least distance from the Sun.
5 ...	11 ...	Mercury at greatest elongation from the Sun, 18' east.
5 ...	14 ...	Saturn in conjunction with and 3° 29' north of the Moon.

Variable Stars

Star	R.A.	Decl.	h. m.
	h. m.		
U Cephei ...	0 52.3 ...	81 16 N. ...	Mar. 2, 19 57 m
Algol ...	3 0.8 ...	40 31 N. ...	Feb. 28, 2 54 m
			Mar. 2, 23 43 m
U Monocerotis ...	7 25.4 ...	9 33 S. ...	Feb. 28, m
T Canis Minoris ...	7 27.7 ...	11 59 N. ...	,, 28, M
S Cancri ...	8 37.5 ...	19 26 N. ...	Mar. 2, 23 26 m
R Leonis ...	9 41.5 ...	11 57 N. ...	,, 2, m
U Virginis ...	12 45.4 ...	6 10 N. ...	,, 5, m
W Virginis ...	13 20.2 ...	2 48 S. ...	,, 4, 0 0 m
S Bootis ...	14 19.3 ...	54 20 N. ...	,, 2, M
δ Libræ ...	14 54.9 ...	8 4 S. ...	,, 3, 0 5 m
U Coronæ ...	15 13.6 ...	32 4 N. ...	Feb. 27, 21 2 m
U Ophiuchi ...	17 10.8 ...	1 20 N. ...	Mar. 3, 1 8 m
			and at intervals of 20 8
W Sagittarii ...	17 57.8 ...	29 35 S. ...	Mar. 3, 4 0 m
R Scuti ...	18 41.5 ...	5 50 S. ...	,, 3, M
β Lyræ ...	18 45.9 ...	33 14 N. ...	,, 5, 20 0 M
R Lyræ ...	18 51.9 ...	43 48 N. ...	Feb. 28, M
δ Cephei ...	22 25.0 ...	57 50 N. ...	Mar. 2, 23 0 M

M signifies maximum; m minimum.

Meteor-Showers

Amongst the meteor-showers of the season are the two following:—Near δ Virginis, R.A. 192°, Decl. 1° N; near ξ Sagittarii, R.A. 280°, Decl. 17° S. The latter radiant gives very swift streak-bearing meteors.

GEOGRAPHICAL NOTES

Two letters have been received in Vienna from Dr. O. Lenz, dated, one from Lake Tanganyika in September, and the other from the River Shiré in December. This indicates that the Austrian Expedition has taken an unexpected route to the east coast. When Lenz and his companions left Kasonge, on the Upper Congo, on June 30, they made for Tanganyika, arriving at Capt. Hore's station on the west shore on August 7. Crossing to Uji, Dr. Lenz found that it was impossible to proceed northwards to the Albert Nyanza and Emin Pasha, on account of the Arab raids and the state of things in Uganda. Instead, therefore, of proceeding eastwards to Zanzibar, he travelled, by land apparently, to the south end of Lake Tanganyika, along the Stevenson road to Lake Nyassa, down that lake to the Shiré, and thence by the Zambesi to Quillimane. The two letters will be published in the next number of the *Mitteilungen* of the Vienna Society, and will doubtless contain a good deal of information of interest.

TIPPOO TIP, about whom we have heard so much recently in connection with the Emin Pasha expedition, seems to be rather

an intelligent man, and even finds time in the midst of his ivory raids to attend to the interests of science. He recently came upon a remarkable tribe on the Congo, to the north of Nyangwé, who do a great deal of work in copper, and whose inlaid work in that metal is of a highly artistic character. He sent several specimens to an English friend at Zanzibar, who has brought them with him to this country. Still more interesting is the discovery by Tippoo, among the same people, of what may be regarded as the first steps towards a currency. Spears are naturally among the most valuable articles which such a people possess, and, as a matter of fact, the value of everything is reckoned by them in terms of spears. Not only so, but they have actually reached the stage of a conventional currency. Enormous spear-heads of very thin copper are made, some six feet in length, which are passed from hand to hand, just as bank-notes are with us. These spears, for example, in the purchase of ivory, are valued at £200—their intrinsic value being probably not so many pence. We are glad to know that a specimen is likely to be deposited in the British Museum. Readers of Schweinfurth's "Heart of Africa" will remember that among the Niam-Niams hoes are used for a similar purpose, only after a reverse fashion; tiny hoes, what we should call mere toys, are in common use as money.

The principal article in the new number of *Petermann's Mitteilungen* is a summary of the journey across Africa from Mossamedes to Quillimane, by the Portuguese travellers, MM. Capello and Ivens in 1884-85. The most valuable geographical work accomplished by the travellers was the exploration of the interesting region lying between the Upper Zambesi and Lake Bangweolo. The important north-east tributary of the Zambesi, the Kabompo, was traced to its source in the closest proximity to the sources of the Lualaba, one of the most important contributors to the Congo. From here a zigzag was made eastwards and southwards, across the head-waters of many affluents of the Zambesi, until that river was reached about 16° S. and 29° E. MM. Capello and Ivens took very numerous astronomical and meteorological observations during their journey, as well as observations for terrestrial magnetism. The complete narrative of the journey, with ample supply of maps and scientific appendixes, has just been published in Portuguese. The same number of the *Mitteilungen* contains a large collection of barometric data on the hypsometry of South America, mainly Peru and Bolivia.

PROF. L. BODIO sends to the *Bollettino* of the Italian Geographical Society for December 1886 an important paper on Italian emigration, which he divides into two categories—permanent and temporary. The latter, which is essentially of a periodical character, varies from 80,000 to 100,000 persons yearly, and consists chiefly of stonemasons, bricklayers, navvies, and other day-labourers from the northern provinces of Piedmont, Lombardy, and Venice, who seek casual employment on the public works in Austria, France, Germany, Switzerland, Corsica, and elsewhere. They generally leave their homes in the spring, returning with their earnings towards the close of autumn, and enjoy the reputation of sober, steady, intelligent workmen. The permanent movement, which alone constitutes emigration properly so called, has already risen during the last twenty years from less than 20,000 to about 80,000 annually, and is directed from the same northern provinces, and from Liguria and parts of Naples, almost exclusively to the Argentine States and some other parts of the New World. The emigrants, who sail either directly from Genoa, Naples, and Palermo, or from the French ports of Marseilles, Bordenaux, and Havre, comprise between 60 and 80 per cent. of male adults, the small minority consisting of women and children. They represent nearly all social conditions, the peasant class, however, largely predominating in South America. For the year 1885 the returns show 57,827 to the Argentine Republic; 15,485 to the United States; 12,311 to Brazil; and 1477 to Uruguay. The chief inducements to leave their native land and settle abroad appear to be poverty, the desire to better their fortunes, and the direct encouragement of friends and relatives who have prospered in their new homes across the Atlantic. Very few ever return to reside permanently in the mother country.

THE Germans are losing no time in making themselves acquainted with the section of New Guinea which they have annexed. The Empress Augusta River, close to the western boundary of the German territory, was recently navigated by Admiral von Schleinitz and Dr. Schrader, in the steamer *Ottlieb*, for a distance of 224 miles. It being the dry season, the river

was too shallow for further navigation by the steamer. The ship's steam-launch, however, proceeded 112 miles further, to a point situated in 4° 16' S. and 141° 50' E.; judging from the quantity of water in the river the voyage could have been continued 50 miles further, but fuel ran short. For over 200 miles from its mouth the river flows through extensive plains; then its course suddenly changes, and it assumes the character of a mountain stream, forcing its way through hills of gneiss, mica-slate, and quartz; but the velocity of its current remains uniform. The settlements on its banks were only found at long intervals.

ON THE CONSTITUTION OF THE NITROGENOUS ORGANIC MATTER OF SOILS

THE organic matter of soils, the residue of the limited oxidation of vegetable and animal matter, has appeared a subject so complex and obscure, and promising the investigator so little of definite result, that it has received but scanty attention. The researches made have been chiefly confined to a study of the non-nitrogenous humic acids, the nitrogenous organic bodies present in soil have been scarcely at all investigated. The agricultural chemist has indeed not unfrequently spoken and written as if such investigation was superfluous, holding that the nitrogenous organic bodies contained in humus were not capable of serving as food for farm crops until they had undergone a further change into ammonia, and finally into nitric acid. A valuable paper, "Sur les principes azotés de la terre végétale," by Berthelot and André, which appeared in the *Comptes rendus* of December 6, has called attention to this neglected subject, and has done much to clear up our ideas respecting the constitution of the nitrogenous organic matter contained in soils. Like many other epoch-making treatises, the paper in question brings forward facts which have, in part, been already established by earlier investigators; but in no earlier investigation, as far as I am aware, have the facts appeared in such a striking aspect, nor have the conclusions which flow from them been clearly set forth.

Berthelot and André conclude that the nitrogenous matter of soils is mainly composed of insoluble amides; these amides are decomposable by the action of acids, alkalis, and to a less extent by water, into ammonia and soluble amides (amido-acids), in the same manner as other bodies of the same class with which the chemist is already quite familiar. The behaviour of soil towards hydrochloric acid furnishes the main facts on which the French chemists base their conclusions. They find that when a soil tolerably rich in nitrogen (0.174 per cent.) is treated with dilute hydrochloric acid, a quantity of ammonia is found in the solution, which is greater as the strength of the acid is increased, as the time of its action is lengthened, and especially as the temperature is raised; two hours' boiling produces, in fact, with various strengths of acid, four, five, and six times as much ammonia as five days' action in the cold. Besides ammonia, there is found in the acid solution a considerable quantity of some nitrogenous organic body, the amount of which rises and falls with the quantity of the ammonia. In cases in which the action of the acid was carried farthest, the nitrogen of the soluble organic body bore to the nitrogen of the ammonia a proportion of about 3 to 1. The extent to which the nitrogenous matter of the soil was attacked by the hydrochloric acid was very considerable; boiling 200 grammes of soil for two hours with 400 cubic centimetres of water, and 100 cubic centimetres of strong hydrochloric acid, resulted in the solution of 31.8 per cent. of the soil nitrogen, and the conversion of 7.1 per cent. of it into ammonia. The nature of the nitrogenous organic matter found in solution in the hydrochloric acid has apparently not been particularly investigated by Berthelot and André, but the whole reaction is so characteristic of the splitting up of an amide that their view of the constitution of this body becomes highly probable.

Investigations earlier than those of Berthelot had shown that hydrochloric acid dissolves nitrogenous matter from the soil. Loges has pointed out that this solution contains a nitrogenous body precipitable by phospho-tungstic acid. The nitrogen and carbon in this precipitate had a relation of about 1 to 6.2. My own experiments show that a nitrogenous body precipitable by phospho-tungstic acid is also extracted from soil by a cold

1 The presence of amides in soil was long ago inferred by S. W. Johnson ("How Crops Feed," p. 247), from the reactions of soil with which chemists were then acquainted.

solution of potassium carbonate. We may hope that, before long, further light will be thrown on the constitution of these bodies.

The action of alkalis on soil is quite in accordance with the assumption of the amide nature of its nitrogenous compounds. Boussingault long ago showed that the agricultural operation of liming a soil caused the production of ammonia. It has recently been shown by Baumann, and others, that a solution of soda, even in the cold, develops a notable amount of ammonia in soil, while at a high temperature the action becomes very considerable.

Nor are facts wanting which seem to exhibit the actual synthesis of amides from ammonia and humic acids. Knop long ago observed that when peat was treated with ammonia the ammonia disappeared, and could no longer be detected. Joulie found, in his experiments on the changes which take place in farmyard manure, that when finely divided straw, horse-dung, and ammoniacal urine of known composition were mixed, and allowed to ferment, a great disappearance of ammonia took place, accompanied by a gain of 35 to 63 per cent. in the organic nitrogen. The ammonia had in this case clearly united with some of the organic compounds present.

The view of the constitution of the nitrogenous matter of the soil which has been now brought forward will, we think, prove fruitful: it throws much light on the chemical changes within the soil; it has also possibly important bearings on plant-nutrition. That the acid sap contained in roots is capable of rendering soluble, and thus effecting the assimilation of various mineral matters with which they come in contact, is admitted to be a fact by physiologists. May it not equally follow that the insoluble amides of the soil are also attacked by the acid root-sap? We know not yet the properties of the soluble amides which result from the action of acids on the insoluble amides of the soil; but if they are diffusible through a membrane, they must enter the plant, and it is certainly very probable that they would then be found capable of taking part in plant-nutrition. A reaction of the kind we have supposed between the root and the soil would probably take place to a very different extent with different plants, much depending on the character of the root-sap. When the subject has been more fully investigated, it may perhaps be found that we have in this action of the roots an explanation of those obscure cases of plant-nutrition which at present puzzle the agricultural chemist.

R. WARINGTON

UNIVERSITY AND EDUCATIONAL INTELLIGENCE

CAMBRIDGE.—The following is the speech delivered by the Public Orator, Dr. Sandys, in presenting for the honorary degree of Doctor of Science, Prof. Alexander Agassiz, Curator of the Museum of Zoology, Harvard College, Massachusetts:—

Cum Collegio Harvardiano antiquitus consociati, nuper vetera amicitiae iura auspiciis optimis renovavimus; litteris datis acceptisque trans maria lata dextras iunximus; legatis denique insignibus missis, ludis illis saecularibus, etiam absentes, velut praesentes interfuimus. Hodie vero e Collegii illius professoribus unum revera praesentem videmus, virum et suo et patris et Collegii sui nomine nobis dilectum. Donec Alpium inter culmina ingentes illae glaciae moles desuper paullatim descendunt, tam diu patris illius nomen superstes vivet, qui, in Republica non magna natus, Rempublicam maximam gloriae suae fecit participem, expertus scilicet vetera illa verba quam vera essent:—

“Omne solum forti patria est, ut piscibus aequor,
Ut volucris vacuo quicquid in orbe patet.”

Filii vero famam patre tanto non indignam, quibus potissimum verbis exsequi potero? Utinam tu mihi hodie adesses:—

O testudinis aegrea
Dulcem quae strépsum, Pieri, temperas;
O mutis quoque piscibus
Donatura cycni, si libeat, sonum.

Atqui Musa illa vocata non audit; rogata tacet; virumque praeconio altiore dignum sermone pedestri laudandum relinquit. Ergo, utcumque possumus, virum libenter laudamus, qui, cum ingenii sui ope aeris thesaurum ingentem invenisset, Academiam suam divitiarum suarum amplitudine ornavit, iudice me (insur-rare mihi videtur Horatius) iudice me, “non sordidus auctor naturae verique.” Quid autem de vivario illo dicam, aequoris Atlantici prope marginem ulteriore condito, ubi maris immensi

miracula minutissima ab hoc viro accuratissime examinantur, ubi oceani ipsius e penetralibus profundis rerum naturae veritas ipsa audacter extorquetur? Satis erit hodie de veritate illa dicere quod olim de Romanorum virtute dictum est:—

“Merses profundo; pulchrior evenit.”

Duco ad vos marinae praesertim zoologiae indagatorem indefessum, ALEXANDRUM AGASSIZ.

SCIENTIFIC SERIALS

THE *Quarterly Journal of Microscopical Science*, January.—The anatomy of the Madreporian coral *Fungia*, by G. C. Bourne (plates xxiii. to xxv.). During a visit to Diego Garcia (an atoll lying in 7° 13' S. lat., 72° 23' E. long.) which extended from the middle of September 1885 to the middle of January 1886, the author was able to collect and preserve a large number of specimens of *Fungia dentata*. These *Fungiae* were very abundant within the lagoon, where at low spring tides they could be collected by scores from depths of from three to ten feet: a prolonged search failed to secure any specimens under two inches in diameter, or an example of the nurse-stock. It is suggested that the time of the year was the cause of this; the depth of the water in which the search had to be made was also unfortunate for such investigations. The name “mesogloea,” suggested by Prof. Lankester, is used to denote the supporting lamina of Coelenterata: the only seeming objection to the name is that it is the name of a well-known genus of Algae.—On some points in the development of *Petromyzon fluviatilis*, by Arthur E. Shipley (plates xxvi. to xxix.). The material was obtained by fertilising the eggs of the ripe female Lampern, hatching the larvæ out, and rearing them in confinement. The summary is too long for abstracting, but it may be mentioned that the early development of the skeleton is described up to the stage where Prof. Parker commenced his researches.—The ammoniacal decomposition of urine, by Dr. W. R. Smith (plate xxx). Records a series of observations proving that the ammoniacal decomposition of urine is brought about by the presence of a Micrococcus which differs from that described by Prof. W. Leube, inasmuch as it liquefies gelatine. Though about twenty different organisms were isolated from one sample of healthy urine, only this one acted so.—Notes on Echinoderm morphology, No. 10; on the supposed presence of symbiotic Algae in *Antedon rosacea*, by P. Herbert Carpenter (plate xxx.). Discusses the views of Vogt and Yung as to the Sacculi of *Antedon* being symbiotic Algae, and considers these views as certainly not proven; an opinion which Perrier seems by intuition to have already ascribed to him.—The function of nettle-cells, by Dr. R. von Lendenfeld (plate xxx.). The plasmotic contractile coat of the endoblast is incited to action by the endocil: the animal can control this action.—Some new methods of using the aniline dyes for staining Bacteria, by E. H. Hankin. Illustrations of the structure and life-history of *Phytophthora infestans*, by Prof. H. Marshall Ward (plates xxxi. and xxxii.).—On the formation and liberation of the zoospores in the Saprolegniae, by Dr. Marcus M. Hartog.

THE *Journal of Botany* for January is chiefly occupied by a biographical notice of the late Dr. H. F. Hance, of Whampoa.—In the number for February, Dr. Richard Spruce describes and figures a Hepatica from Killarney new to science, to which he gives the name *Lejeunea Holtii*; Mr. Alfred Fryer continues his notes on the genus *Potamogeton*; and Mr. J. G. Baker commences a synopsis of the six genera *Sodiroa*, *Caraguata*, *Schlumbergeria*, *Guzmania*, *Catopsis*, and *Tillandsia*, which make up the tribe Tillandsiæ of the natural order Bromeliaceæ.

Bulletin de l'Académie Royale de Belgique, December 1886.—Determination of the parallax relative to the larger member of the double star Σ 1516 of Struve, by L. de Ball. From previous observations the chief star of this group appeared to have proper movement in a straight line independently of its companion, with which it had no physical connection. By means of a Coïnte refractor the author has followed the relative displacements of the two stars, and has determined a periodicity the effect of the relative parallax, which he finds to be

$$0''\cdot091 \pm 0''\cdot013,$$

and the distances

$$0''\cdot112 \pm 0''\cdot010.$$

From these elements he determines an absolute parallax $0''\cdot104$ with a mean error $0''\cdot008$, corresponding to a distance which

t would take 31 years to traverse.—Note on the transparency of latina mirrors, by Edm. Van Aubel. His further researches firm the author's previous conclusions regarding the false disparity of these mirrors, the light passing, not through the air itself, but through the interstices left between the particles deposited on the plates as prepared by Paul Lohmann, of Berlin. On the instability of equilibrium of the surface-layer of a liquid, second part, by G. Van der Mensbrugghe. The points dealt with are: (1) the existence of a surface-tension per to each liquid according to a given inner temperature; (2) the existence of a contractile or expansive force on the surface of a liquid in contact with a solid; (3) tension of a surface common to two liquids not intermingling.—On the energy of an atom of carbon, by Louis Henry. A method is proposed for determining the relative value of the four unities of chemical action.—On the physiology of the heart of the Neanderthal, by Léon Fredericq. The author explains the nature of the contraction of the ventricles, the idio-muscular contraction of the cardiac muscle, the nervous system of the heart, its isolated circulation, and the circulation in the pulmonary artery.—The Neanderthal or Canstadt race in Belgium, by MM. Traipont and Hest. The authors describe what appears to be the most important anthropological find ever made in Belgium. It consists of a more or less perfect human skeleton discovered by them in association with the remains of *Rhinoceros tichorinus*, *Elephas migentus*, the cave hyæna, and other extinct animals in the disturbed Lower Quaternary deposits of a limestone cave at Y, on the banks of the Orneau, in the province of Namur. The human remains, which came to light during the summer of 1879, present remarkable points of resemblance with those of the oldest yet discovered Palæolithic race, as represented by the Neanderthal and Canstadt skulls. The relationship is so close that the strikingly simian features of these skulls, hitherto regarded as possibly aberrant or pathological, would appear to be perfectly normal, and characteristic of the oldest known human inhabitants of Western and Central Europe. One of the skulls of the Spy men is decidedly platidolichocephalic (long and low), with a cephalic index 70; the other is sub-platidolichocephalic, with index 74.80. The frontal bone is also very low, narrow, and retreating, and the upper alveolar process highly prognathous, while the chin is but slightly developed, receding more widely than that of even the lowest Papuan type.

Engler's *Botanische Jahrbücher*, Achter Band, 1 Heft.—The latest botanical discoveries in the tombs of Egypt, by G. Schweinfurth. This article, with an appendix dated October 1866, contains an enumeration and description of vegetable remains found in tombs at Dra-Abu'n-Negga. Though the specimens were often in bad preservation, the author has been able to recognise some fifty species of plants from tombs dating from various periods, both very ancient and comparatively modern; among others the garlic (*Allium sativum*), which, like leeks and onions, is mentioned in Numbers, chap. xi.—In the next two articles by Alfredo Cogniaux and Dr. F. W. Klatt are descriptions of the Melastomaceæ, Cucurbitaceæ, and Compositæ collected by Lehmann in Guatemala, Costa Rica, and Columbia.—On the family of the Lactoridaceæ, by A. Engler. The genus *Lactoris* has been placed by various authors in the Magnoliaceæ, Dilleniaceæ, and Piperaceæ (Saururaceæ). On anatomical as well as other grounds the author rejects the affinity of the Saururaceæ and Dilleniaceæ, and concludes that *Lactoris* is to be regarded as representing a family (Lactoridaceæ) closely allied to the Magnoliaceæ.—On *Didymia*, a new genus of peraceæ, by Dr. R. A. Philippi (with one plate).—Contributions to the flora of the Congo district collected by Dr. Naumann on the expedition of H.M.S. *Gazelle*, prepared by A. Engler.—Then follow abstracts of papers published elsewhere.—At the conclusion of this number is a formal offer of prizes for monographs of the genera *Ranunculus* and *Draba*, and for a critical revision of the fossil forms of *Quercus*.

Achter Band, 2 Heft.—Dr. R. A. Philippi, on the Chilean species of *Polyachyrus*, a genus of Compositæ belonging exclusively to Chili and Peru. The author distinguishes the species according to the characters of the leaves, and illustrates his paper with a plate.—Hepaticæ Africanæ, by F. Stephani (one plate). This is a description of two collections of Hepaticæ: the one, made by F. A. Moller, from the Island of St. Thomas, consists of thirty-four species, of which twenty are new; the other, by J. Monkemeyer, about the mouth of the Niger, consists of six species, of which eight are new.—The Hepaticæ of the peninsula of Alaska, prepared by F. Stephani, comprise four new

species, three of which are figured on plate iii. The fourth (*Fruillania chilcootensis*) is extremely small, only a few millimetres in length, and is found hidden in the roughnesses in the bark of the birch.—Comparative anatomy of the leaf of the family Olacineæ, by E. Edelhoff. This is a laborious investigation of minute details of the anatomy of the leaf, the outcome of which is apparently no new view as to the grouping of the members of the family, but rather the recognition of microscopic diagnostic characters.—Dr. Gürich, on the botanical results of the expedition of Flegel to the Niger-Binué.—Note on a recently disclosed Pliocene flora in the neighbourhood of Frankfurt/a/M., by Dr. H. Th. Geayer.—Abstracts of papers published elsewhere.

Nuovo Giornale Botanico Italiano, January 1887.—Signor A. Piccone continues his observations on the part played by phytophagous fishes in the dissemination of Algæ. The fish which appears to be by far the most effective in this direction is *Box Salpa*, L.—Dr. F. Tassi contributes an elaborate paper on anæsthesia and poisoning in plants. Among the general conclusions at which the author has arrived, the more important are that there exists in certain plants a property analogous to that which in animals is variously denominated irritability, contractility, excitability, &c., but that this property is located in no special organ, but originates in the protoplasm. Some substances which produce anæsthetic or poisonous effects in animals are in no way injurious to plants.

Rendiconti della R. Accademia dei Lincei, December 1886.—Researches on the nature of malaria, carried out by Dr. Bernardo Schiavuzzi in Pola, Istria. The results of these experiments show the constant presence of a Bacillus, morphologically identical with that already described by Klebs and Tommasi-Crudeli, in the malarious districts of Pola, and its absence from the healthy localities. This Bacillus, artificially cultivated and inoculated on rabbits, develops fevers showing all the characteristics of swamp-fever, while in the infected animals the red corpuscles of the blood undergo the same alterations as Marchiafava and Celli have shown to be characteristic of malarious infection. These alterations, however, are attributed by Dr. Schiavuzzi, not to the presence of a parasitic animal which has never yet been detected either in the air or in the soil of the infected districts, but to a deterioration of the blood-corpuscles directly or indirectly caused by the action of a pathological ferment of quite a different nature. He accordingly concludes that the *Bacillus malarie* described by Klebs and Tommasi-Crudeli in 1879 is the true cause of marsh-fever.—On the objective spectroscope, by L. Respighi. The author claims the honour of having first introduced and applied to stellar spectroscopy the improved form of this instrument, as now generally used by spectroscopists. Although the important modification made by him is commonly attributed to Secchi, he shows conclusively that it had been adopted and successfully employed by him fully nine months before its application by Secchi in November 1869. An account of his first experiments with the perfected instrument appeared in the *Atti of the Academy* for May 20, 1869. The modification in question consists in replacing the large prism of Fraunhofer's instrument by one with a small refracting angle, by means of which may be obtained perfectly distinct and well-defined spectra of the smaller stars.

Rendiconti del Reale Istituto Lombardo, January 13.—Annual Report on the progress of the mathematical and natural sciences, presented by the Secretary, S. Ferrini. In this general survey of work done by members of the Istituto, special reference was made to E. G. Cantoni's memoir on the phenomenon of dew, showing that Aitken's observations have been confirmed by the results obtained in Italy by Fusinieri, Melloni, and Cantoni himself, in opposition to the generally admitted hypothesis of Wells; to C. Poloni's experimental researches on the permanent magnetism of steel at various temperatures, formulating the law of variations caused by changes of temperature, and on his new method for measuring the absolute thermic conductivity of metallic wires; and to Giacomo Cattaneo's studies on the formation of gastric and intestinal glands in the embryo of *Salmo salar*.

Rivista Scientifico-Industriale, January 15.—Electricity developed with the formation of fogs and clouds, by Prof. Luigi Palmieri. Some electric phenomena recently observed at the meteorological stations of Naples and Vesuvius are appealed to in confirmation of the author's view that strong electric tensions in clear skies constantly indicate the near approach of clouds

fogs, and even rain. Hence the strong tensions of atmospheric electricity so frequently signalled from the New York Observatory some days before the arrival of storms and wet weather on the west coast of Europe. During thirty-six years of constant study, the author has recorded thousands of similar observations, which have been overlooked by physicists dazzled by theories opposed to the natural conditions.—Further remarks on the question whether electricity is developed during the condensation of aqueous vapour, by Prof. Costantino Rovelli. In reply to the statements of Prof. Magrini, the author points out that, although his own experiments may have their weak side, the prolonged and repeated observations of Prof. Palmieri cannot be refuted by merely negative proofs.

SOCIETIES AND ACADEMIES

LONDON

Physical Society, February 12.—Annual General Meeting.—Prof. B. Stewart, F.R.S., President, in the chair.—In opening the proceedings the President regretted that in their Report the Council have to record the loss of one who took prominent part in the proceedings of the Society, the late Dr. Guthrie. It was, however, satisfactory to learn that the appeal of the Guthrie Memorial Committee, under the presidency of Prof. Huxley, had been generously responded to. The Council also learn with regret from Dr. E. Atkinson that owing to pressure of work he is unable to retain the office of Treasurer to the Society, and desire to express their thanks to him for his past services. Prof. Rücker has consented to be nominated for the office thus rendered vacant, and the Council believe that by his election the connection between the Society and the Normal School of Science (which is so desirable) will be maintained.—The Report of the Council for the year 1886 was read and received, and the following gentlemen were elected Members of the Council for the present year:—President: Dr. Balfour Stewart, F.R.S.; Vice-Presidents: Dr. E. Atkinson, Prof. W. E. Ayrton, F.R.S., Shelford Bidwell, F.R.S., Prof. H. McLeod, F.R.S.; Secretaries: Prof. A. W. Reinold, F.R.S., Walter Baily; Treasurer: Prof. A. W. Rücker, F.R.S.; Demonstrator: C. V. Boys; other Members of Council: R. H. M. Bosanquet, W. H. Coffin, Conrad W. Cooke, Prof. G. Forbes, Prof. F. Fuller, Prof. J. Perry, F.R.S., W. N. Shaw, Prof. S. P. Thompson, C. M. Whipple, C. R. Alder Wright, F.R.S.—The President proposed the following resolution: "That at the end of Clause 11 of the By-laws, which says, 'Every candidate for admission into the Society shall be recommended by not less than three members, to two of whom he must be personally known,' there be added, 'When a candidate living abroad is a member of a recognised scientific Society, such membership may, subject to the approval of the Council, be held equivalent to the personal knowledge aforesaid.'" The resolution was carried, subject to confirmation by a special general meeting to be held on February 26.—A vote of thanks, proposed by Prof. Ayrton and seconded by Prof. McLeod, to the Lords of the Committee of Council on Education, for the use of the rooms and apparatus of the Normal School of Science, was passed unanimously.—The Hon. R. Abercromby proposed a vote of thanks to the officers of the past year for their gratuitous services, which was seconded by Prof. Pickering.—Sir Philip Magnus proposed a vote of thanks to the auditors, Colonel Festing and Prof. Fuller, which was seconded by Mr. Lecky, and passed unanimously.—Mr. J. Brown was elected a Member of the Society.—The following communication was then read:—Note on the tenacity of spun glass, by E. Gibson and R. E. Gregory. The authors have experimented on the tenacity of glass rods and fibres made from the same piece of glass. The fibres varied from 1/25 to 1/50 mm. and the rods from about 1/4 to 1 mm. in diameter. They find the tenacity per square centimetre of rods increases as the diameter decreases, as in ordinary wires, whereas with fibres this is not shown. Experiments were shown illustrating the method of working, and the highest tenacity recorded was for a fibre of 0.340 mm. diameter, which gave 466×10^7 dynes per square centimetre, a value about half as great as that for steel wires. The authors refer to Quincke's suggestion that the increased tenacity of small wires is due to surface-tension, and may be represented by $W = Ad + Ed^2$, where W is the breaking weight and d the diameter, but their own results with glass do not agree with this formula. Sir Philip Magnus asked if the diameters were measured at the point of rupture, if the elongation was deter-

mined, and whether the authors were able to suggest any other formula which would express their results. Mr. C. V. Boys remarked that the tenacity being so much affected by accidental circumstances, such as rate of cooling, no such formula could be expected. Prof. Rücker, referring to Quincke's experiments, said that the surface-tensions of metals calculated from them appear improbable. After some further remarks by the President, Prof. Ayrton, Mr. C. V. Boys, Prof. McLeod, and Mr. Gregory, the proceedings terminated.

Royal Meteorological Society, February 16.—Mr. W. Ellis, President, in the chair.—The adjourned discussion on the Hon. R. Abercromby's paper on the identity of cloud forms all over the world, and on the general principles by which their indications must be read, was resumed; and the following papers were read:—Remarks concerning the nomenclature of clouds for ordinary use, by Prof. H. H. Hildebrandsson; and Suggestions for an international nomenclature of clouds, by the Hon. R. Abercromby. Both Prof. Hildebrandsson and Mr. Abercromby have paid great attention to the question of the forms of clouds, and having recently conferred together, they have agreed to recommend for international use the following ten principal varieties, viz.:—High-level clouds: cirrus, cirro-stratus, cirro-cumulus; middle-level: strato-cirrus, cumulo-cirrus; and low-level: cumulus, stratus, strato-cumulus, nimbus, cumulo-nimbus.—The influence of weather on the proportion of carbonic acid in the air of plains and mountains, by Dr. W. Marcet, F.R.S., and M. A. Landriset. The authors give an account of some experiments which they have made on the proportion of carbonic acid in the air at Geneva and on the summit of the "Dole," the highest point of the Jura chain, the difference in altitude being 4193 feet. The results of these experiments show: (1) that in fine clear weather on a mountain chain of moderate Alpine altitude, and in the adjoining valley or plain, the atmosphere holds the same mean proportion of carbonic acid at both places; and (2) that when the summit of a mountain chain is in a fog, a circumstance which frequently happens in an Alpine district, the air in the fog contains a smaller proportion of carbonic acid than it would hold in fine clear weather.—The Secretary, Dr. Tripe, read a letter received from Sir F. Abel, Organising Secretary to the proposed Imperial Institute, inviting the Society to draw the attention of the Fellows to the undertaking, with the view of their contributing towards it. The President stated that copies of the letter and of the accompanying paper, explanatory of the scheme, would be forwarded to each Fellow.

Mathematical Society, February 10.—Sir James Cockle, F.R.S., President, in the chair.—The following communications were made:—On the equation of Riccati, by the President (Prof. Hart, Vice-President, taking the chair).—The orthocentroidal circle (i.e. the circle whose diameter is the join of the orthocentre and centroid), by R. Tucker.—On polygons inscribed in a quadric and circumscribed about two confocal quadrics, by R. A. Roberts.—On the binomial equation $x^n - 1 = 0$; quinquisection, by Prof. Tanner.—Symmetrical determinant-formulæ in elliptic functions, by L. J. Rogers.—Notes on curves, by H. M. Taylor.—Some generalisations of differential formulæ connected with the change of the independent variable in a differential expression, with application to a new class of reciprocants, by C. Leudesdorf.

Geological Society, February 9.—Prof. J. W. Judd, F.R.S., President, in the chair.—The following communications were read:—Evidence of glacial action in the Carboniferous and Hawkesbury series, New South Wales, by T. W. Edgworth David.—The terraces of Rotomahana, New Zealand, by Josiah Martin.—The eruption of Mount Tarawera, by Capt. F. W. Hutton. The paper began with a description of the country in which the eruption took place. From Tongariro to White Island, in the Bay of Plenty, a distance of 130 miles, there extends a belt, 20 or 30 miles wide, abounding in solfataras, geysers, hot springs, &c., and composed of volcanic rocks, chiefly rhyolite, with some augite-andesite. About the middle of this belt lie the mountain and lake of Tarawera, and two or three miles further south Lake Rotomahana, the spot where the famous Pink and White Terraces existed. Before the recent eruption there were no craters on Mount Tarawera, the form of which was a ridge, apparently due to denudation. Having described the eruption, Capt. Hutton briefly noticed the results of the eruption in the form of fissures on Mount Tarawera, the change of Rotomahana from a lake to a crater of larger dimensions.

precipitous walls, the formation of a new lake between this crater and Tarawera, and the formation of a number of small craters about Okaro. The materials ejected were composed of andesite, rhyolites, both compact and vesicular. The mineral structure and distribution over the surrounding country of various forms of pumice, scoria, and ash were described, and it was shown that there was a difference in the substances ejected from the mountain craters of Tarawera and those from the craters in the plain at Rotomahana. At Okaro, the former comprising pumice and scoria, which are not thrown out from the latter, and but little steam issuing from the higher craters when compared with the enormous volumes emitted from the lower vents. The eruption ascribed to the reheating of old lava-streams saturated with water. This reheating was apparently not due to crushing—had it been so, the preceding earthquakes would have been more violent—but probably to molten rock coming up from below and heating the rocks near the surface. The eruptions at Rotomahana and Okaro were purely hydrothermal.

Chemical Society, February 3.—Dr. Hugo Müller, F.R.S., President, in the chair.—The following papers were read:—The oxidation of gases by carbon, by Charles J. Baker.—An examination of the laws which govern substitution in the case of benzoid compounds, by Henry E. Armstrong. Certain mono-derivatives of benzene, especially those containing a methylene radical, one of the halogens, hydroxyl or amidogen, and a mixture of the para- and ortho-di-derivatives in proportions which vary both according to the nature of the compound and with and of the reagent, and the conditions under which change is effected; and if produced at all, the meta-derivative is formed in but a small proportion. If, however, the chloride present in the mono-derivative be—

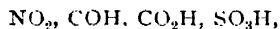

the meta-di-derivative appears invariably to be the chief product. Hitherto no explanation of this difference in the behaviour of the two series of mono-derivatives has even been suggested. In seeking to arrive at an explanation it is necessary to form a clear conception of the manner in which "substitution" is effected. The author is of opinion that in the first place an additive compound is formed; and he points out

Kekulé has long since insisted in the plainest terms on this interpretation of those cases of change which are commonly taken as "double decompositions." He is inclined to believe that the tendency of negative to attract and combine with positive elements—to which he has of late frequently directed attention—is the effective cause; and that the additive compound is formed from those mono-derivatives which obey "para-ortho law" by the fixation of the reacting molecule on the carbon-atom which carries the radical; separation of the ether or halogen hydride ensuing thereon, the radical of the reacting molecule assumes the place either of an ortho- or of a para-hydrogen atom. It is easy to understand the formation of the ortho-di-derivative, as the hydrogen-atom displaced is associated with a carbon-atom contiguous to that to which the reacting molecule attaches itself. The formation of the para-derivative is attributed by the author to the tendency towards isomerism, so frequently evidenced in cases of isomeric change in other ways by benzenoid compounds; and not to the existence of any direct connection between carbon-atoms relayed in the para-position. The formation of meta-derivatives is believed by the author to result from the addition of the reacting molecule, not to the carbon-atom of the benzene-ring, but to the radical which in the mono-derivative is attached to one of the carbon-atoms of the ring; he is, however, of opinion

in order to explain why the additive compound thus constituted yields a meta-di-derivative, it will be necessary to obtain further information regarding the "dynamics" of such changes.—Some derivatives of tetramethylene, by G. H. Perkins and Dr. W. H. Perkin, Jun.—Derivatives of pentamethylene, by Dr. W. H. Perkin, Jun.—The decomposition of potassium chlorate and perchlorate by heat, by Dr. Percy F. Frankland and John Dingwall.—The action of chlorine on cyanogen, by Dr. J. William James.

PARIS

Academy of Sciences, February 14.—M. Gosselin, President, in the chair.—On waterspouts and M. Ch. Weyher's recent researches, by M. Faye. While fully appreciating M. Faye's novel and interesting essays, the author makes certain

reservations, especially as regards the term *trombe marine* ("waterspout") applied by him to one of the results. This, he submits, was not a true waterspout, but only a rotatory movement of a volume of air without any defined limits, and with aspiration towards the axis of the ventilator. But a true waterspout is characterised by a cylindro-conical funnel sharply outlined, descending from the clouds to the ground or to the surface of the sea, without exercising on it any perceptible aspiration.—Note on MM. Paul and Prosper Henry's photograph of the nebula No. 1180 of Herschel's general catalogue, by M. Mouchez. During their photographic operations on Orion on January 27, MM. Henry obtained an image of a nebula of 3' to 4' diameter with stars of the 17th magnitude, invisible to the observer with the equatorial of the East Tower. This nebula, which has also since been photographed by Roberts in England, has now been identified with that discovered at the Cape by Herschel, and by him indicated with the number 1180 in his catalogue.—Reply to M. Houzeau's recent note on a method to determine the constant of aberration, by M. Lœwy. It is shown that M. Houzeau's method of determining the constant from the differences in right ascension or in declination as measured at different epochs, is liable to the most serious errors. In virtue of the diurnal movement, the two images are displaced in the field of the telescope at different rates of velocity and in any direction, their relative position changes from instant to instant, and under the given conditions cannot be accurately defined.—On a sandstone of organic origin discovered in the coal-fields of the Loire basin, by MM. Favarcq and Grand'Eury. Notwithstanding their chemical composition these remarkable deposits belong evidently to fresh-water organisms, which cannot at present be further identified. They abound especially in the Rive-de-Gier and Saint-Etienne districts.—The inauguration of railways in France: its true date, by M. Léon Aucoc. It is pointed out that the proposed celebration in 1887 of the fiftieth anniversary of this event rests on an historical error. The first line actually completed was that between Saint-Etienne and Andrezieux, 23 kilometres long, opened on October 1, 1828; that is, nine years before the assumed date 1837.—Remarks on the palaeontological researches made in the Lower Tertiary deposits in the neighbourhood of Rheims, by M. V. Lemoine. The author gives the general results of his investigations carried on uninterruptedly for the last fifteen years, and constituting the Rheims district one of the points where the beginning of Tertiary life may be best studied in Europe. The fossil vertebrates alone studied by him now number 94, of which not more than 8 or 10 were previously known. Amongst them are 40 mammals belonging to 23 different genera, of which 8 only had hitherto been observed in later Tertiary beds.—On the mode of formation of the striated Bilobites, by M. Ed. Bureau. The author has obtained plaster casts of most of these Bilobites, from a careful study of which he concludes that they must represent imprints of animals on the sands of shallow Silurian waters.—Combined action of belladonna and opium in a case of acute diabetes, by M. Villemain. After the usual remedies had failed, this treatment was lately tried in an extreme case of diabetes at the Val-de-Grâce Hospital, with complete success.—Determination of the position of the shaft corresponding to a given position of the piston in a steam-engine, by M. H. Leauté. Two remarkably simple graphic constructions designed in 1869 by M. Marcel Deprez are described, by means of which the position of the shaft for each position of the piston may be determined with sufficient accuracy, when the length-ratio of connecting-rod and shaft is greater than 3.—On the application of photography to M. Lœwy's new methods of determining the elements of refraction and aberration, by M. Ch. Trépiéd. An inquiry is here made into the conditions and means by which M. Lœwy's new and effective method of photographic registration might be utilised in determining the elements of astronomic refraction.—Observations of Barnard's and Brooks's comets made with the 0.38 m. equatorial, Bordeaux Observatory, by MM. G. Rayet and Courty.—On surfaces where the difference of the chief radii of curvature is constant at each point, by M. R. Lipschitz.—On a certain class of recurrent sequences, by M. Maurice d'Ocagne.—On the specific heats of liquids, by M. Marcellin Langlois. By the process here described the author determines the specific heats of water, sulphuret of carbon, chloroform, chloride of carbon, ether, alcohol, and acetone.—Researches on the specific inducting power of liquids, by M. Negreano. The author determines the dielectric constants of a series of homologous and liquid carburets of hydrogen for the purpose of

comparing the dielectric constants with the molecular weights and densities. He also determines the index of refraction of these different liquids with a view to the verification of Maxwell's law.—On the variable period of the current in an electro-magnetic system, by M. R. Arnoux.—Physical researches on the isomery of position, by M. Alb. Colson. Having succeeded in transforming orthoxylylene and metaxylylene into alcohols, glycols, ethers, &c., isomeric with the known compounds of paraxylene, the author here inquires whether bodies so closely related in their chemical properties may not also be connected by some physical relations. The best results have been obtained by the calorimetric process.—Action of the oxide of mercury on some dissolved chlorides, by M. G. André. In this preliminary paper the author deals with the chlorides of barium, calcium, strontium, and magnesium.—On the action of hydrochloric acid on the solubility of the chlorides, by M. R. Engel. His further studies enable the author to generalise the law already announced by him in the *Comptes rendus* for March 1886.—A new process of analysing the carbonic acid emitted, and the oxygen inhaled, in the act of breathing, by MM. M. Hanriot and Ch. Riche. The differential method here described as applicable, with some modifications, to the analysis of various gaseous mixtures, constitutes a simple and rigorous method for the quantitative analysis of those of respiration.—The formic salts, by MM. Gréhan and Quinquaud. The authors here discuss the question as to what becomes of the formic salts introduced into the system, and find that the formate of soda injected into the digestive organs or into the blood mostly passes unchanged into the urine.—On the properties of colchicine, by MM. A. Mairet and Combemale. Their experiments on dogs and cats satisfy the authors that this substance is an irritant poison which attacks all the organs, but especially the digestive tube and the region of the kidneys.—On the effects of the transfusion of blood into the head of decapitated animals and men, by M. J. V. Laborde. The author refers to his numerous experiments on this subject, which were overlooked in the paper recently presented to the Academy by MM. Hayem and Barrier.—On the comparative morphology of the brain in insects and crustaceans, by M. H. Viallanes.—The males of *Lecanium hesperianum* and the question of parthenogenesis, by M. R. Moniez.—On the zoological researches carried out during the second scientific expedition of the *Hirondelle*, in 1886, by Prince Albert of Monaco.

BERLIN

Physical Society. January 7.—Prof. von Helmholtz in the chair.—Dr. R. von Helmholtz developed theoretically the formulæ expressing the relations subsisting between vapour-pressure, the melting-point, pressure, and volume, and enabling the vapour-pressures in the fluid and solid state, or the freezing-points and the change of the melting-point with that of the pressure, to be calculated.—Dr. Thiesen, while engaged in working experiments instituted by Schellbach respecting the resistance of air, had found an expression for the force of resistance in accordance with which a medium with less interior friction must necessarily offer a greater resistance than did a medium with more friction. This induced him to carry out experiments of his own with cylindrical rods regarding the resistance of air. On a hardened steel point a brass cylinder open at the bottom and bearing at its lower end externally two conjoined pieces, into which the steel rods 1 metre long and 1 English inch thick could be inserted horizontally and diametrically opposite to one another, was able to rotate. By means of a cord circulation, the cylinder was set rotating, and the abatement of speed consequent on the resistance of the air was noted by each half-revolution being marked electrically. These experiments yielded the same formula for the resistance as had been obtained from the earlier experiments. Another important result was that the method employed for the measurement of the resistance of air had maintained its validity remarkably well. In the discussion following this address, Prof. von Helmholtz took part. He called attention to the formation of whirling surfaces and whirls on the rotating bodies, a matter which in a high degree complicated the phenomenon.—Dr. Thiesen made a further communication respecting the determination of the national standard kilogramme. The cylinders of platinum-iridium, weighing rather more than 1 kilogramme, which were cast in London, were tested in respect of their density, and so often as fissures were detected they were re-cast. They were thereafter polished and again tested. Forty-two such standards were next compared with one another, and their uniformity and non-liability

to be affected by transport having been ascertained, they had then to be compared with the kilogramme of the Archives, and after examination by the International Commission were despatched to the different Governments.

BOOKS AND PAMPHLETS RECEIVED

Histoire des Sciences Mathématiques et Physiques, vol. x.: M. Ma (Gauthier-Villars, Paris).—Proceedings of the Linnean Society of New South Wales, and series, vol. 4, part 3 (Cunninghame, Sydney).—Nomenclature Color for Naturalists: R. Ridgway (Little, Brown, and Co.).—Bulletin the Philosophical Society of Washington, vol. ix. (Washington).—Hour Readings, 1884, part 2, April to June (Eyre and Spottiswoode).—The Origin of the Fittest: E. D. Cope (Macmillan).—Geographical and Geological Distribution of Animals: A. Heilprin (K. Paul).—Hints for the Solution Problems of Solid Geometry: P. Frost (Macmillan).—Levelling and General Application: T. Holloway (Spon).—Observations Météorologiques de Godthaab: A. F. W. Paulsen (Gad, Copenhagen).—*Challenger* Expedition Reports—Zoology, vol. xvii.; Botany, vol. ii.—Philosophische Studie Vierter Band, 1. Heft (Engelmann, Leipzig).—Encyclopædie der Naturwissenschaften, Erste Abth., 50. Lief.; Zweite Abth., 39, 40, 41. Lu (Trewendt, Breslau).—City Government of Boston, Mass.: J. M. Hugh (Baltimore).—Annual Address to the Asiatic Society, Calcutta, February 1887: E. T. Atkinson.—Halifax, Annual Report of Public Library Committee, 1885-86.—Beiblätter zu den Annalen der Physik und Chemie, Band x (Barth, Leipzig).

CONTENTS

PAGE

The Owens College	38
Anderson on Heat and Work	38
A Field Naturalist in Eastern Bengal	38
The Measure of the Metre	38
Our Book Shelf:—	
De Quatrefages: "Histoire Générale des Races Humaines"	38
Schlemmüller: "Grundzüge einer Theorie der kosmischen Atmosphären mit Berücksichtigung der irdischen Atmosphäre"	38
Wall: "Manual of Physical Geography of Australia"	38
"An Intermediate Physical and Descriptive Geography"	38
Letters to the Editor:—	
Mr. Wallace on Physiological Selection.—Dr. George J. Romanes, F.R.S.	39
The Alleged Ancient Red Colour of Sirius.—F.R.S.	39
A Green Light at Sunset.—R. T. Omond	39
Sunset Phenomenon.—Dr. Wentworth Erck	39
Aspects of Clouds.—Robert James Reilly	39
A Recently-Discovered Deposit of Celestine.—H. G. Madan	39
"Culminating Sauropsida."—Prof. John Cleland	39
The West Indian Seal (<i>Monachus tropicalis</i>).—Henry A. Ward	39
An Abnormal <i>Hirudo medicinalis</i> .—R. J. Harvey Gibson	39
Instinctive Action.—D. W. C.	39
The Relations between Geology and the Mineralogical Sciences, I. By Prof. John W. Judd, F.R.S.	39
Tabasheer. By W. T. Thiselton Dyer, C.M.G., F.R.S.	39
On the Earlier Tripos of the University of Cambridge. By Sir G. B. Airy, F.R.S.	39
Notes	39
Our Astronomical Column:—	
The Binary Star δ Equulei	40
The Temple Observatory	40
Discovery of a New Comet, 1887 d (Barnard 2)	40
Probable New Variable	40
Names of Minor Planets	40
Brightness and Mass of Binary Stars	40
The Liverpool Astronomical Society	40
Astronomical Phenomena for the Week 1887	
February 27—March 5	40
Geographical Notes	40
On the Constitution of the Nitrogenous Organic Matter of Soils. By R. Warington, F.R.S.	40
University and Educational Intelligence	40
Scientific Serials	40
Societies and Academies	40
Books and Pamphlets Received	40

THURSDAY, MARCH 3, 1887

ENDOWMENT OF MEDICAL RESEARCH

OUR readers will probably have seen that a memorial, signed by some of the most able and trusted leaders in science and in medicine, has been presented to the Council of the Royal College of Surgeons, asking it to consider the propriety of establishing a new institution for the prosecution of such branches of science as are most closely connected with the objects of the College. There is no doubt that the memorial will be carefully and maturely considered in a spirit worthy of the eminent men who guide the policy of the College, but it seems fitting that in these columns the excellence of the suggestion should be acknowledged, whatever may be found to be the best method of meeting it.

In the first place, all who care for English biology and English surgery can heartily rejoice that the College which has done so much for both is now in a position not only of dignity but of affluence. Just before the foundation of the present College, the Company of Surgeons which preceded it was almost bankrupt, and, by want of observing a legal formality, well nigh forfeited its charter. But for fifty years past the College has grown in honour and in wealth. Its Membership stands deservedly first among the surgical diplomas which admit to practice. Its Fellowship involves higher training and more thorough examination than most University degrees. It possesses the second Medical Library in the kingdom, and the most complete, extensive, and well-arranged Museum of Anatomy—human, comparative, and pathological—which exists in the world. The original Hunterian Collection which was purchased by the nation after the death of the great anatomist, was intrusted to the care of the College of Surgeons on condition of providing a suitable building, and a competent Curator. The trust has been nobly dealt with. The museum left by Hunter, still cherished with reverence and still remarkable in varied aspects, has been many times multiplied by successive additions. Buildings of great size and admirable design have again and again been added. Curators have been appointed who have made their names familiar through Europe—Clift, Quekett, Owen, and Flower. And Hunterian Professors and Lecturers have been appointed who have made the Museum as well known as that of the Jardin des Plantes—Sir Everard Home and Sir Richard Owen, Huxley, Flower, and Parker, among anatomists; and, among surgeons, Abernethy, Cline, Astley Cooper, Laurence, Hilton, Fergusson, and Paget. Far from reserving its theatre for the veterans only, the College has shown a laudable liberality in founding Junior Lectureships; and now some of the most industrious, thoughtful, and brilliant of the younger generation of anatomists and pathologists are describing their new investigations from the Chair of the Hunterian Museum.

Now, however, there seems to be a probability of the College making another and an enduring addition to the benefits which it has conferred on science.

A large bequest has enabled them seriously to consider the foundation of such an institution as is suggested in

to save is stronger than the impulse to spend; and even if it is determined to spend the Wilson bequest, part at least might be safely applied to further extension and improvement of the Museum, fresh buildings, and an increased staff of officials. Still we hope that it may be found possible to meet such current needs by current income, and that the large sum placed at the free disposal of the College will be devoted to some new, useful, and appropriate scientific purpose.

The appropriate purpose is not far to seek. A museum is necessary for the study of anatomy, the one half of the science of living creatures; but for the prosecution of the other half, for the study of physiology, a laboratory is needful, where the physical, chemical, and vital phenomena of man and animals can be observed. Hunter himself was never content with the mere demonstration of a fact in living structures, normal or diseased. His acute and fertile intellect at once inquired: How came it about? What is its use? Of what process is it the evidence? How can that process be either checked or fostered for the relief of suffering and preservation of life?

The progress of knowledge since Hunter's day has vastly increased our power of dealing with these questions: many have been already more or less perfectly answered; more are ripe for solution to anyone who can give time and pains to the work; and most lie still untouched, a rich and virgin field ready to reward the man of thought as well as skill. But the methods of research have become more and more elaborate. The easy things have been done; or rather what was once hard has now become easy, and what once was impossible is now practicable, with greater expenditure of time and money. The change is only what has taken place in navigation, in war, and in engineering. Few scientific investigations can now be carried on except in properly equipped laboratories.

There are many departments in which work is urgently needed, and in which our own country is discreditably behindhand. In Germany and France and America, even in smaller countries like Holland and Sweden, adequate, or something like adequate, provision is made for the investigations of which we speak. Edinburgh has made great strides of late years, and there the University laboratories of physiology and pharmacology are worthy of the place. Cambridge has, since Prof. Foster was called to the University, been known through Europe for the first time as a great school of physiology. Oxford has lately built and furnished a laboratory for Prof. Sanderson. But London is still far behind the three chief Universities of the kingdom, and behind Paris and Lyons, Strassburg, Berlin, Leipzig, Bonn, and a host of petty towns in Germany.

It is true that before he was carried away to Oxford Dr. Burdon Sanderson had established a laboratory at University College which is a credit to London, and where work of the best kind has been and is being done. At King's College, though the accommodation is not what it should be, Prof. Gerald Yeo and his assistants put forth no less excellent results. In two at least of the great medical schools physiological laboratories have long existed, and have contributed to the progress of knowledge as well as to instruction. Lastly, the situa-

or three of its medical graduates on the Senate, founded an institute for the study of comparative pathology which, under Sanderson, Klein, Greenfield, Roy, and Horsley, has accomplished results of great benefit both to domestic animals and to man.

If, however, physiology and pathology are to some extent provided with means for research, others of the sciences allied to medicine and surgery are absolutely destitute. Physiological chemistry has scarcely existed in England since the days of Prout, and at the present day there is not a single laboratory where this difficult and important branch of knowledge is pursued. When Dr. Gaanec's excellent text-book is completed, the *Index Auctorum* will scarcely contain an English name.

Pharmacology—the experimental investigation into the action of drugs—is another foreign science. Fraser and Brunton have done much to redeem this country from absolute sterility, but in London there ought to be a laboratory like that of Prof. Schmiedeberg for this most obviously and practically useful of all medical sciences.

A laboratory for the study of Physiology would be the most closely connected with the memory of Hunter, with the Museum, and with the traditions of the College. A laboratory of physiological, pathological, or therapeutical chemistry would perhaps fill the most absolutely vacant space. A laboratory devoted to the direct study of the nature, origin, and propagation of Diseases, to their prevention, and to surgical methods of treatment would be the most directly useful and probably the most immediately fruitful.

So much is needful before England can begin to contribute her fair share to the common sum of knowledge, that it is scarcely possible to go far wrong in deciding what branch of medical science should first be taken up.

The Royal College of Surgeons has a great opportunity, and one that is not likely to return. If the great accession to its resources should be frittered away on a multitude of objects, the opportunity will be missed, and probably for ever. But we cannot doubt that the leading scientific surgeons in the kingdom will decide on using the Wilson bequest for the endowment of some new and urgently needed institution for research, which will be an honour to the College, a credit to the nation, and an instrument for increasing knowledge and diminishing suffering for centuries to come.

THE ELECTRIC MOTOR

The Electric Motor and its Applications. By T. C. Martin and Jos. Wetzler. (New York: Johnson, 1887.)

CONSIDERING the very rapid strides that have been made during the past six years in the industrial application of electric motors, the appearance of this handsome volume, giving the latest information on this topic, is thoroughly timely. It constitutes, though somewhat popular in style, a welcome addition to the library of the electrical engineer. Those who are accustomed only to the slow and steady development of industries in the Old World can hardly appreciate the revolution that is setting in in consequence of the employment, especially in small workshops and factories, of electric motors in place of steam-engines or gas-engines. They win their

that of the steam-engine or gas-engine. It is less troublesome to keep in order, takes less room, runs at a more uniform speed, and is more cleanly. What wonder, then, that thousands—literally—of electric motors are already in use in New England, where an invention is welcomed not sneered at, because it is new.

Much of the volume before us has already seen the light in another form in the pages of our American contemporary, the *Electrical World*, but the matter has been very carefully edited and arranged. It is by no means a scissors-and-paste affair; but a well-considered treatise abundantly illustrated with drawings of motors and of their various applications. It treats the subject both historically and systematically.

The first chapter is devoted to an exposition of the elementary principles of electric motors. Almost at once we are plunged into the essence of the matter, the development in the armature of the motor of the counter electromotive force, that *crux* of the untrained electrician. In this connection Jacobi's law, that the electric motor does its greatest possible work when it diminishes the original current to one-half, is given, and correctly given not as a law of maximum efficiency, for which it has been so often mistaken, but as a law of maximum activity. But the authors have missed the point that Jacobi's law even in this sense is only true when the condition of supply of the electric energy is that of a given constant electromotive force. Jacobi's law would obviously not apply to motors placed in a circuit in which the given condition of supply was that of a constant current. The chapter concludes with some very apposite remarks on the general principles of construction of electric motors, quoted from a paper in the *Philosophical Magazine* by an English electrician, Mr. W. Mordey.

Chapter II. is devoted to early motors and experiments in Europe, from Barlow's wheel and the primitive engines of Jacobi and Froment down to the famous Pacinotti machine. The complement to this narrative is found in Chapter III., which deals with the early motor and experiments in America, beginning with Davenport in 1837. The most celebrated of these was that of Prof. C. G. Page, who succeeded in constructing a motor of 10 horse-power. The authors incidentally mention that, in the period of the Civil War, between 1860 and 1867 not a single patent on electric motors was issued in America.

Chapter IV. deals with the electric transmission of power, as developed successively by Pacinotti, Fontaine, and Marcel Deprez. In this connection the theory of the efficiency of electric transmission is explained by the use of graphic diagrams in which the areas are proportional to the energy transmitted or to the work performed. The experiments of Marcel Deprez are mildly criticised, and the rules for calculating the cost are given.

The modern electric railway and tramway in Europe occupy Chapter V. Here several of Siemens's tramways are described, also those at the Giant's Causeway, Brighton, and at Blackpool. Chapter VI. gives a similar account of the modern electric railway and street-car line in America. From this account it appears that Mr. Stephen D. Field is in America awarded the sole right to use "the combination of an electric motor operated by means of a current from a stationary source of electricity" which "combines

locomotives of Field, Edison, Daft, and others, are given. Several electric railroads of some magnitude are at work in the States. Chapter VII. resumes the subject of street railways in which storage batteries are employed for driving the electric motors. The work done in this country by Mr. Reckenzaun receives due recognition, and Mr. Elieson's tramway engine is also described. The industrial application of electric motors in Europe and in America occupies the next two chapters, the special form of motors devised by Profs. Ayrton and Perry being noticed in the one and those of Griscom and Daft in the other. Electrically-propelled boats and balloons are treated by themselves; so also is the subject of telephage. This subject—the transmission of freight along a wire road by electricity—originated with the late Prof. Fleeming Jenkin, and it has found imitators in America. The twelfth and last chapter is devoted to the latest American motors and motor systems, the motors of Brush, Sprague, Van de Poole, and others, being here described at length.

And here we must pause to point out the one blot on this otherwise excellent work: namely, that the entire theory of the self-regulating motor, which was discovered and worked out in 1882 by Profs. Ayrton and Perry, and which forms the basis of their epoch-making paper read in 1883 before the Society of Telegraph-Engineers, is appropriated *en bloc*, and accredited to Lieut. Sprague. From p. 160 it appears that Sprague's method of securing self-regulation is to use a differential compound winding; but this is exactly Ayrton and Perry's method. Even the equation on p. 161, which is given as the Sprague law of winding, is identical with the equation given on p. 367 of the present writer's book (edition of 1884) on dynamo-electric machinery in the section on the theory of the differential compound winding. Another matter credited to Mr. Sprague by the authors is the discovery of a motor which, when supplied at constant potential, runs faster when the strength of the magnetic field is diminished. But this is no new principle: it is an inherent law of nature, common to all motors old and new, being the simple converse to the equally fundamental fact that a dynamo, if it is to generate a constant electromotive force, must be run faster in a weak field, and may be run slower if the field is strengthened. Lieut. Sprague has done good work in producing motors of excellent design and having points of original merit: this we may freely acknowledge without ascribing to him what was known before his work was begun. The authors will do well to correct these slips in the second edition, which will probably soon be demanded. The book is creditable alike to authors and publisher.

SILVANUS P. THOMPSON

THE FLORA OF LEICESTERSHIRE

The Flora of Leicestershire, including the Cryptogams. With Maps of the County. Issued by the Leicester Literary and Philosophical Society. 372 Pages and 2 Maps. (London and Edinburgh: Williams and Norgate, 1886.)

THE county of Leicestershire covers an area of 800 square miles of the centre of England, at the summit of drainage between three of the great streams, the

Trent, the Severn, and the Midland Ouse. Almost the whole of the county is at least 100 feet above sea-level. A large portion of the surface is between 300 and 500 feet, and Charnwood Forest rises at its highest point to 900 feet, so that Leicestershire is very different from such low-lying level Midland counties as Cambridgeshire, Bedfordshire, and Huntingdonshire. Half the area of the county is in grass, about one-quarter is under arable cultivation, and there are 20 square miles of woodlands. In Charnwood Forest there are slate and granite, and the sedimentary rocks are represented in the county from the middle of the Palæozoic to the middle of the Mesozoic series—Carboniferous Limestone, Coal-measures (Permian missed out), Trias, Lias, and Lower Oolite—so that there is every variety of soil.

Competent botanists have resided in the county for the last three generations. The fathers of Leicestershire botany are Dr. R. Pulteney, F.R.S., who was a surgeon at Leicester, and the author of "A General View of the Writings of Linnæus" (1781), and the well-known "Historical Sketches of the Progress of Botany in England up to the date of the general adoption of the Linnæan System" (1790); and the poet Crabbe, who lived at Belvoir from 1782 to 1813, when he removed to Wiltshire. Between 1820 and 1850 Leicestershire was the home of three clergymen, all of whom were enthusiastic botanists. The Rev. Andrew Bloxam lived at Twycross for more than forty years. He is best known as one of the special investigators of the British brambles, and partly, perhaps, because he worked them so thoroughly there is a general idea that Leicestershire is the richest county in England in forms of this complicated genus. He was one of the last survivors who kept up the old tradition of botany as it was in the days of Smith, Hooker, Turner, Dillwyn, and Forster, when a collector swept through the whole vegetable kingdom, from the flowering plants down to the fungi. The Rev. W. H. Coleman was a most energetic and capable botanist. He was for many years one of the masters of the Ashby-de-la-Zouch Grammar School, and it was he who laid the basis of the present work, dividing the county into a dozen districts, and tracing out the distribution of the plants through them as fully as he had opportunity. He died in 1864, and in 1875 his manuscript was handed over by his friend Mr. Edwin Brown, of Burton-on-Trent, to the Leicester Literary and Philosophical Society, which appointed a Committee to amplify and revise it. Of this Committee Mr. Mott, of Leicester, has acted as Chairman, and Mr. Carter, Dr. Finch, and Messrs. E. and C. Cooper are the other members. The other clergyman who worked in conjunction with Messrs. Bloxam and Coleman was the Rev. Churchill Babington, for many years the Disney Professor of Archaeology at Cambridge, and now Rector of Cockfield, in Suffolk. In 1850 Miss Mary Kirby (now Mrs. Gregg) published a small flora of the county, which contained a substantially complete list of the flowering plants and ferns of Leicestershire, but no attempt was made to trace out their distribution in detail.

In the present work the number of flowering plants and ferns, native and naturalised, in Britain is estimated at 1546, and of these, 825 are admitted for Leicestershire. This number of 1546 is reached only by counting the subspecies of such variable types as *Ranunculus aquatilis* and

Rubus fruticosus, and by including a large number of plants that have no claim to be considered as really wild, such as *Linaria Cymbalaria*, *Corydalis lutea*, and the wall-flower. Mr. Watson's estimate was 1425, and, as compared with this, the flora of Leicestershire will stand at a little over 700. He worked out carefully in detail the distribution over the island of all these species, and showed that they fall into, broadly speaking, three geographical or climatic groups: that 532 species are spread generally over the whole island; that 606 species represent southern climatic and geographical influences; and that 238 species represent the boreal element in our flora, and are plants that are thoroughly at home only in the north of Scotland, and are found in England and Wales only in mountainous tracts. In any county, or other tract of land, the great mass of the flora always consists of the 532 generally-diffused plants, and the climatic difference between one county and another is shown by the extent to which the characteristically northern and southern types are represented. It adds very much to the interest which any book on local botany has for the non-resident general reader, if the writers keep these three climatic groups distinct in their minds, and give as complete an idea as possible of the way in which, and the extent to which, the austral and boreal types are represented in the area of which they treat. The writers of the present "Flora" have not attempted to give any general summary worked out upon this basis, and they are quite mistaken in supposing that their county includes three out of Watson's six climatic zones. Watson's infer-agrarian zone includes the low-level country south of the Humber and the Dee. Its characteristic types are such plants as *Clematis Vitalba*, *Rubia peregrina*, *Geranium rotundifolium*, *Trifolium subterraneum*, *T. suffocatum*, *Lathyrus Nissolia* and *L. Aphaca*, and *Centaurea Calcitrapa*. Watson's mid-agrarian zone includes the low levels of the north of England, up to a height of 900 feet above sea-level on the mountains of Yorkshire and the Lake District. Its upper limit is marked by the cessation (essential from climatic causes, not accidental) of fruticose Rubi, *Rosa arvensis*, *Pyrus Malus*, *Viburnum Opulus*, and *Alnus glutinosa*. Above this, up to the line of possible arable cultivation, extends the super-agrarian zone, with an average annual temperature of 42° to 45° F. The only county south of the Humber and Trent in which it is represented is Derbyshire. There do not appear to be in Leicestershire more than ten or a dozen out of the 238 boreal plants, such as *Lycopodium Selago*, *Empetrum nigrum*, and *Drosera anglica*, and these are either very rare or quite extinct. There is no saxifrage except *granulata* or *tridactylites*, no wild bird-cherry, no *Andreea*, no *Polypodium Phegopteris* or *Dryopteris*. To understand their county and its flora in their proper relation to the rest of England, Mr. Mott and his colleagues must revise completely their ideas on this subject. The county would appear to be essentially a mid-agrarian outpost, pushed out from the Pennine Chain into the centre of England; for, out of the 600 austral types, not more than about 150 enter into it, which is fewer than there are either in North Yorkshire or at the Lakes. The limestone types, the occurrence of which is regulated more by soil than climate, appear to be well represented.

For the way in which the details of the flora are worked

out, we have nothing to give but commendation. In the identification of the Phanerogamia, great pains has evidently been taken by the Committee. No doubt some of the species, which they admit on the authority of their predecessors, will prove to be blunders, as, for instance, *Tofieldia palustris*, *Carduus heterophyllus*, and *Asplenium viride*. When the members of the county society make their excursions into the different districts, they will be able to see at a glance what plants have been gathered there by their predecessors. The flora includes, not only the Phanerogamia and ferns, but also the mosses, Hepaticæ, lichens, Algæ, and fungi. It is not likely that there are many fresh Phanerogamia or ferns still to find; but as only 4 Characæ, 179 mosses, 49 Hepaticæ, 177 lichens, and 446 fungi are known, there is ample scope for further work in all these orders. [The portion of the book devoted to Algæ, which is ably edited by Mr. F. Bates, of Leicester, contains descriptive notes on many of the less known species. There is an interesting note on p. 344, on the species which have become extinct. They are 30 in number, and are nearly all plants of swamps and heaths, amongst them being *Lycopodium Selago*, *Osmunda regalis*, *Pinguicula vulgaris*, *Drosera anglica*, and *D. rotundifolia*.

The book will be still more interesting when we have good floras of Warwickshire, Nottinghamshire, Derbyshire, and Cheshire to compare it with, and for all these counties "Floras" are in course of preparation.

J. G. BAKER

GEOLOGY OF JERSEY

Géologie de Jersey. Par Le P. Ch. Noury, S.J. (Paris: F. Savy; Jersey: Le Feuvre, 1886.)

CONSIDERING that Jersey became subject to the Crown of England at the time of the Norman Conquest, English geologists may agree with M. de Lapparent's complaint as to the neglect the island has hitherto received. Although the Geological Society of London made it their earliest care to publish in 1811 (not 1817, as quoted in the opening of this little volume) MacCulloch's paper on the Channel Isles, although at the present time more than one worker is engaged in further removing the reproach, M. Noury is even now well to the front in providing in a handy form an account of the structure of Jersey serviceable to inhabitants and visitors alike. The character of this well-printed *brochure* presupposes, however, some general knowledge of geology, and the author is perhaps not so uniformly happy as, let us say, the Rev. W. S. Symonds in placing his facts before the intelligence of the untrained tourist. Some controverted matters, moreover, of purely speculative value are introduced, such as the construction of the primitive crust (p. 126), the succession in time of granite, syenite, and diorite, and the formation from these of schists and gneisses by disintegration in a heated ocean. The description of the prevailing rocks is the work of a close observer in the field; and the careful mention of such materials as have been artificially introduced ("cultivated rocks," one might almost call them) cannot be too highly praised. Future geologists will thus be spared the description of gneissic fragments (p. 6) imported as ballast from Brazil.

The suggested derivation of "pyromeride" (p. 29)—

"*partagée dans le feu*"—is not historic, Haüy's and Monteiro's name referring to the different fusibilities of the two constituents of the spheroids. We doubt also the primary origin assigned to the chalcedony with which the hollows of these old rhyolites are so often filled. Here, as is so frequently the case among Continental writers, the immense importance of secondary changes appears to be overlooked. In one of these lavas M. Noury has found a spherulite measuring 18 inches in diameter. The "sphérolithes," however, of certain diabase veins (p. 41) would appear to correspond to the spheroidal structure of weathered basalt rather than to the contemporaneous volcanic bombs suggested by the author.

The account of the connection between open fissures and the decomposition of dykes, and of the origin of the numerous bays, as well as of the larger inland features, is full of interest to the visitor. In the review of the history of the island the discussion of recent elevation and depression is too lengthy to allow of justice being done to the evidence relied on for the ages assigned to the various types of rock—evidence derived solely from comparison with the mainland of France. The scanty preservation, moreover, of Secondary deposits in the Hebrides makes one cautious in accepting the conclusion (p. 139) that Jersey has remained above water since Permian times. M. de Lapparent has, indeed, recently stated that the final conglomerate may be of Triassic age.

The book is written in the lucid and attractive style that French men of science have taught us to expect. A coloured geological map forms a handsome and valuable addition.

G. C.

OUR BOOK SHELF

General Biology. By William T. Sedgwick, Ph.D., and Edmund B. Wilson, Ph.D. Part I. Introductory. (New York: Henry Holt and Co., 1886.)

THIS work has been planned by the authors as an "introductory study" to biological science, after digesting which the learner may proceed to Huxley and Martin's "Practical Biology," Brooks's "Hand-book of Invertebrate Zoology," or to a second part of the present book, which is promised to be ready some time this year.

In the first four chapters of the introductory portion, Messrs. Sedgwick and Wilson deal with the generalities of biology—that is, with the nature and properties of protoplasm and the origin and modification of cellular tissues. In the remaining chapters they discuss at full length the two types selected to illustrate the two principal modifications of life. These are, the common brake (*Pteris*) and the earthworm (*Lumbricus*). The embryology and physiology of the selected types are as fully dealt with as the pure morphology. At the end of each chapter a scheme of practical work is given, which may in some cases be of much value.

On p. 123 it is stated that "all the organs of the body are originally developed from the walls of these chambers"—that is, the chambers of the body-cavity formed by the dissepiments. But it is a well-known fact that, as has been previously stated by the authors themselves (p. 152), the nerve-cords and ganglia are developed from the epiblast, or, as Messrs. Sedgwick and Wilson prefer to call it, the "ectoblast." Such being the case, it is obvious that the nerve-cords are not developed from the mesoblastic chambers.

Another and more serious error will be found on p. 143, where the *vesiculæ seminales* of the earthworm are described as the *testes*. It has been conclusively shown by Bloomfield that the large white bodies which fill up the tenth and eleventh somites of *Lumbricus* are really the *vesiculæ seminales*. The true *testes* are very small bodies, only present at certain periods of the year. There are two pairs of them, in the eleventh and twelfth somites. The *spermatozoa* are not fully matured in the *testes*, but pass into the *vesiculæ seminales* to complete their development.

Notwithstanding these few errors, Messrs. Sedgwick and Wilson's introductory essay is well adapted for the use of junior students in biology. Moreover, it is adequately illustrated by well-drawn woodcuts, far exceeding in clearness of execution the average of those found in American text-books.

LETTERS TO THE EDITOR

[The Editor does not hold himself responsible for opinions expressed by his correspondents. Neither can he undertake to return, or to correspond with the writers of, rejected manuscripts. No notice is taken of anonymous communications.]

[The Editor urgently requests correspondents to keep their letters as short as possible. The pressure on his space is so great that it is impossible otherwise to insure the appearance even of communications containing interesting and novel facts.]

Industrial Studentships

I AM directed to request that you will be so good as to allow me, through the medium of your columns, to inform manufacturers and others engaged in industries in which art is more or less concerned, that the Lords of the Committee of Council on Education have decided to make arrangements for the admission of a limited number of persons employed in those industries to study in the South Kensington Museum, Library, and Schools, without the payment of any fees, for periods of from two to nine months according to circumstances.

Detailed rules with regard to these working studentships will be sent on application to the Department. Briefly, the conditions may be stated to be that the designer or workman for whom admission is sought shall show that he has sufficient power of drawing and sketching to be able to profit by the opportunities afforded; that he is actually engaged in some art industry; and that the proprietors of the works in which he is engaged undertake to maintain him while he is studying at South Kensington. When admitted, the working student will be set, under direction, to study in the Museum and Art Library from examples relating to the industry in which he is employed, and he will also receive instruction in drawing and designing in the Art School, suited as far as may be to his special case.

My Lords have taken this step with a view to render the Museum of more special and direct use to the country, and they trust that the valuable collection of examples of applied art which has now been brought together may thus be more fully appreciated and taken advantage of by the directors of industry in the country.

J. F. D. DONNELLY

Science and Art Department, February 28

Top-shaped Hailstones

IN connection with the abnormal fall of rain which is taking place this cold weather in the North-West Provinces of India, and which has clothed the outer ranges of the Himalaya with snow down to the 5000-foot level, I should like to mention a fall of hailstones which occurred on January 21 near Ramnagar, in the Terai. The hailstones were not very remarkable for size, being generally one-third of an inch across, with here and there a larger one half an inch in diameter. Some peculiarities of shape and structure, however, arrested my attention. Nearly every one that was not deformed by collision was top- or pear-shaped. Owing to their rebounding from the ground, it was impossible to see whether the broad or pointed end fell foremost; but in every case the broad end was composed of perfectly hyaline, amorphous ice, whilst the pointed end was banded crosswise by alternate layers of clear and white ice. In every case this distinction was perfectly well marked.

In some few instances I found hailstones of another, but pro-

bably derived form. Instead of being circular in section at right angles to the long axis, they were triangular, so that they bore a strong resemblance to the kernels of a beech nut. The



broad end in this case also was perfectly transparent, and the sharper end banded as before.

I append three diagrams representing typical forms.
Ramnagar, Terai, January 25 C. S. MIDDLEMISS

Snowflakes

IN your issue of January 20 (p. 271) is an interesting sketch of the snowstorm of January 7, 1887, with mention of snowflakes $3\frac{1}{2}$ inches long. Without vouching for the exact details I send you some statements from a letter in the *New York World* of today's issue. The letter is dated Fort Keogh, Montana, U.S., February 13. "The winter of 1886-87 will be long remembered throughout the north-west for the extreme severity of the temperature and the unusual depth of snow. From January 6 to 11 the degree of cold was something frightful. Mercury thermometers were often congealed, and spirit thermometers were kept jumping from 40° to 60° below zero. Half a dozen times has the 60° notch been touched, and once this season $62\frac{1}{2}^{\circ}$ below zero has been scored on the Saskatchewan plains. But the authorities in weather in this country are the Indians. The oldest members of the Crow tribe say there have been few such winters as the present since they settled in the Yellowstone Valley. Curious phenomena sometimes attend a snowstorm. Near Matt Coleman's ranch on January 28 the flakes were tremendous, some were larger than milk-pans. Some flakes measured 15 inches square and 8 inches thick. For miles the ground was covered with such bunches, and they made a remarkable spectacle while falling. A mail-carrier was caught in the same storm and verifies it." The narrative is one of great suffering, and loss of human lives and cattle. "Miss Maggie Bunn, school-teacher at Highmore, while going from the school to her house was frozen to death. The bodies of three Indians who belonged to Berthold Agency were found frozen near Ashland." And so on, in harrowing detail, for a number of whites perished. SAMUEL LOCKWOOD

Freehold, New Jersey, U.S.A., February 14

"Invisible at Greenwich"

I WRITE to note an apparent oversight which I have detected in the *Nautical Almanac* for 1888. The partial solar eclipse of August 7 is stated to be "invisible at Greenwich," but on applying a rigorous calculation I find that it will be visible there to a small extent, the times of contact being as follows:—

	G.M.T.		Angle from		Angle from	
	h.	m.	N. p.	N. p.	vertex	vertex
First contact ...	6	53	...	11° to E.	...	26° to W.
Greatest phase ...	7	3	...	013 (sun's diam. 1)	...	
Last contact ...	7	13	...	30° to E.	...	7° to W.

the angles being for the direct image.

I am aware that this is a very insignificant eclipse, but the greatest attainable accuracy is desirable in our national ephemeris, which, indeed, inserts eclipses much slighter than the above, e.g. the lunar eclipse of November 26, 1890, whose magnitude is only '002.

A. C. CROMMELIN

Trinity College, Cambridge, February 15

Lunar Halos

LAST evening (February 8), about a quarter-past eight o'clock (75th meridian time), I saw around the moon a series of coloured rings lying close together. The inner one was two or three diameters of the moon from the moon and red, the next was violet, then red, and finally violet again, this last one being very faint. From their proximity to the moon these rings seem to constitute the coronal, but I am puzzled by the fact that the inner ring was red. Do halos ever occur so close to the moon and without an interval between the two pairs of red and violet rings?

February 12.—Since writing to you on the 9th inst. I have

found that my colleague here, Prof. W. G. Brown, noticed the rings around the moon about half an hour before I saw them. He says the colour nearest the moon was yellow, passing into red outwards, and that immediately following the red was violet, then the colours of the solar spectrum in order from violet to red on the outside. This indicates that the first red was really outside a violet ring which for some reason was invisible, and brings the phenomenon properly under diffraction: in fact, we had a good example of the coronal with the innermost rings wanting.

S. T. MORELAND

Washington and Lea University, Lexington, Va., U.S.A.

The Beetle in Motion

IF it can interest Prof. Lloyd Morgan I am in a position to communicate that I have many times observed the progressive movements of insects, spiders, and myriapods. I have not noticed the retardation of hind-legs; it seems to me that this occurs only in the case of bulky and slow-moving beetles, like the larger Melasomata. In general, I find that the mode of progression in articulates does not differ essentially from what we see in vertebrates; the process is only, at first sight, a little obscured by the plurality of the legs. If we consider only the prothoracic ring of a beetle, we find that it walks like all bipeds, alternating one leg with another. Two segments walk in the manner of quadrupeds, which are not ambliers. Now the legs of the third segment must necessarily repeat the movements of the legs of the first segment, for the sake of equilibrium. The fourth ring would repeat the movements of the second, and so on.

Tashkend

A. WILKINS

A Recently-Discovered Deposit of Celestine

WITH reference to Mr. Madan's letter (p. 391), on "A Recently-Discovered Deposit of Celestine," I beg to inform him that a note was read by me at the last meeting of the Mineralogical Society, describing these crystals as exhibiting a habit and size unknown till then to occur with such crystals of celestine in England. I obtained the crystals at Christmas, from Mr. Henson, of the Strand, and am expecting to receive more material, which I hope to work on at the end of Term; but, unlike Mr. Madan, I have at present been unable to visit the locality where they are found.

R. H. SOLLY

Minealogical Museum, Cambridge, February 28

The Vitality of Seeds

MAY I ask, through the columns of your widely-circulated paper, whether there is any really trustworthy evidence for the following statement made by Prof. Judd in his address to the Geological Association (p. 393 in your last issue): "The botanist cites the germination of seeds, taken from ancient Egyptian tombs, as a striking illustration of how long life may remain dormant in the vegetable world." I know that this is a popular belief, but should like to learn upon what foundation it rests. Probably it would interest other botanists besides.

February 26

N. E. P.

THE RELATIONS BETWEEN GEOLOGY AND THE MINERALOGICAL SCIENCES

II.

LET us now turn from the static aspect of minerals, their morphology, to the dynamical aspects, their physiology.

Minerals are not fixed and unchangeable entities, as they are sometimes regarded. On the contrary, they exhibit varying degrees of instability, and pass through very definite series of metamorphoses.

We have already seen that every alteration in the temperature or other conditions which surround a crystal leads to striking modifications of molecular structure, which are at once revealed by the delicate tests of optical analysis. So sensitive, indeed, are some crystals to the action of external forces, that even the passage of the

¹ Address to the Geological Society at the Anniversary Meeting on February 18, by the President, Prof. John W. Judd, F.R.S. Continued from p. 396.

light-waves through their substance leads to permanent molecular rearrangements which are evidenced by marked changes in colour, translucency, and other properties.

Many minerals have their atoms so arranged that the action of external forces causes them to fall readily into new combinations. In this way there are brought about such paramorphic changes as that of aragonite into calcite, and auzgite into hornblende. Excessively slight manifestations of force are sometimes sufficient to induce such paramorphic changes.

But the most significant fact of all is that every crystal possesses certain peculiarities of molecular structure, and as the result of this internal "organisation," it responds in a definite manner to the action of various external forces, undergoing in this way well-marked series of physical and chemical changes without losing its identity. As the final result of such successive changes, however, the bonds which hold the "organised" structures together are gradually weakened, and at last break down altogether. In this way the separate existence of the mineral comes to an end; but the materials of which it was composed, resolving themselves into new compounds, may go to build up the substance of other "organised" structures. Need I point out that in all these respects minerals behave exactly like plants and animals?

But in the case of plants and animals changes such as these, which are the direct outcome of external forces acting on a special organisation, are called *physiological*, and I know of no valid reason why the same term should not be employed in the case of minerals. It is true that the accomplishment of the cycles of change in minerals often requires periods of time of enormous duration, and that during incalculable intervals they may appear to be wholly suspended; but in these respects the "life" of a mineral differs from that of a plant in just the same manner as the latter does from the life of an animal.

I must ask your attention for a few moments to these peculiarities of internal organisation in minerals, and to the way in which the various physical and chemical forces act and react upon them in consequence of their special organisation.

Recent researches have shown that every crystal possesses a number of planes, all of which are related to its peculiar symmetry, along which the several physical forces operate in a marked manner to produce changes in the physical and chemical properties of the crystal. These planes have been called the "structure-planes" of the crystal.

By far the most obvious of these structure-planes of crystals are those of cleavage. When crystals are subjected to the action of mechanical force they break up along one, two, or three definite planes, with varying degrees of ease. In some cases when this separation cannot be readily effected by percussion or pressure, it may be brought about by the unequal expansion and contraction in a crystal resulting from alternate heating and cooling. We cannot arrive at the limit of this liability of a crystal to separate along its cleavage-planes; if we powder a calcite-crystal and examine the fine dust under a microscope, each minute grain will be seen to have the form of a cleavage-rhomb of the material.

Now the exquisite molecular structure of a crystal, of which this wonderful property of cleavage is the outcome, is borne witness to, not only by the perfection of the cleavage-surfaces—presenting, as they do, a lustre which no artificial polish can imitate—but by the fact that each particular set of cleavage-surfaces presents definite characteristics, analogous to those seen in the actual faces of crystals. Each exhibits striking peculiarities in its mode of reflecting light; each yields in varying degrees to a hard point drawn across it in different directions; and each, when treated with appropriate solvents, is attacked in a characteristic fashion, giving rise to the geometrical forms known as the etching-figures. Wonderful as these

cleavage-surfaces are, however, it must be remembered that the power of cleavage is one that, under ordinary circumstances, remains altogether *latent* in crystals.

Cleavage-planes, however, are not the only latent structure-planes in crystals. Long ago it was shown by Brewster, Reusch, and Pfaff, that when minerals are subjected to pressure in certain directions, their molecules appear to glide over one another along certain definite planes within the crystal; and, if we examine optically a crystal which has been treated in this manner, it is actually found to exhibit a series of twin-lamellæ arranged parallel to the so-called "gliding-planes." It thus appears that in the movements set up within a crystal by the application of force from without, certain of the molecules of which the crystal is built up, lying in bands parallel to the gliding-plane, are actually made to rotate through an angle of 180° .

At one time these "gliding-planes" were regarded as being peculiar to a few minerals, such as calcite and rock-salt; but the investigations of Frankenheim, Baumhauer, Foerstner, and especially of Mugge, have shown that they exist in crystals belonging to every group in the mineral kingdom, including all those minerals which occur as common rock-forming constituents, such as the feldspars and pyroxenes.

As is the case with the cleavage-planes so with the gliding-planes, there may exist one, two, or three in the same crystal. One of these is usually a principal gliding-plane—the slipping movement with its accompanying twin-lamellæ being produced parallel to it with the greatest facility—while the others are subordinate ones.

Strange to say, however, the particular gliding-plane along which a crystal yields appears to be determined, not only by the direction in which the force is applied, but to some extent also by the nature of that force, whether percussive, or a sustained pressure, or a violent stress; in some cases where the application of external force fails to produce the gliding movement with its accompanying lamellar twinning, it may be induced by the strains which result from unequal expansion and contraction during the heating and cooling of a crystal. Some mineralogists have, indeed, proposed to apply distinctive names to the results which follow from the application of different kinds of force—whether a blow (*Schlagfiguren*), pressure (*Reissflächen*), or the effect of heating and cooling (*Contractionrisse*).

The gliding-planes of crystals are quite distinct from the cleavage-planes, though some very curious and interesting relations have in certain cases been shown to exist between them. That the artificial formation of twin-lamellæ, like the production of cleavage, is rendered possible by complicated molecular structures, it is scarcely necessary to point out. The application of external force to such crystals is like the putting of a spark to a train of gunpowder: the molecules lying in parallel bands are in unstable equilibrium, ready, so soon as set in motion, to roll through an angle of 180° .

There is still a third and even more subtle set of structure-planes in crystals to which I must now allude, those, namely, for which the name of *solution-planes* has been proposed.

It was long ago shown by Daniell that when crystals are exposed to the action of solvents they are attacked in such a manner as to give rise to peculiar geometrical forms. The subject has been followed up by Baumhauer, Leydolt, Becke, and others, who have shown what a wonderful variety of "etching-figures" may be produced by operating upon the various faces and cleavage-surfaces of different crystals.

Quite recently, however, it has been shown by Von Ebner, as the result of his studies of calcite and aragonite, that all the complicated phenomena of the etched figures arise from the existence of planes along which solvent or chemical action takes place most readily within

a crystal. It thus appears that the complicated etched figures, with their curved and striated surfaces, are indications of the combination or oscillation of tendencies to chemical action along the different solvent-planes of the crystal.

My own experiments have enabled me to show that the chemical action taking place along the solution-planes of crystals leads to the development of cavities, often assuming the forms of negative crystals, which may become wholly or partially filled with the product of the chemical action.

Although the solution-planes are quite distinct, both from the gliding-planes and the cleavage-planes of crystals, I have been able to show that some curious and interesting relations exist between them. If lamellar twinning has been already developed in a crystal, then chemical action takes place along the gliding-planes in preference to the normal solution-planes.

It is only when we study the minerals building up the rock-masses of the globe that we fully realise the importance of these molecular structures, and the wonderful changes which crystals are capable of undergoing, as a consequence of their internal "organisation." Then, and then only, do we begin to understand the significance and the far-reaching consequences of the physiological changes of which minerals are susceptible.

The crystals forming the rock-masses of the globe have been subjected to every variety of mechanical force—violent fracture, long-continued strain, steady but enormous pressure—prolonged over vast intervals of time, to which must be added the potent effects of alternate heating and cooling. Such crystals, moreover, are transfused through their whole substance by various liquids and gases acting under tremendous, and sometimes varying, pressures.

Under such circumstances it is not surprising to find that the crystals have often yielded along their cleavage-planes, and that cleavage-cracks have been produced. These, by affording a ready channel for the passage of solvents, not unfrequently determine the course of various chemical operations going on within the crystal.

Not unfrequently, too, the rock-forming minerals have yielded along their gliding-planes, and the development in them of twin-lamellæ is the result. Every crystal of calcite in an ordinary metamorphic limestone, and many of the plagioclase feldspars in igneous rocks, exhibit the secondary lamellar twinning which has arisen from the action of mechanical forces upon the mass.¹ The microcline structure in orthoclases, with many other similar structures in other minerals, must almost certainly be ascribed to the same cause.

Still more remarkable are the consequences which follow from the existence of the solution-planes in crystals. By the action of various solvents under pressure, augite is made to assume the forms known as diallage and pseudo-hypersthene, the ferri-ferrous enstatite of bronzite or hypersthene, while the feldspars acquire their aventurine, schiller, and chatoyant phenomena. When, in addition to the static pressures due to thousands of feet of super-incumbent rocks, these solvent agencies work with those tremendous dynamical aids afforded by deforming stresses, such as make the rocks to flow during mountain-making,

¹ It has often been asserted that the "striation" on the faces or cleavage-surfaces of crystals is an indication of the existence of polysynthetic twinning. But in the oligoclase of Ytterby and other localities, I have found that many crystals which exhibit striation do not affect polarised light differently in the alternate striae. But on submitting the crystals to alternate heating and cooling, and sometimes by percussive force, the twinning may be easily developed in them. It appears from these observations that the crystals are built up of lamellæ, in which the molecules are alternately in stable and unstable equilibrium. I have in some cases found that the stresses upon a slice of feldspar which is being heated and cooled and then ground into a thin section, while cemented to a glass plate during the preparation of a microscopic slide, are sufficient to cause the rotation of the molecules in the alternate lamellæ. In some cases, I have no doubt that twin-lamellation, like cleavage-cracks, may be induced in the crystals of our rock-sections during the processes to which they are submitted in their preparation.

it is not surprising to find the molecules of the original crystals breaking from their old allegiances, and the liberated atoms uniting to form new minerals, the position of which is determined by the lines of flow in the mass.

Not a few of our gems owe their exquisite beauties to these physiological changes which have taken place in them since their first formation. The ardent glow of the sunstone and the pale watery gleam of the moonstone, no less than the lovely play of the azure tints in Labrador-spar and the bronzy sheen of Paulite, are the result of physiological processes taking place in crystals which were originally clear and translucent. In the profound laboratories of our earth's crust slow physical and chemical operations, resulting from the interaction between the crystal, with its wonderful molecular structure, and the external agencies which environ it, have given rise to new structures, too minute, it may be, to be traced by our microscopes, but capable of so playing with the light-waves as to startle us with new beauties, and to add another to

"The fairy tales of science, and the long results of time."

Yes! minerals all have a *life-history*, one which is in part determined by their original constitution, and in part by the long series of slowly-varying conditions to which they have since been subjected. In spite of the circumstance that their cycles of change have extended over periods measured by millions of years, the nature of their metamorphoses and the processes by which these have been brought about are, in all essential respects, analogous to those which take place in a *Sequoia* or a butterfly. In spite, too, of the limitations placed upon us by our brief existence on the globe, it is ours to follow in all its complicated sequence this procession of events, to discover the delicate organisation in which they originate, to determine the varied conditions by which they have been controlled, and to assign to each of them the part which it has played in the wonderful history of our globe during the countless ages of the past.

The subject of distribution, or chorology, is one of no less importance in the study of the mineral than in that of the vegetable and animal kingdoms. The relations of minerals to one another, and the manner in which they make their appearance in respect both to time and place, constitute a most instructive and suggestive field of research.

The older mineralogists paid some attention to the question of the mode of association of minerals with one another, which they described under the term "paragenesis." But this was at a time when only large and freely crystallised specimens received much attention. At the present day this question of the varied distribution of minerals in space and time, and the manner in which they are associated with one another to build up rock-masses, constitutes a most important branch of our science, that to which the name of petrology is given.

Under the name of "petrography" an attempt has been made to establish a branch of natural-history science which shall bear the same relation to mineralogy as that science does to chemistry. As minerals are formed by the union of certain chemical compounds, so rocks, it is argued, may be regarded as being built up of different minerals. But it must be remembered that while minerals possess a distinct individuality—the result of their different chemical constitution and their characteristic crystallographic form—we are quite unable to point to anything analogous to these in the case of rocks.

How is a rock-"species" to be defined? It is not enough to state its ultimate chemical composition; for rocks of the most varied character and origin may agree in this respect. Equally futile is it to take mineralogical constitution as the basis of our classification; for, in the

same rock-mass, the species of minerals which are present and their proportions to one another may, and, indeed, often do, vary from point to point. Nor does minute structure, though affording admirable criteria for distinguishing certain *types* of rock, supply a sufficiently definite means of diagnosis for all the different varieties which occur. A system of "lithology" may, indeed, be devised, if we confine our attention to the hand-specimens in our museums; but it breaks down the moment that we attempt to apply it in our researches in the field.

I have long felt assured that all attempts at a nomenclature and classification of rocks must, for the reasons just stated, be regarded as tentative and provisional only; but the careful study of rock-types is nevertheless bringing to light a number of facts calculated to profoundly modify mineralogical no less than geological thought and speculation.

Petrology forms the link between mineralogy and geology, just as palæontology does between biology and geology. Mineralogy has justly been styled the alphabet of petrology; but if the orthography and etymology of the language of rocks lie in the province of the mineralogist, its syntax and prosody belong to the realm of the geologist. In that language, of which the letters are mineral species and the words are rock-types, I am persuaded that there is written for us the whole story of terrestrial evolution.

Petrology, it is clear, could make but little progress until the improvement of microscopic methods enabled us to make accurate determinations of the minerals in a rock, even when these are present as the most minute particles. The characteristic peculiarities of the different rock-forming minerals, so carefully studied by Zirkel, their accurate optical diagnosis, at which Rosenbusch has laboured with so much success, these with the micro-chemical methods of Knop, Bofický, Streng, and Behrens, and the pyro-chemical method of Szabó, have already done much to render exact our methods of recognising the minerals in a rock. The contrivances, for which we are principally indebted to the French petrographers, for effecting the isolation of the minerals in rocks, so that they may be submitted to accurate chemical analysis, enable us in cases of difficulty or doubt to confirm or check the results of our microscopical studies.

But there is at present, perhaps, a tendency to confound the end with the means in such researches as these. When all the varieties of minerals in a rock have been correctly identified, the work of the petrologist is not ended; on the contrary, it is only just begun.

The relationship of the several minerals in a rock to one another, the discrimination between such as are original and those of secondary origin, and the recognition among the former of the essential, as distinguished from those that are accessory or accidental,—these are problems of even greater importance than the exact determination of the species or varieties to which each belongs. In not a few rocks it can be demonstrated that every one of its present mineral constituents is different from those of which it was originally made up; in some cases, indeed, it may be shown that the recombination of the elements of the rock into fresh mineral aggregates has taken place again and again. As well might we try to give a rational account of our English speech without taking into account the series of changes through which it has passed in its evolution from the Anglo-Saxon dialects, as to explain the nature of a rock without studying the influence upon it of the forces by which it has gradually acquired its present characters.

With respect to the geographical distribution of the different mineral species, many suggestive observations have been made. Some, like the feldspars, the pyroxenes and the olivines, appear to be ubiquitous in our earth's crust, and even make their appearance again in those bodies of extra-terrestrial origin—the meteorites. Others,

like leucite, nepheline, hauyn, sodalite, and melilite, are exceedingly abundant in certain areas of the earth's surface, while they appear to be wholly wanting in others.

Still more remarkable are the relations which are found to exist between the types of rocks occurring in different geographical areas. The study of this subject is leading us to the recognition of the fact that there are distinct petrological provinces. In closely adjoining areas—such as Hungary and Bohemia, for example—widely different types of rock have been erupted during the same geological period; and this is a fact not less striking and significant than that of the meeting of two perfectly distinct biological provinces along a line which traverses the Malayan archipelago. It cannot be doubted that the prosecution of this hopeful branch of study—the geographical distribution of minerals and rocks—will lead us to results of the highest interest and value.

That there will be shown to be a distribution of rocks in time, as well as in space, I am perfectly prepared to believe. I cannot but think, however, that some of the generalisations on this subject which have been hazarded are somewhat premature. To a geologist (especially one belonging to the school of Lyell) it is equally difficult to conceive that there should be a broad distinction between the metamorphic rocks of Archæan and post-Archæan age respectively, as that the pre-Tertiary volcanic rocks should be altogether different from those of Tertiary and recent times.

The great object of all our studies—concerning the morphology, the physiology, and the chorology—of the mineral kingdom, ought to be to arrive at definite ideas concerning its ætiology; the causes by which the existing forms, capabilities, and positions of minerals and rocks have been determined.

While the *fossils* contained in rock-masses afford us the means for determining the date of their origin, the careful study of the minerals which they include may enable us to unravel the complicated series of changes through which they have passed since their first formation.

Eighteen years ago, when seeking to show how the origin of a particular rock might be elucidated by a combination of studies in the field, in the chemical laboratory, and by the aid of the microscope, I ventured to offer to this Society some general remarks on this subject. As it has been my constant endeavour since that time to apply the principles then enunciated in the case of rocks of more complicated character and more recon-dite origin, I may perhaps be forgiven for repeating the words I then used. Every rock since its first formation "has undergone and it still is undergoing a constant series of internal changes, the result of the action of different causes, as heat, pressure, solution, the play of many chemical affinities, and of crystallographic and other molecular forces, causes insignificant perhaps in themselves, but capable under the factor *time* of producing the most wonderful transformations. The geologist is called upon to unravel the complicated results, to pronounce what portion of the phenomena presented by a rock is due to the forces by which it was originally formed, and what must be referred to subsequent change; to discriminate the successive stages of the latter and to detect their various causes; in short, to trace the history of a rock from its deposition to the present moment."

Dr. Wadsworth has well characterised the changes which take place in rock-masses as due to the tendency of unstable mineral combinations to pass into stable ones. It must be remembered, however, that stability is a relative term, and that the arrangement of molecules which is stable under one set of conditions becomes unstable under another set. As by the internal movements and the external denudation of the earth's crust, the conditions under which rock-masses exist are undergoing slow but

continual change, new adjustments of the molecular structure of the rocks are at once necessitated and brought about.

In attempting to reason as to the *original* conditions under which a rock-mass must have been formed, it is of great importance to avoid those sources of error which exist in rocks that have undergone much secondary alteration. Such rocks abound in, though they are not necessarily confined to, the older geological formations; and it is among the younger and fresher rocks, therefore, that we may most hopefully seek the key to many petrological problems.

If, for example, we concentrate our attention upon the more recent and less altered igneous rocks, it becomes clear that the degree of crystallisation displayed by them has depended on the slowness with which consolidation has taken place, and that this has in turn been determined by the depth from the surface at which they have been formed. In this way, by the study of igneous rock-masses in Scotland and in Hungary, I was able to show that there is a perfect gradation from highly crystalline rocks—granites, diorites, and gabbros—into the ordinary volcanic types—rhyolites, andesites, and basalts, respectively—and from the latter into the various kinds of volcanic glass. These conclusions have been confirmed by subsequent investigations like those of Hague and Iddings in the Comstock region, and of Lotto in Elba. Further and more recent researches have enabled me to show that certain types of structure have been determined in rocks, according to the more or less perfect absence of all movement within them during their consolidation.

Very remarkable, indeed, are the internal changes which take place in rock-masses when they are submitted to those powerful stresses which result from the movements that occur during mountain-making; and the full explanation of these is perhaps the most difficult problem which still confronts the geologist.

It was long ago asserted by Scrope and Darwin that the solid rock-masses of the globe, under such conditions as these, must have actually *flowed*, like the viscous lavas of the rhyolitic series. These geologists were even able to show that the separation and disposition of the crystalline elements in such lavas present the closest analogy with what is seen in the crystalline schists and gneisses of greatly disturbed areas.

Since these early researches, which were principally based on the study of rocks in the field, aided only by the pocket-lens, three classes of researches have served to deepen our insight into the methods by which the schistose and gneissose rocks must have been produced.

In the first place, the experiments of MM. Tresca and Daubrée have shown that solid matter under enormous pressure behaves like a viscous substance, its whole internal structure exhibiting evidence of the flowing movements to which it has been subjected.

In the second place, the studies of M. Spring have established the fact that both paramorphic change and direct chemical reaction may result from simple pressure. Thus the unstable monoclinic form of sulphur, by a pressure of 5000 atmospheres, was at ordinary temperatures converted instantly into the stable rhombic form, a transformation accompanied by change of density and of many other physical properties. Still more striking is the case of the unstable, yellow, rhombic, mercuric iodide, which, by simple rubbing with a hard substance, passes into its stable, red, tetragonal allomorph. It is instructive to notice that the same change in both instances appears to take place "spontaneously" after a sufficient interval of time; or, in other words, small variations in temperature, pressure, and other surrounding conditions are capable, if sufficient time be allowed, of bringing about the same result as more intense pressure applied suddenly. That the similar paramorphic change of pyroxene into hornblende, which is so frequently

exemplified in the earth's crust, is sometimes the result of intense pressure, and at other times follows from the repeated slight alteration of conditions during long periods of time, we have, I believe, abundant evidence.

But the experiments of M. Spring that prove that chemical reactions can result directly from pressure are of even greater interest to the geologist. By submitting mixed powders to intense pressure, he succeeded in producing metallic alloys and various binary compounds, and also in bringing about double decomposition between many salts. That similar reactions between the complicated silicates which form the minerals of rocks have resulted from the enormous pressures to which they have been subjected, we have the most ample proof. Thus in rocks where such pressure has just begun to act, such as the "flaser-gabbros," wherever the unstable olivine is in contact with the almost equally unstable anorthite, chemical reactions have been set up by the pressure, and these have resulted in the formation of zones of enstatite and anthophyllite, hornblende and biotite, which have been so well described by Torneböhm, Bonney, Adams, and Williams. Provided with the clue supplied by these results, we find little difficulty in going one step further. When the pressure has been still more intense, as in mountain-making movements, reactions are set up among all the minerals of the rock-mass; the elements of which it is composed, set free from their old engagements, enter into new alliances, and the result is the formation of a completely new set of crystallised minerals.

The third class of researches, destined, as I believe, to remove our difficulties in explaining the origin of the schistose and gneissose rocks, are those already alluded to as having been undertaken with the microscope. As yet the details of such changes have only been explained in the case of some of the simpler examples; but I am convinced that the persevering application of the same methods in the field and the laboratory will result in the removal of difficulties that now seem to be absolutely insurmountable.

Some observers in this country have been led to infer that the recrystallisation of rock-masses under pressure has in all cases been preceded by their pulverisation. Of this, I confess that I can find no evidence. That near great faults of all kinds, this reduction of rocks to powder does take place, we find abundant proof; but the evidence also points to the conclusion that such *rock-crushing*, as distinct from *rock-flowing*, is in every case local and exceptional.

There is another and totally different series of changes which takes place in rocks, when, brought near to the surface by denudation, they are exposed to the action of water, oxygen, carbonic acid, and other atmospheric agents. The breaking-up of the alkaline silicates and the deposition of secondary silica, the formation of the zeolites, the epidotes, the chlorites, and serpentine, the resolution of crystallised minerals into the isotropic mixtures, and the recrystallisation of these in new forms, all offer problems of the highest interest to the geologist.

I may venture, in drawing these remarks to a close, to indicate another point of analogy between the three natural-history sciences. It is found in the circumstance that experimental verifications of our conclusions are often difficult, if not actually impossible.

We must be content to reason from the proved variability of the existing forms of plants and animals as to the possibility of the production in time of new species. And in the same way, with our limited command of heat, pressure, and especially of time, we can scarcely hope to originate the exact counterparts of the various minerals and rocks of our earth's crust.

We may nevertheless joint with satisfaction to what, in spite of such difficulty, has already been accomplished in this interesting field of research. The honour of having

pushed these researches to such successful issues belongs chiefly to the chemists, mineralogists, and geologists of France. To the labours of Senarmont, Daubr e, and a host of other workers, we owe the artificial production of a very large number of the minerals of our globe; while the ingenious experiments of Fouqu e and Michel L vy have resulted in the formation of many rocks differing in no essential particulars from those which have been produced by natural agencies.

In the prosecution of his various researches the importance and value of exact mineralogical knowledge to the geologist is becoming every day more apparent. The temporary estrangement between the cultivators of mineralogy and geology is now, we may hope, for ever at an end; very heartily, indeed, do geologists recognise and welcome the aid of their brethren the mineralogists.

But if it be confessed that the benefits, past and prospective, conferred on geological science by mineralogy are vast and even incalculable, it must also be admitted that the debt is amply repaid by the beneficial influence which is being exercised in turn upon mineralogy by geology.

Some time ago a distinguished mineralogist asked me if I did not find the ordinary text-books of his science but little calculated to arouse the interest or excite the enthusiasm of students. I am sure that the energy of my assent must at least have assured my friend of the strength of my convictions on the subject.

Too long, indeed, has the accumulated mass of mineral lore recalled the grim vision of the seer of Chebar. In that gruesome valley the wail of the student, "the bones are very dry," has mingled with the sigh of the teacher, "Can these bones live?" But now from the four winds of heaven come the constructive ideas of many minds—from Scandinavia and from France, from Germany and from the United States—and in obedience to this influence behold "a great shaking" in the formless mass. Scattered facts, isolated observations, imperfect generalisations, and tentative hypotheses are falling together "bone to his bone," and are building up a sound body of mineralogical knowledge; and into this the spirit of geological thought entering, mineralogy shall stand forth a living science.

DR. WILLIAM TRAILL, OF WOODWICK¹

THE death of this assiduous student of natural history merits more than a passing notice, since there are few surgeons who did more for the advancement of Eastern conchology than he; while his researches on the antiquities of his native county (Orkney) also claim attention. His whole career, indeed, as in the case of many an Eastern surgeon, illustrates the wisdom of placing both natural history and botany on the curriculum of every medical student.

Dr. Traill was the eldest son of Mr. Traill, of Westness, Rousay, Orkney, and he was born in Kirkwall on September 8, 1818. He proceeded to the University of Edinburgh to study medicine at the age of sixteen, and while there he had the advantage of the direction and advice of his uncle, the late Prof. Traill, who held the Chair of Medical Jurisprudence. Young Traill proved an apt student, and showed from the first a strong liking for natural history. This was fostered by his uncle (whose collection of snakes, now in the Museum of Science and Art, was well known to naturalists), as well as by his pursuits during the holidays at the family seat at Westness, in the Island of Rousay. Amongst his fellow-students were Dr. Cleghorn, of Stranathie, late Conservator of Forests in India, Sir Lyon Playfair, and Dr. Halliday Douglas.

After graduating in 1841, he proceeded to India as a surgeon in the East India Company's service. The

¹ Abstract of Paper read at the Literary and Philosophical Society, St. Andrews, January 21, 1887.

splendid field thus opened up to the young naturalist stirred all his energies into activity, and he studied and collected various groups, but especially the land-shells of Madras. His early studies on the shores of Orkney had given him a predilection for this department, and he remained faithful to it throughout life. Thus, when shortly afterwards called to serve in China, he began the collection of those beautiful specimens of Eastern shells now so well known in many collections. His opportunities were further extended by a residence of some years at Singapore, and afterwards at Malacca and other stations. He returned to England in 1854, and his collections were much admired, both as regards the beauty of the specimens and the number of examples of each species. His acquaintance with Dr. Knapp, a retired army surgeon, and also well known as a malacologist, gave a great impetus to his studies, as also did his association with Andrew Murray, Robert Gray, Dr. Howden, Wyville Thomson, Foster Heddle, James Cunningham, Patrick Dalnahoy, and R. Greville.

His return-voyage to India in 1856 gave him an opportunity of examining the pteropods and other pelagic mollusks, and his observations, with four plates and a chart, were communicated by Sir Walter Elliott to the *Madras Journal*, then edited by his friend Dr. Cleghorn. His preparations of the delicate glassy shells of the Thecosomatous forms was remarkable. He also described some rare species, observed certain peculiarities in their structure, and made comparisons between the velum of the young *Cypræa* and the epipodia of the pteropods. His collection of Eastern mollusks was largely increased during his second period of duty, so that it became celebrated for certain rare types, such as *Rostellaria rectirostris*, *Trochus guilfordii*, *Trochus imperialis*, &c. He also added largely to Prof. Traill's collection of snakes formerly alluded to.

On retiring from active duty he settled at St. Andrews, and at once took an active interest in the University Museum and Literary and Philosophical Society, of which latter he was a Vice-President at his death. He spent much of his time in arranging the Mollusca in the Museum, and he enriched the collection by many interesting and rare types. In his annual trips to his estate in Orkney he also made researches on the antiquities and geology of the district, and these he embodied in papers communicated to the Edinburgh Antiquarian Society, and to the Society at St. Andrews. Amongst these papers are the following:—"Results of Excavations at the Broch of Burrian, Orkney," two plates and woodcuts; "Notice of Excavations at Stenabek, Orkney," with woodcuts; "On Submarine Forests in Orkney"; "On the Picts' Houses of Skerra Broc"; "On the Recurrence of Boulder-Clay in Orkney"; "Notice of the Boulders in North Ronaldshay," &c.

His knowledge of botany also enabled him to acclimatise various plants in Orkney, such as *Phormium tenax*, various Veronicas, the Manuka (Capt. Cook's sea-plant), the Japanese *Euonymus*, and others.

Dr. Traill was a man of refined and cultivated mind, genial but unobtrusive, and had a large circle of friends. He enjoyed good health till eighteen months ago, when the first symptoms of the disease which ultimately proved fatal appeared.

W. C. M.

THE EARTHQUAKE

A SERIES of shocks of earthquake has caused much havoc in the Riviera during the last week. Although it is too early to attempt to give a complete account of what has happened, the leading facts, so far as they are of scientific interest, are well summed up in the following report, issued by Father Denza, of the Montcalieri Observatory:—

"(1) The earthquake in our region has had nearly the

same effect as those on November 28, 1884, and September 5, 1886. In length it extended to the east along a line leaving the plains of Lombardy at Lomellina, and passing by the district of Alessandria to the Riviera di Levante, and westward over all the Western Alps, proceeding towards Switzerland as far as Geneva and beyond, and to Paris and Corsica. The telluric movement proceeded from the Lepontine Alps on the north to the Gulfs of Lyons and Genoa on the south, extending, but more feebly, through Tuscany to Rome.

"(2) The movement had its greatest intensity in Liguria, in Southern France, and in Piedmont, where it shook the whole of our plain, and penetrated into all the Maritime, Cottian, Graian, Pennine, and Lepontine Alps.

"(3) This time the centre of the strongest intensity was in the Gulf of Genoa, along the line dividing the place where the Apennines join the Alps, and extending from Savona to Mentone. It was within this space that people lost their lives in several localities, such as Savona, Noli, and Mentone, and everywhere as far as Marseilles there were numerous disasters and buildings thrown down. The movement of the soil, not so violent, but equally disastrous, spread over the mountainous country which extends from the Altare Pass to Millesimo, Mondovi, and the neighbouring regions. The shock was severe, but it did no considerable damage, in a portion of the province of Coni, as also in the provinces of Alessandria and Turin, it being very intense on Mont Cenis. It was slighter in the plains and in the valleys of the province of Novara.

"(4) In the places where the earthquake was most intense the principal shocks were three in number, and with a slight difference, depending probably on the difference of clocks, correspond to the times indicated by the seismic instruments of our Observatory—namely, the first at 6.22 a.m., the second at 6.31, and the third at 8.53. In the places near the centre of motion slight shocks occurred at intervals all through the day. The severest and most terrible shock was the first, which was undulatory in several places, oscillatory, and perhaps rotatory. It was several times prolonged and accentuated. Here at Montcalieri, as at Turin and elsewhere, it had three principal repetitions, plainly evidenced by the courses traced by our registering seismograph. These augmentations of intensity were mistakenly regarded by some as so many distinct shocks.

"(5) The dominant direction of the first undulatory shock was from west to east, with slight deviations at intervals from west and north-west to east and south-east, and with oscillatory and very slight vibrations. The two other shocks were also undulatory, and the last was rather more intense than the second, but without reaching the intensity of the first. The second and third had about the same direction as the first.

"(6) The earthquake in places where it was severe and very severe was accompanied by rumblings. I may add, in conclusion, that about 2 o'clock this (Thursday) morning our most delicate seismic instruments signalled very slight fresh shocks, undulatory, and from north-west to south-west."

The fullest and most accurate details as to the successive shocks have come from the more important towns in the western Riviera. Mr. W. J. Lewis, writing to us from the Hôtel des Îles Britanniques, Mentone, on Saturday, the 26th of February, says that some slight vibrations seem to have been felt there about midnight and 3 a.m. before the great shock. "This last," he continues, "occurred apparently a few minutes before six, just as day was dawning." He was roused from sleep by being violently jolted in bed, which was being shaken with great violence. At the same instant he heard loud noises of apparently cracking walls and ceilings, and the rattle of falling plaster and breaking glasses. "I did not," says Mr. Lewis, "instantly realise my position, but had time

to consider what was going on, and to conclude that, if the house collapsed under the shock, escape was hopeless, and that there was nothing to be done. This may possibly have taken ten seconds. Needless to say, that when the motion ceased and I found myself unharmed, I was up seized my warmest clothing, and was down in the garden in less than a minute. The daily Press will have sufficiently described the scenes which have occurred throughout the Riviera. The second shock, of considerable but much less force, occurred about ten minutes later. I observed, within a few minutes of this that the hall clock marked 6.15, local time, corresponding to 5.54 a.m., so that I should be inclined to place the second shock at 6.10. A third shock of about the same intensity as the second occurred between 8.30 and 8.45. This last threw down bricks, tiles, &c., which had been displaced by the first shock, and raised the panic to the greatest height."

According to Mr. Lewis, the early reports of the disaster at Mentone were much exaggerated, but the truth, he says, is bad enough. "The large hotels, especially those in high situations, seem to have suffered least. The whole of the East Bay and the old town have escaped practically unharmed. The greatest damage has occurred to two-storied buildings placed on the alluvia soil in the comparatively level part lying along the sea and in the valleys of the Carrei and Borriogo, embracing the main portion of the modern town of the West Bay. Here the relation with the foundation is well marked in the case of two equally well-built houses not more than 300 yards apart, viz. St. John's Parsonage and the House of Rest. The former is in the valley, and the foundation were a source of great trouble at the time of building. It is very much shattered. The other is built on a rock, and has escaped uninjured. Within a radius of a quarter of a mile of the station the main destruction has occurred. But the houses most wrecked—some score or more—show most conclusively bad building. The large hotels in this injured area—the Îles Britanniques, National, Orient, Méditerranée, des Colonies, &c.,—most of which are four to five stories high, have suffered injury to lathe and plaster, but in few places are the main walls seriously damaged. In the case of these high buildings the intention of raising them to such a height necessitated a firm and solid foundation. I have noticed that the walls in a part of this hotel at a height of six stories have on the top floor suffered no visible damage. In the same way Mont Carlo, built on rocky ground, has escaped uninjured."

Writing from Nice, a correspondent of the *Times*, signing himself "Commander, R.N.," says that, on Wednesday morning, about six o'clock, he was awakened by an extraordinary commotion so unaccountable that for a moment he thought an escaped lunatic was shaking the bed in a maniacal outburst of fury. Running to the window, he saw that the shock must have been very severe, "for everywhere the streets were strewn with fragments of cornices, mouldings, chimney-pots; while many houses exhibited dangerous-looking cracks and rents in the walls of the upper stories. Another shock as violent as the first must inevitably have been followed by the downfall of many buildings. Fortunately, however, none of the succeeding shocks at all approached the first in violence." Another correspondent of the *Times*—"C. I. de M."—writes from Nice, that he was awakened shortly after 6 a.m. by "a tremendous vibration, which shook the whole house, a large hotel, from top to basement. The bed rocked and swayed violently to and fro like a hammock set swinging, and great masses of plaster fell from the ceiling and walls in every direction, strewing the room with *débris*, while the paper was literally stripped from the walls, and every second the whole hotel appeared as if it must topple over. . . . At 8.30 a.m. another shock though of less violence, seemed to complete the reign of terror which had now set in."

At Cannes Sir Theodore Martin noted that the first

series of shocks began at five minutes after six (Cannes time). "No premonitory warning was given, and there was none of that rumbling noise which frequently accompanies earthquakes. The sky was without a cloud, and the first 'rose of dawn' had just begun to show itself in the east. The air was still and fresh, and not a leaf stirred in mimosa or eucalyptus. The trembling, beginning somewhat gently at first, like that produced by the passage of a heavy railway train, grew rapidly more and more marked. . . . The convulsion lasted for fully a minute, and the oscillation was from east to west. A second but light shock, some minutes afterwards, did not tend to diminish the apprehension caused by the first. So far as we can learn, few of the thousands who fill the hotels remained in their rooms, the great majority finding their way, some in the scantiest of raiment, into the adjoining gardens. The first alarm was beginning to pass off when, about half-past eight, a third shock was felt. This did not last above fifteen seconds, but while it lasted it was very severe, shaking the floors and moving the furniture in the same way, but in a less degree than the first shock. The air continued calm as before, and the whole sky was flooded with sunshine."

It will be observed that Sir Theodore Martin describes the direction of the oscillation at Cannes as from east to west. Another correspondent of the *Times* says that at Antibes the undulations were "undoubtedly from west to east." At Toulon, where there were two violent shocks about six o'clock, the undulations were also from west to east. On the other hand, at Turin, where there were three shocks in the space of seventeen seconds, the second shock, which was by far the strongest, had a direction from north-east to south-west.

At Marseilles two smart shocks were felt about 6 a.m., and a third at 8.30 a.m. They lasted about fifteen seconds each, and caused fissures in several houses. At Nîmes some windows were shattered, and the clocks stopped; and like results were produced at Gienoble. At Avignon three shocks were felt between 6 and 8 o'clock a.m., and the first shock was violent enough to awake all the inhabitants. Slight shocks were felt at Lyons.

It was in the towns and villages of the Italian Riviera that the earthquake produced its most desolating effects. Dianio Marina was utterly destroyed. At the first shock, about 6 o'clock, the inhabitants of this place rushed into the streets half dressed. Then came a more fearful shock. A frightful cracking noise was heard as far as the beach, and the houses fell in, burying the greater number of those who had lived in them. The results at Dianio Castello, a mile and a half off, were also very appalling, and at Bajardo more than 200 persons were killed in the church. The full extent of the calamity which so suddenly overtook these and other places in the same district cannot even yet be accurately determined. The following is the official list of dead and wounded:—Alassio, 3 dead, 8 wounded; Albenga, 30 wounded; Albissola, 3 dead, 12 wounded; Bajardo, 230 dead, 30 wounded; Bussano, 80 dead, 27 wounded; Castellaro, 41 dead, 65 wounded; Ceriana, 5 dead, 12 wounded; Dianio Castello, 35 dead, 10 wounded; Dianio Marina, 180 dead, 65 wounded; Montalto Ligure, 1 dead, 3 wounded; Noli, 16 dead, 12 wounded; Oneglia, 23 dead, about 150 wounded; Pompeiana, 5 dead, 7 wounded; Porto Maurizio, 1 dead, 10 wounded; Savona, 11 dead; Taggia, 8 dead, 14 wounded; Triora, 4 dead, 9 wounded.

All over Switzerland the earthquake was felt, more or less, and the oscillations are said to have been from north to south. Dr. A. Riggenbach, Assistant Astronomer at the Basle Observatory, writes to us that some shocks occurred there. The two clocks of the Basle Observatory, and the two regulators of the public electric dials, the principal astronomical clock of Knoblich, keeping sidereal time, were stopped at 6h. 42m. 50s. a.m. local mean time, or 5h. 34m. 30s. a.m. Greenwich mean time.

Mr. G. M. Whipple, Superintendent of the Kew Observatory, has been good enough to send us a careful tracing, which we reproduce, of the curve given by the bifilar magnetograph at the Kew Observatory, showing that the instrument was affected by the earthquake about 5.40 a.m. Indications of the later shocks were shown on the original photograph, but not with sufficient clearness to enable them to be satisfactorily

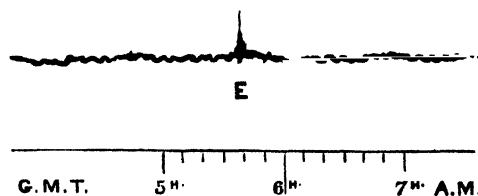

Copy of trace of bifilar magnetograph at the Kew Observatory, Richmond, Surrey, 1887, February 23, 5-7 a.m. Movement produced by earthquake marked E.

identified. In the Signal Office at Washington, the Government seismoscope was, on Wednesday morning, disturbed by accurately recorded shocks at 7.33 a.m. This is equivalent to 7.50 a.m. by the standard time of the 75th meridian. If, therefore, these shocks were connected with the earthquakes in Southern Europe, the velocity of their transmission from the Riviera was about 500 miles an hour.

The problems connected with the earthquake were discussed at the meeting of the French Academy of Sciences on Monday. M. Mascart stated the contents of a note from M. Fines, of Perpignan, who possesses a magnetometer. A little before the shock his magnetic instruments were shaken by a peculiar jolting motion. At 5.45 a.m. the magnetic registering instruments at the Observatory in the Parc de St. Maur, near Paris, exhibited the same motions. At the Lyons Observatory similar vibrations were observed at 5.55. M. Mascart remarked that these movements were simultaneous. It was not, therefore, an oscillatory movement passing from one point to another with which they had to deal, but a phenomenon which affected a large space simultaneously. He supposed there had been an electric current which had acted on all the instruments placed within its sphere of action. The form of the curves recorded was very distinct from those given by magnetic instruments when affected by storms or auroras. M. Mascart suggested that means might yet be found of predicting the approach of a seismic storm. He added that if the cause of the effects that had been observed was an electric flux, it was easy to understand why their intensity was everywhere nearly the same. A commission was appointed to examine documents which may be transmitted with reference to the earthquakes.

NOTES

A CIRCULAR to Great Britain and the other European States, and to the United States, has been forwarded by the Executive Commissioners of the Melbourne Centennial International Exhibition. The Exhibition will be opened on August 1, 1888, in order to celebrate the centenary of the founding of the colony of New South Wales, and will remain open for six months. The Commission invites the British, foreign, and colonial Governments to participate in the undertaking, and trusts that steps will promptly be taken by them for the completest possible representative display. It is pointed out that the population of Australasia is 3,500,000, that the imports of British goods annually amount in value to 22,000,000*l.* and that 7700 miles of rail-

way are open for traffic, while over 2000 miles of line are in course of construction. Applications for space must be made before the end of August this year. The Commission desires to make the Exhibition specially interesting in manufacturing processes, machinery, &c., in motion, and objects of manual labour. There will also be a picture gallery lighted by electricity. Further information may be obtained from the Agent-General in London, or from the Executive Commissioners in Melbourne.

MR. ROBERT ETHERIDGE, JUN., of the Geological Department of the British Museum, has received the combined appointments of Palæontologist to the Department of Mines, and to the Australian Museum, Sydney, and will shortly proceed to Australia to take up the duties of the two offices. His extensive palæontological knowledge will be much missed in the British Museum.

SOME days ago the Medical School of Paris elected M. Brouardel as Dean, in the place of M. Béclard, recently deceased. M. Brouardel is Professor of Forensic Medicine.

ON Saturday last Mr. John Morley delivered, in the Egyptian Hall of the Mansion House, the annual address to the students of the London Society for the Extension of University Teaching. His subject was "The Study of Literature," and we need scarcely say that he set forth his ideas with his usual vigour and lucidity. But what did Mr. Morley mean by the following sentence: "I, for one, am not prepared to accept the rather enormous pretensions that are nowadays made sometimes for physical science as the be-all and end-all of education"? By whom are these "rather enormous pretensions" made? Men of science, no doubt, claim for the study of physical science a high place in education; but we have never heard that they feel disposed, on that account, to exclude the study of art and literature.

THE University of St. Petersburg lately celebrated its sixty-eighth anniversary. It has 64 professors, 47 fellows, 8 lecturers, and 39 laboratory assistants. There are 2627 students, who are grouped as follows:—For Oriental languages, 87; for law, 1170; for natural science, 426; for mathematics, 618; for history and philology, 224.

WE have received the four February sections of "Studies in Microscopical Science," edited by Mr. Arthur C. Cole. The text, which is finely illustrated, relates to *Haustoria*, the ovary and ova in birds, fatty degeneration of the kidney, and microbes.

PROF. OTTO STRUVE'S jubilee was celebrated some days ago at the Pulkowa Observatory. A great number of delegates from learned societies and scientific institutions were present.

THE new journal edited by Prof. Grancher is called the *Bulletin Médical*. It appears in Paris twice a week, on Thursdays and Sundays.

IN the February number of the *Journal of the Anthropological Institute* there is an interesting paper by Mr. Bloxam, describing eight specimens of Aroko or symbolic letters, which have actually been used by the tribe of Jebu in West Africa. These Aroko were sent to Mr. R. N. Cust by Mr. J. A. Otonba Payne, Registrar of the Supreme Court at Lagos, who himself belongs to the tribe of Jebu. The paper is carefully illustrated. One of the figures represents a message from a native prince of Jebu, Ode, to his brother residing abroad. It consists of six cowries, all turned in the same direction. The quill of a feather is passed through them from front to back, and the shaft is turned towards the end of the quill and fixed to the side of the

cowries. The significance of this symbolic group of objects depends upon the facts that, in the Jebu language, six is "E-fa," from the verb "fa," to draw, and that Africans are in the habit of cleansing their ears with a feather, and look upon it as the only instrument by which this can be effectually done. The meaning is: "By these six cowries I do draw you to myself, and you should also draw closely to me; as by the feather only I can reach to your ears, so I am expecting you to come to me, and hoping to see you immediately."

IN the *Rendiconti* of the Reale Istituto Lombardo for January, Count Trevisan de Saint-Léon describes some experiments recently carried out by Dr. Bareggi in Milan, for the purpose of showing that it is possible to ascertain, from the state of the blood, whether persons bitten by animals suspected of rabies, or even undoubtedly mad, have really been infected.

THE Reports of the Botanist to the New York Agricultural Experiment Station, Geneva, N.Y., Mr. J. C. Arthur, for 1885 and 1886, furnish an admirable illustration of the value of such State appointments. A large portion of both Reports is occupied with an exhaustive history of the pear-blight (*Micrococcus amylovorus*), which is exceedingly destructive to pear-trees in the Northern United States; proofs that the mischief is caused by the specific Bacterium; and suggestions for a remedy. In addition to this, much information is given with regard to the following diseases, among others: the strawberry-mildew (*Sphaerotheca Castagnei*), the plum-leaf fungus (*Septoria cerasina*), the lettuce rust (*Septoria Lactucee*), and the lettuce-mildew (*Peronospora gangliiformis*). Woodcuts are given of these various fungoid parasites, and a very useful summary is appended of the literature of the pear-blight.

AN admirable lecture on "Wrought Iron" was delivered by Mr. J. Starkie Gardner at the Society of Arts on Tuesday, February 22. It is printed in the current number of the *Journal of the Society of Arts*, with illustrations of the exquisite ironwork in the cathedrals of York, Durham, and Winchester. The general artistic superiority of mediæval ironwork to that of later times Mr. Gardner attributes in part to the fact that in the Middle Ages important work of this kind was intrusted only to smiths who had a special aptitude for it. If such a workman was not forthcoming, the work was either not executed, or was made in the simplest form; whilst, if he were forthcoming, the details at least of the design were left to his own fancy. Mediæval smiths were not fettered by estimate or bound by time, but Mr. Gardner is of opinion that they did their work much more quickly than men do now. Otherwise, he thinks, the intricate designs used in Germany, Spain, and Portugal, for ordinary domestic purposes, could not have been produced at any price which would have suited the occupiers.

AT a durbar held at Shillong in connection with the Jubilee rejoicings, Mr. Ward, Chief Commissioner of Assam, reviewed the history of the province during the last fifty years. In that time, he said, its population and settled area had been nearly trebled. The first tea plantation had been started about fifty years ago. There were now nearly 200,000 acres under tea, while the land taken up by planters, although not yet actually planted, amounted to about 400,000 acres. Again, fifty years ago the land revenue of five districts, comprising Assam had been about four and a half lakhs of rupees; it had grown twenty-six lakhs. Then the journey from Gowhaty to brooghur had occupied a month or six weeks; now it took three days.

MUCH interest has been excited by the announcement of Capt. Conder, of the Palestine Exploration Expedition, succeeded in deciphering and translating the Hittite inscriptions. Ten principal texts are known, and Capt. Conder claims to have

epreted all of them. Three of his translations, which were blished in the *Times* of Saturday last, are invocations to the and water gods, and, apparently, to the divinity of the on. Capt. Conder says that not only the words, but the mmar of the inscriptions, can be shown to belong to a well-own tongue. What this tongue is, we are not to learn for ne time.

WE regret to announce the death of Dr. Grothe, Professor at : Polytechnical School at Delft, author of "Mechanical chnology," and an excellent monograph on iron. He was n in Westphalia in 1806, and died on February 10 last.

PROF. HÆCKEL, of Jena, has just started on a journey to : East, which will be of some months' duration. He will it the coast of Asia Minor to continue his investigations of er marine animals.

LIEUT. QUEDENFELDT has just returned from Morocco to rlin, bringing with him some valuable collections: an ethn-ical one, which he has presented to the Anthropological ciety, a collection of insects, and a large collection of the plements, tools, and instruments of torture of the Hamadjas oe.

MESSRS. G. PHILIP AND SON have in the press a revised and arged edition of "The Geology of England and Wales," by race B. Woodward, F.G.S., of the Geological Survey of gland. They will also have ready shortly "Philips' Plani-riere of the Stars visible from the Countries situated about ' south of the Equator" (uniform with "Philips' Plani-riere for England"); "Rustic Walking Routes within the elve-mile Radius from Charing Cross," containing a field-:h map of the district, with geographical description, charts, l directions, by W. R. Evans; and "Philip's Handy Volume las of the World," consisting of sixty-four plates, containing wards of one hundred maps, printed in colours, with statistical es on each map.

MESSRS. WHITTAKER AND CO. will publish shortly a second d much enlarged edition of "Magnets and Dynamo-Electric chines," being the first volume of their "Specialist's Series." r the new edition some revisions in the text have been made, l a preface and a chapter on the latest types of generators ve been written by Mr. W. B. Esson.

A FRENCH translation has been published of Cæsar Lombroso's Jomo Delinquanti," with a fine series of figures to illustrate : learned author's lectures concerning the anthropological tures of the professional criminal.

ADMIRAL TEISSERENC DE BORT has just published a map, wing the distribution of fog on the various parts of the earth. is based upon observations made at 1600 land stations, and 2,000 marine ones.

IN a Report just issued, Mr. S. W. North, Medical Officer of ealth, calls attention to the prevalence of typhoid fever in rk during the year 1886. For many years York has been ble to outbreaks of this disease, and the fact will not surpris yone who reads Mr. North's account of the sanitary con-ions of the city.

IN a paper entitled "Ueber die Allgemeine Beugungsfigur in nröhren" (*Mémoires de l'Académie Impériale des Sciences St. Pétersbourg*, vii^e série, tome xxxiv., No. 5), Hermann uve remarks that the old problem of the diffraction of light ough a circular aperture, the source being in the axis, has n considered by Airy and others, who have given approx-ite solutions in special cases; but the general solution has y been made feasible by the discovery of Bessel's funct-ions. : accordingly proceeds to develop it by the straightforward hods with which readers of modern analysis are familiar.

showing how his solution accords with those previously given for the axis and for the edge of the geometrical shadow. In this latter case he remarks that the illumination is less than one-fourth that which would be obtained by removing the screen. His results are put into a useful numerical form in tables at the end of the paper.

THE last number of the *Bulletin* of the Belgian Natural His- tory Museum contains a summary of ornithological observations made at various stations throughout Belgium during the year 1885. This is quite a novel feature, which, if carried out systematically, promises excellent results, especially as regards the many obscure questions connected with the migrations of birds of passage. The chief stations are Brussels, Hasselt, Carls- burg, and the Ostend and other lighthouses along the coast. The names of the naturalists who undertake to send in reports are given in all cases. These reports contain the name of the bird in three languages—Latin, French, and Flemish or Walloon according to the locality—followed by the dates of arrival and departure, and any other remarks tending to throw light on the habits and movements of the bird. Thus, under *Ciconia alba*, Bechst., *Cicogne blanche*, *Ooievaar* (white stork), we have, from the Nieuport Lighthouse: "Seven seen, June 18, flying west- wards; rare on this coast, where they never nest.—Signed, A. Vermorke." The present summary contains 171 such entries, the value of which, when made by competent observers from year to year, ornithologists will not fail to appreciate.

THE latest advices from Honolulu report that the volcano of Mauna Loa is again in eruption, and that all the craters in the vicinity have become active.

IN the December number of the *Mineralogical Magazine*, Prof. Macadam gives the analysis of a sample of talc used in paper-making. This mineral is obtained from New Jersey. It is very largely employed for paper-making in place of China clay (kaolin), and gives, amongst other advantages, a much more pure effluent, fully 90 per cent. being retained in the paper. From its fibrous nature it appears to attach itself to the smaller paper particles, and retain these also. The very high and beautifully smooth glaze of the American papers is largely due to the use of this substance.

IN the *Mittheilungen* of the Zürich Antiquarian Society (Band xxii. Heft 1) will be found a detailed account of the recently-discovered lake-dwelling at Wallishafen, on the Lake of Zürich. The articles found were mainly bronze, but underneath the existing remains appear to be the charred fragments of an earlier dwelling, the remains of which clearly belong to the Stone Age.

A LARGE canoe, belonging to prehistoric times, was lately dragged from the bottom of the River Cher, near Vierzon, and is now in the Museum of the Society of Antiquaries at Bourges. A part of it had been visible for many years at low water, but no one understood what it was until it happened to be seen by M. Beauchard, who at once perceived its real character. When it was brought to land, fragments which had been torn or cut off by peasants were recovered and pieced together. The canoe is in the form of a trough, and is said to have a general resem- blance to the ancient boat found some time ago at Brigg, in Lincolnshire. The present specimen has the special charac- teristic of being closed at both ends by pieces of wood fixed in vertical grooves. This device seems to have been adopted in consequence of the boat having been injured by some accident.

M. GUILMETH, the French traveller, while on a journey in Australia, discovered some bee-hives in a gigantic eucalyptus- tree, of 120 metres in height. The honey was strongly scented with the perfume of the flowers of the tree. Prof. Thomas Karaman has examined it, and believes it to have beneficial medicinal properties.

LIKE the authorities of the National Museum, Washington, the Curators of the Museum of the Academy of Natural Sciences, Philadelphia, complain that they have not nearly room enough for the display of the collections entrusted to their charge. "It is well within the truth," they state in their Report for 1886, "to say that the existing collections, if properly displayed, would completely fill a building of twice the dimensions of the present one. The large and very valuable collections of the Pennsylvania Geological Survey, contained in upwards of 200 cases, still remain in the cellar, boxed, for want of exhibition space. The types of the greater number of the fossil plants described by Lesquereux in his 'Coal Flora of the United States,' probably one of the most valuable collections of fossil plants in the world, have been added to this collection during the year, but, for similar reasons, still remain boxed. The report of the Professor of Ethnology and Archæology indicates that accessions to this department of the Academy's Museum could readily be had were proper exhibition space provided, but that under present conditions the same is impossible. In view of these facts the necessity for an extension to the Academy's building cannot be too strongly insisted upon." The Curators also urge that a fund should be raised for zoogeographical exploration. The interest derived from 50,000 dollars would, they think, fairly equip an annual expedition to any of the largely-unexplored regions lying about the dominions of the United States, such as Mexico, Central America, the Bahamas, and Labrador.

MR. ARTHUR J. BETHELL has reprinted, with additions and corrections, three articles which lately appeared in the *Field*, on a ride to the Falls of Zambesi. He has added a number of notes which may be of considerable service to men who think of spending some time in hunting in South Africa.

It was decided some time ago that a number of the Crown diamonds of France should be sold. Others were put aside for the collections of the Paris School of Mines and Museum of Natural History; and these gems were recently given to the delegates appointed by the two Schools. The Regent diamond, a very fine one, will be kept in the Louvre Gallery.

THE additions to the Zoological Society's Gardens during the past week include a Bonnet Monkey (*Macacus sinicus*), a Macaque Monkey (*Macacus cynomolgus*) from India, presented by Miss E. James; a Three-striped Paradoxure (*Paradoxurus trivirgatus*) from India, presented by Mr. Gerald Callinder; a Common Squirrel (*Sciurus vulgaris*), British, presented by Miss May Honrott; a Scop's Owl (*Scops qui*), captured at sea near Aden, presented by Mr. W. M. Holland; a White-fronted Heron (*Ardea nova-hollandia*) from Australia, presented by Mr. J. B. Dyas; a Stanley Parrakeet (*Platyercus icterotis*) from West Australia, a Burmeister's Cariama (*Chunga burmeisteri*) from South-East Brazil, a Black Sternothere (*Sternotherus niger*) from West Africa, received in exchange; two Smews (*Mergus albellus* ♂ ♀), European, purchased.

OUR ASTRONOMICAL COLUMN

COMET 1887*b* (BROOKS, JANUARY 22).—The following ephemeris for this object is by Dr. R. Spitaler (*Astr. Nach.* No. 2773).

1887	R.A.	Decl.	Brightness
Berlin midnight	h. m. s.		
March 4 ...	3 37 51 ...	51 48'5" N. ...	1'19
6 ...	3 43 32 ...	49 39'6" ...	1'15
8 ...	3 46 11 ...	47 35'1" ...	1'12
10 ...	3 53 33 ...	45 35'2" ...	1'08
12 ...	3 58 3 ...	43 39'9" ...	1'04
14 ...	4 2 17 ...	41 49'3" N. ...	1'00

The brightness on January 25 is taken as unity.

COMET 1887*c* (BARNARD, JANUARY 23).—Dr. H. Oppenheim gives (*Astr. Nach.* No. 2773) the following ephemeris for Berlin midnight for this comet:—

1887	R.A.	Decl.	log r	log Δ	Brightness
	h. m. s.				
March 10	21 36 44	51 59'4" N.	0.3182	0'3700	0'6
14	21 52 56	53 51'0"	0'3259	0'3775	0'6
18	22 9 39	55 34'6"	0'3335	0'3855	0'5
22	22 26 51	57 10'3"	0.3411	0'3938	0'5
26	22 44 30	58 37'8"	0'3486	0'4025	0'4
30	23 2 32	59 57'2" N.	0'3560	0'4113	0'4

The brightness at discovery is taken as unity.

COMET 1887*d* (BARNARD, FEBRUARY 15).—Prof. Boss supplies the following elements and ephemeris for this object from observations made on February 16, 18, and 20:—

T = 1887 April 6.77 G.M.T.

$$\begin{aligned} \pi &= 203 \frac{13}{16} \\ &= 139 \frac{16}{2} \end{aligned} \left. \vphantom{\begin{aligned} \pi \\ &= 139 \frac{16}{2} \end{aligned}} \right\} \text{Mean Eq. 1887}^\circ$$

$$\log q = 9.8892$$

Ephemeris for Greenwich Midnight

1887	R.A.	Decl.	Brightness
	h. m.		
March 2 ...	3 56'7" ...	29 21' N. ...	0'38
4 ...	3 40'0" ...	31 18"
6 ...	3 26'5" ...	32 48' N. ...	0'32

The brightness at discovery is taken as unity.

A METHOD FOR THE DETERMINATION OF THE CONSTANT OF ABERRATION.—M. Loewy, in reply to M. Houzeau's claim to be considered the originator of the method for determination of aberration by measurement of the relative positions of two stars situated in distant parts of the sky (*NATURE*, vol. xxxv. p. 377) points out, in the *Comptes rendus*, tome civ. No. 7, that the invention of a new method for the determination of the constant of aberration does not consist in a general indication of the effect of aberration on a certain observation or combination of observations, but in furnishing definite rules the following out of which will lead to results of the accuracy demanded by the exigencies of modern science. M. Loewy maintains that M. Houzeau's researches on the subject come under the former category, whilst his own are entitled to be ranked under the latter.

The same number of the *Comptes rendus* contains a note by M. Trépiéd pointing out how photography can be applied for the purpose of practically carrying out M. Loewy's method.

THE HARVARD COLLEGE OBSERVATORY.—From Prof. Pickering's Report, presented on December 7, 1886, we learn that during the past year the east equatorial has been used for the photometric observation of the eclipses of Jupiter's satellites upon the system adopted in 1878. The total number of eclipses thus observed is 358, of which 39 have occurred since the end of October 1885. With the same equatorial the observation of comparison stars for variables with the wedge photometer has been continued, and has formed the principal work of the instrument. The "new" stars in Orion and Andromeda, and comets, have also been observed with the east equatorial throughout the year. The reduction and publication of work already done with the meridian-circle is at present, in Prof. Pickering's opinion, more desirable than the prosecution of new series of observations. This department of the Observatory has sustained a heavy loss in the resignation of Prof. Rogers, who has devoted many years to laborious astronomical work at Harvard College. During the year ending November 1, 1886, 209 series of measures have been made with the meridian-photometer. The total number of separate photometric comparisons is 59,800. The instrument continues to give entire satisfaction as a means of measuring the brightness of stars of the ninth magnitude or brighter. The average deviation of 100 circumpolar stars used as standards, which, with the smaller instrument of the same kind employed in the Harvard photometry, was 0'16 of a magnitude, has been reduced to 0'12 with the present instrument; whilst the average deviation of stars from the fifth to the ninth magnitude but little exceeds 0'1 of a magnitude. And a comparison between the results obtained by Dr. Lindemann, at Pulkowa, with a Zöllner photometer, and at Harvard College, with the meridian-photometer, shows that the average deviation of a measurement of the difference in brightness between two stars observed at both places does not exceed 0'1 of a magnitude. For an account of the interesting and import-

researches in stellar photography which have recently been tried out at the Harvard College Observatory, see NATURE, xxxv. p. 37.

NEW MINOR PLANET.—A new minor planet, No. 265, was covered on February 27, by Herr Palisa, at Vienna. This is fifty-eighth that Herr Palisa has discovered.

ASTRONOMICAL PHENOMENA FOR THE WEEK 1887 MARCH 6-12

OR the reckoning of time the civil day, commencing at Greenwich mean midnight, counting the hours on to 24, here employed.)

At Greenwich on March 6

Mercury rises, 6h. 37m.; souths, 12h. 11m. 28" S.; sets, 17h. 46m.; decl. on meridian, 5° 40' S.; Sidereal Time at Sunset, 4h. 43m.

Venus (Full on March 9) rises, 13h. 39m.; souths, 21h. 29m.; sets, 5h. 10m.*; decl. on meridian, 17° 4' N.

Planet	Rises h. m.	Souths h. m.	Sets h. m.	Decl. on meridian
Mercury	6 54	13 15	19 36	3 22 N.
Venus	7 20	13 35	19 50	2 16 N.
Mars	7 0	12 54	18 48	1 58 S.
Jupiter	22 19*	3 21	8 23	12 2 S.
Saturn	12 2	20 11	4 20*	22 28 N.

* Indicates that the rising is that of the preceding evening and the setting of the following morning.

Occultations of Stars by the Moon (visible at Greenwich)

Star	Mag.	Disap.	Reap.	Corresponding angles from vertex to right for inverted image
α Geminorum	6	0 41	1 40	131 289
β Leonis	6	4 1	4 39	67 337
γ Leonis	6	18 24	19 14	68 185
δ Leonis	4	20 50	21 54	61 111
ε Leonis	6	22 53	near approach	332 —
ζ Virginis	2½	3 7	3 40	145 210
B.A.C. 4277	6	4 22	near approach	186 —

Mercury stationary.
Jupiter in conjunction with and 3° 34' south of the Moon.

Saturn, March 6.—Outer major axis of outer ring = 44" 0; inner minor axis of outer ring = 18" 3; southern surface visible.

Variable Stars

Star	R.A.	Decl.	h. m.
Cephei	0 52.3	81 16 N.	Mar. 7, 19 36 m
Arietis	1 58.6	11 59 N.	6, M
Cancer	8 50.2	20 17 N.	9, m
Ursæ Majoris	10 36.7	69 22 N.	11, M
Virginis	12 8.8	5 24 S.	7, M
Ursæ Majoris	12 39.0	61 43 N.	10, M
Virginis	13 20.2	2 48 S.	12, 5 o M
Libræ	14 54.9	8 4 S.	9, 23 39 m
Coronæ	15 13.6	32 4 N.	6, 18 46 m
Scorpii	16 10.9	22 40 S.	11, M
Ophiuchi	17 10.8	1 20 N.	7, 5 46 m
and at intervals of 20 8			
Sagittarii	18 25.2	19 12 S.	Mar. 9, 3 o m
Ursæ	18 45.9	33 14 N.	9, 1 o m
Ursule	19 43.8	27 0 N.	12, M
Ursule	19 46.7	0 43 N.	9, 5 o m
Cephei	22 25.0	57 50 N.	12, 0 o m

M signifies maximum; m minimum.

ON RADIANT-MATTER SPECTROSCOPY:—EXAMINATION OF THE RESIDUAL GLOW

THE duration of phosphorescence after cessation of the exciting cause is known to vary within wide limits of time, in several hours in the case of the phosphorescent sulphides to minute fraction of a second with uranium glass and sulphate of zinc. In my examinations of the phosphorescent earths glow-

Paper read before the Royal Society by Mr. William Crookes, F.R.S., Feb. 17.

ing under the excitement of the induction discharge *in vacuo*, I have found very great differences in the duration of the residual glow. Some earths continue to phosphoresce for an hour or more after the current is turned off, while others cease to give out the light the moment the current stops. Having succeeded in splitting up yttria into several simpler forms of matter differing in basic power (Roy. Soc. Proc. vol. xl. pp. 502-509, June 10, 1886), and always seeking for further evidence of the separate identity of these bodies, I noticed occasionally that the residual glow was of a somewhat different colour to that it exhibited while the current was passing, and also that the spectrum of this residual glow seemed to show, as far as the faint light enabled me to make out, that some of the lines were missing. This pointed to another difference between the yttrium components, and with a view to examine the question more closely I devised an instrument similar to Becquerel's phosphoscope, but acting electrically instead of by means of direct light.

The instrument, shown in Fig. 1, A and B, consists of an opaque disk, *abc*, 20 inches in diameter, and pierced with twelve openings near the edge as shown. By means of a multiplying wheel, *d*, and band, *ef*, the disk can be set in rapid rotation. At each revolution a stationary object behind one of the apertures is alternately exposed and hidden twelve times. A commutator, *g* (shown enlarged at Fig. 1, B), forms part of the axis of the disk. The commutator is formed of a hollow cylinder of brass round a solid wooden cylinder. The brass is cut into two halves by a saw cut running diagonally to and fro round it, so as to form on each half of the cylinder twelve deeply cut teeth interlocking, and insulated from those on the opposing half cylinder by an air space about 2 mm. across. Only one half, *h h*, of the cylinder is used, the other, *i i*, being idle; it might have been cut away altogether were it not for some little use that it is in saving the rubbing-spring, *j*, from too great friction when passing rapidly over the serrated edge. To a block beneath the commutator are attached two springs, one, *k*, rubbing permanently against the continuous base of the serrated hemicylinder *h h*, and the other, *j*, rubbing over the points of the teeth of *h h*. By connecting these springs with the wires from a battery it will be seen that rotation of the commutator produces alternate makes and breaks in the current. The spring, *j*, rubbing against the teeth is made with a little adjustment sideways, so that it can be said to touch the points of the teeth only, when the breaks will be much longer than the makes, or it can be set to rub near the base of the teeth, when the current will remain on for a much longer time and the intervals of no current will be very short. By means of a screw, *l*, attached to the spring, any desired ratio between the makes and the breaks can be obtained. The intermittent primary current is then carried to an induction coil, *m*, the secondary current from which passes through the vacuum tube, *n*, containing the earth under examination. When the commutator, the coil-break, and the position of the vacuum tube are in proper adjustment, no light is seen when looked at from the front if the wheel is turned slowly (supposing a substance like yttria is being examined), as the current does not begin till the tube is obscured by an intercepting segment, and it ends before the earth comes into view. When, however, the wheel is turned more quickly, the residual phosphorescence lasts long enough to bridge over the brief interval of time elapsing between the cessation of the spark and the entry of the earth into the field of view, and the yttria is seen to glow with a faint light, which becomes brighter as the speed of the wheel increases.

To count the revolutions, a projecting stud, *o*, is fastened to the rotating axis, and a piece of quill, *p*, is attached to the fixed support, so that at every revolution a click is produced. With a chronograph watch it is easy in this way to tell the time, to the tenth of a second, occupied in ten revolutions of the wheel.

Under ordinary circumstances it is almost impossible to detect any phosphorescence in an earth until the vacuum is so high that the line spectrum of the residual gas begins to get faint; otherwise the feeble glow of the phosphorescence is drowned by the greater brightness of the glowing gas. In this phosphoscope, however, the light of glowing gas does not last an appreciable time, whilst that from the phosphorescent earth endures long enough for it to be caught in the instrument. By this means, therefore, I have been able to see the phosphorescence of yttria, for example, when the barometer gauge was 5 or 6 mm. below the barometer.

When the earth under examination in the phosphoscope is yttria free from samaria, and the residual emitted light is ex-

amined in the spectroscope, not all the bands appear at the same speed of rotation. At a slow speed the double greenish-blue band of $G\beta$ (545) first comes into view, closely followed by the deep blue band of $G\alpha$ (482). This is followed, on increasing the speed, by the bright citron band of $G\delta$ (574), and at the highest speed the red band of $G\zeta$ (619) is with difficulty seen.

The following are measurements of the time of duration of the

phosphorescences of the different constituents of yttrium. The wheel was first rotated slowly, until the first line visible in the spectroscopie attached to the phosphoscope appeared; the speed was counted, and it was then increased until the line next visible was seen. In this way the minimum speed of revolution necessary to bring each line into view was obtained, and from these data the duration of phosphorescence for each constituent

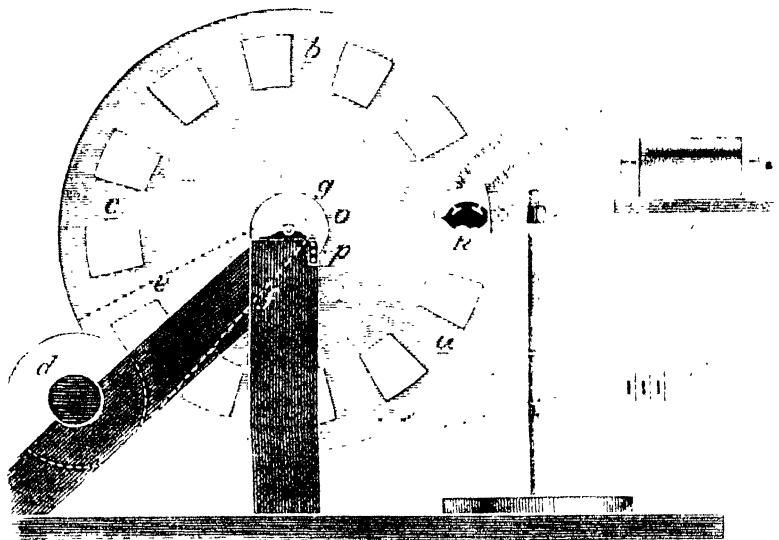

FIG. 1, A.

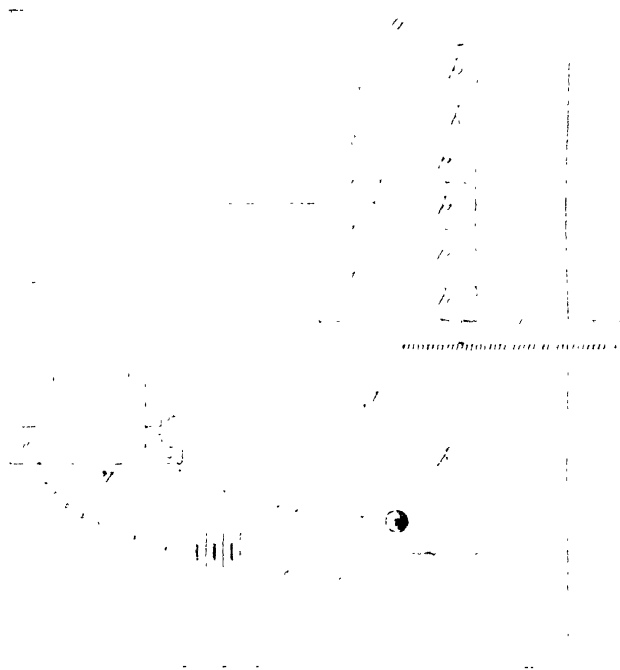

FIG. 1, B.

of yttria was calculated. The time in the following table represents in decimals of a second the time elapsing between the cessation of the induction discharge and the visibility of the residual glow of the earth:—

At 0'0035 sec. interval the green and blue lines of $G\beta$ and $G\alpha$ begin to be visible.

At 0'0032 sec. interval	the citron line of $G\delta$ begins to be visible.
At 0'00175	the deep red line of $G\zeta$ (647) is just visible.
At 0'00125	the line of $G\theta$ is almost as bright as that of $G\delta$, and the red line of $G\eta$ is visible.

0.000875 sec. interval the highest speed the instrument could be revolved with accuracy, the whole of the lines usually seen in the yttria spectrum could be seen of nearly their usual brightness.

have already recorded (Phil. Trans., 1883, Part III. 114-16), that phosphate of yttria, when phosphoresced in a tube, gives the green lines very strongly whilst the citron band is very faint. The same tube of yttric phosphate was now used in the phosphoscope. The green lines of G β soon faded themselves on setting the wheel into rapid rotation, but I was unable to detect the citron band of G δ even at a very high speed.

The effect of calcium on the phosphorescence of yttria and samarium has been frequently referred to in my previous papers. I save time if I summarise the results here. About 1 per cent of lime added to a badly phosphorescing body containing yttrium or samarium always causes it to phosphoresce well. It increases the sharpness of the citron line of G δ but increases in brightness. It also renders the deep blue line of G α extremely faint. The green lines of G β are diminished in brightness. Calcium also brings out the phosphorescence of samarium, although itself, or in the presence of a small quantity of yttrium, scarcely phosphoresces at all.

In the phosphoscope the action of lime on yttrium is seen to alter the order of visibility of the constituents of yttrium. A mixture of equal parts yttrium and calcium, the citron G δ is the first to be seen, then comes the G α blue line, then the green line, and finally the G η red line. This may, I think, be explained somewhat as follows:—Calcium sulphate has a residual phosphorescence, whilst yttrium sulphate has a comparatively short residual phosphorescence. Now with calcium, although the green phosphorescence of G β lasts longest, it does not last nearly so long as that of calcium sulphate. The residual vibrations of the calcium compound induce, in a mixture of calcium and yttrium, phosphorescence in those yttrium lines (G δ) whose vibrations it can assist, in advance of those (G β) to which it is antagonistic; the line of G δ therefore appears earlier in the phosphoscope than that of G β , although calcium not present the line of G β would appear first. Experiments were now tried with different mixtures of yttrium and calcium as ignited sulphates, to see where the special influence of calcium on G δ ceased.

Yttrium	Calcium	
Per cent.	Per cent.	
7½	2½	Order of appearance in the phosphoscope.—G β , G α , G δ , and G η . The citron line of G δ is only to be seen at a high speed, and is then very faint.
5	5	Order of appearance in the phosphoscope.—G α , G β , and G δ (citron and blue) together, and lastly G η (red). At a very high speed the green lines of G β become far more luminous than any other line.
0	10	Order of appearance.—G δ and G α together, then G β , and lastly G η .
0	20	Order of appearance.—G δ and G α simultaneously, then G β , and lastly G η . The residual phosphorescence lasts for 30 seconds after the current stops. The light of this residual glow is entirely that of G δ . The line of G β comes into view at an interval of 0.0045 second. At 0.00175 second the line of G η is just visible.
0	40	Order of appearance.—G δ and G α together, then G β and G η together.
0	50	
0	60	
0	70	
0	70	Order of appearance.—G δ , G α , G β .
0	90	
5	95	
1	99	

The action of barium on yttrium was now tried. The following mixtures (as ignited sulphates) were made:—

Yttrium	Barium	
Per cent.	Per cent.	
95	5	In the phosphoscope the G β line appears earliest, but the blue G α line is the next to be seen, whilst the red line of G η is the latest in appearing. As the percentage of yttrium increases the blue line more and more overtakes the red and increases in brightness.
90	10	
80	20	
70	30	
60	40	Spectrum similar to the above. As the percentage of yttrium increases the spectrum grows brighter. In the phosphoscope the earliest line to appear is the G β green, then the G η red, and next closely following it the G α blue.
50	50	
40	60	
30	70	
25	75	In the radiant-matter tube all these mixtures give similar spectra. The G β green is a little brighter and the G δ citron is a little fainter than in the corresponding mixtures of yttrium and calcium, but the whole of the yttrium lines are seen. In the phosphoscope the G β green is the first to appear, then the G η red. The G δ citron is not visible at any speed.
20	80	
15	85	
10	90	
5	95	Red line of G η is much brighter; G δ is very faint, and the green of G β is stronger. In the phosphoscope the order of appearance is,—first the line of G β , then the red line of G η .
1	99	
0.5	99.5	

The next experiments were tried with strontium, to see what modification the addition of this body to yttrium would produce. The following mixtures of ignited sulphates were experimented with:—

Yttrium	Strontium	
Per cent.	Per cent.	
95	5	A very good yttrium spectrum. In the phosphoscope the order of appearance is,—first the green of G β , then the G α blue, lastly the G η red. No G δ citron line could be seen.
80	20	In the phosphoscope the green of G β is very prominent at a low speed, standing out sharply against a black background. With a higher velocity the G α and G η lines come into view.
60	40	The ordinary spectrum of this and the neighbouring mixtures is very rich in the citron line of G δ , but I entirely fail to see a trace of this line in the phosphoscope at any speed. The line of G β is the first to come, then the blue line of G α .
40	60	
35	65	At about this point a change comes over the appearance in the phosphoscope. The blue line of G α is now the earliest to appear, and it is followed by the G η red and G β green. No G δ line is seen.
25	75	These mixtures are very similar to each other in the phosphoscope. The line of G α comes first, next the G η line, then G β line. No G δ citron line has been seen in any of these mixtures.
15	85	
5	95	
0.5	99.5	

In a paper read before the Royal Society, June 18, 1885; (Phil. Trans., 1885, Part II., p. 716), I described the phos-

phorescence spectrum given by a mixture of 61 parts yttrium and 39 parts of samarium, and illustrated it by a coloured lithograph. Also in a paper read before the Royal Society, February 25, 1886 (Roy. Soc. Proc. vol. xl. p. 236), I described and figured the phosphorescent spectrum of an earth obtained in

the fractionation of yttria which was identical, chemically and spectroscopically, with an earth discovered by M. de Marignac, and provisionally called by him Y_a . I repeat here these spectra, and the spectrum of yttrium added for comparison. Omitting minor details, it is seen that the Y_a spectrum is identical with

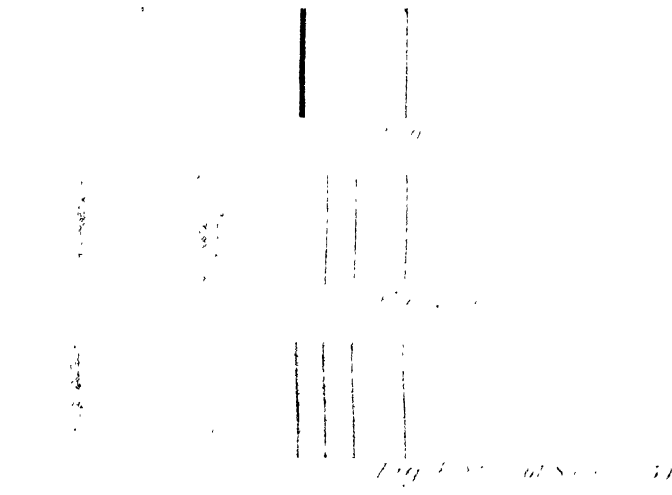

that of the mixture yttrium 61, samarium 39, with one important exception—the citron line of $G\delta$ in the former spectrum is absent in the latter. Could I by any means remove $G\delta$ from the mixture of yttrium and samarium the residue would be Y_a . I have little doubt that this will soon be accomplished, but in the meantime the phosphoscope enables us to remove the line of $G\delta$ from the

mixture. It is only necessary to add strontium to a suitable mixture of yttrium and samarium and view the phosphorescing mixture in the instrument when the wheel is rotating rapidly, to obtain a spectrum which is indistinguishable from that of Y_a .

(To be continued.)

PRE-SCIENTIFIC THEORIES OF THE CAUSES OF EARTHQUAKES

IN the course of a lecture delivered recently before the Rigaku Kyōkai, or Science Society of Tokio, on the causes of earthquakes, Prof. Milne classified the theories as to the cause of these phenomena into three kinds—unscientific, quasi-scientific, and scientific. In the former class he included the explanations of the Negro preachers at Charleston after the late earthquake there, that they occurred in consequence of the wickedness of the population. The Mussulmans in Java recently prayed to the volcanoes there to cease their shakings, at the same time promising reformation of life. That earthquakes are the direct result of man's wickedness is an idea that has always been common. About 1750 earthquakes were felt in many parts of Europe, which were widely attributed to this cause, and innumerable sermons were preached inculcating the lesson that if mankind would live better lives there would be no more earthquakes. In 1786, after a shock at Palermo, the people are recorded to have gone about scourging themselves, and looking extremely humble and penitent. An English poem called "The Earthquake," published in 1750, alleged, in somewhat halting verse, that the disturbances were not due to an unknown force, nor to the groanings of the imprisoned vapours, nor yet to the shaking of the shores with fabled Tridents:—

"Ah no! the tread of impious feet
The conscious earth impatient bears
And shuddering with the guilty weight,
One common grave for her bad race prepares."

From this theory, which can scarcely have satisfied the poet himself, Prof. Milne passed on to the myths which attribute earthquakes to a creature living underground. In Japan it is an "earthquake-insect" covered with scales, and having eight legs, or a great fish having a certain rock on his head which helped to keep him quiet. In Mongolia the animal was said to be a frog, in

India the world-bearing elephant, in the Celebes a world-supporting hog, in North America a tortoise. In Siberia there was a myth, connected with the great bones found there, that these were the remains of animals that lived underground, the trampling of which made the ground shake. In Kamchatka the legend was connected with a god, Tuil, who went out hunting with his dogs. When these latter stopped to scratch themselves, their movements produced earthquakes. In Scandinavian mythology, Loki, having killed his brother Baldwin, was bound to a rock face upwards, so that the poison of a serpent should drop on his face. Loki's wife, however, intercepted the poison in a vessel, and it was only when she had to go away to empty the dish that a few drops reached him and caused him to writhe and shake the earth. The lecturer had no means of collecting the fables of the southern hemisphere; but they would obviously be worth knowing for purposes of comparison. As to quasi-scientific theories, these endeavoured to account for earthquakes as parts of the ordinary operations of Nature. It was supposed, for instance, that they were produced by the action of wind confined inside the earth. The Chinese philosophers said that Yang, the male element, entered the earth and caused it to expand, and to shake the ground in its efforts to escape. Its effects would be more violent beneath the mountains than in the plains, and therefore earthquakes in the north of China, which was mountainous, were said to be more violent than those in the south. It was supposed that when the wind was blowing strongly on the surface of the earth, there was calm beneath, and *vice versa*. Aristotle and many other classical writers attributed earthquakes to wind in the earth. Shakespeare, in "Henry IV.," speaks of the teeming earth being pinched and vexed with a kind of colic by the imprisoning of unruly wind within her womb. Then came the theory of electrical discharges, which was advocated in 1760 by Dr. Stukely, as well as by Percival and Priestley. They are strongly held in California at the present day, where it was believed that the network of rails

ted the State against any dangerous accumulation of elec-
 . But Prof. Milne showed that the laying down of rails
 an had no such effect. He thought the electric pheno-
 which sometimes attended earthquakes were their conse-
 es, not their causes. He had himself experimented with
 nite placed in a hole; an earth-plate was fixed about thirty
 away from the dynamite, and from it a wire was carried
 distance to another earth-plate. When the dynamite charge
 xploded there was certainly a current produced, as was
 ted by a strong deflection of a galvanometer-needle at the
 f the wire. He attributed this to chemical action. When
 round was shaken there was always a greater or less action
 crease or decrease of pressure in connection with the earth-
 Earth currents unquestionably accompany earthquakes,
 as has been said, they appear to be the consequences, not
 causes, of the latter. Next came the chemical theories,
 1 were very strong in Europe up to the beginning of the
 nt century. It was imagined that underground there were
 us substances, such as sulphur, nitre, vitriol, which, by
 action on each other, resulted in violent changes, giving
 o vapour, the sudden production of which, in certain cases,
 l shake the ground. It was only in 1760 that Dr. Mitchell,
 wrote a good deal on the subject, first threw out the theory
 earthquakes were connected in some way with volcanoes,
 use they were most frequent in volcanic countries. He
 ved that large quantities of steam were given off from vol-
 as, and came to the conclusion that an earthquake was
 iced at the time that an attempt was made to form a vol-
 . that steam got in between certain strata, and, as it ran
 een them, caused pulsations. Prof. Rogers, about the same
 in North America, endeavoured to show that it was not
 1, but really lava, that ran along underneath the ground,
 ng it to rise and fall, thus producing an earthquake. Prof.
 e having thus dealt with unscientific and quasi-scientific
 ies, passed on to those of modern science. It is unneed-
 here to follow him into this portion of his subject, although it
 pied the main part of the lecture.

THE EFFECT OF CERTAIN STIMULI ON VEGETABLE TISSUES¹

HE object of our paper is to describe the behaviour of
 turgescient pith when placed in water and treated with
 in reagents. If from a growing shoot the external tissues
 emoved, a well-known result is seen: the pith suddenly
 ens, becoming longer than the specimen was at first. This
 riment shows that turgescient pith is normally in a compressed
 ition—it is always trying to get longer—and when it is freed
 the coercion of the unyielding external tissues, it at once
 become longer. This tendency to become longer is further
 fested by allowing turgescient pith to remain in damp air, or
 ater, for some time, when a great increase in length takes
 . In such a piece of pith we have the essential, active factor
 owth, freed from interference, and at liberty to perform its
 ion rapidly and freely. The tendency in turgescient pith to
 onger is the very power which calls forth that increase in
 h which we call growth; so that in studying turgescient pith
 re studying the active agent in the production of growth.
 do not suppose that our results are necessarily directly ap-
 plicable to normal growth,² but we think that they have a
 ing on normal growth sufficiently close to give interest to our
 riments.

ie pith,³ after being cut into pieces about 6 inches in length
 ½ inch in thickness, was ready for use. The lower end of
 ith was fixed to a hook at the bottom of a narrow jar, the
 r end was attached by a silk thread to the short arm of an
 ometer lever. The jar was then filled with water, and as
 ith elongates the short arm of the lever ascends and the
 arm rapidly descends. Its movement, read off on a milli-
 e scale, gives an index of the rate of "growth" of the pith.
 lengthening of the pith is, in fact, observed like the normal
 th of a plant, the only difference being that the "growth"
 e pith is so rapid that the descent of the long arm is clearly
 le to the naked eye and is correspondingly easy to measure.
 most striking to see the index travelling down thus quickly

abstract of a Paper by Anna Bateson (Newnham College) and Francis
 in (Cambridge), read before the Linnean Society, January 20, 1887,
 or the sake of convenience we shall nevertheless use the word
 with " to mean the elongation of the pith under observation.
 unflower and Jerusalem Artichoke.

and traversing (it may be) 10 mm. ($\frac{3}{8}$ inch) in a minute. We
 used a stop-watch to determine the time in which the point of
 the long arm of the lever travelled over a certain distance, and
 we could thus estimate the changes in the rate of growth from
 minute to minute.

The first thing needful to know is the ordinary course of
 growth of the pith in water. It was found that an interesting
 phenomenon—an apparent *grand period*—takes place. That is
 to say, the growth is at first slow, then more rapid, and ultimately
 becomes slow again, the whole period taking perhaps twenty
 minutes to complete. This is precisely the series of changes
 which a growing organ exhibits in the course of days instead of
 minutes. We do not suppose that our grand period is necessarily
 of a kindred nature to the grand period of normal growth. For
 we are aware that purely mechanical processes, such as the
 moistening of a hygroscopic awn, exhibit the same thing—
 the awn at first untwists slowly, then more quickly, and then
 again slowly. But the knowledge of the fact is of great import-
 ance to us, since unless we know the normal course of growth
 we cannot study the effect of reagents.

Warmth.—Before going on to consider the action of reagents,
 we will say a few words as to the stimulation caused by an
 increase in the surrounding temperature. If the water in the
 jar is gradually warmed, the growth of the pith increases in
 speed in the most striking manner. The increase is fairly steady
 from, say, 17° C. to about 35°, the rate at this latter tempera-
 ture being perhaps four times as high as it was at first. It then
 usually becomes irregular, with some diminution; and, just
 before a temperature is reached which kills the tissues, a sudden
 and rapid fall in the rate of growth sets in. This we found
 usually to occur at about 55° C. This is, no doubt, an unusually
 high temperature, but not higher than plants are known to be
 able to survive.

The chief interest in these temperature experiments is this:
 they show that the phenomena we are considering is a truly vital
 one. We have always been on our guard in this matter, and
 have wished to make certain that the observed phenomena are
 not in some mysterious way mechanical, instead of, as we
 believe, the response of living tissues as living tissues. There-
 fore, when we find that heat has a normal effect on our material,
 we are encouraged to believe that our other results—to which
 we now pass on—are also vital phenomena.

Alcohol.—The pith was attached to the auxanometer, and the
 jar filled with water. As soon as the rate of growth was found
 to be steadily diminishing, a small quantity of alcohol was added.
 The result was an immediate and striking increase in the rate of
 growth. For instance, when 2 per cent. of spirit was added,
 the growth was accelerated within two minutes by 50 per cent.

The result is temporary, so that in the course of another two
 minutes the rate of growth sinks to what it was before stimu-
 lation. Similar results were obtained with ether, and here the
 pith was allowed to grow in damp air, and was subjected to ether
 in the form of vapour. When the vapour was present in the
 proportion of 0.27 per cent., the acceleration was 56 per cent.;
 with 0.4 per cent., the acceleration was 100 per cent. Here, as
 in the case of alcohol, the result was temporary, the rate falling
 in a few minutes to what it was before stimulation.

When the ether amounts to 3 per cent. of the atmosphere,
 the pith is killed, and shows no increase, but, on the contrary,
 a decrease¹ in length. Elfving has shown that ether has a
 stimulating effect on respiration, and on the sensitiveness of
 swarm-spores to light. He also tested its effect on the growth
 of phycomyces. His results differ from ours, inasmuch as he
 found no stimulating effect: the ether produced either no
 effect whatever, or else it retarded, or even stopped, growth.

Ammonia.—We employed the *Liquor Ammoniac fortior* of
 the "British Pharmacopœia" for the preparation of our solu-
 tions, and we found that various strengths ranging between 0.5
 and 2.4 per cent. produced acceleration of growth. Here
 again, as with ether and alcohol, the acceleration was very
 temporary.

Acids.—As a rule, acids produced no acceleration, but caused
 either retardation, or flaccidity and death. Thus, for instance,
 acetic acid (0.5 and 1 per cent.) produced retardation; 5.4 per
 cent. produced death.

Hydrocyanic Acid did not cause flaccidity such as we
 have described in the case of acetic acid. The action of this
 reagent is comparable rather to that of alcohol, but is not

¹ This contraction is simply a symptom of flaccidity, and usually of death.

identically the same. It produces either a temporary acceleration, such as is due to alcohol, or else a remarkably steady and high rate of growth. On the action of this reagent we hope to make further observations.

Quinine Chloride.—Extremely dilute solutions acted poisonously, and produced a shortening of the tissues. When contraction took place it was manifested within a remarkably short time. In one case contraction seemed to begin simultaneously with the exposure to the poison, and was certainly well marked in less than one minute.

Conclusion.—The most interesting fact which we have established is the possibility of stimulating turgescient tissues to increased elongation by such reagents as alcohol, ether, and hydrocyanic acid. And we incline to think that our results may help to direct attention to a factor in the problem of cell-mechanism—namely, the protoplasmic element, rather than the purely osmotic side of the question.

SOCIETIES AND ACADEMIES

LONDON

Royal Society, February 24.—"On the Relation between Tropical and Extra-Tropical Cyclones." By the Hon. Ralph Abercromby. Communicated by Mr. R. H. Scott, F.R.S.

All cyclones have a tendency to assume an oval form: the longer diameter may lie in any direction, but has a decided tendency to range itself nearly in a line with the direction of propagation. Tropical cyclones have less tendency to split into two, or to develop secondaries than those in higher latitudes. A typhoon which has come from the tropics can combine with a cyclone that has been formed outside the tropics, and form a single new, and perhaps more intense, depression. There is much less difference in the temperature and humidity before and after a tropical cyclone than in higher latitudes. The quality of the heat in front is always distressing in every part of the world.

The wind rotates counter-clockwise round every cyclone in the northern hemisphere, and everywhere as an ingoing spiral. The amount of incurvature for the same quadrant may vary during the course of the same cyclone; but in most tropical hurricanes the incurvature is least in front, and greatest in rear; whereas in England the greatest incurvature is usually found in the right front. Some observers think that broadly speaking the incurvature of the wind decreases as we recede from the equator. The velocity of the wind always increases as we approach the centre in a tropical cyclone; whereas in higher latitudes the strongest winds and steepest gradients are often some way from the centre. In this peculiarity tropical cyclones approximate more to the type of a tornado; but the author does not think that a cyclone is only a highly developed whirlwind, as there are no transitional forms of rotating air.

The general circulation of a cyclone, as shown by the motion of the clouds, appears to be the same everywhere. All over the world, unusual coloration of the sky at sunrise and sunset is observed, not only before the barometer has begun to fall at any place, but before the existence of any depression can be traced in the neighbourhood. Cirrus appears all round the cloud area of a tropical cyclone, instead of only round the front semicircle, as in higher latitudes. The alignments of the stripes of cirrus appear to be more radial from the centre in the tropics, than tangential, as indicated by the researches of Ley and Hildebrandsson in England and Sweden respectively. Everywhere the rain of a cyclone extends farther in front than in rear. Cyclone rain has a specific character, quite different from that of showers or thunderstorms; and this character is more pronounced in tropical than in extra-tropical cyclones.

Squalls are one of the most characteristic features of a tropical cyclone, where they surround the centre on all sides; whereas in Great Britain, squalls are almost exclusively formed along that portion of the line of the trough which is south of the centre, and in the right rear of the depression. As, however, we find that the front of a British cyclone tends to form squalls when the intensity is very great, the inference seems justifiable that this feature of tropical hurricanes is simply due to their exceptional intensity.

A patch of blue sky, commonly known as the "bull's-eye," is almost universal in the tropics, and apparently unknown in higher latitudes. The author's researches show that in middle latitudes the formation of a "bull's-eye" does not take place when the

motion of translation is rapid; but as this blue space is not observed in British cyclones when they are moving slowly, it would appear that a certain intensity of rotation is necessary to develop this phenomenon.

The trough phenomena,—such as a squall, a sudden shift of wind, and change of cloud character and temperature, just as the barometer turns to rise, even far from the centre—which are such a prominent feature in British cyclones,—have not been even noticed by many meteorologists in the tropics. The author, however, shows that there are slight indications of these phenomena everywhere; and he has collated their existence and intensity with the velocity of propagation of the whole mass of the cyclone.

Every cyclone has a double symmetry. One set of phenomena, such as the oval shape, the general rotation of the wind, the cloud ring, rain area, and central blue space, are more or less related to a central point. Another set, such as temperature, humidity, the general character of the clouds, certain shifts of wind, and a particular line of squalls, are more or less related to the front and rear of the line of the trough of a cyclone. The author's researches show that the first set are strongly marked in the tropics, where the circulating energy of the air is great, and the velocity of propagation small; while the second set are most prominent in extra-tropical cyclones, where the rotational energy is moderate, and the translational velocity great. The first set of characteristics may conveniently be classed together as the rotational, the second set as the translational, phenomena of a cyclone.

Tropical and extra-tropical cyclones are identical in general character, but differ in certain details, due to latitude, surrounding pressure, and to the relative intensity of rotation or translation.

Linnean Society, February 17.—Mr. W. Carruthers, F.R.S., President, in the chair.—The Rev. A. Johnson exhibited drawings of an abnormal *Begonia Veitchii* grown by him the preceding autumn. The peculiarity consisted in the flower having a single, large, flask-shaped, ovarian-like organ (?) placed centrally, and surmounted by a single, simple, straight style; thus, though doubtless a male, indicating an hermaphrodite condition, while presenting resemblances to the normal female organs of *Laurus nobilis*.—Mr. E. M. Holmes exhibited some irregularly-developed lemons, in which the carpels were more or less separated at the apex, the arrest of the normal union of the carpel being attributed to the bite of an insect in the early stage of the growth of the fruit.—There were exhibited, for Mr. J. G. Otto Tepper, a new *Styidium* (*S. Tepperiana*, F. Muell.), collected in November 1880 on Mount Taylor, Kangaroo Island, Victoria, Australia. It was found in the interstices of a Tertiary limestone. Other trees which grew in the neighbourhood were stunted Eucalypts, Hawkeas, and an Acacia somewhat resembling *A. pycnantha*.—Sir J. Lubbock drew attention to examples of *Peziza coccinea* from Hiacombe. A dried specimen of *Primula imperialis*, Jungh., collected by Dr. Sydney Hickson in Java, was exhibited from the Royal Gardens, Kew. This species is a giant form of *Primula*, being over 3 feet in height. Plants of this Himalayan and Malayan species are now under cultivation at Kew, and form an interesting addition to this popular group of garden plants.—Mr. G. Maw showed two rare Narcissi, both known under the name of *N. cernuus*. The daffodil discovered by Mr. Buxton in the Pyrenees at 7000 feet altitude is interesting as the only white form known in a wild habitat. A diminutive, orange-coloured species, flowered by the Rev. C. Wolley Dod from bulbs collected by Dr. Henriques, of Coimbra, appears to be allied to *N. triandrus*.—Sir J. Lubbock read the second part of his paper on phytobiological observations, and on the leaf of *Liriodendron*. In *Cenothera bisteria* the seed-leaves are linear, terminating in a large round expansion. There is nothing to account for it in the seed, nor does it appear to be of any advantage to the young plant. On watching the growth, however, and comparing it with that of other allied species, the explanation appears to be as follows: the cotyledons are at first round, but a growth takes place at the base of the cotyledon, which closely resembles that of the subsequent leaves, hence their peculiar figure in this species. In allied species the seed-leaves consist of two parts, a terminal portion—the true or original cotyledon—and a subsequent growth resembling in each species their true leaves. With reference to seed-leaves in which the stalks are connate, e.g. *Smyrniacum*, the union seems clearly advantageous as giving additional strength. Other characters in various species, *Plantago*, *Tilia*, *Heliohila*, *Carlamine*, &c., were instanced. As to the tulip-tree (*Lirio-*

Mendron), for long a puzzle by the peculiar saddle shape of the leaves, after testing various other suggestions which had proved untenable, Sir John described the structure of the bud and the manner in which the young leaves were packed in it, and showed that the peculiar manner in which the young leaves are arranged, satisfactorily accounts for the well-known and very remarkable form of the leaf.—A paper was read on *Dichelaspis pellucida*, by Dr. Hoek, of Leyden. The cirripede in question was got from the scales of a water-snake in the Mergui Archipelago by Dr. J. Anderson, and this is believed to be the first record of the species since Charles Darwin wrote his classic monograph on the group thirty-five years ago.

Zoological Society, February 15.—Prof. W. H. Flower, F.R.S., President, in the chair.—The Secretary read a report on the additions that had been made to the Society's Menagerie during the month of January 1887, and called special attention to two Blakiston's Owls (*Bubo blakistoni*) from Japan, presented by Mr. J. H. Leech; three Hooker's Sea-Lions (*Otaria hookeri*), presented by the Hon. W. J. M. Larnach, Minister of Marine of New Zealand; and a Blue Penguin (*Eudyptes minor*) from Cook's Straits, New Zealand, presented by Mr. Bernard Lawson.—Prof. F. Jeffrey Bell read a report on a collection of Echinodermata made in the Andaman Islands by Colonel Cadell. The collection was stated to contain 100 examples referable to 50 species.—Mr. G. A. Boulenger read a paper on a collection of Reptiles and Batrachians made by Mr. H. Pryer in the Loo Choo Islands. The author observed that exceptional interest attached to this collection, seeing that it was the first herpetological collection that had reached Europe from that group of islands. Two new species were described, viz. *Tachydromus smaragdinus* and *Tropidonotus pryeri*.—Mr. Oldfield Thomas read a paper on the small Mammals collected in British Guiana by Mr. W. L. Sclater. The collection contained thirteen specimens belonging to eight species, of which one was new; this the author proposed to describe as *Hesperomys (Rhipidomys) sclateri*.—Mr. G. A. Boulenger pointed out the characters of a new Geckoid Lizard from British Guiana. The specimen in question was contained in a small collection of Reptiles made by Mr. W. L. Sclater on the Pomeroon River. The author described it as *Gehnotodes annularis*.—A communication was read from Mr. Charles O. Waterhouse, containing an account of a new parasitic Dipterous Insect of the family Hippocidæ. The author stated that this insect had been found on a species of Swift (*Cypselus melanoleucus*), by Dr. R. W. Shufeldt, at Fort Wingate, New Mexico. It was closely allied to *Anapera pallida*, a European dipterous parasite found on *C. afus*, and was proposed to be named *Anapera pubriata*.—Mr. John H. Ponsoby communicated, on behalf of Mr. Andrew Garrett, the first part of a paper on the Terrestrial Mollusks of the Viti or Fiji Islands.—Mr. F. E. Beddard read a paper on the structure of a new genus of Lumbricidæ (*Thamnodrilus*) discovered by Mr. W. L. Sclater in British Guiana, which he proposed to characterise as *Thamnodrilus guelmi*.

Anthropological Institute, Feb. 8.—Mr. Francis Galton, F.R.S., President, in the chair.—A paper was read by Sir Charles Wilson on the tribes of the Nile Valley north of Khartoum. Sir Charles Wilson opened his paper by remarking on the extraordinary way in which the various races inhabiting the Nile Valley—with many of whom he had come in contact in the course of the Nile Expedition—had become mixed up, and how completely the indigenous population had in certain cases lost its nationality while absorbing its Arab conquerors. The tribes of the Nile Valley north of Khartoum might be divided into three groups, the Hamitic, the Semitic, and the Nuba, all alike claiming descent from the Korish of Mecca. Sir C. Wilson then proceeded to give briefly a history of the different tribes from the earliest times, describing in detail the peculiarities and physical characteristics of each race. A number of Soudanese weapons, lent by Sir Allen Young, were exhibited.

PARIS

Academy of Sciences, February 21.—M. Gosselin, President, in the chair.—Determination of the constant of aberration: first method of observation, by M. Lecmy. In this paper the author proceeds to explain successively the geometrical properties on which depend the various methods of estimating the constant of aberration. The first of the two processes is here dealt with, which, although somewhat less rigorous than the general method,

practically yield results of the greatest precision, while also enabling the observer to determine two other physical constants—the variation of refraction caused by change either of temperature or of atmospheric pressure.—Note on M. Faye's recent communication regarding waterspouts, by M. Mascart. M. Faye having again raised this question in connection with M. Weyher's experiments, the author returns to his original contention that the great body of observed phenomena are directly opposed to M. Faye's theory of cyclones.—On the development of the Pennatulæ (*Pennatula grisea*), and on the favourable biological conditions presented by the Arago Laboratory for zoological studies, by M. H. de Lacaze-Duthiers. A visit paid to the Arago station last October suggests some remarks on the flourishing condition of the Alcyonaria and Pennatulæ, which have become thoroughly acclimatised in this district. A general description is given of the laboratory and reservoir at the Fontaulé headland, which has been enlarged to a capacity of 130 cubic metres, offering every facility for the study of sponges, star-fish, tritons, and many other lower forms of marine life.—On the Alpine flora surviving in the Paris district, by M. A. Chatin. The author discusses the various hypotheses which trace this already described flora either to the Scandinavian or Swiss Alps or to the Pyrenees, and concludes generally that the Parisian highland flora is independent of all, and truly aboriginal. It is also contended that most of the present European vegetation goes no further back than the Quaternary formations, and that for plants there has been independent succession and plurality of centres of creation rather than widespread diffusion from a single centre.—On the orthobutyrate and isobutyrate of lime, by MM. G. Chancel and F. Parmentier. An exhaustive study of these substances shows that M. le Chatelier's approximate relation—

$$d \log \frac{k}{\delta} \approx \frac{d t}{T^2}$$

giving the variation of solubility of different bodies, with their heat of solution at saturation, cannot be regarded as the expression of a general law from which fresh deductions may be safely drawn.—On the red fluorescence of alumina (second notice), by M. Lecoq de Boisboudran. Here are treated two highly calcined aluminas + Cr₂O₃ and + Bi₂O₃, and a moderately calcined alumina + Bi₂O₃.—On the incubation of Phylloxera during the winter season, by M. A. L. Donnadieu. In reply to M. Balbiani, who holds that the Phylloxera of the oak completes the entire cycle of its evolution in a single year, the fertilised eggs hibernating during the ensuing winter, the author's researches lead to the conclusion that the activity of this organism is not interrupted during the period of suspended vegetation of the plant on which it lives. A like conclusion is arrived at as regards the Phylloxera of the vine, which on this plant continues without interruption, but with a somewhat diminished intensity, the biological evolutions of its summer life throughout the winter season.—Observations of Brooks's comet made at the Observatory of Toulouse, by M. Baillaud.—On Gauss's quadrature formula, and on Hermite's formula of interpolation, by M. P. Mansion.—On the orthogonal systems formed by the θ functions, by M. F. Caspary.—On the movements of the air, by M. Ch. Weyher. A series of experiments are described which have been carried out by means of a jet of air or vapour a demi-millimetre in diameter and inclined 45° to the horizon, holding in suspense two spheres, one of cork with a diameter of 20 mm., the other of caoutchouc inflated with air. The centre of gravity of the spheres is below the axis of the jet, which thus causes them to revolve round each other, while their weight is balanced by the attraction produced by the series of little eddies developed along the sides of the jet.—On a method of determining the induction flux traversing an electro-magnetic system, by M. R. Aronow. A simple method is described, by means of which this quantity may be accurately determined without the aid of the ballistic galvanometer, which is not available for practical purposes.—On the causes determining the phosphorescence of the sulphuret of calcium, by M. A. Verneuil. From the author's researches, which are still in progress, it appears that the violet sulphuret of calcium prepared from shells owes its bright phosphorescence to the salt of bismuth, the carbonate of soda, the sea-salt, and the sulphate of lime formed during the reaction.—Action of some metals on weak solutions of the nitrate of silver, by M. J. B. Senderens. It is shown that by acting on such solutions lead reduces the nitric acid while the silver is precipitated; also that analogous phenomena are presented by zinc,

iron, tin, cadmium, antimony, and aluminium.—Action of sulphuric acid on the solubility of the sulphates, by M. R. Engel. Sulphuric acid, acting on solutions of sulphates incapable of combining with it to form acid sulphates, determines a diminution of the solubility of the salt. But this is shown to take place according to a law different from that observed for the chlorides in presence of hydrochloric acid.—On the reproduction of the micas, by MM. P. Hautefeuille and L. Péan de Saint-Gilles. In this preliminary paper the authors confine themselves to some of their researches on the fusion of the elements of the micas with the fluosilicate of potassa.—Remarks on M. Boutroux's note regarding the action of nitric acid on sugar, by M. E. Maumene. M. Boutroux's statement that by the action of sugar and nitric acid he obtained saccharic acid and oxalic acid, but not hexepic acid, is shown to be erroneous.—On the treatment of new wines with sugar, by MM. D. Klein and E. Fréhou. The authors' experiments show the possibility of obtaining with alcohol of about the theoretic quantity right fermentations by means of which poor vintages may henceforth be converted into good wines capable of preservation.—A contribution to the study of the alkaloids, by M. Oechsner de Coninck.—Researches on the mode of action of colchicine taken as a therapeutic, and on the mechanism of this action, by MM. A. Mairet and Combemale. The authors' experiments show that this substance has the same diuretic or purgative action on men as on animals, but the former are three times more sensitive to its action than the latter.—Fresh studies on the embryogeny of the Nematodes, by M. Paul Hallez.—On the development of the Nematodes of the beetroot during the years 1885 and 1886, and on their modes of propagation, by M. Aimé Girard.—On the oscillations produced during the Eocene period in the Laval basin, by M. D. (Ehlert).—On the geological constitution of la Montagne-Noire, Castelnaudary district, by M. J. Bergeron.

BERLIN

Physical Society, January 21.—Prof. von Bezold in the chair.—Dr. König spoke of the disadvantages of the hydro-oxygen lamps, and demonstrated a new lamp constructed by Herr Linnemann, in which the unsteadiness in the light, arising from the fact that in the common lamp the flame burned now in the burning tube and now outside of it, was avoided. In the new lamp the coal-gas or the hydrogen issued from a ring-shaped opening in the burner, while the oxygen in the centre was admitted through a capillary tube and did not come into contact with the burning gas till outside of the burner. In the middle of the blue flame was seen a bright point which gave the heat-maximum. Instead of the lime cylinder, Herr Linnemann used in his lamp zircon plates, which, at the place of the bright point, gave a highly intense constant light. The speaker made use of this light in order, with the aid of the optical bench of Prof. Paalzow, to demonstrate by projection a long series of phenomena in connection with the doctrine of the polarisation of light. For all teaching purposes and demonstrations this method of representing the most important optical phenomena could not be surpassed by any other.—Dr. Lummer described the experiments of M. Macé de Lepinay, who by a new method had determined the wave-length of the ray of light D_2 , ascertaining, as he had done, by weighing, the volume of a quartz cube, the size of which was determined in units of the wave-lengths, and from the volume of the cube finding the length of the light-wave. The speaker showed a series of inaccuracies in the measurements of M. de Lepinay, and, in view of the fact that the wave-lengths of the rays of light were now measured with a precision of $1/60,000$, whereas the determination of the centimetre was affected with an uncertainty of $1/4000$, he purposed inversely ascertaining the length of the centimetre from the wave-length. The mode of procedure should be the same as that made use of by M. de Lepinay, yet several improvements in the measuring and weighing were stated, such as the speaker hoped to be able to effect later on.—Dr. Dieterici showed an apparatus designed by Prof. Köppen which enabled one to fill a barometer free of air very rapidly. An upright standing communicating-tube open at one end for the admission of the quicksilver issued at the other end in a capillary tube passing at the bottom into a vessel. The open leg of the siphon was longer than the other. On pouring in the quicksilver it rose uniformly in both legs, forced up the air in the closed leg and through the capillary outwards. When the closed leg was entirely filled with quicksilver, and yet more continued to be poured in, it drained itself off through the capillary, bearing along with it all the air, in the same manner as did the

Sprengel pump. The quicksilver became collected in the vessel and closed the lower opening of the capillary. vacuum was thus established, and in the closed leg of the

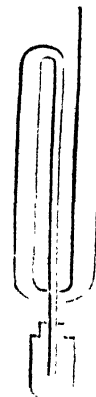

communicating-tube the quicksilver sank to barometer height.—I. H. W. Vogel presented photographs of coloured objects in the distinctness of their *muscles* perfectly corresponded the impression conveyed by the objects themselves to the eye. The speaker had, in conjunction with Herr Oberneth, succeeded in finding in eosin-silver a substance rendering the photographic plates most highly sensitive for the yellow-green light corresponding with the utmost sensitiveness of the retina for t rays. The photographs of solar spectra and different landscapes attested the excellence of this "sensibilisator."

CONTENTS

	P.
Endowment of Medical Research	
The Electric Motor. By Prof. Silvanus P. Thompson	
The Flora of Leicestershire. By J. G. Baker	
Geology of Jersey	
Our Book Shelf: —	
Sedgwick and Wilson: "General Biology"	
Letters to the Editor: —	
Industrial Studentships.—Colonel J. F. D. Donnelly, C.B.	
Top-shaped Hailstones.—C. S. Middlemiss. (<i>Illustrated</i>)	
Snowflakes.—Samuel Lockwood	
"Invisible at Greenwich."—A. C. Crommelin	
Lunar Halos.—Prof. S. T. Moreland	
The Beetle in Motion.—A. Wilkins	
A Recently-Discovered Deposit of Celestine.—R. H. Solly	
The Vitality of Seeds.—N. E. P.	
The Relations between Geology and the Mineralogical Sciences, II. By Prof. John W. Judd, F.R.S.	
Dr. William Traill, of Woodwick	
The Earthquake	
Notes	
Our Astronomical Column: —	
Comet 1887 <i>b</i> (Brooks, January 22)	
Comet 1887 <i>c</i> (Barnard, January 23)	
Comet 1887 <i>d</i> (Barnard, February 15)	
A Method for the Determination of the Constant of Aberration	
The Harvard College Observatory	
New Minor Planet	
Astronomical Phenomena for the Week 1887	
March 6-12	
On Radiant-Matter Spectroscopy:—Examination of the Residual Glow. By William Crookes, F.R.S. (<i>Illustrated</i>)	
Pre-Scientific Theories of the Causes of Earthquakes	
On the Effect of Certain Stimuli on Vegetable Tissues. By Miss Anna Bateson and Prof. Francis Darwin, F.R.S.	
Societies and Academies	

THURSDAY, MARCH 10, 1887

THE AURORA BOREALIS

Aurora Boréale. Étude générale des Phénomènes produits par les Courants électriques de l'Atmosphère.
Par M. S. Lemström. (Paris: Gauthier-Villars, 1886.)

Resultate der Polarlicht-Beobachtungen angestellt im Winter 1882 und 1883 auf den Stationen Kingua Fjord und Nain. Von Dr. K. R. Koch. (Berlin: A. Asher and Co., 1886.)

THE organised and obstinate scientific curiosity of our time has not neglected the beautiful phenomenon the "Polar Dawn." Yet its investigation is attended peculiar difficulties and discouragements. It can be profitably conducted only amid scenes of frozen desolation, in the grisly depths of Arctic winter nights, under conditions taxing man's energy and resource to live, to say nothing of observing. The appearances in question are, moreover, as elusive as they are surprising. They promptly kindle the imagination, but leave the understanding, unless prepared by special study to apprehend something of their causes, baffled and helpless. Nevertheless, auroral research, though Nature seem to frown upon it, has been pursued with indefatigable energy during the last half century. It has formed the principal object of some, it has occupied a prominent place in the programmes of all recent Polar expeditions; besides being furthered, with less heroic zeal, by writers and thinkers unequal or averse to the company of thermometers normally below the zero of Fahrenheit. Nor have these labours been thrown away. Much of the mystery long attaching to the evanescent splendours of Arctic skies has been dissipated. There is no longer any doubt as to the kind of explanation appropriate to them. Their laws and relationships have been, to a great extent, elucidated; a satisfactory theory of their origin is attained; and some circumstances of their occurrence, long in debate, have been attested on unquestionable authority.

An excellent specimen of the patient laboriousness by which these results have been brought about is afforded in the work of Dr. Koch, cited as one of our authorities. He was in sole charge of the German station of Nain, on the coast of Labrador, during the International Polar term 1882-83, and now presents us with the record of his observations there, together with those made simultaneously at the still more northerly post of Kingua Fjord. Although situated in about the latitude of Dundee—56° 33'—Nain appears to be, in point of climate, one of the grimmest localities accounted habitable on the face of the globe. Frost-bites were a quite common incident of Dr. Koch's daily experience; and various winds, rendering the use of his meteoroscope impossible, often left him dependent upon the natural features of the solemn but forbidding landscape, for determining the azimuths of auroral bands and arches. As regards these phenomena, indeed, the station is admirably located. It lies close to the southern edge of, not actually within, the zone of maximum frequency; auroræ are consequently numerous and intense, and appear almost indifferently above the northern or horizon. Their varying forms are beautifully

delineated in the drawings which lend a greatly increased value to Dr. Koch's publication. Multiple arches, up to the number of eight, were frequently seen; and the incessant movements affecting them, both as a whole and in their parts, the transverse flashing of the rays set side by side to compose some of them, the torrential rushing of light along the paths others seemed to prepare for it, as well as the restless wanderings of the entire luminous structure up and down the sky, gave continual variety and animation to these strange exhibitions, while accentuating their baffling recalcitrance to exact measurement. No estimates of height were attempted at either Nain or Kingua Fjord; but there was a total absence of auroral appearances below the clouds, or otherwise unmistakably very near the earth, such as have been noted by M. Lemström and other observers in high latitudes. Luminous mists were, however, common. At times they suffused the whole sky; and shapeless masses of them constantly succeeded, and (at Kingua Fjord) were often the substitutes for the organised and definite forms of a perfect aurora. A sudden and wide-spread development of cirrus clouds was another curious secondary feature of the Nain polar lights. These were, at both stations, completely mute; not a suspicion of audibility attended their movements.

A no less intrepid observer than Dr. Koch is the author of the work with which we have coupled his in the heading of this article. M. Lemström's auroral researches began in 1868, when he was attached to the Swedish Polar Expedition commanded by Baron Nordenskjöld. They were continued during a sojourn of six weeks in Finnish Lapland in 1871, and were brought to a highly successful issue at Sodankylä in 1882-84. Finland held an honourable place among the eleven nations lately combined for a simultaneous attack upon the secrets of the Arctic circle; and the Professor of Physics in the University of Helsingfors was, by an almost inevitable choice, appointed chief of the Finnish meteorological station established in compliance with the terms of international agreement. Our readers are not unacquainted with the original line of work struck out by him in that capacity. Its upshot was to secure demonstrative evidence as to the proximate cause of the aurora borealis.

The book under review derives, then, a particular interest from its authorship. It is the production of a man who has devoted thought and labour without stint to the subject of which it treats, and has pushed the associated problems visibly nearer to solution. He now sums up the present state of knowledge as regards them in a well-arranged, concisely written, and copiously illustrated volume, recapitulating the most significant and surely established facts, fitting them, with the critical judgment bought by long experience, into their proper places, and expounding the theory best adapted to interpret and harmonise them.

Remarkably, as time went on, Halley's conjecture of a magnetic origin for auroræ gathered round it confirmatory circumstances entirely unknown to its author. Celsius and Hiorter noticed, in 1741, spasmodic disturbances of the magnetic needle coincident with the darting movements of northern lights. Wilcke, Ussher, and Dalton, ascertained, towards the end of the century, the close geometrical relations between the terrestrial magnetic

system and all the various parts composing a fully developed auroral display: the corona forming in the magnetic zenith, the streamers flitting parallel to the line of the dip, the arch erecting its summit in the magnetic meridian. When Faraday succeeded in obtaining luminous effects through magnetic action, and Rudolf Wolf demonstrated the subjection of auroræ to an identical periodicity with magnetic variations, the case might have appeared complete.

Yet the pure and simple magnetic theory of the aurora borealis, when attempted to be realised, either eluded the grasp of thought, or was found to involve admissions not very easy to make. Dalton, whose propensity towards forming distinct conceptions was a primary quality of his mind, had the courage to give it definite shape in 1793 (in his "Meteorological Observations and Essays"). Compelled, as he supposed, by the exigencies of observation, he conceived an envelope of an elastic fluid partaking of the nature of steel to replace atmospheric air at a height of about a hundred miles, and to supply the material alike of arches and streamers, shown, by their disposition in space, to be of a ferruginous character. It can scarcely be wondered at that the idea, in spite of Biot's adoption and development of it, failed to strike root. More vitality was in Canton's interrogative suggestion forty years earlier: "Is not the aurora borealis the flashing of electrical fire from positive towards negative clouds at a great distance, through the upper part of the atmosphere, where the resistance is least?" (*Phil. Trans.*, vol. xlvi. p. 357.)

It was not, however, until the electrical illumination of rarefied gases came to be studied with detailed attention that the full effect of the visual identity of the two kinds of phenomenon became sensible. The analogy was defined and completed by some experiments made by De la Rive in 1853. They showed that a luminous discharge in an exhausted vessel, when influenced by a powerful electro-magnet, condenses into a ring of light encircling its pole, endowed, moreover, with a rotatory movement such as has frequently been observed to affect a system of auroral streamers. Here, for the first time, their true part in such displays was assigned to the forces emanating from the earth's magnetic poles. It is a directive, not a formative one. The structure, not the occurrence, of auroræ is conditioned by them.

A marked change in scientific opinion resulted, accordingly, from these investigations. The "magnetic effluvium" theory of the aurora borealis finally disappeared, and what we may call the "illuminated vacuum" theory took its place. The change was accompanied by a shifting of the ground of inquiry. What was urgently needed in order to render intelligible the mode of action producing the gorgeous flame-vesture of northern skies, was perceived to be, not so much improved knowledge (however desirable) of the laws of terrestrial magnetism, as a sound doctrine of atmospheric electricity. Here De la Rive broke down. His hypothesis of a polar accumulation, through the agency of the winds, of the positive charge of the air, was obviously untenable.

Nothing better was, however, proposed until 1878, when Prof. Edlund, of Stockholm, applied the principle of "unipolar induction," discovered by Weber in 1841, to explain the phenomena of atmospheric electricity (*Phil.*

Mag., vol. vi. p. 360). The effects thus designated are really derived, as a particular case (in M. Edlund's probable view), from the well-established laws of magnetic action upon electric currents.

Each element of the system of currents formed by the electrified particles of the rotating terrestrial crust and atmosphere is thus urged, by the powerful magnet which the earth may legitimately be regarded as inclosing within it, along a path at right angles to the line drawn from each of its poles to the current-element. The direction and relative strength of the impelling forces are indicated in the accompanying figure, copied from the work before

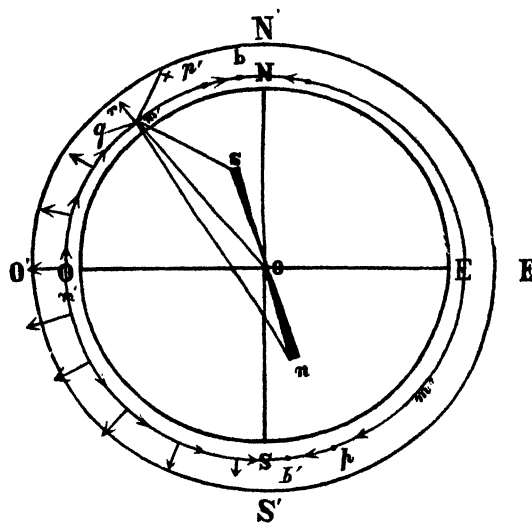

us (p. 166), where the particle *m'* is solicited towards the south pole (pointing north) of the magnet *Sn*, and towards *g* by its south pole. The combined result is to drive the particle upward and poleward along a line everywhere perpendicular to the swing of the dipping-needle. The vertical component, accordingly (represented by the arrows standing erect on the circle *m' m' m''*), attains its maximum at the magnetic equator, where the dip vanishes; the tangential component is there = 0, and attains its highest value in middle latitudes.

Several remarkable effects ensue: first, that atmospheric electricity gains potential with elevation—an observed fact; next, that it is constantly travelling away from the equator towards either pole. The circulatory process, however, thus set on foot, must be carried further; and in its continuance and completion Prof. Edlund finds the key to the auroral mystery.

At and near the equator, recombination of the positive electricity of the air with the negative electricity of the earth is opposed by the whole strength of magnetic induction repulsion, there acting vertically. When effected at it can only then be by sudden, violent, disruptive charges, apparent to our senses as lightning. But increasing inclination of the magnetic needle in high latitudes renders the line of no resistance marked by continually more practicable as an avenue of descent for the accumulating positive fluid. Hence, when it has attained a certain potential, gradual discharges take place over two polar zones, along the line of the dipping

needle. These constitute what we are accustomed in the northern hemisphere to call the aurora borealis.

Auroræ are, in this view, the polar equivalents of lightning. The same office of relieving the electrical tension of the air is fulfilled by them with innocuous tranquillity. Not indeed in absolute silence, though the "eerie din" of their rustling streamers has been caught by very few ears. Major Dawson, however, was fortunate enough to hear once, and once only, during his sojourn at Fort Rae, 1882-83, a sound "like the swishing of a whip, or the noise produced by a sharp squall of wind in the upper rigging of a ship," which accompanied, with its *crescendo* and *diminuendo*, the brightening and fading of an aurora visible at the time. This was the first official confirmation of innumerable less authentic reports to the same effect.

The mutual relations of auroræ and thunderstorms are full of significant interest. In point of geographical distribution, they may be termed complementary. The one kind of phenomenon is not more characteristically of polar than the other is of tropical origin. We take from M. Lemström's pages the following concise table, strongly corroborative of Edlund's theory, showing the dependence upon latitude of storm-frequency:--

Latitude	Mean annual number of storms
Between 0 and 30	... 52
" 30 " 50	... 20
" 50 " 60	... 15
" 60 " 70	... 10
About 70	... 0

Yet the two kinds of atmospheric luminosity are separated by profound distinctions. Thunderstorms give no sign of systematic magnetic associations. Sometimes, it is true, the needle may be seen to quiver at the instant of a lightning-flash, but by what seems a casual disturbance, quite different from the tumultuous agitation which accompanies or even betrays the darting of northern lights.

Storms are, moreover (so far as is known), completely exempt from the complicated periodicity by which auroral appearances are regulated. Now this, as M. Tromholt discovered in 1882, is exactly inverted in the far north. His discussion of M. Kleinsmidt's observations (1864-80) at Godthaab in North Greenland made it apparent that, on the polar side of the great auroral zone, a sunspot maximum brings with it an auroral minimum, and *vice versa*; that the two equinoctial peaks of the auroral curve in middle latitudes there coalesce into a single elevation at the winter solstice; and that the evening maximum noted further south is there shifted to the morning. Nor are these curious inversions peculiar to Godthaab.

Their immediate cause is easily understood. The auroral zone swings to and fro in several superposed periods, over the surface of the earth. As the sun's activity augments, it travels slowly towards the equator, and retreats towards the pole as it diminishes, diversifying its progress with minor oscillations, daily, bi-annual, and (perhaps) monthly. The analogy of the closing-in of the solar spot-zones with approach to maximum is striking, but unexplained. Auroral periodicity is thus seen to depend, not upon cessation, but upon removal, and the

observed reciprocal relation between auroral frequency in middle and very high latitudes is completely accounted for.

We can even go a step further. By Edlund's theory an increase of atmospheric electricity must be attended by a lowering of the latitude in which recombination takes place. That is to say, the observed shifting in space of the auroral zone implies, and is explained by, a rise and fall of potential in the upper conducting strata of the air, synchronising with the rise and fall of solar disturbance. This is probably in part an indirect effect of the fluctuations in the sun's activity.

Electricity, in M. Edlund's view, is simply the ether of space, a certain share of which belongs naturally to every ponderable substance. When this normal store is by any means augmented, the body on which the accumulation takes place is positively electrified; when it is diminished, negative electrification ensues. Hence, the expulsion of this so-called "fluid" from the earth by magnetic inductive action leaves it, *ipso facto*, negatively charged, and produces a positive charge in the air.

All this M. Lemström, in the work before us, readily admits; but he supplements the magnetic forces at work in disturbing our planet's electrical equilibrium with evaporation, of which the enormous capabilities for producing high potentials have been indicated by Prof. Tait (*NATURE*, vol. xxix. p. 517). But evaporation doubtless proceeds most vigorously when the sun's radiative energy is strongest—that is (presumably), at epochs of spot-maximum, so that an obvious link is thus supplied between the solar and auroral periods. The sequence of cause and effect is as follows: the sun's increased power quickens the development of aqueous vapour; this, in its turn, gives rise to a more copious supply of atmospheric electricity; added tension insures more speedy neutralisation; the zone of gradual recombination descends towards the equator, and auroræ are more frequently visible in middle latitudes.

Yet this is perhaps not the whole truth. Many circumstances speak in favour of a direct electrical inductive action of the sun upon the earth. M. Quet has lately shown (*Comptes rendus*, t. xcvi. p. 1038) that the existence of a magnetic fluctuation corresponding in period with the sun's rotation on its axis is otherwise inexplicable; and the instantaneous response of the terrestrial magnetic system to the solar outburst of September 1, 1859, almost compels the same inference, which is strengthened by the undoubted growth of magnetic intensity with solar activity. Hence, as sunspots become numerous, the circulatory process described by M. Edlund must be quickened and strengthened; atmospheric electrical tension will be heightened; and although the repellent magnetic power is proportionately reinforced, this is more than counterbalanced by the added mutual attraction between the opposite electricities of earth and air. Through this cause also, then, the auroral zone widens its distance from the pole once in eleven years.

The view that auroræ are due to currents of positive electricity illuminating the air on their passage to the earth, has been solidly established by M. Lemström's results at Sodankylä. His "discharging apparatus" served the precise purpose of Franklin's kite. The one

experiment was not more decisive than the other. Not only did luminous appearances accompany the setting-in of a current towards the earth from the network of insulated wires spread over the summit of Mount Oranturi, but the light evoked was distinctively *auroral*. Examined with the spectroscope, it yielded the still enigmatical "citron-line" discovered by Ångström in 1867. This is the invariable and chief constituent of auroral radiations. Besides one fitfully present, detected by Zöllner in the red, it is the only vivid line its spectrum includes. Ten others, more or less dubiously enumerated, are faint, hazy, indeterminate. M. Lemström holds that there is a fair agreement between some of them and lines in the laboratory-spectrum of rarefied air. But this is perhaps a too sanguine opinion. These seeming coincidences are very loose, and have not been drawn closer by careful inquiry. Vogel's conclusion that the spectrum of the aurora is modified from that of atmospheric air is indeed highly probable, but its probability is derived far more from external than from internal evidence.

A. M. CLERKE

THE BUTTERFLIES OF INDIA

The Butterflies of India, Burmah, and Ceylon. A Descriptive Hand-book of all the Known Species of Rhopalocerous Lepidoptera inhabiting that Region, with Notices of Allied Species occurring in the Neighbouring Countries along the Border. With Numerous Illustrations. By Lionel de Nicéville, F.E.S. Vol. II. Royal 8vo. (Calcutta. London: Bernard Quaritch, 1886.)

MORE than four years have elapsed since the first part of this book was published, and one of the authors has been obliged to resign his share in the work. The second volume, which has been written by Mr. de Nicéville alone, is in no way inferior to the first. When we remember that in the trying climate of Calcutta, and only in the leisure hours which can be spared from official work, Mr. de Nicéville has with but very trifling assistance from the Government of India completed a volume of nearly 300 pages, containing over 300 species of butterflies, we must allow that he deserves great praise; and though a volume produced under such difficulties must of necessity contain faults, yet it is in every respect very superior to Mr. Moore's work on the Lepidoptera of Ceylon, which was largely subsidised by Government. There is no doubt that the impetus given to the study of the butterflies of India by the publication of this work will have the best results, and we have every reason to hope and believe that it may be completed in three or four years more at latest. The present volume is devoted almost entirely to the family of Nymphalinx, and brings up the number of Indian butterflies already described to over 600, all of which are treated in a thoroughly scientific, careful, and painstaking manner.

Though the author has gathered to his assistance a growing band of field workers in various parts of India, among whom Messrs. Möller, Knyvett, Graham Young, Colonel Swinhoe, and others are conspicuous, and is rapidly accumulating a large quantity of specimens from all parts of the country, he still labours under the diffi-

culty of being unable to see the types of many of the so-called species described by Messrs. Butler and Moore in Europe. Evidence is constantly being brought forward to confirm the opinion of most entomologists that a large proportion of the names given by these authors represent no fixed or constant varieties, and that the characters described by them cannot be recognised in the insects themselves; but it is impossible to ignore them until this can be proved by comparison of these types with large series of specimens. Under these circumstances, Mr. de Nicéville has acted wisely in printing the descriptions of all these doubtful species, so that the attention of collectors may be called to them, and their existence proved or disproved. His remarks on them have the advantage of being intelligible, which is not always the case with the original descriptions of the authors in question, who have had for some years almost a monopoly in the description of Indian butterflies.

The kind of difficulty which occurs in many instances may be illustrated by the author's final remarks on the numerous varieties of the genus *Abisara*, described as species by Mr. Moore.

"A *prunosa* is typically the darkest coloured, and is the male most brilliantly purple-shot, of this group of the genus, specimens from Travancore being particularly large and dark. Even among Ceylon specimens, however, I find considerable variation; in some males the inner discal band on the fore-wing is evenly convex, and in others distinctly angled in the middle, and the purple suffusion is also variable; the size and number of the black spots on both sides of the hind-wing is extremely inconstant. In one very abnormal specimen there are two sub-apical spots, only the anal ones being entirely wanting. From an island one would expect to find some distinguishing characters in a species supposed to be peculiar to it, but I have quite failed to discover any. I can only repeat that, in my opinion, the name *echerim* should apply to all the species of this group of the genus *Abisara*, except perhaps to the Andaman local race, which has been named *bifasciata*; that as, in this case, the geographical range of numerous slight local races is not segregated, and each local race must interbreed with the next on the boundary-line which is supposed to separate them, it can serve no good scientific purpose to pick out a few apparently different specimens from each local race and to describe them, at the same time ignoring the intergrade specimens which exist."

If this opinion had been more generally held, the study of the butterflies of India would have been much simplified, and it is to be hoped that a new edition of "The Butterflies of India," which will certainly be called for almost before the first is complete, will show a large reduction in the number of names. A fixed nomenclature is the first desideratum in this as in other branches of science, and tends more than anything to attract good workers, who are often disgusted by a long list of synonyms and by changes in well-known old names.

The keys to the genera and species have been worked out very carefully, and will be useful to beginners. The literature, geographical distribution, and variation of each species are also well and carefully done. The volume will be indispensable to lepidopterists generally, and ought to interest many in India, who have hitherto looked on the collection of butterflies as rather a pastime than a science.

H. J. ELWES

OUR BOOK SHELF

The Deviation of the Compass in Iron Ships considered Practically. By W. H. Rosser. Second Edition, with considerable additions. (London: James Imray and Son, 1887.)

REMEMBERING the number of books already published treating in a practical form of compasses, their deviations on board iron ships, and the consequent adjustments, some persons may be disposed to ask, "What purpose will be served by an addition to them?" In answer it may be said that this, the second edition of a useful work by an author who bases his knowledge on the teaching of the "Admiralty Manual," and knows from instructing others their many difficulties, can hardly fail to be welcome to those having neither time nor ability to assimilate the subject without a guide at every turn.

Whilst we hope that Mr. Rosser's later edition will be duly appreciated, there is a certain definition which, for the sake of simplicity and accuracy, we would fain see removed from it. At pp. 30 and 31, clear definitions are given of true, magnetic, and compass courses. Why not let well alone, and not complicate the matter by introducing the term "correct" magnetic course? A reference to the later editions of the Admiralty publications on the deviation of the compass shows that the word "correct" in connection with "magnetic course" has been entirely omitted, apparently as no longer serving any purpose.

The concluding paragraph of the preface on patent compasses is hardly fair to Sir William Thomson's. The principles involved in the construction of his compass are not in themselves novelties, but he has done world-wide good by showing in it how that enemy of compasses—friction—may be avoided, whilst at the same time he has produced a card which is almost free from oscillation when the ship rolls heavily.

Travels in the Wilds of Ecuador. By Alfred Simson. (London: Sampson Low, 1886.)

"No one with the spirit of roaming within him," says the author of this book, "can live long in Ecuador without cherishing a growing desire to explore its unknown parts." Some time ago, accordingly (the exact date is not mentioned), he started with a companion from Guayaquil for Baños, and from Baños they went through the forest to the village of Aguano, on the River Napo, completing the road in eighteen days' actual walking, or forty-five days' foot journey, including necessary stoppages. At Aguano they were obliged to remain forty-two days, which they spent partly in collecting Lepidoptera, partly in making voyages of discovery by land and water in search of provisions. They then made their way in canoes down the Napo to the Amazon, which they reached after a voyage of twenty-five days. At Iquitos the two friends parted, Mr. Simson's companion setting out to explore the Ucayali, while Mr. Simson himself joined a Mr. Reyes in an expedition up the River Putumayo.

The story is very simply and pleasantly told, and those who like to read about distant lands of which little is generally known, will find much to interest them in the author's record of his adventures. The best parts of the book are those in which he describes the Indian tribes of Ecuador, whose habits and modes of thought and feeling he closely observed. He also notes some rather curious facts in natural history. Probably few persons have ever heard of "the roaring of an alligator." "I heard it myself," says Mr. Simson, "on one occasion in the case of a huge beast who appeared to be following a female of his species." The animal was swimming very rapidly, diving and rebounding up to the surface of the water. Mr. Simson was in a small Rob Roy canoe, and remained still to watch his manœuvres. Immediately the alligator saw the canoe, he "came towards it, roaring like a bull at

each bound above water." As he was diving, Mr. Simson (who was unarmed) forced the canoe straight over him, and so escaped. "Curiously enough," we are told, "not half an hour after this episode, an alligator jumped from a steep bank over my canoe, and only just cleared it, as I was distractedly paddling along under the shore, and inadvertently startled the reptile above me."

LETTERS TO THE EDITOR

[The Editor does not hold himself responsible for opinions expressed by his correspondents. Neither can he undertake to return, or to correspond with the writers of, rejected manuscripts. No notice is taken of anonymous communications. The Editor urgently requests correspondents to keep their letters as short as possible. The pressure on his space is so great that it is impossible otherwise to insure the appearance even of communications containing interesting and novel facts.]

Tabasheer

AS I have occasionally found the curious stony plug of which Mr. Thiselton Dyer writes (*NATURE*, vol. xxxv. p. 396), in the joints of bamboos accidentally broken, and been much exercised as to the nature and origin of the phenomenon, I have been much interested by his paper. May I further suggest that it is to a certain extent pathological—due, that is, to arrested growth, either longitudinal or lateral, in the shoot next above the joint in which the stony secretion or sediment is found.

In the onrush of tropical growth in the young shoot, Nature, after flooring the knot, has poured in, as it were, sap and silica sufficient for a normal length and width of stem to the knot next above it. But by some check to the impulse, or irregularity of conditions, the portion of stem thus provided for is shorter or narrower than intended; and the unused silica is left behind as a sediment, compacted by the drying residuum of sap. It is a question only to be settled by close examination of a great number of examples.

Something like it occurs, however, in the case of our own wheat. Larger joints, that is, and stronger walls are commonly found where the length of stem between joint and joint is a short one. As in the bath for electroplating the same amount of silver is deposited in a given time on a single penny as on a tea service of many pieces, so in the case of quick-growing silicated stems it would seem as if the same average amount of material were provided by the mounting sap, and the constructive use actually made of it determined by many accidents. In the wheat stem the silica is differently placed; in the fiercely-growing bamboo shoot the mineral in excess is left behind in a crude form, and disregarded. That is what I should expect to find.

HENRY CECIL

Bregner, Bournemouth, March 1

Temperature and Pressure in Jamaica

THE following table of elevations and averages is not as perfect as might be wished, but as some years must pass before it can be greatly improved, it is here given as one of many results obtained by the Meteorological Service in Jamaica:—

Station	Elevation Feet	Pressure Inches	Max.	Mean	Min.	Range
Kingston	0	30.00	87.0	78.2	71.0	16.0
Kempshot	1773	28.20	80.5	72.7	68.0	12.5
Cinchona Plantation ...	4907	25.27	68.5	62.6	57.5	11.0
Portland Gap	5477	24.71	69.0	59.7	54.6	14.4
Blue Mountain Peak ...	7423	23.14	71.1	55.7	46.3	24.8

In *NATURE*, vol. viii. p. 200, it was suggested that the fall of temperature, δT was connected with the fall of pressure δP by the equation

$$\delta T = \lambda \cdot \delta P,$$

where λ was taken equal to $3^{\circ}23$.

We can now correct this expression and take

$$\delta T = \lambda \cdot \delta P + \mu (\delta P)^2,$$

where $\lambda = 2^{\circ}92$, and $\mu = 0^{\circ}08$. But these values relate to mean temperatures; for minimum temperatures $\lambda = 0^{\circ}96$, and $\mu = 0^{\circ}40$.

These expressions and their connection are important, and it

would be interesting to know whether similar results have been found in India and elsewhere within the tropics, or may yet be obtained.

Computing δT by means of these formulæ, and applying the results to the temperatures at Kingston, we have

	Mean	Min.
Kempshot	72.7	68.0
Cinchona Plantation	62.6	57.5
Portland Gap	60.5	54.7
Blue Mountain Peak	54.4	45.6

which are fairly satisfactory.

Putting $\delta P = 30$ inches, the minimum formula gives -311° as the temperature of space, the thermometer being shaded from the sun by any spherical body such as the earth or moon.

Putting $\delta F = 30$ inches, the mean formula gives -81° as the mean temperature of a body devoid of atmosphere, such as a meteorite pursuing its course in space, or the moon, at the mean distance of the earth from the sun.

An expression for maximum temperatures cannot be as easily deduced; but if the surface of the meteorite or the moon which is turned from the sun be -311° , and if the mean temperature be -81° , it follows that the maximum temperature of the surface turned towards the sun must be about $+149^\circ$.

Jamaica, February 12

MAXWELL HALL

Electricity and Clocks

In addition to the plan pointed out by Prof. Sylvanus Thompson (the correct way to repeat from a striking clock to electric bells), I believe I have seen an arrangement in Dublin whereby a single port or going train only is made to strike the hours on an indefinite number of electric bells. I believe this mechanism is a patent.

Sandymount, March 2

HORLOGE

Top-shaped Hailstones

ON August 6, 1885, a hailstorm occurred in this neighbourhood, during which two waterspouts were seen. After one of these had burst, a fall of hailstones, almost exactly similar to those described by Mr. Middlemiss in your issue of March 3 (p. 413), commenced and lasted for some minutes. I do not remember to have noticed that there was a mass of clear ice at the base of the cone, but the banding was very distinct.

Beside the horizontal stratification there was another perpendicular one, giving the hailstone the appearance of being composed of alternate cylinders of clear and white ice. If the hailstones which Mr. Middlemiss saw at Ramnagar showed this peculiarity, he will perhaps be kind enough to communicate the fact through your columns. Sketches of the hailstones which fell in this district were published in the *Meteorological Record* soon after the occurrence, but I cannot give the precise date of the copy.

T. SPENCER SMITHSON

Facit, Rochdale, March 7

The Present Southern Comet

EITHER the present brilliant southern comet is periodic, or one of a large family of comets, moving in similar orbits and possessing marked similarities of structure. Its orbit, as far as an orbit can be determined from the approximate positions of a very indefinite nucleus, is similar to those of the 1843 and 1880 comets. In Grant's "History of Astronomy" the following description of the 1668 comet occurs:—"It appeared a little above the western horizon. The tail measured 23° in length, and resembled a huge beam of light. The head was so small as to be scarcely visible. The observations will be represented with sufficient accuracy by the elements of the orbit of the comet of 1843." A fairly accurate description of the present comet. There are other comets—1618, 1689, 1702—which possess this strong family likeness. If these comets be not one and the same, they must all have had a common origin. I do not know if it has been noticed that the aphelia of their orbits lie within a few degrees of Sirius. It may be possible that they have all been ejected from that gigantic sun; at any rate, it is impossible that they could have been attracted from nebulous masses lying beyond Sirius.

A. W. R.

Lovedale, South Africa, February 1

The Earthquake

I EXAMINED my magnetograms very carefully on the day of the earthquake in North Italy, and I find no trace of any special disturbance on the H.F. trace similar to that on the Kew curve. It may be well to place this on record, as it may aid in fixing the limits of the disturbance.

S. J. PERRY

Stonyhurst College, Blackburn, March 7

CEREBRAL LOCALISATION¹

I.

IT is rather more than ten years since the first edition of this book came under review in the pages of this journal. And it was intrusted to very able hands, for the reviewer was George Henry Lewes, himself an expert mentalist in this branch of physiology, and of the highest distinction as a philosopher and psychologist. The review is courteously but unflinchingly hostile: exception is taken to some of the facts and to most of the deductions of the author; although the value of the work, from its richness in suggestions as well as in facts, is ungrudgingly admitted. Mr. Lewes especially complains that the book "is so deficient in the indispensable correctives of counter facts and arguments, that the reader must be cautioned against accepting any position unless elsewhere verified. . . . From one cause or another there is a disregard of counter evidence, which, in a second edition, I should seriously urge him to rectify. . . . This disregard arises from no unfairness, but simply from the one-sidedness which comes from preoccupation with certain views."

The increased size of the work (498 pages instead of 322) is, no doubt, in part due to an endeavour to carry out the suggestion, although the growth of the subject may itself, in great measure, account for such increase. Indeed it must be confessed that the characteristic complained of by Mr. Lewes has not by any means entirely disappeared, and the student who may consult its pages must bear in mind that the book still remains the gospel of the functions of the brain "according to Ferrier."

The pervading idea of the work is expressed by the term "localisation of function." It was against this idea (and especially against certain applications of it) that Mr. Lewes brought to bear the full powers of his criticism.

One serious objection which was urged by him against many of Dr. Ferrier's results (those of localised extirpation) was that he was unable to keep the animals alive long enough to allow the effects of Disturbance of function to subside, so as to leave only the effects of Removal to be estimated. But the use of antiseptics has now permitted this objection to be removed, since there is no longer, in most instances, the same difficulty in preserving the animals, as was the case in Dr. Ferrier's first experiments.

It is further urged by the previous reviewer that "neither the effects of Disturbance nor the effects of Removal are to be taken as conclusive evidence that the function disturbed or removed is the function of the organ operated on." [But although not of themselves conclusive, yet if looked at in conjunction with other evidence they may furnish important indications regarding the function of the organ.] Mr. Lewes further affirms that "whenever a function persists or reappears after the destruction of an organ, this is absolutely conclusive against its being the function of the organ," meaning, of course, of that organ alone. That in the case of recovery or reappearance, partial or complete, of a lost function, another organ previously possessed of a different function has vicariously taken its place, is a scarcely tenable hypothesis. And yet there are well-recorded instances of such reappearance: as in the case of Goltz's dogs, which recovered some of the lost power of voluntary movement; and in that of the visual disturbances which are caused by lesions of the occipital lobe, in which

¹ "The Functions of the Brain." By David Ferrier, M.D., LL.D., F.R.S. Second Edition, re-written and enlarged. (London: Smith, Elder, and Co. 1886.)

I have myself frequently observed recovery, to all appearance complete. It appears to me that the idea expressed by the term "concentration of function" harmonises much more fully with our existing knowledge of the facts relating to this question than the more inflexible phrase "localisation."

It is time, however, to turn to the edition which lies before us. Dr. Ferrier, in his preface, tells us that the book has been almost entirely re-written, and, in point of fact, so much has been added and modified as to constitute this edition, in many respects, a new book. But the principal teachings of the original—those to which the book from the first owed its chief interest—the doctrines, namely, therein advocated regarding the localisation of cerebral functions, are, it is claimed by the author, maintained in all essentials unchanged. Since it is to the exposition of these doctrines, and especially of the experimental facts upon which they rest, that the student of physiology or psychology would naturally first turn, in order to discover what that is new may have been adduced in support of the Ferrierian teachings, and in what manner the hostile attacks which have been directed against them are met by their author, no apology is needed if we devote our attention first and chiefly to those parts of the book which deal with this important question.

After it had been found impossible to deny the correctness of the facts regarding electrification of the cortex of certain regions of the brain, a vigorous onslaught was made from various quarters upon the method of experimentation. It was especially contended (by Dupuy and others) that the movements produced by this method are really due, not to excitation of the cortex cerebri itself, but to conduction of the current to the basal ganglia (corpora striata). But a single new fact entirely overthrows the last remnant of this objection, since it has been shown (by Franck and Pitres) that similar movements may be caused by mere mechanical stimulation of the cortex (p. 228). Indeed, the same observers entirely deny that the basal ganglia respond at all to direct electrical excitation, a statement which we shall afterwards see is not, however, accepted by Dr. Ferrier.

In the review above alluded to, Mr. Lewes alleges two principal facts against the doctrine that the gray matter of the cerebral cortex is directly excitable, viz.: (1) the fact that only the electrical current causes an excitation,—mechanical and chemical stimuli have no such effects, because they cannot pass through the cortex to reach the white substance; (2) what he terms the "decisive experiment" of Dr. Burdon Sanderson. "If that part of the surface of the hemisphere which comprises the active spots is severed from the deeper parts by a nearly horizontal incision made with a thin-bladed knife, . . . the result is the same as when the surface of the uninjured organ is acted upon" (Proceedings of the Royal Society, No. 153). But we have just seen that, under suitable conditions, the cerebral surface may be excited mechanically; and, with respect to the second fact, I imagine that Dr. Sanderson would now be the first to admit that his results were due either to imperfect severance or to the spreading of a current of too great intensity.

Moreover, the study of the characters of the contractions which result from excitation of the cortex has tended to show that its excitation is indeed a stimulation of centrifugally discharging nerve-centres, and in conformity with this view it is found that destruction of the cortex in the excitable regions is followed not only by immediate paralysis of the parts in which movement is evoked on excitation, but also by speedy degeneration of the efferent nerve-fibres. The arguments upon this point are set forth briefly, but clearly, by the author (pp. 231-33).

With regard to the results of localised excitation of the cortex (in the monkey), some modifications which are not wholly unimportant have been introduced; but to obtain these the author appears rather to have again consulted

his original memoir (Proc. Roy. Soc., No. 161, 1875) than the results of any new experimental investigations. The facts that the excitable region extends over the margin of the hemisphere to include the marginal gyrus upon the mesial surface, and that this part of the excitable region is associated with movements of the leg and trunk, had not been definitely determined at the time of publication of the first edition, but are duly recorded here (p. 245).

The general correctness of Dr. Ferrier's statements regarding the results of localised excitation of the brain in the monkey (and, from its resemblance to the human brain, these will be those of chief interest to most readers) seems at the present time to be universally admitted. I have myself so frequently had the opportunity of verifying them as to have no doubt of their general applicability. But the *inferences* which he has drawn from the results of excitation have not, as we shall presently see, been allowed to remain unquestioned.

The method of localised ablation is of yet more importance for the determination of the functions of the cortex than that which we have just considered. In carrying out this method, the necessity of strict adherence to Listerian precautions is demonstrated when we compare the results which were obtained in the first instance by Dr. Ferrier himself, and recorded in the first edition of this book, with those which have been yielded by the antiseptic method in the hands of Prof. Yeo and himself, in a series of experiments undertaken with the express object of testing the applicability of that method to brain-surgery, several of which experiments are recorded in this edition. The path which their experiments indicated has since been trodden by my colleague Mr. Horsley and myself, and it is to-day a beaten track leading to previously undreamed-of possibilities in surgical science. The fact that the brain can be as effectually searched with a view to the discovery and removal of a tumour as any other part of the human body is an advance of vast extent—a boon to suffering humanity of incalculable value. And that this boon has been acquired, could have been acquired, solely as the result of experiments upon animals, is a fact which may well make the most frenzied of anti-vivisectioners pause ere he would deny to his fellow men the opportunity of acquiring benefits of such inestimable worth!

At the present time it is admitted, even by those physiologists who, like Goltz, have been hitherto accounted the most strenuous opponents of the doctrine of cerebral localisation, that the results of localised extirpation of the cortex vary with the part removed. These results consist of a loss or diminution in the power of voluntary action of different groups of muscles, or of a loss or defect in the appreciation of sensory impressions (but, according to some observers, both volition and sensibility may be at the same time affected by the destruction of certain parts): lastly, from experiments upon some parts of the hemisphere, it may happen that no effect appreciable to the observer is obtained. With respect both to these results and those obtained by excitation, Dr. Ferrier, in the first edition of this work, took up certain positions which have in the meanwhile been vigorously assailed from various quarters. These positions are, in the present edition, for the most part defended by the author with no less vigour, although one or two have been somewhat shifted, and one, at least, altogether abandoned.

In order to make clear these positions to those readers of NATURE who may not have followed closely the controversies which have been carried on during the past fifteen years regarding this subject of cerebral localisation, it will be necessary briefly to describe, with the aid of a diagram, the main features of the external configuration of the monkey's brain (every fissure and convolution in which is represented in the human brain). It will then be easy to indicate the regions to which special functions were originally ascribed by Dr. Ferrier, the modifications

which he has since seen reason to introduce in the original scheme, and the results which have been arrived at by certain other workers in this field of research.

Fig. 1 is a diagram of the outer surface of the left hemisphere of the monkey's brain: in it the fissures are represented by black lines. It is seen to be crossed obliquely by six prominent fissures (besides less important

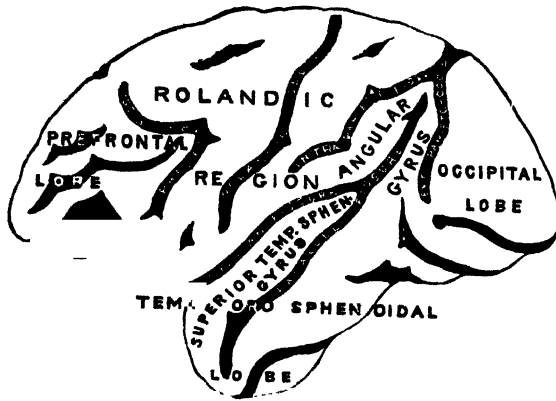

FIG. 1.

depressions). These, enumerated from before back, are the pre-central, Rolandic, intra-parietal, Sylvian, parallel, and parieto-occipital fissures. The anterior portion of the hemisphere in front of the pre-central fissure is termed the pre-frontal lobe. The part of the brain behind this, and bounded behind by the intra-parietal and Sylvian fissures, may be designated the Rolandic region, since it includes the Rolandic fissure. The next part, posteriorly, lies in the angle between the intra-parietal and parieto-occipital fissures, and has the end of the parallel fissure running up into it: it is known as the angular gyrus. Behind the parieto-occipital fissure is the occipital lobe. The rest of this surface of the hemisphere below and behind the Sylvian fissure is the temporo-sphenoidal lobe: the convolution in this which lies between the Sylvian and the parallel fissures, and which is thus very well marked off from the rest of the lobe, is the superior temporo-sphenoidal gyrus.

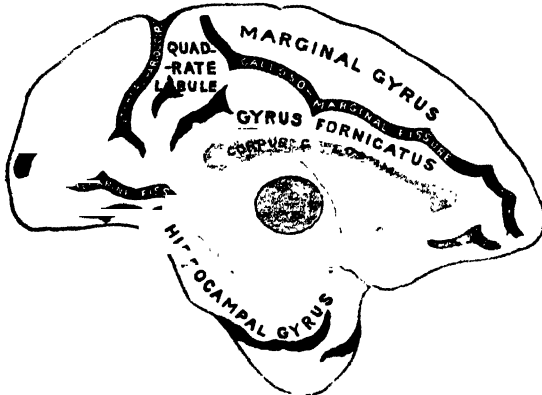

FIG. 2.

Fig. 2 represents the mesial and under surface of the left hemisphere. We here see, above the cut corpus callosum and the other parts which unite the two hemispheres, two convolutions running longitudinally, and separated by a well-marked fissure, the calloso-marginal. The upper one is termed the marginal gyrus, the lower the gyrus fornicatus. The latter expands posteriorly into

the quadrate lobule, and is then continued around posterior end of the corpus callosum on to the under surface of the temporo-sphenoidal lobe, where it becomes continuous with the hippocampal gyrus. The inter-parieto-occipital fissure, continuous above with the external one of the same denomination, cuts off, like that, occipital lobe from the rest of the brain.

Briefly stated, the positions taken up by Dr. Ferrie in the first edition of this work were as follows:—

(1) The Rolandic region is motor. This is the part of the hemisphere from which all volitional impulses (at least for the limbs, head, and face,—about the trunk muscles nothing was ascertained) issue. It is not connected with sensory perceptions of any kind, not even with those of the muscular sense.

Evidence.—Electric excitation in this region in an animal produces definite and co-ordinated movements of muscles of the limbs, neck, and face, similar to those which occur in voluntary efforts. Extirpation is followed by immediate and permanent paralysis of those muscles with the occurrence of any loss or impairment of sensation in the corresponding parts.

(2) The angular gyrus is the centre for vision with the opposite eye.

Evidence.—Electric excitation of this convolution produces movements of the eyes towards the opposite side, contraction of the pupils, and closure of the eyelids if under the stimulus of a strong light. Movement of the head to the opposite side is also frequently produced. Extirpation of the angular gyrus on one side causes complete blindness in the opposite eye, but this is permanent if the angular gyrus of the other hemisphere be intact. If this also be removed the loss of vision is complete and permanent.

(3) The superior temporo-sphenoidal convolution is the centre for hearing with the opposite ear.

Evidence.—Electrical excitation of this convolution produces sudden retraction or pricking up of the opposite ear, opening of the eyes, dilatation of the pupils, and turning of the head and eyes to the opposite side. "The phenomena resemble the sudden start and look of surprise which are caused when a loud sound is made in the opposite ear." Lesions of the superior convolution produce deafness of the opposite ear, as evidenced by the fact that the animal becomes deaf to ordinary sounds when the superior convolution is removed upon the same side as the lesion is stopped with cotton wool. When the lesion is established bilaterally, so as to cause destruction of the superior temporo-sphenoidal convolution on both sides, the animal fails to respond to auditory stimuli.

(4) The hippocampal region is concerned with the appreciation of tactile sensation, if not of other forms of sensibility.

Evidence.—Unilateral destruction of this region is followed by complete absence of response to cutaneous stimulation on the opposite side of the body (without a true motor paralysis, although there may be disturbance of voluntary movements, "due to the loss of tactile sensation, by which movements are guided") "the effects being of a persistent character."

(5) The subiculum, or tip of the temporo-sphenoidal lobe (under surface) is specially related to the sense of smell (in the nostril of the same side).

Evidence.—Electrical irritation of this part of the brain causes phenomena (torsion of the lip and partial closure of the nostril of the same side) such as are "produced by the direct application to the nostril of a powerful or disagreeable odour." Destruction of this region upon one side is accompanied, when the nostril of the opposite side is plugged, by impairment or loss of the olfactory sense. Bilateral destruction by complete absence of reaction to olfactory sensations. "The comparative development of this region in animals in which the sense of smell

largely developed, as in the dog, cat, and rabbit, strongly bears out this view."

(6) The lower part of the temporo-sphenoidal lobe, close to the subiculum, is probably to be regarded as the centre of taste.

Evidence.—Electrical excitation of this region produces movements of the lips, tongue, and cheek-pouches, which "may be taken as reflex movements consequent on the excitation of gustatory sensation." And the abolition of taste coincides with (bilateral) destruction of this region.

(7) The pre-frontal region is probably related to the reflective and intellectual faculties.

(8) The occipital lobe is related to the visceral sensations, such as hunger and thirst. The evidence in favour of this opinion was regarded even by its author at the time as very inconclusive, and since the subject is entirely ignored in the later edition we need not further consider it.

E. A. SCHAFER

(To be continued.)

THE UNIVERSITY COLLEGES

THE other day (March 3) the *Times* printed a letter from Prof. Jowett containing a powerful appeal to the State on behalf of the University Colleges which have recently been established in large towns by the exertions of private individuals. On Monday evening last, Mr. Mundella, having asked the Chancellor of the Exchequer whether his attention had been called to this letter, proceeded to inquire whether the Government "would introduce or facilitate the passing of a measure authorising local authorities to contribute towards the establishment and maintenance of schools and colleges adapted to the wants of their several localities, and would recommend to Parliament annual grants in aid of the same." That Mr. Goschen, so far as his personal sympathies are concerned, would have liked to give an affirmative answer to this question there can be no doubt; but, speaking as a member of the Government, he adopted a very discouraging tone. He was not in a position, he said, to recommend to Parliament annual grants in aid of local colleges. He admitted that it was an open question whether local authorities should not be empowered to aid such institutions, but the Government could not undertake to introduce or facilitate the passing of a measure dealing with the matter.

This decision is greatly to be regretted, and we must hope that the Government will soon be compelled by the pressure of public opinion to reconsider the subject. No one disputes that the University Colleges have done, and are doing, most valuable service to the communities in the midst of which they are placed. Until they were established, what is called a University education was accessible only to very well-off persons. The University Colleges have brought a high intellectual training within reach not only of the middle classes, but of working men, and large numbers of eager and intelligent students have taken advantage of the opportunities provided for them. Even, therefore, if no material benefit were derived by the nation directly from the University Colleges, it would be the clear duty of the State to afford them the help they need. But from the point of view of industry and commerce, as well as from the purely intellectual point of view, it is hardly possible to overrate the importance of these colleges. That our traders are being driven by German and other competitors from important markets is, unfortunately, only too certain; and it is not less certain that they will never recover the ground they have lost until English industry in all its branches is carried on in accordance with strictly scientific methods. This is beginning to be pretty generally understood, and it will be strange if the country does not insist that justice shall be done to institutions in which a serious attempt is being made to

impart the kind of knowledge without which it is impossible for manufacturers to adapt their work to the rigid conditions of the present age.

No doubt it would be very satisfactory if the University Colleges could be made self-supporting, but this they cannot be. If those of them which do not possess any considerable endowment receive no aid from the Government, they will soon be placed in a position of grave difficulty; and the question will have to be faced, whether it is worth while to maintain them at all unless they can be maintained in a state of high efficiency. After all, it is no very great sacrifice that the State is asked to make for their benefit. What is claimed is simply that not less shall be done for the English colleges than is done for like institutions in Scotland, Ireland, and Wales.

An aspect of the question which does not always receive adequate attention was well brought out in Prof. Jowett's admirable letter. "Among other benefits," he wrote, "the influence which is exercised by these institutions on the society of a place is not to be forgotten. The residence in a large manufacturing town of a number of highly educated persons, having a variety of literary and scientific interests, is a social element of great value. They raise the tone of conversation; they create ideas and aspirations which would not ordinarily have arisen in a mercantile community. They break in on the dull monotony of wealth. The posts which they occupy, though poorly paid, afford leisure for study and opportunities for research. Among the holders of them are to be found some of the most promising young men of the country. Many of them are known by their writings, and a large proportion of the papers published in English scientific periodicals is a record of the work done in University Colleges."

The *Times*, we are glad to say, cordially supports the cause advocated by the Master of Balliol. "The good," it says (March 3), "which the local colleges do is not exaggerated by Prof. Jowett. They form centres of instruction for all the young men and young women of a town who desire to improve themselves. They foster the love of study, and teach the art of making use of time. 'They may have even kindled in the minds of one or two the spark of genius.' To put the matter on a lower but not less practical level, they have done much, by means of their technical schools, to provide that very instruction of which, as everyone admits, our artisans are so much in need to enable them to carry on the struggle for existence against foreign rivals. Nor does the Master overstate the advantages which the town indirectly derives from the presence of these colleges, whose teaching staff do much to raise the tone of social life throughout the district. It is a sound argument of the defenders of the Church Establishment that it is a great gain to English society to have at least one educated gentleman settled in every parish. The argument may be extended in favour of the University Colleges, and we may say that in a large town, where the pursuit of wealth through commerce is the characteristic of the whole society, it is a great advantage to have four or five men of high intellectual training, whose aims are different, whose standard is different, and who represent science and literature sometimes with great distinction. It would on many grounds be matter for extreme regret if the excellent institutions which foster such men should disappear. Yet there is too much reason to fear that such will be the fate of most of them, unless help more permanent and certain than any that can be derived from voluntary sources is at once forthcoming. Neither Leeds, Newcastle, Sheffield, Nottingham, nor Bristol is in a satisfactory financial condition. The fees cannot pay even the very modest stipends of the professors, and the annual subscriptions are showing a lamentable tendency to diminish. It seems as though there was nothing for it but an appeal to the Exchequer, sorely tried as it now

is, and growing as is the need for economy. . . . The University Colleges during fifteen years have proved their value; and also, like every other educational institution, they have proved that they cannot live without external help. The only help that is likely to be permanent and that will enable them to feel secure is help from the State; and, in a moderate degree, it will be worth the State's while to give it."

The opinions of men of science on the subject were expressed in a letter from Sir Henry Roscoe, which appeared in the *Times* on Saturday last. "It is unnecessary now," he wrote, "to enlarge on the important national work in which these colleges are engaged. That the higher scientific and technical training which these colleges are now giving to the best of their power is a necessity, indorsed as this opinion has been by two Royal Commissions, is now, I am glad to think, generally admitted. It is, however, perfectly clear that if these colleges are to do the work which the country demands they must receive pecuniary assistance. They cannot from their very nature be made self-supporting. Their object is to afford a thorough but also a cheap education, and the localities have in almost all cases now practically exhausted the power of raising funds from private sources. How, then, are the necessary means to be found? They must come either from Imperial or from municipal sources. As the Master has pointed out, the remedy must be a speedy one. We cannot afford to wait until public opinion has reached the point at which ratepayers generally are convinced that it is to their advantage to support such colleges. The only alternative, therefore, is that the nation as a whole shall, through the Government, acknowledge its obligation to supply the necessary funds, the amount required being comparatively small and not one likely largely to increase. It is satisfactory to know that the whole subject of the furtherance of scientific and technical education in the country is at the present moment under the serious consideration of Members of Parliament of all political parties, and I have good reason to hope that our efforts to bring this question, vital as it is to the industrial and commercial supremacy of the country, to a satisfactory issue may, even this Session, be crowned by some measure of success. Among the several important matters engaging our attention, I need scarcely say that this particular one, affecting as it does the higher technical education of those who are hereafter to take positions as leaders in our commerce and industries, is by no means the least important."

We trust that the new impetus now given to this question may lead to beneficial results. It is to be hoped, however, that we shall bear less of the word "*technical*" in connection with these colleges, for if they are technical only, we may be better without them.

THE EARTHQUAKE IN SWITZERLAND

PROF. FOREL, the meteorologist, of Morges, on the Lake of Geneva, has just issued a report on the earthquake of February 23. He classifies the shocks under three heads—namely, preparatory shocks, strong shocks, and consecutive shocks. It is difficult, in the absence of trustworthy data, to indicate the precise locality of the first-named, but Switzerland was undoubtedly the region of the second; but it was to the third—that is, the consecutive shocks—that all the mischief was due. The professor traces the course of the phenomenon in Switzerland over a radius of at least four hundred square miles. Its force was greater in the southern parts of the country than in the north, though the shocks were felt throughout Geneva, Berne, Neuchâtel, Fribourg, Vaud, Valais, and Tessin; and observations go to prove that these shocks travelled almost due north and south, although the direction of the oscillations does not coincide with this course. The

oscillations in Switzerland were characterised by their number and repetitions. In some localities they were longitudinal; that is, running parallel to the meridian; in others they were transverse, running or flowing from east to west. The vertical movements were marked by their feebleness where indicated, but in the greater part of the territory affected vertical oscillations were entirely absent. One of the peculiarities of the oscillations generally was the length of duration, which is set down as varying from 10 to 30 seconds. But the collected reports prove that the mean of these figures more nearly represents the prevailing duration. The intensity of the shocks was greater in the central and southern areas of the disturbance, and it would seem as if the shocks only just failed to attain the necessary strength which would have produced disastrous effects. As it was, church bells were rung, in some places violently; windows were rattled, doors thrown open, ceilings slightly cracked, and morsels of plaster were brought down, and here and there stacks of wood were thrown over. One of the most striking features of the phenomenon was the extraordinarily large number of clocks that were instantly stopped, and this fact has afforded the best possible means of determining with something like perfect accuracy the time of the shocks, which varies from three to four minutes past six in the morning, Berne time. The large astronomical clock of the Observatory at Basle stopped exactly at 6h. 4m. 7s. This, taken as representing Berne time, corresponds with 5h. 43m. 35s. of Paris, 5h. 55m. 43s. of Marseilles, 6h. 3m. 2s. of Nice, and 6h. 24m. 3s. of Rome.

The consecutive shocks, which were responsible for all the loss of life and damage to property, were centralised in the region of the Riviera. The greatest damage was done by the two first shocks, which occurred with an interval of fifteen minutes between them. The reports from the Swiss observatories also show that a series of feebler shocks were experienced in Switzerland later on in the same day, and also on several succeeding days.

NOTES

SEVERAL schools of science and art in the colonies and dependencies of the United Kingdom have expressed a wish to be allied with the Department of Science and Art and to have the advantage of its examinations. It has therefore been decided that upon the application of the Colonial Government or Educational Department, or other public authority of the colony, the Department of Science and Art will arrange for the examination of their schools, on the results of which examination certificates and returns of awards will be issued. The entire cost of the examination of the papers and works, and of their carriage, clearing in London, and conveyance to and from South Kensington, will, of course, have to be defrayed by the local authority concerned. The personal examinations, the subjects of which are stated in the Science and Art Directory, must be held in the colonies and dependencies upon the earliest date possible after the receipt of the examination papers, and these examinations must be conducted by qualified and responsible persons not immediately interested in the results of the examinations, who should on the conclusion of each examination furnish a certificate that the examination has been fairly conducted. The examination of works is held at South Kensington, and works to be examined must be forwarded to reach South Kensington not later than the end of April in each year. The Department will send upon application copies of lists of examples and prizes, and will, as far as possible, advise the local authorities in reference to the conduct of science and art schools or classes. The Department will also present specimen examination papers or works—when there are such in stock disposable—with the view of indicating the style of drawings

and paintings done by students and candidates in the United Kingdom, and the standards of attainment for the various examinations.

CAPT. A. W. GREELY has been appointed to succeed the late General Hazen, as Chief Officer of the Signal Service in the United States, with rank of Brigadier-General. This announcement has been well received in America even by those who have hitherto wished to see the Signal Service separated from the army. Capt. Greely was next in rank to General Hazen in the bureau, and his eminent fitness for the duties of his new position is universally acknowledged.

THE Paris Geographical Society will shortly celebrate the centenary of the La Pérouse expedition round the world. The last news received from the unfortunate explorer and his companions was brought to France by an uncle of M. de Lesseps.

SEVERAL interesting speeches were delivered in the House of Commons, on Monday evening last, in connection with the supplementary vote of 10,560*l.* for the Science and Art Department. Mr. Mundella said the vote asked for was the result of an automatic increase in which every member who had spoken ought to rejoice. The increase had been large and rapid. In 1875 the total number of pupils in every branch of art instruction was 444,000, while in 1885 the number had increased to 883,000, or nearly double. There had been a large increase of art schools, where, he thought it would be admitted, the work was much better done than in art classes. He did not, however, profess to be satisfied with the position we have attained. It was true, he said, our Estimates were large as compared with twenty-five or thirty years ago; but, as compared with other countries similarly situated to ourselves, they were a disgrace to us. The expenditure on education in England was 5 per cent. of the whole expenditure of the country, but in some other countries the expenditure on education formed one-third of the whole expenditure of those countries—in Switzerland, for instance, it was rather more than one-third. While it was the duty of the Treasury to keep down expenditure, there would be no real good done in this country until the expenditure on education was largely increased. Prof. Stuart also insisted that England does not yet do nearly enough for scientific education. To illustrate this, he quoted the school statistics of New Zealand and Australia, showing the large proportion of children attending science teaching in those colonies. Prof. Stuart argued strongly in favour of technical instruction being carried on in evening classes, so that the minds of workmen might be concentrated on those branches of work which they might not so easily acquire in the workshop. An immense impulse had been given in the right direction when the examination in chemistry had been made one of a practical kind, instead of merely book-work and paper-work, and a similar step would have a good effect in the case of physics and mechanics. In conclusion, Prof. Stuart urged upon the Government the desirability of extending as far as possible the scholarships, local exhibitions, and prizes in connection with the science classes. Sir H. Roscoe gave it as his opinion that the money which the country voted for the purpose of science and art instruction was money well spent. The importance of the question could not be overrated, and the Science and Art Department was in a position to carry out in the main the requirements of the country in regard to such instruction. There was, however, one matter to which the Department had not yet given attention, and that was the question of manual instruction in the use of tools. In view of what was being done on the Continent in extending science and technical instruction, he trusted the Committee would pass the vote as only the beginning of what they might hope to get in time.

WE regret to announce the death of Dr. August Wilhelm Eichler, Professor of Botany at the Berlin University, and Director of the Royal Botanical Garden and Botanical Museum at Berlin. He died on Wednesday, the 2nd inst.

DURING the past month there have been several fine displays of the aurora borealis in Northern Sweden. The displays generally began about 8 o'clock p.m., and continued till towards midnight, the point of culmination being reached about 11 o'clock. The aurora appeared in the form both of streamers and clouds, the colours being mostly white and yellow.

ON February 19, about midnight, a brilliant meteor was seen in Central Norway. It went in a direction north-east to south-west, and was observable for several seconds. The colour was at first brilliantly white, but changed during the passage into yellow and green. The greatest apparent size of the meteor was equal to that of the full moon. It left a trail a couple of yards in length, portions of which remained for some seconds after the meteor had been lost to view behind a mountain ridge. During its passage it lit up the country within a great area.

THIS year Prof. Du Bois-Reymond will celebrate the twentieth anniversary of his appointment as secretary of the Academy of Sciences of Berlin. He is the oldest member of the physico-mathematical class of the Academy.

IN a lecture delivered at the Society of Arts on Wednesday, the 2nd inst., Mr. E. J. Beale stated that last season's experiments in the cultivation of tobacco in England and Ireland resulted in a success satisfactory beyond the hopes of the most sanguine promoters of the experiments. While reasonable caution in the matter of area and extent of future operations was necessary, those results, he thought, more than justified further trials.

THE fifty-fifth annual meeting of the British Medical Association will be held at Dublin on Tuesday, August 2, and the three following days. Dr. Withers Moore, Senior Physician to the Sussex County Hospital, is President, the President-Elect being Dr. John T. Banks, Regius Professor of Physic in the University of Dublin. An address in Medicine will be delivered by Dr. W. T. Gairdner, Professor of Medicine in the University of Glasgow; one in Surgery by Dr. E. Hamilton, Fellow and Professor of Surgery in the Royal College of Surgeons in Ireland; and one in Public Medicine by the Rev. S. Haughton, M.D., Senior Fellow of Trinity College, Dublin. The scientific business will be conducted in eight sections and two subsections. Dr. G. F. Duffey, of 30 Fitzwilliam Place, Dublin, is local Honorary Secretary.

THE Exhibition of Marine Meteorological Instruments organised by the Royal Meteorological Society, which will be held at the Institution of Civil Engineers, 25 Great George Street, Westminster, from Tuesday to Friday next, the 15th to 18th inst., promises to be very interesting and instructive. Many of the instruments used in the *Challenger* and other expeditions will be exhibited. At the meeting of the Society on Wednesday evening, Dr. H. R. Mill will read a paper on "Marine Temperature Observations." Any persons, not Fellows, wishing to visit the Exhibition or to attend the meeting, can obtain tickets on application to the Assistant Secretary, Mr. W. Marriott, 30 Great George Street, S.W.

IN the State of New York there are at least fourteen distinct laws relating to the medical profession. The State Legislature is now considering a measure for the entire repeal of some of these laws, and for the abrogation of parts of others. *Science* is of opinion that the measure "should meet with the hearty support of the medical profession, and receive the vote of every member of the Legislature."

MESSRS. CASSELL AND CO. will have ready, shortly, "A Manual of Practical Solid Geometry, adapted to the Requirements of Military Students and Draughtsmen," compiled by Major William Gordon Ross, R.E., Professor of Geometrical Drawing and Fortification, Royal Military Academy, Woolwich.

MESSRS. GRIFFIN will publish, shortly, a work on pathology, by Prof. Julius Dreschfeld, of Owens College.

DR. THOMAS JONES, Lecturer on Surgery at Owens College, has a work on surgery in preparation. Messrs. Smith, Elder, and Co., will be the publishers.

MR. H. K. LEWIS will issue immediately "Photography of Bacteria," illustrated with eighty-six photographs reproduced in autotype, by Dr. Edgar M. Crookshank; also a second edition, revised and considerably enlarged, of "Manual of Bacteriology," by the same author.

WE have received the first number of the *Wesley Naturalist*, a monthly journal of the new Wesley Scientific Society, of which the Rev. Dr. Dallinger, F.R.S., is President. In an introductory paper, Dr. Dallinger says the Society does not hope to do important original work. Its aim will be "to direct, stimulate, and help, mostly the young and those engaged in daily work, in acquiring correct knowledge of the principles of a chosen branch of science."

MESSRS. GURNEY AND JACKSON, the successors to Mr. Van Voorst, are about to publish a List of British Birds, which has been revised by Mr. Howard Saunders. It will be printed so as to be available for the labelling of specimens. The use of varied type will enable the student to distinguish readily the rarer visitors and the species having a doubtful claim to be considered British.

AN extensive fish-culture establishment is being formed by Mr. William Burgess on his estate at Malvern Wells, Worcester, for the propagation of Salmonidæ and coarse fish. A series of breeding- and rearing-ponds has been made, and a hatchery capable of incubating four millions of ova is being constructed. The site selected for the purpose is said to be admirably adapted for fish-culture, as there is an abundance of pure water. Mr. Burgess has already turned into his waters a quantity of fish, including trout, salmon, and carp.

IN the spring the U.S. Fish Commission steamer *Albatross* will sail for her work on the Pacific. The fish-bearing properties of the Kiu Sawa, or Black Stream of Japan, will be investigated. The Kiu Sawa, crossing the Pacific in a high latitude, is said to modify the temperature and climate of Alaska and the Aleutian Archipelago in very much the same way as the Gulf Stream modifies the climate of the British Isles.

THE managers of the Royal Victoria Hall and Coffee Tavern show much discretion in the choice of subjects for their well-known "Penny Science Lectures." On Tuesday last a lecture on "Vesuvius and Ischia, a Volcano and an Earthquake," was delivered by the Rev. W. W. Edwards. On Tuesday next, Prof. George Forbes will describe "A Journey across Asia, through Siberia," and, on the 22nd inst., the Dean of Westminster will lecture on "Westminster Abbey."

A REPORT of the proceedings of the thirty-fifth meeting of the American Association for the Advancement of Science, held at Buffalo in August last, has lately been published. It contains, besides many short papers and abstracts, the address of Mr. H. A. Newton, the retiring President, and the addresses of the Vice-Presidents in the Sections of Mathematics and Astronomy, Physics, Chemistry, Mechanical Science and Engineering, Geology and Geography, Biology, Anthropology, and Economic Science and Statistics.

IN the second Bulletin of Miscellaneous Information, issued from the Royal Gardens, Kew, there is an interesting account of Cape boxwood. Some time ago a sample of the wood of this tree was sent to Kew, and it was found that the two woods were almost identical. It was clear, therefore, that Cape boxwood was none other than a species of *Buxus*, and perhaps *B. sempervirens* itself. Small samples were exhibited in the Cape Court at the recent Colonial and Indian Exhibition, and in the Catalogue it was stated that the wood had been "very favourably reported on for engraving purposes." The general appearance of the specimens at the Exhibition did not recommend Cape boxwood to the notice of engravers.

WE regret to announce the death of Dr. Birnbaum, Professor of Chemistry at the Technical High School at Karlsruhe, on February 20; and of Dr. Reinhold von Reichenbach, the well-known chemist, who died at Gratz on February 23.

THE South American Exhibition at Berlin has resulted in a great pecuniary loss.

M. E. BERILLON has just published a little book on Paul Bert's scientific career. Being a medical man himself, he has been able to give a very clear and accurate idea of M. Bert's work in physiology.

AT a recent meeting of the Paris Biological Society an apparatus was shown, made of iron and glass, in which a pressure of 1000 atmospheres can be developed for the purpose of studying the influence of pressure on animal life.

THE third meeting of the French Congrès de Chirurgie will take place in Paris in the month of April 1888. The second one was held in November 1886. Prof. Verneuil is President Elect for 1888.

THE earthquake which took place on February 6 in Southern Indiana, Illinois, a small portion of Kentucky, and East Central Missouri is said by American newspapers to have had an area of about 75,000 square miles. The greatest intensity was in South-Western Indiana and South-Eastern Illinois. The U.S. Geological Survey is trying to obtain accurate information as to the boundary of the area covered.

CORRESPONDENTS in Athens report that on Friday last successive slight shocks of earthquake were felt from noon to midnight at Philiatra. The direction was south-west by south.

M. FLORAN DE VILLEPIGNE has devised, in Paris, an instrument, the autographometer, which records automatically the topography and difference of level of all places over which it passes. It is carried about on a light vehicle, and those who wish to use it have nothing to do but to drag it, or have it dragged, over the ground of which they desire to obtain a plan.

THE University of Berlin is being attended, during the present term, by no fewer than 5357 students. This is the largest number of students that have ever been enrolled by a German University. In the Faculty of Philosophy there are 1984 students in that of Medicine, 1297; in that of Law, 1282; in that of Theology, 794. The number of instructors is 288, of whom 147 are in Philosophy, 103 in Medicine, 22 in Law, and 16 in Theology.

THE Chicago Manual Training School has lately issued its fourth annual Catalogue. The requisites for admission to this institution are that the candidates be at least fourteen years of age, and be able to pass a satisfactory examination in reading, spelling, writing, English composition, geography, and arithmetic. The course extends over three years, and includes instruction in mathematics, science, language, drawing, and shop-work, during the entire period. The school has a well-equipped wood-room, foundry, forge-room, and machine-shop.

nd ample apparatus for teaching the various subjects in which instruction is given. Although the regular school exercises were begun only in February 1884, the total number of pupils enrolled is now 190.

In his Report for 1886, Mr. Andrew S. Draper, Superintendent of Public Instruction in the State of New York, points out that that State is now spending 14,000,000 dollars annually in support of its public school system; and he suggests that it might be well to spend a few thousands occasionally in efforts to determine the best way of using this vast sum. Mr. Draper puts some questions which show that he is far from being perfectly satisfied with the educational system he has to administer. 'Is there not,' he asks, "too much French, and German, and Latin, and Greek, and too little spelling, and writing, and mental arithmetic, and English grammar, being taught? Have we been as ambitious of progress in the lower grades as in the advanced? Are not our courses of study too complex? Are we not undertaking to do more than we are doing well? Is not the examination business being overdone? Are we not cramming with facts, which will soon be forgotten, rather than instilling principles which will endure?"

IN an article in the March number of the *Zoologist*, Mr. Robert Service tries to show that, until near the end of the first quarter of the present century, ptarmigan were natives of the south-west of Scotland. He thinks that when these birds were on the mountains of Dumfriesshire and Galloway they were probably also to be found on the Cumbrian Mountains. Mr. Service says that, in nearly all the outlying stations of the present range of ptarmigan in Scotland, such as Arran, Argyll, and the Outer Hebrides, they are decreasing.

MR. WILLIAM BURGESS, who owns an extensive pheasantry at Malvern Wells, has recently made some observations upon the red worm, which is one of the worst assailants of birds. He thinks it comes from the droppings of cattle, which when young are especially liable to the attacks of this insect. Mr. Burgess finds that agricultural salt acts as a remedy against it.

A DISCOVERY of great geological interest was lately made on Juckatoo Island, Sydney, in the shape of a Mastodonsaurus. There is a similar specimen from Stuttgart in the collection of the University, but this one is remarkable from the fact that it is the first Labyrinthodont found in Australia. It belongs to the Triassic age of the Hawkesbury Sandstone formation.

DR. WEILL, of Paris, having carefully studied the new therapeutical agent, antifebrine, or acetanilide, discovered by Cohn and Hepp, of Strasburg, says that it is an anæsthetic agent, and that it combats fever very effectually.

A FRENCH translation of the "Phantasms of the Living" is being prepared in Paris by M. Ch. Richet and some other persons.

M. HAYEZ, of Brussels, has issued a second edition of "A General List of Observatories and Astronomers, and of Astronomical Societies and Reviews," prepared by M. A. Lancaster, Librarian of the Royal Observatory of Brussels. The List has been drawn up with great care, and, from the fact that a second edition has been called for, we may assume that astronomers have found it of considerable service. The names and addresses of all well-known astronomers are given, and the compiler has noted every Observatory, whether public or private, in which work is actually being done.

IN the Proceedings of the U.S. National Museum, lately issued, there is a paper by Mr. G. H. Boehmer, on Norse naval architecture. Mr. Boehmer gives a clear and remarkably interesting account of the forms of boats represented in the ancient rock-sculptures of Sweden and Norway; of the boat-shaped stone burial-crouns supposed to have been erected during

the transition time from the Bronze period to the Iron Age; and of boat-remains dating from the third to about the ninth or tenth century of our era, and found at various times and places. The ship found at Tune, and the Gokstad ship, are carefully described. Mr. Boehmer thinks that the "Northland boats" now used in the fisheries along the coast of Norway are almost exactly like those which have always been used by Norsemen from the time of the rock-sculptures. These Northland boats are described as long, narrow, and low, light and elegant, and fit both for sailing and rowing.

THE additions to the Zoological Society's Gardens during the past week include a Black-winged Kite (*Elanus caeruleus*) from the Cape of Good Hope, presented by Mr. R. Southery; a Hawfinch (*Coccothraustes vulgaris*), British, presented by Mr. W. H. Quintin; two Pike (*Esox lucius*) from British fresh waters, presented respectively by Mr. H. E. Young and Mr. G. G. Sykes; two Gloved Wallabys (*Halmaturus manicatus* ♂ & ♀), two Cereopsis Geese (*Cereopsis novæ-hollandiæ*) from Australia, a Blossom-headed Parrakeet (*Palzornis cyanocephalus*) from India, received in exchange; two Pike (*Esox lucius*) from British fresh waters, purchased.

OUR ASTRONOMICAL COLUMN

SOLAR ACTIVITY IN 1886.—The latter part of 1886 showed a most remarkable falling off in the number and size of the sun-spots, a falling off so great as to lead so experienced an observer as Prof. Tacchini to speak of it as possibly the minimum of the eleven-year period. The following numbers, taken from Prof. Tacchini's tables (*Comptes rendus*, vol. ciii. No. 2, and civ. No. 4), may be compared with those we gave (*NATURE*, vol. xxxiii. p. 398) for the year 1885:—

	Relative frequency	Relative size of spots	Daily number of spot groups	Relative size of faculæ
January ...	8.84	60.42	2.00	47.63
February ...	6.30	29.00	1.70	32.10
March ...	14.39	84.78	3.87	43.91
April ...	8.13	51.91	3.00	41.32
May ...	6.50	52.77	1.92	37.81
June ...	7.14	25.22	2.32	37.14
July ...	8.30	39.93	2.17	35.42
August... ..	3.24	18.70	1.40	8.33
September ..	5.59	23.41	1.45	18.52
October ...	1.46	8.08	0.69	18.08
November ...	0.04	0.15	0.04	7.41
December ..	6.17	27.04	1.22	15.65

After the fine group of spots which were seen on May 7 and 8 had passed out of sight, the spots decreased in number and size pretty steadily until the end of October. From October 31 to December 12 there then ensued a long period of almost total quiescence. On six days only out of the forty-two could there be discovered on the sun any trace even of a spot, and on those days only one tiny spot could be seen. For an entire rotation and a half the sun was practically free from spots. M. Riccò has also drawn attention to this remarkable interval, and on searching the Palermo records for the earliest comparable period after the maximum of 1870, he finds a somewhat similar interval of quiescence in 1875, five years after the maximum of 1870, and nearly eight years after the minimum of 1867. The depression of last November follows the maximum of 1884 by less than three years, but the previous minimum by about eight years; reckoning from the minimum, the November depression follows the precedent of 1875, but reckoning from the maximum, it would appear to have occurred most exceptionally early. It would seem, therefore, that the irregularity has not been so much in the principal or secondary minima as in the maximum of 1884, which fell later than the mean by nearly two years. M. Riccò anticipates that the true minimum of the eleven-year period will fall in 1890.

A striking feature of the past year has been the great diminution, and for some months, the almost total cessation of spot activity in the northern hemisphere of the sun, nearly all the principal groups having been located in the southern hemisphere.

Faculæ and prominences have shown a falling off in 1886 but

one far less marked than that shown by the spots. The following numbers derived from notes by the Rev. S. J. Perry in the *Observatory* for February 1886, and March 1887, shows that the mean extent of the prominence arc has greatly diminished, though the mean height of the prominences has suffered little change. This diminution in extent was especially marked during the last three months of the year.

	Mean height of chromosphere, excluding prominences	Mean height of prominences	Mean extent of prominence arc
1885	8"00	28"67	28 25
1886	8"05	24"78	13 36
Mean 1880 to 1885	8"07	25"71	32 45

The "mean extent" for October is 9° 54', for November 7° 25', and for December 9° 31'.

COMET 1887 d (BARNARD, FEBRUARY 15).—Prof. Boss has furnished other elements of this comet than those he gave in his first circular, the first set of elements being thus superseded. They are as follows:—

$$T = 1887 \text{ March } 28.47$$

$$\left. \begin{aligned} \omega &= 36 \quad 37 \\ \delta &= 135 \quad 28 \\ i &= 139 \quad 45 \end{aligned} \right\} \text{Mean Eq. } 1887.0$$

$$\log q = 1.0059$$

Prof. Krueger (*Astr. Nach.*, No. 2774) has computed the following ephemeris for Greenwich midnight from these elements:—

1887	R.A.	Decl.	log ρ	log Δ
March 13	54 13	57 49 N.	0.0162	9.9430
15	52 53	57 11	0.0129	9.9730
17	51 44	56 39	0.0100	0.0008
19	50 41	56 11	0.0076	0.0265
21	49 46	55 46	0.0056	0.0400

THE WARNER OBSERVATORY.—Mr. Lewis Swift, director of the private observatory of Mr. Warner, of Rochester, N.Y., has recently published a pamphlet giving a description of the dome and 16-inch refractor and other accessories of the observatory. The great telescope has been used by Mr. Swift, since July 1883, in a systematic search for new nebulae, of which 540 have been discovered up to January 1, 1887. The places and descriptions of over 400 of them are given. Mr. Swift is also engaged in searching for comets. The pamphlet, in addition, contains a list of the recipients of the Warner Prizes for cometary and other astronomical discoveries, as well as a reprint of the essays on comets and on the "sky-glow" of 1883 and 1884, to which prizes have been adjudged.

ASTRONOMICAL PHENOMENA FOR THE WEEK 1887 MARCH 13-19

(FOR the reckoning of time the civil day, commencing at Greenwich mean midnight, counting the hours on to 24, is here employed.)

At Greenwich on March 13

Sun rises, 6h. 21m.; souths, 12h. 9m. 39'3s.; sets, 17h. 58m.; decl. on meridian, 2° 56' S.; Sidereal Time at Sunset, 5h. 22m.

Moon (at Last Quarter March 16) rises, 21h. 43m.*; souths, 3h. 8m.; sets, 8h. 23m.; decl. on meridian, 9° 34' S.

Planet	Rises		Souths		Sets		Decl. on meridian
	h. m.	h. m.	h. m.	h. m.	h. m.	h. m.	
Mercury	6 22	12 54	19 26	5 33	N.		
Venus	7 6	13 39	20 12	5 52	N.		
Mars	6 41	12 46	18 51	0 15	N.		
Jupiter	21 49*	2 52	7 55	11 53	S.		
Saturn	11 34	19 43	3 52*	22 29	N.		

* Indicates that the rising is that of the preceding evening and the setting that of the following morning.

Occultation of Star by the Moon (visible at Greenwich)

March	Star	Mag.	Disap.	Reap.	Corresponding angles from vertex to right for inverted image
14	γ Libræ	4½	3 56	5 10	82 252
17	14		Saturn stationary.		

Variable Stars

Star	R.A.		Decl.	h. m.
	h. m.	h. m.		
η Geminorum	6 8.1	22 32	N.	Mar. 15, 0 0 <i>M</i>
R Lyncis	6 51.9	55 29	N.	" 18, <i>M</i>
R Crateris	10 55.0	17 43	S.	" 19, <i>M</i>
δ Libræ	14 54.9	8 4	S.	" 16, 23 13 <i>m</i>
U Coronæ	15 13.6	32 4	N.	" 17, 3 18 <i>m</i>
U Ophiuchi	17 10.8	1 20	N.	" 13, 2 40 <i>m</i>
and at intervals of 20 8				
W Sagittarii	17 57.8	29 35	S.	Mar. 13, 22 0 <i>M</i>
U Sagittarii	18 25.2	19 12	S.	" 15, 21 0 <i>m</i>
R Sagittæ	20 8.9	16 23	N.	" 19, <i>m</i>
U Capricorni	20 41.9	15 12	S.	" 16, <i>M</i>
R Vulpeculæ	20 59.4	23 22	N.	" 19, <i>M</i>
δ Cephei	22 25.0	57 50	N.	" 18, 11 0 <i>M</i>

M signifies maximum; *m* minimum.

Meteor-Showers

	R.A.	Decl.	
Near α Persei	50	48 N.	
β Virginis	175	10 N.	Slow bright meteors.
δ Ursæ Majoris	185	58 N.	March 17.
β Draconis	263	50 N.	
η Serpentis	276	6 N.	Very swift meteors.
κ Cephei	300	80 N.	Slow bright meteors.

GEOGRAPHICAL NOTES

ON Tuesday last, the 8th inst., the Expedition under Mr. H. M. Stanley for the relief of Emin Pasha, arrived at Simons-town from Zanzibar. They were to resume their voyage on Wednesday, after taking supplies on board. Mr. Stanley is accompanied by Tippoo Tip, through whose agency, it is expected, Stanley Falls will be restored to the Congo State. Messengers have been sent across the continent to the Congo, and Mr. Stanley expects that a large addition to his caravan will be awaiting him when he arrives on the Upper Congo.

LIEUT. BAERT, of the Congo Free State, has recently made a journey up the Mongalla, a northern tributary of the Congo, considerably to the east of the Mobangi. The river had previously been navigated to some extent by Mr. Grenfell, but Lieut. Baert has succeeded in getting much beyond Grenfell's furthest. In fact, he attained the limit of navigation, at over 200 miles from the mouth of the river, where its course is broken by falls. The river flows in a general southward direction, through a well-wooded country, and its rapids are situated in about 3° 30' N. lat., and 22° E. long. The Mongalla is very sinuous; its rapids are situated in a mountainous district inhabited by a people named Sebi, who do good work in iron.

A FRENCH traveller, M. Chaffanjon, is exploring the Orinoco. He has already surveyed the Bolivar and the San Fernando, and discovered numerous errors in existing maps. He has made large collections in ethnology, archaeology, and philology. He hoped to solve the puzzling problem of the Casiquiare, and reach the sources of the Orinoco last December.

In the first number for 1887 of the *Mitteilungen* of the Vienna Geographical Society, is a German translation of the interesting paper by D. Isabelo de los Reyes, on the Tinguians of the Philippine Island, Luzon. The author is himself an Ilocan, a tribe which marches with the Tinguians, and has had exceptional opportunities of investigating the origin, and customs, and beliefs of his fellow-countrymen, and, being educated, can tell what he knows. A good map accompanies the paper, and to this Dr. Blumentritt contributes explanatory text. To the same number Herr Edward Glaser contributes a sketch of his journeys in South Arabia, which, while mainly for archaeological purposes, have yet been the means of adding much to our knowledge of the little-known South Arabian mountain-land.

THE *Bollettino* of the Italian Geographical Society for January publishes a detailed account of the recently acquired Italian possessions on the Red Sea coast, extracted from an official memoir presented to the Chamber of Deputies by S. E. di Robilant. These possessions are grouped under three separate divisions: (1) territory garrisoned and administered by Italy, including Massowa, Embermi, the Abd-el-Kader peninsula, Gherar, Taulud Island, and the neighbouring Dahlak Archipelago; (2) protected territory, comprising the

east-lands from Adulis (Annesley) Bay southwards to Assab, with stations at Hawakil, Mader, and Ed; (3) territory placed under the absolute sovereignty of Italy—Assab and surrounding district stretching for thirty-six miles between Ras Dermah and Ras Sinthiar, and including the neighbouring islets, annexed in July 1882. Massowa, the centre of government, occupies a strong position on an island connected by an embankment with Taulud, and defended by forts at Gherar and on the Abd-el-Kader peninsula. Since the Italian occupation it has been largely rebuilt in European style, and according to a rough census taken in September 1885 has a population of about 5000. There are several mosques, a Catholic church attached to the French mission, and a meteorological observatory where observations have been regularly recorded since May 1885. During this period the temperature has varied from 19°·1 C. in January, to 42°·8 in August, with a mean of about 26°·4.

DR. OTTO KRÜMMEL publishes in the *Zeitschrift für wissenschaftliche Geographie*, under the title of "The Relief of the Australian Mediterranean," i.e. the sea lying between Australia and the islands on the north, some valuable data as to recent soundings therein. They are as follows:—

S. Lat.	E. Long.	Depth in fathoms
4° 45'	123° 40'	90
4° 29'	123° 48'	110
4° 14'	123° 58'	80
3° 58'	124° 10'	55
3° 45'	124° 18'	60
3° 32'	124° 34'	60
3° 22'	124° 51'	75
3° 12'	125° 10'	90
3° 3'	125° 22'	120
2° 53'	125° 36'	105
2° 45'	125° 48'	90

On the other hand, Dr. Krimmel recalls the fact that we have the neighbouring Banda Sea in a depth of 2000 to 3000 fathoms. These data seem to indicate that between Celebes and Buru there exists a sub-oceanic ridge. We cannot say whether it extends over Ceram to New Guinea, and so indicates an ancient land-bridge between Asia and Australia, for between Ceram and New Guinea we have no soundings, and those on the borders of the strait between Buru and Ceram are from 1500 to 3000 fathoms.

MR. W. GRIGGS has published a facsimile of the famous map of the world lent by the Pope to the Colonial and Indian Exhibition, and placed in the West Indian section. This map, which is a copy of the chart in which Pope Alexander drew the line dividing the possessions of Spain and Portugal in the New World, was bequeathed to the Pope by the last of the Borgias in 1830, and has since then been preserved with much jealousy. It is drawn on a sheet of vellum seven feet long by three broad. The colours of the original are reproduced.

ON RADIANT-MATTER SPECTROSCOPY:—
EXAMINATION OF THE RESIDUAL GLOW.¹
II.

IN the search for bodies giving discontinuous phosphorescent spectra I have submitted a great number of earths and combinations to the electric discharge *in vacuo*, and have noted the results. As the superficial phosphorescence apart from the composition of the emitted light has formed the subject of several recent papers by my friend M. Lecoq de Boisbaudran, before the Académie des Sciences, it may be useful if I place on record some of the more striking facts which have thus come under my notice. The bodies are arranged alphabetically, and, unless otherwise explained, were tested in the radiant-matter tube in the form of ignited sulphates.

Alumina, in any of the forms which give the crimson line (λ6942—6937), has a very persistent residual glow. In the phosphoroscope rubies shine with great brilliancy. This phosphorescence of alumina has recently been the subject of a paper read before the Royal Society (Roy. Soc. Proc. vol. xlii., 1887, p. 25).

Antimony oxide with 95 per cent. of lime (in the form of ignited sulphate).—White phosphorescence, the spectrum showing a broad space in the yellow, cutting the red and orange off.

¹ Paper read before the Royal Society by Mr. William Crookes, F.R.S., on February 17. Continued from p. 448.

In the phosphorosopes the residual glow is very strong, and of a greenish colour. The spectrum of the residual light shows that the red and orange are entirely obliterated, leaving the green and blue very luminous. Antimony oxide with 99 per cent. of lime gives a pale yellowish phosphorescence, which on heating turns red. In other respects it is like the 5 per cent. mixture.

Arsenious acid with 99 per cent. of lime gives a greenish white phosphorescence like pure calcium sulphate.

Barium 5 per cent., calcium 95 per cent.—The sulphates phosphoresce green, with specks of yellow and violet. The spectrum is continuous, with slight concentration in the red, great concentration in the green, and in the orange a broad black band hazy at the edges.

Bismuth 15 per cent., calcium 85 per cent., phosphoresces of a bright reddish orange. The spectrum shows a tolerably sharp and broad dark band in the red and orange, and a strong concentration of light in the green and blue; the spectrum being continuous and divided into two parts by a black band in the yellow, as in the case of the antimony-calcium spectrum. In the phosphoroscope the red and orange disappear and the green and blue remain. Bismuth 7 per cent., calcium 93 per cent.—The action is similar to the 15 per cent. mixture, except the colour of the phosphorescence, which is whiter. In the phosphoroscope the red and orange below the dark band is cut off. With 2 per cent. of bismuth the same phenomena occur. With 0·5 bismuth the phosphorescence is greenish blue and the spectrum is continuous, with strong concentrations in the orange and green. The phosphoro cope cuts off the red and orange.

Cadmium 1 per cent., calcium 99 per cent.—Similar to calcium sulphate, *q.v.*

Calcium sulphate was prepared from a colourless and transparent rhomb of Iceland spar which had been used for optical purposes. It was dissolved in nitric acid, the nitrate was decomposed with distilled sulphuric acid, and the ignited sulphate tested in the tube. The phosphorescence is bright greenish blue without bands or lines. In the phosphoroscope the colour is a rich green; the spectrum shows the red and orange entirely cut off, leaving the green and blue; the blue is especially strong.

Calcium sulphates prepared from Prof. Breithaupt's calcites (Phil. Trans., 1885, Part II., p. 697) were re-examined. All phosphoresce with the normal greenish-blue glow of calcium, except No. 11, which gives a reddish glow. A minute trace of samarium was found in this calcite, but not enough to affect the colour of the glow. In the phosphoroscope all the specimens give a continuous spectrum beyond the yellow, the red and orange being cut off as usual.

Chromium 5 per cent., calcium 95 per cent., as sulphates, gives a pale reddish phosphorescence. In the phosphoroscope the colour is green, and the red and orange are cut off. 1 per cent. of chromium with calcium phosphoresces green in the cold, and becomes a red when slightly heated. The behaviour of chromium with aluminium has already been described (Roy. Soc. Proc. vol. xlii. p. 28, *et seq.*)

Copper sulphate with 95 per cent. calcium sulphate behaves like calcium sulphate.

Diamonds phosphoresce of various colours. Those glowing pale blue have the longest residual glow, next come those phosphorescing yellow; I am unable to detect any residual glow in diamonds phosphorescing of a reddish colour. A large diamond of a greenish hue, very phosphorescent, shines almost as brightly in the phosphoroscope as out of it.

Glucina phosphoresces of a rich blue colour. There appears to be no residual glow with this earth in the phosphoroscope.

Lanthanum.—All the specimens of lanthanum sulphate I have examined in the radiant-matter tube phosphoresce of a reddish colour, and give a broad hazy band in the orange, with a sharp line—1/λ²280—superposed on it. This is identical with the line of Ge, one of the constituents of the samarium phosphorescent spectrum. Calcium added to lanthanum changes the colour of the phosphorescence from red to yellowish, and brings out yttrium and samarium lines, these metals being present as impurities; the Gδ and Gα lines are also seen, but the space which should be occupied by the Gβ green is now a dark space. I have shown that when Gδ, Gα, and Gβ are present in very small quantities with lime, the lines of Gδ and Gα are intensified, while that of Gβ is weakened. This new result seems to show that if only a small trace of Gβ is present with lime and lanthanum, the green line is not only suppressed, but the quenching

action has actually extended so far as to neutralise that part of the continuous lime spectrum having the same refrangibility as the $G\beta$ line, the result being a black space in the spectrum. In the phosphoscope the line of $G\epsilon$ is visible at the lowest speed; $G\delta$ comes in at an interval of 0'0035 second, and the $G\alpha$ line immediately afterwards.

Lead sulphate, by itself, in the radiant-matter tube glows with a nearly white colour, giving a continuous spectrum. In the phosphoscope the red and orange are cut off, leaving a strong concentration of light in the green and blue. 5 per cent. of lead added to calcium sulphate phosphoresces like lime.

Magnesia phosphoresces pink. 5 per cent. with lime, as sulphates, give a greenish phosphorescence, with a tendency to turn red as the powder heats. The Oriental ruby containing about between 1 and 2 per cent. of magnesia, a mixture was prepared of acetate of alumina with 2 per cent. of magnesia, and tested after ignition. It gave no spectrum or lines. This was done to see if the crimson line of aluminium might be due to the presence of magnesia.

Nickel added to calcium sulphate in the proportion of 5 per cent. makes no alteration in the usual phosphorescent phenomena of calcium.

Potassium, 5 per cent., added to calcium sulphate gives a bright phosphorescence, and made the residual glow very persistent.

Samarium.—The phosphorescent behaviour of this body, alone and mixed with other substances, has been fully described in my paper on samarium (Phil. Trans., 1885, Part II., pp. 709-21.)

Scandium, either in the form of earth or sulphate, phosphoresces of a very faint blue colour, but the light is too feeble to enable a spectrum to be seen. Addition of lime does not bring out any lines.

Sodium sulphate mixed with an excess of calcium sulphate gives a greenish tinge to the usual colour of the phosphorescence. The sodium line is visible in the spectrum.

Strontia in the radiant-matter tube glows with a rich blue colour, showing in the spectroscopy a continuous spectrum with a great concentration of light in the blue and violet. In the phosphoscope the colour of the glow is bright green, showing in the spectroscopy a continuous spectrum, with the red and blue ends cut off. A mixture of calcium sulphate with 5 per cent. of strontium sulphate behaves like calcium sulphate alone.

Thorium, as oxide or sulphate, refuses to phosphoresce, and the tube rapidly becomes non-conducting. A tube with thoria at one end and a phosphorescent earth such as lime or yttria at the other end, and furnished with a pair of poles near each end, at a particular exhaustion is non-conducting at the thoria end, while it conducts at the yttria end. If the wires of the induction coil are attached to the poles at the thoria end, no current will pass; rather than pass through the tube, the spark prefers to strike across the spark gauge—a striking distance of 37 mm.—showing an electromotive force of 34,040 volts. Without doing anything to affect the degree of exhaustion, on transferring the wires of the induction coil from the thoria to the yttria end, the spark passes at once. To balance the spark in air the wires of the gauge must be made to approach till they are only 7 mm. apart, equivalent to an electromotive force of 6440 volts; the fact of whether thoria or yttria is under the poles making a difference of 27,600 volts in the conductivity of the tube. The explanation of this action of thoria is not yet quite clear. From the great difference in the phosphorescence of the two earths, it is evident that the passage of the electricity through these tubes is not so much dependent on the degree of exhaustion as upon the phosphorogenic property of the body opposite the poles. This view is supported by the fact that the thoria may be replaced by a metal wire, when the same obstructive action will result.

Lime does not give phosphorescent properties to thoria, if this earth be pure, but it brings out the lines of yttrium and samarium which are almost always present in small quantities in thoria unless it has been specially purified.

Tin with 95 per cent. of lime gives the lime phosphorescence only.

Thulium and *erbium* together phosphoresce with a green light, giving the erbium spectrum already described before this Society (Roy. Soc. Proc. vol. xl. p. 77, Fig. 1, January 7, 1886). There is, in addition, a faint blue line apparently double (see "Ytterbium"). The addition of lime causes the mixture to phosphoresce of a pale blue colour. The spectrum now shows a bright blue band, in the same position as the faint double blue

band seen in the absence of lime. The blue line of $G\alpha$ is also seen, and a faint line of $G\delta$. The red line of $G\eta$, one of the constituents of the ordinary yttria spectrum, is prominent in this spectrum.

Tungsten and *uranium*, each mixed with 95 per cent. of lime, only give the lime spectrum.

Ytterbium.—I have not yet succeeded in preparing this body of trustworthy purity; but through the kindness of Prof. Clève, M. de Marignac, and Prof. Nilson, I have been enabled to experiment with specimens of ytterbia prepared by these chemists. Prof. Clève's ytterbia, in the form of sulphate, gives in the radiant-matter tube a blue phosphorescence, the spectrum of which shows a strong double blue band,¹ together with traces of the $G\delta$ and the erbia green lines. The addition of lime broadens the blue band and makes it single. Prof. Clève writes that this ytterbia may contain some traces of thulia, perhaps also of erbia, but scarcely any other impurities. Measurements in the spectroscopy give the following approximate results:—

Scale of spectro-scope	λ	λ^2	Remarks
8.63	4626	4673	Commencement of first blue line. This edge is very hazy.
8.54	4574	4780	Centre of the first blue line.
8.45	4524	4885	End of first blue line.
8.44	4518	4898	Centre of dark interval between the two blue lines.
8.40	4475	4994	Centre of second blue line. This line is narrower than the first line.

The following are measurements taken with the mixture of this ytterbia and lime:—

Scale of spectro-scope	λ	λ^2	Remarks
8.71	4674	4577	Up to this point there is the continuous spectrum of li-calcium. Here a black space commences.
8.515	4555	4819	Commencement of a hazy blue band.
8.475	4538	4855	End of hazy blue band. This band is of considerable brilliancy.

These blue bands are seen much fainter without lime, and are about as strong in the mixture of thulia and erbia with lime described above. I had ascribed them to ytterbia, when Prof. Nilson kindly forwarded me a small specimen of ytterbia, considered by him perfectly pure, and used for his atomic weight determinations. This ytterbia gives absolutely no blue bands. The origin of these bands therefore remains uncertain.

Ytterbia from Prof. Nilson, in the form of sulphate, refuses to phosphoresce without the addition of lime. When lime is added it only brings out traces of the phosphorescent bands of $G\epsilon$, $G\beta$, and $G\alpha$. Evidently these are impurities.

Ytterbia from M. de Marignac is identical with that from M. Clève, as far as my examination can go. In sending me this ytterbia M. de Marignac warned me that he was very far from thinking it pure.

Yttrium.—During the fractionation of the higher fractions of yttria (+6, 118 and 119), a very sharp green line sometimes makes its appearance, situated between $G\beta$ and $G\gamma$ (approximate position on the $1/\lambda^2$ scale, 325). It is very faint, and is not connected with the orange line of $S\delta$, although it is as sharp. The yttria showing these lines phosphoresces of a transparent golden-yellow colour, the fractions at the other end phosphorescing yellowish green.

I have previously described the action of a large number of

¹ This is the band spoken of in my Royal Society paper of June 9 last (Roy. Soc. Proc. vol. xl. 1886, p. 507), provisionally called $S\gamma$, and ascribed to ytterbia. If it is not due to ytterbia it is a new body.

bodies on the phosphorescence of samarium ("On Radiant-matter Spectroscopy; Part 2, Samarium," Phil. Trans., 1885, Part II. pp. 710-22.) The experiments resulting in the following observations were tried at about the same time. I will describe them in alphabetical order. Unless otherwise mentioned all the mixtures were in the form of anhydrous sulphates.

Yttrium 5 per cent., *aluminium* 95 per cent., gives a good yttria spectrum; the blue line of $G\alpha$ is very distinct, and the double green of $G\beta$ is well divided. In the phosphoroscope the $G\beta$ and $G\alpha$ lines first appear simultaneously, then the $G\delta$ line.

Yttrium 99.5 per cent., *bismuth* 0.5 per cent.—The spectrum is bright, and on close examination a trace of samarium green, $G\gamma$, is to be detected forming a wing to the $G\delta$ line. In the phosphoroscope the citron line of $G\delta$ entirely disappears and the samarium double green line, which out of the phosphoroscope is almost obscured by the great brightness of $G\delta$, now appears distinctly, together with the green $G\beta$ line. *Yttrium* 95 per cent., *bismuth* 5 per cent., gives the usual yttria spectrum. No $G\delta$ line appears in the phosphoroscope at any speed. At first only the $G\beta$ line is seen, and next the $G\alpha$ line appears, as in yttria. On gradually increasing the percentage of bismuth the spectrum of yttria grows fainter, until with 95 per cent. of bismuth the phosphorescence is bad and the spectrum faint.

Yttrium 5 per cent., *cadmium* 95 per cent., gives a brilliant phosphorescence, but the spectrum is almost continuous. In the phosphoroscope a faint concentration of light is seen in the green, which becomes sharper as the speed increases.

The action of calcium on the phosphorescence of yttrium has already been described.

Yttrium and *cerium*.—Cerium has the effect of deadening the brilliancy of the yttrium spectrum in proportion to the quantity added. All the bands remain of their normal sharpness.

Yttrium 5 per cent., *copper* 95 per cent., phosphoresces very feebly.

Yttrium 90 per cent., *didymium* 10 per cent.—This mixture gives a good yttria spectrum. *Yttrium* 70 per cent., *didymium* 30 per cent., phosphoresces very fairly, and gives all the usual lines.

Yttrium 50 per cent., *didymium* 50 per cent., refuses to phosphoresce. The tube is either too full of gas to allow the phosphorescence to be seen or it becomes non-conducting. When the mixture is illuminated by the glowing gas the absorption-lines of didymium in the green are seen. With higher proportions of didymium the same results are produced. On adding 25 per cent. of lime to the mixture containing 50 per cent. of didymium the yttria spectrum is brought out very well. Lime added to a mixture of 10 per cent. yttria and 90 per cent. didymium brings out the yttrium spectrum fairly, but the tube soon becomes non-conducting.

Yttrium 5 per cent. and *gucinum* 95 per cent. gives a bright phosphorescence, but the definition of the spectrum lines of yttria is bad.

Yttrium 5 per cent., *thallium* 95 per cent.—No spectrum is given by this mixture; it turns black and refuses to phosphoresce.

Yttrium 5 per cent., *tin* 95 per cent., phosphoresces faintly, the lines being very indistinct.

Yttrium 5 per cent., *titanium* 95 per cent., acts like thoria, and the tube becomes non-conducting.

Yttrium 5 per cent., *tungsten* 95 per cent.—This phosphoresces of a bright yellow colour, the spectrum is brilliant, but the lines are not sharply defined. In the phosphoroscope the colour becomes greenish, and the spectrum shows only the green lines of $G\beta$.

Yttrium 5 per cent., *zinc* 95 per cent.—The phosphorescence is of a pale yellowish-white, and the spectrum is very brilliant, being equal to that shown by 30 per cent. of yttrium with barium, calcium, magnesium, or strontium. In the phosphoroscope the colour becomes reddish, and the $G\beta$ green line is the first to come. No citron line is seen. If the yttrium contains a trace of samarium, the samarium spectrum, which is scarcely seen under ordinary circumstances, now comes out distinctly.

Zinc sulphate mixed with 95 per cent. of calcium sulphate phosphoresces a bright bluish-green colour; the spectrum contains no bands or lines.

Zinc sulphide (Sidot's hexagonal blende, *Comptes rendus*, vol. lxiii., 1886, pp. 999-1001; vol. lxiii., 1886, pp. 188-89).—This is the most brilliant phosphorescent body I have yet met with. In the vacuum tube it begins to phosphoresce at an exhaustion of several inches below a vacuum. At first only a

green glow can be seen; as the exhaustion gets better a little blue phosphorescence comes round the edges. At a high exhaustion, on passing the current the green and blue glows are about equal in brightness, but the blue glow vanishes immediately the current stops, while the green glow lasts for an hour or more. In the phosphoroscope the blue glow is only seen at a very high speed, but the green glow is seen at the slowest speed, and the body is almost as bright in the instrument as out of it. Some parts of a crystalline mass of blende which, under the action of radiant matter, leave a glow with a bright blue colour, leave a green residual light when the current ceases; other parts which glow blue become instantly dark on stopping the current.

The different action of calcium, barium, and strontium on the constituents of yttrium is an additional proof, if confirmation be needed, that the bodies I have provisionally called $G\alpha$, $G\beta$, $G\delta$, &c. (Roy. Soc. Proc. vol. xl. 1886, p. 502), are separate entities. It may be as well here to collect together the evidence on which I rely to support this view. I will take the bodies *seriatim* :—

$G\alpha$.—An earth phosphorescing with a blue light, and showing in the spectroscopy a deep blue line, of a mean wave-length 482. This earth occurs in different proportions in purified yttria from different minerals. Samarskite, gadolinite, hielmite, monazite, xenotime, euxenite, and arrhenite contain most $G\alpha$, whilst fluocerite and cerite contained notably less of this constituent. The addition of lime brings out the phosphorescence in $G\alpha$ in advance of that of the other constituents. The behaviour in the phosphoroscope of $G\alpha$ when mixed with the alkaline earths also points to a difference between it and its associates. With lime the blue phosphorescent band of $G\alpha$ comes into view at a very low speed, the order of appearance with a small quantity of lime being $G\beta$, $G\alpha$, $G\delta$, and with a large quantity of lime, $G\delta$, $G\alpha$, $G\beta$. Employing strontia instead of lime, the order of appearance in the phosphoroscope when the quantity of strontia is small is $G\beta$, $G\alpha$, $G\eta$, and when the quantity of strontia is in excess, $G\alpha$, $G\eta$, $G\beta$. Baryta in small quantity brings out the lines in the phosphoroscope in the following order, $G\beta$, $G\alpha$, $G\eta$; but when the baryta is in excess the order is $G\beta$, $G\eta$, $G\alpha$. The chemical position taken up by $G\alpha$ in the fractionation scheme precludes it from being due to the bodies I have called $G\beta$, $G\gamma$, $G\epsilon$, $G\zeta$, $G\eta$, or $G\delta$. It closely accompanies $G\delta$ (the earth giving the citron line), concentrating at the least basic end, and I have not yet succeeded in effecting a separation of the two. If, therefore, $G\alpha$ is not a separate entity, its blue line must be due to the citron-band-forming body called $G\delta$. The difference between $G\alpha$ and $G\delta$ is brought out in a marked manner by the phosphoroscope when baryta or strontia is present; the citron line of $G\delta$ being entirely suppressed, while the blue line of $G\alpha$ is brought out with enhanced brilliancy. For these reasons I am inclined to regard $G\alpha$ as a separate body, although the evidence in favour of this view is not so strong as in the case of some of its other associates.

$G\beta$.—An earth phosphorescing with green light, and showing in the spectroscopy a close pair of greenish-blue lines of a mean wave-length of 545. This earth can be separated by chemical fractionation from the other constituents of yttrium. It concentrates at the most basic end, and is present in the samarium which invariably makes its appearance at this end of the fractionation of yttrium. It is one of the prominent lines in $Y\alpha$, where also it accompanies some of the samarium lines. $G\beta$, however, is not a constituent of samarium, for it is easy to purify samarium by chemical means so that it does not show a trace of the $G\beta$ green lines, although it is very difficult to get $G\beta$ free from some of the samarium lines. The residual phosphorescence of $G\beta$ is very considerable, and its green lines show first in the phosphoroscope when only yttrium is present. The addition of lime keeps back the glow of $G\beta$, and brings forward that of $G\delta$. Strontium and barium act on $G\beta$ very differently to lime. A small quantity of strontium brings forward the residual glow of $G\beta$, whilst in large quantities strontium keeps the phosphorescence of $G\beta$ back to the last.

$G\gamma$.—An earth phosphorescing with a green colour, and showing in the spectroscopy a green line having a wave-length of 564. This is one of the least definite of all the supposed new bodies. It appears to be a constituent of samarium, occurring in the fractionation of yttrium among the most basic constituents connecting yttrium and samarium. Its point of maximum intensity is, chemically, very well marked, and is at a different part of the fractionation scheme to those of the other lines of

samarium, especially $G\epsilon$. On dilution with lime, the phosphorescent line of $G\gamma$ vanishes before that of $G\epsilon$.

$G\delta$.—An earth phosphorescing with a citron coloured light, and showing in the spectroscope a citron line having a wave-length of 574. $G\delta$ is one of the least basic of all the bodies associated in yttrium, occurring almost at one extremity of the fractionation. It is not very difficult to separate chemically $G\delta$ from all the other accompanying bodies except the one which I have called $G\alpha$ (giving the deep blue line). Not only can $G\delta$ be obtained free from the other four constituents of yttrium, but the body called by M. de Marignac $Y\alpha$ is a proof that the other four components of yttrium can be obtained quite free from $G\delta$. Lime intensifies the phosphorescence of $G\delta$, and deadens that of $G\beta$, while strontium has the opposite action. The behaviour of $G\delta$ in the phosphorescope, when mixed with lime, strontia, or baryta, also affords a striking evidence of individuality, lime enhancing the residual glow, while strontia or baryta altogether suppress it.

$G\epsilon$.—An earth phosphorescing with a yellow colour, and, in the spectroscope, showing a sharp yellow line having a wave-length of 597. It is seen in the samarium spectrum as a sharp yellow line superposed on a hazy double band. As I have already pointed out, $G\epsilon$ fractionates out high up among the most basic earths, and generally accompanies lanthanum. In the phosphorescent spectrum of lanthanum the line $G\epsilon$ is seen quite free from the lines of other bodies.

$G\zeta$.—An earth phosphorescing with a red light, showing in the spectroscope a red line of wave-length 619. This body is always more plentiful in yttrium obtained from samarskite and cerite than from gadolinite, hielmite, and euxenite, and is almost absent in yttrium from xenotime. $G\zeta$ is of about intermediate basicity. Working with samarskite yttria, $G\zeta$ becomes most

brilliant after the line of $G\eta$ has completely disappeared. Further fractionation causes the line of $G\zeta$ to fade out, and the citron and blue lines are then left.

The phosphorescence of $G\zeta$ is developed to a different extent according to the metal with which the yttria is mixed. The order (beginning with the substance having the greatest action) is zirconium, tin, aluminium, bismuth, glucinum.

$G\eta$.—An earth phosphorescing with a deep red light, and showing in the spectroscope a red line having a wave-length of 647. Like its fellow red constituent, $G\eta$ occurs most plentifully in samarskite yttrium, and scarcely at all in yttrium from hielmite, euxenite, and cerite. It is the first of the strictly yttrium constituents to separate out, on fractionation, at the most basic extremity, leaving $G\alpha$, $G\beta$, $G\delta$, and $G\zeta$. In almost all samples of yttria, except when very highly purified, $G\eta$ is seen very brilliantly, and by its side can be detected the faint red band of samarium. In the phosphorescope the line of $G\eta$ is the last to appear when yttria alone is being observed; strontia and baryta enhance the residual glow of $G\eta$, strontia in moderate quantities bringing it out before that of $G\beta$, while baryta brings it out after $G\beta$.

$S\delta$.—An earth giving in the spectroscope when phosphorescing a very sharp orange line of wave-length 609. I have already (Roy. Soc. Proc. vol. xl. 1886, p. 504) discussed the claims of this earth to be considered a separate entity. It is not present in the rare earths from gadolinite, xenotime, monazite, hielmite, euxenite, and arrhenite; it is present in small quantity in cerite, and somewhat more plentifully in samarskite. In samarskite yttrium it concentrates at a definite part of the fractionation. Its sharp orange line is not strong enough to be seen in the phosphorescope. A little calcium entirely suppresses the orange line, while samarium or yttrium seems to intensify it.

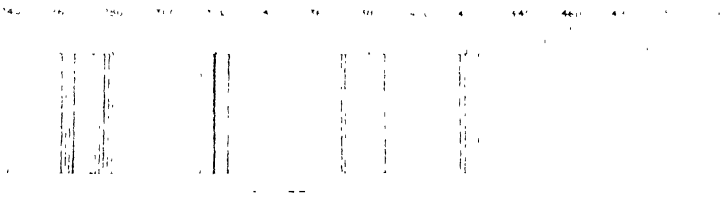

FIG. 5.

In addition to the above earths, it is not improbable that the sharp green line ($\frac{1}{\lambda^2}$ 325) mentioned under the heading "Yttrium" may be caused by still another earth.

The brilliant and characteristic spark spectra yielded when certain elements are volatilised and rendered incandescent by the spark from a powerful induction coil are relied on by chemists as an indisputable proof of the identity of such elements. Bearing this in mind I have endeavoured to ascertain how these yttrium constituents would behave in respect to the spark spectrum. Do the definite system of lines in the old yttrium spark spectrum belong to one constituent only, or are the yttrium lines broken up and distributed among the different bodies I have designated as $G\alpha$, $G\beta$, &c.? Also do the other constituents possess special spark spectra of their own? Very careful and long-continued experiments have shown me that neither of these hypothetical cases occur.

The spark spectrum given by old yttrium is shown in the drawing (Fig. 5). It is chiefly characterised by two very strong groups of lines in the red and orange. I now take the earth $G\delta$. This occurs near one end of the fractioning, and not only differs from the parent yttrium in its phosphorescent spectrum, but by virtue of the process adopted for its isolation it must likewise differ in its chemical properties. On examining its spark spectrum I see absolutely no difference between this spectrum and the one given by old yttrium.

I now pass to the other end of the fractionation of yttrium, where occurs a concentration of a body giving a totally different phosphorescent spectrum from the one at the first end. And it also differs chemically from old yttrium, and in a more marked manner from its brother, $G\delta$, at the other extremity of the fractionation. Here again its spark spectrum is perfectly identical both with old yttrium and with $G\delta$, and however closely I

examine these three spectra in my laboratory, the whole system of lines is still identical.

Respecting the theoretical considerations involved in these results, I see two possible explanations of the facts brought forward. According to one hypothesis, research has somewhat enlarged the field lying between the indications given by ordinary coarse chemistry and the searching scrutiny of the prism. Our notions of a chemical element have expanded. Hitherto, the molecule has been regarded as an aggregate of two or more atoms, and no account has been taken of the architectural design on which these atoms have been joined. We may consider that the structure of a chemical element is more complicated than has hitherto been supposed. Between the molecules we are accustomed to deal with in chemical reactions and the ultimate atoms, come smaller molecules or aggregates of physical atoms; these sub-molecules differ one from the other, according to the position they occupied in the yttrium edifice.

An alternative theory commends itself to chemists, to the effect that the various bodies discussed above are new chemical elements differing from yttrium and samarium in basic powers and several other chemical and physical properties, but not sufficiently to enable us to effect any but a slight separation. One of these bodies, $G\delta$, gives the phosphorescent citron line, and also the brilliant electric spectrum. The other seven do not give electric spectra which can be recognised in the presence of a small quantity of $G\delta$, whilst the electric spectrum of $G\delta$ is so sensitive that it shines out in undiminished brilliancy even when the quantity present is extremely minute. In the process of fractionation, $G\alpha$, $G\beta$, $G\delta$, &c., are spread out and more or less separated from one another, yet the separation is imperfect at the best, and at any part there is enough $G\delta$ to reveal its presence by the sensitive electric spark test. The arguments in favour of each theory are strong and pretty evenly balanced.

The compound molecule explanation is a good working hypothesis, which I think may account for the facts, while it does not postulate the rather heroic alternative of calling into existence eight or nine new elements to explain the phenomena. However, I submit it only as an hypothesis. If further research shows the new element theory is more reasonable, I shall be the first person to accept it.

Neither of these theories agrees with that of M. Lecoq de Boisbaudran, who also has worked on these earths for some time. He considers that what I have called old yttrium is a true element, giving a characteristic spark spectrum, but not giving a phosphorescent spectrum *in vacuo*. The bodies giving the phosphorescent spectra he considers to be impurities in yttrium. These he says are two in number, and he has provisionally named them $Z\alpha$ and $Z\beta$. By a method of his own, differing from mine, M. de Boisbaudran obtains fluorescent spectra of these bodies; but their fluorescent bands are extremely hazy and faint, rendering identification difficult. Some of them fall near lines in the spectra of my $G\beta$ and $G\delta$. At first sight it might appear that his and my spectra were due to the same bodies, but according to M. de Boisbaudran the chemical properties of the earths producing them are widely distinct. Those giving phosphorescent lines by my method occur at the yttrium extremity of the fractionation, where his fluorescent bands are scarcely shown at all; whilst his fluorescent phenomena are at their maximum quite at the terbium end of the fractionation, where no yttrium can be detected even by the direct spark, and where my phosphorescent lines are almost absent.

UNIVERSITY AND EDUCATIONAL INTELLIGENCE

CAMBRIDGE.—Girton College has withdrawn from the arrangement by which it was hoped that a united scholarship for men and women might be established in geology and palæontology out of the Harkness fund. The council of Girton do not consider that the scheme proposed fulfils the essential condition of placing students of Girton and Newnham on the same terms as members of the University. A scheme has consequently been propounded for men alone, open to B.A.'s of not more than four years' standing. The electors are to be the Vice-Chancellor, the Woodwardian Professor, the Examiners in Geology in the Natural Sciences Tripos for the current and the preceding year, and an additional elected examiner. The electors are to take any steps they think desirable to ascertain the qualifications of candidates, and in making the award they are to have regard to proficiency in geology and palæontology, and to promise of future work. One scholar is to be elected annually; but in case no person shall be deemed worthy of election, the income for the year is to go to a reserve fund, to be given, when advisable, to scholars to aid them in prosecuting geological or palæontological researches.

The acceptance of the John Lucas Walker Student-ship for the furtherance of original research in pathology, which has been offered to the University by the Attorney-General, is to be voted on in the Senate to-day. The amended regulations provide that the studentship shall be usually tenable for three years, with power of further prolongation for two years more when exceptionally valuable work has been done by the student. The fund, consisting of about 8300*l.* 4 per cent. debentures, is to be managed by the Professor of Pathology for the time being, the Professors of Physic and Physiology, and the President of the London College of Physicians. The studentship is not to be awarded by competitive examination, but any other mode of ascertaining qualifications may be taken. After full announcement of a vacancy, the Professor of Pathology is to nominate the best qualified candidate, but the other electors may overrule the nomination if they are unanimous in favour of some other candidate. The student shall not necessarily be a member of Cambridge University, and may be of either sex. No occupation interfering with pathological research may be followed by the student, who is also to vacate his studentship if elected to a professorship or fellowship. At least three terms of study are to be pursued at Cambridge. Exhibitions or prizes not exceeding 50*l.* may from time to time be awarded by the managers to any person, except the student for the time being, in respect of any essay, discovery, or meritorious service connected with or conducing to the science of pathology, and grants may be made for the furtherance of original research in the science.

The amended regulations for the Mechanical Sciences Tripos also come to a vote to-day.

The Senate has accepted the subscription of 500*l.* offered through Prof. Newton to enable the University to become a Governor of the Marine Biological Association.

The following new appointments of electors to various Professorships have been made: Botany, Mr. Thiselton Dyer; Political Economy, Right Hon. A. J. Balfour, M.P.; Experimental Physics, Dr. D. MacAlister; Downing Professorship of Medicine, Dr. A. Macalister; Mental Philosophy and Logic, Prof. A. Marshall; Surgery, Dr. A. Macalister. The remaining appointments are re-elections.

SCIENTIFIC SERIALS

American Journal of Science, February.—Kilauea after the eruption of March 1886. Under this general heading are grouped three separate papers, disposed in chronological order, describing the appearance of the volcano at different times since the great outburst of last March. The first is a communication to Prof. W. D. Alexander, Surveyor-General of the Hawaiian Islands, by J. S. Emerson, assistant in the Survey, dated August 27, and embodying a series of observations ranging from March 24 to April 14. This paper is illustrated by a plate showing the crater and new lake drawn to a scale of 1 : 20,000. The second, by L. L. Van Slyke, Professor of Chemistry, Honolulu, describes the general appearance of the volcanic district during the month of July, when considerable changes had already occurred, including a general upheaval in the centre of Halema'uma'u, and the reappearance of liquid lava in three different places. The third comprises a report to Prof. Alexander by Mr. Frank S. Dodge, on the survey of Kilauea in the last week of September and the first of October, with a plate of the crater on a scale of 1 : 6300. This observer expects that perhaps in a few months the great central pit will again fill up and overflow, as it did prior to the last eruption.—Volcanic action, by James D. Dana. The general question of igneous disturbances is discussed in connection with the recent eruptions of Kilauea, Vesuvius, and Tarawera. The author's conclusions on the causes of these phenomena, as summed up in his "Manual of Geology" (1863), are mainly confirmed, being attributed to the hydrostatic pressure of the column of lava; the pressure of vapours escaping in underground regions from the lavas, or produced by contact with them, acting either quietly or catastrophically; and the pressure of the subsiding crust of the crust forcing up the lavas in the conduit.—On the Coahuila meteorites, by Oliver Whipple Huntington. It is shown that the assumed new meteorite discovered near Fort Duncan, Maverick County, Texas, and recently described by Mr. W. E. Hidden, is really one of the "Coahuila irons," described by J. Lawrence Smith, and supposed to belong to one fall, although found on the opposite side of the Rio Grande from Maverick County.—A new rhizostomatous Medusa from New England, by J. Walter Fewkes. This is a large acraspedote jelly fish, not only new to New England, but also unlike any yet captured on the Atlantic coast of North America. It was captured in September 1886 in New Haven harbour, and is allied to a common species found on the west European seaboard, *Pilma* (*Rhizostoma*, auth.) *octopus*, Haeck., and to *F. pulmo* of the Mediterranean.—A short study of the atmosphere of β Lyrae, by Orray T. Sherman. The author's observations lead to the conclusion that in stars known to possess a spectrum comprising bright lines, these lines, while persistent in place, are not persistent in intensity. Comparing Lockyer's result in the study of the atmosphere with his own, he draws a general conclusion regarding the condition of the stellar atmosphere, describing it as consisting of an outer layer of hydrogen positively electrified, an inner layer of oxygen negatively electrified, and between them a layer of carbon mingling on its edge with the hydrogen. The electric spark passing through the mixture forms the hydrocarbon compound, whose molecular weight carries it into the oxygen region where combustion ensues with the formation of carbonic acid and aqueous vapour, both of which descending under the influences of their molecular weight are again dissociated by internal heat, and return again to their original positions.—Phenacite from Colorado, by Samuel L. Penfield, with notes on the locality of Topaz Butte, by Walter B. Smith. Some interesting facts are communicated with regard to the crystallisation of this remarkable mineral, the occurrence of which in the United States (Pike's Peak, El Paso County, Colorado), was determined by Messrs. Cross and Hillebrand.

Topaz Butte, five miles north of Florissant, marks the southern limit of the "crystal beds" whence have come most of the specimens labelled *Pike's Peak*. The largest phenacite ever found in this locality is a rough lenticular crystal about 15 mm. in diameter.—The norites of the Cortlandt series on the Hudson River, near Peekskill, New York, by George H. Williams. In continuation of his memoir on the peridotites of the Cortlandt series (*American Journal of Science*, 1886, p. 26) the author here begins a petrographic description of the massive rocks of this system. The present paper deals with the non-chrysolitic rocks, norite proper and hornblende norite. He designates all rocks in which one-half or more of the non-feldspathic constituents are hypersthene as norite, and names varieties of this after the prevailing accessory component.—A method for subjecting living protoplasm to the action of different liquids, by George L. Goodale. An apparatus is described by means of which the necessity is obviated of transferring specimens from the litre-flask to the stage of the microscope, all handling being thus avoided, while the object can be placed under the action of as large a quantity of liquid as may be desirable.—On the topaz from the Thomas Range, Utah, by A. N. Alling. The topaz crystals here under examination are from the cabinet of Prof. Brush, vary in length from 3 mm. to 10 mm., and are perfectly clear and colourless.—On a simple and convenient form of water battery, by Henry A. Rowland. A simple, convenient, and cheap form of water battery is described, which the author has had in use for many years.

Bulletin des Sciences Mathématiques, tome x. December 1886, tome xi. January 1887, Paris.—We single out these two recently issued parts, as they contain papers on subjects intimately connected with notices of Greek geometry, which we have from time to time communicated to NATURE when giving an account of Dr. Allman's contributions to *Hermathena*. In the *Mélanges* of the earlier number M. Paul Tannery has two notes: one of nine pages, entitled "Démocrite et Archytas" (see Gow's "History," p. 129, and NATURE, vol. xxxiv. p. 548); the other, of eleven pages, on "Les Géomètres de l'Académie." The latter part has an article of twelve pages, by the same writer, on "La Technologie des Éléments d'Euclide." All three are quite up to M. Tannery's well-known excellent form for thoroughness of research and soundness of inference. The rest of the matter consists as usual of reviews (*inter alia*, of the French translation of Clerk Maxwell's "Electricity and Magnetism" and Mr. Greenhill's "Differential and Integral Calculus"), and of useful abstracts of papers in the various Continental and British mathematical journals.

SOCIETIES AND ACADEMIES

LONDON

Royal Society, February 24.—"Problems in Mechanism regarding Trains of Pulleys and Drums of Least Weight for a given Velocity Ratio." By Prof. H. Hennessy, F.R.S.

As trains of wheels, pulleys, and drums are frequently employed in machinery for the transformation of large and small velocities of rotation, it appeared to the author desirable to inquire into the conditions which would favour the greatest economy of weight of the parts forming such trains. Eighty years since Dr. Thomas Young had arrived at a theorem for the minimum number of teeth in a train of wheels and pinions with a given velocity ratio, and when the pairs of wheels and pinions are similar. By investigating the question of minimum volume or minimum weight of trains the author has been led to the following results, which are fully demonstrated in his paper: namely, that for a train of cylindrical pulleys composed of similar pairs the ratio of the diameter of a large to that of a small pulley should be as 19 to 10. For drums composed of hoops supported by disks of the same thickness, and with the breadth of each hoop equal to the radius of the small drum, the ratio of the diameters should be 11 to 5. If the hoop was supported by spokes whose volume taken together would be half the volume of a complete disk, the ratio would be 51 to 20. With regard to a train of pulleys, it was shown that a single pair possessing the same velocity ratio as a series with the ratio of diameters found for minimum volume, the latter would be considerably less than the former. Thus, with five pairs whose velocity ratio would be nearly 244, the volume would be less than the 1/26 of a single pair possessing the same velocity ratio. A model constructed in brass of such a train, with all the large pulleys 1.9 inches in diameter,

and all the small 1 inch, weighed 18.34 ounces. A train of four pairs of drums illustrative of the last problem solved weighed 16.788 ounces, the large drums being 2.55 inches, and the small 1 inch diameter, while all the hoops were half an inch broad. The velocity ratio of this train is 42.2825, or a little more than 424.

March 3.—"The Etiology of Scarlet Fever." By E. Klein, M.D., F.R.S., Lecturer on General Anatomy and Physiology at the Medical School of St. Bartholomew's Hospital, London.

The investigation, the results of which I now record, was commenced at the end of December, 1885. It arose out of an inquiry into the prevalence of scarlatina in different quarters of London, undertaken by the Medical Department of the Local Government Board as a part of its business of investigating local epidemics. That inquiry had demonstrated milk from a farm at Hendon as the cause of the scarlatina, and had adduced strong circumstantial evidence that the scarlatina had been distributed, not in the whole, but in certain sections of the Hendon milk, and further that the ability of the sections of milk service to convey the disease had been related to a malady affecting particular cows. This evidence against particular cows at the Hendon farm could not and did not aim at furnishing direct and definite proof of the connection of this cow disease with scarlet fever of man, for the inductive methods usually employed by the Medical Department of the Local Government Board when applied to inquiries about epidemic spread of scarlatina can for obvious reasons yield but circumstantial evidence. As on various former occasions, so also on this, the Medical Department sought to put the above conclusions to the test of scientific experiment. This task was delegated to me by the Board. The first part of this work has been published in the recently issued volume of the Reports of the Medical Officer of the Local Government Board for 1885-86. I have therein shown that the suspected cows from the Hendon farm that had been made the object of special study, showed besides a skin disease—consisting in ulcers on the udder and teats, and in sores and scurf patches and loss of hair on different parts of the skin—also a general disease of the viscera, notably the lungs, liver, spleen, and kidney, which resembled the disease of these organs in acute cases of human scarlatina. I have further shown that the diseased tissues of the ulcers on the teats and udder produced on inoculation into the skin of calves a similar local disease, which in its incubation and general anatomical characters proved identical with the ulceration of the cow; and further, that from the ulcers of the cow a species of micrococcus was isolated by cultivation in artificial nutritive media, which micro-organism in its mode of growth on nutritive gelatine, on Agar-Agar mixture, on blood serum, in broth, and in milk, proved very peculiar and different from other species of micrococci hitherto examined. With such cultivation of the micrococcus I have produced by subcutaneous inoculation in calves a disease which in its cutaneous and visceral lesions (lung, liver, spleen, and kidney) bears a very close resemblance both to the disease that was observed in the Hendon cows as well as to human scarlatina.

The second part of the work, carried out during 1886-87 for the Medical Department, had for its object to investigate whether or no the disease, human scarlatina, is associated with the identical micrococcus, and whether this, if obtainable from the human subject, is capable of producing in the bovine species the same disease as was observed in the Hendon cows and in the calves experimented upon from the latter source. The definite and clear proof that this is really the case has now been obtained, and the evidence I now bring to the notice of the Royal Society.

On examining acute cases of human scarlatina—for which opportunity I owe great thanks to Dr. Sweeting, the Medical Superintendent of the Fulham Fever Hospital—I soon ascertained the fact that there is present in the blood of the general circulation a species of micrococcus, which on cultivation in nutritive gelatine, Agar-Agar mixture, blood serum, and other media, proved to be in every respect identical with that obtained from the Hendon cows. Out of eleven acute cases of scarlet fever examined in this direction, four yielded positive results: three were acute cases between the third and sixth day of illness with high fever temperature, and the fourth was a case of death from scarlatina on the sixth day. In all these four cases several drops of blood were used, after the customary methods and under the required precautions for establishing cultivations in a series of tubes containing sterilised nutritive gelatine, and generally only a very small number of these tubes revealed after an incubation of several days one or two colonies of the micrococcus. This

shows that the micrococci were present in the blood in but small numbers.

Having ascertained the identity in morphological and cultural respects of the micrococcus of the blood of human scarlatina with the organism obtained from the Hendon cows, the action of the cultivations of both these sets of micrococci was then tested on animals and the results compared. It was found that mice—wild mice better than tame ones—after inoculation or after feeding, became affected in exactly the same manner, no matter whether the one set of cultivations or the other was used. The great majority of these animals died after between seven and twenty days; the *post-mortem* examination revealed great congestion of the lungs, amounting in some cases to consolidation of portions of the organ, congestion of the liver, congestion and swelling of the spleen, great congestion and general disease of the cortical part of the kidney. From the blood of these animals, taken directly from the heart, cultivations were established in nutritive gelatine, and hereby the existence of the same species of micrococci was revealed; they possessed all those special characters distinguishing the cultivations of the micrococcus of the Hendon cows, and of the human scarlatina.

In the third and concluding section of the work, cultivations of the micrococcus of two cases of human scarlatina were used for infecting calves: two calves were inoculated, and two were fed from each set of cultivations. All eight animals developed disease, both cutaneous and visceral, identical with that produced in the calves that had been last year infected with the micrococcus from the Hendon cows.

From the heart's blood of calves thus infected from human scarlatina the same micrococcus was recovered by cultivation, possessing all the characters shown by the cultures of the micrococcus of the Hendon cows, and of the cases of human scarlatina.

It must be evident from these observations that the danger of scarlatinal infection from the disease in the cow is real, and that towards the study and careful supervision of this cow disease all efforts ought to be directed in order to check the spread of scarlet fever in man. It is also obvious that in the agricultural interest investigations of this cow disease are greatly called for.

Anthropological Institute, February 22.—Mr. Francis Galton, F.R.S., President, in the chair.—The election of Mr. Joseph Straker was announced.—Prof. Ferrier read a paper on the functional topography of the brain. He discussed the question how far recent investigations into the functional topography of the brain could be brought into relation with craniological and anthropological researches with a view to establish the foundations of a scientific phrenology. Then he sketched the functional topography of the brain so far as it had been settled, but pointed out that the psychological aspects of brain functions were still far from being made out, although that correlation must be established and proved before a practical psychology, in any degree serviceable to the physician or the anthropologist, could be regarded as possible. He offered some speculations on the subject, and illustrated them by reference to certain facts and phenomena of disease in man. On the question as to how far it was possible from an anatomical examination of the brain to form an estimate of the forces and capacities of the individual, he pointed out many great difficulties which had to be encountered. *Cateris paribus*, greater anatomical development might be considered as an index of greater functional capacity. He thought the attempt to determine differences in functional capacity from the examination of the head involved all the difficulties connected with the examination of the brain, and a great many more. He indicated the cranial relations of the principal convolutions, but expressed his belief that in the present state of our knowledge the data of a scientific phrenology were still very deficient. There was reason to believe, however, that, if the subject were taken up from different points of view by anatomists, physiologists, psychologists, and anthropologists, great progress might be made.—Mr. H. D. Rolleston read a paper on the cerebral hemispheres of an adult Australian; and a paper by Mr. Soren Hansen on a fossil human skull from Lagoa Santa, Brazil, was taken as read.

Entomological Society, February 2.—Dr. D. Sharp, President, in the chair.—The President nominated Mr. R. McLachlan, F.R.S., Mr. O. Salvin, F.R.S., and Mr. H. T. Stainton, F.R.S., Vice-Presidents during the Session 1887-88.—The Rev. W. J. Holland, Dr. F. A. Dixey, Mr. C. J. Gahan, and Mr. S. Klein, were elected Fellows.—Mr. P. Crowley exhibited a new species

of *Synchlœ*—*S. johnstoni*—from Kilima-njaro; also, for comparison, specimens of *Synchlœ mesentina* and *S. hellica*, which the new species closely resembled.—Mr. W. White exhibited a number of preserved larvæ of European Lepidoptera in various stages of growth, illustrating the gradual development of the markings and colour, as explained by Prof. Weismann, in his "Studies in the Theory of Descent."—Mr. Gervase F. Mathew exhibited a variety of a female of *Lycana telicanus*, from the neighbourhood of Gallipoli; some specimens of a *Lycana* from Vigo, believed to be varieties of *Lycana baton*; and several examples of a *Leucophasia* from Vigo, which appeared to be identical with *L. asiatica*.—Mr. Porritt exhibited, on behalf of Mr. N. F. Dobrée, a series of a remarkable red form of *Teniocampa gracilis*, bred from larvæ collected in Hampshire.—Mr. Eland Shaw exhibited specimens of *Pachyylus cinerascens* (Fab.), *Meocostethus grossus* (Linné), and *Gryllus flavipes* (Gmel.), and read a note on the identity of *Gryllus (Locusta) flavipes* (Gmel.).—Mr. H. Goswami read a communication from Prof. Riley, of Washington, on the subject of the Australian bug (*Sceryra purchasi*). It was stated that the insect had of late years become very destructive to various trees and shrubs in California, into which country, as well as into New Zealand and Cape Colony, it had been introduced from Australia.—The Rev. T. A. Marshall communicated a monograph of the British *Braconidae*, part 2.—Mr. F. P. Pascoe read a paper entitled "Descriptions of some new species of *Brachycerus*."—Mr. Francis Galton, F.R.S., read a paper "On pedigree moth-breeding as a means of verifying certain important constants in the general theory of heredity," in which he suggested the institution of a system of experimental breedings, to be continued for several years, with the object of procuring evidence as to the precise measure of the diminution of the rate at which a divergence from the average of the race proceeds in successive generations of continually selected animals.—Mr. F. Merrifield read a paper entitled "A proposed method of breeding *Selenia illustraria*, with the object of obtaining data for Mr. Galton." Mr. McLachlan said he considered the fact that *S. illustraria* was dimorphic an objection to its selection for the experiments proposed, and suggested that the common silkworm moth would be more suitable. Prof. Meldola remarked that, although for some reasons the species selected was well adapted for testing Mr. Galton's conclusions, he believed that the fact of the moth being seasonally dimorphic was likely to introduce disturbing elements into the experiments which might influence the results. The discussion was continued by Dr. Sharp, Messrs. Baly, Kirby, White, Klein, Porritt, Dunning, Waterhouse, Bates, Merrifield, Galton, and others.

Chemical Society, February 17.—Dr. Hugo Müller, F.R.S., President, in the chair.—It was announced that the following changes in the Council list were proposed by the Council:—As President: Mr. W. Crookes, F.R.S., *vice* Dr. Hugo Müller, F.R.S. As Vice-Presidents: Prof. McLeod, F.R.S., Prof. Schorlemmer, F.R.S., and Mr. Ludwig Mond, *vice* Mr. Crookes, F.R.S., Prof. Liveing, F.R.S., and Prof. T. E. Thorpe, F.R.S. As ordinary Members of the Council: Prof. A. H. Church, Dr. P. F. Frankland, Prof. Kinch, and Dr. H. F. Morley, *vice* Messrs. H. T. Brown, A. E. Fletcher, and Profs. Meldola and Pickering.—The following papers were read:—The influence of temperature on the heat of dissolution of salts, by Prof. S. U. Pickering. This is an extension of the author's previous work on the sulphates, entitled "The Influence of Temperature on the Heat of Chemical Combination" (Trans., 1886, 260), which tended to show that the heat of dissolution of a salt does not increase regularly with a rise of temperature, but that irregularities occur at various points, so that the heat of dissolution must be represented by a series of curves. The experiments with potassium sulphate, hydrated and anhydrous magnesium sulphate, and hydrated and anhydrous copper sulphate have been repeated, and the investigation extended to potassium, sodium, hydrated and anhydrous strontium chloride, potassium and the two strontium nitrates, the two sodium carbonates, sodium acetate and potassium sodium tartrate. The investigation comprises over 700 determinations, the mean results with each salt being deduced from two to five distinct series of experiments, each performed with different thermometers. The observations extended from 3° to 25°. In all cases it was found that the irregularities previously noticed were the result of error, and that the heat of dissolution of a salt is represented by a series of straight lines. In rising from low temperatures the heat of dissolution is expressed by a straight line up to a certain point, when the rate becomes suddenly lowered and remains constant till a further sudden reduction occurs at

some still higher temperature. The average divergence of all the mean results from lines of perfect straightness amounted to less than one-thousandth of a degree. . . . The heat of combination of a salt with its water of crystallisation is deduced from the author's results. He concludes that it is not a constant quantity at all temperatures; the general effect of rise of temperature being to diminish it, although at very low temperatures this effect seems to be more than counterbalanced by some other cause, probably the tendency of the water molecules to unite with each other, the heat of combination diminishing then with fall of temperature. The more water a salt contains the more marked are both these results.—Periodates, by Dr. C. W. Kimmins.—Sulphonic acids derived from the β -monohaloid-derivatives of naphthalene, by Prof. Henry E. Armstrong and Mr. W. P. Wynne.—The decomposition of potassium chlorate and perchlorate by heat, by Dr. Frank L. Teed.—The formation of ethylic cyanacetate, by Dr. J. William James.—The relation of diazobenzene anilide to amidazobenzene, by Mr. R. J. Friswell and Mr. A. G. Green.—Note on Wallach's explanation of the isomeric transformation of diazoanidobenzene into amidoazobenzene, by Prof. R. Meldola, F.R.S.

Victoria Institute, February 21.—Prof. T. McKenny Hughes read a paper on caves, their formation, uses as places of refuge, and the influences which in many cases cause uncertainty as to the ages of the deposits therein. In regard to English sea caves he held that our coasts had not recovered their present elevation, after the submergence that followed on the Glacial age, before man came on the scene, marine shells being found buried in the same earth as Palæolithic man and the extinct animals.

Middlesex Natural History Society, February 15.—Mr. Mattieu Williams in the chair.—Mr. Logan Lobley read a paper on the geology of the parish of Hampstead. Commencing with a sketch of the work of those distinguished geologists who have made Hampstead classic ground, Mr. Lobley referred especially to the work of the late Mr. Caleb Evans, and mentioned that Mr. Evans's well-known model of the area had passed into safe keeping. The London Clay was described in detail; its minerals, the nature of its clays, and the material manufactured from them, were treated of, as well as the sections, and the fossils they have yielded. Passing on to the Bagshot Sands, Mr. Lobley traced their age, their connection with similar beds of other districts, and the important part they play in the question of water-supply. Some remarks upon the formation of the present features of the area by denudation, and some interesting and suggestive notes upon the sources and direction of flow of the former smaller streams, such as the Fleet, the West Bourne, and the Bays Water, with a reference to the great folds of the Chalk, and the relation of the geology of London to that of the southern area, concluded the paper.

EDINBURGH

Royal Society, February 7.—Lord Maclaren, Vice-President, in the chair.—Dr. E. Saug read a paper on cases of instability in open structures.—Mr. W. Peddie communicated a paper on the time-rate of increase of electrolytic polarisation.—Sir W. Thomson discussed the equilibrium of a gas under its own gravitation alone, and pointed out the bearing of the problem on the question of the probable age of the sun.—Dr. Ralph Copeland, of Dun Echt Observatory, communicated some astronomical notes.

Royal Physical Society, January 19.—Dr. Alexander Bruce showed some microscopic specimens tending to confirm Gower's views with regard to the existence of the ascending lateral tract in the spinal cord. His sections were taken from a case of meningomyelitis confined to the lower dorsal cord. They showed ascending degeneration of Goll's columns, of both cerebellar tracts, and of a comma-shaped tract in the situation of the ascending lateral tract of Gower's.—Dr. R. H. Traquair communicated the first part of a revision of the nomenclature of the fishes of the Old Red Sandstone of Scotland.—Mr. W. E. Hoyle read a report on a collection of shells brought from the West Coast of Africa, the Canaries, and Cape Verde Islands, by Mr. John Rattray.

Mathematical Society, February 11.—Mr. George Thom, President, in the chair.—Mr. W. J. Macdonald gave a proof of a geometrical theorem; Mr. A. Y. Fraser submitted a paper on vortices, by Mr. Charles Chree; Mr. R. E. Allardice communicated a note on a theorem in algebra, by Mr. John L. Mac-

kenzie; Mr. George A. Gibson called attention to a point in the history of definite integrals; and Mr. John S. Mackay gave a few trigonometrical notes.

CAMBRIDGE

Philosophical Society, January 31.—Prof. Babington in the chair.—On the motion of a ring in an infinite liquid, by Mr. A. B. Basset.—Form and position of the Horopter, by Mr. J. Larmor.—On the finer structure of the walls of the endosperm cells of *Taraxacum officinale*, by Mr. Walter Gardiner. It would appear, from the author's more recent researches, that the perforation of the walls of the endosperm cells in the plant referred to is established after the formation of the wall, and in a similar manner to that which occurs in sieve-tubes during the formation of the sieve-plate. The author further hopes to show that this is a special instance of a general phenomenon.

February 14.—Mr. Trotter, President, in the chair.—On the influence of capillary action in some chemical decompositions, by Prof. Liveing.—On homotaxis, by Mr. J. E. Marr.—Note on the function of the secreting hairs found upon the nodes of young stems of *Thunbergia laurifolia*; on the petiolar glands of the Ipomæas; and on the occurrence of secreting glandular organs on the leaves of some Aroids, by Mr. Walter Gardiner. In the last paper the author remarked that it has been frequently stated that the entire absence of all extra-floral secretory structures in monocotyledonous plants furnishes one of the most striking points of difference between the above-named group and the Dicotyledons. One would be led to expect, however, that some form of secretive organ should be present, and that probably they would be found—if anywhere—among the Aroids. Guided by these considerations, the author made a careful examination of the Aroids at Kew, and was so fortunate as to find two individuals, viz. *Aglaonema Mannii* and *Alcasia cuprea*, which appear to him to possess definite organs of secretion. The structure of these organs was then shortly described, and a comparison was instituted between them and certain forms of extra-floral nectaries. As to the existence of intramural glands, e.g. in *Anthurium punctatum*, the author's observations confirmed those of Dalitzsch recently published in the *Botanisches Centralblatt*.

LIVERPOOL

Biological Society, January 22.—Prof. W. Mitchell Banks, President, read his inaugural address, which dealt with the aims and objects of the Society.—Prof. W. A. Herdman read a paper on recent researches in connection with the vertebrate brain (the pineal eye in lizards, and the pituitary gland in the Vertebrata and Tunicata), and their bearing on the hypothetical protochordata.

February 12.—Prof. W. A. Herdman, Vice-President, in the chair.—Mr. A. O. Walker contributed some notes on the *Mysida* of Liverpool Bay, with a description of some abnormal specimens.—A paper was read by Mr. J. Lomas on some points in the structure of *Alcyonidium gelatinosum*.—The Secretary (Mr. R. J. Harvey Gibson) drew attention to the new English translation of Sachs's "Text-book of Botany," Book II., by Goebel, and made some remarks on the value of a uniform terminology for the reproductive organs, not merely in botany, but in biology generally.—Dr. Ellis contributed some notes on boring insect larvæ.—Dr. Larkin exhibited and described some physiological apparatus.

PARIS

Academy of Sciences, February 28.—M. Gosselin, President, in the chair.—Remarks accompanying the presentation of MM. Charcot and P. Richer's work, "Les Démoniaques dans l'Art," by M. Charcot. Representations of persons "possessed by the devil," that is subject to epilepsy and other nervous affections, have been brought together from ivories, enamels, tapestries, engravings, paintings, and other sources, for the purpose of studying these works from the stand-point of scientific truth. Such masters as Andrea del Sarto, Domenichino, and Rubens are generally found to have depicted these subjects with a strict regard to nature, so that their figures accurately reproduce the traits of a now well-understood pathological state.—Determination of the constant of aberration: first and second method of observation, by M. Loewy. The author here deals with the somewhat feeble part played by refraction in these already described processes. From this study it appears that, the action of refraction being at all altitudes the same, the measure of the distance (except for very low regions) may be everywhere effected under almost

lential conditions of accuracy. Hence it is no longer necessary to observe the two stars only when found at considerable latitudes, a circumstance which greatly facilitates compliance with the other geometrical conditions of the problem.—On the great movements of the atmosphere, in connection with M. Mascart's last note of February 21, by M. Faye. The author reviews the whole subject of aerial movements as bearing more especially on his well-known theory regarding the direction of the wind in cyclones. The paper is followed by a brief reply from M. Mascart, who still maintains that this theory is unsupported by observation.—Note on the measurement of the photographic plates of the transit of Venus across the solar disk in 1882, by M. Bouquet de la Grye. These measurements, which have been executed in the Institute, deal altogether with 1019 plates, involving lengthy calculations which cover no less than 32,000 sheets of paper.—On the phosphorescence of the sulphuret of calcium, by M. Edmond Becquerel. In connection with M. Verneuil's recent paper on the determining causes of the phosphorescence of the sulphuret of calcium, the author makes some observations on the views already announced by him on the influence of foreign substances in modifying the molecular condition of the sulphuret of phosphorescent calcium.—On the red fluorescence of alumina, by M. Lecoq de Boisbaudran. It has recently been shown that highly calcined alumina yielding a bluish fluorescence *in vacuo* assumes a red tint in the phosphoscope. Notwithstanding this observation the author still contends that the presence of chromium is necessary to obtain the red fluorescence of alumina. A mere trace of Cr_2O_3 superadded suffices to produce the fine fluorescence described by M. Becquerel in his work on "Light."—Note on the earthquake of February 23 at Marseilles Observatory, by M. E. Stephan. The movement which was attended by such disastrous effects along the Riviera, and even in the Maritime Alps, was very little felt at Marseilles, where two series of shocks were recorded at the Observatory, the first at 5.55 in the morning, and lasting about 90 seconds, the second ten minutes later, and lasting only some 15 seconds. The astronomic pendulums were somewhat disturbed, but the meridian-circle was not appreciably affected.—Observations of Barnard's new comet (1887 *d*), and of Palisa's new planet 265, made at the Paris Observatory (equatorial of the West Tower), by M. G. Bigourdan.—On a new method of determining the parallax of the sun by the photographic observation of the transit of Venus, by M. Obrecht. The method here described yields formulæ by means of which the parallax may be determined from the observations of a single station.—Additional note on the measurement of aberration, by M. J. C. Houzeau. It is shown that the objections recently raised by M. Lœwy to the author's method rest on a serious error.—On applicable surfaces, by M. E. Amigues. A definition is given of rectilinear applicable surfaces, from which several theorems are deduced.—On the product of two sums of eight squares, by M. X. Antomari. A fresh demonstration is given of the theorem that the product of two sums of eight squares is a sum of eight squares. It is further remarked that by means of this theorem a rule of multiplication of complex quantities in a space of eight dimensions may be conceived analogous to the rule of multiplication of quaternions.—Note on entropy, by M. Félix Lucas. It is shown on theoretical grounds that when a gas is heated under a constant volume or under a constant pressure, the increase of its entropy is in proportion to the increase of its true temperature.—On the coefficients of chemical affinity, by MM. P. Chroustchoff and A. Martinoff. Certain analytic and thermic experiments are described, from which it is inferred that neither the initial nor the final composition of precipitates can serve to give coefficients of chemical affinity. Characteristic constants of affinity cannot be evolved by the method of simultaneous precipitation.—The action of heat on heptene, by M. Adolphe Renard. From the experiments here described, it follows that under the influence of heat heptene is decomposed chiefly into toluene and hydrogen, at the same time yielding a certain quantity of its lower homologues, hexene and pentene.—On the special characters of the loss of activity experienced by diastase under the action of heat, by M. Em. Bourquelot. A series of experiments are described, from which it would appear that the quality of the fermentation is modified rather than its quantity diminished, unless it be admitted that in natural diastase there are two or more soluble ferments intermingled, which by the increase of temperature become successive in the earths of cerite, M. Eug. Demarçay. Several methods

are described for easily preparing this substance, and comparing it with the natural ferrite known as franklinite.—On the nitrates and superphosphates, by M. A. Andouard. The author's experiments show that it is a mistake to mix these substances together as artificial manures.—On the destruction of the Nematodes of beetroot, by M. Aimé Girard. The sulphuret of carbon is proposed as a more practical remedy than the expensive system of "decoy plants" (*plantes pièges*) introduced by Kühn.—On the cause of the changes which take place in the blood on contact with air, oxygen, and carbonic acid, by M. A. Béchamp. These changes are referred to the activity and influence of the microzymes of the blood.—On the transfusion of blood into the head of decapitated animals, by MM. Hayem and Barrier. It is argued that the assertions contained in M. Laborde's recent communication on this subject are not justified by his own publications.—On the gastric glands secreting mucus and ferment in birds, by M. Maurice Cazin.—On the structure of the muscular fibres in the edriophthalmous crustaceans, by M. R. Köehler.—On the anatomy of *Bilhazia* (*B. hamatobia*, *Distomum hamatobium*), by M. Joannes Chatin.—On the geology of the Lake Kelbia district and of the Central Tunisian seaboard, by M. G. Rolland. From his extensive studies of this region the author concludes that during the historic period the relief of the land has not perceptibly changed, and that in the Roman epoch as well as now Lake Kelbia communicated only intermittently with the sea.—On the deposits of tin, from the geological stand-point, by Mr. Reilly. Excluding those of Mexico and Bolivia, the author argues that all these deposits, from Cornwall to Australia, are connected by a vast curve, which he calls the "axis of Sumatra."—On some new methods of artificially producing crystallised silica and orthose, by M. K. de Kroustchoff.—On the earthquake of February 23, recorded at the Perpignan Observatory, by M. Fines. As at Marseilles, the vibrations were but slightly felt in this district.—On the effects of the same earthquake in East Switzerland, by M. F. A. Forel. The main shock appears to have been very generally felt throughout this region.—Papers followed describing its effects at Nice, Voreppe (Isère), and Saint-Tropez, and discussing the relations that may exist between seismic and magnetic disturbances.

BERLIN

Physiological Society, January 28.—Prof. Du Bois-Reymond in the chair.—Dr. Benda mentioned that his researches, according to which the "spermatoblasts" resulted from the coalescing of the cells forming the spermatozoa with the supporting cells, had some years earlier been anticipated by the French anatomists, and that Prof. Grünhagen, who formerly opposed this view, was now likewise presenting it as his own.—Dr. Rawitz had examined the green gland of fresh-water crayfish. It was situated on the first member of the antennæ, was uniformly green on the ventral side, but on the dorsal side only at the periphery, elsewhere white, with a round yellow-brown speck in the centre. The gland consisted of two tubules closely interwoven. The cells of the green part had a round grass-green drop of protoplasm, the yellow brown cells a uniformly yellow-brown coloured nucleus. The tubules anastomosed, the yellow-brown cells being the terminal portions of the tubules, and secretory. No conclusions respecting the function of the glands could be drawn from their anatomical structure.—Dr. Gad made a communication respecting the peculiar strange albumen-precipitate with salt recently described by Dr. Wurster. If to the white of eggs lactic acid, peroxide of hydrogen, and common salt were added, almost the whole of the albumen was precipitated as a white flaky mass, perfectly similar in appearance and taste to newly-precipitated caseine (curd), but distinguished from caseine by its chemical reactions. The easy digestibility of this form of albumen, which had hitherto been precipitated by no other reagent was especially remarkable. It was interesting that, in accordance with the reactions shown by Dr. Wurster's test paper for active oxygen, hydrochloric acid was formed on the mixture of lactic acid, peroxide of hydrogen, and common salt, and this acid *in statu nascendi* might be the specific precipitate for this new form of albumen, which could be obtained just as well from blood serum as from white of eggs.

Meteorological Society, February 1.—Prof. von Bezold in the chair.—Dr. Frölich gave a report on measurements of solar heat, which, following up those instituted in 1883 and already published, he had made in the years 1884 to 1886 after some alterations in his apparatus. The most important modifications made in the apparatus consisted in the removal of the rock-salt

plate in front of the thermo-electric pile which he had made use of in his first measurements. He had been induced to remove the rock-salt plate by the conviction that after a time rock-salt developed a quality of transmissibility which was not identical both for luminous and for non-luminous heat. The bare thermo-electric pile showed itself by oft-repeated proofs to be constant towards the rays of a Leslie cube. The relation of the rays from the blackened side of the cube to the rays from the white side continued invariably the same. The same constancy was manifested in the registrations of the thermal element towards the luminous heat of a white-glowing platinum chimney, which was uniformly heated by two gas-flames. The observations of solar heat were made on perfectly bright days and under a perfectly clear atmosphere, the thermo-electric pile being directed to the sun under very different heights, as far as 10° , and exposed to the sun till the diversion of the galvanometer had become constant. The values obtained on the various days and under different solar positions were graphically delineated, on the supposition that the absorption of the atmosphere was an exponential function of its density. The result came out that the "curve" was practically a straight line, or a line concave or convex to so small a degree as to deviate but very little from a straight line. When the curve was lengthened till it met the perpendicular co-ordinate, then the intersecting point representing the magnitude of the solar heat was the same for all days of observation. The deviating results of Mr. Langley and Messrs. Angot and Crova were explained, in part from the fact that in their calculation the reflection of the thermal rays in the different atmospheric strata had not been taken account of, and in part from the fact that the different atmospheric strata were assumed to be parallel, and so their incurvation was left out of account. Notwithstanding the circumstance that the absorption by the atmosphere was different for the different kinds of rays, and also different from day to day, yet was the "curve," the co-ordinates of which were represented by the observed heat and the ab-cissa by the logarithms, without exception, a straight line. This empirically ascertained fact was the main result of the whole series of investigation, extending over three years.

Physical Society, February 4.—Prof. Helmholtz in the chair.—Dr. Sprung described the barograph designed by him, which avoided the errors of the older balance-barometer (first constructed in 1760 by Samuel Moreland) by making the barometer work on a resting horizontal beam, which through horizontal automatic displacement of a sliding weight was kept always in exact equilibrium. The travelling vertical tread-wheel constantly marked its position on the writing-table of the instrument. Seeing, moreover, that this displacement of the tread-wheel was effected by a clockwork, any disturbance that might arise from its rubbing against the barometer was completely precluded. The automatic equilibration of the beam of the balance was produced by an electric current. The speaker had quite recently instituted a series of the most various experiments, by which he demonstrated how the registering balance designed by him was with great advantage available for a large number of physical investigations: how, for example, he was able by his balance to permanently register the state of the quicksilver in the barometer; the progress of the evaporation of alcohol; the discharge of a fluid from a capillary tube; the change of intensity in an electric current; the evaporation of water through a clay-ball; the changes of density in the atmospheric air recorded by the variations of rise on the part of a large glass ball; and phenomena connected with permanent change of weight. The registering balance, which was being executed by the mechanic Fues in Berlin, allowed, in short, a large series of physical processes to be automatically recorded, and would prove highly useful in many physical investigations.—Prof. Helmholtz, by an experiment, demonstrated the great cohesion of an air-free column of water. A siphon-shaped glass tube, the longer leg of which was closed and the shorter one open, was filled with quicksilver, and above the quicksilver there was superposed a small quantity of distilled water. If the filling was effected without admission of air, then, on the tube being placed in an upright position, the water adhered to the closed end, and its adhesion supported the quicksilver column, which was longer than the barometer height. The speaker now brought the open end of the siphon tube into communication with an air-pump, and caused to be pumped out as much as down to 2 mm. pressure, but even then the cohesion of the water supported the quicksilver column. Only by shaking was the water column shattered, and the quicksilver immediately sank. If there was

no shaking, the apparatus continued for an unlimited length of time unchanged. This contrivance should serve the purpose of electrolysing air-free water and ascertaining the strength of the current under which gas bubbles developed themselves by electrolysis. The experiment showed that on the transmission of a current of 2 volts the water continued adherent. The depression of the quicksilver column in consequence of gas development occurred, however, in an experiment with a current of 2.15, and in another with a current of 2.18 volts.

February 18.—Prof. Schwalbe in the chair.—Dr. Frölich spoke of his measurements of the solar heat in the years 1883, 1884, and 1886, and refuted at length the objections which had been raised against these measurements by MM. Vogel, Langley, Angot, and Crova. In the discussion following thereon, Dr. König stated that experiments carried out in the Physical Institute with a Langley bolometer indicated that very considerable influence is exercised by the air-currents on this delicate measuring-instrument.

BOOKS AND PAMPHLETS RECEIVED

Catalogue of the Fossil Mammalia in the British Museum, *Natural History*, part iv.: R. Lydekker.—Practical Electricity: W. E. Ayrton (Cassells).—A Treatise on Algebra: Prof. Oliver, Wait, and Jones (Finch, Ithaca).—Contributions to Meteorology, chap. ii. revised edition: E. Loomis (New Haven).—The Game of Logic: L. Carroll (Macmillan).—Bees and Bee-keeping, vol. ii. parts 5 and 6: F. R. Cheshire (U. Gill).—British Dogs, parts 2-5: H. Dabiel (U. Gill).—Fancy Pigeons, 3rd edition: J. C. Lyell (U. Gill).—Vegetable Biology: Dr. T. W. Shore (Churchill).—Anecdota Oxoniensis: Alpha: edited by J. L. G. Mowat (Clarendon Press).—Journal of the Anthropological Institute, February (Tribner).—Outlines of Lectures on Physiology: T. W. Mills (Drysdale, Montreal).—Schools of Forestry in Germany: Dr. J. C. Brown (Oliver and Boyd).—Social History of the Races of Mankind, 2nd division: A. Featherman (Tribner).—Complete Hand-book on the Management of Accumulators, 2nd edition: Sir D. Salomons (Whittaker).—The Encyclopædic Dictionary, vol. vi. part 1 (Cassells).—Journal of the Chemical Society, March (Gurney and Jackson).—Bulletin of the American Geographical Society, Nos. 4 and 5, 1885 (New York).—Annual Report of the Proceedings of the Sussex Association for the Improvement of Agriculture, 1886.—Journal of the Asiatic Society of Bengal, vol. lv. part 2.—Aborigines of Hispaniola: H. Ling Roth (Harrison).—Bibliography and Cartography of Hispaniola: H. Ling Roth.

CONTENTS

PAGE

The Aurora Borealis. By A. M. Clerke. (<i>Illustrated</i>)	433
The Butterflies of India. By H. J. Elwes	436
Our Book Shelf:—	
Rosser: "The Deviation of the Compass in Iron Ships considered Practically"	437
Simon: "Travels in the Wilds of Ecuador"	437
Letters to the Editor:—	
Taba-heer.—Henry Cecil	437
Temperature and Pressure in Jamaica.—Maxwell Hall	437
Electricity and Clocks.—Horloge	438
Top-shaped Hailstones.—T. Spencer Smithson	438
The Present Southern Comet.—A. W. R.	438
The Earthquake.—Rev. S. J. Perry, F.R.S.	438
Cerebral Localisation, I. By Prof. E. A. Schäfer, F.R.S. (<i>Illustrated</i>)	438
The University Colleges	441
The Earthquake in Switzerland	442
Notes	442
Our Astronomical Column:—	
Solar Activity in 1886	445
Comet 1887 d (Barnard, February 15)	446
The Warner Observatory	446
Astronomical Phenomena for the Week 1887	
March 13-19	446
Geographical Notes	
On Radiant-Matter Spectroscopy:—Examination of the Residual Glow, II. By William Crookes, F.R.S. (<i>Illustrated</i>)	447
University and Educational Intelligence	451
Scientific Serials	451
Societies and Academies	452
Books and Pamphlets Received	

THURSDAY, MARCH 17, 1887

THE STATE AND HIGHER EDUCATION

IT is seldom that a Cabinet Minister receives so influential a deputation as that which on Friday last requested Mr. Goschen to supplement the revenues of the Victoria University from the National Exchequer. The gentlemen present represented the intelligence and industry of the North of England: they told a story of earnest and patriotic effort, and we sincerely trust that Mr. Goschen will feel able to afford them the moderate assistance they desire.

The ground on which the request was made, and on which Mr. Goschen promised to consider it with favourable attention, was designedly circumscribed by narrow limits. Neither the deputation nor the Chancellor wished to raise the wide question of the future relations between the State and the higher education. Both were anxious to regard the matter in hand from one point of view only. For good reasons the State has seen fit to confer the power of granting degrees upon the Victoria University, but it insists that external examiners shall take part with the Professors of the University in the conduct of the degree examinations. The cost thereby entailed on the Colleges, though not very great, is still an appreciable burden to institutions which can barely pay their way. It is therefore suggested that without committing itself to any far-reaching scheme of a general endowment of University Colleges, the State might properly defray the cost of the restrictions which it has itself imposed. Unlike the Universities of Oxford and Cambridge, the Victoria University has hitherto depended on funds which have been accumulated in a single generation. Unlike the University of London, it is a federation of Colleges engaged in educational work. These institutions want their class fees and their examination fees as well as all their slender resources from endowments, and could turn them to good account. Their case is, that to do so would be to the public advantage. They ask that 2000*l.* a year may be given towards the salaries of the examiners and other University officials, in order that the Colleges of the Victoria University may be able to devote the whole of their available funds to the work of teaching.

With this position we have no fault to find. The circumstances of the Victoria University are exceptional, and we think that the Chancellor of the Exchequer, if he grants the request of the deputation, may fairly contend that he has not committed himself on the wider issue that must before long be raised.

We cannot, however, refrain from pointing out that the question of State aid to higher education cannot remain in its present position. Whether such aid shall or shall not be given is no longer open to discussion. It is given already, but not, apparently, on any definite principle.

If it is right that 12,000*l.* a year should be supplied from the national funds for three new Colleges in Wales, which have still their reputations to make, it is surely wrong that England should have received no help till a school of science of European celebrity like the Owens

of 40,000*l.* a year in aid of higher education. Why is England, who pays no small share of this, to have no equivalent aid herself? It has not been found that a liberal educational policy discourages the "pious founder." University College, Dundee, and Lord Gifford's recent bequest are proofs that he still flourishes in Scotland. Why should a contrary result be feared if England shared Scotland's advantages?

It may be said that the fact that the northern Colleges have reached their present degree of efficiency without State support is sufficient proof that it has not been needed. We doubt the validity of this argument. Time is an important element in the industrial warfare of the present day. If we are to wait till prosperity and high prices enable our provincial Colleges to struggle through the slough of financial difficulty in which many of them are involved, we may find too late that efficient educational institutions have helped to bring to others prosperity which has not come to us. The higher education of our industrial population is no mere luxury to be attended to at a more "convenient season," but a vital necessity, a fundamental condition of commercial success. The State should indeed do nothing to choke the fount of private generosity by which in the past that education has for the most part been provided. It should do all in its power to direct local effort towards those channels in which most good can be done. The promoters of the Yorkshire College were four years in collecting one-third of the sum which they originally regarded as necessary for their enterprise; and the undertaking might have languished for several years more had not the Clothworkers' Company come forward with an offer of timely and judicious help. Much good might be done if in like manner the State would assist and encourage the founders of a College in the earlier and more difficult stages of their work.

We are, however, clearly of opinion that if after fair trial it is evident that a "University College" cannot hope to attain efficient support, or to fill its class-rooms from the surrounding neighbourhood, the State would do well to transfer its patronage of higher education elsewhere. If an institution, whether called a "University College" or not, is really doing elementary work, it can, under our present system, obtain State aid. If its pupils are entered for the South Kensington and City and Guilds of London Examinations, it may, by the grants thus received, largely diminish the sum which would otherwise be required for the payment of its teachers. If, then, it is sufficiently proved that any institution belongs to this class, it is already provided for, and has no special claim for further and exceptional help.

On the other hand, it must be remembered that the higher education has never been self-supporting, and that the most successful College can only hope to make both ends meet by endowments or by a sufficient income obtained from some other source than fees. More good will be done by allotting any sum devoted to higher education to Colleges which may be in financial difficulties, but which have proved that they are situated where the want of such education is felt, than in affording exceptional support to institutions in thinly-populated

found. An able lad gains much valuable knowledge, and, most important of all, self-knowledge, by contact with those who are his equals not only in talent but in years. It would be better, by a system of scholarships, to give the youth of country districts an opportunity of learning what competition means in a flourishing College, than to foster a large number of half-equipped and struggling institutions, which cannot reasonably hope to attract students of more than average capacity in numbers sufficient to justify their claim to being centres of the higher learning.

To encourage in their initial stages promising educational enterprises; to determine, if need be after fair trial, whether any given institution can do most good as a centre of elementary, secondary, or higher instruction; to afford to institutions of each grade help, the amount and continuance of which depend upon the educational results they attain and upon the increase or withdrawal of local support,—these are the general lines on which the State may aid secondary and higher education. It would thus encourage the performance of good work in each educational stage at those points where in the nature of things good work of that kind could best be done. It would be led no doubt into expenditure, but in this, as in so many other cases, the old induction holds good. "There is that scattereth and yet increaseth," is true of nations as of individuals, and most true of national expenditure on education.

PRACTICAL ZOOLOGY

An Elementary Course in Practical Zoology. By B. P. Colton, Instructor in Natural Sciences, Ottawa High School, Illinois. (Boston: D. C. Heath and Co., 1886.)

THIS volume is one of the latest additions to the stock of laboratory hand-books based upon the well-known type-system. It is more comprehensive, but, in detail, much simpler and more elementary, than any of its predecessors, while it differs from them in its method of treatment. The objects and scope of the work are set forth in a short introduction, and the detailed matter is embodied in thirty-two fasciculi, each devoted mainly to a consideration of some one type of organisation. Of these, ten are devoted to Insects and three to Crustacea—this, however, for a special purpose to which we shall allude. Practical hints dealing with methods and the like are incorporated with the text.

Certain emendations will be necessary in a subsequent edition, and to these we shall refer duly. In not a few cases the descriptions of the structural features of a given animal have been prefaced by a brief account of its habits and movements. An arrangement, this, of which we heartily approve. It must not be imagined, however, that the book stops short here. The author sets himself "to aid the student in getting a clear idea of the animal kingdom, as a whole, by the careful study of a few typical animals," and he reminds us that "a definition thought out by the student himself, imperfect though it be, is of more value to him than a perfect definition learned from a book, which often appeals to mere memory. Definitions made in the way these pages require are good as far as they go: they should be corrected and supplemented by the instructor. It develops a boy more to earn a dime than to receive a dollar as a gift."

The contents of the work are well arranged, the style is clear and concise, and the facts are presented in logical sequence, nothing being anticipated; but despite the assertion quoted above, there are far too few facts recorded. Some of the descriptions are meagre in the extreme, while others are so brief as to be useless. For example: on p. 8 the nervous system is introduced to the beginner for the first time (and that in the grasshopper) as consisting "mainly of a white cord extending along the floor of the whole body-cavity. In most of the abdominal rings the nerve-cord has enlargements called ganglia, from which nerves branch to the surrounding parts." The like is to be said of the des- spider's organs of respiration (p. 22), of the ch- ney (p. 52), and other organs which could be name- while those of the dorsal vessel and "liver" of the earth-worm demand early rectification. On p. 30 the author says of the "line of division between the head and thorax" in the crayfish:—"Huxley places it between the second pair of maxillæ and the first pair of maxillipeds. Hyatt places the division between the first and second pairs of maxillæ, as the space between these is membranous entirely across the sternal region, while back of this line the parts are hard and firmly soldered together." One primary object of a book of this kind should be that of imparting a sound training in methods by way of systematising the work of the student, and every conscientious teacher of zoology knows that by no means the least formidable difficulty to be encountered is that of teaching his pupils how much, and what, they shall leave aside. Bearing this in mind, we would fain see all matters which involve differences of opinion such as that alluded to above, eliminated from an elementary work.

The author has evidently been struck with the fact that there has manifested itself, under the growth of the type-system, a tendency to produce a lop-sidedness in the mind of the student. He is by no means alone here, but he sets himself to rectify the matter. This he does by extending and considerably modifying the said system; with what amount of success, has yet to be seen. He, and others who have since come into touch with him, must bear in mind that the type-book is, for the most part, but a tool in the hands of the student working (as does he for whom the author prescribes) under the guidance of a teacher, whose bounden duty it is personally to direct the work in all its details. He, and he alone, is to blame for this apparent defect.

One charge frequently brought against the type-system is that of apparent neglect of classification. The author meets this difficulty in a praiseworthy manner, by first describing a given animal as fully as his case demands, and then dealing with certain allied forms sufficiently to bring out the nature of those comparisons upon which our existing classifications are based. He introduces the subject of classification (p. 12) in an absolutely dogmatic and empirical manner, which, while it does not do justice to his intentions, exposes at the same time the dangers of the method adopted. He supplements the afore mentioned chapter for chapter. Writing on p. 44, he says:—"Animals are ranked according to the number of things they can do, and do well. The earthworm has many parts, but they are nearly all alike, and do not enable it to do many different things. A part of an animal having a

work to do is called an organ, and its work is its function. The earthworm has many organs, but few functions. Apply this principle to man and an ape. Each has four limbs. The ape is called four-handed, but has no good hands; he cannot handle things well. He has not good feet; he cannot walk well. What is the one thing he can do well with his four foot-hands? How many distinct functions has man with his hands and feet? Multiplication of parts without corresponding variety of structure and function mark an animal as low in rank." In striving for originality, the author has here gone astray; and with regard to the study of classification in all its branches, we are of opinion that it ought not to form a primary object in a work of purely educational value. For the advanced student, consideration of it must come as a matter of course sooner or later: for the beginner it is better that it be dealt with at the hands of the teacher, and that with the utmost caution.

On p. vi. of the introduction we read: "If the main object of this study is the mere acquisition of facts, full descriptions of most animals can be elsewhere obtained; but if the more important part in education is to lead the pupil to see and think for himself, then some such method as this" (above cited) "should be used." It is under the influence of this desire to "educate" the mind of the student that the author's plan is most novel and his labour most successful. One example will illustrate. On p. 124 the student is directed, when examining the lungs of the mammal, as follows: "Keeping the eyes fixed on the lung, prick a hole through one side of the diaphragm, and note the collapse of the lung." Then follows the question, "Is the lung on the other side affected by this operation?" A forcible means, this, of bringing home a fundamental fact of lung-structure, which, though so simple, is, as any teacher of experience knows to his sorrow, so generally overlooked by the beginner. It is here introduced in a manner which cannot fail to bring home conviction or to create a lasting impression; and the student who shall have thus learned it will some day wake up to the fact that he has made an important discovery. Many other charmingly simple examples of the kind might be cited. In one or two cases the idea is overdone. In others the student is misled for want of a technical term; and speculating upon the probable nature of the retort which might be in such a case elicited, the writer is reminded of a reply obtained from a beginner who had worked out most satisfactorily the mammalian portal vein, in ignorance of the conventional nomenclature. The question, "What do you call this vein?" was met by the rejoinder, "Stomach-liver." More technical terms might, with advantage, be introduced into this book. The acquisition of a technical nomenclature must go hand in hand with that of the fundamentals of a science, and we are of opinion that, until such are rightly and fully mastered, the student must be, as a tool in the hands of his teacher, guided with an unflinching precision.

In consideration of the pernicious rubbish which, even yet, occasionally finds its way into our own elementary schools under the guise of the elementary text-book of science, it is pleasant to reflect upon the merits of this work. The author is fortunate in being unhampere'd with the everlasting syllabus; he performs his experiment in his own manner, and it is worthy of a fair trial. We

question, however, the advisability of making the study of insects the focal point. The author asserts that his work "has usually begun with the fall term. At this time insects are abundant, and many kinds may be easily collected; they therefore serve well to show how animals are classified." We presume, therefore, that he adopts the inevitable. He further claims that "insects are attractive: from insects the student passes on to forms which, if taken up at first, would perhaps be distasteful to him." This may be, but we doubt it. For the analogous use of flowers as a means of introduction to the study of botany much more is to be said. This book is written for special use upon special ground and under special circumstances; it forms part of a system, and its success can only be rightly judged by someone cognisant of the whole. The task which the author has in hand is one, of its kind, the most difficult, and at the same time the most pleasing, of which we can conceive. In it he is honoured, and his plan of work must, like all which have preceded it, have its shortcomings. That these will be made good with a ripening experience we doubt not.

It remains to call attention to one or two matters standing in need of immediate reconsideration. On p. 169 we find the heresy of the evaginated hydra revived, with much emphasis. P. 71 bears the extraordinary statement that "a fish whose body is flattened from side to side is said to be 'compressed'; the word 'flat,' when used in describing a fish, means flattened from above downwards, and is applied to such a fish as the flounder." Directions are given (p. 120) for injecting the blood-vessels of the mammal, but they are wholly superfluous, as more than that which is required for the purpose in hand can be made out without it, while the process is involved in difficulties which are beyond the pale of such elementary students.

The author's directions for killing most of the animals are surprisingly novel; those for despatching the turtle and pigeon being worthy of the modern executioner. P. 102 reads: "with a strong pair of pinchers seize the head" (of the turtle), "pull it well out, and chop it off; examine the mouth; are there teeth present?" No experienced zoologist needs to be reminded of the effects which this repulsive piece of butchering would produce; but even that pales beside the injunction (p. 105) to "open the pigeon's mouth, and insert a pipette containing about a teaspoonful of chloroform into the opening of the glottis, at the base of the tongue" (this has to be found by the student), "blow the chloroform into the lungs, being careful that the point of the pipette does not slip out of the glottis." Never was insult worse than this added to injury. These things must be speedily altered if intended for the juvenile who is "to see and think for himself."

G. B. H.

THE DUTCH COLONIES IN SOUTH AMERICA AND THE WEST INDIES

Westindische Skizzen: Reise-Erinnerungen. Von K. Martin, Professor für Geologie an der Universität zu Leiden. vii.-186 pp. 8vo, with 22 Plates and 1 Map. (Leiden. E. J. Brill, 1887.)

TOWARDS the close of 1884 several learned Societies in Holland granted collectively the means for a scientific mission to the Dutch colonies in South America

and the West Indies. Prof. Suringar, with an assistant, took charge of the botanical work, whilst Prof. Martin was to carry on mineralogical and geological investigations, and Mr. Neervoort van de Poll volunteered as zoological collector. The party visited Dutch Guiana, Curaçao, Oruba, and Buen Ayre, and made also a short trip to Venezuela.¹

Prof. Martin's preliminary report on Curaçao and adjacent islands appeared in the Journal of the Dutch Geographical Society (1885) soon after his return to Holland; and the part referring to Guiana was printed in the "Contributions towards the Linguistics, Geography, and Ethnography of Dutch India" (1886). Of two short notices on the geology of the countries visited, one was inserted in the *Revue Coloniale Internationale* (1885), and the other in the Proceedings of the Royal Academy of Sciences, Amsterdam (March 1886).

The present work is the first part of the author's final report. The narrative of the expedition is cast in the general shape of a diary, but the author usually brings together all the information bearing on the same topic. Strictly scientific matters are excluded, and will be given in a second volume. There is, however, no deficiency of interesting facts referring to the geography and natural history of those out-of-the-way places. The ethnographical chapters on the ancient Indian population of Oruba (with a plate giving samples of old rock-paintings found in certain caves of the island) and on the Bush-Negroes of Surinam are especially valuable. Perhaps Prof. Martin might with advantage have given a little more general geological information, which certainly would have been not less acceptable to the readers of this volume than his notes on the botanical and zoological character of the ground covered by his explorations.

In Guiana the author went up the River Surinam as far as the Negro settlement of Toledo (4° 33' N. lat., and 55° 18' W. of Greenwich), a place not formerly visited by any scientific explorer, and indeed not even by any white man. The further ascent of the river would have given no geological results, as the waters began to rise with the beginning of the rainy season, making it impossible to collect specimens from the rocks in the middle of the stream.

The general situation of Dutch Guiana unfortunately is far from being prosperous. The development of the colony has not kept pace with that of its English neighbour. Agriculture, which ought to be its main strength, is going down-hill, and we believe Prof. Martin is quite right when he expects very little aid from the increasing produce of the gold-washings in the interior. The cause of the evil appears to be rather complicated, as may be seen from a very clever article published by B. E. Colaço Belmonte in *Timehri* (December 1885 and June 1886).

The Dutch islands off the northern coast of Venezuela are so very little known outside the narrow circle of people connected with the interests of those colonies that any information about them must be as welcome as if it came from Corea or Madagascar. The islands are very small, measuring only about 1000 square kilometres, and

¹ Prof. Suringar, on his way home, spent some days on the Dutch Leeward Islands St. Eustatius and Saba. He has published as yet only a small part of his very interesting report in the Journal of the Dutch Geographical Society (unfortunately in the Dutch language, so that few botanists abroad will be able to read it), besides a paper on a new Melocacti from Curaçao, in the Proceedings of the Royal Academy of Sciences, Amsterdam.

are inhabited by 36,000 people, most of them being descendants of Negroes, who speak the *Papiamento*, a jargon which is a curious mixture of Spanish, English, Dutch, Portuguese, and Carib words. The climate is excessively dry, and the vegetation is therefore very poor. For the same reason Curaçao is an important sanitary station; and as the port of Willemstad is one of the safest in existence, it is to be expected that the island will gain in importance by the opening of the canal through the Isthmus of Panama. The principal article of export is phosphate of lime, which is found there in large quantities and of considerable richness. Here as well as on the Venezuelan islands of Los Roques, Orchila, Las Aves, Los Testigos, &c., the phosphates owe their origin to an epigenetic change of the coralline limestone, which became infiltrated with phosphate of lime from overlying deposits of guano, exposed to the action of the periodical rains. All these islands have a nucleus of eruptive rocks (diorite, diabase, gabbro, eclogite): the same geological constitution exists in the central hill of the peninsula of Paraguaná and in the mountain-ridges of La Guajara. We have thus a line of volcanic out-flows corresponding to a long fissure running from east to west.

The chapter referring to Prof. Martin's visit to Venezuela is short, as was his stay in that country. It does not pretend to give anything new, but it is a very proper conclusion to the author's "Recollections of Travel."

When speaking of the so-called flight of flying-fishes, Prof. Martin says it appeared to him that the animals now and then, by a jerk of their tails, gave a new impulse to their ascending movement, in addition to the work done by their fins ("als ob die Thiere sich mit Hülfe des Schwanzes manchmal von neuem emporschnellten und so die Arbeit der Flossen unterstützten"). Our own observations of several species of flying-fishes lead us to adopt entirely Prof. K. Möbius's conclusions, viz. that the pectoral fins do no propelling work at all, but only keep the body of the animal resting on the air, and that the occasional rise in the line of movement, when the latter goes against the wind and the direction of the waves, is due to the lifting pressure of the wind, which ascends the opposite slope of the wave (K. Möbius, "Die Bewegungen der fliegenden Fische durch die Luft," Leipzig, 1878).

Prof. Martin's style is very clear and fresh. The plates which accompany the book, mostly engraved from his own drawings, are excellent illustrations of scenery and ethnographical objects, and the whole volume is got up in a manner which is highly creditable to the publisher. We expect with great interest the concluding part of this valuable report, which, no doubt, will be an important contribution to South American natural history.

A. ERNST

HYDRAULIC POWER AND HYDRAULIC MACHINERY

Hydraulic Power and Hydraulic Machinery. By H. Robinson, M.I.C.E., &c. Pp. xiv. + 190, and 42 plates. (London: Charles Griffin, 1887.)

THIS work purports to "record existing experience in this branch of engineering." It is divided into thirty-five short chapters (not numbered, and therefore

not quite easy of reference). Five of these treat of general subjects, and the rest of particular machines or details.

The work opens with a well-written summary (16 pp.) of what is known of the flow of water under pressure, including a statement of the formulæ from Torricelli down to our own day, with a short account of some of the more recent experiments. Then follow some "General Observations," in which it is explained that the fears entertained on the first introduction of high-pressure water-power that accidents would be frequent from the bursting of pipes, especially in frosty weather, have proved groundless. The "relief-valves" necessary to avoid the shock from suddenly stopping or changing the motion of a non-elastic fluid like water are described and drawn. In another chapter the author describes the mode of "packing" so as to produce joints tight under high water-pressure, explains the use of "cupped leathers" to form a self-tightening joint, and shows the necessity of clear water, since dirty or gritty water causes rapid wear of the leathers.

The advantages of "power co-operation" all over large towns are considered in a short chapter (6 pp.), and illustrated by its successful application at Kingston-upon-Hull. Much more space might have been given to this now very important branch of the subject. A short chapter (6 pp.) details the cost of water-power in various places: it seems to vary from $\frac{1}{10}$ of a penny, to nearly 2d. per 100 foot-tons.

There are three chapters (covering only 7 pp. in all) on water-wheels, turbines, and centrifugal pumps. These chapters are too short to be of any practical use. The remaining 27 chapters are almost entirely devoted to the description of the appliances necessary for the use of high-pressure water-power, and to the very varied machines which may be thereby worked: many of these—especially the larger and more recent machines—are very fully illustrated. All this part of the work is of great interest. The pressure required for various purposes is stated to be 700 lbs. per square inch for ordinary hydraulic machines, 1500 to 2000 lbs. for shop-tools, and up to 20,000 lbs. for compressing iron and steel; and the advantages in the use of high-pressure are explained. The conditions to which this hydraulic power is suitable are shown to be those in which great power is to be exerted at scattered points for a short time only, and at irregular intervals. The machines and appliances described and illustrated are very numerous and diversified—far too many to enumerate here. Among the more interesting may be mentioned cranes, riveters, dock-gear, swing-bridge-gear, steering- and ship-gear, gun-lifts, and hoists of all sorts.

The practical part of this work is excellent: it is, in fact, a short monograph on the use of high-pressure water-power. But the theoretical part sadly needs revision. The term "power" is loosely used, sometimes meaning "force" (say in pounds), sometimes "work" (say in foot-pounds), sometimes "horse-power" (of 33,000 foot-pounds per minute). It is not surprising, therefore, to find the following mistakes: (1) a factor, 60 (*i.e.* 60 seconds in a minute), omitted in computing "horse-power" on p. 24; (2) a factor, 33,000, omitted in computing

"horse-power" on p. 27, also the units (feet and pounds) not mentioned in same place; (3) a result on p. 35, which seems to be inch-pounds \div 33,000 (*i.e.* \div by foot-pounds per minute) marked as H.P.; (4) the following on p. 98, "the power (or foot-pounds) transmitted through a high-pressure water-main is determined by multiplying the number of pounds of water flowing per second by the pressure." From a numerical example lower down it may be seen that the "power" referred to in this sentence is to be estimated (not in foot-pounds, but) in foot-pounds per second, and that by "pressure" is meant head of pressure, in feet.

ALLAN CUNNINGHAM, Major, R.E.

OUR BOOK SHELF

The Statesman's Year-Book for 1887. Edited by J. Scott Keltie. (London: Macmillan and Co., 1887.)

THIS work is so well known and so generally appreciated that it is necessary merely to note the appearance of the volume for 1887. The editor has made every effort to bring the statistics up to the latest date, and those who have been in the habit of referring to the book will find that its value has been considerably increased by important additions and modifications. An adequate account of the smaller British colonies has been introduced, and much new information is given with regard to the various systems of land-tenure in India. The leading facts brought out by the new censuses in Germany and France are embodied, and Mr. Keltie has been careful to show the precise results of the recent colonial enterprises of these two countries.

Joint Scientific Papers of James Prescott Joule, F.R.S. Published by the Physical Society of London. (London: Taylor and Francis, 1887.)

AMONG the contents of this volume are some elaborate papers on "Atomic Volume and Specific Gravity," prepared by Mr. Joule in association with Sir Lyon Playfair. Mr. Joule took the principal part in the experiments on the expansion of salts, the maximum density of water, &c.; but the important theoretical results arrived at with regard to atomic volume he attributes almost entirely to his colleague. Another valuable series of papers were the joint work of Mr. Joule and Sir William Thomson. The subjects are: "The Thermal Effects experienced by Air in rushing through Small Apertures," and "The Thermal Effects of Fluids in Motion." In the year 1843, Mr. Joule read a paper on "The Caloric Effects of Magneto-Electricity and the Mechanical Value of Heat," to the Chemical Section of the British Association assembled at Cork. The subject did not excite much general attention, so that, when he brought it forward again at the meeting in 1847, the Chairman suggested that he should not read his paper, but confine himself to a short verbal description of his experiments. "This," says Mr. Joule, "I endeavoured to do, and, discussion not being invited, the communication would have passed without comment if a young man had not risen in the Section, and, by his intelligent observations, created a lively interest in the new theory. The young man was William Thomson, who had, two years previously, passed the University of Cambridge with the highest honours, and is now probably the foremost scientific authority of the age." The work they afterwards did together, the results of which are here recorded, was chiefly experimental, performed in Manchester and the neighbourhood.

LETTERS TO THE EDITOR

[The Editor does not hold himself responsible for opinions expressed by his correspondents. Neither can he undertake to return, or to correspond with the writers of, rejected manuscripts. No notice is taken of anonymous communications.]

The Earthquake

WITH reference to the earthquake which occurred on the morning of February 23 last, it may be of interest to inform you that two of the magnetic registers of the Royal Observatory, Greenwich, entirely confirm the fact shown by the Kew horizontal-force register (NATURE, March 3, p. 421), of the shock having been sensible in England. The particulars are as follows:—

At 5h. 38m., Greenwich civil time, the declination and horizontal-force magnets were suddenly thrown into vibration by some cause not magnetic, the extent of vibration being in the case of declination 20' of arc, and in the case of horizontal force '004 of the whole horizontal force. Other smaller vibrations will be observed, on the annexed copy of the Royal Observatory photo-

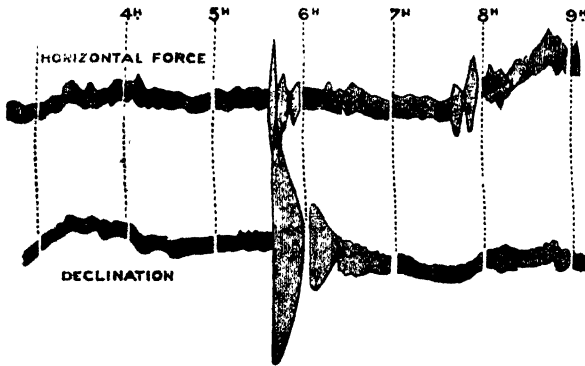

Copy of the photographic registers of the declination and horizontal-force magnets, as recorded at the Royal Observatory, Greenwich, 1887, February 23.

graph, as occurring in declination at about 6h. 0m., and in horizontal force at about 5h. 45m., 7h. 40m., and 7h. 50m. respectively. No motions of this character were shown in the vertical-force magnetic register, the two earth-current registers, or in any of the meteorological registers.

It may be mentioned that the declination magnet is a bar 2 feet long, suspended by a single thread about 6 feet long, and stands in the magnetic meridian, and that the horizontal-force magnet, also 2 feet long, has a bifilar suspension, the threads, about 7½ feet long, being twisted horizontally to cause the magnet to stand at right angles to the magnetic meridian. The time of vibration of the declination magnet is 24 seconds, and that of the horizontal-force magnet 21 seconds. The magnetic declination at Greenwich at the present time is about 17° 53' west.

W. H. M. CHRISTIE

Royal Observatory, Greenwich, March 10

The Engineer on the Dimensions of Physical Quantities

IN a brief book-notice (*ante*, p. 387) I commented on the grave error of measuring potential energy in terms of horse-power, comparing it with the allied absurdity of measuring distance in terms of speed. I also cited the following passage:—

“dividing 3,942,400 foot-pounds per minute by 33,000 foot-pounds, we get 119.4 horse-power”; and I put beside it the allied absurdity:—

“dividing 50*l.* a year by 50*l.*, we get 10*l.* a year.”

I thought it superfluous to point out the nature of the mistake, but I judged rashly. For the *Engineer* (in a leader, of March 4, 1887) has made a somewhat excited attack on this and other of my statements:—re-marking

“we are in doubt whether ‘P. G. T.’ really has any idea what (*sic*) the expression means.”

To this charge I plead guilty. For if I were myself to divide 3,942,400 foot-pounds per minute by 33,000 foot-pounds, the result would contain the unit of *time* alone; and could certainly not express horse power. It might be angular velocity perhaps. It is true that if I were to divide 3,942,400 foot-pounds per minute by the mere number 33,000, I should probably obtain the result 119.4 horse power. But the *Engineer* will ascribe

all this to the pedantry of the “professor,” for its article goes even farther in absurdity than does the passage quoted above. It leaves out the “per minute” and says the author “is strictly correct (*sic*) when he says that 3,942,400 foot-pounds are to be divided by 33,000 foot-pounds to get the horse-power”! Alas for Fourier, and *Dimensions* of physical quantities!!

I wonder what the *Engineer* would assign as the result of dividing 10 eggs per minute by 2 eggs. Would it, or would it not, be 5 eggs per minute? P. G. T.

Tabasheer

MR. W. T. THISELTON DYER'S ingenious contribution on Tabasheer in NATURE (p. 396) will doubtless be interesting in connection with the subject of the nature and mode of distribution of silica in vegetable bodies, in which it is so often contained.

Brewster, in 1819, says (*Edinburgh Philosophical Journal*, n. 1, p. 147):—“It is found in the joints of the female (?) bamboo, sometimes in a fluid state like milk, sometimes with the consistency of honey, but generally in the form of a hard concretion. Some specimens of it are transparent, and resemble very much small fragments of the artificial pastes made in imitation of opal; others are exactly like chalk, while a third kind is of an intermediate character, and has a slight degree of translucency.”

“In the year 1804, Messrs. Humboldt and Blonpland brought with them from America some specimens of tabasheer, called *guaduas butter* by the Creoles, taken from the bamboos which grow to the west of Pinchincha in the Cordilleras of the Andes (Humboldt's ‘Personal Narrative,’ vol. i. Introd. p. xii. note). These specimens were analysed in 1805, by Messrs. Fourcroy and Vanquelin (*Mémoires de l'Institut*, tom. vi. p. 382), who found them to be different from the tabasheers of Asia. Instead of being wholly composed of silicx, they contained only 70 per cent. of this earth, and 30 per cent. of potash, lime, and water.”

Cohn speaks of two kinds of tabasheer, viz. crude and calcified. The former consists of roundly-angular pieces of unequal sizes, possessing all degrees between transparency and opaqueness, and passing from brownish, reddish, yellowish, or dark gray to black in colour; the latter is opal-like, milky, or pale in colour, not unlike a lump of sugar. Tabasheer can be cut into pieces very easily, and shows, in polarised light, only extremely feeble double reflection.

Brewster, moreover, by studying the optical properties of tabasheer, formed one of the semi-transparent specimens, which he obtained from Nagpore and Hyderabad, into a prism, and found to his “great surprise that the refractive power of tabasheer was not only lower than water, but so much lower, as to be almost intermediate between water and gases.” The results he obtained are as follows:—

	Index of refraction
Air	1.0000+
Tabasheer from Hyderabad, yellowish by reflected light	1.1115
Tabasheer from Nagpore	1.1454
“ “ “ harder	1.1503
“ “ “	1.1535
“ “ “ very hard	1.1825
Water	1.3358

As to the chemical constituents of this substance, Poleck's recent analysis (*Bot. Centralbl.* Band xxix., 1887, p. 95) shows that it contains 99.6 per cent. of pure silicic acid and only 0.4 per cent. of other mineral matters, as sodium, sulphuric acid, &c., but neither potash nor phosphoric acid has been detected. The crude specimens contain 58 per cent. of water; the calcified specimens, on the other hand, are free from water.

We may perhaps dwell shortly upon the *habitat* of tabasheer. Mr. Dyer has fully shown its occurrence in India; now let us consider whether it occurs further in the eastern parts of Asia, as in China and Japan, where the growth of bamboos is still in full vigour. In China, tabasheer is known as Tien-chü-hwang or Chü-hwang, that is, the “yellow (substance) of bamboo”; or sometimes called Chü-kaou, or the “cerate of bamboo.” “Pun-tsaou-kang-müh” says: “They are produced inside the stem of bamboos, and look somewhat like yellow earth; they may be often found attached in masses to the inside of the bamboo cane.”

From the well-known old Japanese encyclopædia, “Wakan Sansai Dsuyé,” the following descriptions may be quoted: “After bamboos have been cut down in March or April, and

left for some time, tabasbeer is sometimes found inside the stem when broken." In Japan it is called *Take Miso*, and I have only heard that some portion of fluid, or some solid particles, occur inside the stem of bamboo, but not to such a remarkable extent as we meet with in India. In the Island of Kiuisu, the stem of bamboos is found sometimes filled with fluid, and especially in the province of Satsuma, particles like grains of sand are often detected. In a new Japanese work about bamboos, entitled "*Nihon Chikufu*," or "*A Collection of Japanese Bamboos*," by Nawoto Katayama, published in three volumes in Tokio in 1885, it is stated that in Tokio, if bamboos from the neighbouring provinces of Shimotsuké and Hitachi are kept till July or August and then broken, some watery juice or particles like sand may frequently be found. These particles are pale yellow in colour, but the quantity is only sufficient to fill a very small shell. "*Sômoku Seifu*," and other Japanese botanical books, also mention tabasbeer.

TOKUTARO ITO
Cambridge

"The Origin of Mountain Ranges"

THE reviewer of "*The Origin of Mountain Ranges* in NATURE (Feb. 17, p. 361) says, in reference to my views on the contraction hypothesis:—"He seems to hold that, according to the contractionists, crumpling is produced by unequal contraction in the solid shell itself, which certainly is not their view. And he entirely omits all reference to the one fact which is the life and soul of the hypothesis, that the earth's crust is not strong enough to stand by itself without support, a fact which admits of rigid mathematical demonstration."

Will you kindly permit me to state that this is an entire misapprehension; that I hold neither view; and I have a difficulty in understanding how such inferences can be drawn from anything contained in the work.

T. MELLARD READE
Liverpool, February 18

I AM very sorry if I have represented Mr. Reade as saying what he did not intend to say, but the construction I put upon his words seemed, and still seems, to me to be that which they naturally bear. Mr. Reade's notion of what it is that the contraction hypothesis maintains, and his reasons for differing from its conclusions, are apparently summarised in Chapter XI. on pp. 121-25. He there tries to form an estimate of the ratio between the radial and circumferential contractions *within a shell of 30 miles* in thickness which he assumes to be solid. It seemed to me accordingly that he was contemplating only contraction within a thin shell which he himself starts with assuming to be solid, and that he deals only with "unequal contraction in the solid shell itself."

If Mr. Reade meant something quite different from this, I failed to grasp his meaning; that this was so may or may not be my fault, but in either case I am much obliged to Mr. Reade for putting me right, and very sorry that I should have laid upon him the troublesome necessity of pointing out my mistake.

What the other view is which Mr. Reade disavows, and what other inferences are contained in the passage he has quoted, I confess that I am unable to discover.

A. H. GREEN
Leeds, March 13

The Vitality of Seeds

IN a letter in your last issue (p. 414) upon the vitality of seeds, "N. E. P." states that Prof. Judd in his address to the Geological Association (I presume he means the Geological Society) was reported to have said: "The botanist cites the germination of seeds, taken from ancient Egyptian tombs, as a striking illustration of how long life may remain dormant in the vegetable world." This appears to be a remarkable assertion to emanate from such an eminent scientific man as Prof. Judd, for if he really did make this statement one would think he must have some good proof quite incontrovertible. I must admit I am sceptical, and do not place credence in the statements that have been made by certain people, that wheat or barley, which is frequently found in the ancient tombs of Egypt, could possibly germinate after the lapse, say, of 3000 years.

We have often heard of people having had tricks played upon them by crafty Arabs, who, when discovering grain, knowing, perhaps, that the purchaser wished to test it, substituted for it some of modern date, which was said to be of the same species.

When this was sown, it germinated, and probably yielded a fine crop; but the real grain found in the tomb was to all purposes dead. Mummy-wheat is, I presume, simply a commercial name for a certain species, which has no sort of connection with the tombs of ancient Egypt. Sir Gardner Wilkinson, in his book "*The Ancient Egyptians*," vol. i. p. 471, refers to experiments having been successfully made with some grains of corn discovered in the tombs. Dr. Birch added the following footnote:—"The experiments aforesaid to have been made in France. (The possibility of corn germinating after so many years is strongly denied by some botanists on account of the impossibility of the delicate and minute embryo, placed immediately below the surface, being preserved so long in life, close to the surface.)"

As the late Dr. Birch in the above made reference to experiments having been made in France, I beg to quote the opinion of M. Paul Pierret, a very eminent Egyptologist, Conservateur du Musée Égyptien du Louvre, in his "*Dictionnaire d'Archéologie Égyptienne*," under the head of "*Blé*":—

"Tout ce qui a été dit sur la germination des grains recueillis dans les hypogées est absolument faux; tous les essais tentés dans les conditions voulues de sincérité scientifique ont avorté. Ce blé, semé dans la terre humide, s'amollit, s'enfle, se décompose, et, au bout de neuf jours, est entièrement détruit."

F. G. HILTON PRICE
29 Weymouth Street, W., March 7

I BEG to refer your correspondent "N. E. P.," on this subject, to my "*Memoir of the Late Professor Henslow*," p. 207, where I have given the results of copious experiments made by him in reference to the vitality of seeds, as well as the results of a close investigation of the whole subject by himself, Dr. Daubeny, and others—being a Committee appointed for the purpose in 1840 by the British Association; all tending to show that no seeds retain their vitality for much more than forty years, and very few for anything like so long, and throwing utter discredit upon often-received statements as to the long-retained vitality of the so called mummy-wheat found in the catacombs of Egypt.

Bath, March 7
L. BLOMEFIELD

THE question put by your correspondent with reference to the germination of seeds taken from ancient Egyptian tombs appears to be directly answered by M. A. de Candolle in his work on "*The Origin of Cultivated Plants*." His words are:—"I think it pertinent to say that no grain taken from an ancient Egyptian sarcophagus and sown by agriculturists has ever been known to germinate. It is not that the thing is impossible, for grains are all the better preserved that they are protected from the air and from variations of temperature or humidity, and certainly these conditions are fulfilled by Egyptian monuments; but as a matter of fact, the attempts at raising wheat from these ancient seeds have not been successful."

However, if the germination of mummy-wheat is not sufficiently authenticated, Prof. Judd might perhaps point to other cases which, although of less value on account of their antiquity, would nevertheless go far enough to prove his point. There is, I believe, the case recorded by Dr. Lindley of some raspberries "raised in the garden of the Horticultural Society from seeds taken from the stomach of a man whose skeleton was found thirty feet below the surface of the earth, at the bottom of a barrow which was opened near Dorchester. He had been buried with some coins of the Emperor Hadrian, and it is therefore probable that the seeds were sixteen or seventeen hundred years old."

The following well-ascertained fact, recorded by Prof. Duchartre and others, may prove of interest. Some years ago in Paris, when a number of very old houses were being pulled down in the "Cité" to make room for Haussmannian improvements, Dr. Boisduval examined some dark-looking earth taken from the very foundations of one of those houses. The earth was found to contain seeds, which, being planted carefully under a glass bell, germinated in due time, and proved to be seeds of *Funcus bufonius*, L. This plant, as is well known, affects damp, marshy places such as the island was on which *Lutetia Parisiorum* grew up. It was therefore admitted as very probable that those seeds of *Funcus bufonius* must have been dormant in the ground ever since the time when the "Cité" marshes became dried up, and the ground began to be occupied by houses.

L. MARTIAL KLEIN
University College, Dublin

CEREBRAL LOCALISATION¹

II.

WE have considered the main positions first taken up by Dr. Ferrier with regard to functional localisations, and it will be convenient to examine in the same order the criticisms and statements of other observers regarding those positions.

(1) *The Rolandic region.*—The effects of excitation and ablation in this region, so far as relates to the production, or the paralysis, of the movements of voluntary muscles, are almost universally admitted, and to this extent the researches of Dr. Ferrier have received brilliant corroboration. But the inference that this region is therefore of necessity motor has not been so generally acceded to. The attacks to which it has been subjected are based, almost without exception, upon a denial of the statement that lesions of this region do not involve the loss or impairment of sensation in the paralysed parts. It is alleged that, on the contrary, the motor paralyzes are invariably accompanied by loss or impairment of sensation, either of the so-called muscular sense (Hitzig, Nothnagel; "sense of movement," Bastian), or of tactile sensibility (Schiff, Tripier), or of sensibility in general, muscular and cutaneous (H. Munk); and it has been supposed that the paralyzes of motion which result from these cortical lesions are not true motor paralyzes, such as would be caused by destruction of a motor centre, but are rather due to the loss of the sensations which guide the volitional movements, or the ideas of such sensations, of which the part of the cerebral cortex removed is assumed to be the seat.

The question seems, on the face of it, one which is easily determinable. Do animals, and especially monkeys, in which a lesion in the Rolandic region has been established, exhibit loss of tactile (or any other form of) sensibility? Are cases of motor hemiplegia in man which are produced by injury or disease of this region accompanied by loss of cutaneous or muscular sensibility, or are they not? As regards animals, many, indeed most, observers answer this question emphatically in the positive sense. As regards man, the evidence is more conflicting. We have, it is true, the advantage of being able to obtain a direct answer regarding the existence, or absence, of sensibility in any particular case; but on the other hand there is not necessarily the same restriction of the lesion to the cortical gray matter, and the exact localisation is much more difficult of determination. Accordingly we find that cases of motor paralysis from cortical lesions in man have been put in as evidence upon both sides, according as they have been accompanied or not by impairment of sensibility. Dr. Ferrier is, however, very positive upon this point, relying upon the accuracy of his own observations in animals, as well as upon evidence derived from pathological observations in man, and the allegations to the contrary are disposed of by him in the following manner:—

"The conclusion that tactile sensibility is lost or diminished after destruction of the cortical motor area is based on defective methods of investigation and erroneous interpretation of the reactions of the lower animals to sensory stimulation. Though an animal does not react so readily to sensory stimulation of the paralysed side, it does not follow that this is due to diminished or absent perception of the stimulus. An animal may not react, or react less energetically, to a sensory stimulus, not because it does not feel it the less, but because it is unable, or less able, to do so from motor defect. . . . All that the experiments of Schiff and Tripier demonstrate is that motor reactions are less readily evoked on the side opposite the cortical lesion. But the same thing occurs in cases of purely motor hemiplegia in man" (pp. 374-75).

¹ "The Functions of the Brain." By David Ferrier, M.D., LL.D., F.R.S. Second Edition, re-written and enlarged. (London: Smith, Elder, and Co., 1885.) Continued from p. 441.

"Strictly cortical lesions of the motor area do not cause anæsthesia in any form, and it may be laid down as a rule to which there are no exceptions that if anæsthesia is found along with motor paralysis the lesion is not limited to the motor zone" (p. 378).

"The total abolition of the muscular sense (as in locomotor ataxy) does not paralyse the power of effecting movements. Even though the impressions ordinarily generated by muscular contraction are not perceived, yet the person can walk or move his limbs with perfect freedom under the guiding sense of vision. Even with the eyes shut the patient can intend his movements with correctness" (p. 380).

"Loss of the muscular sense never occurs without general anæsthesia of the limb. . . . The statements to the contrary, sometimes met with, rest only on the foundation of a demonstrably false hypothesis as to the nature of the ataxy which it is invoked to explain" (p. 380).

"The idea of a movement may be perfect when the motor centres are entirely destroyed. A dog with his motor centres destroyed has a clear idea of the movement required when asked to give a paw, and exhibits its grief at being unable to do so in an unmistakable manner; and the patient suffering from cortical motor lesion, after making futile efforts to carry out his ideally realised movement, not uncommonly bursts into tears at his failure. There is no defect in the ideation, but only in the realisation, of the movement" (p. 383).

"The cortical centres are motor in precisely the same sense as other motor centres, and are differentiated anatomically from the centres of sensation, general as well as special" (p. 393).

Certainly, if it can be shown that a distinct part of the cortex is concerned with the perception of impressions of general sensibility, this would afford strong *prima facie* evidence against the Rolandic region being endowed with sensory functions. And we shall presently see that such evidence is forthcoming.

(2) The evidence for the second proposition (that the visual centre is situated *exclusively* in the angular gyrus) has not found confirmation, and is virtually surrendered by the author. That the angular gyrus is at all concerned in the visual process is entirely denied by H. Munk, who has shown that complete blindness is produced by removal of the *occipital lobes* alone, without the implication of the angular gyri, and that removal of one occipital lobe produces blindness of the corresponding half of both retinae (hemianopsia). According to Munk, this blindness is permanent; but Luciani and Tamburini, who have obtained the same immediate result, affirm that it may after a time disappear. Dr. Ferrier, however, denies that the mere removal of the occipital lobes is followed by any perceptible deficiency of vision; and in support of this statement, which was already made in the former edition, he quotes the results of his own more recent experiments, which were performed in conjunction with Prof. Yeo, and also certain unpublished results which have been obtained by Mr. Horsley and myself. Dr. Ferrier has, however, been mistaken in supposing that our observations bear out his statement, for we invariably found, when an extensive removal was effected in the occipital region, that hemianopsia resulted therefrom, as described by Munk. But in the few experiments which we performed the blindness was not permanent, only persisting, so far as we could judge, for some days, or, at the utmost, weeks; and in one of these cases, in which we *afterwards* destroyed the angular gyrus, hemianopsia which appeared to be permanent was produced. This is confirmatory of the statements of Drs. Ferrier and Yeo. I am myself, however, not at all sure that the permanence of the result was due to the destruction of the angular gyrus, and may not rather have been produced by the more complete removal of the occipital lobe which that destruction

involved. As for the angular gyrus, the author seems now to admit that the blindness of the opposite eye which he has obtained on destroying that convolution is quite temporary, not, indeed, persisting for more than an hour or two after the operation. Nevertheless, he infers that this loss of vision which he describes is due to the fact that the angular gyrus is concerned with the appreciation of *direct or central* visual impressions. I have myself failed to obtain evidence either of permanent or temporary visual disturbances as the result of destruction of the gray matter only of one or both angular gyri; and I confess it is to me somewhat surprising that an experimentalist so experienced, and a reasoner so clear-sighted, as Dr. Ferrier, should have attempted to erect a theory of such importance upon a foundation so insecure!

(3) A similar idea arises in one's mind when one considers the evidence which the author has to bring forward of the localisation of the auditory centre in the superior temporo-sphenoidal convolution. Of course, if this be the case, it must follow that bilateral removal of this gyrus will produce complete and permanent deafness. According to Dr. Ferrier, this is actually what happens; but there is only one case followed by complete recovery from the immediate effects of the operation which he is able to quote in support of that statement. This case is that of a monkey which was exhibited to the International Medical Congress in London in 1881, and the animal certainly appeared to be deaf, for it in no way reacted to a loud noise, such as the report of a pistol fired near its head. But, convincing as this test seemed at the time to most of those present, I may here remark that a test of this character is of little or no value when applied to monkeys. For a perfectly normal monkey, if its attention or curiosity is excited in any way, and especially if it is brought into a strange room and surrounded by strange faces, will often give not the slightest sign of perceiving even a loud sound, such as the report of a pistol, when such sound is suggestive of no ideas. On the other hand, a sound which is habitually associated with an emotional idea, *e.g.* the noise made by the approach of a hostile companion, or a footstep which is associated with the expectancy of food, will generally be instantly reacted to. It is true that Dr. Ferrier, in the case mentioned, has not relied entirely upon the negative result obtained from the pistol-report, but expressly mentions other tests as having been applied by him. One remark which he makes is, however, very significant: "Occasionally a doubt was raised as to whether the absence of reaction to sounds was absolute."

I have always been inclined to think that Dr. Ferrier, in localising the auditory centre exclusively in this convolution, has relied too much upon this single case—especially since his deductions therefrom have not been supported by the results of other experimentalists. Luciani, in particular, insists upon the fact that extensive destruction of the temporo-sphenoidal lobe is necessary in order to produce deafness, and that even then the loss of hearing is not permanent. This statement I can myself fully corroborate. I have recently, in conjunction with Dr. Sanger Brown, entirely destroyed the superior temporo-sphenoidal gyrus on both sides in several monkeys, and in not one of them has there been any appreciable loss or impairment of hearing. On the other hand, when the lesion has involved not only the superior gyrus but also the greater part of the lobe there has in one or two instances seemed to be at first, not an entire loss, but a diminution of the power of appreciating auditory sensations—this condition, however, being recovered from after a few days.

I am aware that in locating the auditory centre in the superior temporo-sphenoidal gyrus Dr. Ferrier does not rely alone upon the result of extirpation, but adduces also the movements of the ear and eyes which follow electrical excitation as evidence that a subjective auditory sensation is thereby evoked. Taken by itself this is no

evidence at all, for similar movements may be obtained from excitation of totally different portions of the cerebrum, to say nothing of the cerebellum and of the lower nerve-centres. It only becomes evidence as corroborating the effect of extirpation. But a single "negative instance" is sufficient to overthrow the hypothesis that the auditory centre is situated in the superior temporo-sphenoidal convolution alone, and would outweigh many "positive instances." We have, however, only the one well-recorded "positive instance" of Dr. Ferrier (and this was not altogether free from doubt) as against several "negative instances" (those of Munk, Luciani, and ourselves; which last have not yet been published, and could not, therefore, be taken into account by Dr. Ferrier). It is probable, therefore, that Dr. Ferrier's inference is too exclusive, and that other parts of the temporo-sphenoidal lobe must be included in the auditory centre.¹

(4) The view that tactile sensibility is localised in the hippocampal region has naturally been attacked by those who hold that it is to the Rolandic region that the perception of this and other forms of sensibility are to be referred. It would not appear, however, that they have taken the trouble to repeat Prof. Ferrier's experiments upon this region, so that his position can hardly be said to have been seriously assailed. On the other hand, it has received both corroboration and extension from the experiments of Mr. Horsley and myself, the results of which were shown to Dr. Ferrier, and the conclusions arrived at fully concurred in by him (pp. 340-45). These experiments showed in the first place that extensive destruction in the hippocampal region, especially of the posterior part of the hippocampal gyrus, is followed by hemianæsthesia, which is not, however, of a permanent character, but disappears after a few days; and further, that destruction or injury of the gyrus fornicatus (which, as Broca showed, is to be regarded as a direct extension around the corpus callosum of the hippocampal gyrus (see Fig. 2), produces still more marked and far more permanent symptoms of a like kind.

(5) and (6) With regard to the cerebral localisation of the functions of taste and smell, the author in this edition brings forward no new proofs of an experimental nature. But he adduces and quotes evidence from comparative anatomy to show, not only that in animals in which the sense of smell is largely developed (the "osmotics" of Broca) the hippocampal lobule is greatly developed, but also that the development of the anterior commissure, especially of its posterior division, goes hand in hand with that of the hippocampal lobule, and its internal extension, the nucleus amygdalæ, and is therefore to be regarded as a commissure of the olfactory centres. The evidence in the first edition regarding the localisation of taste-perceptions was of the scantiest description, and has been in no way subsequently strengthened, and it is necessary that further experiments should be made upon the subject with the view of testing the opinion which the author has with all caution put forward on the subject.

(7) Upon the special functions of the pre-frontal lobes, or whether any function is in fact specially concentrated in this part of the brain, very little light has been thrown by the researches of the past fifteen years. There is a very prevalent idea that intellectual capacity goes hand in hand with the development of this region, an idea which has existed from the time of the old Greeks, although it was not apparently shared by peoples of yet more ancient civilisation. The idea does not, however, appear to receive any confirmation from the experimental method.

¹ Dr. Ferrier is mistaken in supposing (*vide p. 310*) that the results of the experiments of Mr. Horsley and myself confirm his conclusions regarding the localisation of the auditory centre in the superior temporo-sphenoidal gyrus. The error seems to have arisen from the misunderstanding of a verbal communication. What we did find in one or two cases was that the whole of the temporo-sphenoidal lobe exclusive of the superior gyrus might be removed on both sides without loss of hearing—not the converse, that hearing was abolished on destroying only the superior gyri on both sides. Indeed, we did not in any single instance perform this last experiment.

Animals from whom these lobes have been removed exhibit "a total absence of symptoms" (p. 396). "In my first series of experiments (carried out without antiseptics), I noted, after removal of the prefrontal regions, a decided alteration in the animals' character and behaviour. . . . They had lost, to all appearance, the faculty of attentive and intelligent observation" (p. 401). But that this was due to an extension of the effects of the lesion consequent on the want of antiseptic precautions appears from what immediately follows:—"In some of my latest experiments, in which the lesions were strictly limited (under antiseptic precautions) to the pre-frontal regions, I could not satisfy myself of the existence of any appreciable mental deterioration. . . . A similar total absence of discernible symptoms has been observed also by Horsley and Schäfer" (p. 396).¹

On the other hand, Dr. Ferrier believes that he has in one or two instances obtained unequivocal evidence that the whole of the pre-frontal lobe is concerned with the movements of the head and eyes, being an extension forwards of the centre for those movements which he had previously described. Nevertheless, he quotes approvingly certain observations of Hitzig and of Goltz upon dogs in which this region had been destroyed upon both sides, and which appeared in consequence to exhibit weakness of memory and lack of attention, without any paralysis of movement or sensation, as tending to confirm, what the comparative study of the relative development of the frontal lobes in different animals and individuals appears to show, "that the frontal lobes, the cortical centres for the head and ocular movements, with their associated sensory centres, form the substrata of those psychical processes which lie at the foundation of the higher intellectual operations" (p. 467). The qualification which I have italicised takes away the whole point of the statement so far as relates to the region under discussion. And a single well-recorded instance in man (such as the celebrated American crowbar case), in which there has been extensive destruction of this region without the occurrence of any appreciable symptoms during life, renders it manifest that there can be no restricted localisation of any special function in this part.

"Munk professes to have found that after destruction of the pre-frontal region in dogs and monkeys, paralysis occurs in the muscles of the trunk on the opposite side. . . . My own experiments, as well as those of Horsley and Schäfer, disprove Munk's assertions in the case of monkeys," and "in regard to dogs they are flatly contradicted by Hitzig, Kriworotow, and Goltz." Moreover, "Horsley and Schäfer have shown that the centres for the trunk-muscles" in the monkey "are in the marginal convolutions" (pp. 400-401). It is not a little curious to observe how in the desire to conform to the prevalent view regarding the frontal region being the special seat of intelligence, both Ferrier and Munk endeavour to prove that the different movements which they respectively associate with this region are particularly related to the development of the intellectual faculties. Munk even goes so far as to assert that the development of the *trunk-muscles* in mammals marches *pari passu* with the evolution of the intellectual capacity. One is surprised that he has not carried the comparison yet further, and drawn attention to the relation between the "wisdom of the serpent" and the complexity of the movements of the reptilian trunk!

The amount of space which it has been necessary to occupy in discussing the question of cerebral localisation may be justified, not only by its general interest and importance, but also by the fact that the author of this work is one of the most prominent exponents of a doc-

¹ Further on (p. 402) the author states that we have noted signs of stupidity in the monkeys in which we had removed the pre-frontal regions. I do not think, however, that such dullness as was exhibited in one or two of these cases was more marked or lasted longer than with equally extensive lesions of other parts of the brain.

trine which, whether wholly or partially right, has revolutionised cerebral physiology and profoundly modified the department of medicine with which this branch of physiology is linked. We can consequently only refer very briefly to some of the principal alterations and additions which we find recorded regarding other subjects.

The structure of the nerve-centres is treated at much greater length than in the former edition, and is copiously illustrated with many original microscopic drawings by Mr. Bevan Lewis and others. The conducting functions of the spinal cord, which were somewhat cursorily dismissed in the former edition, are here considered at length. The view of Brown-Séquard that there is a differentiation within the cord of the paths for different forms of sensibility is subjected to a searching criticism, with the result that the existence of such tracts is entirely rejected by Dr. Ferrier. He, however, nowhere refers to the question of specific paths for temperature-sensations, a question which has become one of much importance in connection with the recent researches of Blix, Goldscheider, and others on the differentiation of specific cutaneous points for these and other forms of cutaneous sensibility. To the question of the existence of a "muscular sense," by which is meant that faculty by which we are aware of the position and movements of our limbs without calling in the aid of our visual perceptions, Dr. Ferrier brings forward a considerable weight of argument to prove that it is not to be regarded as in any way a specific form of sensation, and still less a sense of effort or innervation produced by the appreciation by the sensorium of centrifugal discharges which are emitted from motor centres (Bain, Wundt), but that it is merely the result of impressions of tactile sensibility conveyed by the ordinary sensory or afferent nerves both of the muscles and of the parts acted upon by them, and, as such, can have neither a specific path of conduction nor a central terminus apart from the paths and termini for tactile sensibility.

The functions of the spinal cord as a centre for co-ordinate movements are also treated more fully than before, and it is shown that even in the higher animals each segment of the cord may act as a co-ordinating centre for complex and apparently purposeful movements of the limbs. For it has been demonstrated in monkeys by the author, working conjointly with Prof. Yeo, and in dogs by Bert and by Marcacci, that such movements may be evoked by the excitation of single anterior roots in the cervical and sacral regions. And Dr. Ferrier describes one or two experiments, in which he succeeded in stimulating the anterior cornu of the gray matter alone, and which yielded similar results (*vide* note to p. 77). In relation to the functions of the cord, the tonus of the muscles and the so-called "tendon-reflexes" are carefully considered, and their importance as an expression of the condition of the reflex are pointed out. Many new facts are accumulated regarding the remaining parts of the central nervous system, and their bearing upon the functions of the several organs is gone into in several instances with great care and at considerable length. To most of these it is impossible to refer particularly. It may, however, be noted that the direct excitability of the corpus striatum, at least of its caudate nucleus, which has been denied by Franck and Pitres, is positively re-affirmed, and the motor functions of that organ maintained, by Dr. Ferrier, as the result of new experiments performed by him. But, whether or not it be the case that they are directly excitable, it would appear that the precise functions of the basal ganglia, and the relation which they bear to motion and sensation, are as much a matter of conjecture as ever.

To the chapter which deals with the cerebral hemispheres from the psychological aspect one or two important additions have been made, especially in the part

devoted to the consideration of speech, in which the conditions of "word-deafness" and "word-blindness" are now discussed. The view which has been put forward, amongst others, by Dr. Hughlings Jackson, that there are other and higher centres, over and above those which have been demonstrated by physiological and clinical research, which form the substrata of the higher mental operations, does not receive support from Dr. Ferrier. "It seems more reasonable to believe that there may be higher and lower degrees of complexity in the same centres than to assume the separate existence of more highly evolved centres, for which no evidence is obtained by the results of experimental research" (p. 460).

It might have been expected that the remarkable conditions of the cerebral functions which are met with in both man and animals in an hypnotic state would at least have been alluded to in this edition, but they appear to have entirely failed to attract the author's interest, and the subject is passed over in silence.

In conclusion it may confidently be affirmed that, whatever exception may be taken to this or that statement or opinion, or to the mode in which this or that question is discussed, this new edition of Dr. Ferrier's work, from the care with which it has been revised, the extent of the information which it contains, and the clearness of style and lack of ambiguity which characterise its every page, must prove of the greatest value to the student of neurology, and cannot fail to enhance the high reputation of its author. E. A. SCHÄFER

THE VALUE OF THE NEW APOCHROMATIC LENSES

AT the annual meeting of the Royal Microscopical Society, the Rev. Dr. Dallinger, who was elected President for a fourth year, delivered his annual address, in the course of which he gave a judgment concerning the new object-glasses made with the new German glass, in the following terms:—

In proceeding to fulfil the honourable duty that, by your courtesy, devolves upon me, I purpose in the main to follow the line I have taken in preceding years. I congratulate the Society on its work, and on its steady influence in promoting progressive improvements in the optical and mechanical construction of the microscope, devoid of all prejudice as to how, or from whence, such improvements may come. And whilst, happily, it is not of necessity a President's duty to pass in cursory review the microscopical work of the year, there are times when it may be well for him to review the points of improvement that have been made in the instrument itself.

For the past twenty years I have had an increasing interest in the continuous improvement of the optical appliances of our instrument—an interest which, from the first, applied not only to objectives, but also to eye-pieces and condensers, which consecutive calculation, thought, and experience have shown to have a correlated importance.

Eighteen years ago I had, by practice, made myself fairly master of a $1/25$ -inch objective of that period made by Powell and Lealand. I still possess that lens, and it is as good a lens of its class as they ever constructed. Soon after, I became equally familiar with a $1/50$ -inch of the same class by the same makers.

By saying that I became master of these lenses, I mean that I discovered exhaustively what they would and what they would not do. By this, I learned definitely what I wanted in lenses, if I could get it; and to get that has been my unceasing endeavour until now. And certainly the quest has not been vain. And my method has been to examine impartially, and possess myself of, English, Continental, or American lenses, whenever they have shown any capacity for doing best what my work proved to me required to be done.

I know that, in estimating the quality of a lens by the class of image it affords of certain test-objects well known to us, a certain amount of empiricism must take place. We do not absolutely know the image it ought to present. But this only applies within very narrow limits. Take the Podura scale: I can give you an image of it with my $1/25$ -inch and $1/50$ -inch of twenty years ago. What I, in common with most microscopists, considered then the best result, the most sharp, clear, and delicately defined image, with those lenses I can get now; but, with those lenses, nothing better.

But the elements—the essential features that constituted the quality of beauty in that image—are the very elements, the actual features, that every admitted improvement in our object-glasses has brought out more perfectly. So that if I now put, say, the Podura scale under my old dry $1/25$ -inch objective, and, beside it, another precisely similar scale under a new homogeneous $1/20$ -inch objective of N.A. (numerical aperture) 1.5, the very qualities of the image which I, and experienced microscopists generally, thought the best twenty years ago are incomparably transcended in beauty and perfectness now.

But that is not, and has not been, my only or my chief test. It has been one more eminently practical, so far as my own work went; at least for some years.

Up to ten years ago, although I had spent weeks in patient effort, no lens that I possessed, or that was within my reach, could be made to reveal the flagella of *Bacterium termo*. The flagella of many minute monads and of such Bacterial forms as *Spirillum volutans*, and even *Bacterium lineola*, I could demonstrate, though some of them with difficulty; but not a trace of that of *B. termo*. But, near that time, Powell and Lealand produced a battery of immersion-lenses on a new formula and of much relative excellence; and with these lenses the flagella of *B. termo* were brought within the range of sight.

Since that time that has been a good lens, to me, in proportion to the greater or less ease and perfection with which it has revealed this delicate fibre. And let me say that such lenses as do this are those that always, without fail, give us the best ideal image of Podura scales and other tests. You will pardon me, I trust, for this amount of personal reference, since it will give a greater relevancy to what will follow.

Improvements of great optical importance have been made during the last few years. The manufacture of homogeneous lenses by Messrs. Powell and Lealand gave us the opportunity, which we could not have with foreign makers, of urging certain modifications. The addition of the correction collar was a minor, but still important, point. But the great point was the increase of the N.A. These makers have shown themselves most anxious, and have spared no efforts, to reach the highest aperture yet attained.

Advancing, say, from N.A. 1.25, they attained to 1.35 in such powers as the $1/25$ -inch and the $1/50$ -inch; subsequently to 1.47 in $1/8$ - and $1/12$ -inch objectives; and finding these, from my working point of view, of such supreme gain, I urged them still on, and was ultimately rewarded by the possession of a $1/6$ -inch N.A. 1.5, followed by a $1/12$ - and a $1/20$ -inch foci of the same great aperture. From each of these I obtained special advantages over all like powers, but with lower apertures, within my reach.

A question frequently asked may be asked again, In what way do these last increments of aperture aid us? The practical answer is not difficult. Speaking from observation, I may say that all the objectives I have employed for the most critical work fail to produce images by the extreme marginal zone of the aperture. It is the judgment of competent judges that it will be fair to roughly estimate this defective outermost zone at 10 per cent.; so that, from the total measurement of the aperture by Prof.

Abbe's method, I find that in practice this amount may be deducted as of very little service, in all apertures beyond about 1.3; hence, to be able to utilise fully any given aperture beyond 1.3, it is practically necessary that the measurement by means of Abbe's apertometer should be about 10 per cent. higher.

But a further advantage of great numerical aperture is that, other things being equal, we can utilise with excellent results deeper eye-pieces.

I have long realised the advantage, with finely corrected objectives, of a far larger series of eye-pieces than the catalogues provide. Messrs. Powell and Lealand several years ago made me one or more eye-pieces between each of their deeper eye-pieces of standard catalogued focus, and they certainly, within the limit of excellence beyond which greater eye-piece power cannot be employed, bring out to far greater perfection the qualities of any high-class object-glass.

But we have had announced to us an improvement in the optical arrangement of the microscope, based upon an important and fundamental change in the media employed in the construction of object-glasses and eye-pieces. It will be known that I refer to the system of apochromatic object-glasses and compensating eye-pieces devised by Prof. Abbe, and under his auspices carried out by Messrs. Zeiss, of Jena.

The aim of the construction of these new objectives and eye-pieces has been to provide a higher degree of achromatism than could be reached by the old media; the new kinds of glass produced at the Jena Optical Glass Works, under the superintendence of Dr. Schott and Prof. Abbe, can be so combined in the construction of an object-glass as to achromatise not only the essential portion of the primary spectrum, but also to a great extent the secondary spectrum, leaving only small residuals of the tertiary order still visible under certain test conditions. The final elements of correction are supplied by "compensating" eye-pieces of special construction designed to correct what Dr. Abbe refers to as "the differences in the amplification of the image for the various colours . . . formed by the objective outside the axis, which cannot be corrected by the objective itself."

The first trials of these new optical combinations made in Germany evoked unstinted praise, and those who, like myself, desired nothing so much as real improvement, awaited their arrival in England with eager and even anxious curiosity.

The first that came to this country came to Mr. Frank Crisp, and by his courtesy this lens, an apochromatic of 1/8-inch focus was placed in my hands. I subjected it to comparison, in succession, with my complete set of high powers, including those of N.A. 1.5, and upon tests, and by methods, which I have indicated.

It will be well understood that the high excellence and great aperture of my three latest object-glasses would have given a very elevated standard of comparison, a standard of comparison, so far as I know, never before reached, and the result was that with the potentiality of the system represented by the apochromatic lens I was most powerfully and hopefully impressed. I felt, in fact, that the lens itself was of great merit. But withal, by my standard of test I felt that its merits had been over-estimated.

It is quite true that on some of my delicate test-objects the truth shown by the apochromatic lens in combination with the "compensating" eye-pieces appeared to advantage when compared with my lenses combined with the ordinary eye-pieces; but when I tried my own various powers with the same compensating eye-pieces I am constrained to say that no real advantage over my latest lenses could be discovered. My judgment, therefore, was most favourable as to the immense advantage of the eye-pieces and of the possibilities that lay in the entire system rather than in the special apochromatic object-glass taken

by itself; and although pressed again and again by the editors of journals to give a public expression of my judgment, I steadily declined, feeling that it was not, and could not at that time, be exhaustive.

Later, an opportunity was courteously afforded me by the makers to examine a complete series of these object-glasses, from 1-inch to 1/8-inch focus, and with eye-pieces fitted for English stands. In the examination of these objectives and their system of eye-pieces I spared no pains to be exhaustive and impartial. I desired to find the evidence of progression in optical excellence, for which I am always in search, and the excellence of the 1-inch greatly impressed me; but I failed to realise my high hopes in the behaviour of the higher powers. The result, however, of a most critical examination was to very greatly strengthen my conviction of the value of the optical system which these lenses represented, and above all of the excellence of the actually new resource provided for us by the compensating eye-pieces.

In what I have here said I must again remind you that the comparison of Zeiss's apochromatic object-glasses was with a group of object-glasses the most carefully made, most excellently corrected, and with the widest numerical apertures, of any object-glasses that had ever passed through my hands, based on the old system of correction. But with this understanding it appears to me a responsibility that I must not evade to state the facts at this crisis in the development of object-glasses. And I do this with the more confidence that, as I have already informed you, Mr. Mayall, wholly independent of me, examined this set of objectives and eye-pieces, and we each recorded separately, in writing, our judgments at the time of examination; and I subsequently found that our resulting judgments were almost identical.

During this time samples of the new optical glass had reached the English opticians, and Messrs. Powell and Lealand in relatively brief time, and on a formula of their own, made an apochromatic 1/12-inch object-glass, and eye pieces, constructed on the plan devised by Abbe. By the wise advice of Mr. Mayall this was exhibited at our November meeting. My high opinion of that lens and its compensating system of eye-pieces I at that meeting expressed, and need only add that since I have become the possessor of a second object-glass of precisely similar construction and power made by the firm, I am much strengthened in the opinion I gave.

We all appreciate the splendid services rendered to microscopy by Prof. Abbe, and it was a happy expression of that appreciation that led Mr. Mayall to propose a visit to Jena, with his microscope and such object-glasses as he thought would worthily represent the standpoint we had now reached in England.

I understand that Prof. Abbe greatly desired this wishing to possess the fullest information as to our methods of testing object-glasses, and to be permitted to examine our best optical work.

I need hardly say that it was a source of great pleasure to me to place at Mr. Mayall's disposal all the lenses and apparatus I possessed that would serve him; for it was in the highest interests of the microscopy of the world that so great a leader in recent progress should see the effects of his teaching and practice as evidenced by our latest object-glasses, and especially by the new apochromatic 1/12th by Powell and Lealand, with its system of compensating eye-pieces.

Mr. Mayall has told us the story of his visit: of his kindly reception; of the earnest and repeated trials of the object-glasses he was able to submit to Prof. Abbe; and of the frank appreciation expressed by Prof. Abbe of the English object-glasses. This comparison will, in my judgment, "make history" for the future of our instrument. It will react here and in Germany. Prof. Abbe's splendid powers are more than ever concentrated on the work of touching a higher perfection in object-glasses;

he knows that every improvement initiated in Jena will be watched by keen eyes in England; and he has evidence, which will be as welcome to him as his work is to us, that we are not likely to neglect any point of excellence, provided only we can be made to see it as such. I understand that Dr. Zeiss admits that the formulæ on which his apochromatic objectives are constructed involve far greater technical difficulties than were met with in the older formulæ; and this is evidenced by the great number of separate lenses combined in the construction.

Now it has long been my judgment, and a judgment that has been confirmed by men of large practical experience, that errors of technical execution, when present, are shown at once by deep eye-pieces: with an object of regular structure, whose image fills the field of the eye-piece, the experienced eye readily detects a want of sharpness. I am bound to say that the apochromatics from Jena did not impress me by this test as having accuracy of technical execution equal to the object-glasses with which they were compared.

On the other hand, I find that with the new apochromatic made by Powell and Lealand I can employ advantageously deeper eye-pieces than I had ever used before.

Now there is a less number of separate lenses in the London objective, and whether this superiority is due to the lesser number of lenses or to other causes I may not determine. I refrain from details concerning the comparisons I, amongst others, made of the lower power apochromatic of Zeiss, further than to remark that in my judgment too much has been sacrificed to the object of enabling the observer to employ very thick cover-glasses. This is, no doubt, a convenience; but if, as in Zeiss's $\frac{1}{4}$ -inch and $\frac{1}{6}$ -inch, the choice lies between object-glasses that cannot be used for covered and uncovered objects and object-glasses that, with a moderate range of thickness for cover-glass, provide that facility, the latter appear to me from a practical point of view to be the better.

I note with interest that Powell and Lealand have made an achromatic oil-immersion condenser of N. A. 1.4, and will probably be able to increase the aperture to 1.5 in proportion as thinner glass is used to mount objects upon. The mechanical part of this instrument had, when it first reached me, a very neat form, but was difficult of manipulation; and this, involving as it did alteration, has prevented me from really testing its merits. But I have just received it, with a mechanical modification I suggested well carried out, and I have little doubt but I shall realise now its optical excellence. On the whole, then, we may rejoice in the fact that a distinct advance has been made in the optics of the microscope, and the more so from a conviction that there lies considerable potentiality still in the sources from which the amount of progress made has resulted.

ATLANTIC WEATHER CHARTS

THE Meteorological Council has just issued a folio of synchronous weather charts for the North Atlantic Ocean and the adjacent continents, those now published forming the first part of a series which embraces the thirteen months from August 1, 1882, to August 31, 1883. The whole series is to be issued in four parts, Part I containing the charts from August 1, 1882, to November 7, 1882. Two charts are given for each day—one shows the barometer, wind, and weather, whilst the other gives the air- and sea-temperature, and weather, the weather being given on both charts for the purpose of easy comparison with other elements. The isobars, or lines of equal barometric pressure, are drawn for each tenth of an inch, and figures are given in the central areas of the several depressions to show the lowest reading of the barometer

recorded by vessels passing through these disturbances. The direction and force of wind are shown by a system of arrows which fly with the wind, and the different forms of arrow exhibit very readily where the wind reaches the force of a gale, whilst the winds at high-level stations, where the elevation is 4000 feet or upwards, are indicated by red arrows. The air- and sea-temperatures are shown by different coloured isotherms, or lines of equal temperature, which are drawn for each 5° F. The weather, such as rain, fog, or mist, is shown by different methods of shading, and, as mentioned above, is given with each style of chart. The synchronous hour for which the observations are charted is noon Greenwich time, except in the case of air- and sea-temperature, where local noon has been taken in preference. No letterpress has been published with the charts except a few explanatory notes, in which it is stated that the study of the weather of Western Europe for many years has established in a manner that is beyond question that the atmospheric disturbances, on which the changes of weather are in a great measure, if not mainly, dependent, reach our western coasts after having passed for a longer or shorter distance over the Atlantic. The Meteorological Council undertook the investigation with a view to ascertaining as far as possible the conditions under which such disturbances either originate in or traverse the Atlantic, and the extent to which the direction of their course, their magnitude, and persistence, may be influenced by the general meteorological conditions of the area within which they are generated, or of the regions which surround that area.

The period embraced by the charts is that during which the international system of circumpolar observations was being carried out, and data have thus been obtained from very high northern latitudes, which could not otherwise have been procurable, and by these means the results embodied in the charts have not only been rendered far more complete, but are of an exceptional value, not likely to be soon equalled. Among the circumpolar observations regularly used for the charts are those made at Spitzbergen and Jan Mayen, two stations which add materially to the value of the information on the eastern side of the Atlantic, as they enable many very important barometric changes to be traced which would otherwise be lost, and they help much in fixing the position of disturbances which have skirted the British coasts, and at the time when our weather is improving as these bad-weather systems are passing away.

There are, on an average, observations from rather more than 400 ships for each day, in addition to which there are daily observations from about 300 land stations. In all 11,236 returns, each containing the records of many days, have been received from about 3000 vessels. So large a number of observations have never before been used in the drawing of synchronous charts, and this of itself renders the work quite unique in its character. The area embraced, which extends from the Pacific Coast of America to the east of Moscow, in the heart of Russia, and from the Arctic to the Equator, enables the numerous weather changes to be watched day by day for days together, and allows of a very extensive and comprehensive view of the influence of the several varying conditions of the weather.

The charts show many very interesting features of weather changes, and they exhibit very clearly the general way in which the weather systems move from west to east in the middle latitudes. They show very frequent tracks of low-pressure areas to the north of the parallel of 40°, such areas being frequently observed over the United States; and after traversing North America, they intensify and develop energy on reaching the Atlantic, apparently gaining much of their strength from the supply of vapour over the ocean. Many such storms can be traced across the Atlantic, while some die out

after traversing only a part of that ocean. On the other hand, others are formed over the Atlantic, and especially in the vicinity of Newfoundland, where there is the mingling of hot and cold water, and where, as shown by both air- and sea-isotherms, there is a very great difference of temperature in a very small area. There are numerous instances both of the formation of storms and also of their sudden breaking up. It is also seen how at one time a storm will divide into two parts, and each will follow its independent course, while at another time two well-developed storms will merge and become one. The charts show how, as one of these travelling disturbances is approaching the British Islands, the weather becomes unsettled, and how, as the outer edge of the front segment strikes our coasts, the wind backs to the southward, and in a short time rain begins to fall and the wind freshens. If the disturbance passes over the British Islands, the changes are generally both important and rapid, whilst, if the storm area merely skirts our western coasts, as is the more common experience, the changes are less marked, and influence in the main only our western and northern coasts. The first issue of these charts deals only with the autumn, but they show very different conditions of weather at the early part of this season from those at its close, the whole system of weather being more disturbed as the season advances. There is, however, throughout the period a permanent area of high barometric pressure situated in mid-Atlantic, on the northern side of which the travelling disturbances move. This area of high barometer oscillates from day to day within fairly well-defined limits, and is very seldom altogether broken up; and doubtless a close study of the behaviour of this high-pressure area will tend to materially advance our knowledge of the now almost hopelessly puzzling weather changes with which in weather-forecasting we have to combat.

Among other points of interest exhibited by the charts may be mentioned the graphic manner in which the earlier charts show the meeting of the north-east and south-east trade-winds and the seasonal march of the limits of these winds with the sun. They also show that at the end of the summer the temperature of the air is warmer than the sea to the extent of 2° or 3°, while, as winter is approached, the sea is slightly the warmer. In September there is a good instance of the formation of a West Indian hurricane which eventually crosses the Atlantic and passes to the north of Scotland, and the chart of November 1 shows the vast extent of some of these Atlantic storms, one gale blowing over the whole ocean from the coast of America to that of Europe.

It is scarcely possible to over-estimate the high value of this series of charts. The most practical outcome of their publication, it is hoped, will be an improvement of our weather forecasts and storm warnings and a general extension of our knowledge of the laws which regulate the weather changes in our own islands; whilst from a nautical point of view they are of the utmost value to the seaman in enabling him to follow in detail the many changes he experiences, and they may assist him at times in making a better passage.

GILDED CHRYSALIDES¹

PREVIOUS WORK.—Mr. T. W. Wood in 1867 published the observation that certain pupæ (*Pieris brassicae*, *P. rapæ*, &c.) resemble in colour the surface on which they are found. Although this was disputed by some naturalists, it was confirmed by Mr. A. G. Butler and Prof. Meldola. In 1874 Mrs. M. E. Barber published some very striking observations on the colours of the pupa of *Papilio nireus* (South Africa), confirmation being afterwards afforded by Mr. Trimen, from the case of

Papilio demoleus. Dr. Fritz Müller, however, shows that *Papilio polydamus* is not sensitive to surrounding colours. The observations were explained by supposing the moist skin of the freshly-formed pupa to be "photographically sensitive" to the colour of surrounding surfaces; but Prof. Meldola pointed out that there can be no real analogy with photography. Furthermore, many pupæ are formed at night, when the surrounding surfaces are dark. The present investigation was undertaken with the belief that the influence would be found to work upon the larva as it rests upon some coloured surface before pupation.

I. *Experiments upon Vanessa Io*.—This pupa appears in two varieties, being commonly dark gray and much more rarely yellowish-green. Six larvæ placed in a glass cylinder covered with green tissue-paper, produced six green pupæ; one of these, transferred to a black surface while still moist and fresh, became a green pupa precisely like the others.

II. *Experiments upon Vanessa urticae*.—The pupæ have no green form, but appear in many shades of dark gray, the lighter ones having golden spots on them, while the extreme forms are almost covered with the golden appearance. These latter are very rarely seen in nature, except when the pupa is diseased. Over 700 pupæ were obtained in the following experiments:—

1. *Effects of Colours*.—Green and orange surroundings caused no effect on the pupal colours; black produced, as a rule, dark pupæ; white produced light pupæ, many of them being brilliantly golden. This last result suggested the use of gilt surroundings, which were found to be more efficient than white, and produced pupæ with a colour which even more resembled gold.

2. *Mutual Proximity*.—The larvæ being dark, it was found that when many of them became pupæ on a limited (white or gilt) area, the pupæ were darker than when they had been more isolated. The colours of each were in fact affected by that part of the surroundings made up by the black skins of its neighbours.

3. *Illumination*.—Black surroundings produced rather stronger effects in darkness than in light, but the pupæ were dark in both cases.

4. *Time of Susceptibility*.—The mature larvæ, after ceasing to feed, wander (stage i.) until they find a surface on which to pupate; they then rest upon it (stage ii.), and finally hang, head downwards, suspended by their last pair of claspers (stage iii.), in which position pupation takes place. Stage i. is variable in length, stage ii. may be estimated at 15 hours (but it is also variable), while stage iii. is fairly constant, and lasts about 18 hours; while the whole period is commonly about 36 hours in length. The larvæ are probably affected by surrounding colours for about 20 hours before the last 12 hours of the whole period, and in this time the pupal colours are determined. These facts were discovered by a very large number of experiments, in which larvæ were placed in surroundings of one colour, and then after a variable time were transferred to another colour producing an opposite effect. It was thus found that stage ii. is more sensitive than stage iii., although there is some susceptibility during the latter stage.

5. *The Part of the Larvæ which is Sensitive to Colour*.

(a) *The Ocelli*.—The most obvious suggestion was that the larval eyes (or ocelli, six on each side of the head) saw the colours, and, being influenced, transmitted an impulse to the nervous centres which regulate the formation of the pupal colours. When, however, these organs were covered with black varnish, the pupæ resembled surrounding surfaces to the same extent as when they were produced from normal larvæ.

(b) *The Complex Branching Spines*.—It seemed possible that these structures might contain some organ which was influenced by the colour, but after cutting them off the larvæ remained normally sensitive.

¹ Abstract of Lecture delivered by Mr. Edward B. Poulton at the Royal Institution, on Friday, February 11.

(y) *The General Surface of the Skin.*—This was tested by conflicting colour experiments. It had been previously known that the larvæ were sensitive during stage iii., and therefore they were covered in this stage with compartmented tubes, so constructed that the head and anterior part of the body hung in the lower chamber of one colour, while the posterior part of the body was in the upper chamber in another colour. In another method the larvæ were hung upon a vertical surface, while the head and front part of the body passed through a hole in a shelf, the vertical surface above the shelf, and the upper side of the shelf itself being one colour, while the vertical surface below the shelf and the lower side of the shelf were of the colour tending to produce the most opposite effects. The result of all these experiments was to show that the colour influence does act on some element of the larval skin, and at the larger the area of skin exposed to any one colour the more does the pupa follow its influence. Partly coloured pupæ were not obtained, thus perhaps pointing towards the action of the nervous system rather than towards the direct action of light on or through the skin itself.

6. *The Nature of the Effects Produced.*—The colouring-matter of the dark pupæ is contained in a thin superficial layer of the cuticle; below this is a thicker layer divided into exceedingly delicate lamellæ, between which air is present, and the latter form the thin plates which, by causing interference of light, produce the brilliant metallic appearance. The thinner upper layer, being dark, acts as a screen in the dark pupæ. Precisely the same metallic appearances are caused by the films of silver between the thin plates of glass which are formed on the surface of bottles long exposed to earth and moisture. These have the same spectroscopic characters and the same transmitted colours (complementary to those seen in reflection). The brilliancy of the cuticle can be preserved in spirit for any length of time; it disappears on drying, but can be renewed on wetting (this had been previously known), and the colours are seen to change during the process of drying, and when the cuticle is dried, for the films are thus made thinner. The same cellulated layer exists in non-metallic pupæ of other species, and is used as a reflector for transparent colouring-matter contained in its outer lamellæ. Thus the structure which rendered possible the brilliant effects due to interference probably existed long before these special effects were obtained, and was used for a different purpose.

7. *The Biological Value of the Gilded Appearance.*—It is probable that the gilded pupæ of *Vanessidæ* resemble glittering minerals such as mica (which is very common in many places); their shape is very angular, and like that of minerals: conversely the gray pupæ resemble gray and weathered rock-surfaces, and the two conditions of rock would themselves act as a stimulus for the production of pupæ of corresponding colour. The former was probably gained in some dry hot country, where mineral surfaces do not weather quickly. Once understood, it may be used for other purposes, and in certain species is probably a warning to the enemies that the insect is inedible. It is interesting to note how the *Vanessidæ*, primarily coloured so as to resemble mineral surroundings, are modified for pupation on plants. Thus *Vanessa Io* has a green form which is produced among rocks; *V. atalanta* has no green form, and spins together the leaves for concealment, but both these species commonly pupate freely exposed on mineral surfaces; *Urtica* has neither the green form nor the habit of concealment, and it has a strong disinclination to pupate on its food-plant, as many observations concurred in showing.

[II. *Experiments upon Vanessa atalanta.*—This species was also made brilliantly golden or dark-coloured by the use of appropriate surroundings in the larval condition.

[V. *Experiments upon Papilio machaon.*—This species,

like *P. polydamus* (Fritz Müller), has no power of being influenced by surrounding colours. A brown pupa was obtained on the food-plant, and many green ones upon brown twigs, &c. It is possible that the amount of shade may determine the formation of the dark pupa irrespective of colour, or that less healthy and smaller larvæ may produce the brown form, just as diseased *Vanessa* larvæ produce gilded pupæ.

V. *Experiments upon Pieris brassicæ and P. rapæ.*

1. *Effects of Colours.*—Black produced dark pupæ, and the greater the illumination the darker the pupæ (*P. rapæ*), this result being the reverse of that obtained with *V. urticae*; white produced light pupæ, and the greater the illumination the lighter the pupæ (*P. rapæ*); dark red (*P. brassicæ*) produced dark pupæ; deep orange, in both species, produced very light pupæ of a green colour; pale yellow and yellowish green produced rather darker pupæ than the orange; bluish-green produced much darker pupæ; while dark blue produced still darker pupæ (*P. rapæ* only). Hence there is a remarkable and sudden fall, followed by a slow and gradual rise in the amount of pigment formed as the light from various parts of the spectrum from red to blue predominates in the reflected rays which fall on the larval surface. But their effects on the formation of superficially placed dark pigment are accompanied by changes affecting the formation of greens and yellows, &c., in the deeper sub-cuticular tissues. Hence the results of any given stimulus are exceedingly complicated.

2. *Other Experiments.*—It was shown by the method described above that the ocelli are not sensitive in this species, and by similar transference experiments it was proved that the influence acts on the larva and not on the pupa itself.

VI. *Experiments upon Ephyra pendularia.*—In this genus of moths the exposed pupæ are often green and brown in different individuals, but these colours follow the corresponding tints of the larvæ, and therefore cannot be influenced unless the latter themselves were changed, and such susceptibility in the larval state has not been proved for this genus. This is the only known instance of a constant relation between the larval and pupal colours.

VII. *Experiments upon the Cocoon of Saturnia carpini.*—It was found that the larvæ spin dark cocoons in black surroundings, but white ones in lighter surroundings.

NOTES

THE principal officers for the Manchester meeting of the British Association, to begin on August 31, under the presidency of Sir Henry Roscoe, have now been selected. The following will be the Presidents of the various Sections:—Section A, Mathematics and Physics, Sir Robert S. Ball, Astronomer Royal for Ireland; B, Chemistry, Dr. Edward Schunck, F.R.S.; C, Geology, Dr. Henry Woodward, F.R.S.; D, Biology, Prof. A. Newton, F.R.S.; E, Geography, General Sir Charles Warren, R.E., G.C.M.G.; F, Economic Science, Dr. Robert Giffen; G, Mechanical Science, Prof. Osborne Reynolds, F.R.S. For Section II, Anthropology, a President has not yet been chosen. One of the public lectures will be given by Prof. H. B. Dixon, who has taken as his subject "The Rate of Explosions in Gases." The lecture to the working classes will be given by Prof. George Forbes. It is expected that, socially, the Manchester meeting will be one of the most brilliant ever held. A very large sum has already been subscribed, and liberal arrangements are being made for excursions and other entertainments.

THE trustees of the fund established by Mrs. Elizabeth Thompson, of Stamford, Connecticut, "for the advancement and prosecution of scientific research in its broadest

sense," having accumulated income available for grants, desire to receive applications for appropriations in aid of scientific work. This endowment is not for the benefit of any one department of science, but it is the intention of the trustees to give the preference to those investigations which cannot otherwise be provided for, which have for their object the advancement of human knowledge, or the benefit of mankind in general, rather than to researches directed to the solution of questions of merely local importance. Applications for assistance from this fund should be addressed to the Secretary of the Board of Trustees, Dr. C. S. Minot, Harvard Medical School, Boston, Mass., U.S.A., and should be accompanied by a full statement of the nature of the investigation, of the conditions under which it is to be prosecuted, and of the manner in which the appropriation asked for is to be expended. The new grants will probably be made in May next.

IN consequence of the date fixed for the celebration of the Queen's Jubilee, the Senate of the University of London have deemed it necessary to change the time of holding the ensuing Matriculation Examination from the week beginning Monday, June 20, to the preceding week beginning Monday, June 13.

IN his annual Report for the year 1886, Mr. H. B. Medlicott, Director of the Geological Survey of India, explains how it happens that Bengalis have not hitherto been employed in connection with his department. The Survey, he points out, has no duties of a mechanical nature to which, and through which, it would be possible to break in the uninitiated. Its work is strictly scientific, and requires the constant exercise, upon scanty data, of an independent, conscientious, and sober judgment. Now, Mr. Medlicott holds that Bengalis have not yet shown that they are fit for such work as this. "In Bengal," he says, "the word of knowledge has been preached for the last two generations, but in no single case has it found the needful germ in which it might come to maturity and bear fruit in original scientific work; it seems only to develop a more obnoxious kind of weed—words of science without substance. In the medical and engineering services they have for long had like teaching and opportunities to those from which Darwin, Huxley, Tyndall, and a host of others have arisen, but of like result in Bengal there is no symptom even. For a still longer period the practical results of the new knowledge in the shape of material progress have been displayed with ever-increasing energy from the West, but neither has this awakened in the Oriental mind a power to do likewise. Of imitation there is no lack, but of creative power there is no sign. If this is not a demonstration on the part of the Bengali of his ineptitude for science, evidence counts for nothing. He would do well to take it to heart, if by any means he may correct his failing. Meanwhile, even if there were not particular evidence to confirm it, I hold this as sufficient warrant for objecting to the appointment of natives to the slender staff of the Geological Survey."

MR. A. LAWRENCE ROTCH, the proprietor of the Blue Hill Meteorological Observatory in the United States, has recently issued a pamphlet giving an account of the foundation and work of the observatory. According to the *American Meteorological Journal*, the station on Pike's Peak, 14,000 feet above the sea, is of problematic value to meteorology, whereas "the Blue Hill Observatory, only 635 feet above the sea, and much younger, has already been of considerable meteorological service."

SOME time ago we referred to the fact that experiments were being made at Fort Scott in connection with the manufacture of sugar from Sorghum. A report on these experiments was lately presented to the U.S. Department of Agriculture by Mr. H. W. Wiley, to whom the conduct of the work was intrusted. The results were very discouraging, and the failure is attributed

by Mr. Wiley to the following causes:—(1) Defective machinery for cutting the canes and for elevating and cleaning the chips and for removing the exhausted chips. (2) The deterioration of the cane due to much of it becoming over-ripe, but chiefly to the fact that much time would generally elapse after the canes were cut before they reached the diffusion battery. The heavy frost which came on October 1, 1886, injured the cane somewhat, but not until ten days or two weeks after it occurred. (3) The deteriorated cane caused a considerable inversion of the sucrose in the battery, an inversion which was increased by the delay in furnishing chips, thus causing the chips in the battery to remain exposed under pressure for a much longer time than was necessary. The mean time required for diffusing one cell was twenty-one minutes, three times as long as it should have been. (4) The process of carbonation, as employed, secured a maximum yield of sugar, but failed to make a molasses which was marketable. This trouble arose from the small quantity of lime remaining in the filtered juices, causing a blackening of the syrup on concentration, and the failure of the cleaning apparatus to properly prepare the chips for diffusion. With regard to the future, Mr. Wiley is of opinion that the chief thing to be accomplished is the production of a Sorghum plant containing a reasonably constant percentage of crystallisable sugar.

MR. HENNESSY, of the Indian Survey, to whom, as we have already announced, the Government of the Straits Settlements applied to aid in a survey of the latter territory, has declined the appointment offered him. *Indian Engineering* observes that as the size and population of the Straits do not come up to those of an Indian district, and as the colony has already a Surveyor-General, a Deputy Surveyor-General, several Assistant Surveyors-General, with a full complement of subordinates, as well as a Special Commissioner of Lands, there must be something wrong when another surveyor from India is required in order to carry out a satisfactory survey. The circumstance appears to require some explanation.

ON December 10, a volcanic eruption of great violence took place in Mount Tarumai in Yezo. Ashes continued to fall for several hours in the vicinity of the foot of the mountain, and on the neighbouring coasts, and even after this had ceased the underground disturbances continued. On December 13 the eruption recommenced, and lasted for four days. A large slip occurred on the side of the volcano, an area of about 10,000 feet square being affected, and stones and other debris fell so thickly as to change the configuration of the sea shore to some extent. Previous eruptions, according to Prof. Milne's work on the volcanoes of Japan, occurred on February 8, 1874; October 7, 1883; January 4, 1885; and April 21, 1886.

ON March 15 a strong shock of earthquake passed through Mandalay, perceptibly moving buildings and trees. No damage occurred.

ON the 9th inst. Mr. W. A. Carter lectured to the Croydon Natural History Society on "Marine and Fresh-water Fishes." Mr. Carter stated that fish have the power of influencing each other by sounds and action, and in support of this assertion he described the movements of a shoal of carp in a pond. He had observed them following the lead of a single congener, which conducted them to a quantity of food a considerable distance off. Referring to fish monarchs, the lecturer said he had noticed that certain freshwater fish, such as the trout, were subservient to a ruler, which might be seen swimming at the head of his tribe, as might also certain marine forms, such as herring and bass.

THE new gun-powder melinite has already begun its work of destruction. Some days ago a bomb filled with this explosive agent exploded by accident in Belfort arsenal, killing six persons, and severely wounding eleven.

A DINNER was lately given to Prof. de Lacaze-Duthiers by some forty or fifty of his pupils, who also presented him with a magnificent engraving of his own likeness. This was a well-earned tribute of admiration for the good and useful work done in the department of zoology by Prof. de Lacaze-Duthiers. He has done great service to students of natural science by his personal labours, by the establishment of the two marine zoological stations of Roscoff and Banyuls-sur-Mer, and by the founding of the *Archives de Zoologie Expérimentale*.

THE zoological station of Cette, on the Mediterranean coast, founded by Prof. Sabatier, of Montpellier, has been recently attached to the École Pratique des Hautes Études. Cette is a very interesting place for zoologists, owing to the abundance of the fauna and its variety.

THE laboratories of the Paris Medical School will soon—that is, in the course of the spring or summer—be transferred to new buildings in front of the Medical School. The present laboratories are ugly and unhealthy.

SOUTHAMPTON, we are glad to see, is anxious to possess a University College of its own. On Wednesday, the 9th inst., a public meeting, over which the Mayor presided, was held to express the general opinion on the subject, and resolutions were unanimously carried in favour of the scheme. In one of these resolutions it was stated that, in the opinion of the meeting, The Hartley Institution is admirably fitted, and has high aims, to form the nucleus of a University College for Southampton and the surrounding district.

SIR JOSEPH WHITWORTH'S will, dated December 1884, has now been proved. He leaves two hundred shares in Sir Joseph Whitworth and Company (Limited) to the Owens College, Manchester; eighty shares to the Institution of Civil Engineers, London; and forty to the Institution of Mechanical Engineers. By his will, after making certain bequests, he left the residue of his estate to the School Boards of Manchester, Salford, and Stockport, and to the Science and Department, South Kensington; but by codicils added last year he revokes his bequests to the School Boards and South Kensington, and leaves all his real estate and the residue of his personal estate to his executors and trustees absolutely for their own use and benefit, but in confidence that they will make such dispositions of his property for educational purposes as they know that he would have wished made.

WE regret to announce the death of M. Alexander Borodin, professor of Chemistry at the Medico-Surgical Academy at St. Petersburg, and one of the most eminent Russian musical composers. He died on February 27.

THE death is announced of Dr. Gustav Heinrich Kirchenauer, first Burgomaster of Hamburg, and a well-known naturalist. He died on March 4.

A DECREE has been signed by the King of Italy by virtue of which a new and complete edition of the works of Galileo will be published at the cost of the State. The Minister of Education, with the assistance of some eminent professors, will superintend the publication, which will fill twenty quarto volumes of 500 pages each.

By the investigation of forty-two large North German lakes, the well-known zoologist Dr. Otto Zacharias has proved that the lower fauna occupies an intermediate position between that of the Scandinavian and that of the Swiss and Italian freshwater basins. Since it is supposed that during the Ice epoch gigantic glaciers stretched from the north of Europe to the foot of the Riesengebirge, it is interesting to learn that the North German lakes contain a number of lower Crustaceans that, till now, have only been found in Scandinavia.

THE Academy of Sciences at Berlin has granted the following sums for the furtherance of zoological research:—75*l.* to Dr. Karl Brandt (Königsberg) for investigations on Radiolaria; 50*l.* to Prof. Ludwig (Giessen) for the continuation of his work on Echinoderms; 100*l.* to Dr. Heinicke (Oldenburg) to continue his researches on the varieties of the herring. Besides these sums, 1950*l.* has been given for the printing of some important zoological works, viz. Prof. Dohrn's "Jahresbericht," Dr. Taschenberg's "Bibliothek," and Prof. Fritsch's work on "Electric Fishes."

THE total value of fish landed on the coasts of Scotland for the two months ending February 1887 was 190,068*l.*, being an increase over the corresponding period of last year of 8434*l.*

THE twenty-second volume of the Transactions and Proceedings of the Royal Society of Victoria has been sent to us. It contains the address of Prof. Kernot, the President, delivered on March 11, 1886; and among the papers are "The Atmosphere a Source of Nitrogen in Plant Economy," by Mr. E. Lloyd Marks; "Notes on some Evidences of Glaciation in the Australian Alps," and "The Cryptogamia of the Australian Alps," by Mr. James Stirling; "On an Apparatus for Utilising the Force of the Tides," by Mr. Lockhart Morton; and "On an Apparatus for Determining the Stability of Ships," by Mr. C. W. McLean.

WE have received Parts 21-25 of "Landerkunde des Erdteils Europa." The editor of this admirably illustrated work is Prof. Alfred Kirchoff, and among the contributors are Profs. Penck, Egli, and Heim. The aim of the writers is not merely to describe the countries with which they deal, but to bring out the influence of geographical conditions upon material, political, and social progress.

IN reference to the acclimatisation of flat-fish in American waters, the latest Bulletin of the United States Fish Commission states that in April 1880 five soles sent from England reached New York, and were deposited outside Sandy Hook. In October 1881, out of a consignment of turbot and soles sent from England, three soles and six turbot survived. These were transferred to the Sheep's Head Bay. In order to ascertain whether any trace of these fish could be found, the Fish Commission in October last trawled in the vicinity of the spots mentioned, but did not succeed in capturing any flat-fish.

THE Botanical Museum of Hamburg will be rendered more generally serviceable to German commerce and industry by the addition of a commercial laboratory. For analyses and investigations a most moderate tariff has been set up.

IN an article in the *Entomologist's Monthly Magazine* for March, Mr. Herbert Goss raises the question whether *Aporia crategi* is dying out in this country. At one time this butterfly was common in Kent, Sussex, Hampshire, Huntingdonshire, Northamptonshire, Herefordshire, Monmouthshire, and Glamorgan-shire. Now it has disappeared, apparently, from all these counties. Mr. Goss does not think that this can be attributed to the rapacity of collectors, and he holds that it can be accounted for only in some localities by cultivation and drainage. It seems to him more probable that the extreme scarcity or total extinction of the Black-veined White may be due to a succession of wet ungenial summers and mild winters.

THE investigations into the causes and nature of the species of elephantiasis known in Java as *beri-beri*, and in Japan as *kakke*, which have been conducted at Acheen, in Sumatra, by a medical officer delegated by the Japanese Government, and Dr. Cornelissen, Inspector of the Medical Service of the Netherlands India, have led to the following results: (1) *beri-beri* must be regarded as a disease produced by minute organisms; (2) these

organisms are Bacilli, which bear most resemblance to the *anthrax* Bacilli, but not smaller; (3) they are found in the blood, lungs, heart, and nervous tissue of persons dying of the disease; (4) they can be reared independently; (5) the Bacilli, which can live as parasites in the human organism, can also live and multiply out of it. These facts, which are said to be established by the investigations, explain how *beri-beri* patients can infect particular places, and how healthy individuals coming from uninfected places contract the disease in infected ones.

Mr. W. H. BEEBY has reprinted from the *Scottish Naturalist* some interesting notes on the flora of Shetland. They are the result of a visit of about eight days to the Shetland Islands at the latter end of July last. Four distinct districts were visited, the greater amount of time being spent in Unst. Mr. Beeby is of opinion that the flora of the Shetland Islands is well worthy of further attention. An explorer would, he thinks, be rewarded by finding plants which are at present known only in the Faeroes and in Scandinavia.

THE contents of Part 2, No. 3, of vol. lv. of the Journal of the Asiatic Society of Bengal include a short paper by Dr. King, on two new species of holly from the Eastern Himalayas, but are otherwise purely entomological. Prof. Forel continues his critical examination of Indian ants in the Calcutta Museum. Mr. de Nicéville describes nine new species of Indian butterflies, chiefly from Sikkim (which are to be figured in a succeeding number). Mr. Doherty, of Cincinnati, U.S.A., communicates a paper on new or rare Indian butterflies, many of which are from the Nicobar Islands; and Mr. E. T. Atkinson, President of the Society, gives a compilation of what has been written concerning Indian Coccidæ, which may be taken as an introduction to the study of this obscure and injurious family of insects in India. The author has chiefly followed Signoret in the systematic arrangement. The collected information will prove useful in India, for some of these scale-insects have been most destructive to coffee and other plantations. Having a clue as to how and what to observe, Indian entomologists will, no doubt, soon show that legions of Coccidæ exist in India, as elsewhere, and many strange forms will be detected.

THE additions to the Zoological Society's Gardens during the past week include a Gray Ichneumon (*Herpestes griseus*) from India, presented by Mr. C. F. Hird; a Golden Eagle (*Aquila chrysaetos*) from Scotland; a Chilean Sea-Eagle (*Geranoaetus melanoleucus*) from South America; a Brazilian Caracara (*Polyborus brasiliensis*) from Brazil, presented by Mr. C. Czarnikow; a Bronze-winged Pigeon (*Phaps chalcoptera*) from Australia, presented by Mr. Malcolm Nicholson; two Red-crested Cardinals (*Parouaria cucullata*) from Brazil; two Cockateels (*Calopsitta nove-hollandiæ*) from Australia, presented by Colonel F. D. Walters; two Crested Newts (*Molge cristata*), presented by Mr. Alban Doran; a Lesser White-nosed Monkey (*Ceropithecus pectorata*) from West Africa; two Blue-fronted Amazons (*Chrysotis ætiva*) from South America, deposited; a Hog Deer (*Cervus porcinus*), born in the Gardens.

OUR ASTRONOMICAL COLUMN

TELEGRAPHIC DETERMINATION OF AUSTRALIAN LONGITUDES.—A "Report on the Telegraphic Determination of Australian Longitudes," signed by Messrs. Ellery, Todd, and Russell, has recently been published by the Government of South Australia. This Report contains the final results of the operations connecting Singapore and Port Darwin, carried out in 1883 by Capt. Darwin, R.E., in concert with the Australian astronomers above mentioned. The Observatories of Melbourne, Sydney, and Adelaide were subsequently connected with Port Darwin. The preliminary results of these telegraphic longi-

tude determinations were communicated by Mr. Todd in 1883 to Sir G. B. Airy, and published in the *Observatory* for October of that year. The longitude of Singapore adopted in forming the results given in the Report before us is that determined by Commander Green, U.S.A., in 1882, viz. 6h. 55m. 25^o. East of Greenwich (for Capt. Darwin's station), assuming that of the Madras Observatory to be 5h. 20m. 59^o.42s. Hence the resulting longitudes are:—

	h.	m.	s.
Observatory, Port Darwin	8	43	22.49
" Adelaide	9	14	20.30
" Melbourne	9	39	54.14
" Sydney	10	4	49.54
" Wellington, N.Z.	11	39	6.52
" Hobart	9	49	19.80

The observations for the purpose of connecting Singapore with the various points in Australia are given in sufficient detail in the Report to enable us to see that the determinations have been made with care and attention to detail, and appear to be deserving of every confidence. The New Zealand and Tasmanian results may perhaps require further correction.

COMETS AND ASTEROIDS.—Prof. Daniel Kirkwood has a brief note in the *American Journal* for January 1887, on the origin of comets, in which he points out the probability that two, at least, of recent short-period comets have had an origin in the zone of asteroids. Tempel's comet (1867 II.) has a period, inclination, and longitude of node approximately the same with those of Sylvia (Minor Planet No. 87), whilst its eccentricity is but little greater than that of Ethra (No. 132). Wolf's comet (1884 III.), before its last close approach to Jupiter, had an eccentricity which was exceeded by twelve known minor planets; its period was about 3619 days, and its mean distance 4.611, so that it would appear to have been simply a very remote asteroid. Its period was very nearly commensurable with that of Jupiter.

THE TAILS OF THE COMETS OF 1886.—Prof. Th. Bredichin has recently examined the curves of the tails of the three principal comets of last year in connection with his well-known theory as to the laws of formation of the tails of comets. The two first comets, those of Fahry and Barnard (1886 I. and II.), proved difficult to observe, the earth being nearly in the plane of the orbit of the former comet, so that the foreshortening greatly increased the errors of observations, whilst the tail of the latter was very short, and was diffused on one side. Both, however, were of the same type, the second, $1 - \mu$ being found to be equal to 1.3 for the first, and 1.9 for the second. The third comet referred to, that discovered almost simultaneously by Mr. Barnard and Prof. Hartwig, proved much more important for the purposes of Prof. Bredichin's theory, since it showed three tails. Of these the principal one plainly belonged to the first type, a value of 17.5 for $1 - \mu$ satisfying the observations very fairly. The shorter tail seen by a number of observers plainly belonged to the third type, $1 - \mu$ being very small, whilst a third tail, seen by Mr. Backhouse (*NATURE*, January 6, p. 224), and lying between the other two, evidently belonged to the second type.

MINOR PLANET No. 265.—M. Bigourdan points out (*Comptes rendus*, vol. civ. No. 9) that the motion of R.A. of this body is unusually rapid, amounting to $-1m. 40s.$, or double the ordinary value for the other asteroids. As the planet is nearly exactly in opposition, it must be relatively near the earth, and may therefore be very advantageously employed in the future for the determination of the solar parallax.

ASTRONOMICAL PHENOMENA FOR THE WEEK 1887 MARCH 20-26

(FOR the reckoning of time the civil day, commencing at Greenwich mean midnight, counting the hours on to 24, is here employed.)

At Greenwich on March 20

Sun rises, 6h. 5m.; souths, 12h. 7m. 37.7s.; sets, 18h. 11m.; decl. on meridian, $0^{\circ} 10' S.$; Sidereal Time at Sunset, 6h. 3m.

Moon (New on March 24) rises, 4h. 30m.; souths, 9h. 10m.; sets, 13h. 57m.; decl. on meridian, $15^{\circ} 39' S.$

Planet	Rises		Souths		Sets		Decl. on meridia ⁿ
	h.	m.	h.	m.	h.	m.	
Mercury	5	48	12	13	18	38	4 10 N.
Venus	6	51	13	43	20	35	9 22 N.
Earth	6	22	12	38	18	54	2 27 N.
Mars	21	18*	2	22	7	26	11 42 S.
Jupiter	11	7	19	16	3	25*	22 30 N.

* indicates that the rising is that of the preceding evening and the setting of the following morning.

Planet	h.	Event
Mercury	22	Sun in equator.
Venus	3	Mercury in inferior conjunction with the Sun.

Variable Stars

Star	R.A.		Decl.	Date	h. m.		
	h.	m.			h.	m.	
Antares	3	0.8	40 31 N.	Mar. 20,	4	36 m	
Aldebaran	6	57.4	20 44 N.	Mar. 25,	23	1 25 m	
Arcturus	7	25.4	9 33 S.	Mar. 25,	22	14 m	
Betelgeuse	8	37.5	19 26 N.	Mar. 21,	22	42 m	
Castor	10	32.0	12 48 S.	Mar. 22,		m	
Procyon	14	54.9	8 4 S.	Mar. 23,	22	47 m	
Corona	15	13.6	32 4 N.	Mar. 24,	1	1 m	
Polaris	17	10.8	1 20 N.	Mar. 23,	4	12 m	
and at intervals of 20 8							
Sagittarii	17	57.8	29 35 S.	Mar. 25,	23	0 m	
Regulus	18	45.9	33 14 N.	Mar. 21,	23	0 m	
Antares	19	46.7	0 43 N.	Mar. 25,	4	0 m	
Quara	23	38.0	15 55 S.	Mar. 25,	22	0 m	

M signifies maximum; m minimum.

Meteor-Showers

Year 55 Aurigæ, R.A. 98°, Decl. 45° N.; and on March 20, r θ Ursæ Majoris, R.A. 145°, Decl. 48° N.

GEOGRAPHICAL NOTES

OXFORD has decided to establish a Readership in Geography; didates are invited to apply. Cambridge has postponed ng a similar step till 1888. While on this subject we may e that by a new Imperial ordinance geography has been ed to an equal footing with the most important subjects ght in German middle-class schools — *Realschulen* and *unasiem*. The programme for the examination of teachers ring to make this one of their special subjects has been ed. There are three grades, and the standard in each is y high.

ACCORDING to advices received at Zanzibar from Uganda, Junker's caravan safely reached Emin Pasha, who was in d health. Intelligence has also been sent to Zanzibar that months ago Emin Pasha visited Uganda, but that King vanga refused to allow him or his followers to pass through territory. Emin Pasha then attempted to make arrangements his passage through Karagwa, on the western shore of the toria Nyanza, but failed in this also, and afterwards returned Vadelai, leaving a detachment of soldiers at Unyoro under command of Capt. Casati, Emin Pasha's sole European panion.

WE learn on the best authority that Mr. Stanley, on his val at Stanley Falls with the first contingent of his Expedi-, about 250, will proceed at once to Emin Pasha, without ting for the rest of his party. No doubt he will be reinforced some of Tippoo's men, and in this way there will not be a nent's delay. The main body will follow as soon as steamers able to land them all at Stanley Falls, but first a camp will established at some distance from the Falls as a base of rations. Dr. Junker gave an account of his seven years' loring work, on February 26, to the Cairo Geographical iety. His magnificent maps were shown, one of them asuring 13 feet by 23 feet. Dr. Schweinfurth maintained the olute accuracy of Junker's maps in all respects. Junker then e a detailed account of his sojourn in the Niam-Niam ntry. Here he found extensive fertile plains, veritable annaha, with grass over 3 feet high, and abundance of game. then passed on to his exploration of the Wellé and the

Mepoko, to within four days' journey of the Congo, concluding by giving some interesting details of the effect of the Mahdi revolt on these countries.

THE well-known African traveller, Dr. Zintgraff, who has been commissioned by the German Government to explore the Cameroon district, intends visiting the Cameroon Mountains. As large quantities of caoutchouc are said to be obtained there, Dr. Zintgraff will be accompanied by an expert in that material.

AN official publication of the Colonial Office (African, No. 332) contains a great deal of original information regarding the different districts and tribes of Sierra Leone and its vicinity.

ON Monday evening last a paper on "The Alpine Regions of Alaska" was read by Lieut. H. Seton-Karr at a meeting of the Royal Geographical Society. In the course of a description of a visit to this territory last year, the reader expressed the opinion that the St. Elias Alpine region offers one of the best places for the study of glacial phenomena under the most powerful conditions. According to Dall, the American surveyor, Mount St. Elias is 19,500 feet high. It is a mass of snow and ice from base to summit, and has always been marked in modern maps as exactly on the 141st meridian, which is the boundary line. If the shore line was correctly charted, he found that the summit was east of the meridian of longitude mentioned. It was therefore in the British Empire. Describing the ascent of the mountain, he stated that he proceeded to a point which the aneroid instruments gave as 7200 feet above the sea level. There remained in the Alpine regions of the North Pacific a wide field for explorers. Mounts Crillon, Fairweather, and La Pérouse, respectively 15,900, 15,500, and 11,300 feet high, were not quite so striking as the one he described, but were much nearer to civilised settlements. There is a large blank space upon the map of Alaska, lying between Cook's Inlet and the great Yukon River. It is as unknown as any of the unexplored regions on the globe.

A JOURNEY of considerable interest is now being carried out in Central Asia by Mr. A. D. Carey, of the Bombay Civil Service. Mr. Carey left India in May 1885, and marched through Ladak into Northern Tibet (Chángtán) as far as the Mangsa Lake, and then struck northward, descending on the plain of Turkestan, near Kiria. He thus traversed over 300 miles of country which had never before been visited by a European. The altitudes on this section of the journey were always very great, the track running usually at about 16,000 feet above the sea, while one at least of the passes crossed was calculated to reach 19,000 feet. After a stay at Kiria and Khotan, the Khotan River was followed to its junction with the Tarim; the route then lay along the latter river to Sarik, and then across a stretch of desert to Sháh-Yarand Kuchár. From the latter place the Tarim was followed down to a point where it turns southward towards Lake Lob. From this point the towns of Kuria and Kárástaber were visited, and about the end of the year the Tarim was struck again and tracked down to Lake Lob. Thus the whole length of the Tarim has been explored. The country along its banks is described as flat and reedy, and the people extremely poor and miserable. Mr. Carey pitched his camp at the village of Cháklik, some distance south of the lake, and close to the foot of the great range of mountains which forms the northern scarp of the Tibetan highlands. On April 30, 1886, Mr. Carey started from this village on a journey southward into Tibet, over a pass in the Altyn Tagh Range, and onward by a track occasionally used by the Kalmucks. Since this start nothing has been heard of Mr. Carey, but it is presumed that after spending the summer and autumn in travelling over the elevated region he has returned to Turkestan to winter.

THE principal paper in the March number of *Petermann's Mittheilungen* is a special study of the basin of the Cachapool in the province of Santiago, Chili, by Dr. A. Plagemann. There is also a short paper on the hydrography of Batanga Land, by Herr P. Langhaus. From the notes we are glad to learn that the Roumanian Government has adopted a plan for the triangulation of that country, which will be the means of filling up an important gap in the cartography of Europe. *Ergänzungsheft* No. 85 of *Petermann's* contains a detailed account, with map and diagram, of Dr. Gustav Radde's journeys in the Alpine region of Daghestan in the summer of 1885.

PREHISTORIC REMAINS IN AMERICA

At a recent meeting of the Washington Anthropological Society, Mr. G. K. Gilbert described a prehistoric hearth under the Quaternary deposits in Western New York. The speaker described the finding of the remains of a wood fire in the bottom of a well through the drift deposits near Gaines, a few miles south of Lake Ontario. The evidence in the matter rests almost entirely on the statements of a Mr. Tomlinson, a well-known and respected resident of the place, and who, personally, made the find upon his own farm. It was twenty years ago that the discovery was made, but Mr. Tomlinson has stated that his memory of all the essential details was very clear, and the speaker had every personal reason for believing the statements. The story is briefly that in sinking a well through 17 feet of gravel and clay, they found lying upon the rock at its bottom three large stones, partly inclosing a small space in which were about a dozen charred sticks, undoubtedly the remains of a fire started by human hands. Mr. Tomlinson gave some of these remains to neighbours, who still remember the matter, and the remainder he kept himself. In time, however, they have been lost, and the endeavour to find them did not meet with success.

The speaker then discussed at length the character of the beds under which the remains were found, and their geologic age, illustrating his statements by a map, of which a small copy is here reproduced.

The line A B shows the approximate southern limit of the lake drainage, and C D the approximate south-eastern extension of the second glacier, which, it will be noted, extends across the

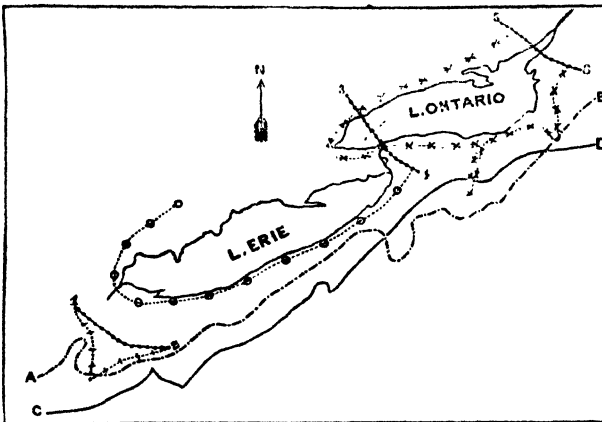

Map of the Ontario-Erie Lake Basins, showing their Quaternary history. The prehistoric hearth was found at x.

drainage line for a considerable distance. When the front of the glacier began to retreat, successive lake basins were formed, extending toward the drainage line and discharging at the lowest point in the divide. When the front of the glacier had retreated to the line 1-2, a lake extended over the area shown by the fine dotted line bearing small cross lines, and discharged toward the Ohio, near what is now the city of Fort Wayne. When the ice front had retreated to the line 3-4, the lake covered the area in part inclosed by the fine dotted line bearing the small circles. It was on the eastern shore of this lake that this ancient fire was built, and by its shore wash that it was so gently covered as not to be disturbed during the process.

By further retreat of the glacier toward 5-6, a lower outlet was exposed in the valley of the Mohawk, and the surface of the glacial lake again fell—the Lake Erie portion to the level of the escarpment of Niagara limestone which still dams it back, and the Lake Ontario portion to a somewhat lower level. Further retreat of the icy dam to 5-6, and beyond, opened the St. Lawrence channel, and the present drainage was established.

From this explanation the comparative age of the hearth and its remains is indicated. It was near the end of the second glacial period, and at the time of separation of Lake Ontario from Lake Erie. At about this time, also, the Niagara River began its work of cutting through the escarpment of Niagara limestone, and at which it has been engaged ever since. Its rate of progress having recently been approximately determined, we are able to estimate the number of years as about 7000 since the lakes were separated and the gorge and falls begun. This estimate

is based on comparisons of a recent survey by the U. S. Geological Survey with those made by the New York Survey forty years ago, and is open to some qualifications. In the first place, it is possible that some of the gorge was cut before the glacial period; then it has been found that the hardest stratum through which the river has to cut thins somewhat to the eastward, and thus offered less resistance to wear at an earlier date in the history of the gorge; and then, again, the possibility is presented of the volume of water having been vastly greater toward the close of the glacial period, and it is known that the erosive power of water increases very rapidly with increase of volume. These qualifications tend to reduce the time estimate; but on the other hand, evidence has been found that at one time the other lakes above Erie emptied by another means, and if this was so for any great length of time after the birth of the Niagara, it would tend to very greatly increase the time.

In the discussion following this paper, Mr. Murdock, of the Point Barrow Station, gave an account of the finding of a prehistoric relic under somewhat similar circumstances. Their station was near the extreme north-west corner of this continent, on a beach ridge a few yards from the Arctic Sea. This ridge was 9 or 10 yards in height, and extended along the coast for some distance. In making an excavation for an earth thermometer, they penetrated a 1-foot layer of turf which capped the ridge, and then frozen gravel and earth to a depth of 20 odd feet, where an Eskimo snow-goggle was found embedded in the frozen earth. The goggle was identical with those now in use, and consists of a piece of bone covering the eyes and bridging the nose, with small slits to admit a very limited amount of light and protect the eyes from snow-blindness. The specimen found had strings of braided sinew attached, but these were broken in removing them from the hard matrix. The speaker believed that the beds inclosing and covering this relic were the results of beach wash. The Eskimo of the region have a tradition that people used to live at the locality of the find, and a few remains of houses are found in the vicinity.

At the same meeting Mr. W. J. McGee read an informal paper on the finding of a spear-head in the Quaternary beds of Nevada.

The speaker described the geologic features of the Walker River cañon, in the lacustrine deposits in which the find was made. These deposits are those of the fossil Lake Lahontan, and were deposited in the old cañon during the Quaternary period. Since then the river has cut a new cañon through them, and they are now finely exposed. Beginning above, the beds consist of silt and loose materials for several feet, then comes a layer of calcareous tufa lying upon 20 to 30 feet of white marl, containing remains of extinct mammalia, and resting unconformably upon a somewhat similar series of beds of earlier date. It was in the white marl of the upper beds that the implement was found. The speaker described in detail the conditions under which the find was made. He was alone at the time, and far distant from camp or party; he had been carefully examining the face of the marl talus as he rode along, and was searching for occasional bone remains. At one point, 26 feet below the surface, he noticed a small projecting point which looked as if it was caused by a bone. Picking off some of the surface, he at once recognised the object to be a product of man's handicraft; and appreciating the importance of the find, and the necessity of a very thorough study of all the circumstances connected with it, framed some working hypotheses before removing the implement. At first it appeared probable that it was embedded in a superficial coating of the slime which is often washed over the surface of this loose marl. This was at once disproved by examination. Other possibilities were suggested, such as its having fallen into its position down a fissure or been shoved into the face of the cliff by man; but these were all found to be, if not impossible, extremely improbable, and the speaker had concluded that it was deposited with the marl. Extensive stratigraphic studies have been made of these lacustrine deposits by King, Russell, and Gilbert, and there can be no doubt but that these beds and the flint were deposited toward the close of the glacial period, and about at the same time as those covering the hearth described by Mr. Gilbert. The implement was a spear-head 3½ inches in length, finely made and well preserved.

In the discussion which followed this paper, several members called attention to the great value of the find from the fact that it was made by a well-trained observer, who appreciated the importance of his discovery before destroying the evidence, and then carefully studied every detail connected with it.

UNIVERSITY AND EDUCATIONAL INTELLIGENCE

AMBRIDGE.—Mr. S. H. Vines, M.A., D.Sc. Lond., F.R.S., Prof. J. H. Poynting, M.A., have been approved for the degree of Doctor in Science.

Unfortunately for research in pathology, the opposition to the candidature of the John Lucas Walker Studentship proved decisive, and it was accepted by a majority of nearly five to one Thursday.

Dr. Michael Foster, Sec.R.S., has been appointed the University representative on the Council of the Marine Biological Association till the next annual meeting of the Association.

The following Entrance Scholarships and Exhibitions in Natural Science will be open for competition in the coming year:—Downing College: Natural Science, June 1, 50*l.* per annum; Peterhouse: Mathematics, Chemistry, and Physics, 40*l.* per annum; date to be announced in June; non-Collegiate students: Physical Science, July, in connection with the Oxford and Cambridge Schools Examination Board, 50 guineas per annum for three years, tenable at Oxford or Cambridge, open to non-Collegiate students of not more than one term's residence, or to persons not yet in residence. Apply to the Rev. G. Howard, Cambridge.

SCIENTIFIC SERIALS

American Journal of Mathematics, vol. ix. No. 2, January. The number opens with a continuation of Mr. Greenhill's memoir on wave-motion in hydrodynamics, in which is discussed the motion in the following cases: § 21, across a channel the sides sloping at any angle; § 22, against a uniformly moving shore; § 24, in a cone; § 25, in a cylinder; and § 23 contains an algebraical solution of waves against a shore.—Prof. Vequer's lectures on the theory of reciprocants give notes of lectures xvii. to xxiv., with an extract from a letter of M. Lphen in which the existence of *invariants* in general is established *a priori*; this is given as introductory to the theory of differential invariants.—A memoir in the theory of numbers, by S. Hathaway, contains an historical introduction of interest. The second part considers fundamental principles and definitions, then a problem and the consequences of its solution, and then turns the question of ideal solution of the problem into the question of the establishment of a given theory of ideals; the constructions are left for the reader to supply. The third part is occupied with a rigorous establishment of the theory of ideals indicated in the second part.—The next paper, on a theorem respecting the singularities of curves of multiple curvature, by H. B. Fine, is a generalisation of a portion of a previous paper, (vol. viii. No. 2) by the same writer.—The number closes with two short notes—one on pencils of conics, by H. D. Thompson (let the eight points in which a conic intersects a cubic be divided into two groups of four, and a conic be described through each group: the two residual—four-point—curves lie on a conic; an exceptional case in Cayley's theorem, which had been overlooked by the author, is mentioned and references given to where it is discussed); the other consists of observations on the generating functions of the theory of invariants, by Capt. P. A. Macmahon.

Votes from the Leyden Museum, edited by Dr. F. A. Stejneger, vol. ix. No. 1, January 1887, contains, among other notices, the following:—J. Buttikofer, on a collection of birds from the highlands of Padang, in West Sumatra, by Dr. C. S. Lesli. This paper gives details of 189 birds in this collection, and is prefaced by a short history of the various published accounts of the birds of Sumatra from the first memoir by Sir Stamford Raffles in 1822. The only new species described is a fly (*Hirundinapus klaesii*).—Dr. R. Horst, descriptions of earthworms. Describes as new a gigantic earthworm from a rice-plantation in Sumatra, *Mormiligaster houtenii*; and also in the same country, *Rhinodrilus tentaculatus*, n.sp.—Dr. Th. van Lidth Jeude, on a collection of reptiles and fishes from West Indies. Describes three new lizards and a new fish seen during the Dutch Expedition to the West Indies.—There are also ten papers on new or little-known insects.

Rendiconti del R. Istituto Lombardo.—Results of the observations made by Dr. M. Rajna at the Brera Observatory on the annual oscillations of magnetic declination during the year 1886, communicated by E. G. V. Schiaparelli. These observations were taken as in previous years at 8 a.m. and 2 p.m.,

the diurnal variation being obtained by determining the difference in time between the two periods. The monthly averages thus determined and tabulated show for the whole year a mean of 6'72.

Bulletin de l'Académie Royale de Belgique, January.—On some curious effects of molecular forces in contact with a solid and a liquid, by G. Van der Mensbrugge. Some experiments are described tending to illustrate the expansive force possessed by the contact layer between a solid and a liquid, and the existence of which the author claims to have been the first to demonstrate.—On Fermat's last theorem, by P. Mansion. It is shown that, if there exist integers x, y, z , verifying Fermat's relation $x^n + y^n = z^n$, where $x < y < z$, then not only the middle term, y , as shown by de Jonquières, but also the largest, z , and the smallest, x , are compound numbers.

SOCIETIES AND ACADEMIES

LONDON

Royal Society, March 3.—“Preliminary Note on a Balanoglossus Larva from the Bahamas.” By W. F. R. Weldon.

A preliminary account was given of the degradation of a Balanoglossus larva, found during the latter half of last year in the deep waters round the Bahamas. Up to the period of the development of a pair of gill-slits, this larva resembled, except in its pelagic habit, the larva found in Carolina by Bateson. After this stage, degradation set in, resulting in the atrophy of the two posterior pairs of body cavities, and the reduction of that in the præoral lobe: the gills and notochord, together with the greater part of the nervous system, disappeared, and the trunk diminished in size. The result was a bell-shaped creature, with a large præoral lobe, on the sides of which was developed a curious arrangement of tentaculiferous grooves. The alimentary canal remained functional, but the creature gradually shrivelled up, and (probably) died.

“Studies of some New Micro-Organisms obtained from Air.” By G. C. Frankland and Dr. Percy F. Frankland.

In previous communications to the Royal Society by one of the authors,¹ details have been given of a number of experiments on the presence of micro-organisms in the atmosphere. In these investigations a solid culture medium was employed, which not only greatly facilitated their enumeration, but also presented them in an *isolated* condition. In this manner the authors have met with a number of different varieties of aerial micro-organisms, which have hitherto remained either unknown or undescribed. They have therefore undertaken the characterisation of a number of these organisms by growing them in various cultivating media and observing the different appearances which they subsequently exhibit, by studying them microscopically in stained and unstained preparations, and by cultivating them on gelatine-plates, and describing the colonies to which they give rise. They have likewise made a number of drawings to illustrate the appearances which they present under the various examinations to which they have submitted them. To further facilitate their identification the authors have provisionally given them names, by which they have endeavoured to represent some of their most striking individualities.

The authors venture to hope that by thus characterising some of the organisms most prevalent in the atmosphere, they may prove of assistance in those investigations which have for their object the study of the particular physiological changes which are brought about by specific micro-organisms.

The following is a list of the micro-organisms described:—

Micrococcus carnicolor	Bacillus plicatus
“ albus	“ chlorinus
“ gigas	“ polymorphus
“ chryseus	“ profusus
“ candicans	“ pestifer vermicularis
Streptococcus liquefaciens	“ subtilis minor
Sarcina liquefaciens	“ subtilis cereus
Bacillus aureus siccus	Saccharomyces rosaceus
“ aureus	“ liquefaciens
“ citreus	Mycelium fuscum.

¹ (1) “The Distribution of Micro-Organisms in Air,” Roy. Soc. Proc. vol. xl. p. 509; (2) “A New Method for the Quantitative Estimation of the Micro-Organisms present in the Atmosphere,” *ibid.* vol. xli. p. 443; (3) “Further Experiments on the Distribution of Micro-Organisms in Air by Hesse's method,” *ibid.* p. 446.

In addition to these varieties a description has been given for the sake of comparison of some aerial micro-organisms which were obtained by one of the authors from Dr. Koch's laboratory in Berlin. These are—

Micrococcus rosaceus	Bacillus subtilis
Sarcina lutea	„ (Micrococcus) prodigi-
„ aurantiaca	„ giosus.

Linnean Society, March 3.—Mr. W. Carruthers, F.R.S., President, in the chair.—The following gentlemen were elected Fellows of the Society:—B. S. Dyer, Right Hon. Sir E. Fry, S. T. Klein, C. Mariès, E. S. Marshall, R. Morgan, J. B. Stone, and A. W. Tait.—A paper was read by Mr. Alfred W. Bennett on the genetic affinities and classification of the Algæ. He referred to Prof. Sachs's scheme as based on the mode of reproduction and degree of complexity of the sexual process alone; this being the most important factor in the life-history of the plant. Supporting Sachs to a certain extent, he nevertheless differs from him, and rather agrees with Prof. Fischer's view of Algæ and Fungi running in distinct series, while he diverges from both writers as to the descent, relations, and grouping of the Algæ. He believes arrest of development has had an important influence in many presumed deviations among the groups in question. He avers that retrogression may take the form of the suppression of either the vegetative or the reproductive organs, and whichever predominates or progresses leaves the other feeble or degenerate. If the principle advocated by the author holds good, it leads towards the almost abandoned divisions of the Algæ into the green, the red, and the brown,—Chlorosporeæ, Rhodosporeæ, and Phæosporeæ. It would appear as if at an early period in the development of the simplest form of vegetative life, three kinds of cell-contents were represented, a colourless, a blue-green, and a pure green. Based thereon are the author's three great divisions:—I. *Schizomyces*, forms entirely destitute of chlorophyll, and adapted to carry on only a parasitic existence; II. *Chroococcaceæ*, unicellular organisms, with cell-contents composed of watery blue-green endochrome diffused through the protoplasm, without distinct chlorophyll grains, starch grains, or nucleus; III. *Protophytes*, characterised by cells possessing a nucleus, starch grains, pure chlorophyll identical with that of higher plants, and in certain states a true cell-wall of cellulose. The (I.) *Schizomyces* lead to the Fungi, which are not discussed by the author. The (II.) *Chroococcaceæ* pass through the *Oscillariaceæ* to *Nostocaceæ*. The (III.) *Protophytes* are the great derivatives of the Algal group. Hence three great lines of descent are indicated. (1) The Diatoms are regarded as of remote origin, very low in the scale. (2) The *Cœobia* comprise a series through *Sorastrea* to *Volvox* and *Allies*. (3) The *Fremobia* as a line of descent pass to the *Multinucleata*, e.g. *Siphonæ* with gigantic cells. Thence cell-division originating, proceeded to the *Confervoidæ-isogamæ*, the *Conferva* group. From these in three different lines have sprung: (a) the *Conjugatæ*, including *Zygnemids* and *Desmids*, a retrogressive group; (b) the brown seaweeds adapted to deep sea life, *Phæosporeæ*, terminating in *Fucaceæ*; and (c) the *Confervoidæ-heterogamæ*, at the extreme of which the *Coleochætæ* are reached. The *Coleochætæ* lead direct to the red seaweeds, or *Floridæ*, a natural group with great variety in development of the sexual organs. By arrest of development branches proceed on the one hand through *Nemaliæ* to the *Ulvaceæ*, while on the other at a tangent from true Algæ were evolved the *Characæ*, the *Mosses*, the *Gymnosperms*, and lastly the higher *Angiosperms*, or flowering plants.—A paper was read on the disease of *Colocasia* in Jamaica, by Mr. G. Massee and Mr. D. Morris. The negroes of the West Indies give the name "Cocoos" to the main stem and shoots of a species of *Aroid*. This forms a wholesome food, and is said to be preferable to yams and sweet potatoes. A blight arises in the tubers similar to the potato-disease; and as shown by the authors this is produced by a fungus belonging to the genus *Peronospora*, a new species named by them *P. trichotoma*. Instructions are given as to remedial measures, an important one being the absolute necessity of badly affected plants being wholly destroyed.

Physical Society, February 26.—Prof. W. G. Adams, Vice-President, in the chair.—The resolution passed at the meeting on February 12, providing greater facilities to persons being abroad for qualifying for membership of the Society, was unanimously confirmed.—Prof. W. Stroud and Mr. A. S. Gulbenkian were elected Members of the Society.—Mr. James Swinburne read a note on Prof. Carey Foster's method of measuring the

mutual induction of two coils. The author described an apparatus devised last summer for measuring mutual induction by a null method, thus dispensing with a ballistic galvanometer. The induction in the secondary coil is balanced by an opposite effect produced by a variable known fraction of the primary current passing through one wire of a double-wound coil of known mutual induction, the other wire of which is joined in series with the secondary coil and galvanometer. In a preliminary trial, using an ordinary reflecting galvanometer, it was found that instead of no deflection being observed, two kicks in opposite directions occurred when there was iron in the circuit. A new galvanometer, with heavy needle, is now being constructed to overcome this difficulty. A null method of finding the ohm by means of a differentially-wound, heavy-needle galvanometer is suggested in the latter part of the note. Prof. Ayrton pointed out that Prof. Foster's method does not require readings on a ballistic galvanometer, and mentioned that in practice it is greatly superior to the one given in Maxwell and the ordinary textbooks. The chief drawback is the necessity of having large condensers of accurately known capacity where large coefficients are concerned. A large number of experiments have been carried out at the Central Institution by Mr. Sumpner with very satisfactory results. Prof. Adams concurred in Prof. Ayrton's statement regarding the difficulties in using Maxwell's methods in practice, and expressed his satisfaction with the great simplicity of Prof. Foster's method.—On the determination of coefficients of mutual induction by means of the ballistic galvanometer and earth inductor, by R. H. M. Bosanquet. The methods described depend on two measurements of the throws of a ballistic galvanometer: (1) that produced by the sudden rotation of a coil (the constants of which are accurately known) through 180° about a vertical axis; and (2) that produced by the mutual induction to be measured when a current of known strength is started in the primary circuit. The earth induction-coil is permanently joined in series with the ballistic galvanometer and secondary coil, and the primary current measured by an absolute tangent galvanometer of the Helmholtz pattern. If Q_0 and Q be the quantities of electricity which pass through the ballistic galvanometer in the two experiments, then

$$Q_0 = \frac{2NAH}{R},$$

where NA is the effective area of the inductor, and

$$Q = \frac{MC}{R},$$

where $C = GH \tan \theta$.

Hence

$$\frac{Q}{Q_0} = \frac{MG \tan \theta}{2NA} = \frac{\alpha}{\beta},$$

where α and β are the throws of the ballistic galvanometer. From the above we get

$$M = \frac{\alpha}{\beta} \cdot \frac{2NA}{G \tan \theta}.$$

A modification to be used when M or R are very large is also described. Numerical results obtained are given, from which it is inferred that Maxwell's formulæ for calculating the mutual induction of two circular coils cannot be applied where the distance between their central planes is at all comparable with their radii. Experiments on an A Gramme dynamo gave very irregular results when the currents were small, owing to the sub-permanent magnetism of the machine. Further uses of the method are suggested, such as the absolute determination of capacity and resistance. Remarks on the subject were made by Prof. Carey Foster and Mr. Swinburne, and Prof. Ayrton replied to Mr. Swinburne's contention that Prof. Foster's method was not independent of observations of a ballistic galvanometer (since capacities are determined by their means) by pointing out that where accurate standards exist it is quite legitimate to base other absolute measurements on them.—Prof. Reinold then read an abstract of a paper on the continuous transition from the liquid to the gaseous state of matter at all temperatures, by Prof. W. Ramsay and Dr. Sydney Young. The authors find the relation between pressure and temperature of gases and liquids at constant volume expressible by $p = bt - a$ where b and a are constants, and therefore conclude that the *isochors* (i.e. curves connecting p and t for constant volume) are straight lines. At temperatures below the critical point, the isotherm, during passage from the gaseous to the liquid state, is a serpentine curve inter-

ed by the horizontal line of vapour-pressure corresponding to that temperature, the two areas between the curve and light line being equal. By experiment and extrapolation the authors find the loci of the apices of the serpentine curves corresponding with different temperatures, to intersect at the critical point. The above results are proved for ether and carbon dioxide, and the authors believe them to be true for all stable substances. F. Rücker remarked that if similar relations hold for liquids and solids, the triple point of intersection would be of immense importance. Prof. Perry, whilst regarding the results as of vast importance, thought the curves and calculations should be very fully discussed before being finally accepted.

EDINBURGH

Royal Society, February 21.—Rev. Prof. Flint, Vice-president, in the chair.—In a paper on the effect of pressure on the maximum density point of water, Prof. Tait replied to criticisms made upon his results by Grimaldi.—Dr. J. Murray gave a re-determination of the mean height of the land of the British Isles above sea-level. He obtains a value higher than that obtained by previous observers.—Prof. Tait read a note on the effects of explosives. He pointed out that within a certain distance from the centre of explosion the speed of ejected matter (&c.,) is greater than that of sound. Hence within this distance there is great danger of damage to objects from pulsive pressure.—Dr. Traquair read a supplementary report on fossil Ganoidei collected in Eskdale and Tiddesdale.—Sir W. Thomson submitted a paper in continuation of his paper read at the last meeting on the equilibrium of a gas under its own gravitation alone.

PARIS

Academy of Sciences, March 7.—M. Janssen in the chair. Determination of the constant of aberration: first and second corrections (concluded), by M. Loewy. The relations being known between the ecliptical and equatorial coordinates, the aberration is here determined by means of which for a couple of stars without aberration the epoch may be calculated, when both at the same altitude above the horizon.—On a theorem of Liapounoff respecting the equilibrium of a fluid mass, by H. Poincaré. By considerations borrowed from electrostatics, a simplification is here offered of the demonstration recently published by M. Liapounoff in the *Mémoires* of the University of Kharkoff.—On the direct fixation of the gaseous nitrogen of the atmosphere by vegetable soils with the aid of rotation, by M. Berthelot. Having already described the results of the experiments made at Meudon on the fixation of atmospheric nitrogen by certain argillaceous and vegetable soils, apart from the action of vegetation, the author here gives the results of the experiments simultaneously carried on with the aid of rotation, and under the ordinary conditions suitable for the natural development of plants. In this case the amount of nitrogen fixed was only 4.67 and 7.58 grms., as compared with 12.7 and 15 in the absence of plants. From these experiments important conclusions are drawn with regard to the rapid exhaustion of the soil under the prevalent systems of forced culture.—On the great movements of the atmosphere, and on M. Mascart's second note of February 28, by M. Faye. The author replies to the objections urged against, and repeats the arguments recently advanced by him in support of, the theory he has formulated on this subject based on fifteen years' observations of atmospheric phenomena.—On the magnetic effects of the recent earthquakes, by M. Mascart. A more careful study of the curves recorded at the Observatory of Nantes shows that the magnetic effects observed at Paris, Lyons, and Perpignan, were also felt in the west of France, although here the oscillations were much smaller.—On the determination of the poles in magnets, by M. Mascart. For the method here described it is claimed that it involves no hypothesis on the magnetic state of the bars, and is free from the objections urged against the other methods now in use.—On the nutritive properties of latex, and on the aqueous apparatus of *Calophyllum* as described by M. Vesque, by A. Trécul.—On the frequency and duration of showers, by Hervé Mangon. The results are here tabulated of the pluviometric observations taken at Paris during the years 1860–70 with the pluvioscope invented by the author. The rainfall here recorded is higher than that indicated by other instruments, which mostly neglect slight showers under 0.10 or 0.15 mm., which nevertheless represent from 1000 to 1500 kgrms. of water

periments, &c.), by M. D. Colladon.—Report on M. Léon Roche's note respecting a new metronome, based on the isochronism of the slight oscillations of the pendulum, by M. Fizeau. The Commission appointed to examine this instrument reports favourably on the principle of its construction as at once simple and practical, and considers that it is likely to be of service to the art of music.—Report on MM. Bérard and Léauté's memoir on the means of diminishing momentary increase of velocity in machinery furnished with governors acting indirectly, by the Commissioners, MM. Lévy, Marcel Deprez, Sarrau, and Phillips. The report considers that MM. Bérard and Léauté have arrived at a simple and complete solution of the problem, how best to control the irregular action of machinery, and that, while specially useful for the manufacture of gunpowder, their apparatus will be found generally applicable to all mechanical work.—Note on the earthquake of February 23 in Italy, by M. F. Denza. General conclusions are given regarding the character, extent, duration, intensity, &c., of this disturbance, derived from reports received from all quarters at the Observatory of Moncalieri.—Propagation of the earthquake in one of the mines at Anzin (Nord), by M. François. The *tromomètre* (seismometer) set up in this mine at a depth of 250 metres two months ago recorded, for the first time, extraordinary vibrations between 6.15 and 6.30 a.m. on February 23.—Reports on the same phenomenon, by MM. A. Issel (Porto Maurizio), M. E. de Rossi (Rome), and Perrotin (Nice).—Observations on M. Donnadieu's recent note on the winter incubations of *Phylloxera*, by M. Balbiani. In reply to M. Donnadieu, the author maintains his views regarding the hibernation of this parasite.—Observations of Barnard's Comet II. and of Palisa's new planet made at the Observatory of Algiers with the 0.50 m. telescope, by MM. Trépied and Rambaud.—Distribution in latitude of the solar phenomena during the year 1886, by M. P. Tacchini. From the tabulated results of the year's observations it appears that the eruptions, spots, and faculae, were more numerous in the southern, and the protuberances in the northern, solar hemisphere. The latter occurred in all zones, whereas the other phenomena were almost entirely confined to the region between the equator and $\pm 40^\circ$.—On the rectifications of Maclaurin's trisector curve by means of the elliptical integrals, by M. G. de Longchamps.—On the laws of solution, by M. H. Le Chatelier. This is a reply to MM. Chancel and Parmentier's recent communication to the effect that the author's law of solution is not general, and in certain cases is opposed to observed facts.—On some formulæ relating to saline solutions, by M. Duhem.—On a particular case of solution, by M. F. Parmentier.—On an acid obtained by the action of potassa on a mixture of acetone and chloroform, by M. R. Engel. The compound substance here described has been obtained by M. Willgerodt by treating acetone with chloroform and a small quantity of solid potassa. Its formula is $C_4H_7OCl_3$, and it takes the name of acetone-chloroform.—Synthetical researches on some derivatives of diphenyl, by M. P. Adam.—Note on active camphene and ethyl-borneol, by MM. G. Bouchardat and J. Lafont.—Action of the dibromide of ethylene on the alkaline alcoholates: preparation of acetyl-ene, by M. de Forcrand.—On the spores of *Bacillus anthracis*, by M. S. Arloing. It is shown that these spores are really killed by the light of the sun.—A new method of attenuating the virus of ovine pox, by M. P. Pourquier. The experiments here described yield an unlimited supply of an attenuated virus or vaccine, with which sheep may be safely and efficiently inoculated.—Researches on the structure and development of the cysts in *Echinorhynchus angustatus* and *E. proteus*, by M. R. Kœhler.—On the food of the sardine, by MM. G. Pouchet and J. de Guerne. It is shown that the food of the sardine varies according to circumstances, and does not depend, as recently asserted, on the animal refuse drifting from the Newfoundland fisheries.—New researches on the mode of formation of double monsters, by M. Camille Dareste.—On the variations of structure in the carboniferous porphyries of Renfrewshire, by M. A. Lacroix.—On the minerals associated with the basalt of Prudelles, near Clermont-Ferrand, by M. Ferdinand Gonnard. The prevailing mineral disseminated among these as among most of the Puy-de-Dôme basalts is a christianite apparently confused by the old mineralogists with mesotype, or vaguely described under the name of zeolite.—Researches on the contraction of the terrestrial radius since the formation of the solid crust, by M. A. de Lapparent. Several arguments are adduced against the general theory that the radius of the globe has diminished by one-half since the gneiss

THURSDAY, MARCH 24, 1887

THE NECESSITY FOR A MINISTER OF
EDUCATION

IF we are justified in judging of the progress of right ideas on the importance to the nation of science and scientific instruction by the outcomes of one week, then certainly we may congratulate ourselves upon the fact that at last the views which we have for the last eighteen years, in season and out of season, been putting forward are beginning to attract public attention.

There can be no doubt that the general interest is now thoroughly aroused on this matter. In spite of the absolute block of anything like a debate upon education in Parliament, scientific and political leaders say their say elsewhere, and the manner in which these utterances are referred to and enlarged upon in the leading journals is a sure indication that the public interest is known to be growing, and that it is now generally acknowledged that our welfare as a nation depends upon a proper consideration of educational questions.

The first utterance we have to refer to is the admirable speech delivered by Lord Hartington on the night our last number went to press. Lord Hartington had consented to give away the prizes and make an address at the Polytechnic Young Men's Christian Institute, an organisation which now numbers nearly 7000 students, for the existence and endowment of which England is indebted to the munificence and clear-sightedness of one individual, Mr. Quintin Hogg.

It was not to be wondered at that Lord Hartington, with such an unaccustomed task before him, should have referred, in the course of his speech, to Prof. Huxley's recent address, in which the fact was emphasised that if peace has her victories, there must be some who are vanquished; that there is a death to the conquered in peace as in war, the victims of peace being starved as a result of continual depression of trade.

The interest of Lord Hartington's speech was that the question which Prof. Huxley had approached from the Darwinian point of view—the survival of the fittest, the destruction of the unfittest—was to him a question of possible contemporary politics which he had to consider, and the consideration he gave to it led him to emphasise Prof. Huxley's view of the situation. It is clear moreover that the opinion given was not one hastily formed, for the former paramount position of this country when she had a monopoly of iron, and coal, and other material resources, and when there was no science to speak of anywhere, either here or abroad, had been fully taken into consideration. We quote from the speech:—

"No doubt we should still have our material resources, our iron and steel, and the muscular energy of what would then be our superabundant population; but instead of being what we are now, we should be hewers of wood and drawers of water for the world. If ever our raw materials could be manufactured for the uses and wants of the world better in other countries than in our own, we should become the slaves and servants of the rest of the world, instead of its leaders and masters, as we have been hitherto."

VOL. XXXV.—NO. 908

Now, if a politician of Lord Hartington's eminence tells us that this may happen as a result of our being beaten in a campaign of peace, it is proper to consider whether we could be very much worse off in the event of a disastrous war. Certainly, to fend off this result by war, we, as a nation, would not hesitate to double the national debt.

Lord Hartington next went on to show that war also now depends upon science.

"There are some who go so far as to deprecate any large expenditure whatever, even when necessary for the efficiency of our services. These people point to the success which we have attained in former times when almost alone we have contended successfully against a whole continent; they point to the undiminished strength and courage of our soldiers and sailors, to the vast resources—industrial, manufacturing, and financial—of the country; and they tell us that if we only husband these resources they will pull us through in future emergencies as they have done in the past. But I would say that all these arguments are utterly vain and futile unless we can prove that the conditions under which we should have to fight are entirely similar to those under which we have fought in the past. If, on the other hand, it can be proved that wars are no longer decided by personal courage or endurance, but by the possession of scientific knowledge and all the most approved and perfected appliances, then we cannot afford to disregard the teaching and the experience of the rest of the world, and cannot afford to allow ourselves to be behindhand in the possession of the scientific knowledge and appliances that are demanded."

Lord Hartington then insists upon the importance of science both in peace and war.

"If undoubted success can only be gained by the possession of scientific knowledge and the application of the most scientific instruction to the masses of our people, then it follows that we shall fall behind in this industrial competition and warfare if we do not possess ourselves of these necessities."

He holds that the army of peace must be aided by the State as well as the other. We no longer think of keeping out an invasion by train-bands, and volunteers, and our merchant fleet. For peace purposes also, then, local effort alone will not do all that is necessary. We have found this out already, and we have the Science and Art Department as well as the Admiralty and War Office. Lord Hartington holds that the Science and Art Department must be strengthened so far as technical instruction is concerned.

We see, then, that at last we have one political leader who views science and scientific instruction in the true light, and has the courage of his opinion. Science is to be aided on precisely the same grounds that we aid the army and the navy. It is no longer a question of merely paying for Sweetness and Light, or of giving a poor dog a bone.

It was not to be expected that Prof. Huxley, who has so unceasingly done all in the power of a single individual to place the right views on this matter before the public, would rest content with the note of warning to which Lord Hartington, as we have seen, has so forcibly drawn attention.

Under the title of "The Organisation of Industrial

Education" a letter appeared in the *Times* of the 21st inst., which we print *in extenso* elsewhere. The main purpose of this second outcome is to show that at the present moment what is chiefly lacking in the army of peace is organisation and a proper headquarter staff—an Educational Commander-in-Chief. Reading between the lines of the letter, it is easy to see that one of the things "organisation" is expected to do, nay, must do, is to prevent so-called "economy" from thwarting every attempt at progress. "Economy does not lie in sparing money, but in spending it wisely," is a maxim that must be commended not only to the Treasury, but to local bodies.

It is probably the feeling that the proposals of a strong Minister of Education, with a full knowledge of his subject and in touch with all the most eminent educationalists of his time, would be sure to commend themselves to Parliament, and that the annual charge would be increased, which has induced successive Ministries to postpone the creation of such an office. It is now thirteen years since both the Duke of Devonshire's Commission and Parliament itself discussed the question; the latter on the motion of Mr. (now Sir Lyon) Playfair. Three years ago the Report of the Select Committee presided over by Mr. Childers unanimously recommended that a Minister of Education should be appointed. With the growing feeling on the part of the public on this matter, if an opportunity presents itself of again bringing forward this proposal it will not be allowed to be dropped.

It is clear from Prof. Huxley's letter that the present machinery is not adequate: it can only be strengthened and consolidated by the appointment of a Minister. One enormous advantage of such a Minister would be that we should have an acknowledged Department to apply to, absolutely in sympathy with those who wish to bring about any improvement in our educational machinery. Quite recently we have had two deputations on purely educational matters: one, for an endowment to the Victoria University, to the Chancellor of the Exchequer, and the other, for further aid to technical education, to the Lord President. It is very difficult for a plain man to understand why the Chancellor of the Exchequer should have been chosen in one case and the Lord President in the other: of course there is an official reason, but it only adds point to the grotesqueness of the present arrangements.

We have, however, to refer to these deputations from another point of view. The prayer of the Victoria University has been granted: that the needed assistance in the other matter—technical instruction—will be granted at once is by no means certain. However this may be, well-wishers of science must thank Mr. Mundella for his vigorous pleading of the cause they have at heart.

The object of the last deputation, as Mr. Mundella pointed out, was to ask the Government to take a very modest step in the direction of the organisation of industrial and commercial education. The education of the 4,600,000 on the books of the elementary schools is confined to education of a purely elementary character, and anything in the shape of manual or industrial education is treated in a way very disheartening to those interested in the question. At present our industrial classes are like badly drilled soldiers fighting a battle with antiquated weapons—

it is like sending our soldiers into the field, armed with Brown Bess, to meet the best armed soldiers of Europe. Dr. Konrad, in a report on the Prussian system in its bearing on the national economy, said the superiority of the Western to the Eastern workman, and of the German to the Englishman, was well established; and he added that no doubt the Englishman by his enormous perseverance and his wonted diligence got through considerably more work in the sphere to which he had been long accustomed, but he was far behind the German in capacity for adapting himself to new circumstances. This was the result of the better and more general training which the Germans got in their schools. Mr. Mundella acknowledged that there had been repeated attempts to do something in England to improve the condition of things, but where public bodies had interfered they had acted beyond their powers and been punished accordingly. It was freedom from the restrictions under which these authorities laboured that the deputation sought. They asked also for increased powers to promote industrial, scientific, and technical training, and that for this purpose they should be put in connexion with the Science and Art Department. The cost of executing what they proposed would be trifling.

Sir Lyon Playfair contended that a short Act of three clauses would do all that is wanted. We hope soon to see it. Sir B. Samuelson, as Chairman of the Associated Chambers of Commerce, presented a memorial from that body, and Mr. Howell hit the nail on the head by stating that for "unemployed," in connexion with our industrial population, now so often used, the word "unskilled" should be substituted.

We are bound to say that Lord Cranbrook's answer was sympathetic, but he is clearly of opinion that the Government can do nothing because "Parliament has not really pronounced on the subject of technical instruction"!

ROSENBUSCH'S "PETROGRAPHY"

Mikroskopische Physiographic der massigen Gesteine
Von H. Rosenbusch. I. Abtheilung. Zweite gänzlich umgearbeitete Auflage. (Stuttgart, 1886.)

THE first part of the second edition of this important work has at length appeared, the author having wisely decided not to keep back this instalment until the whole has been completed. Petrography advances now apace with such gigantic strides, and so quickly are new facts accumulated and new theories elaborated, that as soon as the last chapters of a treatise on this science have been written it is almost time to begin re-writing the first.

This book has been looked forward to by petrographers with a certain amount of pardonable impatience, in the hope that it would do something towards clearing away the mists that envelop rock-classification and nomenclature. Since the introduction of the polarising microscope into petrographical research, old familiar names—like greenstone, trap, felstone, trachyte, &c.—have either been discarded or materially modified in their use; and we now talk with Gumbel of lamprophyre, proterobasalt, picrophyre, palæophyre, palæopicrite, leucophyre, and the like; or we use names manufactured from the local

ties where the rocks are found, such as tonalite, ortlerite, or palatinite; or, lastly, following in the wake of the organic chemists, we construct complex names by stringing together those of the component minerals, as, for example, quartz-augite-diorite or hornblende-augite-mica-andesite. The result is that either different petrographers call the same rock by different names, or use the same name to designate different rocks. At the same time, so many views have arisen as to the fundamental elements of petrographical classification, that there are almost as many systems of classification as there are petrographers.

Up to the present time Continental geologists have been in the habit of making geological age a primary factor in classification. Now, although this may apply to Germany, it certainly will not hold for other countries. In England and America it has been shown conclusively that rocks identical in structure and composition have been formed in pre-Tertiary and Tertiary times.

The new edition of Rosenbusch's work would, it was hoped, bring order into this chaos, and give us a classification and nomenclature which, without being too rigid, would allow of referring any particular rock to its family. Such a classification, agreeing with all the known facts, would doubtless readily be accepted by all geologists in this country, were it only for the sake of uniformity and unanimity.

A brief review, or epitome, of Prof. Rosenbusch's book may not be unwelcome here. Any criticism had best be reserved until the work is completed. We owe, indeed, such a debt of gratitude to the author for collecting, collating, and arranging the vast quantity of facts which have been accumulating within the last few years, that it would be almost presumptuous to attempt to find fault with a work so excellent, so invaluable in every way.

In the introduction Prof. Rosenbusch gives us his views on classification. These differ very materially from those expressed in the former edition. "A natural system of classification must," he writes, "in the first place lay stress on the geological mode of occurrence (*geologische Erscheinungsform*), as determining structure and the mineral components. In the second place comes chemical composition, and, lastly, geological age." Secondary alteration in structure or mineralogical composition can have no classificatory value.

It is the geological mode of occurrence that almost exclusively determines the structure of an eruptive rock. Eruptive masses of the same chemical and mineralogical composition possess a totally different structure, according as they were poured out at the earth's surface in the form of lava, or consolidated in the deeper regions of the earth's solid crust. This may, of course, also be expressed by saying that the structure of a rock depends, *ceteris paribus*, only on the differences of temperature and pressure to which it has been subjected during its formation.

Classified, then, according to their mode of occurrence, eruptive rocks may be divided into two great groups: (1) the *Plutonic* rocks (*Tiefengesteine*); and (2) the *Volcanic* or *effusive* rocks (*Ergussgesteine*). Occupying an intermediate position between these two chief groups is a third—that of the rocks occurring in the form of dykes (*Ganggesteine*). Both plutonic and volcanic rocks

are often found as dykes; but this group comprises those rocks which are found occurring alone in this form, and which possess certain structural peculiarities entitling them to be considered apart from the plutonic and effusive rocks. With regard to the latter it may be remarked that it is in this group that Prof. Rosenbusch does not feel justified in dropping altogether geological age as a classificatory factor. Accordingly these rocks are subdivided by him into *paleovolcanic* and *neovolcanic*: the former embracing those erupted in pre-Tertiary times, the latter those of Tertiary age.

In the introductory chapter to the plutonic rocks Prof. Rosenbusch treats of the structure and order of crystallisation of the mineral components of these rocks. In this chapter he embodies the substance of his paper on the granular and porphyritic structure of massive rocks, published some time since in the *Neues Jahrbuch*. In that paper he showed how in an eruptive silicate-magma the minerals separate in the order of decreasing basicity, so that at any given moment the uncrystallised magma is more acid than the sum of the separated compounds. Further, that the relative masses of the compounds present in such a magma act only in so far as the order of their separation, that generally those present in less quantity crystallise out first. To facilitate petrographical expression, Prof. Rosenbusch has proposed a couple of words which appear to be worthy of general acceptance. He calls those mineral components which occur in individuals, bounded on all sides by crystallised faces, *idiomorphic*: *allotriomorphic*, those which owe their boundaries to causes other than an internal arrangement of the molecules composing them. Applying this to the plutonic rocks, he points out that, whereas certain rocks, occurring as dykes, possess a "pan-idiomorphic granular" structure, the plutonic rocks are characterised by a granular structure essentially "hyp-idiomorphic" (a part of the minerals only possessing their own crystallographic form).

The group of the Plutonic rocks is subdivided by Prof. Rosenbusch as follows:—

- (a) Family of the granitic rocks.
- (b) Family of the syenitic rocks.
- (c) Family of the *elæolite* syenites.
- (d) Family of the diorites.
- (e) Family of the gabbros and norites.
- (f) Family of the diabases.
- (g) Family of the *theralites*.
- (h) Family of the peridotites.

Among these we notice a new name—the *theralites*. Under this head are included the plagioclase-nepheline rocks, formerly represented by the *teschenites*. The latter have been shown by Rohrbach (*Tschermak's Min und Pet. Mitt.*, 1885, ii. 1-63) to contain no nepheline, and have consequently been referred by him partly to the diorites, partly to the diabases. Still, plutonic rocks representing this mineralogical combination appear to exist (*e.g.* in the Crazy Mountains in Montana, U.S.); and thus the gap left by the removal of the *teschenites* is filled up. Prof. Rosenbusch derives the name *theralite* from *θηρᾶν* (to seek eagerly).

The group that embraces the rocks occurring in the form of dykes, is subdivided, according to mineralogical

and chemical composition, into a *granitic*, a *syenitic*, and a *dioritic* series.

Looking at the rocks, however, from the point of view of habit and structure, three types, independent of mineralogical composition, may be established, namely: a "*granitic*," only known to occur among the more acid representatives; a "*granito-porphyrific*," which is represented in each of the above series; and a "*lamprophyric*," which appears to be unrepresented in the more acid subdivisions. The following classification is accordingly proposed for the "dyke-rocks":—

- (a) Granitic dyke-rocks (aplite, tourmaline-granite, &c.).
- (b) Granito-porphyrific dyke-rocks (granite-porphyr, syenite-porphyr, æolite-porphyr, diorite-porphyr).
- (c) Lamprophyric dyke-rocks.

This last family may perhaps be best designated as a refuge for certain classes of rocks, such as the kersantites and kersantons, the minettes, and the lamprophyres, which have been long wandering about in the various systems of classification without finding any fixed abode. It is further subdivided into the syenitic lamprophyres (minettes and vogesites) and the dioritic lamprophyres (kersantite and camptonite).

Passing on to the group of the true Volcanic rocks, we note an important distinction between them and those of the Plutonic group, contained in a general law laid down by the author in this chapter. A volcanic (effusive) rock is always more acid and specifically lighter than its plutonic equivalent. To explain this the author suggests that an eruptive magma, during its slow ascent along cracks in the earth's crust, differentiates according to specific gravity, the heavier part, which ultimately gives rise to the plutonic rocks that consolidate within the earth's crust, being more basic, poorer in alkalies, and richer in alkaline earths and iron, than the specifically lighter part which reaches the earth's surface.

The author then proceeds to discuss the recurrence of phase in the crystallisation of the effusive rocks, and defines porphyritic structure as that structure which is produced by the recurrence of the same or similar minerals at two distinct periods of crystallisation. It is this structure which is the most essential characteristic of the effusive rocks. It may, however, be developed in very different ways. When the ground-mass is holocrystalline, the structure is "*holocrystalline-porphyrific*"; it is "*vitro-porphyrific*" when the ground-mass is glassy, and "*hypocrystalline-porphyrific*" when the ground-mass consists partly of vitreous, partly of crystalline elements.

Of the Volcanic group only the palæovolcanic series is discussed in the present volume. It is subdivided as follows:—

- (a) Family of the quartz porphyries (palæovolcanic equivalents of the granites).
- (b) Family of the quartzless porphyries (equivalents of the syenites).
- (c) Family of the porphyrites (equivalents of the diorites).
- (d) Family of the augite-porphyrates and melaphyres equivalents of the gabbros and diabases).
- (e) Family of the picrite-porphyrates (equivalents of the peridotites).

The neovolcanic rocks (rhyolites, trachytes, andesites, basalts, phonolites, tephrites, &c.) are reserved for the

Second Part, which is promised for Easter of this year, and will contain the plates to the whole volume. Thus completed, the work will form a most valuable addition to petrographical literature. One of its important features is the full collation of literature under each head. Students of petrographical science will thank Prof. Rosenbusch for the inestimable boon he has conferred upon them in indexing almost all the papers dealing with petrographical subjects which had appeared up to the date of publication of his book.

FREDERICK H. HATCH

LOCH CRERAN

Loch Creran: Notes from the Western Highlands. By W. Anderson Smith. (Paisley and London: Alexander Gardner, 1887.)

THE amateur naturalist who has leisure, a genuine interest in his subject, and abundant opportunities of exercising his observation, ought to be an exceptionally happy person; but he is not always well-advised in rushing into print with the result of his fugitive studies. That, however, is one of the foibles of the hour. The public are supposed to welcome somewhat bald catalogues of the common objects of the way-side, the heath, and the sea-shore; the newspaper reporter is glad to be temporarily withdrawn from the Divorce Court and sent to describe the chestnut-trees in Bushey Park; and young ladies, who have got the length of distinguishing between *Ranunculus Ficaria* and *R. acris* narrate in the evening papers the story of their exploration of the hedgerows. The result is harmless enough. It is not science; it is not literature; but it serves to teach a few people here and there to keep their eyes open; and that is something. And perhaps a world groaning under a load of books need not mind an additional volume or two— which it is not compelled to read.

Mr. W. Anderson Smith does not inform us whether these "*Notes from the Western Highlands*" have been, like some other of his writings, reprinted from a provincial journal; but if they are so, he has done himself injustice in not stating the fact; for carelessness that is comparatively venial in the columns of a newspaper becomes vexatious in a book. And truth compels us to say that Mr. Smith's style is slovenly in the extreme. Mis-spellings abound; the few scraps of French or Latin quoted are almost invariably mangled; there is an occasional lapse of grammar; and now and again the heedless composition provokes a smile, as when he says, "Into the luxurious beds we sink up to the knees, many of them at present with dainty seed-vessels ripe and full." And yet there is a chatty simplicity here and there in the book that is not without attraction. The ways and humours of certain domestic pets are described in a kindly fashion which recommends itself; and there are incidental glimpses of winter life and winter occupations in the West Highlands that are sufficiently pleasant. As for the bulk of the volume, that is devoted to marine zoology; and marine zoology, to be made interesting, not to say intelligible, to the general reader, should be accompanied by illustrations; while, on the other hand, the trained scientific student is not likely to concern himself much with the unmethodical investigations here noted down.

But in merely making incidental memoranda of the every-day experiences of life in his northern home, Mr. Smith has mentioned not a few interesting things; and for these one soon begins to be grateful in reading a volume that is otherwise none too lively. He tells us, for example, how a heron was suspected of stealing ducklings, was watched, and finally caught in the act of devouring one of the birds—which seems a singular occurrence. On the other hand, the appearance of a bat in January, when the West Highlands happen to be visited by a spell of mild weather, is by no means the rare phenomenon he supposes it to be. There are some interesting remarks on the incubation of the cuckoo's egg (pp. 13 and 16) which seem to suggest a need for further inquiry. But we cannot say that we place implicit faith in Mr. Anderson Smith as an observer. His story of how, on one occasion, in passing through a wood, he startled a number of fallow-deer and roebuck may be forgiven on account of the darkness prevailing at the time: we should prefer to wait for some daylight notes before believing that the fallow-deer and the roe have agreed to lay aside their long-standing and mutual antipathy. "The pheasant is an unwieldy bird and of no great power of flight." Did the writer of that sentence ever try to "stop" a rocketer well on the wing and coming down wind; and what was the expression of his face when he wheeled round to find the "unwieldy" bird already disappearing into the next parish? Mr. Smith in this volume revives a controversy in which, as it appears, he has been engaged before, with regard to the lower animals committing suicide; and remarks that it may be assumed they know what death is from the fact that many of them can simulate it with marvellous accuracy. It is no doubt true that the young of certain animals, when confronted with danger, will suddenly become motionless, and remain so until the danger is removed—just as it is a common trick among street arabs for a small boy, when pursued by a bigger boy, to throw himself down in the roadway and lie perfectly still, prepared for the worst. But to assume that the young curlew or the young rat that suddenly stiffens itself and shuts its eyes is aware that it is simulating death, or has any understanding of such a state, is a far jump. Mr. Smith cites the case of a terrier belonging to a friend of his which, having the distemper, deliberately went off and drowned itself. Clearly the verdict here must be temporary insanity; the dog did not know what it was doing. The chief reason for concluding that the lower animals are not aware that they possess the liberty of suicide is that so few of them (or none of them) take advantage of it; if they did know, the overworked cart-horse, the mangy cur, the long-enduring donkey, would forthwith knock their heads against the nearest wall—unless, indeed, it is to be supposed that these animals are so highly intelligent as to have heard of the significant French proverb: "Quand on est mort, c'est pour longtemps." But this question of suicide among animals has always been a stumbling-block. Prof. Edward Forbes accused a whole tribe of star-fish of having a suicidal instinct on no better grounds than that they, on being brought into the air, or put in fresh water, went to bits. He even describes one of them as rejoicing in its power of eluding scientific scrutiny:—"I saw its limbs escaping through every mesh of the dredge.

In my despair I seized the largest piece, and brought up the extremity of an arm with its terminal eye, the spinous eyelid of which opened and closed with something exceedingly like a wink of derision." After this we shall not be surprised to hear of a body of scientific experts meeting to consider the question of suicide among animals—with Mark Twain as President of the Committee.

"Loch Creran" is not a vivacious book; but it is unpretentious; and the author, in a rambling and hap-hazard fashion, contrives to give us some idea of his surroundings and pursuits. Indeed, the dweller in towns, who has the patience to follow this somewhat prolix writer, will probably part company with him with no slight feeling of envy.

OUR BOOK SHELF

The Encyclopædic Dictionary. Vol. VI. Part I. (London: Cassell and Co., 1887.)

THE work to which this volume belongs is much more than a mere dictionary in the ordinary sense. It includes the description of things as well as of words, special attention being given to objects and processes indicated by scientific and technical terms. The information offered is never, of course, exhaustive, but it is sufficient for the purposes the compilers have had in view, and generally it has the merit of being clear, concise, and, as far as it goes, accurate. As a dictionary the work deserves high praise. It contains all the English as well as all the Scotch words now in use, with their significations re-investigated, re-classified, and re-illustrated by examples. A large number of obsolete words have also been introduced. The etymology is inclosed within brackets immediately following each word; and the pronunciation is indicated by diacritical marks, a key to which is given at the foot of the several pages. The present volume includes all words from "quo" to "shipp," and, so far as we have been able to test it, we have found it lucidly arranged and thoroughly trustworthy.

Descriptive Catalogue of the General Collection of Minerals in the Australian Museum. By A. Felix Ratte. Printed by order of the Trustees. (Sydney: Thomas Richards.)

THIS Catalogue has been carefully compiled, and no doubt it has already been of considerable service to persons making use of the Australian Museum. For the classification of silicates the compiler has taken as a guide Dana's "System of Mineralogy"; for the classification of metallic minerals, Roscoe's "Chemistry." But these authors' systems have not been entirely followed, especially where rare mineral products are concerned. The notes, although generally brief, are adequate, and there is a valuable appendix on gems and ornamental specimens.

LETTERS TO THE EDITOR

[The Editor does not hold himself responsible for opinions expressed by his correspondents. Neither can he undertake to return, or to correspond with the writers of, rejected manuscripts. No notice is taken of anonymous communications.]
[The Editor urgently requests correspondents to keep their letters as short as possible. The pressure on his space is so great that it is impossible otherwise to insure the appearance even of communications containing interesting and novel facts.]

West Indian Meteorological Confederation

IN the leading article in NATURE, vol. xxxv. p. 241, remarks were made respecting the advantages which would accrue to the West Indian Islands, and to the Meteorological Council of the

Royal Society, if those islands were confederated for meteorological purposes.

The writer was apparently unaware that in the year 1879 those islands agreed to confederation. It was not restricted to the British colonies—Guadaloupe, for instance, passed a vote of credit through its chamber before the decision of the British Meteorological Council was received—but all the work broke down when the Meteorological Council insisted upon Antigua as the central station.

It is unnecessary to say that unmitigated failure was the result.

The advantages to the United States of any West Indian system, however poor, are palpable to the lowest stratum of scientific intelligence; yet we find that Congress disestablished the whole of their West Indian stations without the slightest reason, as far as I have been able to discover. But the words of the Chief Signal Officer have a thousand times the weight of mine, and I quote them accordingly:—

"Among the objects for which appropriations were refused were 'foreign reports.' A request was made for 4000 dollars to pay for these warnings of tropical hurricanes, which, last year, were instrumental in saving millions of dollars of property. Two storms of great fury swept up from the Gulf, one in September and one in October. Warnings of the coming of these storms were given from the West India stations, so that the indications officer on duty in each month was able to give at least two days' notice of the coming of the storm to every port in the Gulf and on the Atlantic coast. The result was an immense saving of valuable property and of human life. The statistics were gathered as fully as possible from all the stations passed over by the cyclones, and the names of the vessels, their value, and the value of their cargoes, remaining in port in obedience to the storm warnings of this service, were ascertained. The reports were not wholly satisfactory, because accurate information could not be obtained from the largest places of the country, such as New York, Philadelphia, Baltimore, and Boston. These cities lie at the head of large harbours that have safe anchorages near their openings, and vessels delayed by a storm almost invariably go down the harbour to there await its conclusion. But, without these great ports, it was ascertained that 6,469,586 dollars of property remained safe in harbour during the September cyclone, and 6,051,393 dollars in October. The failure to appropriate the 4000 dollars asked for for the current fiscal year has reduced the warnings received from the West Indies, and made it less possible to predict with certainty the approach of tropical hurricanes." (Report for 1883, p. 4.)

The anticipations of the Chief Signal Officer have been fully confirmed.

In the face of such opposition I would ask what is the use of proposing schemes of confederation requiring the support of the authorities? There is no doubt that if meteorological confederation is to obtain in the West Indies, it must be done among the British colonies themselves; but who will come forward to undertake such a task? Should anyone attempt it, he will at least have the support of Jamaica.

MAXWELL HALL,

Jamaica Government Meteorologist

February 15

Units of Weight, Mass, and Force

YOUR reviewer, of the well-known initials "P. G. T.," has taken exception to some of the terminology employed by Mr. Anderson in his book "On the Conversion of Heat into Work," particularly to the expressions of "pounds on the square inch" and "tons on the square inch," which he says would define a superficial density if used in their proper sense; and it is this opinion I wish, with your permission, to dispute, as I think "P. G. T." and mathematicians generally, are at present in this

endeavour to avoid one ambiguity in dynamical language only creating greater confusion.

I presume that "P. G. T." would have been satisfied with the above expressions provided the word "weight" had been introduced somewhere; but let us examine carefully what is implied by "weight" as used in ordinary language.

Turning to the chapter on elementary dynamical principles in Maxwell's "Theory of Heat," we find that "the word *weight* must be understood to mean the *quantity of the thing as determined by the process of weighing against standard weights*." And again:—"In a rude age, before the invention of means for overcoming friction, the weight of bodies formed the chief obstacle to setting them in motion. It was only after some progress had been made in the art of throwing missiles, and in the use of wheel-carriages and floating vessels, that men's minds became practically impressed with the idea of mass as distinguished from weight."

The language we employ, including the use of the ambiguous word "weight," was formed in this rude age before the discovery of true dynamical principles and before the theory of gravitation, and now, in order to avoid ambiguity, the mathematician uses, *wherever it is possible*, the word "mass" for greater precision, where an ordinary person would use the word weight.

But unfortunately for his principle the rules of language do not permit him to be consistent, and he is compelled to speak of "weights and measures" and of "bodies weighing so many pounds or tons" instead of "bodies *massing* so many pounds," or "*masses* and measures," which might be mistaken for a political phrase.

The word "weight" will, then, be found to be used in ordinary language in most cases in the same sense as the word "mass," introduced with laudable intention by the mathematicians to avoid confusion; but unfortunately some mathematicians introduce greater confusion than they remove by appropriating the word "weight" to the subsidiary sense of the word, undistinguishable by those ignorant of dynamics, namely, the force with which the earth attracts the weight.

Thus we find in ordinary treatises on dynamics, after an effort at the definition of the mass, the weight of a body defined as "the force with which it is attracted by the earth."

As Maxwell says, "The only occasions in common life in which it is required to estimate weight considered as a force is when we have to determine the strength required to lift or carry things, or when we have to make a structure strong enough to support their weight." Herein is comprised in general terms the whole province of the theory of engineering, and consequently the engineer always employs the gravitational measure of forces.

The force with which the earth attracts the standard weight is taken as the gravitation unit of force; and for brevity the force with which the earth attracts a pound weight (the mathematician would say a pound mass) is called the force of a pound, abbreviated again to "a pound." Hence we have steam pressures, gunpowder pressures, moduli of elasticity, tenacities, &c., as well as the expressions objected to by "P. G. T." in Mr. Anderson's book, expressed in pounds or tons on the square inch, without creating any confusion in the mind of the practical man; and we find the words "pound" or "ton" used side by side, now in the sense of weight or mass, and now in the sense of force; as, for instance, in the statement, "A train, weighing 100 tons moving against a resistance of 20 pounds a ton, is drawn by an engine exerting a pull of 2 tons, &c."

But when the practical man opens the ordinary text-book on dynamics, then the confusion begins. Take, for instance, the familiar equation $W = Mg$: what does it mean? The writers tell us that W means the weight and M the mass of the body. Having defined "weight" as the force with which the body is attracted by the earth, the writer implies that he is keeping to the statical gravitational unit of force, and therefore his unit of mass is the mass of g pounds, if W , the weight, is measured in pounds. But, after defining a pound as a unit of mass, he ought to take M as the weight in pounds, and then the equation $W = Mg$ means that the earth attracts M pounds with a force of W poundals where $W = Mg$.

The confusion is intolerable ("most tolerable, and not to be endured"), and entirely due to the erroneous mathematical definition of the word "weight," combined with straining the units of mass and force so as to fit into the equation $P = Mf$, when absolute units are not employed.

To show the absurdity of the definition that "the weight of a body is the force with which it is attracted by the earth," take the question, "What is the weight of the earth?" Accord-

ing to this definition, the answer is "Zero," but ordinary people would calculate the result in millions of tons, from the data of the mean radius and the mean density.

Take again a question of a similar nature: "Prove that 288 pounds at the pole weigh the same as 289 pounds at the equator." To realise this question we must imagine a balance constructed of which the arm is curved into a quadrant of the earth, reaching along a meridian from the pole to the equator, and supported by a fulcrum in latitude 45°; then 288 pounds at the pole will equilibrate 289 pounds at the other end of the balance at the equator. Without requiring a balance with so long an arm, we can have 289 pounds at the bottom of the shaft of a mine weighing the same as 288 pounds at the surface, provided the shaft is of sufficient depth.

Some years ago, being troubled myself with this confusion of language, I wrote to Prof. Maxwell to ask him for a good illustrative example of the correct and incorrect use of the word "weight," and received the following characteristic reply on a postcard:—"Compare St. John xix. 39, ὡσεὶ λίτρας ἑκατόν, with the A.V. (authorised version), and keep to the original Greek." The translation in the authorised version is "about a hundred pounds weight."

Here we see that Maxwell recognised the ambiguous nature of the word "weight," and advised its omission wherever possible; but the exigencies of language compel us to use it; and in fact we shall generally find writers, even after the above incorrect definition of weight, proceed subsequently to use the word in its ordinary meaning of daily life.

I wish to repeat that writers on dynamics only create confusion in appropriating the word "weight" to the sense of the force of attraction of the earth on a body, as we never speak of "a force weighing so many pounds"; and I wish to support the language in ordinary use by engineers and practical men as perfectly correct in using the words "pound" or "ton" side by side in two senses, first as meaning the weight (or mass) of a body, and secondly as meaning the force with which the body is attracted by the earth; one being sometimes distinguished as a pound weight, and the other as a pound force.

If we use Prof. James Thomson's admirable word "poundal" for the British absolute unit of force, this slight confusion of terms will disappear, although engineers will still continue to think in gravitation units of force, as gravity is the one universal force from which there is no escape; and I fear it will be impossible ever to persuade them to think in C.G.S. units like the centimetre, gramme, dyne, erg, &c., which, though admirably adapted for the minute measurements of experiments in physics, are unsuitable for large magnitudes.

In conclusion, let the equation $W = Mg$ be dismissed from the text-books, as leading to statements such as "The mass of a body weighing W pounds is $\frac{W}{g}$;" the true equivalent equation being

$W = M$, and therefore unnecessary; and with it let the confusing "astronomical unit of mass" disappear, and introduce instead the "constant of gravitation" in our equations. Let us also recognise that the primary idea of "weight" is the same as "mass," and form our dynamical definitions on the usages of ordinary language.

A. G. GREENHILL

Woolwich, February 28

Mr. Herbert Spencer's Definition of Life

I HAVE read with much interest the report in NATURE of Prof. Judd's address to the Geological Society, in which he attempts to show that Mr. Herbert Spencer's definition of life is not restricted to those cases only which display the ordinarily acknowledged characteristics of vitality; a certain correspondence between internal and external changes being displayed by minerals.

I write to draw attention to what I think tends to show that the mass of evidence brought forward really tells in favour of the definition; bearing in mind that the hypothesis of evolution "implies insensible modifications and gradual transitions, which render definition difficult—which make it impossible to separate absolutely the phases of organisation from one another" ("Principles of Biology," vol. ii. p. 10), and that consequently there can be no "absolute" commencement of life.

The fact, treated by Mr. Spencer when seeking a definition of life, that there is a correspondence between life and its cir-

cumstances gives the clue showing us that the "vitality of minerals" is a misnomer; a fallacy he himself exposes when he treats of the internal actions—the feathery crystallisation—displayed by the misnamed storm glass in correspondence with external changes. Using his own words, we see that:—

"Subtle as is the dependence of each internal upon each external change, the connection between them does not, in the abstract, differ from the connection between the motion of a straw and the motion of the wind that disturbs it. In either case a change produces a change, and there it ends. The alteration wrought by some enviroing agency on an inanimate object, does not tend to induce in it a secondary alteration, that anticipates some secondary alteration in the environment. But in every living body [in a living body, mark!] there is a tendency towards secondary alterations of this nature; and it is in their production that the correspondence consists. The difference may be best expressed by symbols. Let A be a change in the environment; and B some resulting change in an inorganic mass. Then A having produced B, the action ceases. Though the change A in the environment, is followed by some consequent change a in it; no parallel sequence in the inorganic mass simultaneously generates in it some change b that has reference to the change a. But if we take a living body of the requisite organisation, and let the change A impress on it some change C; then, while in the environment A is occasionally a, in the living body C will be occasioning c; of which a and c will show a certain concord in time, place, or intensity. . . ." (vol. i. p. 78).

"That the word *correspondence* will not include, without straining, the various relations to be expressed by it," is best met by the reply "that we have no word sufficiently general to comprehend all forms of this relation between the organism and its medium, and yet sufficiently specific to convey an adequate idea of the relation; . . . The fact to be expressed in all cases, is, that certain changes, continuous or discontinuous, in the organism, are connected after such a manner that, in their amounts, or variations, or periods of occurrence, or modes of succession, they have a reference to external actions, constant or serial, actual or potential—a reference such that a definite relation among any members of the one group, implies a definite relation among certain members of the other group; and the word *correspondence* appears the best fitted to express this fact." (vol. i. p. 79).

In deer-stalking we see a realisation of these symbols. In the deer the primary internal change—the perception of odour, or, as I believe it is called, "winding"—is followed by that secondary internal change which induces a desire to increase the distance between the living organism and the inferred source of danger, a change differing not only in degree, but in kind, differing *totò calò* from any of those actions which take place in minerals and crystals.

That the address contains many valuable facts furthering not only Mr. Spencer's view of life, but also his views of evolution, becomes apparent when we consider how it carries out and develops these ideas to an extent which would have been impossible at the time when the "Principles of Biology" were first published, now twenty years since. I say "furthering," for I wish now to touch upon a very important point, which I cannot but think has been much enlarged and amplified by Prof. Judd. It is to the much more expanded meaning which can now be attached to the fact that the degree of life varies as the degree of correspondence between internal and external relations.

For the correspondence displayed by a crystal or mineral is shown to be of a very much lower degree than that displayed by the simplest plant or animal. These latter present correspondences of greater complexity, greater rapidity, and greater length in the series of them than the former, which, during its long "millions of years," can respond only to the two or three forms of molar and molecular forces alluded to. The changes in the mineral simply respond to changes in the environment; whereas in an organism it is a relation between changes in it which responds to a relation between changes in the environment.

Churchfield, Edgbaston

F. HOWARD COLLINS

An Equatorial Zone of almost Perpetual Electrical Discharge

THE recent reference in your columns to Edlung's theory of the aurora borealis, recalls a very curious observation that I

have made in my travels of a zone of almost perpetual electrical discharge in the belt of the "doldrums" all round the world.

Anywhere in that belt, a more or less intermittent display of sheet lightning commences the moment the twilight of sunset has sufficiently faded away, and continues with varying intensity till the light of morning prevents further observation.

The localisation of this belt of lightning is very obvious as we run a section across the equator on board ship. There is very little electrical discharge in the high-pressure belt of anticyclones which encircle the earth approximately under the lines of the tropics; but as we approach the low-pressure band of the "doldrums," where the two trade-winds, or the two monsoons meet, then the display of lightning is of nightly occurrence, even if there are no actual thunderstorms.

This electric discharge has a diurnal period like every other meteorological element; for night after night, as I have slept on deck in Malaysia during the change of the monsoons, I have noticed a very marked diminution of the lightning after 1 or 2 a.m. If a total eclipse of the sun could last for twelve hours, I have no doubt that we should see more or less lightning all the time, with a regular set of diurnal variations.

Edling and others have noticed the gradual decrease in the frequency of thunderstorms as we recede from the equator; but I wish to show now, not only that the discharge is of nightly occurrence, but that the locality of maximum effect is not so much on the equator as in the "doldrums." The sheet lightning may be the reflection of distant thunderstorms, or it may be the silent discharge of electricity. Meteorologists are much divided as to the possibility of the latter; but it is certain that the amount of sheet lightning is out of all proportion to the frequency of actual thunderstorms.

Is it not possible that we may find in this perpetual lightning, some clue to the origin of earth-currents everywhere? and in the diurnal variation in the discharge, some probable reason for the hourly variation of the aurora, and of some magnetic elements? No doubt it is at present difficult to connect the electricity of lightning with the electro-magnetic effects of terrestrial magnetism or the aurora; and though Edlung's theory is defective in this respect, I cannot help thinking that he is right in collating thunderstorms on the equator with the glow discharge of electricity on the Arctic circle; and it is in the hope that the discovery of the constancy of electrical discharge in the "doldrums" may perhaps assist in the evolution of a true theory of the aurora, that I have penned this short notice.

RALPH ABERCROMBY

21 Chapel Street, London, March 15

Scorpion Virus

PROF. BOURNE'S experiments, related in the Proceedings of the Royal Society of January 6, 1887, seem to establish the fact that although the scorpion may be provoked to strike and wound itself or another scorpion, it is incapable, in either case, of causing any toxic action, however active the virus may prove in respect of other creatures. That it is, in short, with the scorpion as it is with the cobra or viper: they poison other creatures, but not themselves or each other.

Some years ago an exhaustive series of experiments brought me to the conclusion that a cobra is not poisoned by cobra virus, whether inoculated by its own fangs, by those of another cobra, or by a hypodermic syringe. The same in the case of daboia and other viperine snakes.

It seemed, however, that the bungarus, a less deadly snake than the cobra, occasionally is affected, though slowly, by the cobra virus, but that it escapes more frequently than it suffers; and when it does suffer the effect of the poison is greatly diminished. On the other hand, non-venomous snakes, lizards, frogs, fish, mollusca, and other low forms of life, all rapidly succumb to snake poison.

The details of these experiments are to be found in the "Thanatophidia of India," published in 1872, and in referring to them Prof. Bourne remarks: "They show conclusively that the cobra poison will not affect a cobra, and will not even affect the viperine pyas." I would correct the latter part of the quotation so far as to say that the pyas is a colubrine harmless snake, not a viperine snake, and that it rapidly succumbs to the cobra virus.

Prof. Bourne has helped to dispel another of the popular delusions which cling round venomous creatures.

March 14

J. FAYRE

THE RELATION OF TABASHEER TO MINERAL SUBSTANCES

MR. THISELTON DYER has rendered a great service, not only to botanists, but also to physicists and mineralogists, by recalling attention to the very interesting substance known as "tabasheer" (*NATURE*, vol. xxxv. p. 396). As he truly states, very little fresh information has been published on the subject during recent years, a circumstance for which I can only account by the fact that botanists may justly feel some doubt as to whether it belongs to the vegetable kingdom, while mineralogists seem to have equal ground for hesitation in accepting it as a member of the mineral kingdom.

It is very interesting to hear that so able a physiologist as Prof. Cohn intends to investigate the conditions under which living plants separate this substance from their tissues. That unicellular Algæ, like the Diatomaceæ, living in a medium which may contain only one part in 10,000 by weight of dissolved silica, or even less than that amount, should be able to separate this substance to form their exquisitely ornamented frustules is one of the most striking facts in natural history, whether we regard it in its physiological or its chemical aspects.

Sir David Brewster long ago pointed out the remarkable physical characters presented by the curious product of the vegetable world known as "tabasheer," though so far as I can find out it has not in recent years received that attention from physicists which the experiments and observations of the great Scotch philosopher show it to be worthy of.

Tabasheer seems to stand in the same relation to the mineral kingdom as do ambers and pearls. It is in fact an *opal* formed under somewhat remarkable and anomalous conditions which we are able to study; and in this aspect I have for some time past been devoting a considerable amount of attention to the minute structure of the substance by making thin sections and examining them under the microscope. It may be as well, perhaps, to give a short sketch of the information upon the subject which I have up to the present time been able to obtain, and in this way to call attention to points upon which further research seems to be necessary.

From time immemorial tabasheer has enjoyed a very high reputation in Eastern countries as a drug. Its supposed medicinal virtues, like those of the fossil teeth of China and the belemnites ("thunderbolts") of this country, seem to have been suggested by the peculiarity of its mode of occurrence. A knowledge of the substance was introduced into Western Europe by the Arabian physicians, and the name by which the substance is generally known is said to be of Arabic origin. Much of the material which under the name of "tabasheer" finds its way to Syria and Turkey is said, however, to be fictitious or adulterated.

In 1788 Dr. Patrick Russell, F.R.S., then resident at Vizagapatam, wrote a letter to Sir Joseph Banks in which he gave an account of all the facts which he had been able to collect with respect to this curious substance and its mode of occurrence, and his interesting letter was published in the Philosophical Transactions for 1790 (vol. lxxx. p. 273).

Tabasheer is said to be sometimes found among the ashes of bamboos that have been set on fire (by mutual friction?). Ordinarily, however, it is sought for by splitting open those bamboo stems which give a rattling sound when shaken. Such rattling sounds do not, however, afford infallible criteria as to the presence or absence of tabasheer in a bamboo, for where the quantity is small it is often found to be closely adherent to the bottom and sides of the cavity. Tabasheer is by no means found in all stems or in all joints of the same stem of the bamboos. Whether certain species produce it in greater abundance than others, and what is the influence of soil, situation,

and season upon the production of the substance are questions which do not seem as yet to have been accurately investigated.

Dr. Russell found that the bamboos which produce tabasheer often contain a fluid, usually clear, transparent, and colourless or of greenish tint, but sometimes thicker and of a white colour, and at other times darker and of the consistency of honey. Occasionally the thicker varieties were found passing into a solid state, and forming tabasheer.

Dr. Russell performed the interesting experiment of drawing off the liquid from the bamboo-stem and allowing it to stand in stoppered bottles. A "whitish, cottony sediment" was formed at the bottom with a thin film of the same kind at the top. When the whole was well shaken together and allowed to evaporate, it left a residue of a whitish-brown colour resembling the inferior kinds of tabasheer. By splitting up different joints of bamboo Dr. Russell was also able to satisfy himself of the gradual deposition within them of the solid tabasheer by the evaporation of the liquid solvent.

In 1791, Mr. James Louis Macie, F.R.S. (who afterwards took the name of Smithson), gave an account of his examination of the properties of the specimens of tabasheer sent home by Dr. Russell (Phil. Trans. vol. lxxxi., 1791, p. 368). These specimens came from Vellore, Hyderabad, Masulipatam, and other localities in India. They were submitted to a number of tests which induced Mr. Macie to believe that they consisted principally of silica, but that before calcination some vegetable matter must have been present. A determination of the specific gravity of the substance by Mr. Macie gave 2.188 as the result; another determination by Mr. Cavendish gave 2.169.

In this same paper it is stated that a bamboo grown in a hot-house at Islington gave a rattling noise, and on being split open by Sir Joseph Banks yielded, not an ordinary tabasheer, but a small pebble about the size of half a pea, externally of a dark brown or black colour, and within of a reddish-brown tint. This stone is said to have been so hard as to cut glass, and to have been in parts of a crystalline structure. Its behaviour with reagents was found to be different in many respects from that of the ordinary tabasheer; and it was proved to contain silica and iron. The specimen is referred to in a letter to Berthollet published in the *Annales de Chimie* for the same year (October 1791). There may be some doubt as to whether this specimen was really of the nature of tabasheer; if such were the case, it would seem to have been a tabasheer in which a crystalline structure had begun to be set up.

In the year 1806, MM. Fourcroy and Vauquelin gave an account of a specimen of tabasheer brought from South America in 1804 by Humboldt and Bonpland (*Mém. de l'Inst.*, vol. vi. p. 382). It was procured from a species of bamboo growing on the west of Pichincha, and is described as being of a milk-white colour, in part apparently crystalline in structure, and in part semi-transparent and gelatinous. It was seen to contain traces of the vegetable structure of the plant from which it had been extracted. On ignition it became black, and emitted pungent fumes.

An analysis of this tabasheer from the Andes showed that it contained 70 per cent. of silica, and 30 per cent. of potash, lime, and water, with some organic matter. It would, perhaps, be rash to conclude from this single observation that the American bamboo produced tabasheer of different composition from that of the Old World; but the subject is evidently one worthy of careful investigation.

It was in the year 1819 that Sir David Brewster published the first account of his long and important series of observations upon the physical peculiarities of tabasheer (Phil. Trans., vol. cix., 1819, p. 283). The

specimens which he first examined were obtained from India by Dr. Kennedy, by whom they were given to Brewster.

Brewster found the specimens which he examined to be perfectly *isotropic*, exercising no influence in depolarising light. When heated, however, it proved to be remarkably *phosphorescent*. The translucent varieties were found to transmit a yellowish and to reflect a bluish-white light—or, in other words, to exhibit the phenomenon of *opalescence*. When tabasheer is slightly wetted, it becomes white and opaque; but when thoroughly saturated with water, perfectly transparent.

By preparing prisms of different varieties of tabasheer, Brewster proceeded to determine its refractive index, arriving at the remarkable result that tabasheer "has a lower index of refraction than any other known solid or liquid, and that it actually holds an intermediate place between water and gaseous bodies!" This excessively low refractive power Brewster believes to afford a complete explanation of the extraordinary behaviour exhibited by tabasheer when wholly or partially saturated with fluids. A number of interesting experiments were performed by saturating the tabasheer with oils of different refractive powers, and by heating it in various ways and under different conditions, and also by introducing carbonaceous matter into the minute pores of the substance by setting fire to paper in which fragments were wrapped.

The mean of experiments undertaken by Mr. James Jardine, on behalf of Brewster, for determining the specific gravity of tabasheer, gave as a result 2.235. From these experiments Brewster concluded that the space occupied by the pores of the tabasheer is about two and a half times as great as that of the colloid silica itself!

From this time forward Brewster seems to have manifested the keenest interest in all questions connected with the origin and history of a substance possessing such singular physical properties. By the aid of Mr. Swinton, Secretary to the Government at Calcutta, he formed a large and interesting collection of all the different varieties of tabasheer from various parts of India. He also obtained specimens of the bamboo with the tabasheer *in situ*. In 1828 he published an interesting paper on "the Natural History and Properties of Tabasheer" (*Edinburgh Journal of Science*, vol. viii., 1828, p. 288), in which he discussed many of the important problems connected with the origin of the substance. From his inquiries and observations, Brewster was led to conclude that tabasheer was only produced in those joints of bamboos which are in an injured, unhealthy, or malformed condition, and that the siliceous fluid only finds its way into the hollow spaces between the joints of the stem when the membrane lining the cavities is destroyed or rent by disease.

Prof. Edward Turner, of the University of London, undertook an analysis of tabasheer, the specimens being supplied from Brewster's collection (*Edinburgh Journal of Science*, vol. viii., 1828, p. 335). His determinations of the specific gravities of different varieties were as follows:—

Chalky tabasheer	2.189
Translucent tabasheer	2.167
Transparent tabasheer	2.160

All the varieties lose air and hygroscopic water at 100° C., and a larger quantity of water and organic matter (indicated by faint smoke and an empyreumatic odour) at a red heat. The results obtained were as follows:—

	Loss at 100° C.	Loss at red heat
Chalky tabasheer	0.838 per cent.	1.277 per cent.
Translucent tabasheer	1.620 " "	3.840 " "
Transparent tabasheer	2.411 " "	4.518 " "

Dr. Turner found the ignited Indian tabasheer to consist almost entirely of pure silica with a minute quantity

of lime and vegetable matter. He failed to find any trace of alkalis in it.

In 1855, Guibourt (*Fourn. de Pharm.* [3], xxvii. 81, 161, 252; *Phil. Mag.* [4], x. 229) analysed a specimen of tabasheer having a specific gravity of 2.148. It gave the following result:—

Silica	= 96.94
Potash and lime	= 0.13
Water	= 2.93
Organic matter	= trace

Guibourt criticised some of the conclusions arrived at by Brewster, and sought to explain the source of the silica by studying the composition of different parts of the bamboo. While the ashes of the wood contained 0.0612 of the whole weight of the wood, the pith was found to contain 0.448 per cent., the inner wood much less, and the greatest proportion occurred in the external wood. On these determinations Guibourt founded a theory of the mode of formation of tabasheer based on the suggestion that at certain periods of its growth the bamboo needed less silica than at other times, and that when not needed, the silica was carried inwards and deposited in the interior.

In the year 1857, D. W. Rost van Tonningen, of Buitenzorg, undertook an investigation of the tabasheer of Java, which is known to the natives of that island under the name of "singkara" (*Naturkundig Tijdschrift voor Nederlandsch Indië*, vol. xiii., 1857, p. 391). The specimens examined were obtained from the *Bambusa apus* growing in the Residency of Bantam; it is described as resembling in appearance the Indian tabasheers. Its analysis gave the following result:—

Silica	= 86.387
Iron oxide	= 0.424
Lime	= 0.244
Potash	= 4.806
Organic matter	= 0.507
Water	= 7.632

Total ... 100.000

Apart from the question of its singular mode of origin, however, and its remarkable and anomalous physical properties, tabasheer is of much interest to mineralogists and geologists. All the varieties hitherto examined, with the exception of the peculiar one from the Andes, are in composition and physical characters true opals; this is the case with all the Indian and Java varieties. They consist essentially of silica in its colloidal form, the water, lime, potash, and organic matter being as small and variable in amount as in the mineral opals; and, as in them, these substances must be regarded merely as mechanical impurities.

The tabasheers must be studied in their relations on the one hand with certain varieties of the natural semi-opals, hydrophanes, beekites, and floatstones, some of which they closely resemble in their physical characters, and on the other hand with specimens of artificially deposited colloid silica formed under different conditions. Prof. Church, who has so successfully studied the beekites, informs me that some of those remarkable bodies present singular points of analogy with tabasheer.

By the study of thin sections I have, during several years, been endeavouring to trace the minute structure of some of these substances. In no class of materials is it more necessary to guard one's self against errors of observation arising from changes induced in the substance during the operations which are necessary to the preparation of transparent sections of hard substances. Unfortunately, too, it is the custom of the natives to prepare the substance for the market by an imperfect calcination, and hitherto I have only been able to study specimens procured in the markets which have been subjected to this process. It is obviously desirable, before

attempting to interpret the structures exhibited under the microscope, to compare the fresh and uncalcined materials with those that have been more or less altered by heat.

Tabasheer would seem, from Brewster's experiments, to be a very intimate admixture of two and a half parts of air with one part of colloidal silica. The interspaces filled with air appear, at all events in most cases, to be so minute that they cannot be detected by the highest powers of the microscope which I have been able to employ. It is this intimate admixture of a solid with a gas which probably gives rise to the curious and anomalous properties exhibited by this singular substance.

The ultra-microscopical vesicles filled with air in all probability give rise to the opalescence which is so marked a property of the substance. Their size is such as to scatter and throw back the rays at the blue end of the spectrum and to transmit those at the red end.

When the vesicles of the substance are filled with Canada balsam, and a thin slice is cut from it, this opalescence comes out in the most striking manner; very thin sections are of a rich orange-yellow by transmitted light, and a delicate blue tint by reflected light.



Section of Indian tabasheer, seen with a magnifying power of 250 diameters.

I do not know of any substance which in such thin films displays such striking opalescence.

That the excessively low refractive power of tabasheer is connected with the mechanical admixture of the colloidal silica with air seems to be proved by the experiments of Brewster, showing that with increase of density there was an increase in the refractive index, from 1.111 in specimens of the lowest specific gravity, to 1.182 in those of the highest specific gravity. Where the surface was hard and dense, Brewster found the refractive index to approach that of semi-opal. The wonderful thing is that a substance so full of cavities containing gas should nevertheless be transparent.

By the kindness of Mr. F. Rutley, F.G.S., I am able to supply a drawing taken from one of my sections of tabasheer.

The accompanying woodcut gives some idea of the interesting structures exhibited in some sections of tabasheer, though much of the delicacy and fidelity of the original drawing has been lost in transferring it to the wood.

In this particular case, the faint punctation of the surface may possibly indicate the presence of air-vesicles

of a size sufficiently great to be visible under the microscope. But in many other instances I have failed to detect any such indication, even with much higher powers. The small ramifying tubules might at first sight be taken for some traces of a vegetable tissue, but my colleague Dr. Scott assures me that they do not in the least resemble any tissue found in the bamboo. I have myself no doubt that it is an inorganic structure. It is not improbably analogous to the peculiar ramifying tubules formed in a solution of water-glass when a crystal of copper sulphate is suspended in it, as shown by Dr. Heaton (*Proc. Brit. Assoc.*, 1869, p. 127). Similar forms also occur on a larger scale in some agates, and the artificial cells of Traube may probably be regarded as analogous phenomena.

The aggregates of globular bodies seen in the section so greatly resemble the globulites of slags and natural glasses, and in their arrangement so forcibly recall the structures seen in the well-known pitchstone of Corriegills in Arran, that one is tempted to regard them as indicating the beginnings of the development of crystalline structure in the tabasheer. But I have good grounds for believing the structure to have a totally different origin. They seem in fact to be the portions of the mass which the fluid Canada balsam has not succeeded in penetrating. By heating they may be made to grow outwards, and as more balsam is imbibed they gradually diminish, and finally disappear.

I must postpone till a future occasion a discussion of all the structures of this remarkable substance and of the resemblances and differences which they present to the mineral opals on the one hand, and to those of the opals of animal origin found in sponge spicules, radiolarians, and the rocks formed from them, some of which have recently been admirably investigated by Dr. G. J. Hinde (*Phil. Trans.*, 1885, pp. 425-33).

I cannot, however, but think that it would be of the greatest service to botanists, physicists, and mineralogists alike, if some resident in India would resume the investigations so admirably commenced by Dr. Patrick Russell nearly a century ago; and it is in the hope of inducing someone to undertake this task that I have put together these notes. There are certain problems with regard to the mode of occurrence of this singular substance which could only be solved by an investigator in the country where it is found.

Most parcels of the commercial tabasheer appear to contain different varieties, from the white, opaque, chalk-like forms, through the translucent kinds to those that are perfectly transparent. It would be of much interest if the exact relation and modes of origin of these different varieties could be traced. It would also be important to determine if Brewster was right in his conclusion that the particular internodes of a bamboo which contain tabasheer always have their inner lining tissue rent or injured. The repetition of Dr. Russell's experiment of drawing off the liquids from the joints of bamboos and allowing them to evaporate is also greatly to be desired. My colleague Prof. Rucker, F.R.S., has kindly undertaken to re-examine the results arrived at by Brewster in the light of more recent physical investigations, and I doubt not that some of the curious problems suggested by this very remarkable substance may ere long find a solution.

JOHN W. JUDD

EXHIBITION OF MARINE METEOROLOGICAL INSTRUMENTS

THE eighth Annual Exhibition of the Royal Meteorological Society was held in the Library of the Institution of Civil Engineers, 25 Great George Street, Westminster, from Tuesday, March 15th, to Friday, the 18th. The exhibition was specially devoted to marine meteoro-

logical instruments and apparatus, and such new instruments as have been invented and first constructed during the past twelve months.

A very interesting and valuable collection of instruments from the *Challenger* Commission, the Scottish Marine Station at Granton, the Scottish Meteorological Society, and Mr. J. Y. Buchanan, were brought from Edinburgh under the charge of Dr. H. R. Mill, who showed several in action. This set included various forms of deep-sea thermometers, from the early pattern of the Miller-Casella to the Scottish frame for Negretti and Zambra's reversing thermometer, which has been adapted from Magnaghi's by Dr. Mill. Two specimens of the Miller-Casella thermometer, after four months' immersion in brackish water, were shown, with the following results: in No. 1, which was placed at the surface, the copper case was clean, but the scale figures were entirely obliterated from the porcelain; in No. 2, which was suspended in 9 fathoms, and at 1 foot above the bottom, the copper was entirely covered with a green crust, but the scale figures were not rendered illegible. Various forms of piezometers for ascertaining the depth when the temperature is known, or the temperature when the depth is known, were also exhibited. These were nearly all constructed by Mr. Buchanan on board the *Challenger*. Water-bottles for obtaining samples of water at the bottom, or any required depth below the surface, were suspended from the gallery to show their action when in use. The most interesting were Buchanan's sounding-rod and water-bottle for great depths, and Mill's self-locking slip water-bottle for moderate depths.

The Meteorological Council contributed sets of instruments as supplied to merchant ships and the Royal navy; the Royal Meteorological Institute of the Netherlands exhibited a set as supplied to the Dutch navy; and the Deutsche Seewarte sent a set as issued to the German navy.

The Rev. C. J. Steward exhibited a set of instruments as used at the Lochbuie Marine Institute, Isle of Mull, which, among others, included a dimenion thermometer in a box for river temperatures, the box being suitable for the bottoms of pools, or rough stony bottoms; and a large disk for ascertaining the transparency of the sea.

In connexion with the deep-sea thermometers Mr. Casella showed some apparatus originally employed in testing these instruments for the Admiralty and the Royal Society, and damaged during the experiments; viz., a bottle broken at a pressure corresponding to 2½ miles of sea-water, a steel bar bent at 3 miles, and an iron plug broken at 4 miles. Specimens of almost every pattern of deep-sea thermometer were exhibited, including Johnson's registering metallic, the records of which are obtained by the varying expansion of brass and steel bars acting upon indices; Miller-Casella maximum and minimum; and Negretti and Zambra's turnover thermometer.

The barometers exhibited included patterns used in the British, Dutch, French, and German navies. The English marine barometer has an iron cistern and contracted scale, and the gun barometer is mounted with india-rubber packing to prevent breakage caused by gun-firing. M. Richard Frères, of Paris, sent one of their self-recording aneroids, for use on board ship; and Mr. Abercromby showed several curves taken at sea by one of these instruments in various parts of the world.

The anemometers shown were: Sir Snow Harris's, which is an improved form of Lind's; Hagemann's, Robinson's, Black's pressure, and Whipple's maximum pressure, the latter being quite a new instrument. Dr. Black exhibited his marine rain-gauge and evaporator. Among the miscellaneous instruments were various forms of patent logs, current meters, clinometers, and a model of a section of a vessel fitted with lightning conductor.

In addition to the instruments, a number of charts

diagrams, &c., were exhibited, showing the meteorological conditions prevailing over the various oceans of the globe. The advance made in synoptic meteorology over the North Atlantic was clearly shown by comparing Leverrier's charts (1864) with the daily synchronous weather charts just published by the Meteorological Council. The specimens exhibited of the latter were (1) August 1-6, showing the meteorological conditions in the summer; (2) February 9-14, showing the conditions in the winter; and (3) February 24 to March 4, showing the conditions in early spring, and the persistence of the European anticyclone, producing cold dry winds over England. The Meteorological Council also exhibited a set of large charts showing the mean temperature of the sea surface round the coasts of the British Isles for each month. Dr. Mill had several interesting diagrams showing the distribution of temperature in a section of the Clyde sea area at seven periods from April 1886 to February 1887. Mr. Abercromby exhibited forty-six photographs and diagrams of clouds taken in various parts of the world; and Mr. Dyason showed a number of coloured drawings of clouds, &c. The Astronomer Royal sent the photographic registers of magnetic declination and horizontal force at the Royal Observatory, Greenwich, showing the earthquake shock which occurred on the morning of February 23.

The most interesting of the new instruments was the Watkin aneroid with open scale, by Mr. Hicks. Instead of the usual one-circle of figures, the scale of this instrument consists of a spiral of three complete turns. On the aneroid being put under an air-pump or taken up a mountain, the point of the index is gradually drawn *towards* the centre, so that it follows the *decreasing* spiral scale; but when the index moves in the opposite direction, the point moves *away* from the centre, thus following the *increasing* spiral. This is effected by the index-hand being made to slide in and out, so that one end may advance or recede from the centre, and thus follow the spiral scale. Attached to the spindle is a cross-piece, in which the index slides, and a hollow drum fixed to the dial-plate has a flexible chain or cord wound round it, the ends being fastened on the projecting pins riveted to the index. Consequently, if the spindle and the piece attached to it are revolved, one portion of the chain or cord winds off the drum, the other is wound on to the same extent, and the index is caused to slide through the cross-piece, the direction of motion being controlled by the direction in which the spindle is revolved.

MM. Richard Frères sent specimens of their self-recording thermometer, hygrometer, dry and wet bulb thermometers, and rain-gauge.

GEOGRAPHY AT THE UNIVERSITIES

AT last, after years of apparently fruitless labour, the Royal Geographical Society have been eminently successful in persuading almost simultaneously the two great English Universities to recognise geography as a University study, and to make definite provision for teaching it. In pursuance of a proposal made by the President and Council of the Royal Geographical Society to the Vice-Chancellors of the two Universities, and of the replies thereto, a deputation of a few members of their Council visited Oxford and Cambridge in turns, to meet delegates appointed by those Universities, in order to explain their proposal more fully, and to discuss any modifications that might be suggested. The main features of the proposal were, that the Royal Geographical Society offered to give 150*l.* annually to each University if they would establish a Lectureship or Readership in Geography, giving the Lecturer an adequate University status, and contributing, on their part, an equal sum, so

the stipend of each Lectureship to 300*l.* The Council also offered to give the two Universities a Scholarship or Exhibition of 100*l.* in alternate years for geographical students. The Royal Geographical Society was to be represented on the Board that selected the Examiners, and on that which adjudged the Scholarship.

The meeting at Oxford with delegates from that University, including the present and past Vice-Chancellor took place five weeks ago, at which the proposal was well discussed and favourably entertained, subject to the foreseen difficulty of finding adequate funds from the University resources; nevertheless everything seemed in train for being eventually carried out, though after a little delay, in the intended manner. An unexpected incident, however, gave a new and collateral impulse, and has hurried the Lectureship into existence at once. It happened that the Readership in Ancient History became vacant, and it seems to have occurred to those with whom the election of a successor rested, that as there was a great difficulty in finding funds for geography, and as a Professorship in Ancient History was already in existence, and, again, ancient history was taught by most classical tutors, the Readership in Ancient History might be abolished without much loss, and one in geography might be with propriety established in its place. There was a near-even division of opinion on the matter, but the vote in favour of geography prevailed and carried the day, and the advertisement inviting candidates has already been published. So Oxford now takes an independent line, and accepts only the offer of the Scholarship.

The Cambridge meeting took place about three weeks ago. The proposal was carefully discussed, and modifications were asked for. At Cambridge, as at Oxford, the University funds are seriously embarrassed by engagements already entered into, chiefly connected with building operations; and there seemed no way, so narrow was the available surplus, of raising the whole of the annual amount of 150*l.* in a direct form, but only 50*l.* of it. However, it appeared that indirect means existed by which the nominal sum would indirectly and eventually be raised, even something more than the proposed amount, and an amendment specifying only 50*l.* was therefore provisionally accepted. After this had received the approval of the Council of the Royal Geographical Society, it was submitted to the Council of the University of Cambridge and adopted by them in the terms of the following recommendation:—

“That the approval of the Senate be given to the delivery in the University in the ensuing academic year of one or more courses of lectures on geography by lecturers selected by the Royal Geographical Society, that a teacher of geography be appointed by the Committee on which the Royal Geographical Society is represented, and that the Senate accept the proposal of the Royal Geographical Society to award in alternate years an Exhibition of 100*l.* or prizes of 50*l.* and 25*l.* That before the end of the Easter Term, 1888 a University Lecturer in Geography be appointed, for a period of five years, at a stipend of 200*l.* a year, of which sum 50*l.* is to be paid out of the common University fund and 150*l.* by the Royal Geographical Society. The appointment of the Lecturer to be made by a joint Committee of the representatives of the Royal Geographical Society and of the Council of the Senate, subject to the confirmation of the Senate; the Lecturer to submit a scheme of lectures to the Committee of Management, and power is to be given to the Council of the Senate with the concurrence of the Committee of Management to cancel the appointment of the Lecturer at any time.”

This recommendation has to be submitted to the Senate at the beginning of next term, but its ultimate acceptance is placed almost beyond doubt through the very favourable reception given to the proposals of the Royal Geographical Society by the Council of the University.

*THE ORGANISATION OF I.
EDUCATION*

THE following is the letter by Prof. Huxley to which reference is made in our leading article (p. 482):—

"When a statesman of Lord Hartington's authority concurs with and enforces the opinions I ventured to express some little time ago, I have every reason for private and personal satisfaction. But the circumstance has a public importance as evidence that our political chiefs and leaders are giving their serious attention to those social questions which lie far above the region of party strife, and are of infinitely greater moment than the topics which ordinarily absorb the attention of politicians.

"The organisation of industrial and commercial education is not the least of these great problems. That it has to be solved, under penalty of national ruin, proves to be no mere alarmist fancy, but the belief of an experienced man of affairs, whose imperturbable coolness and strong common-sense are proverbial.

"It is an interesting question for us all, therefore, How do we stand prepared for the task thus imperatively set us? My conviction is that we are in some respects better off than most people imagine, in others worse. I conceive that two things are needful: on the one hand, a machinery for providing instruction and gathering information; on the other hand, a machinery for catching capable men wherever they are to be found and turning them to account. Now, I apprehend that both these kinds of machinery are to be found, though in a fragmentary and disconnected condition, in several organisations which, though independent, supplement one another.

"The first of these is that of the School Boards, which provide elementary education, and sometimes, though too rarely, have at their disposal scholarships by which capable scholars can attain a higher training. The second is the organisation of the Department of Science and Art. The classes, now established all over the country in connexion with the Department, not only provide elementary instruction, accessible to all, but offer the means whereby the pick of the capable students may obtain in the schools at South Kensington as good a higher education in science and art as is to be had in the country. It is from this source that the supply of science and art teachers, who in turn raise the standard of elementary instruction, is derived. The third organisation is that of the technical classes connected with the City and Guilds Institute, or with the Society of Arts, or with provincial Universities and Colleges, which provide special technical instruction for those who have, or ought to have, already acquired the elements of scientific and artistic knowledge in the science and art classes.

"A fourth organisation for the advancement of the interests of industry and commerce, of the nature of that which I imagined it was the intention of the founders of the Imperial Institute to create, and such as is, I believe, now actually in course of creation in the City of London, will complete the drill-grounds of the army of industry, and, so far as I can judge, omit nothing of primary importance. But, leaving the last aside as still in the embryonic condition, these excellent organisations are all *nere torsos*, fine—but fragmentary.

"The ladder from the School Boards to the Universities, about which I dreamed dreams many years ago, has not yet acquired much more substantiality than the ladder of Jacob's vision.

"The Science and Art Department has done, and is doing, admirable work, which I regret to see more often made the subject of small and carping criticism than of the praise which is its due. I trust it may not be diverted from efficiently continuing that work by having duties for which it is unfit forced upon it. That which the Department needs, in my judgment, is nothing but the means of

doing that which Commission after Commission, Royal and departmental, have declared to be its proper business.

"As Dean of the Normal School I may be permitted to declare that it is impossible for us to perform the functions allotted to us unless the recommendations made by impartial and independent authority are carried into effect.

"The school exists, and common-sense surely suggests either make it efficient or abolish it. The alternative of abolition is not likely to be adopted, as that step would be equivalent to striking the keystone out of the edifice of scientific instruction for the masses of the people which it has taken a quarter of a century to raise, and which is the essential foundation for any sound system of technical education. The alternative of efficiency means spending a few thousand pounds on additional buildings; but the guardians of the national purse do not seem to feel the force of the adage about 'spoiling a ship for a halfpenny-worth of tar.'

"The state of affairs in regard to that which ought to be the centre of our system of technical education is nearly the same. The Central Institute is undoubtedly a splendid monument of the munificence of the City. But munificence without method may arrive at results indistinguishably similar to those of stinginess. I have been blamed for saying that the Central Institute is 'starved.' Yet a man who has only half as much food as he needs is indubitably starved, even though his short rations consist of ortolans and are served up on gold plate. And I have excellent authority for saying that little more than one-half of the plan of operations of the Institute, drawn up by the Committee of which I was a member, has been carried out, or can be carried out, if the funds allotted for the maintenance of the Institute are not largely increased. At the same time, the Institute is doing all that could be rationally expected of it. Some of the guilds and many provincial towns are making admirable provision for elementary technical education. Such work, in my judgment, ought to be left to local administrators, whatever aid it may be thought desirable to give them. But the local schools should be brought into relation with the Central Institute, and this should be put upon such a footing as to subserve its proper purpose of training teachers and giving higher technical instruction.

"Economy does not lie in sparing money, but in spending it wisely. And it is, to my mind, highly necessary that some man or body of men, whom their countrymen trust, should consider these various organisations as a whole and determine the manner in which they should be correlated and in which it is desirable that the resources, public and private, which are available should be distributed among them.

"Lord Hartington has many claims on the gratitude and respect of his countrymen. I venture to express the wish that he would add to them by taking up this great work of organising industrial education and bringing it to a happy issue."

AUGUST WILHELM EICHLER

THE death of Dr. August Wilhelm Eichler, briefly announced in a previous number, is a great loss to botanical science, and especially to systematic botany. Year by year we are losing men of wide and consequently sound knowledge of plants without their places being adequately filled. We have doubtless arrived at a stage in botany where specialists are necessary; yet we venture to assert that men of general attainments are better qualified than specialists, in a narrow sense, for the head of large botanical establishments, such as the one over which the late Dr. Eichler presided, and which greatly extended its reputation during the nine years he was Director.

Dr. Eichler was barely forty-eight years of age, but before entering upon the absorbing duties connected with the University and Botanic Garden of Berlin he had already made a name as a botanical author.

For some years he was assistant to Von Martius at Munich, and succeeded him as editor of the colossal "Flora Brasiliensis," now nearly completed. This was in 1868, but he had previously been a considerable and excellent contributor to this work, having elaborated several difficult families in a masterly manner. The work by which he is more generally known is the "Blüthendiagramme," in which he admirably illustrates and explains the morphology and organogeny of the Phanerogamia. His labours were chiefly in the direction of morphology. His continued careful study of the female flower of the Coniferæ may be regarded as having finally settled the homologies of the different elements of the inflorescence of that family. One of his later contributions to science, if not his last, is entitled "Zur Entwicklungsgeschichte der Palmenblätter," in which the author fully elucidates the development of the various types of leaf in the Palmae.

As a lecturer Dr. Eichler was exceedingly popular and successful; and he was regarded as an able administrator of the Botanic Garden. He was successively Professor of Botany at Munich, Gratz, Kiel, and Berlin, having been appointed to the last post in 1878. Two years later, "at the comparatively youthful age of thirty-nine," he was chosen a member of the Berlin Academy of Sciences; and in 1881 he was elected Foreign Member of the Linnean Society of London. He was also honorary and corresponding member of many other learned societies; and all who knew him, however slightly, will join in regretting his early death.

NOTES

BARON EGGERS, commissioned by Dr. Urban and assisted by the Royal Academy of Sciences of Berlin, is about to undertake the botanical investigation of the hitherto unexplored higher mountains of St. Domingo. The specimens collected for distribution will be arranged (under corresponding numbers) in two series. One will consist only of species which have not yet been distributed in Baron Eggers' West Indian collections; the other and larger series will include everything except the commonest tropical species. The first-named series will be disposed of at forty shillings per century, the latter at thirty shillings. Dr. J. Urban, assisted by other systematists, will determine the collections and receive the names of subscribers. As the expense and difficulty of transit in the island must limit the number of collections for sale, early application to Dr. Urban is desirable. Dr. Urban's address is Friedenau, bei Berlin.

A CONVERSAZIONE given by the Council of the City and Guilds of London Institute was held at the Central Institution, Exhibition Road, on Wednesday evening, the 16th inst., and was attended by about 1300 visitors. Lord Selborne received the guests. A large number of interesting objects of scientific and artistic interest were exhibited, and during the evening demonstrations were given by the Professors in the various departments, as well as by several gentlemen who are associated with the work of the Institute.

ON the 15th inst. a meeting was held at Grimsby to consider the expediency of establishing there an Institution for Technical Education with regard to Fish and Fisheries, and a Marine Fish-Culture Station. Mr. W. Oldham Chambers, Secretary of the National Fish-Culture Association, pointed out to the meeting the advantages of the proposed Station and Institute. Resolutions in support of the scheme were unanimously adopted,

and an influential local Committee was appointed to further the object in view. Letters have been received from the various Fish Trade Associations and other bodies, heartily approving of the undertaking. The Manchester, Sheffield, and Lincolnshire Railway Company are prepared to grant a site for the Institute, and to erect a building, free of cost, at Cleethorpe, near Grimsby.

WE are sorry to see that the income of the Mason Science College, Birmingham, during the year ending "Founder's Day," February 23, fell short of the expenditure by the sum of 1646/. After deducting what may be termed extraordinary expenditure, there remained a deficiency of 1074/. The Council, in their last report, remind the Trustees that the annual deficits, which since 1881 have been charged against the accumulated surplus, have now reduced this fund to the sum of 1419/, and that the estimates for the current financial year anticipate that the balance of the fund will be required. It is not creditable to the well-off citizens of Birmingham that an institution capable of doing great work for their town and district should have to meet these constantly recurring deficiencies.

THE spring meeting of the Institution of Mechanical Engineers, under the presidency of Mr. E. H. Carbutt, will take place on Monday, May 16, and the following day. On Tuesday, May 17, the Duke of Cambridge will dine with the members of the Institution.

IN order to determine between the rival sites for the Sedgwick Memorial Museum at Cambridge, and at the same time advance the chances of proceeding early with a portion at least of the building, the Council of the Senate propose to submit a grace next term to settle the question of site. The grace will take the form of authorising negotiations with Downing College for a site opposite the old Botanic Garden. If this be rejected, the latter affords the only practicable site.

MISS GORDON has presented to the Museum of the Royal Gardens, Kew, the collections and drawings made by her late brother, General Gordon, illustrative of the *Coco de Mer* (*Lodoicea seychellarum*), a palm peculiar to the Seychelles, and remarkable, among other things, for possessing the largest known seed in the vegetable kingdom. The seeds are well known in European museums. One amongst General Gordon's specimens is a model which he had made of the fruit in its mature state, before the external fibrous but perishable husk had become detached. Some of the specimens are placed, with others already possessed by Kew, in No. 2 Museum. The rest will be shown, with the drawings made by his own hand, in No. 3 Museum.

THE Cambridge University Local Examination Report for the past year states that in zoology and physiology the answers showed very inefficient teaching. Botany is somewhat better done; but many senior candidates had not been taught the use of floral diagrams. In physical geography, while the answering was generally good, many had used antiquated text-books. Chemistry was fairly done, the candidates choosing, out of the alternative questions, the practical rather than the theoretical. Qualitative analysis was well done, both by seniors and juniors. The seniors showed general ignorance about the laws of multiple proportion, and combination by volume. Heat was badly done by both seniors and juniors. Many seemed never to have read any text-book, and to have presented themselves on the strength of a few isolated facts. Statics was very unequally mastered. There was better acquaintance with the mathematical than with the practical part of the subject. Electricity (senior subject) had not been studied seriously enough to warrant its inclusion in the examination. The mathematical subjects of the examination are reported on much more favourably.

THE botanical collections of the late Thomas Moore, F.L.S., curator of the Botanic Garden at Chelsea, belonging to the Society of Apothecaries, have been acquired for the Herbarium of the Royal Gardens, Kew. The most important portions are:—(1) The general fern herbarium, which contains the types of the numerous species described by Moore, especially those introduced into European cultivation. (2) The collection of ferns and varieties of British ferns, which is probably unique in richness and completeness; it is especially interesting as the basis of Mr. Moore's well-known and beautifully illustrated works on the fern flora of the British Isles. (3) The fern herbarium of R. Heward, F.L.S., which is especially strong in the best Indian species.

BRITISH field botanists will be glad to learn that the Scottish Society of Way Society has been successful in its action brought before the Court of Session against the proprietor of Glen Doll in Argyre. Lord Kinnear has found that "the pursuers had established a sufficient use and possession of the road for more than twenty years to entitle them to a judgment." There is probably a portion of the Highlands of Scotland from which botanists would feel it a greater hardship to be excluded. For years it has been so well watched by keepers that access to it has been impossible, except to such botanists as are swift and sure of foot. The present owner is the first who has denied a right of way through it, and, if we are not mistaken, the action only determines this right to use the road. It is to be feared that sportsmen will not be wanting to confine the public to the road, and to deny all access to those parts so interesting to the field botanist.

A SERIES of charts showing the surface temperatures of the Atlantic coast waters, from the eastern coast of Maine to the extreme southerly coast of Florida, is being prepared by the United States Fish Commission. The Commission is aided in this important undertaking by the Lighthouse Board and the Signal Service. Observations have thus far been made at twenty-four lighthouse stations, showing the surface temperatures at these localities during the past five years. The temperatures at each station are shown in detail for each year by ten-day means, and the facts are combined with those brought out on a series of isothermal charts giving the relations of the different stations. The results are likely to be of great value in connexion with the study of the migration of the mackerel, menhaden, cod, and other migratory fishes.

AN interesting discussion has just been started in the Paris Academy of Medicine, concerning the bad results of mental training in young persons. Attention has especially been called to the fact that many French girls, under the pressure of competition, are injuring their health by over-work at school. About 12,000 of them are trying to get the superior diploma which would confer upon them the right of getting an appointment in Government schools. Only 2000 will be able to get appointments.

AN excellent address on the physical training of girls was recently given by Dr. Rayner W. Batten to the Gloucestershire Branch of the British Medical Association. It is printed in the *British Medical Journal*. Speaking of ladies' Colleges, Dr. Batten says he does not know of more than one that is such a thing as a proper playground, whilst a leading college, if not the first in the country, with abundant means and ample opportunities, makes no pretence of having a playground at all. Dr. Batten urges that drill and calisthenic exercises are not enough. There must be recreation as well, "and at present, in our ladies' Colleges," he says, "the precise, with the exception of tennis, has little of the recreative element in it." Dr. Batten is of opinion that all Colleges

should have playgrounds—large spaces, open to the fresh air and sunlight—that every girl should be made to play, two half-holidays a week at least being given for that purpose, and that the games should be varied, so that girls may not have to go on doing what they are conscious of not doing well. "Every girl will soon find out her strong and weak points in play as well as in work, and if the game is to be a recreation she must be allowed to choose her own form, the only obligation being that she is to play, and that no books or work are to be brought on the playground."

At the meeting of the Essex Field Club on Saturday next, the 26th inst., Prof. Sylvanus P. Thompson will read a paper on William Gilbert, the founder of the science of electricity, and an Essex worthy entitled to rank with Ray among the pioneers of science. Those wishing to attend the meeting should communicate with the Secretary, Buckhurst Hill, Essex.

ON the night of March 7, about 11.30, a brilliant meteor was seen in Dalarlia, in Central Sweden. It was first seen in the north-west, going in a southerly direction, but soon afterwards it changed its course more easterly. Its colour was a brilliant white, and its greatest size about that of the moon. It was lost to sight behind the horizon, leaving only a faint trail behind.

FROM a recent official French Report on oyster-culture in France we learn that the two principal centres are at Arcachon in the south-west and Auray in the north-west. The Bay of Arcachon has since 1854 held a foremost place in oyster-breeding. In 1857 there were twenty parks, or district oyster-beds: in 1865 the number had increased to 297, with an output of over 10,000,000 oysters. At the present time the little bay, which has a total area of 37,500 acres, has oyster-beds covering an area of 15,000 acres, which provide annually about 300,000,000 oysters for consumption. With regard to the oyster-beds at Auray, on the coast of Brittany, these, though not so important as those of Arcachon, have still a considerable output, and, from being exhausted and unproductive when their rehabilitation was first undertaken, have become full to overflowing. In 1876-77 we find that 7,000,000 oysters were placed on the market from Auray; in 1885 the number had risen to over 70,000,000.

THE ideas of M. Victor Meunier with regard to the domestication of apes are discussed in the new number of the *Revue d'Anthropologie* by Madame Clémence Royer, the French translator of Darwin. Madame Royer does not doubt that, under a proper system of training, apes might be made good workers. They lack perseverance, indeed, but in general intelligence they are, she thinks, superior to the dog, the horse, or even the elephant. She points out, however, that it would be necessary to feed domesticated apes with great quantities of fruit, bread, and eggs, that the process of educating them would be costly, and that for many generations they would probably be injuriously affected by the climate of Europe. Her opinion is that, if the experiment is to be made, it should be made first of all in tropical countries, where apes might be taught to labour in connexion with the cultivation of coffee, cocoa, and cotton.

AN interesting paper on "The Application of Gems to the Art of the Goldsmith" was read to the Society of Arts on Tuesday, the 15th inst., by Mr. Alfred Phillips. It is printed in the Society's Journal. Mr. Phillips gives a very favourable account of the capacity of English workmen employed by goldsmiths at the present day. When masters encourage them to depart from the beaten track, they readily adapt themselves, Mr. Phillips says, to work which, ten years ago, would have been sent as a matter of course to specialists on the Continent.

A HEALTH EXHIBITION will be opened in Warsaw on May 15 next.

AN International Agricultural Exhibition of Tools and Implements will be held at Parma in September next.

THE Royal Bavarian Academy of Sciences is collecting the numerous treatises of Joseph Fraunhofer, hitherto dispersed in numberless serials, and is about to publish them in one volume.

PROF. VERNEUIL AND L. H. PETIT have issued the first number of a periodical publication called "Études expérimentales et cliniques sur la Tuberculose." It is published by means of a fund especially raised for the promotion of the study of tuberculosis.

M. H. GADEAU DE KERVILLE has just published a work on evolution. It is entitled "Causeries sur le Transformisme," and contains an exposition of the facts and theories upon which the doctrine of evolution is based.

A BOOK on therapeutics, by M. G. Hayem, Professor in the Paris Medical School, has just been published.

THE February number of the Italian Geographical Bulletin contains a detailed account, by Dr. G. A. Colini, of the rich ethnological collection recently presented to the Prehistoric and Ethnographic Museum of Rome by General Genè, Commander of the Italian possessions on the East Coast of Africa. The collection includes a great variety of objects, such as arms, costumes, implements, ornaments, utensils from Abyssinia, Somali Land, and the Afar (Danakil) country. Amongst them are baking-ovens, braziers, incense-burners, cooking-utensils, pestles for grinding coffee, pepper, durrha, &c.; baskets, matting, veils, robes, loin-cloths, wooden sandals, lamps, swords, match-lock guns, knives, hairpins, &c., illustrating the arts and industries of the East African peoples.

WE have received the four latest Bulletins of the U.S. Geological Survey (Nos. 30-33). No. 30 contains Mr. C. D. Walcott's second contribution to "Studies on the Cambrian Faunas of North America." A systematic review of our present knowledge of fossil insects, including myriapods and arachnids, by Mr. S. H. Scudder, is presented in No. 31; and an elaborate account of mineral springs of the United States, by Dr. A. C. Peale, in No. 32. No. 33 is made up of notes, by Mr. J. S. Diller, on the geology of Northern California.

MR. EDWARD COOKWORTHY ROBINS, whose collected papers on technical education and applied science, buildings and fittings, &c., were reviewed in NATURE some time ago, is now engaged on a general work of reference on the same subject. It will appear shortly under the title of "Technical School and College Buildings," in a quarto volume of about 250 pages, with upwards of 100 full-page illustrations, plates, and maps.

In the Proceedings of the American Antiquarian Society (vol. iv. p. 62) Mr. Frederick W. Putnam gives an account of twelve jade objects found in Nicaragua and Costa Rica, ten of which were ornaments made by cutting celts into halves, quarters, or thirds, a portion of the cutting edge of the celt remaining on each piece. Mr. O. W. Huntington, who was asked to report upon the nature and source of the material of these ornaments, is of opinion that the specimens "are unquestionably Chinese jade." They have, he says, "all the characters of that mineral, although the largest specimen from Costa Rica is rather unusual in its colour, and would not be taken for jadeite at sight." The *American Naturalist*, which calls attention to these facts, thinks "it will now be in order to collate during the next ten years the evidence for and against contact between the Orient and the western shores of America."

SOME interesting notes from Venezuela have lately been contributed by Dr. Ernst, of Caracas, to the Proceedings of the Berlin Anthropological Society. The writer brings together much valuable information as to the manners and customs of the aboriginal population, and about their food, ornaments, implements, weapons, and canoes.

THE additions to the Zoological Society's Gardens during the past week include a Mauge's Dasyure (*Dasyurus maugei* ♀) from Australia, presented by Mr. W. Miller; two White-crowned Pigeons (*Columba leucocephala*) from the West Indies, presented by Lieut.-Colonel Dawkins; two Long-tailed Grass Finches (*Poephila acuticauda*) from Australia, presented by Mr. Walter Burton; an Algerian Tortoise (*Testudo mauritanica*) from North Africa, presented by Mr. J. M. Green; a European Pond Tortoise (*Emys europea*), South European, presented by Mr. Henry Garle; five European Tree Frogs (*Hyla arborea*), European, presented by Mr. F. W. Green; an Axis Deer (*Cervus axis* ♀), a Collared Fruit Bat (*Cynonycteris collaris*), sixteen Puff Adders (*Vipera arietans*), born in the Gardens.

OUR ASTRONOMICAL COLUMN

RESEARCHES ON THE DIAMETER OF THE SUN.—Herr Auwers has published in the *Sitzungsberichte der Königlich Preussischen Akademie der Wissenschaften zu Berlin*, 1886, No. 1, the first part of an elaborate investigation of the value of the sun's diameter as found from meridian observations, and of the apparent variations thereof. The discussion now published refers to variations in the mean annual values only of the diameter. The series of observations discussed are the meridian observations of the sun made at Greenwich, 1851-83; at Washington, 1866-82; at Oxford (Radcliffe Observatory), 1862-83; and at Neuchâtel (transit observations only), 1862-83. The "personal equations" of the various observers are first determined on the supposition that there may be periodic annual variations, both in the horizontal and vertical diameters of the sun, such for instance as have been supposed by Secchi and others to exist, with a period corresponding to the sunspot cycle. The first determination of "personal equation" is therefore made by comparing observations taken in each year with others taken in the same year only. The resulting diameters are, however, such as to convince Herr Auwers that, although inequalities exist in each of the series of observations discussed, their comparison with each other and with the sunspot curve is sufficient to show that they have no connexion either with the latter or with a progressive change, but are most probably due to uncorrected "personal equations." A second determination of these on the assumption that, for some observers at least, they are liable to change, but that the sun's diameter is not subject to annual variation, leads to much more satisfactory results, and is regarded by Herr Auwers as the correct solution of the problem. The effect of personality on the deduced solar diameter, which on the average, for an individual observer, amounts to about 1" (sometimes 3", 4", and even 10"), may be inferred from the fact that the values of the horizontal and vertical diameters of the sun, deduced from thirty-three years' observation with the Greenwich transit-circle, and referred to the mean of Dunkin, Ellis, Criswick, and J. Carpenter, as standard, are respectively 32' 2" 48 and 32' 2" 00; whilst, referred to the mean of fifty-four observers, the same observations give, for the horizontal and vertical diameters respectively, the values 32' 1" 99 and 32' 2" 73.

COMET 1887 b (BROOKS, JANUARY 22).—The following ephemeris for Berlin midnight, is by Dr. R. Spitaler (*Astr. Nach.* No. 2776).

1887	R.A.	Decl.	Brightness
	h. m. s.		
March 24 ...	4 18 8	35 46.5 N.	0.72
26 ...	4 21 20	34 26.1	...
28 ...	4 24 26	33 8.9	0.66
30 ...	4 27 26	31 54.9	...
April 1 ...	4 30 21	30 43.9	0.61
3 ...	4 33 11	29 35.7 N.	...

The brightness on January 24 is taken as unity.

MINOR PLANET No. 262.—This object has been discovered by Valda.

HARVARD COLLEGE OBSERVATORY.—The late Uriah A. Boyden having left property to the value of 230,000 dollars in part for the purpose of astronomical research, the Trustees of the fund have transferred the property to the President and Faculty of Harvard College, in order that the researches proposed by Mr. Boyden may be directed at the Harvard College Observatory. These researches will be supported by a portion of the means of the Observatory, in addition to the trust itself. By the terms of the will the money is to be applied to observations "at such an elevation as to be free, so far as practicable, from the impediments to accurate observations which occur in the observatories now existing, owing to atmospheric influences."

ASTRONOMICAL PHENOMENA FOR THE WEEK 1887 MARCH 27—APRIL 2

FOR the reckoning of time the civil day, commencing at Greenwich mean midnight, counting the hours on to 24, here employed.)

At Greenwich on March 27

Rises, 5h. 49m.; souths, 12h. 5m. 30'.s.; sets, 18h. 22m.; decl. on meridian, 2° 35' N.; Sidereal Time at Sunset, 6h. 41m.
 on (at First Quarter on April 1) rises, 7h. 19m.; souths, 14h. 12m.; sets, 21h. 16m.; decl. on meridian, 9° 44' N.

Planet	Rises	Souths	Sets	Decl. on meridian
	h. m.	h. m.	h. m.	
Mercury	5 19	11 26	17 33	0 40 N.
Venus	6 38	13 47	20 56	12 41 N.
Mars	6 3	12 30	18 57	4 37 N.
Jupiter	20 47*	1 52	6 57	11 28 S.
Saturn	10 39	18 48	2 57*	22 30 N.

* Indicates that the rising is that of the preceding evening and the setting of the following morning.

Occultations of Stars by the Moon (visible at Greenwich)

Star	Mag.	Disap.	Reap.	Corresponding angles from vertex to right for inverted image
		h. m.	h. m.	
μ Ceti	4	18 42	19 35	108 359
71 Tauri	6	20 38	near approach	47 —
θ ¹ Tauri	4½	21 17	22 13	117 335
θ ² Tauri	4½	21 26	22 8	91 0
75 Tauri	6	21 46	near approach	226 —
B.A.C. 1391	5	22 16	23 7	159 288
85 Tauri	6	23 12	near approach	42 —
115 Tauri	6	0 9	0 45	173 258
B.A.C. 2731	6½	21 20	22 30	111 288

h. o ... Venus in conjunction with and 4° 50' north of the Moon.

h. 22 ... Saturn in conjunction with and 3° 23' north of the Moon.

Variable Stars

Star	R.A.	Decl.	h. m.
	h. m.		
Pol	3 0'8	40 31 N.	Mar. 28, 19 3 m
eminorum	6 57'4	20 44 N.	" 30, 22 0 m
libræ	14 54'9	8 4 S.	" 30, 22 21 m
Coronæ	15 13'6	32 4 N.	" 30, 22 43 m
Herculis	16 20'8	19 9 N.	Apr. 1, m
Phiuchi	17 10'8	1 20 N.	Mar. 28, 4 58 m
		and at intervals of 20 8	
Sagittarii	17 57'8	29 35 S.	Mar. 29, 3 0 M
Lyre	18 51'9	43 48 N.	" 31, m
quillæ	19 46'7	0 43 N.	Apr. 2, 2 0 M
agittæ	19 50'9	16 20 N.	" 2, 4 0 M
Quarii	20 44'0	5 34 S.	Mar. 28, m
Cephei	21 8'1	68 2 N.	" 31, M
ephei	22 25'0	57 50 N.	" 28, 2 0 m

M signifies maximum; m minimum.

GEOGRAPHICAL NOTES

IN a recently-issued Colonial Office Report on the Gambia will be found some useful data on the climate of that colony which completely upset the results of previous observations and greatly reduce the temperatures hitherto accepted. The mean temperature, according to these latest observations, varies from 68°·5 in January to 80° in July at 7 a.m., and from 73°·7 in January to 82°·5 in July at noon. The same Report contains some interesting statements relating to the ethnology of the colony.

THE principal paper in the just-issued Bulletin (only No. 4 of 1885) of the American Geographical Society is on the historical and geographical features of the Rocky Mountain Railways, by Mr. James Douglass. There is also a translation of Baron Nordenskjöld's reply to criticisms on the "Voyage of the Vega." The criticisms relate to points of minor importance.

THE new number of the "Antananarivo Annual and Madagascar Magazine" (Christmas, 1886), consists, besides a reprint of Mr. A. R. Wallace's chapter on the fauna of Madagascar, mainly of papers on linguistic topics and on Malagasy folk-lore. M. Grandidier's paper on the channels and lagoons of the east coast of the island is translated with some interesting remarks by Mr. Sibree appended. Mr. Sibree points out that it would only require about thirty miles of canals to connect all these lagoons and so create a safe and extensive internal waterway of the greatest commercial value. The Rev. W. Montgomery contributes a paper on the Malagasy game of "Fanerana," in many respects resembling chess.

IN the new number (Heft i. Band 10.) of the *Deutsche Geographische Blätter*, we find a useful and careful, if rather too favourable, study of the trade-routes of Mexico, old and new, and their commercial importance, by Herr A. Scobel. From a scientific point of view the most valuable paper is that of Dr. Otto Finsch on his visit three years ago to the atoll of Diego Garcia in the Chagos Archipelago, about half-way between the Seychelles and Ceylon. Dr. Finsch was only a few hours on the islands, but his notes on the people (mostly of the Negro type from the Mauritius) and the richness of the bird life are interesting. An open space in the little east island was covered with "millions" of birds, whose combined cry was deafening. Eggs, also in "millions," lay about everywhere, unprotected by any nest. The commonest among these birds was the sooty tern (*Sterna fuliginosa*). Next to the Laccadives, the Chagos Islands seem to be the favourite breeding-place of this bird in the Indian Ocean. The variety in the colouring of the eggs was unprecedented in Dr. Finsch's experience, especially considering the fact that they all belonged to birds of the one species named above. The only other species noticed in the island by Dr. Finsch was the noddy (*Anous stolidus*). The birds arrive in the islands in the month of June, and stay till the young are fledged; by November they have all taken their departure. As on most coral islands, the animal world generally is very poor.

THE same number contains an account of Fontana's exploration of Eastern Patagonia in 1885, and also a short biography of Emin Pasha. From the latter we learn that Edward Schnitzer was born at Oppeln, in Silesia, in 1840; received his early education at Neisse, in Upper Silesia, and studied medicine at Breslau, Berlin, and Königsberg. From his earliest years he had a special taste for natural history, and especially ornithology, and in the latter department he has all along been a diligent collector. In 1864 we find Schnitzer at Antivari, in Albania, as a surgeon in the Turkish service. In 1870 he accompanied Ismail Pasha to Syria and Arabia, and afterwards to Trebizond, Erzeroum, and Epirus. At Ismail's death in 1874, Schnitzer came to Constantinople, and in 1875 made a short visit to his German home. Entering the Egyptian service, he, in 1876, followed Gordon Pasha from Cairo into the Soudan, where, under the title of Emin Effendi, he was appointed chief surgeon, and in 1878 Governor-General of the Equatorial Province, with the title of Bey. His work as administrator, scientific explorer, and collector, since then is well known. To Bremen and Vienna he has sent some 2000 bird-skins, carefully labelled with all necessary information, and including some twenty-five new species.

SINCE the time of Herodotus travellers in Africa have brought home reports of pygmy tribes scattered about in various regions of Africa. Readers of Schweinfurth will remember the Akkas

whom he met in the Monbattu country, and now Dr. Ludwig Wolf, who, with Wissmann, recently explored the Sankuru, the great southern tributary of the Congo, gives us many details of a similar pygmy race among whom he sojourned for some time, in the district to the north-west of the station Luluaburg. He found entire villages inhabited by tiny men and women, of a height of not more than 1.40 metre. Among their neighbours they are known as Batua. These are nomad tribes devoting themselves exclusively to the chase and the manufacture of palm wine. Their villages, consisting of huts, are met with in clearings in the forests which cover the greater part of the country. Each district thus possesses a village of pygmies. As is the case of the Akkas among the Monbutus, so the Batua among the Bakubu are regarded as little benevolent beings whose special mission is to provide the tribes among whom they sojourn with game and palm-wine. In exchange, manioc, maize, and bananas are given to the pygmies. Generally they live apart, but sometimes they unite themselves with races of larger stature. They excel in the art of scaling palm-trees to collect the sap, and in setting traps for game. Their agility is almost incredible. In hunting they bound through the high grass like grasshoppers, facing the elephant, antelope, and buffalo with the greatest audacity, shooting their arrows with rare precision, following up rapidly with a stroke of the lance. Physically the Batua are very well made, having absolutely no deformity. They are simply little men, well proportioned, very brave, and very cunning. Their mean height is 1.30 metre. Their skin is a yellow-brown, less dark than that of larger races. Their hair is short and woolly. Neither the Akkas nor the Batua have any beard.

SUNLIGHT COLOURS¹

SUNLIGHT is so intimately woven up with our physical enjoyment of life that it is perhaps not the most uninteresting subject that can be chosen for what is—perhaps somewhat pedantically—termed a Friday evening “discourse.” Now, no discourse ought to be possible without a text on which to hang one’s words, and I think I found a suitable one when walking with an artist friend from South Kensington Museum the other day. The sun appeared like a red disk through one of those fogs which the east wind had brought, and I happened to point it out to him. He looked, and said, “Why is it that the sun appears so red?” Being near the railway station, whither he was bound, I had no time to enter into the subject, but said if he would come to the Royal Institution this evening I would endeavour to explain the matter. I am going to redeem that promise, and to devote at all events a portion of the time allotted to me in answering the question why the sun appears red in a fog. I must first of all appeal to what everyone who frequents this theatre is so accustomed, viz. the spectrum; I am going not to put it in the large and splendid stripe of the most gorgeous colours before you with which you are so well acquainted, but my spectrum will take a more modest form of purer colours some twelve inches in length.

I would ask you to notice which colour is most luminous. I think that no one will dispute that in the yellow we have the most intense luminosity, and that it fades gradually in the red on the one side and in the violet on the other. This then may be called a qualitative estimate of relative brightnesses; but I wish now to introduce to you what was novel last year, a quantitative method of measuring the brightness of any part.

Before doing this I must show you the diagram of the apparatus which I shall employ in some of my experiments.

RR are rays (Fig. 1) coming from the arc light, or, if we were using sunlight, from a heliostat, and a solar image is formed by a lens, L_1 , on the slit S_1 of the collimator c. The parallel rays produced by the lens L_2 are partially refracted and partially reflected. The former pass through the prisms P_1P_2 , and are focused to form a spectrum by a lens, L_3 , on D, a movable ground glass screen. The rays are collected by a lens, L_4 , tilted at an angle as shown, to form a white image of the near surface of the second prism on F.

Passing a card with a narrow slit, S_2 , out in front of the spectrum, any colour which I may require can be isolated. The consequence is that, instead of the white patch upon the screen, I have a coloured patch, the colour of which I can alter to

any hue lying between the red and the violet. Thus, then, we are able to get a real patch of very approximately homogeneous light to work with, and it is with these patches of colour that I shall have to deal. Is there any way of measuring the brightness of these patches? was a question asked by General Festing and myself. After trying various plans, we hit upon the method I shall now show you, and if anyone works with it he must become fascinated with it on account of its almost childish simplicity—a simplicity, I may remark, which it took us some months to find out. Placing a rod before the screen, it casts a black shadow surrounded with a coloured background. Now I may cast another shadow from a candle or an incandescence lamp, and the two shadows are illuminated, one by the light of the coloured patch and the other by the light from an incandescence lamp which I am using to-night. [Shown.] Now one stripe is evidently too dark. By an arrangement which I have of altering the resistance interposed between the battery and the lamp, I can diminish or increase the light from the lamp, first making the shadow it illuminates too light and then too dark compared with the other shadow which is illuminated by the coloured light. Evidently there is some position in which the shadows are equally

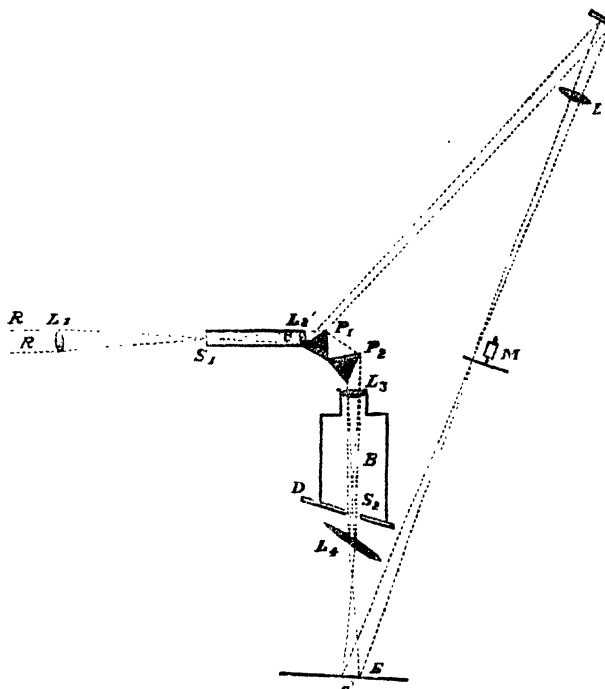

FIG. 1.—Colour Photometer.

luminous. When that point is reached, I can read off the current which is passing through the lamp, and having previously standardised it for each increment of current, I know what amount of light is given out. This value of the incandescence lamp I can use as an ordinate to a curve, the scale number which marks the position of the colour in the spectrum being the abscissa. This can be done for each part of the spectrum, and so a complete curve can be constructed which we call the illumination curve of the spectrum of the light under consideration.

Now, when we are working in the laboratory with a steady light, we may be at ease with this method, but when we come to working with light such as the sun, in which there may be constant variation owing to passing, and maybe usually imperceptible, mist, we are met with a difficulty; and in order to avoid this, General Festing and myself substituted another method, which I will now show you. We made the comparison light part of the light we were measuring. Light which enters the collimating lens partly passes through the prisms and is partly reflected from the first surface of the prism; that we utilise, thus giving a second shadow. The reflected

¹ Lecture delivered by Capt. W. de W. Abney, R.E., F.R.S., at the Royal Institution, on February 25, 1887.

from P_1 fall on G , a silver-on-glass mirror. They are colored by L_2 , and form a white image of the prism also at F . The method we can adopt of altering the intensity of the comparison light is by means of rotating sectors, which can be opened or closed at will, and the two shadows thus made equally intense. [Shown.] But although this is an excellent plan for some purposes, we have found it better to adopt a different method. You will recollect that the brightest part of the spectrum is in the yellow, and that it falls off in brightness on either side, so, instead of opening and closing the sectors, they are at fixed intervals, and the slit is moved in front of the spectrum, just making the shadow cast by the reflected beam too dark or too light, and oscillating between the two till equality is restored. The scale number is then noted, and the curve constructed as before. It must be remembered that, on each side of the yellow, equality can be established.

This method of securing a comparison light is very much better for sun work than any other, as any variation in the light of the spectrum is to be measured affects the comparison light to the same degree. Thus, suppose I interpose an artificial shadow before the slit of the spectroscope, having adjusted the shadows, it will be seen that the passage of steam in front of the slit does not alter the relative intensities; but this result is to be received with caution. [The lecturer then proceeded to point out the contrast colours that the shadow of the rod illuminated by white light assumed.]

You must now make a digression. It must not be assumed that everyone has the same sense of colour, otherwise there would be no colour-blindness. Part of the researches of General Festing and myself have been on the subject of colour-blindness, and these I must briefly refer to. We test all who come by making them match the luminosity of colours with white light, as we have now shown you; and as a colour-blind person has only two fundamental colour-perceptions instead of three, his matching of luminosities is even more accurate than is that made by those whose eyes are normal or nearly normal. It is curious to note how many people are more or less deficient in colour-perception. Some have remarked that it is impossible that they were colour-blind, and would not believe and sometimes we have been staggered at first with the remarkable manner in which they recognised colour to which they ultimately proved deficient in perception. For instance, a gentleman when I asked him the name of a red colour which he said it was sunset colour; he then named green and blue correctly, but when I reverted to the red patch he said no. On testing further he proved totally deficient in the perception of red, and with a brilliant red patch he perceived almost a black shadow. The diagram shows you the relative perceptions in the spectrum of this gentleman and myself. There are others who only see three-quarters, others half, others a quarter the amount of red that we see, whilst some see none. Others see less green and others less violet, but I have met with no-one that can see more than myself or General Festing, whose colour-perceptions are almost identical. Hence we have called our curve of illumination the "normal curve."

We have tested several eminent artists in this manner, and about one-half of the number have been proved to see only three-quarters of the amount of red which we see. It might be thought that this would vitiate their powers of matching colour, but it is not so. They paint what they see, and although they see less in a subject, they see the same deficiency in their pigments; and if they are correct. If totally deficient, the case of course would be different.

Let us carry our experiments a step further, and see what effect is known as a turbid medium has upon the illuminating curve of different parts of the spectrum. I have here water which has been rendered turbid in a very simple manner. In it I have been very cautiously dropped an alcoholic solution of mastic. Mastic is practically insoluble in water, and directly the alcoholic solution comes in contact with the water it separates in very fine particles, which, from their very fineness, remain suspended in the water. I propose now to make an experiment with this turbid water.

I place a glass cell containing water in front of the slit, and the screen I throw a patch of blue light. I now change it for turbid water in a cell. This thickness much less than the blue; with a still greater thickness the blue has almost gone. If I measure the intensity of the light at the operation, I shall find that it diminishes according to a certain law, which is of the same nature as the

law of absorption. For instance, if one inch diminishes the light one-half, the next will diminish it half of that again, the next half of that again, whilst the fourth inch will cause a final diminution of the total light of one-sixteenth. If the first inch allows only one-quarter of the light, the next will only allow one-sixteenth, and the fourth inch will only permit $1/256$ part to pass. Let us, however, take a red patch of light and examine it in the same way. We shall find that, when the greater thickness of the turbid medium we used when examining the blue patch of light is placed in front of the slit, much more of this light is allowed to pass than of the blue. If we measure the light we shall find that the same law holds good as before, but that the proportion which passes is invariably greater with the red than the blue. The question then presents itself: Is there any connection between the amounts of the red and the blue which pass? Lord Rayleigh, some years ago, made a theoretical investigation of the subject; but, as far as I am aware, no definite experimental proof of the truth of the theory was made till it was tested last year by General Festing and myself. His law was that for any ray, and through the same thickness, the light transmitted varied inversely as the fourth power of the wave-length. The wave-length 6000 lies in the red, and the wave-length 4000 in the violet. Now 6000 is to 4000 as 3 to 2, and the fourth powers of these wave-lengths are as 81 to 16, or as about 5 to 1. If, then, the four inches of our turbid medium allowed three-quarters of this particular red ray to be transmitted, they would only allow $(\frac{3}{4})^4$, or rather less than one-fourth, of the blue ray to pass. Now this law is not like the law of absorption for ordinary absorbing media, such as coloured glass for instance, because here we have an increased loss of light running from the red to the blue, and it matters not how the medium is made turbid, whether by varnish, suspended sulphur, or what not. It holds in every case, so long as the particles which make the medium turbid are small enough; and please to recollect that it matters not in the least whether the medium which is rendered turbid is solid, liquid, or air. Sulphur is yellow in mass, and mastic varnish is nearly white, whilst tobacco-smoke when condensed is black, and very minute particles of water are colourless: it matters not what the colour is, the loss of light is *always* the same. The result is simply due to the scattering of light by fine particles, such particles being small in dimensions compared with a wave of light. Now, in this trough is suspended $1/1000$ of a cubic inch of mastic varnish, and the water in it measures about 100 cubic inches, or is 100,000 times more in bulk than the varnish. Under a microscope of ordinary power it is impossible to distinguish any particles of varnish: it looks like a homogeneous fluid, though we know that mastic will not dissolve in water. Now a wave-length in the red is about $1/40,000$ of an inch, and a little calculation will show that these particles are well within the necessary limits. Prof. Tyndall has delighted audiences here with an exposition of the effect of the scattering of light by small particles in the formation of artificial skies, and it would be superfluous for me to enter more into that. Suffice it to say that when particles are small enough to form the artificial blue sky they are fully small enough to obey the above law, and that even larger particles will suffice. We may sum up by saying that very fine particles scatter more blue light than red light, and that consequently more red light than blue light passes through a turbid medium, and that the rays obey the law prescribed by theory. I will exemplify this once more by using the whole spectrum and placing this cell, which contains hyposulphite of soda in solution in water, in front of the slit. By dropping in hydrochloric acid, the sulphur separates out in minute particles; and you will see that, as the particles increase in number, the violet, blue, green, and yellow disappear one by one and only red is left, and finally the red disappears itself.

Now let me revert to the question why the sun is red at sunset. Those who are lovers of landscape will have often seen on some bright summer's day that the most beautiful effects are those in which the distance is almost of a match to the sky. Distant hills, which when viewed close to are green or brown, when seen some five or ten miles away appear of a delicate and delicious, almost of a cobalt, blue colour. Now, what is the cause of this change in colour? It is simply that we have a sky formed between us and the distant ranges, the mere outline of which looms through it. The shadows are softened so as almost to leave no trace, and we have what artists call an atmospheric effect. If we go into another climate, such as Egypt or amongst the high Alps, we usually lose this effect. Distant mountains stand out crisp with black shadows, and the want of atmosphere

is much felt. [Photographs showing these differences were shown.] Let us ask to what this is due. In such climates as England there is always a certain amount of moisture present in the atmosphere, and this moisture may be present as very minute particles of water—so minute indeed that they will not sink down in an atmosphere of normal density—or as vapour. When present as vapour the air is much more transparent, and it is a common expression to use, that when distant hills look “so close” rain may be expected shortly to follow, since the water is present in a state to precipitate in larger particles; but when present as small particles of water the hills look very distant, owing to what we may call the haze between us and them. In recent weeks everyone has been able to see very multiplied effects of such haze. The ends of long streets, for instance, have been scarcely visible though the sun may have been shining, and at night the long vistas of gas lamps have shown light having an increasing redness as they became more distant. Everyone admits the presence of mist on these occasions, and this mist must be merely a collection of intangible and very minute particles of suspended water. In a distant landscape we have simply the same or a smaller quantity of street-mist occupying, instead of perhaps 1000 yards, ten times that distance. Now I would ask, What effect would such a mist have upon the light of the sun which shone through it?

It is not in the bounds of present possibility to get outside our atmosphere and measure by the plan I have described to you the different illuminating values of the different rays, but this we can do:—First, we can measure these values at different altitudes of the sun, and this means measuring the effect on each ray after passing through different thicknesses of the atmosphere, either at different times of day, or at different times of the year, about the same hour. Second, by taking the instrument up to some such elevation as that to which Langley took his bolometer at Mount Whitney, and so to leave the densest part of the atmosphere below us. Now, I have adopted both these plans. For more than a year I have taken measurements of sunlight in my laboratory at South Kensington, and I have also taken the instrument up to 8000 feet high in the Alps, and made observations there, and with a result which is satisfactory in that both sets of observations show that the law which holds with artificially turbid media is under ordinary circumstances obeyed by sunlight in passing through our air: which is, you will remember, that more of the red is transmitted than of the violet, the amount of each depending on the wave-length. The luminosity of the spectrum observed at the Riffel I have used as my standard luminosity, and compared all others with it. The result for four days you see in the diagram.

I have diagrammatically shown the amount of different colours which penetrated on the same days, taking the Riffel as ten. It will be seen that on December 23 we have really very little violet and less than half the green, although we have four-fifths of the red.

The next diagram before you shows the minimum loss of light which I have observed for different air thicknesses. On the top we have the calculated intensities of the different rays outside our atmosphere. Thus we have that through one atmosphere, and two, three, and four; and you will see what enormous absorption there is in the blue end at four atmospheres. The areas of these curves, which give the total luminosity of the light, are 761, 662, 577, 503, and 439; and if observed as astronomers observe the absorption of light, by means of stellar observations, they would have had the values, 761, 664, 578, 504, and 439—a very close approximation one to the other.

Next notice in the diagram that the top of the curve gradually inclines to go to the red end of the spectrum as you get the light transmitted through more and more air, and I should like to show you that this is the case in a laboratory experiment. Taking a slide with a wide and long slot in it, a portion is occupied by a right-angled prism, one of the angles of 45° being towards the centre of the slot. By sliding this prism in front of the spectrum I can deflect outwards any portion of the spectrum I like, and by a mirror can reflect it through a second lens, forming a patch of light on the screen overlapping the patch of light formed by the undeflected rays. If the two patches be exactly equal, white light is formed. Now, by placing a rod as before in front of the patch, I have two coloured stripes in a white field, and though the background remains of the same intensity of white, the intensities of the two stripes can be altered by moving the right-angled prism through the spectrum. The two stripes are

now apparently equally luminous, and I see the point of equality is where the edge of the right-angled prism is in the green. Placing a narrow cell filled with our turbid medium in front of the slit, I find that the equality is disturbed, and I have to allow more of the yellow to come into the patch formed by the blue end of the spectrum, and consequently less of it in the red end. I again establish equality. Placing a thicker cell in front, equality is again disturbed, and I have to have less yellow still in the red half, and more in the blue half. I now remove the cell, and the inequality of luminosity is still more glaring. This shows, then, that the rays of maximum luminosity must travel towards the red as the thickness of the turbid medium is increased.

The observations at 8000 feet, here recorded, were taken on

FIG. 2.—Relative Luminosities.

September 15 at noon, and of course in latitude 46° the sun could not be overhead, but had to traverse what would be almost exactly equivalent to the atmosphere at sea-level. It is much nearer the calculated intensity for no atmosphere intervening, than it is for one atmosphere. The explanation of this is easy. The air is denser at sea-level than at 8000 feet up, and the lower stratum is more likely to hold small water particles or dust in suspension than is the higher.

For, however small the particles may be, they will have a greater tendency to sink in a rare air than in a denser one, and less water vapour can be held per cubic foot. Looking, then, from my

FIG. 3.—Proportions of Transmitted Colours.

laboratory at South Kensington, we have to look through a proportionately larger quantity of suspended particles than we have at a high altitude when the air thicknesses are the same; and consequently the absorption is proportionately greater at sea-level than at 8000 feet high. This leads us to the fact that the real intensity of illumination of the different rays outside the atmosphere is greater than it is calculated from observations near sea-level. Prof. Langley, in this theatre, in a remarkable and interesting lecture, in which he described his journey up Mount Whitney to about 12,000 feet, told us that the sun was really blue

our atmosphere, and at first blush the amount of extra which he deduced to be present in it would, he thought, so; but though he surmised the result from experiments with rotating disks of coloured paper, he did not, I think, method of using pure colours, and consequently, I slightly exaggerated the blueness which would result. taken Prof. Langley's calculations of the increase of for the different rays, which I may say do not quite with mine, and I have prepared a mask which I can the spectrum giving the different proportions of each ray lated by him, and this when placed in front of the spectr show you that the real colour of sunlight outside the here, as calculated by Langley, can scarcely be called

Alongside I place a patch of light which is very the colour of sunlight on a July day at noon in England. mparison will enable you to gauge the blueness, and you that it is not very blue, and, in fact, not bluer per- than that we have at the Riffl, the colour of the at which place I show in a similar way. I have also some screens to show you the value of sunlight after through five and ten atmospheres. On an ordinary clear will see what a yellowness there is in the colour. It hat after a certain amount of blue is present in white e addition of more makes but little difference in the tint. e last patches show that the light which passes through osphere when it is feebly charged with particles does ce the red of the sun as seen through a fog. It only more suspended particles in any thickness to induce it. servations made at the Riffl, and at 14,000 feet, I have at it is possible to see far into the ultra-violet, and to ink and measure lines in the sun's spectrum which can ly only be seen by the aid of a fluorescent eye-piece eans of photography. Circumstantial evidence tends that the burning of the skin, which always takes place high altitudes in sunlight, is due to the great increase ultra-violet rays. It may be remarked that the same burning is effected by the electric arc light, which is to be very rich in these rays.

ly, to use a homely phrase, "You cannot eat your cake e it." You cannot have a large quantity of blue rays present direct sunlight, and have a luminous blue sky. The latter ways be light scattered from the former. Now, in the ps you have, on a clear day, a deep blue-black sky, very indeed from the blue sky of Italy or of England; and the sky which is the chief agent in lighting up the s, not only in those regions do we have dark shadows out of no intervening—what I will call—mist, but the sky itself is so little luminous. In an artistic point this is important. The warmth of an English landscape ht is due to the highest lights being yellowish, and to lows being bluish from the sky-light illuminating them. igh Alps the high lights are colder, being bluer, and lows are dark, and chiefly illuminated by reflected direct

Those who have travelled abroad will know what the A painting in the Alps, at any high elevation, is leasing, although it may be true to Nature. It looks d somewhat harsh and blue.

London we are often favoured with easterly winds, e, unpleasant in other ways, are also destructive portion of the sunlight which is the most chemically s living organisms. The sunlight composition of a ay, by the prevalence of an easterly wind, be reduced to November day, as I have proved by actual measurement. ase it is not the water particles which act as scatterers, carbon particles from the smoke.

ring, then, the cause of the change in the colour ght, we can make an artificial sunset, in which we imitation light passing through increasing thicknesses rged with water particles. [The image of a circuh- rgram placed in front of the electric light was thrown on en in imitation of the sun, and a cell containing hypo- of soda placed in the beam. Hydrochloric acid was led: as the fine particles of sulphur were formed, the light assumed a yellow tint, and as the decomposition hyposulphite progressed, it assumed an orange and a deep red tint.] With this experiment I terminate are, hoping that in some degree I have answered the I propounded at the outset: why the sun is red when ough a fog.

UNIVERSITY AND EDUCATIONAL INTELLIGENCE

CAMBRIDGE.—From the University accounts for 1886, just issued, we learn that the Mathematical Tripos Examiners are paid 348*l.*; Examiners in Natural Science, 575*l.*; in Medicine and Surgery, 210*l.*; all extremely moderate payments.

Science Professors received 3725*l.* from the University Chest, 1800*l.* from the Common University Fund (derived from tax on the Colleges), besides payments from special endowments; Readers, Demonstrators, and other officers connected with Science and Medicine, 2100*l.* from the University Chest; 1800*l.* from the Common University Fund. Total, 9425*l.* for teachers mainly.

The University Observatory cost 786*l.*, in addition to 164*l.* from the Sheepshanks Fund. The Botanic Garden cost 1223*l.*; the Museums and Lecture Rooms, 4221*l.*, including 100*l.* for Dr. Guillemard's collection of bird-skins from the voyage of the *Marchesa*, 11*l.* for bird-skins bought by Prof. Newton at the Jardine sale, and 8*l.* 10*s.* for a skeleton of a European elk. The Pathological Laboratory cost 167*l.* out of the foregoing amount; the Department of Human Anatomy, 356*l.*; the Woodwardian Museum, 498*l.*; the Chemical Laboratory, 517*l.*; the Cavendish Laboratory, 274*l.*, including 60*l.* for instruments. The new dissecting-room (iron) for Human Anatomy cost 350*l.*, an additional class-room for Physiology 10*l.*, charged to the Museums Reserve Fund.

At Gonville and Caius College, Dr. Shuttleworth's Scholarship of 60*l.* for three years, open to medical students of the University of not less than eight terms' standing, given for proficiency in Botany and Comparative Anatomy, has been awarded to Francis Henry Edgeworth, B.A., Scholar of the College.

SOCIETIES AND ACADEMIES

LONDON

Royal Society, March 3.—"On the Limiting Distance of Speech by Telephone." By William Henry Preece, F.R.S.

The law that determines the distance to which speaking by telephone on land-lines is possible, is just the same as that which determines the number of currents which can be transmitted through a submarine cable in a second.

It is dependent on a time-constant varying with the conditions of the circuit, invariable for the same uniform circuit, but differing for different circuits. It represents the time that elapses from the instant contact is made at the sending-end to the instant that the current begins to appear at the receiving-end. It is given by the following equation:—

$$a = Bkr^2,$$

B being a constant dependent principally on the units used; *k* the inductive capacity per unit length (mile or knot); *r* the resistance per unit length, and *l* the lengths in miles or knots.

The number of reversals which can be produced at the end of a wire per second is quite independent of the impressed E.M.F., and therefore of the strength of the current. But it depends upon the sensitiveness of the apparatus used to receive the currents. This is why such discordant results are obtained by different observers who attempt to measure the velocity of currents of electricity. It is also why the telephone is such an admirable instrument for research—for it is sensitive to the least increment or decrement of current.

The inductive capacity of overhead and underground wires was measured with great care on very dry days in different parts of the country.

The results come out as follows:—

	Capacity per mile, microfarads	Resistance per mile, E.A. ohms
No. 7½ iron wire	0·0168 ...	12·0
No. 12½ copper wire	0·0124 ...	5·7
Gutta-percha-covered wire in iron pipes	0·2500 ...	23·0
Gutta-percha-covered wire in cables	0·2900 ...	10·25

It then became necessary to determine the speed of the current through wires of different lengths, resistances, and capacities.

It was found that, for mixed wires, the speed was given by the equation

$$t = 32 \times 10^{-8} KR,$$

but for copper alone the constant was 22×10^{-8} .

The limiting distance through which it is possible to speak varies inversely with the speed of the current, and that the speed of the current varies inversely with the product of the total resistance and the total capacity of the circuit. Hence the number of reversals that it is possible to send through any circuit varies inversely with the product of the total resistance (R) and the total capacity (K), or the limiting distance—

$$S = KR \times \text{constant} \dots \dots \dots (1)$$

This is only another form of Thomson's law for $K = Lk$, and $R = lr$, and

$$\therefore S = kr^2 \times \text{constant}.$$

If the equation (1) be put into this form,

$$A = krx^2, \dots \dots \dots (2)$$

and A be given the following values:—

Copper (overhead)	15,000
Cables and underground	12,000
Iron (overhead	10,000

the limiting distance (x) through which speech is possible is

$$x^2 = A/kr.$$

There is an interesting consequence of Thomson's law which comes out of these experiments, and that is, whether the line be a single wire completed by the earth, or a double wire making a metallic circuit, the rate of speed between the two ends is exactly the same, and therefore the distance we can speak through is just the same whether we use a single or double wire circuit. This is owing to the fact that though in the latter case we double the total resistance, we halve the total capacity, and therefore the product remains the same.

The difference between copper and iron is clearly due to self-induction, or to the electro-magnetic inertia of the latter, and the difference between copper overground and copper underground is due to the facility that the leakage of insulators offers to the rapid discharge to earth, at innumerable points, of the static charge, which in gutta-percha-covered wire can find an exit only at the ends.

It is also evident that there is no difficulty in working telephones through underground wires, even though they attain fifty miles in length, and in fact it would be better to work underground with proper copper wire from London to Brighton, than to use iron wires along the railway telegraph poles, owing to the absence of external disturbances in the former case.

March 17.—“Second Note on the Geometrical Construction of the Cell of the Honey Bee (Roy. Soc. Proc. vol. xxxix. p. 253, and vol. xii. p. 442).” By Prof. H. Hennessy, F.R.S.

The author deduces from the results established in his communications as above cited that, while the trihedral pyramid at the apex of the cell may be inscribed in a sphere whose diameter, D, is equal to the sum of the three edges of the pyramid, another sphere may be inscribed within the cell touching all of its nine faces and whose diameter, L', is equal to the diameter of the cell, and that between these diameters the following relation exists:—

$$\frac{D}{L'} = \left(\frac{3}{2}\right)^{\frac{2}{3}}.$$

The connexion between the geometrical cell and its inscribed and circumscribing spheres is pointed out as possibly bearing on the mode of formation of the actual cells.

“A Coal-dust Explosion.” By W. Galloway. Communicated by R. H. Scott, M.A., F.R.S.

Zoological Society, March 1.—Prof. W. H. Flower, F.R.S., President, in the chair.—Prof. Jeffrey Bell read extracts from a communication sent to him by Mr. Edgar Thurston, Superintendent of the Government Central Museum, Madras, containing observations on two species of Batrachians of the genus *Cacopus*.—Mr. O. Salvin (on behalf of Mr. F. D. Godman) exhibited a pair of a large and rare Butterfly (*Ornithoptera victoria*), the male of which had been hitherto undescribed. These specimens were obtained at the end of May 1886 by Mr. C. M. Woodford, at North-West Bay, Maleita Island, one of the Solomon group.—Mr. E. B. Poulton read a paper containing an account of his experiments on the protective value of colour and markings in insects (especially in Lepidopterous larvae) in their relation to Vertebrata. It was found that conspicuous insects were nearly always refused by birds and lizards, but that they were eaten in extreme hunger: hence the unpleasant taste failed as a protection under these circumstances.

Further, conspicuous and unpalatable insects, although widely separated, tended to converge in colour and pattern, being thus more easily seen and remembered by their enemies. In the insects protected by resembling their surroundings it was observed that mere size might prevent the attacks of small enemies. Some such insects were unpalatable, but could not be distinguished from the others. In tracing the inedibility through the stages, it was found that no inedible imago was edible in the larval stage; in this stage therefore the unpleasant taste arose.—Mr. G. A. Boulenger read a paper descriptive of the fishes collected by the late Mr. Clarence Buckley in Ecuador. The set of all the species in the collection acquired by the British Museum in 1880 contained a large number of highly interesting and well-preserved specimens. Amongst them were representatives of ten species described as new to science.—Mr. Richard S. Wray, read a note on a vestigial structure in the adult Ostrich representing the distal phalanges of the third digit.—Mr. John H. Ponsoy communicated (on behalf of Mr. Andrew Garrett) the second and concluding part of a paper on the Terrestrial Mollusks of the Viti or Fiji Islands.—Mr. Edgar A. Smith gave an account of a small collection of shells from the Loo-Choo Islands, made by Mr. H. Pryer.

Geological Society, February 18.—Annual General Meeting.—Prof. J. W. Judd, F.R.S., President, in the chair.—Having presented the various medals, and the proceeds of the Donation Funds in the gift of the Society, the President read his Anniversary Address, which we have already printed.—The ballot for the Council and Officers was taken, and the following were duly elected for the ensuing year:—President: Prof. J. W. Judd, F.R.S. Vice-Presidents: H. Bauerman, Prof. T. G. Bonney, F.R.S., A. Geikie, F.R.S., Henry Woodward, F.R.S. Secretaries: W. T. Blanford, F.R.S., and W. H. Hudleston, F.R.S. Foreign Secretary: Warrington W. Smyth, F.R.S. Treasurer: Prof. T. Wiltshire. Council: H. Bauerman, W. T. Blanford, F.R.S., Prof. T. G. Bonney, F.R.S., A. Champernowne, Thomas Davies, Prof. P. M. Duncan, F.R.S., A. Geikie, F.R.S., Henry Hicks, F.R.S., Rev. Edwin Hill, W. H. Hudleston, F.R.S., J. W. Hulke, F.R.S., Prof. T. McKenny Hughes, Prof. T. Rupert Jones, F.R.S., Prof. J. W. Judd, F.R.S., R. Lydekker, J. E. Marr, E. T. Newton, Prof. H. G. Seeley, F.R.S., Warrington W. Smyth, F.R.S., J. J. H. Teall, Prof. T. Wiltshire, Rev. H. H. Winwood, Henry Woodward, F.R.S.

February 23.—Prof. J. W. Judd, F.R.S., President, in the chair.—The following communications were read:—On the origin of dry chalk valleys and of Coombe rock, by Mr. Clement Reid. Whilst engaged in examining the Pleistocene deposits of Sussex, for the Geological Survey, the author observed that the Coombe rock differs from anything commonly seen in the strongly glaciated districts of the Yorkshire and Lincolnshire Wolds. As in these localities, the seaward slope of the South Downs is broken by the line of a partially buried sea-cliff before passing under the low-lying drift areas. Subsequent to the formation of this sea-cliff a mass of angular flint and chalk detritus spread out from the Downs over the low lands, being seldom found far up the valleys. This is the Coombe rock, which passes further on into a worthless mixture of angular flint and loam, and at a still greater distance into almost clean brick-earth. It is not of glacial origin, neither is it marine, nor is it a gravel formed by ordinary fluvial action. The rolling outline of the Downs, and the steep-sided dry valleys point to conditions which have passed away. However much rain may fall, the upper parts of these valleys are always dry, and no running water can be found where the incline of the bottom of the valley exceeds the slope of the plane of saturation—never more than 60 feet per mile. The author discussed the various explanations which have been offered. In suggesting an origin for the dry valleys and Coombe rock, he considers that the fauna and flora, both at Fisherton and Bovey Tracey, point to a great degree of cold, from 20° to 30° lower than what now prevails in the South of England. The ground would thus be frozen to the depth of several hundred feet, and the drainage system of the chalk entirely modified. There would be no underground circulation. The summer rains would immediately run off any steep slope, often in violent torrents. These would tear up the layer of rubble already loosened by the frost, carrying down masses of unthawed chalk too rapidly for solvents to have much effect. No Coombe rock is found in valleys that have a greater slope than 100 feet per mile. There is no need of excessive rainfall; it might have been a dry period corresponding to that of

1. If the time had not been short, all soft rocks in the f England would have been planed down to one gently ing surface like the plains of Russia and Siberia. Such conditions may have occurred more than once.—Probable of former glaciation of Norway, as demonstrated by rest condition of rocks upon and near the western coast, W. F. Stanley.

hematical Society, March 10.—Sir James Cockle, President, in the chair.—The following communications nade:—A metrical property of plane curves, by R. a.—Note on the Weierstrass functions, by Mr. A. G. m.—Second paper on the change of the independent e; with applications to some functions of the reciprocal y C. Leudesdorf.—A note on knots, by Mr. A. B. , F.R.S.

mical Society, March 3.—Dr. Hugo Müller, F.R.S., nt, in the chair.—The following papers were read:— c and racemic acids and the magnetic rotatory power of hyl salts, by Dr. W. H. Perkin, F.R.S.—Anhydracetone- by Mr. Francis R. Japp, F.R.S., and Mr. Cosmo Innes .—Condensation compounds of benzil with ketones, by ne.—Constitution of glycosine, by Mr. Francis R. Japp, , and Mr. E. Cleminshaw.—Diphenylglyoxaline and diphenylglyoxaline, by Mr. Francis R. Japp, F.R.S.— racetic acid, by Dr. W. H. Perkin, Jun.—The colouring- of *Drosera Whitakeri*, by Prof. E. H. Rennie.—Further on the di-haloid derivatives of thiocarbamide, by Dr. McGowan.

thropological Institute, March 8.—Mr. Francis Galton', President, in the chair.—Mr. A. L. Lewis read a paper ne circles near Aberdeen. In this paper Mr. Lewis ed in detail two circles near Dyce and Portlethen ively, and drew particular attention to the fact that they n two important particulars from the circles of Southern . In former papers on stone circles the author had d on the presence of a special reference to the north-east, e these circles the main direction is north and south. re further distinguished from the southern circles by the ice of an oblong stone flanked by two upright stones, is indeed their principal feature, and which exists nowhere in the Aberdeen district, where it is almost universal. wis regarded the Aberdeen circles as having more affinity "giants' graves" found in the north of Ireland, than to glish circles to which it has always been sought to ally .—The following papers were also read:—Palæolithic nents from the drift-gravels of the Singrauli Basin, South ore, by Mr. J. Cockburn.—Stone implements from , by Mr. Abraham Hale.

omological Society, March 2.—Dr. D. Sharp, President, chair.—Mr. Slater exhibited, with the object of showing et of food in causing variation in Lepidoptera, two speci- of *Arctia caja*, one of which was bred from a larva fed on aves, and the other from a larva fed on low plants, the ry pabulum of the species.—Capt. H. J. Elwes exhibited e number of Lepidoptera-Heterocera, caught by him at hing, in Sikkim, at an elevation of 7000 feet, on the night ust 4, 1886, between 9 p.m. and 1 a.m. The specimens ted represented upwards of 120 species, belonging to yces, Noctuæ, Geometræ, Crambida, &c., many of which elieved to be undescribed. Capt. Elwes stated that Mr. Wallace's observations on the conditions most favourable ecting moths in the tropics were fully confirmed by his xperience during four months' collecting in Sikkim and the s. The conditions referred to were a dark wet night in ny season; a situation commanding a large extent of virgin and uncultivated ground; and a whitewashed veranda with ful lamps in it. He also made some remarks on the Khasia he southern slopes of which he believed to be the true habitat greater part of those insects described many years ago by Westwood and others as coming from Sylhet. A discussion l, in which Mr. McLachan, Dr. Sharp, Mr. Champion, Mr. , and others took part.—The Rev. W. W. Fowler exhibited imen of *Cathormiocerus socius*, taken at Sandown, Isle of .—Mr. S. Stevens exhibited specimens of *Cathormiocerus nus* and *Platytrarus hirtus*.—Mr. F. Grut said he was red by M. Péringuey, of Cape Town, to announce that e was engaged on a monograph of the genus *Hipporhinus*, and e would be glad to receive specimens and other assistance

from British entomologists.—Mr. Gervase F. Mathew, R.N., communicated a paper entitled "Descriptions of new species of Rhopalocera from the Solomon Islands."—Mr. G. T. Baker communicated the following papers: "Description of a new species of the Lepidopterous genus *Carama*, together with a few notes on the genus"; and "Description of a new genus of Rhopalocera allied to *Thecla*."

Institution of Civil Engineers, February 22.—Mr. Edward Woods, President, in the chair.—A paper was read on irrigation in Lower Egypt, by Mr. William Willcocks.

March 1.—Mr. Edward Woods, President, in the chair.—A paper was read on dredging-operations and appliances, by Mr. John James Webster. The author described the objects for which dredging-operations are generally carried out, and spoke of the advantage of obtaining the aid of natural scour, when possible, for supplementing or dispensing with dredging. The various kinds of appliances used were fully described.

March 15.—Mr. Edward Woods, President, in the chair.—A paper was read on the treatment of gun-steel, by Colonel Eardly Maitland, R.A.

PARIS

Academy of Sciences, March 14.—M. Janssen, President, in the chair.—Reply to M. Houzeau's additional note, by M. Lœwy. It is argued that M. Houzeau's mistake lies in the arrangement proposed by him in 1871, which is practically that of a sextant with fixed opening. The principle of the sextant is based on the combination of two mirrors, which in virtue of known optical conditions must give it an undoubted superiority over M. Houzeau's apparatus, which is provided with only one mirror.—On a problem relating to the theory of minima surfaces, by M. Gaston Darboux. To the different solutions of the problem given in vol. cii. of the *Comptes rendus* (1886), is here added another which rests on a new genesis of minima surfaces proposed in an important memoir by M. Ribaucour.—On the great movements of the atmosphere, and on M. Colladon's note of March 7, by M. H. Faye. The paper deals with M. Colladon's suggestion, based on M. Weyher's recent experiments, that rotatory movements with vertical axis may have both an ascending and a descending direction, thus presenting a middle term between the extreme views of M. Faye and his opponents.—On the artificial production of the ruby, by M. Fremy. Some remarks are presented on the two processes elaborated by MM. Fremy and Feil, in connexion with the recent death of M. Feil. A third method is referred to which has since been brought to great perfection with the co-operation of M. Verneuil. A paper followed, by MM. Fremy and Verneuil, on the action of the fluorides on alumina in connexion with the same subject.—The small *Ursus spelæus* of Gargas, by M. Albert Gaudry. A description is given of this species of cave-bear, a skeleton of which, made up with the bones of several individuals, has just been mounted in the new room for palæontological specimens in the Natural History Museum.—Details collected from various sources on the earthquake of February 23, by M. F. Fouqué. An account is given of the vibrations recorded at the Observatories of Lisbon, Wilhelmshafen, and Seville; the general conclusion being that the magnetic disturbances were not the cause, but rather the effect, of the shocks.—Report on MM. Guyou and Simart's memoir on the development of naval geometry as applied to the question of the stability of vessels, by the Commissioners, MM. Phillips, Lévy, Sarrau, and de Jonquières. The report speaks favourably of MM. Guyou and Simart's studies, which greatly reduce the elaborate calculations hitherto required to be worked out in determining questions of stability from the theoretical and practical stand-points.—Experiments on the effects of the transfusion of blood into the heads of decapitated animals (second note), by MM. G. Hayem and G. Barrier. The experiments show that the time is limited to about ten seconds, during which it is possible by transfusion of arterial blood to momentarily revive the action of the sensor and motor cortical centres.—On a correlation between earthquakes and the declinations of the moon, by M. H. de Parville. A systematic study of lunar and terrestrial phenomena continued for a quarter of a century leads the author to infer a distinct relation between lunar declination and earthquakes, the general law being that the disturbances occur either at the equiline, the lunistic, or exactly when the sun and moon have the same declination.—On the variations in the absorption-spectra of didymium, by M. Henri Becquerel. Fresh experiments here described confirm the previous conclusion of the

author regarding the presence of foreign substances in didymium, as revealed by its absorption-spectra. Some of these bodies may possibly be diverse combinations of the same with another substance or with itself, such combinations being so stable that it has hitherto been impossible to transform one into the other.—On the specific heat of a salt-solution, by M. P. Duhem. The method employed by the author to find the expression of the heat of solution is here shown to lead also to the expression of the specific heat of a salt-solution.—On a standard pile, by M. Gouy. The author describes a convenient standard of electro-motor force, formed with zinc, sulphate of zinc, mercury, and dioxide of mercury.—Researches on the application of rotatory force to the study of certain compounds produced in the solutions of tartaric acid, by M. D. Gernez.—On a general method of forming the manganites from the permanganates, by M. G. Rousseau. The metallic permanganates are transformed to manganates at a temperature ranging from 100° to 150° C., and as the law of decomposition here formulated is applicable to the compounds of the whole series, it is proposed as a general method for obtaining most of the metallic manganates.—On the reticulated structure of the protoplasm of the Infusoria, by M. Fabre-Domergue.

BERLIN

Physiological Society, February 25.—Prof. Munk in the chair.—The President communicated two treatises sent for publication in the Proceedings of the Society, by Prof. Kronecker, of Berne. In the first, Prof. Kronecker had, in conjunction with Fraülein Popoff, examined the formation of serous albumen in the intestinal canal. As reagents they made use of the hearts of frogs and tortoises, void of blood, which were stimulated to contraction only when blood or a solution of serous albumen was poured through them, but under every other albuminous or saline solution remained inactive. Stomachic peptone was incapable of nourishing the heart. When, however, the peptone was kept for some time in the stomach or in an intestinal coil connected with the mesentery, then it acted on the heart in the same way as did serous albumen. Pancreatic peptone was incapable, either of itself or after remaining in the stomach or the intestine, of stimulating the heart to contraction; by exposure for a considerable time to the air, the peptone likewise became nutritious to the heart.—In the second treatise, containing an investigation by Prof. Kronecker and Fraülein Kink, it was demonstrated that in peptone solution two kinds of Bacteria are developed in the presence of air: *Bacillus restituens*, which transformed the peptone into serous albumen, exactly in the same way as did the living mucous membrane of the stomach; and *Bacillus virescens*, which liquefied the alimentary gelatine and imparted a deep blue colouring to all sterilised substrata when exposed to the air. This latter Bacillus operated poisonously on the heart.—Dr. Benda spoke of the function of the cross-striped muscle substance. By anatomical investigation of the muscles of the river crayfish he had arrived at the conviction that it was only the cross-striped substance which generated the contraction, while it was in the highest degree probable that the protoplasm discharged the office of mediation between the ends of the motory nerves and the contractile substance.—Prof. Ewald described some comparative experiments performed on three patients to ascertain the amount of nourishment with different commercial peptones, with eggs, and with eggs to which were added pepsine and hydrate of chlorine. The nutritive fluids were supplied *per enema*, and the individually very changeable nitrogenous transpositions were determined by careful analyses of the ingesta and egesta.

Meteorological Society, March 1.—Prof. von Bezold in the chair.—Dr. Kremser communicated the results of an investigation into the variability of atmospheric temperature in Germany. Variability he understood, in accordance with Hann's definition, to be the difference between the mean temperature on two consecutive days. Such variability was found by Dr. Kremser to attain its greatest magnitude in the mountains and in the eastern provinces, and its least range along the coasts of the Baltic and North sea, and on the islands. The maximum was in the Riesengebirge, 4°·3 F., the minimum on the islands of the North Sea, 2°·3. If the monthly means were arranged in chronological sequence for the year, there was presented an annual march of temperature with a chief maximum in December and a secondary in June. The variability of temperature at each of the different hours, 6 a.m., 2 p.m., and

10 p.m., yielded values differing from those of the variability of each of the different hours already specified to the yearly march of variability of the specified means. The greatest change of temperature affecting an individual per twenty-four hours was observed in Clausen, amounting to 68° F. In Berlin, the greatest change to which the period was liable was 24°·7; in Munich it was 30°·6. A variability of 18°·0 affecting a period of twenty-four hours might be expected in the course of a year in the east and but along the North Sea coast only in a period of the year on the basis for the above conclusions, Dr. Kremser had made the observations of ten years.

BOOKS, PAMPHLETS, and SERIALS RECEIVED

Gairloch: J. H. Dixon (Edinburgh).—Catalogue of Siwalik fossils contained in the Geological Department of the Indian Museum, Part 1. Mammalia; part 2. Aves, Reptilia, and Pisces: R. Lydekker (Calcutta).—Catalogue of Pleistocene and Prehistoric Vertebrata contained in the Geological Department of the Indian Museum, Calcutta: R. Lydekker (Calcutta).—Memoirs of the Geological Survey of India. Palaeontology, ser. xiii. Salt Range Fossils: W. Waugen: ser. xii. The Fossil Flora of the Gondwana System, vol. iv. part 2. The Fossil Flora of a part of the fields in Western Bengal: O. Feistmantel (Trübner).—Chairman's Report of the Longman Commozion Telluriche il Terremoto del 23 Febbraio, 1887 (Roux, I).—On Over-work and Premature Mental Decay, 4th edition: H. F. Baillière, Tindall, and Cox.—Geological History of Lake Lotozhan (Russell (Washington)).—Transactions of the Academy of Science, vol. iv. No. 4 (St. Louis).—Proceedings of the Anthropological Society, vol. xxiii. No. 124 (Philadelphia).—Essentials of His and 2nd edition. E. A. Schäfer (Longmans).—Natural History of Northumberland, Durham, and Newcastle-upon-Tyne, vol. viii. (Williams and Norgate).—Verhandlungen des deutschen Wissenschaftlichen Vereins zu Santiago, 3. Heft (Valparaiso).—A Plea for Land University: H. W. Crosskey (Cornish, Birmingham).—Proceedings of the Academy of Natural Sciences of Philadelphia, part 3, October number 1886 (Philadelphia).—American Naturalist, January (Lippincott).—Annalen der Physik und Chemie, No. 4, 1887; Beiblätter der Physik und Chemie, No. 2, 1887 (Barth, Leipzig).

CONTENTS

The Necessity for a Minister of Education 4
 Rosenbusch's "Petrography." By Dr. Frederick H. Hatch, Geological Survey of Great Britain 4
 Loch Creran 4
 Our Book Shelf:—
 "The Encyclopædic Dictionary" 4
 Ratte: "Descriptive Catalogue of the General Collection of Minerals in the Australian Museum" 4
 Letters to the Editor:—
 West Indian Meteorological Confederation.—Mr. H. H. Hall, Jamaica Government Meteorologist 4
 Units of Weight, Mass, and Force.—Prof. A. Greenhill 4
 Mr. Herbert Spencer's Definition of Life.—Howard Collins 4
 An Equatorial Zone of almost Perpetual Electrical Discharge.—Hon. Ralph Abercromby 4
 Scorpion Virus.—Sir J. Fayrer, K.C.S.I., F.R.S. 4
 The Relation of Tabasheer to Mineral Substances. By Prof. John W. Judd, F.R.S. (Illustrated) 4
 Exhibition of Marine Meteorological Instruments Geography at the Universities 4
 Professor Huxley on the Organisation of Industrial Education 4
 August Wilhelm Eichler 4
 Notes 4
 Our Astronomical Column:—
 Researches on the Diameter of the Sun 4
 Comet 1887 b (Brooks, January 22) 4
 Minor Planet No. 262 4
 Harvard College Observatory 4
 Astronomical Phenomena for the Week 1887 March 27—April 2 4
 Geographical Notes 4
 Sunlight Colours. By Capt. W. de W. Abney, R.E., F.R.S. (Illustrated) 4
 University and Educational Intelligence 5
 Societies and Academies 5
 Books, Pamphlets, and Serials Received 5

THURSDAY, MARCH 31, 1887

A UNIVERSITY FOR LONDON

WE have from time to time informed our readers of the progress made in the attempt to organise the capacities for teaching and learning in London into a more complete and more efficient shape. The movement most natural and admirable. What we have desired is to warn those interested in it not to lose sight of the full result obtainable while busied in their attempts to remove a particular grievance or further a particular interest. Each constituent of the future University—the Colleges and professional schools, the teachers and the students, the medical corporations, and the Senate and Convocation of the existing University of London—each is indispensable. Any one of these can block the way for the rest. Together they make up amply sufficient elements for the foundation desired, and this foundation could not be strengthened, but weakened, by attempts which can never be realised) to bring in such heterogeneous elements as the British Museum or the Royal Society, the Government technical schools or the Corporation of the City and its Companies.

The present state of affairs is, we believe, pretty much as follows. The Convocation of the present University, which the first efforts towards its reform began some ten or seven years ago, rejected a scheme presented to it by a Committee of forty of its most distinguished members, of which Lord Justice Fry was the chairman. Among them were the present Home Secretary, the President of the Royal College of Surgeons, Mr. Justice Wills, Sir Joseph Lister, Dr. Wilks, Prof. Michael Foster, Dr. Cristowe, Mr. Power, Mr. Howse, Dr. Ord, Prof. Unwin, Mr. Thiselton Dyer, Mr. Anstie, Prof. Carey Foster, the Rev. Dr. Dale, and Mr. Cozens-Hardy. A second and much smaller Committee was then constructed by Mr. (now Sir Philip) Magnus, who had taken the lead in opposing some of the provisions of the previous scheme, and this Committee brought up, on report, a second and modified plan of reform, which passed Convocation last May, not without opposition, but by substantial majorities and with only minor alterations. This second Committee laid the amended scheme before the Senate and remain in charge of it. Meantime the Senate had appointed a Committee of its own members, who have for several months been elaborating a scheme of their own, who have already conferred both with the Committee of Convocation and with one appointed by the Teaching University Association, and who have now presented their Report to the Senate. Some opportune vacancies, which occurred in the latter body during the last two or three years, have the presence of Lord Justice Fry himself, and of Dr. Wilks, Dr. Pye Smith, and Prof. Carey Foster. It is as probable that a scheme of reform will be accepted by Senate and Convocation, which will go as far as sanguine could expect, and farther than timid will approve. The Convocation of the latter body will gain more direct representation, and the Convocation of the Colleges which send up men for the University degrees will probably be also directly re-

presented on the Senate. But a more important improvement, one that would be useful even if the Senate were to remain exactly as it is, will almost certainly be the institution of Boards of Studies, which will represent the teachers and probably the examiners in each Faculty, much like the standing Committees which sit under the same name at Oxford. The general body of teachers which would elect these Boards would include provincial as well as London Professors, and would more or less correspond to the Congregation of Oxford, but it would probably seldom meet, except for the purpose of election of the representative Boards of Studies.

The Association for Promoting a Teaching University held a general meeting several weeks ago, and admirable speeches were made, especially those of Mr. Marshall and Mr. Bryce, but it lacked the enthusiasm given by numbers. After communicating with the principal London Colleges and Medical Schools, the Council of the Association propose to apply either to the Crown or to Parliament, probably with the object of securing a Royal Commission on the whole question.

University College, after coquetting with the Victoria University (which has apparently not welcomed with great warmth the proposal of accepting so large and distant a Society as its daughter), is now engaged in direct negotiations with King's College, with a view to agreement upon a common plan of action. This is a prudent course, for if the reform of the University of London should prove unattainable or inadequate, the two chief Colleges, by acting together, would be far more likely to obtain the privileges which they then would rightly seek.

Meantime the great medical corporations have become tired of waiting. They represent the most urgent grievance, and are fully justified in pressing for its redress. They appear likely to ask for power to grant degrees to their own licentiates, though under what authority and on what terms, either of examination or of residence, they have not yet determined. They have the advantage of practically undivided counsels, of knowing what they want, and of having an indisputable cause of complaint. They are naturally supported by the whole influence of the medical schools of London, and it adds not a little to the complexity of the situation that those connected with University and King's Colleges prefer to throw in their lot with the other professional schools rather than to hold aloof and unite with the other Faculties of their own Colleges.

Of the several bodies concerned, it is possible that the Senate, or at least the Convocation, of the existing University may fear that the just value of its degrees, attained by fifty years' efforts, will be compromised by allowing teachers to have a voice upon the Senate. But they must see that if the University is forsaken by its two most important London Colleges after the secession of its only important provincial one (Owens College), and if the medical schools of London, which have supplied nine-tenths of its graduates in that Faculty, also forsake it, its position will be untenable. Even if it were suffered to exist as a degree-conferring machine for unattached and imperfectly-taught students all over the kingdom, it would become what its worst enemies have called it, a mere Government Board, and could scarcely keep the title of a University, still less of the University of London, when it

had been stripped (or rather had stripped itself) of both characters. Moreover, Convocation would lose all importance, and could not possibly retain the only powers it at present possesses, of nominating certain members of the Senate and accepting new charters. The Senate would do its sole work, of choosing examiners and revising their lists, as a small body of salaried Government officials (probably in South Kensington), and no claim would remain for the unconnected waifs and strays who passed the examinations to take any part in the matter. No charters would be requisite, nor any apparatus of library or Senate House, laboratory or lectures. In fact all the efforts of the past twenty years would be thrown away.

Nevertheless, if the two original Colleges of the University secede, they will find the name, the prescription and the influence of the Senate too strong for them to, wrest its powers from the present holders.

The medical corporations have far more influence and far stronger grounds; for the three or four strongest of them are organised as complete Colleges in their own Faculty, and give a more academic training to their students in medicine than either University or King's College does to students in arts, science, or laws. They might, perhaps, succeed in gaining power to grant degrees where the others failed, but this could only be by showing that no reasonable concessions were made to their just demands by the existing University.

Hence it will be seen that the present University of London, its two original Colleges, and the principal medical schools, have each of them the power of checking, if not of checkmating, each other's plans. Even if they agreed to urge their several objects without opposition to each other, the result would be three Universities existing together in London. One would have become a mere examining Government Board; another would consist of two ill-endowed and ill-consorted Colleges, without residence, with slender endowments, and compelled to extend their proper functions by attempting the instruction of partial students; the third would be a combination of two large professional corporations with Colleges in one faculty only, two or three well equipped, several very poorly furnished, and all of necessity rivals, scattered over the country, none of them endowed, and only able by the terms of their existence to give a second-rate degree.

What hope would there be of any one of these three so-called Universities even approximating to what a University of London should be? Each would be strong enough to prevent the others succeeding; none would be strong enough to absorb its rivals. Meanwhile the higher education would deteriorate rather than improve, endowments would be indefinitely postponed, and the prospects of the University laboratories, museums, and libraries of London sending out worthy contributions to the progress of human knowledge would become poor indeed.

When the several separate movements now in progress are checked by the necessity of obtaining the sanction if not the support of Government, we may hope that broader views will be taken of what is best for the community, and more sober views of what is practically attainable. Believing in the public spirit and the good sense of our countrymen, we have little fear but that, with patience and mutual concessions, a combined

result will be obtained which will benefit all the part to the new confederation, and promote the only interest with which this journal is concerned—the national interests of learning and of science.

A JUNIOR COURSE OF PRACTICAL ZOOLOGY.
A Junior Course of Practical Zoology. By A. Mil Marshall, M.D., D.Sc., M.A., F.R.S., Professor in Victoria University, assisted by C. Herbert Hurst (London: Smith, Elder, and Co., 1887.)

NOTICE will be found in the columns of this journal (vol. xxviii. p. 242) of the second edition of a small laboratory hand-book by the senior author of the above named work, entitled "The Frog; an Introduction Anatomy and Histology." In the preface to that read: "The second instalment of the work, containing directions for the examination and dissection of a number of animals chosen as types of the principal zoological groups, is in active preparation, and will be published shortly." The author further acknowledges "valuable help from Mr. C. H. Hurst, Assistant Lecturer in Zoology in the College." Mr. Hurst now appears as junior author, and, although the work here under review differs in some important respects from its predecessor above referred to, we presume that it is the promised "second instalment."

The volume opens with an introduction, confined to the consideration of practical hints as to methods of working and manipulation; then follow fifteen chapters, each devoted to some one type of organisation, and the whole closes with an appendix, dealing with the uses and methods of preparation of reagents. We have, in all, most successful and important book of 421 pages.

The work is largely akin, in its more salient features, to many of its predecessors; but it stands alone in respect of certain methods of treatment, to which we shall refer duly. Thick type has been employed throughout for various headings, and the authors adopt the plan, introduced in the aforementioned smaller work, of printing directions for dissection in italics. In dealing with complications of the vertebrate skeleton, they have availed themselves of the printer's art, by way of restricting descriptions of homologous sets of elements to corresponding and distinct types.

The introduction is a model of perspicuity, and well set as to render it impossible for the veriest tyro to obtain anything but full benefit therefrom. The advice given is sound in the extreme, and such as could only have embodied the results of a long and well-tryed experience. The directions for injecting blood-vessels; perhaps, a little too elaborate, being worthy of the *parateur's* art, rather than of the ordinary beginner's; this, however, is a small defect on the right side. We note that under the section on microscopical examination reference to the micrometer has been omitted. Directions for measuring objects under observation should certainly be added to the next edition.

The several chapters into which the book is subdivided differ most conspicuously from those of certain earlier works in the fact that the more general statements are diffused throughout the whole, except so far as they serve to define an animal under consideration, or to

forth the predominant characters of a given system of parts. The chapters on Protozoa and the Leech may be consulted as fair examples. In the latter, advantage is taken of this method to force upon the student, somewhat prematurely, the fact that (p. 36) "the segmental arrangement affects in a marked manner the nervous, excretory, and reproductive systems, and, to a less degree, the circulatory and digestive organs," and the deduction that "it appears to result from a definite arrangement of parts which, in the ancestors of the leeches, were scattered irregularly through the body, much as in *Fasciola*" (dealt with in the previous chapter).

By way of contrast with its predecessor on the Frog, this volume is shorn of much that is histological. In the earlier work a special feature was made of this branch, but here it by no means receives that amount of attention which its importance demands. A start in this direction might well be made with the lung-structure of the bird and mammal, especially in view of the statement made (p. 389) concerning the mechanism of respiration in the former.

The detailed descriptions of the various animals chosen are, for the most part, exceedingly well rendered. A slight ambiguity has crept in in one or two places, and the descriptions of the vascular systems of the mussel and snail might well be amplified.

No portions of the descriptive text stand more in need of revision than those relating to the digestive glands. These are, in *Anodon*, *Helix*, *Astacus*, and *Amphioxus*, designated under the old term "liver." A certain amount of justification is forthcoming in the last-named case, in view of its blood-supply; but in the three first-named the striking results of recent research, which call for no comment here, ought at least to be suggested in the term "digestive gland" or "hepato-pancreas." While we would see, thus, the substitution of a modern term for one well-nigh obsolete, we would desire the withdrawal of the terms "kidney" and "ureter" as applied to the excretory organs of the Invertebrata. In the case of the mussel, in which a portion of that which our authors term "ureter," is glandular and secretory, the terminology as restricted by them becomes misleading.

Conspicuous among the novelties offered us are certain words new to students' books. The volume is fully up to date, and its authors are to be congratulated on having produced the first book for students in the language, which describes the receptaculum ovarium of the worm. As regards pure nomenclature, it is worthy of note that they have embodied, in describing the pterylosis of the bird's wing (p. 386), that introduced by Prof. Flower so recently as February 1886, in a lecture delivered at the Royal Institution; and necessitated by the splendid work in which he is being assisted by Mr. R. S. Wray. (The description of the barbules on the same page is in error.)

In dealing with the appendages of the insect, the nomenclature customarily applied to the crustacean limb is utilised. To this extension we heartily assent. On turning to the crustacean itself, we meet with an innovation far less deserving of support. Our authors, faithful to precedent, reduce the body of the decapod crustacean to twenty segments; but in so doing they discard the ophthalmic somite of their seniors, and press the telson

into the service. This introduces a serious difficulty when the nervous system is taken into consideration, and a still more formidable one as concerns the homology of the eye-stalk. That is passed over in comparative silence, and, although we are not told so in as many words, it is clear that they regard it as in no way serially homologous with the appendages. The condition of the visual organ in the lower Crustacea and other arthropods, taken in conjunction with the facts adduced by Brandt and others in the morphology of the insect's eye, render it probable that the above view may turn out to be correct. Nor must it be forgotten that Boas has challenged (*Morpholog. Jahrbuch*, vol. viii.) the accepted interpretations of the antennule. There are, however, two sides to this question, and it is important to observe that M. Alphonse Milne-Edwards has recently described a decapod (*Palinurus penicillatus*, *Comptes rendus*, vol. lix., 1864), in which one ophthalmite was for the most part multiarticulate and antenniform. This remarkable fact is the more striking in view of the reversion to the antenniform type of certain post-oral appendages, seen in *Mastigopus* and *Apsuedes* among the Crustacea, and so well known in the scorpion-spiders; whatever may be its precise significance, it is clear that the question of general homology of the eye-stalk, with which we are here especially concerned, is far from settled. The introduction of so sweeping a change into a book for juniors without due comment is, under these circumstances, a false step, especially when it is considered that the precise converse is stated in all other books current.

Equally unjustifiable, in that it affects another debatable question, is the statement (p. 379) that the bird's pre-pubic process corresponds to the pubis of mammals. Clear proof of this is not forthcoming. The student's hand-book is not the place for such dogmatisms: if asserted, they should be well qualified, and put as alternatives.

The retention of the old nomenclature for the bird's air-sacs, with its atrocious "*thoracic*" element, is disappointing; the substitution (p. 220) of "*pericardio-cœlomic*" for the well-tried pericardio-peritoneal canal of the fish is as misleading as it is misjudged; while that of "*connective*" for the time-honoured commissure is, on the whole, inadvisable. We live in a word-mongering age. New terms which do not mark a turning-point in advance, or at least the era of a new discovery, are stumbling-blocks, unless introduced by way of replacing irrelevant or absolutely fantastic precursors. Such is not the case with those here under consideration. Our position is somewhat that of the port-bound crew, in dread of being stranded on their own beef-bones.

Attention has been already directed to the diffusion of the more general matter throughout the text. This has been effected very successfully, and in well-chosen language deserving of the greatest praise; but we dissent from the method adopted. It will be generally admitted that Huxley and Martin's "*Elementary Biology*" dissipated for students of the subject, once and for ever, the subtle "cram"; and subsequent writers working along similar lines have, as was to be expected, attempted to improve upon the plan therein created, each after his own lights. Messrs. Marshall and Hurst have aimed at producing a work which they hope "may meet the wants

of those who desire to obtain a practical acquaintance with the elements of animal morphology, and who find the existing manuals insufficient for their purpose." It is to be assumed that they have been especially mindful of the needs of their own College, but the work also covers most of the requirements for the elementary examinations of other schools, and we presume the authors would wish it a general circulation among pure devotees. This said, we proceed to inquire into the method of treatment, and find with much regret that, at the outset, such deductions as are incorporated in the text almost invariably precede the description of those facts upon which they are based. For example: on p. 141, the alimentary canal of the crayfish—itsself complicated—is ushered in with the words that it is "a tube running in a nearly straight line from mouth to anus. Of this tube, the middle portion, or mesenteron, which is very short, is alone formed from the primitive alimentary tract of the embryo, and the 'liver' is an outgrowth of it. The stomatodæum, or anterior portion of the canal and the proctodæum, or hind portion, which together form almost the whole length of the canal, are both formed by invagination of the external surface of the body; and both have a chitinous lining which is continuous, at the mouth and anus respectively, with the chitinous external covering of the body." Then follows the detailed description. Again, the podical plates of the insect are twice mentioned before the student is told how to find them. The tympano-Eustachian passage of the bird is (p. 414) similarly treated; and here the generalisation given should, if introduced at all, have been rather inserted when dealing with the mammal, on the supposition that, as can hardly be doubted, the authors would have the student work over the animals in the order of presentation. In such cases as the dogfish skeleton (p. 198), the limbs of the mammal and bird (pp. 287 and 376), and the enumeration of the differences between Amphioxus and the higher Vertebrata (p. 168), the system is tolerable, by way of clearing the ground and exciting interest. When, however, as in the first-cited instance, the crowning triumph of the student's labour is thus anticipated and his reward forestalled, deduction on reflection upon his work falls flat, and one of the chief aims of the whole system is lost. This, to our thinking, constitutes the gravest defect in this valuable work.

In describing the rabbit's liver (pp. 306-7), the lobes are rightly enumerated, but the student is not informed upon what grounds the customary nomenclature is adopted. In this, and one or two other instances, explanatory clauses are needed, but not given.

The illustrations are excellent, reflecting the greatest credit upon all concerned, and artistic merit such as that of Fig. 28 cannot fail to strike the reader. Fig. 27 is unnecessarily complicated, too much having been attempted. The beautiful new figures of Amphioxus are especially deserving of praise; but more of them are wanted, in order to do justice to the excellent description which they illustrate. Comparison of this chapter with that on the liver-fluke calls for this increase in number, in view of the relative chances of the student's procuring specimens.

Being mindful of the difficulties of preservation of Amphioxus, it is to be regretted that, while full directions

are given for cutting sections, those for preservative which have led up to the splendid results incorporated in this work, should have been omitted. This, the more as the animal is to be obtained in the Channel Islands and is therefore within reach of the native student fact which should be mentioned in the text).

In dealing with the higher vertebrates, the authors follow one of their predecessors in first describing the skeleton. We doubt the advantages of this system, especially as in this work we have an "almost entire omission" of the muscular system, held to be "of subordinate educational value." The book, taken as a whole, is highly welcome and most admirable. It is provided with an exceedingly good index, and presented in a form demanding our sincere thanks alike to authors, printers, and publishers. Taking it, in conjunction with its predecessors, in account, we have to congratulate the student of zoology upon his accessions. This volume yields ample return for the immense labour which its authors have bestowed upon it; it is well worthy of the school which they represent, and of its prototype above named.

It is significant that the only typographical error which we have detected should be the occasional absence of *t* and *r*. This fact might repay a careful research into the hands of the printer.

The authors state in their preface that "corrections suggested from those who use the book will be gratefully received." Having dealt above with the most important matters which occur to us, we append comments on some of the more obvious among those of who minor importance, noted in perusing the volume.

Before proceeding to do this, we wish to call attention to two matters of exceptional note: the first, the respiratory folds of the lining membrane of the fish's mouth; the second, the attachment of the styloid element of the rabbit's hyoid-arch to the paramastoid process. It is indeed remarkable, seeing that these structures are such common occurrences, and that they have been presented to every native student of recent years, that there is not yet a text-book in the language, or out of it for that matter of that, in which they are described. This is the more surprising in the case of the respiratory folds, considering their general development among teleostean and gnathostomatous fishes.

The Hydra. We cannot accept the description of the supporting lamella as the "mesoderm"; it is misleading if not erroneous.

The Leech. There is no mention of the intermediate nerve.

The Earthworm. The description of the histology of the nervous system needs amplification, especially as concerns the distribution of the nerve-cells, by way of bringing out the nature of comparison with the other types. The account given of the blood-vessels is incomplete; the sub-intestinal trunk (described by Horst, *Niederl. Tijdschr.* vol. xxxvii., and others) is not mentioned, the term being applied, in error, to the supra-neural vessel.

We strongly dissent from the description given of the cesophageal glands. Further investigation is necessary before we can accept their subdivision into the three categories here proposed. By our contemporaries, as ourselves, much variation has been observed in the number and relationships, and we have seen examples which all contained calciferous concretions and open into the gut.

The Edible Snail. In describing the liver, the terms left and right have been transposed. Mention should be made of the salient features, in structure and distribution, of the teeth of the radula.

The Lancelet. To the description of the supposed excretory canals of Lankester (p. 178) there should be added that of the much more likely one of Hatschek (*Zool. Anzeiger*, vol. vii.). We accept the senior author's views on oviposition, but Quatrefages' observation should have been mentioned unless finally disproved.

The Dogfish. The remarks on ossification (p. 194) are erroneous. The statement (p. 211) that the labial cartilages probably "belong to the same category as the extra-branchials" is unfortunate, in view of Dohrn's discovery that the latter are displaced rays of the gill-septum.

In describing the relative positions of the roots of the spinal nerves (p. 252) the terms dorsal and ventral have been transposed. The description is irreconcilable with Fig. 36.

The Rabbit. The description of the shoulder-girdle needs revision, with respect to the coracoid element and the relations of the clavicle. The statements concerning the morphological value of the pisiform would be better free of bias, in view of the tendency of current research. In describing the pelvic girdle, mention of the cotyloid bone has been omitted, and consequently we find the statement that the pubis forms a portion of the acetabulum (cf. Parker, *P.Z.S.*, 1882; also Leche and Krause, *Internat. Journ. of Anat. and Hist.*, vols. i. and ii.). The Eustachian cartilage is deserving of note.

The structural differentiation of the lining membrane of the stomach and base of the rectum need description. The duct of the infra-orbital gland is insufficiently noted; the description of the cæcum needs revision. It is interesting to find that the authors have not discovered the ducts of the rectal glands.

The statement explanatory of the uterus masculinus must be withdrawn or considerably modified, in face of Kolliker's belief that it is a derivative of the Wolffian ducts ("Entwickelungsgesch.," 2nd edition, p. 981). Its structural features and relationships are much more intelligible on this view.

The description of the fifth ventricle needs modification, and that of the spiral valve of the portal vein might well be inserted (Hyrtl, *Sitzb. Akad. Wien.*, 1879).

The Fowl and Pigeon. Note of the more important muscles of the syrinx, as also of the larynx of the mammal, might advantageously be added.

The ventricle of the olfactory lobe is not mentioned, either in the bird or rabbit.

In conclusion, we would wish to draw attention to the satisfactory manner in which the authors have apportioned the several chapters of this successful volume in accordance with their respective value—no light task of its kind. The thoroughness of the book is one of its most striking features.

G. B. H.

EMBRYOGENY OF THE ANTHROPOID APES *Recherches Anatomiques et Embryologiques sur les Singes Anthropoïdes.* By J. Deniker. (Paris, 1886.)

THIS work was presented to the Faculty of Science of Paris as a thesis for the degree of Doctor of Natural Science, and was approved of by it as sufficiently meritorious to warrant the bestowal of that degree on the author. It consists essentially of a comparison of the fœtus of the gorilla and of the gibbon with that of man, and also with young and adult anthropoids.

The embryogeny of the anthropoid apes, notwithstanding the great interest which it presents, is unfortunately little

known, probably owing to the difficulties of obtaining embryo specimens. The author has therefore done well to utilise the opportunity which presented itself to further our knowledge of the subject, by publishing the descriptive anatomy of the fœtus of the gorilla and the gibbon which he has had the opportunity of studying. His account of the anatomy of these specimens is rendered more valuable by the comparison he has made between them and the human embryo, and between them and the adult animals of their respective species.

The work begins by a careful description of the external characters of the embryo gorilla and gibbon: the attitude, external form, coloration, and integumentary characters are respectively detailed with much care. The placenta and fœtal membranes were fortunately preserved with the fœtus of the gibbon, and their characters are described and figured, but unfortunately these parts were not obtained with the young gorilla, and so could not be described. A *résumé* is given of the observations of Owen, Huxley, Turner, and others on the placentation of apes and monkeys. The next section contains an account of the weight and dimensions of the various parts of the body of the respective fœtus. Of the former little can be said on specimens preserved in alcohol, but the dimensions of the entire body, the head, trunk, and extremities, are carefully detailed in a tabular form, with the corresponding measurements in the human fœtus at the fourth and fifth month, and of the adolescent gorilla. A second table shows the relations which the dimensions of the several parts bear to the length of the body, and a third table those between the trunk and the extremities, and between the different segments of the latter. These tables show several interesting points in regard to the proportions which the various parts of the body bear to one another in the course of development. During the second half of intra-uterine life the upper extremity in the anthropoids is much shorter in relation to the length of the trunk than in the adult, and the same relation holds good with respect to the length of the fore-arm as compared with that of the upper arm. In the human fœtus of the same age, on the other hand, the upper extremity presents almost the same proportions that it does in the adult. The relative length of the superior extremity as compared with that of the inferior changes likewise considerably in the course of development. Thus in man during the earlier stages of embryonic life the lengths of both extremities are almost equal, but in the anthropoid apes, at an early period even, the length of the superior limb exceeds that of the inferior.

The skeleton of the fœtus is next compared with that of the adult anthropoids. In treating this part of the body the author naturally devotes considerable attention to the various parts of the skull, and has drawn up several valuable tables of its measurements in the fœtus and adult. The second chapter on the skeleton is devoted to a description of the vertebral column, and the limb bones; while the third treats of the dimensions of the individual bones. The points of ossification of the skull are found to be the same in man and the anthropoid monkeys, but the rate of their development in the monkeys in many important respects differs from what obtains in man. In general it may be stated that the frontal region ossifies more rapidly, whereas the occipital

and petro-mastoid regions ossify more slowly than in man. The cranial sections unite probably in the same order as in man, but generally at an earlier age, nevertheless there are certain exceptions to this which are pointed out. The brachycephaly of the skull of young anthropoids diminishes as age advances. Elongation of the facial part of the skull occurs much more rapidly than that of the antero-posterior diameter of the cranial part, until the eruption of the teeth. Passing on to the osteological characters of the rest of the skeleton, we find that the points of ossification of the borders of the vertebræ in the fœtus of the anthropoids do not appear in the same order as in man, as they seem to form simultaneously in all the regions of the vertebral column. The points of ossification of the pleurapophyses of the cervical and sacral vertebræ appear later than in man. This is especially the case in the sacral region of the gibbon. The spinous processes of the cervical vertebræ are shorter in the fœtus and young gorilla than in the adult. In the former the sacrum is broader, the coccyx longer, and the sternum larger, than in the latter. The different segments of the upper and lower limbs, except the carpus, ossify more rapidly in the anthropoid monkeys than in man; the lower limb ossifies, however, more slowly than the upper.

The muscular anatomy of the young and adult anthropoids is fully described and compared, and presents many points of considerable interest. Contrary to the opinion of Bischoff, the muscles of the face are found by the author to be very distinct, not only in the adult but even in the fœtal state. The arrangement of the muscles of the neck, fore-arm, leg, hand, and foot are particularly noteworthy, especially when compared with those in man.

The encephalon of the fœtal gorilla was found to weigh 28 grammes, and equalled a sixteenth part of the entire weight of the body. In the fœtus of both the gorilla and the gibbon the cerebellum is very small, and is completely covered by the cerebrum. The relative and absolute dimensions of the brain of the fœtal gorilla correspond to those of the human fœtus at the fifth month, but in its convolutions it was equivalent to those of the human fœtus at the sixth month, while the frontal lobe corresponds to that of a seven-months child.

The heart of the fœtal gorilla, though absolutely smaller than that of the human, is much greater in proportion to the size of the animal; it is also more voluminous than that of the adult of the same species.

The form of the hyoid bone of the anthropoid apes resembles that of man more nearly in the fœtus than in the adult. Its ossification takes place earlier than in man. The ventricles of the larynx of the fœtal gorilla resemble those of man, and are not continued into the laryngeal sacs.

The development of the dentary follicles of the gorilla and gibbon takes place earlier than in man. The eruption of the milk-teeth occurs in the same order as in man, except that in the gorilla the teeth of the upper jaw appear before those of the lower, that is to say, the reverse of what generally obtains in man. The cæcal appendages increase relatively to age in the gorilla, while in man the contrary appears to be the rule. The spleen of the fœtal gorilla differs in form from that of other anthropoids and from that of man, and resembles more nearly the spleen

of a carnivore. The liver of the gorilla has the four-lobe type-form common to the majority of mammals, as in this respect differs from that of man and the other anthropoids.

The work concludes with a chapter on the general result of the author's observations, in which he confirms the statement made several years ago by Huxley that the structural differences between man and the Primate which approach nearest to him are not greater than those which exist between the latter and the other members of the order of the Primates.

OUR BOOK SHELF

The Geographical and Geological Distribution of Animals. By Angelo Heilprin, Professor of Invertebrate Paleontology at, and Curator-in-charge of, the Academy of Natural Science of Philadelphia. (London: Kegan Paul, Trench, & Co., 1887.)

THE author of this book tells us that, while anxious to present to the student a work of general reference, where the more salient features of the geography and geology of animal forms could be sought after and readily found, he also wished to call attention to the more significant facts connected with the past and present distribution of animal life, so as to lead to a correct conception of the relations of existing faunas. The need of such a work will be generally acknowledged, and, without doubt, this little volume of some 400 pages does to a great extent supply the need; but it may be that the time has not quite arrived for the appearance of a perfectly satisfactory work on the subject. Though the record of both geographical and geological distribution is a vast one, still there is a vast deal more of the record yet to come, and the very pages of Prof. Heilprin's work show what immense additions to the facts and the deductions drawn from these are based on the as yet incomplete publication of the results of the *Challenger Expedition*. When the author has these results to rely on, we find a certainty of fact and a sureness of deduction which give confidence to a general reader or to a student.

The volume consists of three parts. In the first part the distribution of animals throughout space is treated of; in the second the succession of life, the faunas of the different geological periods, and the appearance and disappearance of species are dealt with; in the third the present and past distribution of individual animal groups is considered. On the many still debatable points the author is always judicious, giving when necessary the opinions both for and against; nor, as far as we have been able to judge, does he fail to call attention to difficulties that surround many of the problems he has to refer to. In reference to the subject of the appearance of species we observe that he regards the once burning question of the animal nature of Eozoon as settled "through the negative researches of King, Rowney, Julien, and Möbius" the elaborate memoir of the last-named being conclusive.

For the class of readers for whom this work is meant a glossary of the technical terms employed would have been very useful. Most of them can be learned by reference to original sources, but it would have been convenient to have them within the same cover.

Life-Histories of Plants. By Prof. McAlpine. (London: Swan, Sonnenschein, Lowrey, & Co., 1887.)

THIS book may be dealt with in a very few words. It professes to give the essential features in the life-history of a considerable number of types. The descriptions are extremely scanty, but in spite of this, room has been found for many very doubtful statements. Thus we have Dodson's speculations as to the fertilisation of red seaweed

by the agency of small animals quoted as if they were well-established facts (p. 184). Chara is spoken of as "a sort of transition stage" between the red and brown seaweeds (p. 199). We fail to find any grounds for this extraordinary statement. We are informed that in *Selaginella* "the rain or dew will settle in the hollow of the leaf, and help to float the zoospores; but in *Pinus* their dry and motionless representatives are more exposed to the wind on the outer surface of the leaf" (p. 279). It would be difficult to frame a sentence more hopelessly inaccurate than this.

The following passage from the introductory chapter is worth quoting: "Morphology by itself is thus seen to be a matter of mechanism, revealing nothing higher than a combination of mechanical movements, harmonious in action and beautiful in execution; but physiology, dependent on structure for the interpretation of the phenomena of life and the causes thereof, seeks to reveal the inner life as well as the outward expression of it" (p. 10). It will probably be new to most of us to learn that morphology reveals movements at all, mechanical or otherwise.

At p. 179 "apogamy" and "self-fertilisation" are used as equivalent terms; at p. 138 *Spirogyra* is said to produce gonidia, and at p. 25 reproduction in *Selaginella* is said to take place by means of a true seed.

We have only cited a few examples of positive errors, but throughout the book the terminology is strange and confusing, even where not absolutely incorrect.

The book is presumably intended for students "cramming" for examinations, but even for this purpose we fear that it will prove worse than useless. D. H. S.

LETTERS TO THE EDITOR

[The Editor does not hold himself responsible for opinions expressed by his correspondents. Neither can he undertake to return, or to correspond with the writers of, rejected manuscripts. No notice is taken of anonymous communications.]

[The Editor urgently requests correspondents to keep their letters as short as possible. The pressure on his space is so great that it is impossible otherwise to insure the appearance even of communications containing interesting and novel facts.]

Vitality, and its Definition

It is perhaps desirable that I should offer a few words of explanation, by way of reply to several of your correspondents, who have commented upon certain statements in my recent address to the Geological Society.

In the first place, I think that any candid reader of that address will acquit me of being guilty of such presumption as to make a statement, on my own authority, concerning the vitality of seeds. My object was to contrast the greater stability of mineral structures with the lesser stability of animal and vegetable structures. Consequently I selected what I thought would be regarded as the extreme examples of prolonged vitality in the animal and vegetable worlds respectively. It was quite sufficient for my purpose that competent botanists have cited the case of the germination of seeds taken from ancient Egyptian tombs as authentic, and that a botanist of such eminence as A. de Candolle should assure us that it is "not impossible." As a matter of fact, I have been informed, however, by a reliable authority that experiments on the germination of seeds taken from mummies have very recently been conducted to a successful issue.

With respect to Mr. Herbert Spencer's definition of life, my object was not to find fault with it but to show that the differences between "organic" and "inorganic" matter are of so shadowy a kind as to defy definition. Even straining the meaning of the word "correspondence" so as to give it the force implied in the passage cited from the "Principles of Biology" by your correspondent Mr. Collins, I maintain that in those changes undergone by minerals to which I apply the term "physiological" there is a complete "correspondence with external sequences." When the temperature of a crystal is altered through a certain range, expansion and contraction take place unequally in accordance with the molecular structure of the mass. In consequence of this unequal expansion and con-

traction, stresses are produced and the crystal undergoes an internal molecular rearrangement, which is determined by a latent "organisation," though it can only be detected, perhaps, by its action on the light-waves. But now let another set of forces come into play, namely, the chemical action of liquids containing gases in solution, and immediately the effects of the former change are seen in the manner in which the crystal yields to the new forces operating upon it. This secondary change is in fact only rendered possible by the primary one having taken place. But the changes produced by solvent action in turn weaken the stability of the whole mass, permitting other chemical affinities to assert themselves, in consequence of which the crystal enters upon a long series of metamorphoses which terminate in the complete "dissolution" of the ties that held together its molecules; it thus becomes a pseudomorph, a sort of mineral corpse, with the external form of the original crystal only, but without any of that capacity for undergoing a wonderful cycle of changes which was its original endowment. After this the materials of the "dead" crystal may be used up to form the substance of new ones.

It is scarcely necessary to add that I had no serious intention of asserting that minerals do actually live, in the sense in which "living" is popularly understood. All I care to insist upon is that minerals, like animals and plants, go through definite cycles of change, dependent on their environment, and that the distinction between "organic" or "living" matter and "inorganic" or "lifeless" matter is therefore not a fundamental one. Surely no better proof of this can be adduced than the fact that the more exact we try to make our definitions of the terms "life" and "organisation," the more shadowy and intangible become the distinctions upon which we are driven to depend. I am perfectly satisfied with Mr. Herbert Spencer's admission of "insensible modifications and gradual transitions which render definition impossible." But if this be the case, it is surely not wise to maintain that the science of "non-living" beings must differ totally in its aims and its methods from that of "living" beings. To bring out into clear relief the analogies between the science dealing with the mineral kingdom and those concerned with the animal and vegetable kingdoms was the main object of my address. JOHN W. JUDD

March 28

"The Gecko moves its Upper Jaw"

Thus by the substitution of one reptile for another—the gecko for the crocodile—the well-remembered zoological statement in Arnold's Greek prose is at length put upon a satisfactory foundation. In the spring of 1886, I captured a small gecko (*Tarantola mauritanica*) at Rome, and I have hitherto succeeded in keeping it alive and in health. One of the first things I noticed about it was the extraordinary vigour with which so small an animal would bite one's finger. And the effect produced was certainly rather due to the lizard's expression of intense ferocity during the process than to the pinch which it was



FIG. 1.—The Tarantola in the normal position of rest.



FIG. 2.—The Tarantola prepared to bite, with the upper jaw raised.



FIG. 3.—The Tarantola biting,—a common position, in which the upper jaw is depressed below the normal.

able to give. The expression chiefly depends upon two things—the fact that the anterior part of the head may be bent downwards, and that the eyes are retracted into the head. Examining the former movement more carefully, it was seen that in opening the mouth the upper jaw is distinctly although slightly raised above the normal, so that the profile of the upper surface of the head becomes almost straight (compare Figs. 1 and 2). In biting fiercely it is common for the upper jaw to be depressed below the normal, as is plainly seen in a profile view (compare Fig. 3), although in other positions the curvature of the head is

normal, and again in others the profile may remain straight in biting (as in Fig. 2). As far as I could observe in Tarantola, the upper jaw was always raised in opening the mouth, and the profile of the head straightened from its normal curve when at rest, but on closing the mouth in biting the movement of the upper jaw depended upon the relative position of the animal to the object which it was biting. This depression of the upper jaw may be also often witnessed when the mouth is closed, and it may be produced by applying slight pressure to the head. The animal seems to make the most of its powers of expression, for on provocation it opens its relatively huge mouth with the greatest readiness, and will keep it open for a considerable time, during which its appearance is sufficiently awe-inspiring. The fact that the anterior part of the skull is not co-ossified with the posterior part is well known. Thus in Huxley's "Anatomy of Vertebrata" (1871, p. 225) the following statement is made concerning the geckos: "Neither the upper nor the lower temporal arcades are ossified, the post-frontal being connected with the squamosal and the maxilla with the quadrate by ligament;" and Mr. Boulenger informs me that had he been asked whether the upper jaw of such lizards is moved in biting, he would have been inclined to answer in the affirmative, reasoning from the well-known condition of the skull. But I believe it has not been hitherto actually observed that such movable articulations possess a functional value in the living animal, and that the geckos must be added to the well-known instance of the parrots as Vertebrata which move the upper jaw in biting. It is extremely probable that the same observations will be found to hold for other families of lizards. EDWARD B. POULTON

Wykeham House, Oxford, March 1

Weight and Mass

TILL some quite new facts are discovered, such as shall force us to reconsider our convictions (which have not been lightly formed), I do not think it profitable to accept a quasi-metaphysical challenge from my friend Prof. Greenhill. He has at heart, as strongly as I have, the cause of *definiteness* and *accuracy*:—and if he, as is natural for one in his position, feels inclined to sympathise with the "vernacular" of Engineers rather than object to it as I do, there is nothing for it but to agree to differ. My remarks on this aspect of the subject were of the most cursory and general character; and I went so far as to say that, as the book in question was written by a practical man for practical men, "perhaps we ought not to complain."

I cannot, however, go *so much further* as to allow, with Prof. Greenhill, that it is "perfectly correct" to use the words pound or ton "side by side in two senses." As regards this practice I, in turn, must quote from an unpublished letter of Clerk-Maxwell's. [The passage purports to be part of a (reported) speech by a well-known Evolutionist.]

"He regretted that so many . . . were in the habit of employing the word in a sense *too definite and limited* to be of any use in a complete theory. . . . He had himself always been careful to preserve that largeness of meaning which was too often lost sight of in elementary works. This was best done *by using the word sometimes in one sense and sometimes in another*; and in this way he trusted he had made the word occupy a sufficiently large field of thought."

I have three other remarks to make upon Prof. Greenhill's letter:—

(1) He shows the absurdity of defining the weight of a body as "the force with which it is attracted by the earth." Of course such a definition must necessarily be absurd provided it comes after an explanation (given by Prof. Greenhill) that "weight" is to be understood in the sense of "mass." But from this explanation itself it would unfortunately follow that *a body has weight even when it is no longer heavy*; as, for instance, when it is in a (supposed) cavity at the centre of the earth! Prof. Greenhill says that "weight" is "used in ordinary language in most cases" in the same sense as "mass." Surely the great majority of men regard weight from the point of view of the sublime Porthos:—

"Ma vaisselle d'argent . . . qui doit peser de mille à douze cents livres, CAR je pouvais à grande peine soulever le coffre qui la renferme, et ne faisais que six fois le tour de ma chambre en le portant."

(2) He also speaks of certain difficulties imposed by the "rules of language." I do not ascribe to them so lofty an origin. They are the offspring of the dogmatic ignorance which

has peopled the realms of science with Centrifugal Force and its fellow monsters.

(3) He has commented solely on a passing remark in my article, and says nothing as to its main purpose. I hope, however, that he will eschew "statical" measures of force, and give his hearty aid as well as his good wishes in the war of extermination which must perpetually be waged against the luxuriant undergrowth of the scientific garden:—the circulators, the perpetual-motionists, and (in the case before me) *the measurers of potential energy in terms of horse-power*.

P. G. T.

An Error in Maxwell's "Electricity and Magnetism"

IT may be allowed to me to remark that the error mentioned on pp. 172 and 223 of NATURE has its origin really in Helmholtz's renowned paper ("Ueber die Erhaltung der Kraft," 1847, p. 67), and that it thence found its way into most of the textbooks on electricity. It has sometimes been detected and hinted at; for the first time, I believe, in C. Neumann's paper published in the *Ber. d. k. sächs. Ges. d. Wiss.* at Leipzig (1877 "Elektrodynamische Untersuchungen mit besonderer Rücksicht auf das Princip der Energie." There we find (p. 436) the formula—

$$T \nabla + T_1 \nabla_1 = T^2 w + T_1^2 w_1 - TT_1 \frac{dV_{01}}{dt} + \frac{dF}{dt},$$

which is identical with the equation of energy given in NATURE p. 223, if we put—

$$\nabla_1 = A_1, w_1 = R_1, -TT_1 V_{01} = T_m, F = T_e, \text{ \&c.}$$

The formula is followed by the remark that it agrees entire with the formula given by Helmholtz, the only difference being the last term $\frac{dF}{dt}$, which in the latter is wanting; thus we may

say that by Helmholtz the potential energy of the system is variably expressed by zero.

Being formerly unaware of Neumann's researches, I, in another way, came to the same results, see the paper "Das Princip der Energie in seiner Anwendung auf die ponderomotorischen und elektromotorischen Wirkungen des elektrischen Stromes," published in the *Sitzber. d. k. böhm. Ges. d. Wiss.* (vide NATURE, vol. xxxii. p. 308). In this paper I have hinted one probable cause of this and similar mistakes and their relatively difficult discovery, of which the repetition of the error in the *best text-books* is a decisive proof. This cause I believe to be the trivial circumstance that there is no consistent or generally accepted notation of the different forms of potential and energy. This renders the comparison of different writings on this subject sometimes quite perplexing. When, for example, two authors denote the *same thing*, the one by V , the other by ∇ , and when the first writes the expression $d(T_1 T_2 V)$ the form—

$$T_1 T_2 dV + T_2 T_1 dT_1 + T_1 V dT_2,$$

the other the *identical* expression $-d(T_1 T_2 V)$ in the form—

$$T_1 T_2 dV - T_2 d(T_1 V) - T_1 d(T_2 V),$$

it may happen that they themselves and also other readers overlook the difference of sign, and that they continue to reason *if their V were identical*. Such mistakes occur oftener than supposed. See the interesting note at the end of Sir William Thomson's paper on "Capillary Attraction," NATURE, vol. xxxiv. p. 369.

Could there not be found a means of avoiding the inconveniences caused by such mistakes and the loss of labour spent in detecting them? I dare not hint at the possibility of an international system of notations of the most important physical quantities; thoroughly consistent, and recommended by the highest scientific authorities; for the realisation of such a system would probably meet difficulties quite insurmountable.

Prague University, March 12

A. SEYDLER

Tabasheer

MR. DYER in his article on "Tabasheer" in NATURE, February 24 (p. 396), throws out the suggestion that the silica deposited in the joints of bamboo may have undergone a process of dialysis. It may be of some interest to him, and to your readers generally, to learn that plates of transparent compact silica, SiO₂, may be formed by dialysing the basic soda silicate. Four

five years ago I discovered this, and succeeded in producing plates a quarter of an inch in thickness and four inches in diameter, by placing the basic silicate of soda within a dialyser, which was floated on dilute sulphuric acid, 1 part to 20. The plate of silica was formed in the floated vessel. A similar result may be obtained by placing in a wide test-tube a portion of basic silicate. Taking care that the upper portion of the tube is quite free from adhering silicate, the dilute acid should be poured on to the surface of the silicate without disturbing it. After a few hours the silica is eliminated in a crystalloid form.

Possibly the first process may help us to understand how tabasheer may have been deposited, while the second may throw some light on the formation of raphides, carbonic or some other acid being the active agent.

16 Savile Street, Hull, March 15

THOMAS ROWNEY

A Method of Illustrating Combinations of Colours

IN NATURE, vol. iv. p. 346, there is a description by Mr. Allen, of Sheffield, of some methods of showing the combination of various colours on a screen. He used a binial or "dissolving view" apparatus to produce overlapping disks of colours, and also three lenses mounted close together in place of the ordinary single lantern objective, and giving images of three apertures in a lantern slide, close to which were placed cells of coloured liquids.

His experiments suggested to me the following method, which I have used for some years past, and for which only the ordinary single optical lantern is required.

A lens 10 cm. in diameter and 15 cm. focus is cut in half, and the two halves are mounted in frames so as to be capable of sliding past each other precisely in the same way as the divided object-glass of a heliometer. The motion is given by a pinion acting on racks in the same way as in the ordinary double-barrelled air-pump.

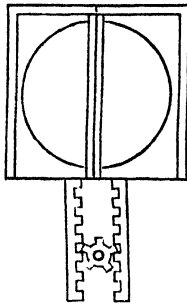

In the frames which carry the semi-lenses are cut grooves in which slips of coloured glass, or gelatine, or cells of coloured liquids may be placed; and the whole is fitted on the nose of the lantern in place of the usual objective, a diaphragm with round aperture about 3 cm. in diameter being put into the slide-holder.

Thus, when the two semi-lenses are so placed as to have their principal axes coincident, they act as a single lens and form one image of the aperture on the screen; but when they are moved past each other by turning the pinion, two disks of light are shown which can be separated entirely or made to overlap to any required extent. If, then, glasses or liquids of any given colours are placed in front of the semi-lenses, the compound colour produced by their union can be easily shown, either simultaneously with the component tints, or alone by accurately superposing the disks, thus avoiding any disturbing effect of the intrusion of other colours upon the eye.

It is in this way easy to show, taking four prominent colours, blue, green, yellow, and red, that blue + yellow = white; blue + red = purple; green + red = yellow, &c.

In place of coloured liquids, which are "messy" and liable to change, I almost always use coloured glasses, either singly or superposed (cobalt-blue, for instance, cemented to "signal-green" glass gives a good pure blue). Such glasses can by patient and careful selection be obtained of almost any required tint and intensity.

Eton College, March 26

H. G. MADAN

Ice-Period on the Altai Range

It is generally assumed that in the Altai Range there are no traces of so-called ice-ages. Hitherto, however, only ridges on the borders of the Altai Mountains have been examined. The geological phenomena of the mid-Altaiic regions are still almost quite unknown. In the course of last summer it happened to me to visit some parts of the south Altaiic regions—the Narim Range in the vicinity of Altaiskaia, Stornitza, or Koton Karagay, the neighbourhood of the Cossack settlement Oorool, then the so-called Katoon's Pales with their snowy giant Belooha. Subsequently I travelled in the valleys of the Belaia and Chernaia Berels, and visited the valley of the Arassan lakes and some other places. Everywhere I was struck by many and various traces and remnants of a large icy cover, which has left either strong glacier deposits, or abundant remains of moraines, or pieces of granite covered with lines. The valleys, too, bear on them the indubitable signs of glacial origin. In a word, there can be no doubt as to the existence of a large ancient icy cover here. Were these glaciers contemporaneous with the ice-age of Europe and North America, or do they present themselves as a quite independent system? My own observations convince me of their independence. The Altaiic ice-period had, I think, its own causes. The Altaiic system of mountains is of great antiquity; and its ridges were probably much higher at one time than they are now. Perhaps the whole system rose far above the line of eternal snow, although at present this line is reached only by some of the highest summits. It is probable, too, that in those very remote times the meteorological conditions of the country were far harsher than at present, because glaciers were more numerous and descended lower, digging the V-shaped valleys of the Katoon River, of the White and Black Berels Rivers, of Chindagatooy, &c.

The question of the periodicity of glacier-ages has again been raised lately, and perhaps it is from the Altai and from the Blue Alps that we may obtain the solid data for the complete solution of this very important question. A. BIALOVESKI Oostkamenogorsk, November 1, 1886

A Claim of Priority

J'AI eu récemment l'occasion de lire dans le *Philosophical Magazine* (Août 1886) la description très-intéressante d'un "intégrateur sphérique," combiné par Mr. Frederick John Smith, et qui semble être une modification de celui du Prof. Hele-Shaw. Mais l'idée première de ces appareils, et c'est sur quoi je dois appeler votre attention, m'appartient sans doute, car dans le No. 630 du journal anglais NATURE (Novembre 24, 1881) j'ai donné la description d'un "Anémomètre Intégrateur," fondé sur le même principe, et qui a été plus tard cité dans le *Quarterly Journal of the Royal Meteorological Society* (No. 43, 1882), par Mr. Laughton ("Historical Sketch of Anemometry and Anemometers").

La modification imaginée par Mr. F. J. Smith, tendant à supprimer ou à amoindrir, autant que possible, le moment d'inertie de la sphère, me paraît excellente, surtout s'il fallait transmettre des vitesses quelque peu considérables. Mais quand il s'agit simplement d'enregistrer celle du vent sur une échelle modérée, je crois que la forme primitive suffit, et, d'après plusieurs essais que j'ai faits, une bille d'ivoire roulant sur des cylindres de bronze c'est ce qui donne les meilleurs résultats.

Je vous prie, Monsieur le Directeur, de vouloir bien faire constater dans votre estimable journal cette réclamation de priorité, ainsi que d'agréer mes plus sincères remerciements et l'assurance de ma considération très-distinguée.

Observatoire de Madrid, le 12 Mars

V. VENTOSA

Oktibehite or Awaruite ?

In the notice of the proceedings of the Geological Society of London (NATURE, December 23, 1886, p. 190) the discovery in New Zealand of a nickel alloy allied to *oktibehite* appears to be claimed by Prof. Ulrich, of Dunedin. This requires explanation, as the mineral was first determined, and named *awaruite*, after the locality, by Mr. W. Skey, Analyst to the N.Z. Geological Survey Department on September 28, 1885, and described by him in a paper read on October 25, 1885, and published in the local papers at the time, as well as afterwards in the Transactions of the N.Z. Institute, vol. xviii., issued May 1886. A notice of it is also given in my twenty-first annual Museum

and Laboratory Report, June 1886, of which I inclose a marked copy. It will be observed that while Ulrich accepts the identity of the New Zealand alloy with *oktibeite*, Skey's analysis shows that its formula is $2Ni + Fe$, while that of the latter mineral is $Ni + Fe$.

JAMES HECTOR

N.Z. Geological Survey Office, Wellington, N.Z.,
February 9

AËRIAL VORTICES AND REVOLVING SPHERES

A STRIKING series of experiments on aerial vortices and revolving spheres has lately been made by M. Ch. Weyher, one of the directors of the important establishment for mechanical constructions at Pantin. An account of these experiments, with illustrations, appeared in a recent number of *La Nature* (February 26). As the results obtained by M. Weyher are very interesting, we reproduce the more important figures, and translate the descriptions given by our French contemporary.

Fig. 1.—*Aërial Vortices*.—A glass cylinder of about 0.40m. in diameter by 0.70m. in height, has an upper cover, pierced by a hole through which passes the shaft of the drum, the latter being formed of one or two paddles of cardboard put cross-wise upon the vertical shaft.

The cylinder contains some sawdust, or, better still, some oatmeal. If the oatmeal is put at first so as to form

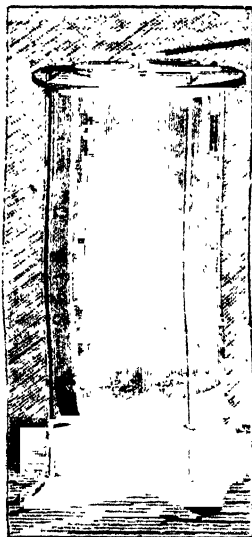

FIG. 1.

a cone or mound, and if the drum is turned round, a little waterspout can be seen forming at the top of the mound. Gradually the mass of oatmeal sinks into a hemisphere.

The matter runs without ceasing into spirals from the circumference to the centre; there it forms at first the lower cone, and then the upper reversed cone, in which the particles of oatmeal describe spirals, going from the centre to the circumference.

The whole system describes a primary general sphere, more or less distorted, the centre of which (where the two cones meet) is more or less deranged by the earth's gravity. If this is looked at from above, a hollow funnel is seen upon the axis: it is there that the air is most rarefied by rotation, and it is there that the finest particles come.

Substituting for oatmeal in the apparatus small light balloons inflated with air, the general movement can be followed. When the balloons are on the exterior circum-

ferences, they fall in slow spirals; when they reach the circumferences nearer the axis of rotation, they rise rapidly upon a helix at a much more extended pace. In short, the experiment shows that, given a mass of air, if a

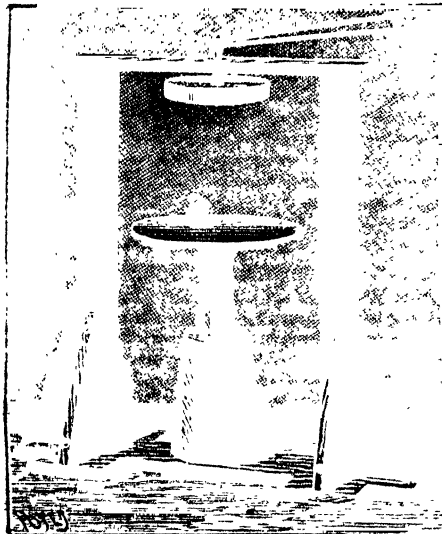

FIG. 2.

movement of rotation round a vertical axis is imparted to it this air falls constantly by the exterior circumferences, and rises by the interior circumferences, and the whole volume passes unceasingly through the centre of



FIG. 3.

the vorte; drawing into its movement the substances or particles therein immersed.

Fig. 2.—A plate of glass or any other material is placed below a drum with paddles; when this drum is put in

motion, we immediately place upon the plate a disk or a coin, to which the fingers give a first movement of rotation round one of its diameters.

The hand being quickly drawn back, the aerial vortex continues to make the coin turn round like a top, and absolutely keeps it captive in its radius of action. The coin, while turning upon one of its diameters, makes a sphere, and a later experiment will show that a revolving sphere constitutes a centre of attraction.

Fig. 3.—*Equilibrium of Revolving Spheres*.—A free sphere keeps itself in equilibrium, and turns round another sphere, to which a rapid movement of rotation is imparted.

The apparatus consists of a pin, A, which is able to turn in a support, and has a pulley, made to receive a transmitted movement. Upon the pin A is placed a sphere, S, composed of from eight to ten flat circular pieces (these may be either flat disks, or disks cut into a crescent shape; it does not matter which). The pin may be at any angle whatever to the horizon; in this experiment it is inclined at 45°, but it may be horizontal



FIG. 4.

or vertical. The angle of 45° was chosen because it seemed to be most difficult for the experiment, which would therefore be the more conclusive. When the sphere S is turned round rapidly, you feel on the hand a strong blast which escapes all around from its equator. Bits of paper which are placed near it are thrown far away. Nevertheless, if a balloon is put near this blast, it is quickly attracted towards the revolving sphere, and describes orbits round it in the plane of the equator. As the experiment took place in a room, where there were obstacles producing eddies, and as also gravity has too much effect by reason of the proximity of the ground, it is very difficult to obtain a regular movement. The balloon comes easily in contact with the revolving sphere, and is then driven away by the collision too far to be caught again. A very simple contrivance consists in placing round the sphere S a wire guard or circle of iron, F, 1 millimetre in diameter, attached to the support by three similar wires.

The balloon will then keep on turning round the motive

sphere, even ceasing to touch the guard in the lower part under the action of gravity. The experiment can be made in different ways, and the guard may even be suppressed, but these variations teach us nothing new.

In studying the vortex movements which the sphere imparts in the medium in which it is plunged, we easily calculate the ratio of the attraction which it exercises on the balloon.

Fig. 4.—The guard of the revolving sphere is taken away, and we place parallel to its equator a circle of paper with an interior diameter greater than the exterior diameter of the sphere; the circle is caught into the movement of rotation, and maintains itself strongly in the plane of the equator.

ON OLDHAMIA

THE organic origin of Oldhamia has often been disputed. Originally described by Edward Forbes from specimens found at Bray Head, near Dublin, in rocks of the Cambrian formation, it has been found in a few other localities in Ireland, in rocks of a similar formation. In the dispute the weight of the evidence has seemed to be in favour of the views of Forbes, Jukes, Harkness, and Kinahan, that this lowly form is a fossil probably belonging to the Polyzoa, or to the Sertularian Polyps. So the matter has stood for a long time. A recent paper by Prof. W. J. Sollas, published in the Proceedings of the Royal Dublin Society for January last, once again opens the discussion. In the hope of throwing light on this problematical structure, thin slices for microscopic examination were cut, both parallel and transverse to its planes of cleavage. When these were placed under the microscope, all trace of the Oldhamia structure appeared to have vanished. An examination with the unaided eye showed, however, that it was still there, presenting itself as narrow, undulating, and branching bands of a lighter colour than the surrounding matrix. Its appearance, moreover, varied in an extraordinary manner according to the direction in which it was viewed. Looked at obliquely in a strong light, the thread-like bands are brilliantly illuminated, and appear faintly coloured with spectral tints; looked at directly, the bands become fainter, and are less clearly distinguishable from the matrix. In certain positions the slice taken at right angles to the bedding has an appearance somewhat suggestive of shot-silk, and, from the planes of cleavage, markings which remotely resemble in form the dendritic markings of Sutton stones extend into the surrounding matrix.

These appearances suggest the presence of some mineral possessing high reflection or refraction arranged in more or less parallel planes. Mr. Teall, in the same paper, gives full details of the mineral characters of the rock. Aided by these, Dr. Sollas finds that the lighter-coloured bands, which correspond to the Oldhamia markings, owe their distinction from the surrounding matrix to the presence of an excess of sericite scales; and that the curious shot-silk appearances are produced by the local deflections of these scales from parallelism with the cleavage planes into directions tangential to curves, which are probably transverse sections of those long ridges which, when seen on the exposed surface of a cleavage plane, are recognised as the usual form of Oldhamia. It would appear possible that these ridges are wrinklings of the cleavage planes produced during the shearing which led to their formation. These observations were made on the form known as *O. radiata*, and in some supplementary remarks Dr. Sollas adds that when Oldhamia is present it shows itself on the surface of the laminae as rounded discontinuous ridges, which are without definite boundaries, and have the appearance of fine wrinkles. When the phyllode is fractured obliquely to the cleavage laminae, the Oldhamia markings are found to extend through the rock as fine ridges or wrinkles

which mark the surface of oblique fracture in a similar manner to those of the cleavage face. In fact, the appearances are remarkably similar to those of *ausweichungscleavage*, described by Heim in his "Gibergsbildung"; but the observations throw no light on the remarkable radiate form sometimes assumed by the structure. In a paper in the same journal Mr. Joly mentions that, in examining specimens of *O. antiqua* and *O. radiata*, he detected the following peculiarity: a sunken or depressed delineation of one form accompanied a raised or relieved delineation of the other form. Thus, if on any specimen *O. antiqua* appeared as a depression, on that same surface the *O. radiata* appeared in relief.

From this observation it appeared probable, if any meaning was to be attached to the relation, that a further

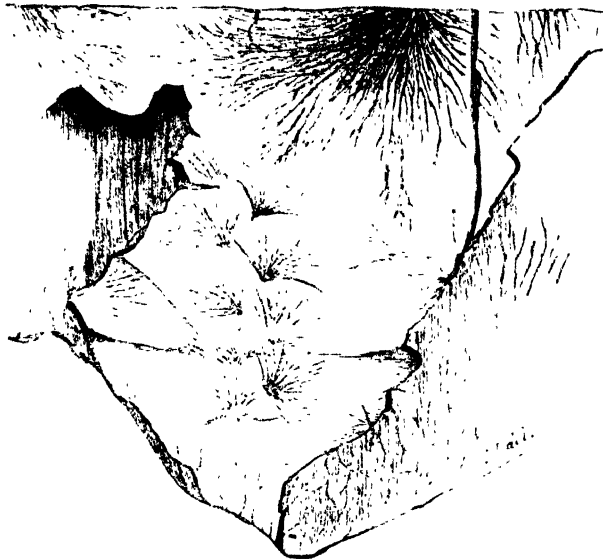

relation would be found to obtain between the mode of delineation and the position in the rock. This, a further examination revealed; in this order: on the upper surface, or what was most probably the surface of deposition (the cleavage of the Cambrian slate of Bray Head coincides generally with the plan of bedding), the *O. radiata* appeared invariably as a depression, the *O. antiqua* in relief.

When fragments were peeled off the slate, the marks were found to be transmitted, or extending to the layers beneath, so that lines on the upper are seen as continued on the adjacent lower layer, this, too, for thicknesses exceeding a millimetre. The accompanying woodcut recalls the appearance of a surface of rock in which this is fairly well shown.

ON THE DISTRIBUTION OF TEMPERATURE IN THE ANTARCTIC OCEAN¹

IN the regions of the Antarctic Ocean where icebergs are numerous, and where in winter the sea-water freezes, the distribution of temperature in the deeper layers of water is peculiar. The facts are detailed in the "Challenger Narrative" (vol. i.). The general result of her observations went to show that, from the most southerly station, a wedge of cold water stretches northwards for more than 12° of latitude, underlying and overlying strata at a higher temperature than itself (p. 418).

Although the conditions and facts likely to throw light

¹ Abstract of a paper read by Mr. J. Y. Buchanan before the Royal Society of Edinburgh, March 21, 1887.

upon the cause of the existence of this cold intermediate or superficial stratum overlying water which at any rate in its upper layers has a temperature higher than that of freezing distilled water are discussed, no satisfactory explanation of the phenomenon is given. One important fact is noticed at page 421. "The fact that the cold wedge above referred to extended north just as far as the icebergs did in March 1874 points to there being some connexion between the temperature and the presence of melting icebergs." It is well known that icebergs consist of land-ice, which is as nearly as possible pure frozen water, and melts in the air at 32° F. It was thought that the effect of immersion of such a substance in a medium having a temperature 3° F. lower than its melting-point would be to indefinitely preserve it, that in fact only the lower surfaces of the icebergs large enough to reach to a depth of 300 fathoms would suffer any melting at all. The existence of the cold stratum was ascribed wholly to the cold brine, separated from the ice on the freezing of the sea-water, sinking downwards with an initial temperature of from 28°·5 to 29° F. This cause, though existing and in operation, is quite inadequate to produce the effect observed. In Dr. Otto Pettersson's admirable work "On the Properties of Water and Ice," undertaken in connexion with the work of the *Vega* Expedition, there is a footnote at page 318 where he says: "As a thermometer immersed in a mixture of snow and sea-water which is constantly stirred indicates - 1°·8 C., we may regard this as the upper limit of the freezing and the nether limit of the melting temperatures of sea-water." In a review of Dr. Pettersson's work in NATURE (vol. xxviii. p. 417) I expressed doubt of the accuracy of this observation, but on repeating it I found it to be confirmed. It affords a complete explanation of the cold wedge of water in the Antarctic Ocean and the dependence of its thickness on the range of icebergs. These enormous islands of ice, a very large proportion of which rise in tabular form to a height of 200 to 300 feet above the sea, float in many cases with their lower surfaces at a depth of from 250 to 300 fathoms. The warmer and denser water coming from lower latitudes (see "Challenger Narr." vol. i. p. 428) bathes these lower surfaces, the temperature of the mixture at the surface of contact falls, the heat abstracted from the sea-water melts a corresponding amount of the ice of the iceberg, and a saline solution is produced, less salt and therefore lighter than the water away from contact with the iceberg, and having a temperature which depends immediately on the strength of the resulting solution. Being lighter than the surrounding water, this resultant solution necessarily flows up along the sides of the iceberg to the surface, and its place is taken by fresh undiluted sea-water which in its turn is cooled, diluted, and transferred to the surface. The result is the production of a most energetic engine of circulation and means of cooling and equalising the temperature of the water within the reach of icebergs. As there is continual renewal of the ocean water brought into contact with the ice, and as its composition is constant, the temperature produced is practically constant, namely 28°·8 to 29°·0 F., or - 1°·7 to - 1°·8 C. The layer of lighter water from 50 to 80 fathoms thick at the surface is due principally to the melting of land-ice, though it is also due in very small proportion to the melting of sea-ice.

Table giving the temperature at which ice melts in sea-water containing different percentages of chlorine

Temp. C. ...	1°·0	1°·1	1°·2	1°·3	1°·4
Per cent. Cl... ..	1°040	1°131	1°222	1°313	1°404
Temp. C. ...	1°·5	1°·6	1°·7	1°·8	1°·9
Per cent. Cl... ..	1°495	1°586	1°678	1°769	1°860

This table is taken from a paper on ice and brine communicated to the Royal Society of Edinburgh on March 21, 1887.

The density (at 15°·56 C.) of the sea-water which comes in contact with the lower surfaces of the icebergs is 1·0255, which represents a chlorine percentage of 1·90. Ice actually melting in this water would produce a temperature - 1°·92 C. When ice is immersed in this water it lowers temperature, and a portion of the ice is melted, producing dilution. The concentration, therefore, or chlorine percentage, which will determine the melting temperature of the ice, will be a little lower than that of the original sea-water. From the *Challenger* observations we see that, on the confines of the pack-ice the cold stratum of water has a uniform temperature of 29° F. (- 1°·67 C.). Ice melts at this temperature in sea-water containing 1·65 per cent. of chlorine. In this process ice is melted, so that 60 grammes pure warm sea-water become 119 grammes diluted cold sea-water. It will be observed that the ice which has been formed in the atmosphere at a temperature of 32° F. comes in this way to be melted at a temperature of 29° F.; and the pressure exerted by the 300 fathoms of sea-water, though it may assist in the lowering of the melting temperature, is insufficient to account for the amount.

O FIND THE DAY OF THE WEEK FOR ANY GIVEN DATE

HAVING hit upon the following method of mentally computing the day of the week for any given date, send it you in the hope that it may interest some of our readers. I am not a rapid computer myself, and I find my average time for doing any such question is about 20 seconds, I have little doubt that a rapid computer could not need 15.

Take the given date in 4 portions, viz. the number of centuries, the number of years over, the month, the day the month.

Compute the following 4 items, adding each, when found, to the total of the previous items. When an item total exceeds 7, divide by 7, and keep the remainder only.

The Century-Item.—For Old Style (which ended September 2, 1752) subtract from 18. For New Style (which began September 14) divide by 4, take overplus over 3, multiply remainder by 2.

The Year-Item.—Add together the number of dozens, the overplus, and the number of 4's in the overplus.

The Month-Item.—If it begins or ends with a vowel, subtract the number, denoting its place in the year, from 1. This, plus its number of days, gives the item for the following month. The item for January is "0"; for February or March (the 3rd month), "3"; for December (the 12th month), "12."

The Day-Item is the day of the month.

The total, thus reached, must be corrected, by deducting "1" (first adding 7, if the total be "0"), if the date is January or February in a Leap Year: remembering at every year, divisible by 4, is a Leap Year, excepting only the century-years, in New Style, when the number of centuries is not so divisible (e.g. 1800).

The final result gives the day of the week, "0" meaning Sunday, "1" Monday, and so on.

EXAMPLES

1783, September 18

17, divided by 4, leaves "1" over; 1 from 3 gives "2"; ice 2 is "4."

83 is 6 dozen and 11, giving 17; plus 2 gives 19, i.e. dividing by 7) "5." Total 9, i.e. "2."

The item for August is "8 from 10," i.e. "2"; so, for September, it is "2 plus 3," i.e. "5." Total 7, i.e. "0," which goes out.

18 gives "4." Answer, "Thursday."

1676, February 23

16 from 18 gives "2."

76 is 6 dozen and 4, giving 10; plus 1 gives 11, i.e. "4."

Total "6."

The item for February is "3." Total 9, i.e. "2."

23 gives "2." Total "4."

Correction for Leap Year gives "3." Answer, "Wednesday."

LEWIS CARROLL

NOTES

In the Report submitted yesterday at Edinburgh to the half-yearly general meeting of the Scottish Meteorological Society, the Council state that the work at the Ben Nevis Observatory continues to be carried on by Mr. Omond and the assistants in the same highly satisfactory manner as has been recorded in previous Reports. In addition to the laborious work of observing at all hours of the day and night, of reducing the observations, and forwarding copies for the Society and the Meteorological Council, the staff of the Observatory has given very effective assistance in the preparation of the tables of the meteorology of Ben Nevis now in the press. Several interesting researches are being conducted at the Observatory, the results of which will be communicated to a future meeting. The Directors took steps last autumn to raise subscriptions to clear off the debt on the institution, and to establish a low-level station at Fort William, at which hourly observations may be made for comparison with those at the Observatory. It is only by two sets of observations at the top and bottom of the mountain that the Ben Nevis Observatory can be utilised, with the desired success, in the furtherance of meteorological science, but particularly in that branch of it which concerns the improvement of the system of forecasting the weather of the British Islands.

On Tuesday evening last the Lord Advocate stated in the House of Commons that the Scottish Universities Bill would shortly be introduced.

The Paris Medical Faculty has decided to alter considerably the mode of competition for its Fellowships. The general object of the changes is to secure more original workers. The thesis (which has usually been the work, not of the candidate himself, but of his friends) is to be suppressed. Each candidate will henceforth have to deliver a lecture on his own scientific researches.

The French Chamber of Deputies has decided that the buildings of the College of France shall be considerably enlarged. Fifty years ago, when this institution had only seventeen professors, its present buildings were sufficient; but now, when it has forty-one professors, they are very inadequate. It is to have four new lecture-rooms, a geological gallery, a set of rooms for other collections, a library, a meeting-room for professors, and eight laboratories. These additions will cost over 9,000,000 francs.

The Anatomical Society, founded last September at Berlin, will hold its first general meeting at Leipzig on April 14. The Society has now over 170 members in England, Germany, Austria, Hungary, Switzerland, Holland, Belgium, Scandinavia, France, Russia, Italy, and North America.

DR. HANS REUCH, who has lately devoted much time to the study of earthquakes in Norway, has issued a tabulated circular, which has been reproduced in the entire Norwegian Press, requesting that reports of any phenomena observed in connexion with earthquakes may be sent to him. By Government permission all such reports may be transmitted through the post free of charge. Dr. Reuch asks especially for information

on the following points: exact time of occurrence of the earthquake; the time compared with that of the nearest railway or telegraph station; locality of occurrence, and whether felt indoors or in the open; nature of soil; what the observer was occupied with; how many shocks were felt; nature of motion, undulating or oscillating; from what direction the shock came; whither it went; how long the motion lasted; what were its effects; did the shock resemble others experienced by the observer; was there any sound; was the sound heard before or after the earthquake; what was the interval between the shocks; were phenomena of restlessness in animals, or peculiarities of the weather, observed; if near sea or lake, were there any strange motions in the same; the names of any other persons who are known to have noticed the earthquake. Earthquake phenomena having been more than usually frequent in Norway during the past year, it is believed that Dr. Reuch's circular may be of considerable service to science.

At a meeting of the Japanese members of the Seismological Society of Japan held at the Imperial University on January 20 (according to a report in the *Japan Weekly Mail*) two papers were read in Japanese. The first was by Mr. Kikuchi, on the geology of Corea. In it the writer described the geological map made by Prof. Gottsche, who visited that country after leaving Japan. The paper also gave a description of the geological formations and the minerals found in the different provinces of Corea, and showed that Corea differs from Japan in the fact that these formations in the former country are much older, and on that account more stable, than those in the latter. This, Mr. Kikuchi thought, might account for the comparative absence of seismological phenomena in Corea. The second paper, by Mr. S. Sekiya, was on recent destructive earthquakes. The writer described in succession the causes and effects of the earthquake which occurred in Japan on February 22, 1880; the earthquake at Ischia in 1883; the shock of October 15, 1884, in Japan; the earthquakes in Spain in 1884; those of the United States of last year; and the shock of January 15 in Japan. It was pointed out that the three earthquakes mentioned as occurring in Japan were very similar in their intensity, and that they extended over nearly the same area; but, with regard to their place of origin, the writer said the first two shocks originated in Tokio Bay, or in the ocean beyond the peninsula, while that of the present year originated in a spot to the south-west of the two previously mentioned. A third paper on the meteorology of Tokio was postponed. It appears from this and other reports which we have published from time to time that the Japanese Section of the Seismological Society, where the papers are read in the Japanese language, is, like the parent Society, in a very flourishing condition. It evidently supplies a demand for this department of science amongst Japanese who know no language well except their own.

At the first meeting of the London Commission for the Melbourne Centennial International Exhibition, held on Thursday, the 24th inst., the chairman, Sir Graham Berry, said that the proposed buildings of the Exhibition would cover an area of more than 1,000,000 feet. It was decided that a deputation should ask Sir Henry Holland to take steps for the appointment, in connexion with the Exhibition, of a Royal Commission for the United Kingdom, and that the Foreign Office should be requested to communicate on the subject of the Exhibition with foreign Powers, India, and colonies other than Australasia.

On Saturday evening last, a lecture on "The Habits of Ants" was delivered by Sir John Lubbock in the theatre of the Working Men's College, Great Ormond Street. The lecturer gave an interesting account of some of the results of his own observations, and brought forward much evidence to prove that ants possess "something more than mere instinct."

By an Order in Council, dated March 7, Her Majesty has declared that the following antiquities shall be protected by the Ancient Monuments Act: (1) Little Kit's Coty House, or the countless stones of Tottington, at Aylesford, in Kent; (2) the chambered tumulus at Buckholt, in Gloucestershire; (3) the Druid's circle and tumulus on Eyam-moor, in Derbyshire; (4) the Pictish tower of Carloway, in Ross-shire; (5) the Ruthwell Runic cross in Dumfriesshire; and (6) St. Ninian's Cave, at Glasserton, in Wigtownshire. The Order will not come into force until it has lain for forty days before both Houses of Parliament.

IN the so-called Seelberg, where in 1816 the mammoth group which is the chief ornament of the Stuttgart Museum was found, further excavations are being made under the direction of Dr. Fraas. Many skeletons, weapons, and implements have been discovered, and Dr. Fraas is of opinion that the mammoth group found seventy years ago was artificially put together by prehistoric artists.

IN the *American Naturalist* there is an article by Mr. John Murdoch on what he calls "some popular errors in regard to the Eskimos." One of these "popular errors" is the notion that the Eskimos pass the winter "in a sort of hibernation, in underground dens, living in enforced idleness and supporting life by stores of meat laid up in less inclement seasons." Mr. Murdoch, who spent two winters at Point Barrow, says this is a wholly mistaken impression. In spite of the extreme inclemency of the climate, the winter, he asserts, is passed by the Eskimos "in one continued round of activity," and he gives a very interesting description of the manner in which they occupy themselves. Another "popular error" on this subject is the idea that the Eskimos always eat their food raw, and devour enormous quantities of blubber. At Point Barrow, Mr. Murdoch found that food was habitually cooked, although certain articles, like the "black skin" of the whale, were usually eaten raw. Taking into account the fact that the Eskimos have no butter, cream, fat, bacon, olive-oil, or lard, he doubts whether much more fat is consumed by them than by civilised peoples. At Point Barrow the fat of birds and the reindeer was freely partaken of, but comparatively little actual blubber either of the seal or whale was eaten. "Seal or whale blubber was too valuable,—for burning in the lamps, oiling leather, and many other purposes, especially for trade."

A BOOK on "Sensation and Movement," by M. Ch. Féré, of Paris, has just been published. The author tries to show how different sorts of sensations react upon the vasomotor and motor phenomena, as indicated by pletysphymograph and dynamometer.

IN a work on "The Nationalities of Bohemia," lately published, Dr. L. Schlesinger shows that 37·11 per cent. of the population of that country are Germans, and 62·83 are Czechs. The limits within which the languages of the two races are spoken are generally very sharply drawn. There are 13,184 inhabited places in Bohemia, and in 4304 of them German alone is spoken, in 8473 the Czech language alone. In only 407 places are both languages used.

THE death is announced of Prof. Simon Spitzer, Professor of Analytical Mechanics at the Technical High School of Vienna, the author of various well-known mathematical works. He died on March 16 at the age of sixty-one.

THE new University building at Upsala is approaching completion. It has been in course of erection since 1879, and will be one of the finest University buildings in Europe. It will be opened with great ceremony on May 18 next by the King of Sweden, in presence of delegates from the principal foreign Universities.

LAST week the American Government forwarded another consignment of whitefish ova to the National Fish-Culture Association. These have been taken from late spawners, and appear more healthy than the batch sent in January. The ova are well "eyed," and in some cases are on the point of incubation. A consignment of the Californian trout ova, viz. the rainbow (*S. irideus*), has likewise been received by the Association from the American Government. This variety is likely to become highly popular in England on account of its unique colour and form and its capacity of gaining flesh rapidly.

WHEN the South Kensington Aquarium was closed, the sea-ott which had been maintained there were transferred to ponds in the Delaford Park Fishery; and in February last many ova were taken from them and crossed with the *S. fario*, in previous years. There are now a large number of hybridised examples of *S. trutta* in the ponds produced from ova laid in the South Kensington Aquarium and crossed in a similar manner. The two-year-old specimens are now about 7 inches long, their size being much smaller than that of other trout of the same age. None of the fish have spawned.

THE meaning of the word "scientist" seems to be rather vague in the country in which it originated. In his annual address as President of the Philosophical Society of Washington, lately published, Mr. John S. Billings says the word was a misnomer of the newspaper reporter, and, "as ordinarily used, is very comprehensive." Webster defines a scientist as "one versed in science, a *savant*." Mr. Billings, however, thinks that the suggestion conveyed by the word "is rather that of one whom the public suppose to be a wise man, whether he is so or not; of one who claims to be scientific." In his address, the subject of which is "Scientific Men and their Duties," he himself uses the term "in the broadest sense, as including scientific men, whether they claim to be such or not, and those who claim to be scientific men, whether they are so or not."

PROF. SARGENT, Director of the Arnold Arboretum of Harvard College, estimates that five foreign trees are planted in New England to one native. Yet, of all foreign trees introduced to America, the willow alone, he thinks, has qualities not possessed in a greater degree by some native. The European oak perhaps the most unsatisfactory deciduous tree that has been experimented upon: it grows rapidly when young, but fails, when about twenty years old, from the cracking of the main stem, and then, after dragging out a wretched existence a few years longer, it miserably perishes. The Scotch pine dies long before reaching maturity, and the Austrian and the Corsican seem to be no better. The Norway spruce, which has been for many years the most widely cultivated foreign tree in Massachusetts, becomes decrepit and unsightly just at that period of its life when trees should become really handsome in full development.

THE Sonnblick Observatory, in the province of Salzburg, Austria, is the highest in Europe, being 10,177 feet above the level of the sea. It was established chiefly through the exertions of M. Rojacher, proprietor of the mines in that district, in conjunction with the German and Austrian Alpine Club, and the Austrian Meteorological Society. Telephonic communication was established with Rauris, a distance of 15½ miles, and observations were commenced in September 1886. Observations at such elevated stations offer much that is of interest to science generally, and more especially as regards those problems of meteorology which relate to the variations of pressure, temperature, and humidity in the upper regions of the atmosphere.

In the *Meteorologische Zeitschrift* for February last, Dr. Hann gives an interesting account of the first three months' observations. The mean temperature in October was 25°·9 F.; in November 15°·3, and in December 8°·1. In October, the de-

crease of temperature with height during the barometrical minima was, generally, rapid. But during the barometrical maxima it was very slow in the lower strata, up to about 5900 feet; then an increase of temperature with height frequently occurred. The periods of high pressure were generally warm intervals on the Sonnblick, and the periods of low pressure were cold intervals. It is noteworthy, however, that the change of temperature with height, in the strata between about 5900 feet and the summit, was almost independent of the conditions of weather, being nearly constant during the whole month, and amounting to about 1°·3 F. per 328 feet (100 metres); while in the lower regions, from about 1300 feet to 5900 feet, it varied between 0° and 1°·1. And, generally speaking, the same rates of decrease of temperature obtained in November and December. During the period of high pressure, on October 1 to 5, which was the warmest part of the month, the march of relative humidity showed a great contrast at the high stations and at the valley stations, humidity being greatest at noon at the high stations, and lowest in the valleys. As regards wind, it may be remarked that early in November the anemometer became a shapeless mass of hoar frost. It remains to be shown what use can be made of the observations on such elevated stations for the practical work of weather-forecasting. The observers of the Pic du Midi claim to have foretold, from the conditions at that Observatory, the disastrous floods that occurred in the South of France at the end of June 1875, and thereby to have rendered important services by their timely warning.

THE Norwegian Government has taken another step towards discovering the origin and nature of the terrible disease leprosy, which is so common on the west coast of Norway, by despatching Dr. G. A. Hansen, Director of the Leprosy Hospital at Bergen, to North America, for the purpose of inquiring into the heredity of the disease among Scandinavian emigrants to the United States.

SOME interesting statistics concerning the libraries of the United States have been printed in America from advance sheets of the forthcoming Report of the Bureau of Education. There are in the United States 5338 libraries, each with 300 volumes or over. Of these, 2981 have each 1000 volumes or over. Forty-seven have each over 50,000 volumes; and among the forty-seven are the public libraries of Boston, Chicago, and Cincinnati, and the libraries of Harvard, Columbia, Yale, Cornell, and Brown Universities. These forty-seven libraries aggregate 5,026,472 volumes; and the whole list of 5338 libraries aggregates 20,622,076 volumes, or one volume to every three persons in the country. In round numbers the United States has one library to every 10,000 of population, though in many States the proportion is far greater. New Hampshire, for example, has a library to every 2700 persons. Massachusetts and Connecticut furnish a library to every 3134 and 3479 persons respectively. California, Colorado, Wyoming, and Michigan, are well up on the list. Arkansas, which stands lowest, has one library to every 50,158 of population.

SOME time ago we reviewed a little book entitled "A Year with the Birds," by an Oxford Tutor. A second edition has now been issued. The author has added a chapter on the Alpine birds, and has also made a considerable number of additions and corrections in the original chapters.

THE annual general meeting of the Linnean Society of New South Wales took place on January 26. The usual address was delivered by the President, Prof. W. J. Stephens, who presented a general summary of all the scientific work included in the year's Transactions. He also drew attention to the labours of other scientific Societies of Australasia during the preceding year, and concluded with some observations on scientific teaching in general schools.

THE additions to the Zoological Society's Gardens during the past week include a Malayan Bear (*Ursus malayanus*) from Malacca, presented by Mrs. Bingham; a Common Squirrel (*Sciurus vulgaris*), British, presented by Mr. H. B. Meadows; two Tree Pipits (*Anthus arboreus*), British, presented by Mr. W. B. Tegetmeier; two Dwarf Chameleons (*Chameleon pumilus*), two Robben Island Snakes (*Coronella phocorum*), a Toad (*Bufo augusticeps*) from South Africa, presented by the Rev. G. H. R. Fisk; two Pondicherry Vultures (*Vultur catuus*) from India, two Ocellated Sand Skinks (*Seps ocellatus*), South European, purchased; two Black Lemurs (*Lemur macao*), a White-fronted Lemur (*Lemur albifrons*), born in the Gardens.

ASTRONOMICAL PHENOMENA FOR THE WEEK 1887 APRIL 3-9

(FOR the reckoning of time the civil day, commencing at Greenwich mean midnight, counting the hours on to 24, is here employed.)

At Greenwich on April

Sun rises, 5h. 33m.; souths, 12h. 3m. 22'6s.; sets, 18h. 34m.; decl. on meridian, 5° 18' N.; Sidereal Time at Sunset, 7h. 21m.

Moon (Full on April 8) rises, 12h. 29m.; souths, 20h. 12m.; sets, 3h. 44m.*; decl. on meridian, 15° 47' N.

Planet	Rises		Souths		Sets		Decl. on meridian
	h. m.	h. m.	h. m.	h. m.	h. m.	°	
Mercury	4 57	10 50	16 43	2 13	15 46	13	S.
Venus	6 26	13 53	21 20	15 46	6 44	11	N.
Mars	5 44	12 22	19 0	6 44	11 12	22	N.
Jupiter	20 16*	1 22	6 28	11 12	2 29	2	N.
Saturn	10 13	18 22	2 31*	22 29			

* Indicates that the rising is that of the preceding evening and the setting that of the following morning.

Occultations of Stars by the Moon (visible at Greenwich)

April	Star	Mag	Disap.	Reap.	Corresponding angles from vertex to right for inverted image	
					h. m.	h. m.
7	46 Virginis	6	21 23	22 6	351	275
7	48 Virginis	6	22 59	0 27	28	271
8	B.A.C. 4647	6	19 57	near approach	302	—
9	94 Virginis	6	1 12	2 22	59	273

† Occurs on the following morning.

April 3 ... 13 ... Mercury stationary.
9 ... 3 ... Jupiter in conjunction with and 3° 20' south of the Moon.

Saturn, April 3.—Outer major axis of outer ring = 41"·9; outer minor axis of outer ring = 17"·5; southern surface visible.

Variable Stars

Star	R.A.		Decl.	h. m.
	h. m.	h. m.		
σ Persei	2 14·8	58 4	N.	Apr. 9, 9
ζ Geminorum	6 57·4	20 44	N.	" 4, 22 0 M
ν Cancri	8 37·5	19 26	N.	" 9, 21 57 m
V Bootis	14 25·2	39 23	N.	" 9, m
δ Libræ	14 54·9	8 4	S.	" 6, 21 55 m
U Coronæ	15 13·6	32 4	N.	" 6, 20 26 m
S Coronæ	15 16·8	31 47	N.	" 6, M
σ Scorpion	16 10·9	22 37	S.	" 4, M
R Ursæ Minoris	16 31·5	72 30	N.	" 5, M
U Ophiuchi	17 10·8	1 20	N.	" 3, 1 52 m
and at intervals of 20 8				
U Sagittarii	18 25·2	19 12	S.	Apr. 5, 3 0 m
R Scuti	18 41·5	5 50	S.	" 8, 2 0 M
β Lyræ	18 45·9	33 14	N.	" 3, 21 0 m
η Aquilæ	19 46·7	0 43	N.	" 7, 2 0 M
R Sagittæ	20 8·9	16 23	N.	" 6, 22 0 m
δ Cephei	22 25·0	57 50	N.	" 8, M
				" 4, 2 0 m
				" 7, 20 0 M

M signifies maximum; m minimum.

GEOGRAPHICAL NOTES

THE new number of the *Mittheilungen* of the Vienna Geographical Society contains several letters written by Dr. O. Lenz during his journey from Kasonge, on the Upper Congo, and the Shiré River, to the south of Lake Nyassa (June to December 1886). These letters are, to a large extent, occupied with details of the troubles which Dr. Lenz had with his men. Kasonge is a most unhealthy town. Bohndorf, Lenz's companion, was struck down with fever, and had to be carried most of the way, while small-pox broke out among his men, seriously hampering the proper work of the Expedition. Lenz left Kasonge on June 30, and reached the Island of Kavala, off the west shore of Lake Tanganyika, the head-quarters of Capt. Hore, on August 7. On the route he passed many villages recently built by Zanzibaris, the native population having retired into the forests and mountains. The region is mainly an open table-land, sometimes of a beautiful park-like aspect, and with the river-valleys thickly wooded. As Tanganyika was approached, the plateau rose to a height of 3000 to 4000 feet, with mountains rising from its surface to an equal height. The chief rock was granite, with crystalline slates, and wooded spurs. After staying a few days with Mr. Hore, Dr. Lenz crossed to Ujiji, which he reached on August 15. Here he found himself compelled to give up his proposed journey to Emin Pasha, and in a large boat he and his men sailed down the lake to the south shore, which he reached on September 27. Mr. Hore informed him that the Lukuga River now flows with a strong current out of Lake Tanganyika to the Lualaba. Mr. Hore, who has known the lake for ten years, assured Dr. Lenz that during that time its level has fallen 15 feet, and as the latter sailed down the lake he saw clearly enough the marks of the old shore-lines. With difficulty Dr. Lenz obtained assistance on the inhospitable south shore to continue his journey onwards to Lake Nyassa. This route has been traversed several times, and Dr. Lenz does not in these letters add much to our knowledge. It is a plateau with mountains rising from it to a considerable height, and to the south-west of Lake Tanganyika he came upon the sources of the Chambeze, which, flowing into Lake Bangweolo, may be said to form the remotest sources of the Congo. On October 17 he reached Nkonde, on Lake Nyassa, a station of the African Lakes Company, and thence made his way down the lake and on to the River Shiré, whence his last letter is dated, in December 1886.

IN the same number will be found the conclusion of Herr Glaser's paper on his journeys in South Arabia, in which he gives some important information on the various classes of the population. He speaks in the worst possible terms of the climate of the region: highland and lowland are equally bad, and deadly for Europeans.

THE leading paper in the last number of the *Verhandlungen* of the Berlin Geographical Society is Dr. Wolf's account of his important exploring work on the Sankuru, the great southern tributary of the Congo. This he navigated upwards from the Kasai, exploring its three great sources, the Lomomi, the Lusambo, and the Lubi. It is on the whole a magnificent water-way, its banks in many parts thickly wooded and densely populated. He gives much information concerning the two leading peoples here, the Bakutu and the Baluba, both of them evidently intruders on the Balua, the pygmy people referred to in our last number, the former coming from the north-west and the latter from the south-east. Herr Staudinger adds considerably to our knowledge of the Niger region in his narrative of his journey from Loko, on the Binué, to the kingdoms of Saria, Kano, Sanfara, Sokoto, and Gando.

HERR FERDINAND SEELAND contributed to a recent meeting of the Austro-German Alpine Club some useful data on the rate of movement of the Pasterz Glacier. On October 3 last he found the glacier entirely free from snow, and he was lucky enough to find six pegs which he inserted in 1882 near the Hofmann Hut straight across the glacier to the base of the Glockner, and also two stones which he laid down in 1884. In the four years 1882-86 the first peg had moved downwards 121·5 m. (i.e. at the rate of 3·5 mm. per hour), the second 162 m. (4·6 mm.), the third 175·5 m. (5 mm.), the fourth 192·3 m. (5·5 mm.), the fifth 201·5 m. (5·8 mm.), and the sixth 198·6 m. (5·7 mm.). Of the stones, in the two years one had moved 104·2 m. (5·9 mm.), the other 100·7 m. (5·8 mm.). According to these results (in the direction from the north edge of the glacier towards the centre), the mean rate of

movement on a slope of 4 to 5 degrees is 5.23 mm. per hour, or 125.1 mm. per day. Herr Seeland left the pegs and stones where they were, and laid down other marks for future measurements.

LIEUT. WISSMANN, who has already done so much good exploring work in the Congo region, started in November last on a fresh expedition, from Luluaburg, the station on the River Lulua, an affluent of the Kasai. Wissmann goes first to the junction of the Lubi with the Sankuru, the great southern tributary of the Congo. Thence he will endeavour to push northwards and explore the unknown country in which the Lulongo, the Chuapa, and the Lomami take their sources. He will then seek to reach Nyangwe, when he will make up his mind either to proceed northwards to the Muta Nziye, or south to explore the Lanji, the Lukuga, and the Upper Lualaba.

THE paper at Monday's meeting of the Royal Geographical Society was by Mr. J. T. Wills, on the region between the Nile and the Congo. It was a summary of all that we know of the region, and places us in a position to appreciate the value of any exploring work which may be done by Mr. Stanley. It deals succinctly with all recent explorations of the Upper Nile region, and with the intervening country between that and the Middle Congo. The valuable work of Dr. Junker, as well as that of Emin Pasha, receives special prominence. Mr. Wills rightly dismisses the Shari hypothesis in connexion with the Welle-Makua, and insists on the identity of the Makua and Mobangi. The Mobangi is known to be a waterway not inferior to the main Congo for practical purposes; deep, never less than 600 yards wide, even in February, when the Kuta Makua certainly (and it too apparently) is at its lowest level; and navigable at all times from Stanley Pool 650 miles thence straight north-north-east to lat. 4° 20' N. beyond the limit which the Congo State, by private treaty with Germany, has placed to its future "sphere of operations," and beyond the limits which the French will probably occupy if they win in their dispute with the Congo State as to which of the two shall not operate in the Mobangi basin. It is then found to turn sharply to the east, flowing from the east through a gap it has cut in a line of quartz and red clay hills 1000 feet high, hills which may be continuation of the hilly watershed between the Makua at Ali Kolo and the sources of the Ngala. One would expect rapids at such a place, but there is only a good current and some awkward rocks; after reconnoitering in a boat, Mr. Grenfell got the *Place* through easily, in February. Where we know the Kuta Makua next, they are placid and colossal; the Shinko at Marra is still 90 yards wide, 20 to 35 feet deep in October, and only 1980 feet above the sea. The average fall thence to Stanley Pool (1070 feet above the sea) is by this only some 9 inches to the mile, and the main Congo appears to nearly maintain this slope up to Bangala, beyond the Mobangi mouth.

BIOLOGICAL NOTES

INJURIOUS FUNGI IN CALIFORNIA.—The following facts recorded by Prof. W. G. Farlow are not without interest in Europe: *Nicotiana glauca*, abundant in Mexico, attracts attention by its pleasing foliage and graceful habit; it is a native of Buenos Ayres, but is acclimatised in Mexico. Within the last few years it has escaped from cultivation in California, and is now a common weed by the roadsides. At San Diego Prof. Farlow noticed that the leaves were badly attacked by a fungus which formed large, grayish-black spots on both sides of the leaves. Examination proved it to be *Peronospora hyoscyami*, De Bary, which was first found on *Hyoscyamus niger*, L., in Europe, where it does not appear to be at all common. Since it is well known that the species of *Peronospora* attack different species of flowering plants which belong to the same natural order, it is much to be feared that the disease which now attacks *N. glauca* may sooner or later extend to the cultivated tobacco, which belongs to the same genus. If this were to happen, the injury to the tobacco would be very great, since, by causing large spots on the leaves to rot, they would become worthless for manufacturing purposes. The question of the possible spread of the disease is one of importance, for it would be a very serious thing if it were to reach the great tobacco-growing regions of States like Virginia.

FERTILISATION OF CASSIA MARILANDICA.—The relation of insects to flowers continues to be a question of profound interest,

but Mr. Meehan thinks that the dependence of a plant on insect aid is rather an indication that, instead of any material aid to its race being gained, its race is nearly run; he thinks that the opposite assumption has been an injury to the study of the main questions on fertilisation, and that the statements of Darwin and Asa Gray do not warrant the generalisations that have been drawn from them. In *C. marilandica* the phenomena attending pollen-formation are curious and apparently little known. The stamens are arranged in different sets. There are three beneath the pistil—the two lateral ones are very strong and equal the pistil in length, the central one immediately beneath the pistil is as long as those on each side, but more slender. Immediately above the pistil are four stamens, with short stout filaments, the anthers being perfectly formed and nearly as long as in the lower set. Above are three petaloid stamens. All the stamens have long black anthers, full of pollen, but which seems never to burst the anther cases. The only opening is at the apex, and this opening is covered by a membrane—never opening except by insect agency. As soon as the flower expands it is freely visited by humble-bees, and, as their loaded thighs evidence, for the pollen. To collect this they alight on the anthers of the long and lower stamens, as on a platform, make an opening in the apex of each of the four shorter ones, and then rifle them of their contents. A mass of plants containing eighty-eight flower-stems was watched on July 30, and the same lot for an hour on August 6, but no attempt was seen to be made by the bees to get the pollen from the longer anthers, or to use them in any way but as a platform. It would be very difficult for the bees to stand anywhere so as to have power to pierce the apical membranes of the longer stamens. When the flowers matured, and the anthers were ready to fall, they were examined, the four short ones were empty sacs, the three lower ones were full of pollen. These latter served no visible object to the flower or its insect visitors. While, however, no pollen could be detected on the stigmatic surfaces, still three out of every twelve flowers yielded a pod, and panicles of flowers covered so as to prevent egress of insects, neither produced fruit nor did a single anther open at its apex. In this case it would appear as if the fertilisation depended on the accident of the extracted pollen escaping from the insect to the stigma, and yet to an ordinary observer this plant would seem one specially arranged for cross-fertilisation. (Proc. Acad. Nat. Sci. Phil. 1886, p. 314.)

VARIATIONS IN THE NERVE-SUPPLY OF THE LUMBRICALES MUSCLES IN THE HAND AND FOOT, WITH SOME OBSERVATIONS ON THE PERFORATING FLEXORS.—Dr. H. St. John Brooks has lately investigated the subject of the varieties in the nerve-supply of the lumbricales. He finds—(1) Discrepancies in the statements of English and Continental anatomists. All these writers appear to be in error about the normal or commonest arrangement of the nerves to these muscles in the foot, and they appear never to have noticed a *double* supply to the third lumbrical in the hand. (2) Varieties of innervation that the author has observed in man, with an account of the nerve-supply in the orang, gibbon, and macaque monkey. He has discovered nerves entering the deep surface of the second (or indicial) lumbrical muscle in both hand and foot; these nerves, he believes, have never before been described: the latter, however, has been seen by Prof. D. J. Cunningham in the foot of a negro, and is recorded by him in his notes (as yet unpublished) of the anatomy of the negro foot. The following statistical table is compiled from the author's notes:—

Table of Variations in the Innervation of Lumbrical Muscles

HAND		Cases
First and second by median; third and fourth by deep ulnar	...	9
Third by median and deep ulnar (others as before)	...	6
Second and third by deep ulnar	...	1
First, second, and third by median (deep dissection not carried out)	...	2
	Total	18
FOOT		
First by internal plantar; second, third, and fourth by deep external plantar	...	8

In the orang, gibbon, and macaque, the second lumbrical of the foot was supplied as in the above table. (3) Prof. Cunningham (*Challenger Reports*, vol. xvi.) has shown that, in *Thylacinus*

and Cucus, the lumbricals of the manus are all supplied on their superficial surface; a similar arrangement is found in the pes of the fox-bat; here, however, the deep external plantar also furnishes twigs to the two outer lumbricales. (4) It appears probable from these facts that the lumbricals were all originally supplied on their superficial surface: the deep nerve (ulnar in hand, external plantar in foot) is, on this hypothesis, gradually displacing the superficial (median; internal plantar). This invasion of the deep nerve has advanced further (in the case of the lumbricals) in the human foot than in the hand. The reverse is the case with the innervation of the short muscles of the pollex and hallux. (5) There is a general correspondence between the innervation of a particular lumbrical muscle and that belly of the long perforating flexor of which it is a part; this fact is best made out in the case of the first or indicial lumbrical of the hand and the indicial belly of the flexor perforans, which are both supplied by the median; it is also seen in the fourth lumbrical and the belly of the long flexor ending in the tendon to the little finger (both by ulnar); also in the third lumbrical and annular belly (both of which have typically a double nerve-supply). In the foot and leg this part of the investigation presents special difficulties, which have, however, in a measure been overcome by minute dissections of the posterior tibial nerve and its branches, conducted under water. (*Dublin University Reports.*)

ON CERTAIN MODERN DEVELOPMENTS OF GRAHAM'S IDEAS CONCERNING THE CONSTITUTION OF MATTER¹

I.

THERE is a certain fitness in our selecting this place to do honour to-night to the memory of Thomas Graham. For was in the chemical laboratory of this Institution that Graham carried out, upwards of half a century ago, the experimental investigations which culminated in his memorable discovery of the law connecting the rate of movement of a gas with its density. This law, combined with that of Boyle, which connects the volume of a gas with its pressure, and with the law of Charles, which expresses the relations of the volumes of gases to heat, has done more to give precision to our knowledge of the constitution of matter than all the speculations of twenty centuries of schoolmen.

Graham was made Professor of Chemistry in the Andersonian Institution in 1830, and it was from here that he gave to the world his classical paper "On the Law of the Diffusion of Gases," read before the Royal Society of Edinburgh, December 19, 1831. I am fully conscious that my only claim to be regarded as worthy to pronounce this eulogium of Graham arises from the circumstance that I also have had the good fortune to hold the Lectureship of Chemistry in this place; and with forerunners like Birkbeck, Gregory, and Graham, I may well be proud of an honourable and distinguished ancestry. This association with the Andersonian Institution naturally quickened my interest in Graham and his works, and my frequent opportunities of conversation with the late Dr. James Young, of Kelly, who for so many years was its President, and who was, as we all know, also one of Graham's discoveries, and for a long time, both here and in London, one of his most trusted assistants, enabled me to learn much of Graham's personal character and mode of work. On the occasion of the gift of Brodie's fine statue of Graham to the city by Dr. Young it fell to my lot to prepare the short biographical notice of my distinguished predecessor, which, with other papers relating to the matter, is, I understand, deposited in the archives of your Corporation. And I may be pardoned, perhaps, for recalling with what mingled feelings of pride and trepidation I set myself to the execution of that task.

In the preface to the admirable reprint of Graham's papers which we also owe to the filial piety of Dr. Young, the late Dr. Angus Smith has indicated in precise and even luminous language Graham's position in that chain of thinkers which includes Leucippus, Lucretius, Newton, and Dalton. Indeed, of all Angus Smith's papers with which I am acquainted there is none, to my thinking, more charming than this little introductory essay of a dozen octavo pages, in which, with unwonted perspicacity, he has defined Graham's place in the history of speculative philosophy. Angus Smith has here crystallised out, as it were, the thoughts of a life-time of literary research and meditation. Pro-

¹ The Triennial "Graham Lecture," given in the Hall of the Andersonian Institution, Glasgow, on March 16, by Prof. T. E. Thorpe, F.R.S.

bably, no man—certainly no contemporary of Graham's—was better fitted by knowledge and by sympathy to form a sound critical estimate of such a position than the biographer of John Dalton. Angus Smith's mind was simply steeped in the old Hellenic philosophy. To him even Kapila was more than a name, and the atomic systems of India matters of more than conjecture or of passing interest. There was much in Smith's intellectual nature to make such inquiries congenial to him. With all his leaning towards objective science he had a Highlander's love of the mystical and a Lowlander's passion for metaphysics. And yet nothing is more admirable than the manner in which, in this essay, these qualities and this wealth of learning are subordinated and held in check, and nothing more striking than the way in which, in a few graphic strokes, done with a master hand, lightly yet firmly, with a consciousness of power and a sense of restraint, Graham's place in the evolution of the atomic philosophy is set forth.

It is here claimed for Graham that he was a true descendant of the early Greeks, and that to him belonged as of right the mantle of Leucippus. Atoms and eternal motion were as much fixed articles of his creed as they were of that of Heraclitus. But with no one of the older Greeks was Graham's thought more in harmony than with that of Leucippus. He, with his wider knowledge of the so-called "elemental" forms of matter, and of the persistency with which the specific properties which we associate with our "elements" are retained, could yet share with the old Greek his conceptions of the essential oneness of matter. It was with Graham, as Smith says of Leucippus, that "the action of the atom as one substance taking various forms by combinations unlimited, was enough to account for all the phenomena of the world. By separation and union, with constant motion, all things could be done."

In one respect Graham's position as an atomist is unique: no man before him had dedicated his life to the study of atoms and atomic motion. These fundamental ideas are intertwined to make up, so to say, the silver thread which runs through the work of forty years. They were the dominant conceptions of his life. Even in his earliest paper, published when he was just twenty-one, in which he treats of the absorption of gases by liquids, we are able to detect in the phraseology employed that his mind had been already permeated by the notion of atomic movement. That he should be familiar, even at this time, with the conception of atoms in the Daltonian sense is hardly surprising when we remember that he had already come under the influence of Thomas Thomson, whose place in the history of science is probably that of the first great exponent of Dalton's theory of chemical combination. But the idea of motion was never with Dalton an integral part of his theory, nor, in so far as it was necessary as serving to explain the phenomena of chemical union, was it held by Thomson. And this is the more remarkable when we remember that Dalton had discovered for himself the fact of the molecular mobility of a gas, and that his first glimpses of the truth of his great law were obtained by the study of chemical combination among gases. Graham was doubtless cognisant, in a general way, of the speculations of the early Greeks, but there is no evidence in any of his writings, nor has anything been preserved in the reminiscences of his friends and contemporaries, to indicate that he was knowingly influenced by them.

This continuity of idea is indeed the most striking characteristic of Graham's labours; all his work seemed to centralise round this fundamental conception of atomic motion. "In all his work," says Smith, "we find him steadily thinking on the ultimate composition of bodies; he searches after it in following the molecules of gases when diffusing; these he watches as they flow into a vacuum or into other gases, and observes carefully as they pass through tubes, noting the effect of weight and of composition upon them in transpiration. He follows them as they enter into liquids and pass out, and as they are absorbed or dissolved by colloid bodies, such as caoutchouc: he attentively inquires if they are absorbed by metals in a similar manner, and finds the remotest analogies, which, by their boldness, compel one to stop reading and to think if they be really possible. He follows gases at last into metallic combination, and the lightest of them all he makes into a compound with one of the heavier metals, chasing it finally through various lurking-places until he brings it into an alloy and the form of a medal, and puts upon it the stamp of the Mint. Indeed he is scarcely satisfied even with this, and he finds in bodies from stellar places—in meteoric iron—this same metallic hydrogenium which he draws out from its long prison in the form of a gas. . . . If we examine his work on Salts and on Solutions we have a similar train of thought. One

might have slighted the importance which he attached to the water of salts and the temperature at which it was reduced, but in his hands it was a revelation of some of the most mysterious internal phenomena of these bodies.

"A chemist must take great pleasure in following Graham when he seeks the laws of the diffusion of liquids and traces their connections, especially when they lead to such results as he expressed by dialysis, a process founded on a new classification of substances, and promising still the most valuable truths. We see in the inquiry how Graham thought on the internal constitution of bodies, by examining the motion of the parts, and from the most unpromising and hopeless masses under the chemist's hands—amorphous precipitates of alumina or of albumen—brought out analogies which connected them with the most interesting phenomena of organic life. Never has a less brilliant looking series of experiments been made by a chemist, whilst few have been so brilliant in their results or promise more to the enquirer who follows into the wide region opened."

In a short paper entitled "Speculative Ideas respecting the Constitution of Matter," originally published in the Proceedings of the Royal Society for 1863, Graham has left us his Confession of Faith upon the subjects to which he had devoted the whole of a thoughtful life. He conceives that the various kinds of matter now recognised as different elementary substances may possess one and the same ultimate or atomic molecule existing in different conditions of movement. Graham traces the harmony of this hypothesis of the essential unity of matter with the equal action of gravity upon all bodies. He recognises that the numerous and varying properties of the solid and liquid, no less than the few grand and simple features of the gas, may all be dependent upon atomic and molecular mobility. Let us imagine, he says, one kind of substance only to exist—ponderable matter; and further that matter is divisible into ultimate atoms, uniform in size and weight: we shall have one substance and a common atom. With the atom at rest the uniformity of matter would be perfect. But the atom possesses always more or less motion, due, it must be assumed, to a primordial impulse. This motion gives rise to volume. The more rapid the movement the greater the space occupied by the atom, somewhat as the orbit of a planet widens with the degree of projectile velocity. Matter is thus made to differ only in being lighter or denser matter. The specific motion of an atom being inalienable, light matter is no longer convertible into heavy matter. In short, matter of different density forms different substances—different nonconvertible elements as they have been considered.

It should be said that Graham uses the terms "atom" and "molecule" in a wider sense than that which the limitations of modern chemistry have imposed upon them, and that he is referring to a lower order of molecules or atoms than those which more immediately relate to gaseous volume. The combining atoms of which he conceives the existence are not the molecules of which the movement is sensibly affected by heat with gaseous expansion as the result. According to Graham, the gaseous molecule must itself be viewed as composed of a group or system of the inferior atoms, following as a unit laws similar to those which regulate its constituent atoms. He is in fact applying to the lower order of atoms ideas suggested by the gaseous molecule, just as views derived from the solar system are extended to the subordinate system of a planet and its satellites.

We cannot as yet fix any limit to this process of molecular division. To Graham the gaseous molecule is a reproduction of the inferior atom on a higher scale. The diffusive molecules, the molecules or systems which are affected by heat, are to be supposed uniform in weight but to vary in velocity of movement in correspondence with their constituent atoms. Hence the molecular volumes of different elementary substances have the same relation to each other as the subordinate atomic volumes of the same substances.

On this basis Graham builds up a conception of chemical combination. He points out, in the first place, that these more and less mobile or light and heavy forms of matter have a singular relation connected with equality of volume. Equal volumes of two of them can coalesce together, unite their movement and form a new atomic group, retaining the whole, the half, or some simple proportion of the original movement and consequent volume.

Chemical combination thus becomes directly an affair of volume and is only indirectly connected with weight. Combining weights are different because the densities, atomic and molecular, are different. The volume of combination is uniform,

but the fluids measured vary in density. This fixed combining measure—Graham's *metron* of simple substances—weighs 1 for hydrogen, 16 for oxygen, and so on with the other "elements."

Graham, however, points out that the hypothesis admits of another expression. Just as in the theory of light we have had the alternative hypotheses of emission and undulation, so in molecular mobility the motion may be assumed to reside either in separate atoms and molecules, or in a fluid medium caused to undulate. A special rate of vibration or pulsation originally imparted to a portion of the fluid medium enlivens that portion of matter with an individual existence, and constitutes it a distinct element or substance.

The idea of the essential unity of matter finds its analogy, to Graham's thinking, in the continuity of the so-called physical states of matter. He clearly perceived that there is no real incompatibility in the different states of gas, liquid, and solid. These physical conditions are, indeed, often found together in the same substance. The liquid and the solid conditions supervene, as Graham puts it, upon the gaseous condition rather than supersede it. They do not appear as the extinction or suppression of the gaseous condition, but as something superadded to that condition. Graham conceives that the three conditions (or constitutions) probably always co-exist in every liquid or solid substance, but one predominates over the others, just as the colloidal condition or constitution which intervenes between the liquid and crystalline states extends into both, and probably affects all kinds of solid and liquid matter in a greater or less degree. Hence, to Graham's thinking, the predominance of a certain physical state in a substance appears to be a distinction analogous to those distinctions in natural history which are produced by unequal development. Liquefaction or solidification does not involve the suppression of the atomic or molecular movement but only the restriction of its range.

Such then are Graham's ideas, formulated in 1863, respecting the probable constitution of matter. I have purposely stated them in great detail, and for the most part in Graham's own words. The paper is very short, but it has evidently been put together with great care. It is impossible not to be struck with the evidence it affords of Graham's insight, his grasp of principles and power of co-ordination. Consider, for example, what he says respecting the continuity of the so-called physical states of matter, and bear in mind upon what an extremely small experimental basis it rested at that time. The observations of Cagnard Latour were almost forgotten, or at all events their significance was not understood. The classical work of Andrews was not yet published. And yet this work and that of a dozen experimentalists in France, Russia, and Germany, has only served to confirm and expand Graham's fundamental conception. The whole paper shows Graham in a very different light from that in which the student of to-day might be apt to regard him. The greater number of his memoirs are mainly the records of measurements, but Graham was not a great measurer in the sense in which we apply that term to such men as Regnault, Magnus, or Bunsen. Very little of his work was done by his own hands, and it must be confessed that the earlier experimental portion was occasionally intrusted to apparently inexperienced assistants. Graham had, however, the *förscherblick* which characterises the true investigator, and he possessed a really marvellous faculty of sifting out the small grain of fact which often lay hidden beneath a mass of imperfect observation. And yet he was in no hurry to theorise. He patiently added fact to fact, repeating and verifying his observations long after he had got an inkling of the truth towards which they were tending. He laboured like Faraday, *ohne Hast, ohne Rast*, and his work is a monument of patient, concentrated thought, and of a singleness of purpose which never swerved.

"Experimentalist philosophers" of Graham's type (to use a phrase which Hobbes of Malmesbury once flung at the progenitors of the Royal Society) have very similar intellectual tendencies. One is insensibly led to compare Graham with the greatest of our English atomists—John Dalton. If you will turn to Dr. Henry's "Life of Dalton," and read the charming analysis of Dalton's mental characteristics, made by one who knew him well and who had studied him carefully, you will find that practically all that is there stated is equally applicable to Graham. Both men were pre-eminently endowed with the faculty of contemplating abstract relations of space and number, and each began his researches with the expectation that all empirical phenomena were to be brought under the control of mathematical laws. Thus Dalton strove to prove that the

changes produced in the gaseous and liquid states of matter vary as the square, cube, or some other simple function of the temperature; Graham, in like manner, sought to show that the movement of his diffusive molecules, whether in liquids or in gases, was related to some equally simple function of their mass. Henry says of Dalton that "his inmost mental nature, and all its outward manifestations were in the language of the German metaphysicians, emphatically subjective. Thus in special or objective chemistry he has left absolutely no sign of his presence; no great monograph on an individual body and its compounds; no memorable analysis of a substance deemed simple into yet simpler elements; no new element—no Neptune—added to the domain of chemistry." Every word of these sentences could be applied with equal truth to Graham. The tendencies of both men were essentially introspective. Each was capable of the most patient concentrated thought and of steady prolonged attention, wholly abstracted from external objects and events. I have heard the late Dr. Young narrate the most extraordinary instances of Graham's power of mental abstraction. Dalton said of himself that, "If I have succeeded better than many who surround me, it has been chiefly, nay, I may say, almost solely, from unwearied assiduity. It is not so much from any superior genius that one man possesses over another, but more from attention to study and perseverance in the objects before them, that some men rise to greater eminence than others."

It seems like a contradiction in terms when we reflect for a moment upon the characteristic features and tendency of his work, to say that Graham, like Dalton, was utterly devoid of the quality we call imagination. Henry says of Dalton that imagination had absolutely no part in his discoveries; except, perhaps, as enabling him to gaze, in mental vision, upon the ultimate atoms of matter, and as shaping forth those pictorial representations of unseen things by which his earliest as well as his latest philosophical speculations were illustrated. Graham would not allow his fancy even that amount of play. Even in the speculative essay from which I have quoted so largely, it seems; as if every word had been weighed and every sentence put together with slow laborious thought. This passionless aspect of his work seems to have greatly impressed Angus Smith, himself a man of lively sympathy and of quick susceptibility. "His works," says Smith, "are full of care, but not of joy."

(To be continued.)

SCIENTIFIC SERIALS

American Journal of Science, March.—On the absolute wave-length of light, by Louis Bell. The experiments here described were undertaken with a view to check the results obtained by C. S. Pierce for Prof. Rowland's great map of the solar spectrum, and to furnish a value of the absolute wave-length as nearly as possible commensurate in accuracy with the micrometrical observations. For the wave-length of D, at 20° C. and 720 mm. pressure, Mr. Bell obtains 5896'08, or *in vacuo* 5897'71, as compared with 5896'22, Rowland's micrometer measure from Pierce's preliminary result, and 5895'89, Thalén's correction of Ångström, both in air at ordinary temperature and 760 mm. pressure. But neither of these was corrected for errors in the gratings; hence, obviously, the cause of the discrepancy.—On the relative wave-length of the lines of the solar spectrum, by Prof. Henry A. Rowland. This measurement of the relative wave-lengths of the spectrum and its reduction to absolute wave-lengths by some modern determination has been undertaken in connexion with the photographic map of the solar spectrum on which the author has been engaged for several years, and which is now finished from the extreme ultra-violet wave-length 3200 down to wave-length 5790. Appended are tables of coincidences and of wave-lengths of standard lines.—The norites of the "Cortlandt series" on the Hudson River, near Peakskill, New York (continued), by G. H. Williams. Here are studied the mica norites, the sagite norite (hyperite), pyroxenite, and the iron ore and emery in the Cortlandt norite. Owing to incipient alteration, easily visible under the microscope, the West-Chester County emery appears to be of less commercial value than that of Asia Minor.—Natural solutions of cinnabar, gold, and associated sulphides, by George F. Becker. In the course of investigations on the geology of the quicksilver deposits of the Pacific slope, the author has made some studies, here detailed, on the question of the state of combination in which quicksilver is dissolved in natural waters. The solubility of zincblende, pyrite (marcasite),

copper sulphides, gold, and other associates of cinnabar, is incidentally examined, the quantitative analysis involved in the process being made by Dr. W. H. Melville.—Fluviatile swamps of New England, by N. S. Shaler. In examining the freshwater swamps of this region, the author has carefully studied the geographical distribution of those formed along the banks of rivers. Although the inquiry is mainly limited to the post-glacial changes in the valleys trending northwards, much light is incidentally thrown on the pre-glacial altitude of the continent. It is made evident that these valleys could not have been excavated by streams of their present slope; hence the inference that the descent of the northward flowing rivers must have been more rapid in pre-glacial times than at present; in other words, this part of the continent was at that time relatively less elevated in its northern parts than it is at present.—On the Mazapil meteoric-iron which fell on November 27, 1885, by William Earl Hidden.—On observations of the eclipse of August 18, 1887, in connexion with the electric telegraph, by Prof. David P. Todd. Referring to his remarks in the Proceedings of the American Academy of Arts and Sciences for 1881, p. 359, the author points out how the proposed method of telegraphic transmission of important observations might be adopted during the eclipse of August 18 next.—On two new meteorites from Carroll County, Kentucky, and Catorze, Mexico, by George F. Kunz. The Kentucky iron has some ethnological interest in connexion with the ornaments of meteoric iron occurring in the mounds of the Little Miami Valley, Ohio, all apparently belonging to one and the same meteoric fall. The Catorze mass, weighing 92 pounds, was found near Catorze, San Luis, Potosi, in 1885. It is one of the caillite group of Stanislas Meunier, and shows the Widmanstätten lines very finely. Analysis: Fe 90'09; Ni and Co 9'07; P 0'24; with specific gravity 7'509.

Rivista Scientifico-Industriale, February.—On the cause of the electric discharge accompanying thunderstorms, by Prof. G. Guglielmo. The views of Ermann and Peltier are here subjected to close scrutiny, and shown to be inadequate to account for these electric phenomena.—On the variations in the electric resistance of antimony and cobalt in the magnetic field, by Dr. G. Facé. The author's researches show that, apart from the intensity of the observed effects, antimony behaves in the way determined by Righi for bismuth, and cobalt in the way determined by Thomson for iron and nickel.

Rendiconti del Reale Istituto Lombardo, February.—Summary of the meteorological observations recorded in the Brera Observatory, Milan, during the year 1886, by E. Pini. The daily, monthly, and annual means are tabulated for the atmospheric pressure, temperature, rainfall, velocity, and direction of the winds throughout the year.—Meteorological observations for the month of January, 1887, at the same Observatory.

SOCIETIES AND ACADEMIES

LONDON

Royal Society, March 10.—"Note on Induction Coils or 'Transformers.'" By John Hopkinson, M.A., D.Sc., F.R.S.

"Note on the Theory of the Alternate Current Dynamo." By John Hopkinson, M.A., D.Sc., F.R.S.

March 17.—"The Embryology of Monotremata and Marsupialia." Part I. By W. H. Caldwell, M.A., Fellow of Gonville and Caius College, Cambridge. Communicated by Prof. M. Foster, Sec. R.S. (Abstract.)

(1) *The Egg-membranes*.—In Monotremata, in very young ova, a fine membrane exists between the single row of follicular cells and the substance of the ovum. This membrane, which I will call the *vitelline membrane*, at first increases in thickness with the growth of the ovum, and through it pass numerous fine protoplasmic processes connecting the protoplasm of the follicular cells with that of the ovum, and serving to conduct food granules, which, appearing in the neighbourhood of the nuclei of the cells, travel thence to the ovum; food granules also appear in the neighbourhood of the germinal vesicle, and travel away from it: hence the horseshoe-shape of the yolk-mass as seen in section.

The author being at the present time in Australia and so unable to correct the proof of this abstract, I have undertaken this duty. In doing so I have ventured, for the sake of what appeared to be increased clearness, to introduce into it some modifications of the author's manuscript, being guided therein by the author's more detailed account given in the fuller paper.—M. FOSTER, Sec. R.S.

the time during which food granules are thus passing from the follicular cells to the ovum may be called "the yolk forming period."

It is succeeded by a period during which the vitelline membrane again becomes thin, the follicular cells are reduced to a single layer, and the cells are very thin and flat. This period may be called the "absorption of fluid period," since during it the ovum absorbs large quantities of fluid through the thin vitelline membrane and single layer of thin follicular cells, and thereby increases largely in size.

This is in turn succeeded by a third period, during which the follicular cells again become active, multiply, increase greatly in size, and give rise between themselves and the vitelline membrane to a deeply standing homogeneous layer, which I will call the *chorion*. This period may hence be called "the chorion forming period." All these three periods are gone through while the ovum is still in the follicle.

Upon the bursting of the follicle and the reception of the ovum in the Fallopian tube, a few of the follicular cells remain attached to the chorion; the majority are left behind within the first follicle.

During the passage along the Fallopian tube, the vitelline membrane again increases in thickness, and the chorion, also increasing in thickness, absorbs fluid and becomes the *albumen layer*. Outside this now appears a new structure, the *shell* or shell-membrane, of tough parchment-like consistency, not staining with reagents. I have not yet traced the deposition of the shell to the activity of any special glands; but I can say that the shell-membrane does not increase at the expense of the chorion or albumen layer.

After reaching the uterus both vitelline membrane and shell-membrane increase in thickness, but the albumen layer diminishes and disappears, serving apparently for the nutrition of the ovum. Immediately beneath the vitelline membrane a new layer is now seen in hardened preparations; but it may be shown that this layer is really fluid, yielding a coagulum which stains deeply with reagents, the fluid being apparently derived, through the membranes, from the uterine glands.

In Marsupialia the history of the vitelline membrane, save that the yolk forming period² is not marked off from the "absorption of fluid" period, is similar to that in Monotremata. I have not been able to trace the beginning of the "chorion" while the ovum is still in the ovary, in Marsupialia; but in an ovum of *Phascolarctos* from the uterus, I found a chorion like that of Monotremata, and surrounded moreover by a thin transparent membrane—a *shell-membrane*. Within the uterus the chorion, increasing in thickness, becomes transformed into an albumen layer, and is eventually absorbed, passing through the vitelline membrane to nourish the ovum, so that eventually the vitelline membrane comes to be close to the shell.

As in Monotremata, a coagulable, and, when coagulated, deeply staining fluid makes its appearance between the vitelline membrane and ovum (blastoderm).

The shell-membrane persists until the developing ovum becomes fixed to the walls of the uterus, after which it disappears.

The paper then compares the egg-membranes just described with those of Placentalia, and those of Vertebrata generally.

(2) *Segmentation*.—The telolecithal ova of Monotremata and Marsupialia go through a partial segmentation. The ova of Placentalia segment completely, but the resulting blastodermic vesicle is identical with that produced by partial segmentation in Monotremata and Marsupialia.

In Monotremata there is a posterior lip to the blastopore similar to that of Elasmobranchii. The epiblast grows in so rapidly from the sides, that a primitive streak region is formed in front of the posterior lip long before the epiblast has enclosed the yolk. This uninclosed area in front of the primitive streak probably includes a region where the hypoblast (yolk) is secondarily broken through the epiblast. The existence of such a region would hide the position of the anterior lip of the blastopore. The circumference of the circle made up by the larger arc of the edge of the blastoderm on the yolk, and the smaller arc of the posterior lip of the blastopore, is a measure of the quantity of yolk in a meroblastic ovum.

In Marsupialia the epiblastic growth incloses the hypoblast at a very early age, except over a narrow slit in front of the posterior lip of the blastopore. This slit corresponds to the area inclosed by the circle described above in a meroblastic egg. The primitive

streak is not conspicuous at an early age because of the large size of the cells. No hypoblast projects through the epiblast in front of the primitive streak region. I would explain the segmentation and the gastrula of Placentalia in the same way. Balfour's objection ("Comp. Embryol." vol. ii. p. 187) to Van Beneden's original comparison of the blastopore of the rabbit with that of a frog, is explained away by the presence of a posterior lip to the blastopore in Marsupialia. My explanation postulates the existence of a similar structure in the rabbit. The blastopore of the rabbit corresponds therefore to the whole area marked out by the growing epiblast and the posterior lip of the blastopore, before the closing of the primitive streak region, or to this area minus the secondary extension, caused by the projecting yolk, in Monotremata.

Linnean Society, March 17.—Mr. W. Carruthers, F.R.S., President, in the chair.—A recommendation of the Council to present to the British Museum, Kew, and the Oxford Botanical Gardens, the Society's carpological collection was submitted to the Fellows, but not approved by them.—Mr. C. B. Clarke, F.R.S., was elected into the Council in the place of Dr. H. Trimen, who resigned.—Mr. A. O. Walker read a paper on the Crustacea of Singapore. These were collected by Surg.-Major Archer during 1879-83. The species were chiefly dredged in 15-20 fathoms, or got on shallow banks. A full list is given of all the forms identified, and several new species are described. Among these are: *Doclea tetraoptera*, *Xanthe scaberrimus*, *Maii miersii*, and *Caphyra archeri*.—A paper was read by Dr. Geo. King, on the genus *Ficus*, with special reference to the Indo-Chinese species. The genus *Ficus* was founded by Linnæus, and included seven species ("Species Plantarum," 1st ed.) Later editions contained 118 species. Blume described 93 Malayan figs, and Roxburgh 55 Indian species. In the "Hortus Cliffortianus" Linnæus clearly comprehended the difference of the sexes, *i.e.*, Caprifig = male, the so-called Fig = female, and *Erimosyce* = hermaphrodite. Vahl seems to have misunderstood the arrangement of the sexes, and Blume apparently followed him. Roxburgh is the first writer who examined minutely the florets of nearly the whole of the species, finding two androgynous and the majority monandrous. Later on Gasparini and Miquel each made a careful study of the flowers of the genus, and separately gave different classifications of the group. Miquel subsequently altered his arrangement, making divisions into six sub-genera, while enumerating 405 Old World, 128 American, and twenty-two species of doubtful nativity. In the "Genera Plantarum" of Bentham and Hooker four of Miquel's sub-genera are admitted, a fifth considered doubtful, and a sixth rejected. These authors regarded Miquel's divisions as too loosely defined, and recommended a re-working of the group. Dr. King goes into a lengthened description of the structural peculiarities of the flowers of the genus *Ficus*. He specifies (1) male, (2) pseudo-hermaphrodite, (3) neuter, and (4) female fertile flowers. Besides these, he states that there occurs in all the species of *Ficus* a set of flowers originally named by himself "*insect-attacked-females*," but for which he has adopted Count Solms-Laubach's term "*gall-flowers*" (*Bot. Zeit.* 1885); the latter botanist having anticipated him in publication, though King's researches had been commenced earlier. King enters into the question of these gall-flowers, stating that, in the majority, the pupa of an insect is present, and this pupa can usually be seen through the coats of the ovary. The pupa when perfected escapes into the cavity of the receptacle by cutting its way through or by bursting these coats; and fully-developed winged insects are often to be found in considerable numbers in the cavity of the fig. The opening through which each insect has escaped from the ovary in which it has been developed is afterwards clearly visible. The pupa of the insect must become encysted in the ovary of the gall-flower at a very early period, for about the time at which the imago is escaping from the ovary the pollen of the anthers of the male flower is only beginning to shed. Now, there is nothing in itself remarkable in the mere occurrence in the genus of numerous flowers having the general form of females, which yet by reason of certain peculiarities in their structure are incapable of fertilisation by pollen practically barren; while at the same time their structural defects fit them for becoming the nidus for the larvae of special insects. But, when the manner in which these malformed female flowers are disposed in the receptacle is inquired into, it becomes clear that through the interposition of insects these malformed female flowers may play a most important part in the life-history of many species of the genus *Ficus*. Thus from the peculiarities in the structure and arrangement of

² In the laid egg of *Echidna* I have not detected calcic salts, but that of *raithorhynchus* gives rise to gas when treated with dilute acid.

the flowers, Dr. King is of opinion that the evolutionary history of the genus *Ficus* may be traced. On data derived therefrom he arranges the Indo-Malayan species into two great groups, the second of these being again divided into three subsidiary sub-groups as follows:—

<i>Ficus</i> , Linn.	Group I. Pseudo-hermaphrodite.	Sect. 1	Palæomorphe	
		Sect. 2	Urostigma	
	Group II. Unisexual	Sect. 3	A	Synœcia
			B	Scydium Covellia Eusyce Neomorphe

Physical Society, March 12.—Prof. G. Carey Foster, Vice-President, in the chair.—Mr. Shelford Bidwell described some experiments which seem to show that the electrical resistance of suspended copper and iron wires, alters with the direction of the testing current. The apparatus used consisted of a metre bridge with coils of 100 ohms in the gaps adjoining the standard wire, the other two arms being two suspended wires united at the top, to which point one terminal of the galvanometer was joined. A commutator placed in the battery circuit served to reverse the testing current. When a wire is suspended vertically the stress increases from below upwards, and the author believes the observed effects to be due to the absorption of heat by the current as it passes from a stretched towards an unstretched part of a copper wire, and the evolution of heat when it passes from an unstretched towards a stretched part. As the apparatus was arranged the current passed up one side and down the other, heating the one and cooling the other, thus disturbing the position of balance. If iron wires were used the heating and cooling effects were reversed. Prof. S. P. Thompson suggested loading the wires at different points in order to vary the stress without using such long wires, and Mr. C. V. Boys thought still shorter wires could be used by joining the ends to a revolving spindle and stretching them by centrifugal force.—On a lecture experiment in self-induction, by Mr. Shelford Bidwell. A telephone is placed in series with the secondary coil of an induction coil and another coil whose self-induction can be raised by inserting a core of iron wires, or another coil, or both. The effect of introducing the iron core is very marked, reducing the sound enormously. If a coil of wire containing an iron core be inserted, the effect of short-circuiting the coil is to increase the sound in the telephone. The same author also described and showed an experiment due to Dr. Fleming, in which a disk of copper inclined at an angle of 45° to the axis of a coil of wire and suspended bifilarly, is deflected by passing an undulatory current round the coil. In explanation of the former experiment, Dr. Fleming wrote down the formulæ for the effective resistance and self-induction of a circuit near another closed circuit, which show that the former is greater and the latter less for undulatory than for steady currents. He had not arrived at any satisfactory explanation of the deflection of the copper disk. Prof. Ayrton exhibited a tuning-fork worked electrically, in which the pitch could be varied by altering the self-induction of the circuit, or by varying the position of the make-and-break screw. Mr. C. V. Boys referred to his experiments, published in 1884, on the impulse given to metal disks suspended in a magnetic field whose strength is suddenly changed, as being of a similar character to that described by Mr. Bidwell, and suggested the use of aluminium instead of copper in future experiments, owing to its conductivity for the same weight being greater. Prof. Thompson said he had recently used a similar apparatus to that described by Mr. Bidwell as an illustration of the effect of self-induction, and pointed out the uses of self- and mutual-induction in multiplex telegraphy and telephony. As an explanation of the deflection of the copper disk by alternating currents, Prof. Foster thought it possibly due to its initial position being that of maximum sensibility, and therefore each impulse had less effect than the preceding one. Mr. W. M. Mordey mentioned a simple arrangement for varying self-induction used by Mr. Ferranti to control the power of incandescent lamps worked by alternating currents, and Prof. Ayrton described a closed magnetic circuit of great self-induction, used to protect voltmeters on the telpher line at Glynde from disastrous inductive effects produced by breaking the locomotive circuit. Referring to tuning-forks, Mr. Bosanquet thought some self-induction was necessary in order that the current should act to the best advantage in attracting the prongs at the proper instant. Further remarks were made by Mr. Boys and Prof. Perry.—On

a lecture experiment to show that capacity varies inversely as the thickness of the dielectric, by Profs. W. E. Ayrton and John Perry. The authors consider it easy for students to see that, other things remaining constant, capacity is proportional to area. Taking this as proved, a condenser is arranged such that the area A of the insulated inner coating varies as the thickness t of the dielectric, and the potential difference between the coatings is found by experiment to be constant. Then since capacity = $\frac{\text{quantity}}{\text{potential}}$, and both the latter being constant, therefore the capacity of the condenser is constant. But by the construction of the apparatus $\frac{A}{t}$ is constant, and it is assumed that

capacity varies as A , therefore capacity must vary inversely as t .—Note on magnetic resistance, by the same authors. Two iron rings about 6 inches diameter, made from the same bar of best Swedish iron about half an inch in diameter, were wound with insulated wire in two halves, so that a current could be sent round either or both halves, and the resulting induction measured by the throw of a ballistic galvanometer placed in series with a few convolutions of wire wound round the outside of the main winding. One of the rings was continuous, and the other had a small air space of about 0.8 mm. in a plane perpendicular to that of the ring and passing through its axis, as if the ring had been cut by a saw. The primary object of the experiments, which were made by Messrs. Aldworth, Dykes, Lamb, Robertson, and Zingler, of the Central Institution, was to determine whether there was any appreciable "surface magnetic resistance." The results do not show any such resistance, and the relative resistance of air and iron as calculated from the unsaturated parts are about as 1200 to 1, a number agreeing fairly well with those obtained by other experimenters. From this the authors conclude that for small distances magnetic resistance of air is proportional to length. When the magnetising current was passed round the one half of the divided ring on which the test coil was wound, a greater induction could be obtained than by any other way of magnetising, and this the authors do not attempt to explain. Mr. Bosanquet said he had always found greater inductions obtainable in the middle of bar electromagnets or open magnetic circuits, than could be produced in closed magnetic circuits, and thought the above observations confirmed his own results. A discussion followed in which Mr. C. V. Boys, Mr. W. M. Mordey, Mr. Bosanquet, and Prof. Perry took part.—On account of the late hour the reading of a note on dynamo machines and motors, by Profs. Ayrton and Perry, was postponed till the next meeting.

Zoological Society, March 15.—Dr. St. George Mivart, F.R.S., Vice-President, in the chair.—The Secretary read a report on the additions that had been made to the Society's menagerie during the month of February 1887.—Mr. Howard Saunders exhibited a young male Harlequin Duck (*Cosmonetta histrionica*), shot off the coast of Northumberland on December 2 last, and remarked that it was the second authentic British-killed specimen in existence.—Mr. Oldfield Thomas read a paper on the Bats collected by Mr. C. M. Woodford in the Solomon Islands.—A communication was read from Mr. W. R. Ogilvie Grant, containing an account of the birds collected by Mr. C. M. Woodford at Faurø and Shortland Islands, in the Solomon Archipelago, and in other localities of the group.—A communication was read from Mr. G. A. Boulenger, containing a second contribution to the herpetology of the Solomon Islands.—Mr. Oldfield Thomas read a paper describing the milk-dentition of the Koala (*Phascolarctos cinereus*), which was shown to be in the same state of reduction as had been described by Prof. Flower in the case of the Thylacine.—A second communication from Mr. Boulenger contained a description of a new Gecko of the genus *Chondrodactylus* from the Kalahari Desert, South Africa, based on a specimen which had been presented to the Natural History Museum by Mr. J. Jenner Weir. The author proposed to call it *C. weiri*.

Geological Society, March 9.—Prof. J. W. Judd, F.R.S. President, in the chair.—The following communications were read:—On *Chondrostes acipenseroides*, Ag., by Mr. James W. Davis.—On *Aristosuchus pusillus*, Ow., being further notes of the fossils described by Sir R. Owen as *Poikilopleuron pusillus* Ow.; on *Patricosaurus merocratus*, Seeley, a lizard from the Cambridge Greensand, preserved in the Woodwardian Museum of the University of Cambridge; on *Heterosuchus valdensis* Seeley, a procelian crocodile from the Hastings Sands of

astings; on a sacrum, apparently indicating a new type of *Ornithodesmus clunivetus*, Seeley, from the Wealden of the Cretaceous, by Prof. H. G. Seeley, F.R.S. In the last paper, after some remarks on the characters of the sacrum in birds, Ornithomiridae, and Dinosauria, the author proceeded to describe a sacrum composed of six vertebrae in the Fox Collection, now at the British Museum, and then to compare the fossil with the corresponding bones of the three groups named. The resemblance to the Dinosaurian and Ornithomiridae sacral vertebrae was less than those which connected the fossil with birds. From the latter it was distinguished by the smaller number of vertebrae in the sacrum, the absence of sacral recesses for the lobes of the kidneys, and the form of the articular face of the first sacral vertebra. But the small number of sacral vertebrae in *Archaeopteryx*, the want of renal recesses in *Ichthyornis*, and the characters of the articulation in the Solan goose showed that these differences were not essential; and the author concluded that the fossil belonged to a true bird, but that it formed a link with lower forms, and approximated more to Dinosaurs than did any other Avian type hitherto described.

Chemical Society, March 17.—Dr. Hugo Müller, F.R.S., President, in the chair.—The following papers were read:—The action of heat on nitrogen peroxide, by Dr. A. Richardson.—Supersaturation of salt solutions, by Dr. W. W. J. Nicol. This paper contains an account of experiments on the physical constants of supersaturated and dilute salt solutions. The solutions were examined in two ways: (1) concentration constant and temperature varying; (2) temperature constant and concentration varying; in this way it was possible to pass from dilute to supersaturated solutions, and to examine the change in the various physical constants. The electric conductivity, specific viscosity and rate of expansion were examined by the first method. The specific viscosity and density by the second. In every case it was found that the curve corresponding to the non-saturated solutions was perfectly continuous with that for the supersaturated solutions. From this the author concludes that the constitution of dilute, saturated, and supersaturated solutions is the same. Supersaturation is explained by the hypothesis that the substance in solution is not the same as that which crystallises out. A supersaturated solution of sodium sulphate deposited crystals of the composition $\text{Na}_2\text{S}_2\text{O}_3 \cdot \text{H}_2\text{O}$ when evaporated *in vacuo*, showing that the solution does not contain the pentahydrate. The author believes that the salt in solution is combined with the whole of the water, an opinion based on his experiments on vapour-pressure and molecular volumes. Colour changes in solution are not, he believes, due to hydration, but to rearrangements of the salt molecule similar to that which occurs in the case of chromium sulphate. Dr. Nicol's views were criticised by Mr. Pickering and Dr. Armstrong.—The formation of γ -naphthalenesulphonic acid by means of sulphuric anhydride and γ -dihydroxynaphthalene, by Dr. Henry E. Armstrong and Mr. W. P. Wynne.— α -Cyanonaphthalenesulphonic acid, by Dr. Henry E. Armstrong and Mr. S. Williamson.—Addendum to paper entitled an explanation of the laws which govern substitution in the case of benzenoid compounds, by Dr. Henry E. Armstrong.—The transformation of citric acid into pyridine-derivatives, and on the constitution of pyridine, by Dr. S. Ruhemann.—Silver containing bismuth, by Mr. William Gowland.

Royal Meteorological Society, March 16.—Mr. W. Ellis, President, in the chair.—The following papers were read:—Notes on taking meteorological observations on board ship, by Capt. D. W. Barker. The author makes various suggestions as to the placing of meteorological instruments on board ship with the view of securing uniformity.—Marine temperature observations, by Dr. H. R. Mill. After briefly sketching the principal historical methods of observing temperature beneath the surface of the water, Dr. Mill discussed in some detail the relative merits and defects of the two instruments now in common use for this purpose. The self-registering maximum and minimum thermometer on Six's principle, even with the addition of an outer bulb to protect it from pressure, has certain inherent defects. It merely shows the highest and lowest temperatures passed through, the indices are liable to be shaken from their proper position, and it requires long immersion in order to attain the temperature of its surroundings. Mr. J. Y. Buchanan has shown how, by the use of mercury and water piezometers, the actual temperature at a given point may be obtained, no matter how the temperature between that point and the surface may vary. Such instruments have not been much used, and now a modifica-

tion of the mercurial outflow thermometer, patented by Messrs. Negretti and Zambra as the "standard deep-sea thermometer," is largely used. When fitted in a frame which admits of the thermometer registering at a precisely known depth, admirable results are obtained by it. The manner of using these thermometers in the Scottish frame and of conducting temperature trips in comparatively shallow water was described; and the best ways of recording the observations and elaborating the results were alluded to; the work of the Scottish Marine Station on the Clyde sea area being taken as an illustration. The importance of marine temperature observations as bearing on submarine geography, on navigation, on the distribution of animal life, and consequently on fisheries, was alluded to. The paper was illustrated by diagrams, and by the exhibition of the apparatus which was described.—After the reading of these papers the meeting was adjourned in order to afford the Fellows an opportunity of inspecting the Exhibition of Marine Meteorological Instruments and Apparatus which has been organised under the auspices of the Society.

Victoria Institute, March 7.—The Rev. Dr. Walker read a paper on insect life in the East, in which he gave a full report of his entomological researches in Egypt and the East, and drew special attention to the very great number of British varieties that he had captured in various parts of the world. During the discussion, Dr. Sydney Klein remarked on the value to science of Dr. Walker's labours, and, in regard to insect life in the East at night, said that when passing a night among the ruins of Ephesus he found its superabundance manifested by the actual roar of chirps, scrapings, rattles, hummings, and cries from the country round, quite equalling his experience in the woods of Central America. Mr. Hastings C. Dent gave an account of his observations in South America and elsewhere.

MANCHESTER

Literary and Philosophical Society, January 17.—Prof. W. C. Williamson, F.R.S., in the chair.—Mr. Henry Hyde exhibited a leaf of *Bryophyllum calycinum*, with young plants growing out of the margin.—Dr. Alex. Hodgkinson read a paper on cavities in minerals containing fluid, with vacuoles in motion, and other inclosures.—Prof. W. C. Williamson, F.R.S., gave a practical demonstration by means of sections, shown by the oxy-hydrogen camera, of the structure and development of young roots. Beginning with those of the maize as they appear within the seed, Prof. Williamson exhibited and explained those of the vine, of the bean, of the crown imperial, and of the several species of cycads, illustrating the changes which roots undergo between the uniform structure seen near the root or tip, to their more advanced condition, as seen first in the roots of endogenous plants, and afterwards in the more complicated ones of exogens.

PARIS

Academy of Sciences, March 21.—M. Janssen, President, in the chair.—On the movement of a solid in a liquid, by M. Halphen. A theoretical demonstration is given of the general proposition that this movement consists of (1) a uniform helicoidal motion round a fixed axis in space; (2) a uniform rotation round a fixed axis in the solid; (3) a periodical movement.—On the great atmospheric movements in connexion with MM. Schwedoff, Colladon, and Lasne's cyclonic theories, by M. Faye. The paper is devoted to a refutation of these various theories, which are stated to be mainly due to the confusion caused by failing to distinguish between movements produced artificially in the air or water by a simple rotatory action, and the natural cyclones, tornadoes, waterspouts, &c.; the two orders of phenomena having only an apparent relation to each other.—Some observations and reflections on the earthquake of February 23 at Antibes, by M. Ch. Naudin. At this point of the coast the sea suddenly retired about 3 feet, soon returning with considerable velocity to its normal level. This and the associated phenomena are attributed, not to any volcanic action or to the gases confined in vast subterranean cavities, but to the resistance offered by certain parts of the terrestrial crust to the electricity generated in the globe itself. It is pointed out that these disturbances occur always in districts destitute of forest growths which might serve to discharge the atmospheric electricity, and on this is founded a fresh argument for replanting lands that have become deforested.—On the red fluorescence of alumina, by M. Lecoq de Boisbaudran. Some experiments are described leading to the inference that this fluorescence is due to the presence of traces of chromium in ordinary alumina, and cannot be produced by the pure earth itself.—Earthquakes in connexion with fire-damp, by

M. F. A. Forel. It is suggested that the series of slight vibrations almost invariably following the first great shocks may tend to cause the escape of fire-damp in mines, and that the precautions against this danger should consequently be redoubled in mining districts within the range of the general disturbance.—On a possible cause of the earthquakes of 1755, 1884, and 1887, by M. A. Blavier. An attempt is made to associate these occurrences with an abnormal accumulation of ice in the Polar waters, causing a deflection of the Rennel branch of the Gulf Stream, attended by great climatic changes and a slight disturbance of equilibrium in the submarine bed, followed by a possible local fracture along the line of least resistance. The in-rush of cold oceanic waters would appear to be indicated by the disappearance of the sardines from the West Coast of Europe in the years in question.—On the employment of gas as a constant source in experiments on radiation, by M. Edouard Branly. In this communication a comparative study is made of the moderator lamp and gas jet, as two sources of mean temperature in these experiments.—On the tartrate of antimony, by M. Guntz. A process is described for preparing in the pure state the acid tartrate of antimony, which Peligot obtains by alcoholic precipitation of a concentrated solution of the oxide of antimony in tartaric acid.—On the presence and quantitative analysis of alumina in wine and the grape, by M. L. L'Hôte. The results are given of experiments made to determine the presence in appreciable quantities of antimony in Burgundy, Roussillon, and some other red wines.—Note on some new syntheses in the fatty series by means of the chloride of aluminium, by M. Alphonse Combes.—On the microbe of yellow fever and its attenuation, second note, by MM. Domingos Freire, Paul Gibier, and C. Rebourgeon. In continuation of their studies on this microbe, discovered by them in 1884, the authors describe a process by means of which the virus may be attenuated and converted into a prophylactic vaccine.—Calorimetric studies on sick children, by M. P. Langlois. The experiments here described show that in chronic disorders with hypothermy there is a diminution of caloric, which increases in maladies with hyperthermy.—On certain characteristics of the pulse in morphiomaniacs, by Messrs. B. Ball and O. Jennings. The observations here illustrated by sychographic tracings serve both to detect the practice in patients secretly addicted to the taking of morphia and to remove the craving for intermittent doses.—Mineralogical study of the Fort Duncan meteoric iron recently presented to the Paris Natural History Museum, by M. Stanislas Meunier. The analysis of this specimen, found in 1882 near Fort Duncan, Maverick County, Texas, shows a remarkable resemblance to the mass which fell at Braunau, Bohemia, on July 14, 1847. It yielded: iron, 92.02; nickel, with traces of cobalt, 6.10; residuum, 1.80; density 7.699.

STOCKHOLM

Royal Academy of Sciences, February 9.—The following papers were accepted for insertion in the Proceedings of the Academy:—On the so-called anomalous dispersion, by the late Colonel C. E. af Klercker. On benzol and toluol monosulphide combinations, by Dr. Mats Weibull.—The Letterstedt Prize for 1887 for the best original scientific work was awarded to Prof. F. A. Smitt for his "Critical Index of the *Salmonida* in the National Museum," whilst the amount of the same legacy for special scientific work was awarded to Prof. A. G. Nathorst for his researches on the Tertiary flora of Japan.—The Secretary announced that the Proceedings of the Academy for 1886 were completed, and that the first part ("Aurores boreales") of Series II. of the work "Observations faites au Cap Thorsden, Spitzberg, par l'Expédition Suédoise," published at the expense of the Academy, was issued.—The following two papers were also presented by Prof. Berlin:—On six isomeric acids of toluol disulphide, by Dr. P. Klason. On the substitution of the amido group in aromatic combinations for hydrothion as well as oxy-sulphuryl by means of diazo combinations, by the same.—Prof. Edlund advanced a strictly mathematical demonstration showing the correctness of his theory regarding unipolar induction.—Prof. Gylden presented the following papers:—Untersuchungen über einen speciellen Fall des Problems der drei Körper, founded on studies at the Stockholm Observatory, by Dr. P. Harzer, of St. Petersburg. On the absolute correctness of terms of expression employed by Prof. Gylden in order to solve the problems of three bodies, by himself, which paper will shortly appear in the *Acta Mathematica*.—Prof. Smitt announced the appearance of a new edition of the illustrated work "Skandinaviens Fiskar" ("The Fishes of Scandinavia"), in which are a number of original drawings by Herr W. von

Wright, belonging to the Academy, which have never been published before. He also presented the first report of the Ornithological Committee appointed by the Academy.—Prof. Mittag-Leffler presented the following papers:—On convergent & definite integrals, by Herr C. B. S. Cavallin. On a treatise by Ascoli relating to the integration of the differential equation $D^2u = 0$ for a given Riemann surface, by Dr. G. Eneström. Integration der differential Gleichung $D^2u = 0$ in einer beliebigen Riemannschen Fläche, by Prof. Giulio Ascoli, of Milan.—The Secretary presented the following papers for insertion in the Proceedings:—On the influence of chlorine on α -acetic naphthalid, by Prof. Cleve. On naphthalid acids, by Dr. A. G. Ekstrand. On α - and β -naphthamidoxim, by the same. On the resin acids in galipot, by Dr. A. Westerberg. On pteropods in the Zoological Museum of the Upsala University, collected by Capt. G. von Scheele, classified by Dr. H. Munthe. Notes on Permian fossils from Spitzbergen, by Prof. B. Lundgren. Einfluss der Neutralsalze auf die Reaktionsgeschwindigkeit der Verseifung von Actylacetat, by Dr. S. Arrhenius.

BOOKS, PAMPHLETS, and SERIALS RECEIVED

Ligaments, their Nature and Morphology: J. B. Sutton (H. K. Lewis).—School Hygiene: Dr. A. Newsholme (Sonnenschein).—Atlantic Weather Charts, part 1, from August 1 to November 7, 1882 (Stationery Office).—Electrical and Anatomical Demonstrations: Dr. H. Tibbits (Churchill).—Memoirs of the Literature College, Imperial University of Japan, No. 1; The Language, Mythology, and Geological Nomenclature of Japan, viewed in the light of Aino Studies: B. H. Chamberlain and J. Batchelor (Tokyo).—Verhandlungen des Naturhistorischen Vereines, Zweite Hälfte (Max Cohen, Bonn).—Colonial and Indian Exhibition; Reports on the Colonial Sections: Edited by H. T. Wood (Clowes).—Monthly Results of Observations made at the Stations of the Royal Meteorological Society for the Quarter ending September 30, 1886 (Stanford).—Instantaneous Photography for Amateurs (Seers, Bath).—General Guide to the British Museum, Natural History.—Quarterly Journal of the Royal Meteorological Society, January 1887 (Stanford).—Studies from the Biological Laboratory, Johns Hopkins University, vol. iii. No. 9.

CONTENTS

PAGE

A University for London	506
A Junior Course of Practical Zoology	506
Embryogeny of the Anthropoid Apes	509
Our Book Shelf:—	
Heilprin: "The Geographical and Geological Distribution of Animals"	510
McAlpine: "Life-Histories of Plants"	510
Letters to the Editor:—	
Vitality, and its Definition.—Prof. John W. Judd, F.R.S.	511
"The Gecko moves its Upper Jaw."—Edward B. Poulton. (Illustrated)	511
Weight and Mass.—P. G. T.	512
An Error in Maxwell's "Electricity and Magnetism." Prof. A. Seydler	512
Tabasheer.—Thomas Rowney	512
A Method of Illustrating Combinations of Colours.—H. G. Madan. (Illustrated)	513
Ice-Period on the Altai Range.—A. Bialoveski	513
A Claim of Priority.—V. Ventosa	513
Oktibehite or Awaruite?—Dr. James Hector, C.M.G., F.R.S.	513
Aërial Vortices and Revolving Spheres. (Illustrated)	514
On Oldhamia. (Illustrated)	515
On the Distribution of Temperature in the Arctic Ocean. By J. Y. Buchanan	516
To Find the Day of the Week for any Given Date. By Lewis Carroll	517
Notes	517
Astronomical Phenomena for the Week 1887 April 3-9	520
Geographical Notes	520
Biological Notes:—	
Injurious Fungi in California	521
Fertilisation of <i>Cassia marilandica</i>	521
Variations in the Nerve-Supply of the Lumbricales Muscles in the Hand and Foot	521
On Certain Modern Developments of Graham's Ideas concerning the Constitution of Matter, I. By Prof. T. E. Thorpe, F.R.S.	522
Scientific Serials	522
Societies and Academies	522
Books, Pamphlets, and Serials Received	522

THURSDAY, APRIL 7, 1887

A NATURALIST IN SOUTH AMERICA

Notes of a Naturalist in South America. By John Ball, F.R.S., M.R.I.A., &c. (London: Kegan Paul, Trench, and Co., 1887.)

I.

BY this unpretending little volume its author has opened up to view a new avenue to knowledge—a royal road, in short, to anyone as competent as he has shown himself to be to take advantage of all that it offers to an intelligent traveller with his eyes and ears open. Its contents are a rich collection of facts and thoughts, chiefly botanical, meteorological, and geographical, acquired during a five months' voyage over 18,400 miles of ocean, and embracing 100° of latitude, during which the author passed only seventy days on dry land; and they are laid before the reader in a style which is as attractive as instructive.

In the preface Mr. Ball says of his voyage:—"A tour around the South American continent, which was completed in so short a time as five months, may not appear to deserve any special record; yet I am led to hope that this little book may induce others to visit a region so abounding in sources of enjoyment and interest. There is no part of the world where a traveller can view so many varied and impressive aspects of Nature, whilst he whose attention is mainly given to the progress and development of the social condition of mankind will find in the condition of the numerous States of the continent, and the manners and habits of the many different races that inhabit it, abundant material to engage his attention and excite his interest." Mr. Ball adds that, though the aim of his journey was mainly to see Nature in aspects new to him, he, as an unprejudiced visitor, gives also his impressions as to the social and political condition of the different regions which he visited. With these impressions we need not concern ourselves, though we may say that they seem to us to be both just and liberal.

Leaving England in March 1882 as a passenger on board a West Indian mail-steamer, Mr. Ball found that the passage across the Atlantic offered nothing of unusual interest, but even this well-beaten track suggests some good ideas as to rate of flow of the upper and lower strata of the aerial currents forming the trade-winds. Barbados was reached in thirteen days, where, amongst other vegetable measures, he obtained the fruits of the sandbox-tree (*Hura spicata*), the explosive nature of which is well known, though not the violence of its character, which would suggest an alternative name of the dynamite-tree. Mr. Ball carried away a specimen packed in a wooden box, which he subsequently placed in his herbarium room in London, where, nine months after it had been obtained, it burst with such violence that the box was broken to pieces, and the valves and seeds of the fruit were scattered all about the room.

A single day at Jamaica afforded him his first glimpse of a thoroughly tropical vegetation *in situ*, and it would be difficult to find a terser or better description of its appearance to a Londoner than his simple statement that it seemed to me as if the inmates of the Palm House at

Kew had broken loose and run scrambling up the rocky hills."

The Isthmus of Panama crossed and the Pacific reached, the real interest of the voyage begins. The first impression Mr. Ball gains—suggested by the breadth of the Bay of Panama (120 sea¹ miles across)—is of the vastness of the geographical features of America as compared with the ideas formed of them from experience of "our diminutive European continent," and from maps, and especially from those on Mercator's projection. In respect of this last he not inaptly complains that it profits nothing to explain, even to the most intelligent youth, the nature and amount of the errors involved in that mode of representing a spherical surface on a plane; and he goes on to say: "I verily believe that all the mischief done by the stupidity, ignorance, and perversity of the writers of bad school-books, is trifling compared to the amount of false ideas spread through the world by the production of that respectable Fleming."

A few hours botanising in the coast forests of Buenaventura, a port on the coast of Columbia, yielded a harvest of plants which forged the first link in a chain of reasoning that has led Mr. Ball to the conclusion (opposed to the view of all other writers on the same subject) that the most marked division of the flora of tropical South America is not that between the regions east and west of the Andes; for on his arrival in Brazil he found that, though he was nearly 3000 miles from Buenaventura, and separated from it by the great barrier of the Andes, the plants of the forests of that country were almost all nearly allied to Brazilian forms. This is followed by a bold speculation, dwelt on at greater length towards the conclusion of the work, that "the ancestors of the Brazilian flora, and to a large extent also those of the Andean flora, came into existence in the ancient high mountain ranges of Brazil, where we now see, in the vast extent of arenaceous rocks, and in the surviving pinnacles of granite, the ruins of one of the greatest mountain regions of the earth."

Crossing the equator, our naturalist was disappointed in not seeing Chimborazo, still in popular estimation the "hub" of the South American continent, though geographers have long known that it has to bow its head to Aconcagua, upwards of 2500 miles further south. Chimborazo is only seventy miles from Guayaquil, whence it is easily seen on clear days, but we are told these occur only about half a dozen times in the year!

Cape Blanco, the westernmost cape of South America, rounded, the so-called rainless zone of South America, which extends for nearly 2000 miles to the southward, is reached. This is a feature of the highest interest to the biologist and meteorologist. Its access was signalled by the sudden fall of temperature from an average of 80°, with a relaxing atmosphere "heavily charged with vapour,"² to 74°, with an elasticity in the air that dispelled a previous lassitude, which had rendered burdensome even the first taste of the charms of tropical scenery.

In no part of the world is a change in vegetation more suddenly effected than in the short distance, amounting to little over 100 miles, between the Gulf of Guayaquil and

¹ Surely an oversight for English miles.

² When shall we have accurate conceptions embodied in our colloquial phraseology? The vapour of water is lighter than atmospheric air, yet the latter is conventionally described as "heavily laden" with it.

Payta. Nowhere in the world are the forests more luxuriant than in the former place, whereas, on arriving at Payta, Mr. Ball was informed by the officers of the ship that it was no use his taking his botanical box ashore with him, because the country was absolutely without vegetation. As, however, the forewarned expected, this was not quite the case: stunted bushes grew in the cliffs, nor were plants absent on the plateau above, where, however, the vegetation was more scarce than he had anywhere seen it, except in the tract west of the Nile above Cairo. He remarks that the gullies furrowing the seaward face of the plateau show that heavy rains must visit this part of the coast, and on inquiry he was informed that abundant rain, lasting for several days, recurs at intervals of three or four years. This, he subsequently found, is a normal feature of the rainless zone, added to which he was informed that slight showers occur at intervals a few times in the year, which suffice to maintain the vitality of the few species of plants that hold the ground persistently; whilst the heavier rains are followed by an outburst of herbaceous vegetation covering the surfaces that have long been bare.

For the existence of this rainless zone Mr. Ball considers that the hitherto assigned causes are insufficient. These are: the influence of the Andes in condensing the Atlantic vapours brought by the westward atmospheric flow; the warming in its passage north of the vapour-bearing aerial currents that accompany the Antarctic or Humboldt oceanic current; and the effect of this warming of the air in enabling it to hold in suspense all the vapour it absorbs in its passage north. Mr. Ball's principal objections to the sufficiency of these causes are that the Andes of Ecuador and Columbia do not condense the western vapour-bringing winds, whilst those of Peru, Bolivia, and North Chili do; and that the littoral zone of the former regions is, for a distance of 800 miles, even moister than parts of the coast of Brazil and Guiana. His supplemental explanation is based chiefly on the physical features of the Andes. In Peru the Andes present four parallel longitudinal chains, increasing in mean elevation in going westward, though the highest peaks are not on the westernmost range. In Ecuador only two such ranges, the two westernmost, exist, and these do not suffice to drain the vapour-bringing winds, a portion of whose moisture is precipitated on the Pacific coast. In Columbia, again, there are three of these parallel ranges, enough perhaps to drain the easterly winds; and its sources of moisture may be supposed to be derived from the diversion southwards of easterly currents from the Caribbean Sea which have crossed the Isthmus of Panama. On the whole, however, Mr. Ball considers that the influence of the Humboldt currents, oceanic and aerial, is of far greater moment than is that of the Andes, since the influence of these currents is felt even to the north of the Gulf of Guayaquil, as at Cape St. Elena, where the rains are less frequent than at Guayaquil. For the further description of this interesting subject we must refer to the work itself.

On April 15, Callao, the port of Lima, was reached, and a ten days' expedition to the higher Andes was effected. For this there were two railroad facilities. One line starts from the coast at Mollendo, south of Callao, and, running

by Arequipa, crosses the crest of the Andes, and terminates at Lake Titicaca, 12,800 feet above the sea. The other starts from Lima itself. It was projected with the intention of piercing the crest of the Cordilleras at an elevation of 15,645 feet above the sea, thence descending to Oroya, a plateau between the main ranges. Its ultimate object was to afford a route to the fertile districts on the eastern slopes of the Andes. As yet it has only reached a village called Chicla, 12,200 feet above the sea, its progress having been stopped by the war between Peru and Chili. The first of these routes was obviously the most desirable for a naturalist, but want of time and the fact of Arequipa being in possession of a Peruvian force drove Mr. Ball to take the Chicla route. To the professed naturalist Mr. Ball's observations on this little expedition offer much of interest, but the season was unfavourable for botanising, the weather at the culminating point wretched, and the natural features of the country, under such conditions at any rate, anything but inviting. There is a brief discussion on mountain sickness, of which Mr. Ball has already detailed his symptoms in this journal (vol. xxvi. p. 477). They are anomalous; but as his elevation was only 12,200 feet, at which many mountaineers who suffer acutely at 16,000 feet and above it feel no inconvenience at all, his experience is insufficient. That the symptoms should disappear during bodily exercise is opposed to what is described in the cases not of man only, but of cattle, sheep, and horses, in crossing high passes. The observations on the temperature of the upper Andean regions as compared with that of the coast are very valuable, as are the notes on the zones of vegetation, the ranges of species, the distribution of endemic forms, &c.

On his return to Lima, Mr. Ball obtained some further information regarding the well-known hollowed cliffs of volcanic rock which occur along the coast, and reach to 700 feet above it, and which have been written of by Lyell and others as indications of a rise of the land. According to a very intelligent local observer, Mr. William Nation, of Lima, the excavations are due chiefly to a cryptogamic plant which grows on the surface of the cliffs, and is in active vegetation as a disintegrating agent during the dense fogs that prevail for many months of the year. Mr. Nation thinks that alternations of dry and damp air, by causing the cells of this burrowing plant to expand and contract, effect the removal of scales of mineral matter from the surface of the rock, and hence eventually excavate the latter. Fancying that the plants might (as do some lichens) chemically affect the rock, Mr. Ball submitted specimens to an eminent cryptogamist, who found it to be an Alga, and harmless in this respect. Mr. Ball himself is disposed to think that vicissitudes of temperature aided by alternations of moisture and dryness, dry fog and sun, may play the greatest part in effecting the hollows. It is to be hoped that Mr. Nation will follow up the problem, which wants only careful observation to solve it.

Between Callao and Coquimbo, along a monotonous coast, several places were visited, but these seem to be far from being oases; some of them, indeed, are dependent on transport by sea for a supply of fresh water. The track between Arica and Copiapo, a distance of 600 miles, "further than from Liverpool to Oporto," is that its

which the rainless zone is most pronounced. With the possible exception of Pisagua, there is no inhabited place where drinkable water is to be had, and yet the wants (or greed) of men have established many industrial settlements along the coast for the purpose of working mines of silver, copper, and lead, and digging deposits of alkaline nitrates. Drinking-water is, in most of these towns, provided by the distillation of sea-water; in others it is imported. Nine such places were touched at by the steamer; their features were uniform, and, we may add, uniformly repulsive: chemical works with tall chimneys, sheds of reeds for workmen, a few clean-looking houses for managers, and grog-shops. At one of these, Tocopilla, Mr. Ball observes:—"At last I found, what I had often heard of, but in whose existence I had almost ceased to believe, a land absolutely without a trace of vegetable life. Not only was there no green thing; not even a speck of lichen that I could detect, though I looked at the rocks through a lens. Even more than by the absence of life I was impressed by the appearance of the surface, which showed no token that water had ever flowed over it. Every edge of rock was sharp, as if freshly broken, and on the steep slope no trace of a channel furrowed its face. The aspect is absolutely that of the scenery of the moon—of a world without water, and without an atmosphere." Curiously enough, small birds, which live on stable manure, were the only trace of indigenous animal life; what they were Mr. Ball could not approach them near enough to see. Seaweeds, however, though scarce, occurred in pools left by the tide, and relieved the barren coast from the curse of being without vegetation. At Caldera, the port of Copiapo, vegetation begins, and, though the environs are sandy, bushes and inclosed gardens are to be seen, and at Coquimbo green is, in the spring at any rate, a dominant colour. On May 9, Mr. Ball disembarked at Valparaiso, and made that town and Santiago his headquarters for twenty days. During this period he made numberless observations on the scenery, climate, vegetation, and geographical features, many of which though referring to matters that are familiar to every scientific reader, abound in thought and shrewdness, and are exceedingly instructive. Leaving Valparaiso, the voyager entered a totally different region of America, physically and biologically, and into it we shall follow him in a future number.

(To be continued.)

COLEOPTERA OF THE BRITISH ISLANDS

The Coleoptera of the British Islands. A Descriptive Account of the Families, Genera, and Species indigenous to Great Britain and Ireland; with Notes as to Localities, Habitats, &c. By the Rev. W. W. Fowler, M.A. Vol. I. Adepaga—Hydrophilidæ. Pp. xxii. and 269. Two Plates. (London: Lovell Reeve, 1887.)

DURING the last thirty years, seven or eight distinct catalogues of British Coleoptera have been published, and have met with an encouraging sale; hence there can be no doubt that there exists a considerable number of collectors of British Coleoptera. But no really satisfactory systematic work on this department of the fauna of our islands exists, and Mr. Fowler has done well

in attempting to supply such an one. The earlier works of Curtis and Stephens are, for obvious reasons, of little practical use in the present day, and though, twelve years ago, Mr. H. E. Cox published a hand-book of British Coleoptera in two volumes, it cannot be said to have been the work required, owing to the facts that it contained no reference to localities, and that it consisted entirely of systematic tables, without the addition of any matter that could make it a pleasant book to use.

In the work now before us, the author has been very successful as regards these points; he adopts the system of tables, but gives, in addition, brief diagnostic descriptions of all the species, and satisfactory details of localities and the distribution in our islands. In his prefatory remarks he very properly calls attention to the necessity of access to collections of an elementary nature, so that the student shall have some elementary notions about, at any rate, a few beetles before attempting to use the work. There can be no doubt that he is quite correct as to this point, and it may be hoped that the local museums and school collections that are now becoming numerous throughout the country will be of great use in this respect; and for this object such institutions should possess a small but well-selected general collection in addition to that of their local fauna.

There are now about 3200 species of Coleoptera on the British list, and the present volume deals with only about one-sixth of these, so that the work when completed will be of considerable extent. The author promises to give, when it is concluded, an introduction to the system of classification employed in it. This is, indeed, indispensable, as at present the student is not supplied with any definitions of the "series" which form the basis of the arrangement used. He already finds, however, under the various subdivisions, remarks on classification and affinities; these are usually well considered, and will, no doubt, increase greatly the interest of the work, and, it may be hoped, will induce the student to extend his studies to questions of greater interest and importance than the determination of the names of species.

The Coleoptera are an enormous order of insects, comprising already fully 100,000 species, and as their organisation is such that the details of their external structure can be readily observed, much has already been done towards establishing a natural classification of the order. The author has made himself well acquainted with the various recent improvements in this department, and acknowledges in the frankest manner his obligations to authorities in various parts of the world. There are some points of general interest as to the British Coleopterous fauna, such as the number of species peculiar to the islands, but the work before us has not yet sufficiently advanced to enable such points to be discussed with advantage, and we may perhaps find occasion at a future time to consider them.

It would be a very great advantage if zoologists could agree on a system of names for the various aggregates larger than genera. Mr. Fowler's work only gives the individual names of these larger aggregates, and distinguishes them merely by rather slight typographical distinctions; as a consequence, the student finds himself introduced to a large number of these names in rapid succession, and they must be rather a source of bewilder-

ment to him than a key to the classification adopted; it would probably be an improvement if, in future volumes, the author would prefix to these names the terms "Family," "Sub-Family," "Group," &c., so as to allow the systematic value of the names themselves to be more readily appreciated. The two plates accompanying the volume are intended to give an idea of those structural characters on which the classification used in the work is based, and they also give three figures of larvæ borrowed from Schiodte; it may be hoped that these latter extraordinary forms may incite some student to continue the work of investigating the earlier stages of beetles, so ably pursued by the talented Dane whose recent decease is still a matter of general regret amongst entomologists. The structural diagrams II. and III. on Plate A are, as given, far from being successful. They are described as representing the under-skeleton, but, actually, one-half of each of the diagrams represents the upper surface, and the manner in which the two halves are connected will inevitably suggest to a beginner that the structures displayed are those that would be seen on removing the parts covering the upper surface.

Mr. Fowler, as we have already stated, has taken great pains to make himself acquainted with the modern authorities, and to render his work as interesting as the nature of the subject and its great extent will permit; his efforts in these directions will no doubt be duly appreciated, and his work will, it may be hoped, find a place in the libraries of all our local museums, as well as on the bookshelves of the amateur.

D. S.

BRITISH STALK-EYED CRUSTACEA AND SPIDERS

British Stalk-eyed Crustacea and Spiders. By F. A. A. Skuse. (London: Swan Sonnenschein, Lowrey, and Co., 1886.)

THIS is a modest little volume of 126 pages, professedly written for the "tyro." We are informed, on p. 14, that the "pages do not profess to be either scientific or in the least anything beyond the production of a humble admirer of Nature, and only intended to put the reader on the road to the investigation of the creatures written about." This being so, it would be unfair to judge the work from the stand-point of more special treatises, and we need do no more than comment upon the introduction of a somewhat antiquated system of classification and of minor errors which would be unpardonable in a work of greater pretensions.

The book is a clearly stated compilation, and is, so far as it goes, fairly accurate and up to date. There is, manifestly, little room for originality, and the reader must be prepared to find that most of the more pleasing passages—those dealing with the habits of the animals described—are, of necessity, quotations from earlier authors, references to whose works are in all cases given as footnotes.

The subject-matter is apportioned into nine chapters and an introduction, and it deals with methods and accessories as fully as with the animals themselves. Under the head of Development (Chapter III.) are to be found the facts of morphology and physiology which fall within the scope of the work. It is in this that the

author is at his worst, and there is much here which stands in need of revision. We are told, in the introduction, that "the earliest known insects have been found in the Devonian, so probably there also existed spiders." Taking the context into consideration, it is surprising that the author should thus presuppose the discovery of Palæozoic spiders, and overlook that of Silurian scorpions and cockroaches, the former so well to his purpose. "Big-tails," "Queer-tails," and "Little-tails" are renderings of *Macrura*, *Anomoura*, and *Brachyura* as unfortunate as they are unconventional.

The illustrations are good as a whole; some are excellent, being faithful copies of standard figures. More spiders might be advantageously delineated, and exception must be taken to the wretchedly wooden drawings of crustacean larvæ, especially of the young lobsters (p. 27). For the latter the author would do well to substitute, should a second edition be demanded, the strikingly truthful drawings of Sars ("Om Hummerens postembryonale udvikling," Christiania, 1874), or, failing those, Kent's figures ("International Fisheries Exhibition Literature," vol. vi. "Conferences").

There is much truth in the author's assertion (p. 10) that "everybody knows a crab. Everybody knows a spider. But it is just these every-day things that people know really least about; while, on the contrary, things that must be sought for in order to be seen are often most commonly known." The writer is true to this tenet, and his book ought, in the hands of an intelligent "tyro," to be productive of good results; while passages such as that in which he describes (p. 73) the construction of the spider's web are well calculated to arouse that enthusiasm which he is sanguine enough to presuppose. The appreciation of the beautiful in Nature must precede the devotion to that which is more useful, and the little handbook before us, invested, as it is throughout, with a true dignity of purpose, will serve as a means to this desired end.

OUR BOOK SHELF

Catalogue of the Fossil Mammalia in the British Museum (Natural History) Cromwell Road, S.W. Part IV. Containing the Order Ungulata, Sub-order Proboscidea. By Richard Lydekker, B.A., F.G.S. (London: Printed by Order of the Trustees, 1886.)

THE collection of Proboscidean remains preserved in the British Museum is by far the largest in any Museum in the world; containing as it does the splendid collections made in the Siwaliks of India by Sir Proby T. Cautley, the unrivalled British series of mammoth remains, the unique collection of pygmy-elephant remains from Malta, the series of remains of dinotherium and mastodon from Eppelsheim, &c., and a fine collection of American mastodons from the United States and from South America.

An immense collection like this, containing remains belonging to nearly all the described forms, was admirably adapted for the study of transition forms, and Mr. Lydekker has not been content in this Catalogue with giving merely a detailed enumeration of the contents of the cases, but has written a full account of the families, genera, and most of the species of the known extinct Proboscidea. In a short introduction he gives some most interesting notes on the geographical and geological distribution of the species. In reference to the subject of the structure of the cheek-teeth Mr. Lydekker thinks that this can be

traced from the most generalised to the most specialised member of the Elephantidæ. So complete indeed is this transition that not only is there no real line of demarcation between Mastodon and Elephas, but several of the species of the two genera seem to pass so imperceptibly into one another that it is not unfrequently a matter of extreme difficulty (if indeed it be not an absolute impossibility) to determine to which species individual teeth really belong.

In regard to geographical distribution, there appears to be considerable evidence in favour of an easterly migration of the mastodons having taken place from Europe to India; while the restriction of the stegodont group of elephants to the latter country and the regions to the eastward, points to the conclusion that the transition from the mastodons to the higher elephants took place in those regions. From this we may also infer that there subsequently ensued a westerly migration of these higher forms to Europe, and finally on to North America, where the true elephants did not make their appearance till the Pleistocene, and then appear to have been represented only by two species, one of which ranged over the greater part of the higher latitudes of the northern hemisphere. The descriptive details are very usefully illustrated by a number of woodcuts of the teeth and cranial bones. The work, despite its name of Catalogue, is a most important contribution to our knowledge of the subject.

LETTERS TO THE EDITOR

- [The Editor does not hold himself responsible for opinions expressed by his correspondents. Neither can he undertake to return, or to correspond with the writers of, rejected manuscripts. No notice is taken of anonymous communications.]
- [The Editor urgently requests correspondents to keep their letters as short as possible. The pressure on his space is so great that it is impossible otherwise to insure the appearance even of communications containing interesting and novel facts.]

Iridescent Clouds

THIS phenomenon is very common here in the winter, occurring, with few exceptions, whenever there are scattered clouds near the sun. The colours are often brilliant enough to catch the attention of the most casual observer, but at other times they can only be made out with the aid of dark neutral-tint spectacles. These reduce the intensity of the glare near the sun to a point favourable to the discrimination of colour.

I have lately been watching the somewhat complicated phenomena, and taking rough measures of the angular distances of the various colours from the sun, and I have little doubt that the colours are due to diffraction of light by fine particles of ice.

Within a circle, radius about 2° , the clouds are white, perhaps faintly tinged with blue; but it is difficult to observe a delicate shade of colour so near the sun. This circular space is surrounded by a ring of yellow or orange. The region of most vivid hues is comprised between 3° and 7° , the most striking being purple, blue, orange, green, and red. These are not arranged in rings, but are distributed over the thinner parts of a cloud in irregular patches. Beyond this region the only colours visible are green and red, becoming fainter as the distance from the sun is increased. I have detected them in three or four cases at a distance of 21° . At some distance from the sun the greens and reds are frequently arranged in bands parallel to the edge of the cloud, sometimes as many as three bands of each being visible. I have often seen a cloud completely encircled by bands, the impression given to the observer being that the colour depends on the thickness of the cloud. No doubt the real explanation is that the ice particles are larger in the interior of a cloud. We have thus two independent factors to determine the colour of a particular portion of cloud: the distance from the sun, and the average size of the particles. Near the sun slight variations of the former are more important, so we get a tolerably regular yellow ring. Far from the sun the variations of the latter have overwhelming influence, and we have bands along the edge of a cloud. At a medium distance, in the region of vivid colour, we have the two factors nearly equally powerful, and indescribable confusion as the general result.

On one occasion, when the edge of a large cloud passed almost through the sun, I noted down the colours in order along the edge, where the size of the particles would be tolerably uniform: white, yellow, red; blue, green, yellow, pink; green, faint red. This list consists evidently of three successive diffraction spectra, and it is in satisfactory agreement with a number of less complete series that I have obtained. The blue, however, is often replaced by a brilliant purple, due to the first and second spectra overlapping. Another method of discovering the true order of the colours is by watching the changing hues of a cloud approaching or leaving the sun. This tended to corroborate the list just given, but I could seldom trace more than two or three changes, so rapidly did the clouds grow or dwindle away. I noticed, indeed, that the more rapid the growth the more brilliant were the colours displayed. One interesting observation deserves special mention. A cloud showed faint colour at a great distance from the sun. It was edged with green, with red inside. As it approached the sun, the bands moved inwards, and red appeared on the edge, then green, then red, then green. The last tint was very undecided, and afterwards the whole cloud remained white. The inward motion of the bands showed that the inner particles were larger.

We now come to the question of the form of the diffracting particles. The form most favourable to diffraction is the sphere, as with a sphere the angle of diffraction for any given spectrum depends only on its diameter. Thus if a cloud be composed of spheres of uniform size, and be at the angular distance from the sun corresponding to the first spectrum for that size, each sphere will send its quota of light to the observer. Next to the sphere comes the circular cylinder. In order that a cylinder may send diffracted light to the observer, its axis must lie in or near the reflecting plane. By the reflecting plane I mean the plane of a mirror which would reflect sunlight to the observer. But, when this condition is satisfied, the angle of diffraction, corresponding to any particular spectrum, depends only on the diameter of the cylinder. Any other form, a circular disk for instance, gives different diffracting angles according to the orientation of the particle. The spectra corresponding to different orientations would be superimposed and white light be the result.

Now, among the manifold forms of snow-crystals there is, I believe, nothing approximating to a sphere. But thin hexagonal prisms are common, either separate, or attached as rays to hexagonal disks. These would produce much the same effect as circular cylinders; for the extreme variation of the apparent diameter of an hexagonal prism from its mean value is only 7 per cent.

Granted that the diffracting particles are hexagonal filaments, my measurements of the angular distances of the colours from the sun supply data for determining the average diameter of the filaments. For this purpose purple is a useful colour, as it always arises from the overlapping of the first two spectra. I took some five-and-twenty measures at various times, which varied from $3\frac{1}{2}^\circ$ to $6\frac{1}{2}^\circ$. These give diameters from $\cdot 017$ mm. to $\cdot 009$ mm. Orange of the first spectrum ranged from $2\frac{1}{2}^\circ$ to $5\frac{1}{2}^\circ$, six measures. These give diameters from $\cdot 021$ mm. to $\cdot 010$ mm. Blues of the second spectrum, four measures, $4\frac{1}{2}^\circ$ to $6\frac{1}{2}^\circ$; diameters $\cdot 014$ mm. to $\cdot 009$ mm. If the colours I observed at 21° from the sun were produced by filaments $\cdot 013$ mm. in diameter, they must have belonged to the ninth spectrum. But the ninth spectrum, in addition to being only one-fortieth as bright as the first, is overlapped by four spectra of higher order and three of lower, so it can hardly be distinguishable. At such a distance from the sun the finer particles would have a great advantage in colour-producing power, so I think it probable the spectrum was of the fifth order, produced by particles of diameter $\cdot 009$ mm.

The next difficulty is to explain why colours are not seen in clouds composed of minute spheres of water. As explained before, the spherical form has a great advantage. I find by calculation that if the spheres were of uniform size, diameter $\cdot 013$ mm., the colours of the first spectrum would be about twenty times as brilliant as if the cloud were composed of filaments of the same diameter, arranged at random, but occupying the same fraction of the field of view. So we might a priori expect that water clouds would be more brightly iridescent than ice clouds. But it is not so. During the summer here I looked frequently and vainly for iridescence. This want of colour must arise from the minute drops not attaining sufficient uniformity of size. So we have to find some cause of uniformity which acts

more powerfully on particles of ice than on drops of water. I venture to offer the following suggestions.

Let us consider what happens when an ice cloud is forming. Dust particles, no doubt, act as nuclei to ice crystals as well as to water drops; so that a number of crystals will start into existence about the same time. Soon there will be no more dust particles of sufficient size to form nuclei. The rate of deposition on a crystal will be proportional to its surface, so all the crystals will grow in diameter at the same rate. The ratio of the largest diameter to the smallest will become less. In fact the crystals will become more uniform in size. No doubt, too, the supply of aqueous vapour near a large crystal will be consumed more rapidly than it can be refunded by diffusion. So the larger crystals will grow somewhat more slowly. These are causes tending towards uniformity. They account for the observed fact that they are newly formed clouds, which show the brightest colours, though when they first come into view they are white. It is easy to give reasons why some clouds should lose their colour so soon. Varying conditions may affect the growth of different layers of particles in a different manner, or a slight increase in the rate of deposition may call new dust particles into action.

In the case of water clouds there are two special causes brought into action against uniformity. Sir William Thomson has shown that the maximum vapour-tension at the surface of water is largely increased when the surface is highly convex. So the large drops will grow more rapidly than the small ones, and the range of size will be more and more extended. Secondly, whenever two drops of water come into collision, they will combine into one larger one.

In conclusion I may remark that St. Moritz is 6000 feet above sea-level, and the iridescent clouds were generally above the surrounding mountains, *i.e.* at least 11,500 feet above sea-level. On some days the sky was overspread at a great height, with a thin haze gathered here and there into denser streaks (cirrostratus?). The haze sometimes formed coronæ close around the sun. I have not made out more than two spectra. From rough measures of the diameters of the rings, I find for the diameters of these filaments values varying from .04 mm. to .07 mm.

JAMES C. MCCONNELL

St. Moritz, Switzerland, March 14

Aino Hairiness and the Urvolk of Japan

IN Mr. B. H. Chamberlain's remarkable and instructive monograph on the Ainos, contained in the first number of the *Memoirs of the Literature College of the Imperial University of Japan*, just published, will be found an explanation of the different conclusions that have been arrived at by different observers as to the *Hairiness* of that singular people, equally isolated, so far as our present knowledge extends, by language and by physical characteristics from all surrounding races. When I spent some days among these so-called savages in 1865 or 1866, I had the opportunity of examining some four or five score of them, chiefly men, and in every individual I found the phenomenon of hairiness more or less marked. The sternal, inter-scapular, and gluteal regions were, in particular, thus provided with a natural covering, the very regions where such a protection from the drip of rain would be most serviceable. I remember well that in some individuals the gluteal fur was so abundantly developed that thick tufts of hair, several inches long, could be grasped in the hand. But recent travellers have been struck by the number of natives they met with deficient in hairiness—whether they were proportionately lacking in face-hair is not stated—and it has been doubted whether hairiness is really an Aino characteristic. Dr. Baelz's investigations have, however, amply vindicated the claim of the Ainos to be the hairiest people in the world, and now Mr. Chamberlain shows that the smooth-bodied natives are in fact half-breeds, the progeny of native mothers by Japanese fathers. Unions of this kind have probably increased in frequency during the last two decades. Between the two races, however, some incompatibility seems to exist, for their progeny exhibit a diminished fertility. "The second generation," says Mr. Chamberlain, on the authority of the Rev. Mr. Batchelor, who has lived for years among the Ainos, and contributes an exhaustive grammar of their language to the volume of *Memoirs* before me, "is almost barren; and such children as are born—whether it be from two half-breed parents, or from one half-breed parent and a member of either pure race—are generally weakly. In the third or fourth generation the family dies out."

The injury to the reproductive system caused by this "miscegenation"—a phenomenon not unparalleled in the history of man, and proving the existence in man, as in other organisms, of a tendency to specific variation—has an important bearing upon the much-debated question of the proportion of Aino blood that runs in the veins of the Japanese of to-day. Mr. Chamberlain, chiefly from philological considerations based upon an examination of place-names, arrives at the conclusion that the *Urvolk* of the Japanese group, from the extreme south to the furthest north, was an Aino race, and we know from history that up to the time of Yoritomo (twelfth century A.D.), and probably later, the northern half of the main island was still, to some extent, peopled by Ainos. Yet even the northern Japanese are smooth-bodied, although it is extremely unlikely that "miscegenation" did not obtain between their Japanese ancestors and the aborigines. In the light of Mr. Batchelor's observations the explanation of this apparent anomaly is easy. The half-breeds died out, and the prepotency of the Japanese in numbers and civilisation gradually expelled the Aino element from the population, which has thus become an almost purely Japanese one.

It must not, nevertheless, be forgotten that at least two distinct races may still be traced in the existing population of the Japanese group. One is slim, high-headed, and often aquiline-nosed; the other stouter and broader, more brachycephalic, and flat-nosed. Excellent types of both, especially of the first, will be found in Siebold's "*Nippon Archiep.*" The former constituted the military class of Old Japan, the latter the peasantry; and of the latter some degree of hairiness of the limbs is a not uncommon characteristic. The drawings of Hokusai sufficiently prove this assertion, which the experience of every resident in Japan will confirm. It may therefore be safely assumed that the elimination of the Aino element has not been complete. For my own part I believe that the earliest inhabitants of Japan were tribes of Malayo-Polynesian blood coming from the south, and of Aino blood coming from the north. Altaic immigrants followed, and, partly perhaps through some degree of reproductive prepotency, gave a characteristic and predominant stamp to the population without total elimination of its aboriginal elements.

University of London, March 21

F. V. DICKINS

Units of Weight, Mass, and Force

HAVING read with much interest Prof. Greenhill's letter in *NATURE* of March 24, p. 486, I am inclined to think that much of the perplexity felt by some who begin the study of dynamics arises from the want of names for the units of the various magnitudes with which the science deals. We have names for units of time, space, mass, force, work; but no names for units of velocity, acceleration, impulse, momentum, &c. I venture to suggest the following:—Let the unit velocity be that with which a point describes uniformly one foot per second. Let this unit be called a vel. Let the unit acceleration be that whereby the velocity is uniformly changed by one vel per second. Let this unit be called a cel. Then everything becomes clear. *E.g.* the meaning of the equation $W = mg$ is seen to be this: The weight of a mass of m pounds at a place where the acceleration arising from the mutual stress between it and the mass e of the earth is g cels being W poundals, the numbers W and mg are connected by the equation $W = mg$. Then, for the sake of the beginner, let the names of the units be given thus: $W = m_1$ poundals, $m = \frac{W}{g}$ pounds, $g = \frac{W}{m}$ cels. It is too common to see acceleration expressed in feet per second, instead of in vel per second. If the weight of a mass of m pounds be defined to be the mutual stress between it and the mass e pounds of the earth, it is evident that the weight of e attracted by m is the same as the weight of m attracted by e ; and, in the absence of either, the other would have no weight.

Bardsea, March 29

EDWARD GEOGHEGAN

The Earthquake in the Riviera

THOUGH there can be no question as to the amount of damage done by the late earthquake—I am writing in a shed, the hotel being destroyed—I think that the violence of the shock has perhaps been very greatly exaggerated. I have only been able to make a flying visit to this place and to Diano Marina, but cannot help being struck by the fact that the peculiar archi-tecture is the main cause of the large amount of destruction

Indeed, judging from the small amount of damage done to buildings in which flat or square stones and flat floors have been used, I should doubt whether the shock was much more severe than that which not long ago damaged the brick buildings in East Anglia.

At both Oneglia and Diano Marina the building material is usually rounded stones from the beach, or rubble with stones of all shapes and sizes. The stucco is apparently expected to make good any deficiencies. Besides this the floors are nearly always brick arches abutting against the vertical walls, without any reference to other lateral support. Most of these houses are three or four stories high. Of course any vibration affecting buildings of this construction will split the walls in all directions, for besides the lateral thrust of the arches, the walls are full of wedge-shaped stones ready to slip into any fissures which may form.

The complication caused by these arched floors makes it very difficult to trace the direction or angle of emergence of the shock.

CLEMENT REID

Oneglia, March 13

Scorpion Virus

ALLOW me to state that the results of my experiments on Cape scorpions are in full accord with Prof. Bourne's conclusion that the poison of the scorpion has no fatal effect on the same individual or another individual of the same or even of another species. Speaking before the South African Philosophical Society in February 1883, I said:—"Members of the Society will see on the table a scorpion of the larger (Cape) species. That scorpion I caught at 11 o'clock this morning. I at once pierced him in three places with his own sting, on which in each case there was a drop of poison. In the last inoculation I held the sting in the wound, and squeezing the 'bulb of the sting' with the pincers forcibly injected poison. The creature is alive and active" (Proceedings for 1883). These and subsequent experiments, however, led me to believe that the poison has some effect, causing sluggishness and torpor for a while. I quite agree with Prof. Bourne that it is physically possible for a scorpion to sting itself in a vulnerable place; and though I never was able to observe the infliction of a wound on itself by any scorpion, I can well believe that this is possible, but, I am convinced, wholly accidental.

I found also that the poison of the ring-hals snake (*Naja huemachates*) was not fatal when inoculated in the same individual or another individual of the same species.

University College, Bristol

C. LLOYD MORGAN

The Supposed *Myzostoma*-cysts in *Antedon rosacea*

SOME eighteen months ago I called attention in these columns (vol. xxxii. p. 391, and vol. xxxiii. p. 8) to certain malformations which I had discovered on the pinnules of *Antedon rosacea* from various British localities. They often take the form of small cysts which are very like those produced by encysting *Myzostomida* on the arms and pinnules of various Crinoids from the Pacific; and as no other cyst-builders but *Myzostoma* were then known to infest the Crinoids, the inference seemed a natural one that the cysts on the pinnules of *Antedon rosacea* had been produced by a small member of this genus. I subsequently found several more cysts on some examples of *Antedon rosacea* which were dredged at Gibraltar by the Italian corvette *Vettor Pisani*, and the whole collection was sent to my friend Prof. L. von Graff for examination.

To our great surprise, however, he has not found a single *Myzostoma* in any one of the fourteen malformations of the pinnules, whether cysts or otherwise, which he has opened; and "the new British *Myzostoma*" must therefore be dis-established.

But what, then, has been the cause of these malformations? Prof. von Graff has found them to be always associated with the presence of a minute globular body, which has the appearance of an egg that has undergone superficial cleavage, but yet exhibits no trace of nuclei when stained. It is impossible to decide at present what this structure may be. Prof. von Graff has described it more fully in a "Supplementary Report on the *Myzostomida* of the Challenger Expedition" which he has just completed. But its nature seems to be as problematical as that of the saccali; and fresh material, not spirit specimens, must be examined

before we can expect to learn much more about it. In any case, however, it would seem that we have to deal with a hitherto unknown parasite of the Crinoids, which is capable of producing modifications in the calcareous tissues of the arms and pinnules, of essentially the same character as those caused by *Myzostoma*, though of smaller size.

I would commend the question to the attention of those naturalists who may meet with *Antedon rosacea* in the dredgings of the ensuing season; and in order that they may know how to catch their hare, I shall be most happy to forward specimens of the cysts to anyone who desires to become acquainted with their external appearance. I may add that the largest cysts I have seen are on Comatulæ from the Cumbræ, Milford Haven, and Gibraltar; while I have no knowledge of their occurrence either at Naples or anywhere else in the Mediterranean.

Eton College

P. HERBERT CARPENTER

On some Observations on Palæobotany in Goebel's "Outlines of Classification and Special Morphology of Plants"

THE few modern authors of botanical text-books who have ventured to summarise recent palæobotanical researches have achieved but moderate success. These authors have too little knowledge of the rapid progress of the study of fossil plants during the last few years to make success possible; hence, their summaries, if not absolutely inaccurate, are usually misleading. So long as these errors are confined to works published in Continental languages, British palæobotanists need not take the trouble to correct them. But the case is altered when English translations of these books appear amongst us. Palæobotany has nowhere made greater progress during the last few years than with ourselves. Many errors have been corrected, and new truths, results of careful and prolonged investigations, have taken their place. With the more important of these new discoveries many of our younger students of geology are now familiar. It is desirable that what they have been taught should not be contradicted by the utterances of authors ignorant of the subject upon which they venture to express an opinion.

Some little time ago Dr. Goebel, of Rostock, published a volume which was virtually a new edition of Book II. of Sachs' "Lehrbuch der Botanik," and an English translation of this volume, made by Mr. H. E. F. Garnsey, and revised by Prof. I. B. Balfour, has just appeared. Dr. Goebel's volume contains some references to the Palæozoic flora which are seriously behind the times. To allow these statements to reach our students uncorrected will do harm, because they must suggest to those students that certain questions are still open and debatable which cannot now be regarded as such.

Had I not unfortunately misunderstood a wish expressed by my friend Prof. Balfour, some explanatory footnotes would have been introduced into the above volume, which would have rendered this communication unnecessary.

On p. 193 of the translation we find the following statement:—"Other groups are the Sphenophylleæ, Lepidodendrea, an Sigillariæ, the first of which are only heterosporous Lycopodiaceæ." We have no reasons for concluding that Sphenophyllum is Lycopodiaceous, still less that it is heterosporous. This latter statement rests upon M. Renault's interpretation of minute multicellular fragment which he observed in a sporangium, and which he believed to be a macrospore; it could not be this, since the exosporium of a macrospore is a unicellular organism. On the other hand, the Lepidodendra were both homosporous and heterosporous. As to the Sigillariæ, even M. Renault now admits that all the vertically-fluted forms are Lycopodiaceous. The assertion that the Lepidodendra were a heterosporous is repeated on p. 196. On p. 272 we have a brief paragraph of eight lines remarkable for the number of the inaccurate statements which it contains. I have indicated these inaccuracies by reproducing them in italics.

"The Calamites are Equisetaceæ which appear in the older geological formations, beginning in the Carboniferous Limestone (1), culminating in the Coal-measures, and disappearing in the Permian formation. The spikes of sporangia are either not known, or so badly preserved (*Calamostachys*) (2), that the structure cannot be determined; it remains doubtful, therefore, whether they were homosporous or heterosporous forms (3). The stems had neither leaves nor leaf-sheaths, or else these were transitory formations and soon fell off (4). In other respects the structure of the stems resembles that of the Equisetaceæ (5)

Their surface was marked with ridges (6), and they had a central hollow divided by diaphragms."

I will examine these statements *serialim*.

(1) The author appears to have been strangely ignorant of Sir William Dawson's magnificent discoveries of Calamites and other Carboniferous plants in the Devonian strata of North America, announced in his Report on the subject in 1871.

(2) In 1874 I published in the Philosophical Transactions the detailed structure of extremely beautiful examples of *Calamostachys Binneyana*, and, since then, Prof. Weiss, of Berlin, has figured equally fine examples of *Calamostachys Ludwigi*. In the Philosophical Transactions for 1881 I further showed that this genus comprehended both homosporous and heterosporous forms. At the same time *Calamostachys* is not the fruit of Calamites.

(4) Both Sir William Dawson and Prof. Weiss have shown that the slender twigs of Calamites were abundantly supplied with verticils of linear leaves.

(5) This statement is true with an important limitation, which Dr. Goebel ignores; or, as a follower of M. Renault, he more probably rejects. Whilst the type of Calamitean organisation is unquestionably Equisetiform, their arborescent stems and branches contained an enormous xylem or woody cylinder, developed exogenously, which made them differ very widely from their degenerate living representatives.

(6) This is a repetition of the old fallacy, which regarded the vertical groovings of the surfaces of the inorganic casts of the fistular medullary cavity as belonging to the cortical surface. We have now numerous sections of the Calamitean cortex, no one of which exhibits the slightest trace of vertical flutings; they are all smooth.

On p. 281, speaking of heterosporous Lycopodiaceæ, the author accepts M. Renault's old conclusions that in *Lepidodendron* "there is no certain indication of secondary growth in thickness." "The connection of fossil stems capable of great increase in thickness, such as the *Sigillariæ* and *Calamodendron* is at present questioned." These facts are no longer capable of being justly questioned. The structure of *Lepidodendron Selaginoides* alone suffices to settle the matter so far as that genus is concerned; to say nothing of the many other species that demonstrate the same fact. M. Grand'Eury himself, long one of the most influential questioners, has now recognised that the genus *Arthropitium* only represents the thick woody zone of a true Calamite. Prof. Stur, of Vienna, long ago demonstrated in an unanswerable manner the almost absolute identity of Calamites and *Calamodendron*; and M. Renault himself, as I have already observed, has still more recently been compelled by the discovery of a *Sigillarian* fructification by M. Zeiller to alter his view respecting the *Sigillariæ*. He no longer insists that these cannot be Cryptogams because their stems grow exogenously, but now hands over to his opponents, who have so long contended for the Lycopodiaceous affinities of this *Sigillarian* genus, all the vertically fluted examples of it.

Whilst deeming it desirable that his readers should be put in possession of the other side of the question to which he refers, it is only fair to Dr. Goebel to say he is himself aware that those questions are dealt with in a one-sided manner. In a footnote on p. 272 of the English translation the author says:—"The short description given in the text from Renault may serve at least to draw attention to these interesting types, in which there is much that is yet uncertain. We cannot enter here into disputed or doubtful points." At the same time it is to be lamented that the leading botanists of the world cannot give us palæontologists more of that valuable aid which their special studies would so well enable them to do. I do not yet despair of enlisting some of the Strasburgers, de Barys, Goebels, and Van Tieghems in this honourable service.

W. C. WILLIAMSON

Owens College

A Sparrow chasing Two Pigeons

ON Sunday, I asked three men what they were observing, when they pointed out a sparrow chasing two pigeons.

The pigeons were evidently greatly alarmed at their pugnacious attendant, who took occasional pecks at them when flying underneath, and whenever possible. The sparrow lost ground when the others made their more rapid doubling, but soon came up with them again, and renewed its attack.

What was the original quarrel of course we do not know, but the persistency of the sparrow's attack greatly amused us.

Have any of your readers observed anything like this? or is there any record of the like?

E. A. C.

Luton, Chatham, March 14

Top-shaped Hallstones

I DREW attention to hallstones possessing the above form in *Science Gossip* of December 1884. These pellets, which fell in my garden at Polmont, Stirlingshire, on the morning of May 6, 1884, were about one-fourth of an inch in length, and nearly three-sixteenths of an inch across. I did not see any horizontal stratification as observed by your correspondent Mr. Middlemiss, but found that each transverse section, when examined by a good lens, exhibited a fairly well-marked internal radiated fibrous structure, somewhat similar to that shown in sections of the mineral wavellite. Below are two (transverse



FIG. 1.—Transverse section (near base of cone) $\times 2$.



FIG. 2.—Longitudinal section $\times 14$.

and longitudinal) diagrammatic sections of the Polmont hallstones.

Since then, however, I have found top-shaped hallstones com-



FIG. 3.—Longitudinal section.



FIG. 4.—Transverse section of Fig. 3.

posed of fibres radiating from the summit of the pyramid as shown in Fig. 3.

Edinburgh University

ALEXANDER JOHNSTONE

A Peculiar Radiation of Light

AT 10.30 p.m. this evening, my attention was called to a peculiar radiation of light in the eastern sky. The centre of radiation was due east, and the bars on the *right-hand side* were increased in brilliancy by light evidently arising from the moon, which was not visible, but concealed by cloud. The extent of these rays was from horizon to zenith; the rays being of unequal size, but of a pale gray colour, slightly iridescent.

The east wind was blowing smartly at the time, and I should like to be informed whether this strangely beautiful appearance in the sky was caused by the radiation of light from a rising moon on thin clouds, or was it the effect of a strong current of wind from a given point?

By 11 p.m. the moonlight was full; the moon still to the right of the axis of the rays, and the rays nearly dispersed.

Falmouth, March 12

ROBERT D. GIBNEY

THE CHEMICAL SOCIETY'S ANNIVERSARY MEETING

THE anniversary meeting of the Chemical Society was held on Wednesday, March 30. We give some extracts from the address of the President, Dr. Hugo Müller, on the recent progress of chemical science:—

As we contemplate this ceaseless activity in chemical research now manifested all over the world, and which from year to year is continually on the increase, we are nevertheless bound to recognise the fact that vast as the work thus accumulated may appear, there remains still much to be accomplished. The more the field is worked the richer will be the harvest.

Overwhelmed by the quantity of material, especially in the direction of the production of new compounds, hasty critics were wont to denounce such work as superfluous, but it is now generally recognised that we must still continue with the patient and careful elaboration of the substructure of facts before we can with advantage proceed with the longed-for rearing of the edifice of a comprehensive scientific generalisation, that is to say, of ideal chemistry.

The infinite complexity which inquiry reveals in every

direction bids us more than ever to be cautious in taking flight on the wings of speculation.

In the meantime we must content ourselves with the use of working hypotheses in the various fields of inquiry; these we develop and modify as we go on, or, it may be, discard in favour of others which for the time being seem more in accordance with the facts before us.

The triumphs of modern chemistry bear testimony that faulty and incomplete as our present theories undoubtedly are, our science is ever advancing.

It is now well understood that the most important data for the future extension of chemical theory will be derived from the interpretation of the results of investigations into the physical side of chemical phenomena.

The examination of the optical properties of chemical elements and compounds, the determination of thermo-chemical constants, and the verification of physical constants generally, are now pursued by a great number of investigators. Of late also the experimental inquiry into the connexion between electrical and chemical force is becoming a fruitful field of research; and we may hope that further determinations of the coefficients of conductivity of electrolytes will before long lead to a clearer perception of the intimate nature of chemical change.

To pass in review the chemical work published during the year, as some of my predecessors have done on similar occasions, has now become an impossible task, even supposing that the time at my disposal permitted me to do so. I am, however, tempted to refer briefly to a few results which strike me as particularly noteworthy.

The work accomplished in thermo-chemistry is, as I have already observed, very considerable, and thanks to the patient labour of many workers the results thus achieved are comprehensive enough to admit of a consideration of their general bearings. In this respect I wish to direct attention to the publication of Julius Thomsen's fourth and concluding volume of "Thermo-chemische Untersuchungen." This remarkable work is entitled to the highest appreciation of all who realise the manifold difficulties which beset the execution of thermo-chemical investigation. But while referring to the many highly important and remarkable deductions which the author draws from his experiments, we cannot at the same time help being struck by the many anomalous results and startling conclusions which he arrives at. It would seem that further determinations of the fundamental values, if possible by different and varied experimental methods, must be obtained before the full importance of this work can be entirely realised.

An important addition to our still very limited knowledge of the density of metallic elements in the gaseous state has been made by V. Meyer and Mensching, who have now succeeded in overcoming the great experimental difficulties formerly encountered in the determination of the vapour-density of zinc. The molecule of zinc has been found to be monatomic, like that of cadmium and of mercury, the only two other metals the vapour-densities of which are thus far known.

The remarkable results recently published by Crookes in his papers on the spectra of the so-called rare earths are still fresh in our memory, and the ingenious application he has made of the doctrine of evolution in this speculation on the genesis of the elements has not failed to attract the attention it deserves.

The further investigations of the chemical and physical properties of the new element germanium by Winkler, Nilson, and Petterson have established its chemical position, and the supposition that its proper place in the periodic system is that of ekasilicon has been confirmed.

Ladenburg's long-continued researches on conine have been crowned by success. He has effected its synthesis and has shown that it is identical with α -propylpiperidine. This must indeed be considered one of the most noteworthy achievements in organic chemistry of the past year, inas-

much as it is the first instance of the artificial formation of an optically active natural alkaloid.

Wallach found that the diazo-amido-compounds formed from diazo-salts and piperidine are for the most part well-characterised substances, and that when heated with concentrated hydrofluoric acid they yield the fluor-derivative in almost theoretical proportions. He has prepared in this way fluorbenzene, parafluorotoluene, parafluornitrobenzene, parafluoraniline, and fluorphenyl, &c.

Studying the action of sodium on mixtures of ethers such as oxalic and acetic ethers, W. Wislicenus has discovered a new and ready method of effecting the synthesis of compound acids, and this reaction cannot fail to become of great value.

Brieger has succeeded in isolating a well-characterised alkaloid from the liquid used for cultivating a certain *Bacillus* which causes tetanus traumaticus in animals. This substance, which the author calls tetanine, seems to be the immediate cause of the toxic action of this *Bacillus*, and thus for the first time a specific pathological effect of a microbe has been traced to a well-defined chemical compound produced or secreted in its life-process.

Finally, I must also allude to the very remarkable observation recently published by Liebreich which demonstrates the fact that under certain conditions chemical reaction is retarded, and even altogether suspended. He noticed that in a mixture of aqueous solutions of chloral hydrate and sodium carbonate the formation of chloroform does not take place uniformly throughout the liquid. For instance, on performing the experiment in a test-tube there appears immediately below the meniscus a sharply defined space of 1-3 mm. thickness in which no reaction takes place. Similar results were obtained when an aqueous solution of iodic acid was mixed with sulphurous acid and soluble starch. The inert space manifests itself on the surface of the liquid which is in contact with the air or separated from it by a thin membrane. In narrow tubes the reaction is much more retarded, and it is altogether suspended in capillary tubes.

In my opinion this preliminary communication contains the germs of a discovery in a new direction, and the further study of the nature of these subtle influences which bring about the phenomenon in question must lead to important results.

In bringing this report to a conclusion I must briefly allude to a subject only indirectly connected with our Society, viz. the progress made in the organisation of technical education in this country, which, more particularly under the guidance and fostering care of the City and Guilds of London Institute, is gradually making its way.

Most of you are aware that the President of this Society is one of the *ex officio* members of the governing and organising body of this Institute, and it may be mentioned in passing that the regular attendance at the frequent meetings of the various Committees and Sub-Committees involves the necessity of devoting a by no means inconsiderable amount of time to this honorary office.

The chief event to be recorded in this connexion is the inauguration of the Central Institution which is to fulfil the function of a Technical University or Polytechnicum, and to afford higher scientific education to the future owners, directors, managers, engineers of manufacturing works, and the teachers in the various branches of technology. This magnificent Institution has now started on its career, and we have every reason to think that before long its value will be fully recognised by those who ought to take advantage of its existence. It is, however, unfortunate that the organisation of this Institution has stopped short of the plans originally laid down, and has been not at once carried to completion. Strange as it may appear, this is due to the want of funds. The City and Guilds, in taking so pro-

minently charge of the initiation and diffusion of technical education in this country, have thus far most liberally furnished the means required, and have thus earned the gratitude of the country; but as the development of the scheme progresses an even and commensurate flow of further contributions is required, which, being voted in many cases but annually, at once demonstrates the somewhat precarious conditions on which this important enterprise is dependent.

It is to be hoped that a more general recognition of the absolute need of an education of a higher scientific character both for masters and men will before long have its proper effect; and that the ways and means will be forthcoming to carry out a work which promises so well, and that the Central Institution may then stand a fair comparison with numerous institutions of a similar kind in other countries which have already helped in so marked a degree to advance the industries of those countries.

The mistaken notion is still too prevalent that technical education has to confine itself to the theoretical considerations of known technical processes, and that a more extended acquisition of scientific knowledge is not required. It is obvious that a pupil educated on these lines may find by the time he is able to enter on his practical career that the processes with which he has been made acquainted have in the meanwhile become obsolete, and unless his education has been sufficiently comprehensive to enable him to strike out new lines for himself he will be ill fitted to compete with those who have been educated on a wider basis.

Essential as it is to impart to the future manager scientific knowledge, it is above all necessary to train him by practical work and research in the laboratory how to investigate a subject which may present itself in his daily occupation, whether it be some unexpected development in a new direction, or whether it be some new difficulty which confronts him in carrying out the processes under his direction.

It is self-evident that such knowledge and such practical experience in carrying out investigations is not to be attained by merely attending one or two courses in the lecture-room or in the laboratory. Those who mean to effectually qualify themselves for such functions can only accomplish this object by devoting years of patient and intelligent work under the guidance of the professor in properly appointed laboratories.

THE INSTITUTION OF NAVAL ARCHITECTS

THE spring meetings of the Institution of Naval Architects this year were, to a considerable extent, adversely affected by the recent death of Mr. William Denny, of Dumbarton, the eminent shipbuilder, who was for many years one of the most active members of the Council, and who was foremost amongst the mercantile shipbuilders of this country in the application of scientific methods to naval architecture. Mr. Denny, as is well known, set up at Dumbarton a large experimental tank similar to that contrived by the Admiralty at Torquay for the late Mr. W. Froude, F.R.S., and in which most of his famous experiments on the resistances of the hulls of ships were carried out. It is not often that manufacturers can be induced to spare time and money for the purposes of scientific investigation, even when such investigation is directly conducive to the success of their business. But Mr. Denny was an exceptional man. He firmly believed in the mercantile value of exact scientific knowledge, and he possessed the courage and the ability to act up to his beliefs. It is satisfactory to know that he considered himself fully repaid for the risks he ran, in the results which he attained.

The opening address of the President dealt, as might have been expected in this Jubilee year, with the remark-

able progress in steam navigation achieved during the fifty years of Her Majesty's reign; a progress which must certainly be acknowledged to be extraordinary when we remember that, at the commencement of the reign, the late Dr. Lardner publicly offered to eat the first steamship which should cross the Atlantic, whereas nowadays we have vessels which make the passage in a few hours over six days, and a fuel consumption at sea of 1½ pounds of coal per indicated horse-power per hour is not uncommon. The speaker alluded to the various improvements, such as the use of steel in the construction of both hulls, engines, and boilers, the adoption of high-pressure steam and triple compounding, &c., which have principally contributed to the remarkable results attained.

The first paper read was by the late Director of Naval Construction at the Admiralty, Sir Nathaniel Barnaby and dealt with the important subject of the connexion between the Royal Navy and the merchant service. This paper was rather political than technical in its character. The author's main object was to support the Admiralty in their recently announced policy of so organising the mercantile marine as to increase the power of national defence. He pointed out that a fast and properly constructed mail steamer may be as efficient a factor in naval war as an ordinary cruiser costing a quarter of a million sterling; and that there are even certain services which the mail-steamer, by reason of her greater size and travelling power, can perform better than the cruiser. On the other hand, the great mass of our mercantile marine is now relatively weaker than it has ever been before against the attacks of an enemy; for in the wars of the last century such ships as the armed East India men possessed a well-recognised fighting value, but nowadays warships are so specialised that the majority of merchant vessels possess no powers of resistance whatever. Sir Nathaniel Barnaby also called attention to the fact that the State makes provision annually for a reserve of seamen, who are drilled periodically and paid by it, and who are liable to be called out to serve in case of war, and he then proceeded to show how, by good organisation of the superior merchant-ships, if manned mainly by naval reserve men, could in case of war be immediately available for service in whatever part of the world they might chance to find themselves. At the present moment the Royal and mercantile navies are under the control of two different Departments of State, and by some strange perversion the First Lord of the Admiralty is almost the only great political officer of State whose name is not to be found on the long list of members of the Board of Trade. As a natural consequence there is no community of action between the two Departments, and no organisation at present exists by which the services of the better class of fast merchant steamers could be rendered instantly available in case of war. The author's cure for this condition of affairs is the creation of a Secretaryship of State for the Navy, so that the interests of the merchant shipping and the Royal Navy might be united, and a truly national marine formed. There is no doubt but that Sir Nathaniel Barnaby in reading this paper has called attention to a very serious set of evils, which may all be remedied by a little organisation and by co-operation between two of the Departments of State. Even if the Board of Trade did not see its way to help in the work, what is to prevent the Post Office authorities from backing up the Admiralty by declaring that they would in future give their preference for mail-carrying purposes to steamers which fulfilled the Admiralty requirements of speed, subdivision and structural strength, and what is to prevent the Admiralty from assisting the Post Office to obtain a cheap and efficient mail service by granting moderate retaining fees or subsidies to such steamers, provided they were always manned with a due proportion of naval reserve

men and trained officers, and provided also that in consideration of the yearly subsidy their services were to be always at the disposal of the State in case of war at a fixed rental to be arranged beforehand. A beginning has undoubtedly been accomplished in the arrangements recently concluded between the Cunard and the White Star Lines on the one hand, and the Admiralty and the Post Office on the other, but much yet remains to be done, and we earnestly trust that Sir Nathaniel Barnaby's paper may be brought under the serious notice of those upon whom will devolve in time of war the care of our mercantile navy and the protection of our food supplies.

M. L. de Bussy, the Inspecteur-Général du Génie Maritime in the French Ministry of Marine, read a short paper on the results of a series of trials carried out on a torpedo boat at progressive speeds, in which he called attention to the fact that there is a diminution in the resistance of the hull after a certain speed has been passed. This fact was, however, already well known to members of the Institution, the peculiar sinuosities, or humps, as they are called, on the speed and power curves of vessels tried at progressive speeds having been often discussed at previous meetings. When all the causes of resistance to propulsion are separately analysed and expressed by correct formulæ, the causes of these successive maxima and minima of resistance will no doubt be clearly intelligible.

Mr. J. H. Biles, the scientific adviser of the firm of Messrs. J. and G. Thomson, of Glasgow, read an interesting paper on the twin-screw torpedo boats, *Wiborg* and *El Destructor*, constructed by his firm for two foreign Governments. The author first gave full particulars of the dimensions of the boats and engines, and their performances. These vessels were considerably larger than the generality of first-class torpedo boats, the *Wiborg* being 142 feet 6 inches, and the *Destructor* 192 feet 6 inches in length. They are both minutely subdivided, the former being provided with 23 and the latter with 39 water-tight compartments, the object being, of course, to enable them to keep afloat as long as possible when exposed to the fire of machine guns. The paper is interesting as showing the most recent tendency in torpedo-boat design. Recent experience in this country and in France undoubtedly points to the conclusion that the older type of first-class boats, though useful enough for harbour defence, are of little or no avail for service at sea. Whether the latest types described by Mr. Biles will fulfil reasonable expectations in this direction is a question which can only be solved *ambulando*. It may be noticed as a curious instance of the skill of modern marine engineers in evolving enormous powers out of engines of limited size, that the *Destructor*, whose load displacement is only 480 tons, has developed over 3800 horse-power, and has made the run of 495 knots from Falmouth to Muros in twenty-four hours, which corresponds to a mean speed of 20.625 knots.

Mr. Dixon Kemp, a well-known authority on yachting matters, read an interesting historical paper entitled "Fifty Years of Yacht-Building," in which he traced out the gradual evolution of the English and American types of racing yachts from the commencement of the present reign down to the most recent times. The author brings out very clearly the causes which have led to the adoption of the relatively narrow and heavily lead-ballasted boats which have hitherto found favour on this side of the Atlantic, and the broad, shallow, centre-board yachts peculiar to the Americans. In view of the recent triumphs of the American type, as represented by the *Puritan* and *Mayflower*, an alteration has been considered desirable in the old tonnage rule which taxed the beam so severely. The Committee of the Yacht-Racing Association appointed to report on the subject have recommended the following rule:—

$$\text{Rating} = \frac{\text{Length of loadline} \times \text{sail area}}{6000}$$

The first outcome of the new rule is the Clyde-built yacht *Thistle*, the principal proportions of which contrast strongly with those of the now famous *Galatea*, as will be readily seen from the following figures:—

	<i>Galatea.</i>	<i>Thistle.</i>
Length of loadline . . .	87.0 feet . . .	85.0 feet
Beam extreme . . .	15.0 " . . .	20.3 "
Draught of water . . .	13.5 " . . .	14.1 "

It should be mentioned that in the case of the *Thistle* the depth of the hold is measured to the bottom of the keel, which is a hollow box intended to hold the lead ballast. The contests, which will doubtless take place during the coming season, between the *Thistle* and some of the powerful American centre-board yachts, will be watched with great interest by yachtsmen. Whether a contest between a keel-yacht and one fitted with the centre-board is a satisfactory trial of merit is at least open to question. In this connexion it may be mentioned that a yacht like the *Mayflower* when sailing off the wind can effect a reduction of 10 per cent. in her immersed surface by housing the centre-board, an advantage which is manifest, especially in the case of light winds and slow speeds.

A subject of great importance with regard to iron and steel ships is the protection of their bottoms from corrosion. Mr. V. B. Lewes contributed a valuable paper on the nature and genesis of rust, and on the protection of plates from its effects. It seems now to be generally admitted that the corrosion which distinguished some of the earlier steel-built ships was due to the presence on the plates of mill-scale or black magnetic oxide of iron, which forms, with the metal of the plate, a powerful galvanic couple, and gives rise, in the presence of sea-water, to very rapid pitting or local corrosion. The action is, in fact, similar at the outset to that which takes place between metallic lead and its peroxide in the well-known Planté secondary batteries. At the present time, steel plates are always carefully freed from this magnetic oxide before being worked into the hulls of ships—a practice which has been attended with the best results. Mr. Lewes believes that the protective compositions of the future will be made by dissolving a good sound gum, not easily perished by sea-water, in a volatile solvent, care being taken that neither gum nor solvent give rise to any organic acids. Body will be given to this varnish by finely-divided metallic zinc, which can now be obtained in so fine a powder that it can be used as a pigment. When, in time, the varnish perishes, as it must do from the action of sea-water under pressure, the zinc will set up galvanic action with the hull-plates; but, being the more electro-positive of the two metals, it will corrode, and will thus protect the iron or steel plates. This paper does not deal with the much-vexed subject of anti-fouling compositions—a much larger subject, which the author reserves for a separate memoir.

Sir Nathaniel Barnaby read a second paper on the subject of fuel-supply in ships of war, which, together with a paper by Mr. Biles, on the comparative effects of belted and internal protection upon the other elements of design of a cruiser, apparently provoked more interest and discussion than any other communication made to the Institution this year. The ships to which Sir Nathaniel Barnaby alluded were the *Impérieuse* and *Warspite*, belted cruisers, for the design of which he was himself chiefly responsible. These vessels have lately been the subject of much adverse comment both in and out of Parliament. As originally designed, the armoured belt was intended to reach from a height of 3 feet 3 inches above the water-line to a depth of 4 feet 9 inches below it. The supply of coal on which this calculation was based was 400 tons, but bunker space was allowed for an additional supply of 500 tons. During construction various additions were made to the weights of the boilers and the armament, which in their turn involved an increase in the weight of hull, and the net

result was that the total weight of each ship was increased by 415 tons. Moreover, the present Board of Admiralty have decided that war-ships are in future to coal up to their full stowage capacity; that is to say, in the case of the *Impérieuse* and *Warspite* 500 tons more fuel are to be carried than the designer allowed for. As a natural consequence, the addition of 915 tons to the total weight of each vessel has immersed these ships so deeply that the height of the armoured belt above water has been reduced from 3 feet 3 inches to a little under 1 foot, and there are not wanting those who declare that this circumstance greatly injures, if it does not totally destroy, their fighting efficacy. Sir Nathaniel Barnaby very successfully proved that the responsibility for the additions to the weights of the hull and machinery belongs to the then Board of Admiralty, and not to himself. He also demonstrated that the addition of the extra 500 tons of coal was a case of deliberate reversal of the policy of one Board by its successor, but, judging from the tone of the discussion, he failed to convince his audience that the original policy of calculating the immersion of the belt on a fuel-supply of 400 tons was a wise one.

Mr. Biles's paper, above referred to, on the armour question, was an interesting and useful attempt to solve a difficult problem. He commenced by taking, as the basis of a definite comparison, the latest type of British belted cruiser, viz. the *Aurora*, of 5000 tons displacement. This vessel has a belt 5 feet 6 inches wide, of which 1 foot 6 inches is above the load-line; the thickness of the belt is 10 inches, and its top edges are united by an armoured deck 2 inches thick, under which are placed all the vitals of the vessel. With this he compares a type of cruiser without any side armour, but protected by means of a plated deck, the sides of which curve down so as to join the bottom some feet below the water-line, the curved or sloping portions of the deck being covered with armour of the same horizontal thickness as the *Aurora's* belt. In making the comparison he assumes—

- (1) That the length and draft of the proposed vessel are to be the same as in the case of the *Aurora*.
- (2) That the displacements are to be the same in each case.
- (3) That the costs are to be the same.

Mr. Biles claims that in design No. 1 the internally protected vessel would weigh less than the belted cruiser by about 210 tons; that it would cost nearly 40,000*l.* less; and that the designer would have the option, on the smaller displacement, of either increasing the thickness of the flat portion of the armoured deck by 40 per cent. amidships, or of adding about six-tenths of a knot to the speed, or finally of adding one 9.2-inch gun and two 6-inch guns to the armament.

In the case of design No. 2, where the displacements of the two types are equal, it is estimated that either a knot and a half might be added to the speed, or else that the thickness of the whole of the deck-plating might be increased by 44 per cent.

Lastly, on the assumption that the cost of the vessels is the same, Mr. Biles claims for the internally protected vessel the following important advantages: viz. 20 per cent. greater thickness of protection on the slope of the deck, 50 per cent. more on the flat, two more guns of the heaviest calibre, 20 per cent. more coal, and one knot additional speed. Mr. Biles very pertinently asks the question, Is the adoption of the belt worth the extra money paid for it with its accompanying sacrifices? or, If the money is to be spent, is the belt worth the sacrifice of speed, protection, and armament, which is entailed in its adoption?

The papers on marine engineering were not quite so interesting as some which have been read at recent meetings of the Institution. There were three on the subject of screw propellers, by Prof. Cotterill, F.R.S., Mr. Calvert, and Mr. Linnington of the Admiralty, and one on the machinery of small boats, by Mr. Splyer, also of the

Admiralty. In addition to the foregoing there were papers on stability, a subject which has been perhaps lately somewhat overdone; and an important contribution by Mr. Archibald Denny on the practical application of stability calculations in relation to the stowage of steamships. Mr. Jenkins, the newly-appointed Professor of Naval Architecture at Glasgow University, prepared paper on the subject of the shifting of cargoes.

STROMEYER'S STRAIN-INDICATOR

THIS is a very useful and ingenious apparatus for measuring the extension or compression produced on any material by tensile or compressive forces. Such deformations having been observed, the corresponding variation in the stresses to which the material has been subjected may at once be inferred by the ordinary law of elasticity connecting strains and stresses in solid bodies. The instrument affords one of the many examples of the valuable results obtainable by the simplest possible mechanical means—results which before the construction of the strain-indicator were considered altogether unattainable.

The instrument is shown in the woodcut, and consists of two flat plates, T, B, about 1½ inch wide and of an convenient length, pressed together by means of two springs, S, S, in such a manner that one plate projects at one end and the other at the other end. The plates are

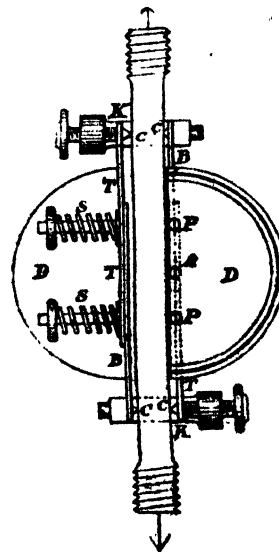

free to slide over each other at their ends opposite. Fixed centre-points, C, C, are screwed one into each end of each plate, and a graduated dial, D, is attached to the upper one of the two plates T. Two of these instruments are held together by a pair of clamps, K, K, fixed just over the centre-points, which, when screwed tight, press the centres against both sides of the test-pieces; for safety against slipping, a few taps of a hammer embed them more firmly. The figure shows a round bolt about to be operated upon by tensile force, the screwed ends form attachments to the grips of the testing-machine. Then when everything is ready, a pair of very fine hardened steel wire rolling pins, P, P, to which light pointers have been attached, are inserted between the plates. The rolling pins, when in position, should be in the centres of the dials. On applying the load to the test-piece, elongation takes place; the centre-points move slightly away from each other, carrying the plates with them, which, as they move in opposite directions, and as they are held

apart only by the interposed rolling pin, cause it to revolve, and the angle through which it has moved can then be read off with the help of the pointer and dial. The best results have been obtained with a wire which was drawn, and which measures exactly $\cdot 015$ inch in circumference. The dial is divided into fifteen equal parts, and their decimals, so that one division represents one-thousandth of an inch, and variations as small as a twenty-thousandth of an inch can be detected.

The above instrument is the outcome of another instrument invented by Mr. Stromeier, of still greater sensitiveness, and which is based on the production of Newton's rings. Its extreme sensitiveness and certain practical difficulties, however, make it unsuitable for the use of the engineer or naval architect, to whom the present instrument is of great value, and by whom it can be very conveniently used.

The strains of a ship in a sea-way have always been very difficult to deal with. Agur and Solomon of old frankly admitted they were "too wonderful" for them, and although the same ingenuousness has not always been practised by naval architects since, the fact remains that the present state of knowledge in this subject is extremely meagre. Methods of calculation have, it is true, been in use by naval architects which have given results most useful for comparative purposes, but which in absolute units frequently indicated forces that ships could not bear. These methods therefore, except for the comparative purposes they were primarily designed to serve, threw no light whatever on the actual conditions of stress on the various parts of the structure in a sea-way. One able investigator showed that the dynamic constitution of sea-waves was such as to make the effective variation of buoyancy enormously less than the apparent variation, and that this difference meant a reduced variation of stress in large ships from, in some cases, 170 to 100. This investigation cleared up many pre-existing difficulties. Mr. Stromeier, however, by means of his beautiful and simple apparatus, enables the variation of stress on any part of any structure, ship, or anything else under the action of any forces to be arrived at with certainty by direct experiment.

The invention of this little apparatus constitutes an era in the science of the strength of complicated structures such as ships, boilers, &c.

WILLIAM BABCOCK HAZEN

THE sudden death of Brigadier-General William B. Hazen, Chief Signal Officer of the United States Army, which occurred on Sunday, January 16, 1887, deprived the country of one of its most distinguished officers, and the Signal Corps of a chief who took a broad view of its duties and relations to the world of business and science.

General William B. Hazen was the great-grandson of Thomas Hazen, who was born 1719. Thomas Hazen was himself great-grandson of Edward Hazen, who emigrated from England before 1649, and settled at Rowley, Mass., where he died in 1683.

The descendants of Edward Hazen include many names eminent in business, theology, and war: energy, industry, and strong convictions characterise the members of the family on all sides.

General Hazen was born at West Hartford, Vermont, September 27, 1830. While he was a child his parents removed to Hiram, Portage County, Ohio. In 1851 he was appointed from Ohio as a cadet to the United States Military Academy, at West Point, from which he graduated on July 1, 1855. He was assigned to the 8th U.S. Infantry, and spent the next five years in frontier service, more especially against the Indians in California, Oregon, and Texas, in which service he displayed an energy and

bravery that have been characteristic of his life. His record during these years embraces constant fights and pursuits. He was twice severely wounded, and by virtue of the latter he was, in January 1860, by the surgeon's order, granted a leave of absence as being unfit for duty. In consequence of this he was at the north while his regiment was in Texas at the breaking out of the Rebellion. The regiment having been captured and its officers released on parole, he alone was unembarrassed by the parole and was able to offer his services to the Union Army; he was at once assigned as temporary instructor at West Point. In May 1861, he became captain of the 8th Infantry of the regular army, and in October was made colonel of the 41st Regiment of Ohio Infantry in the volunteer army. During the war he distinguished himself on many occasions, and his commission as major-general was granted him December 13, 1864, for "specific distinguished services," *i.e.* "for long and continued services of the highest character, and for special gallantry and service at Fort McAllister." This placed him fifth in a list of twenty-four officers who had received commissions for distinguished service.

He continued serving on the frontier territories north and west, and was especially active in Indian affairs until 1870, in which year he was allowed leave of absence to visit the seat of war in Europe. The results of his observations and studies during his six months' absence are embraced in a volume entitled "The School and the Army in Germany and France, with a Diary of Siege Life at Versailles" (New York, 1872). This volume contains a very interesting sketch of Bismarck, and an account of the state of affairs in Europe. It contains especially a fair criticism of the relative excellencies of the German and French systems, both civil and military; in a special chapter on that subject he incidentally brought out more prominently some weak points in our own military organisation. It would seem that the courage displayed so brilliantly on the battle-field frequently nerved him to utter not only these but other fearless criticisms of things that were palpably wrong, and some of which have since been corrected.

He was married, February 15, 1871, to Millie, daughter of the Hon. Washington McLean, of Cincinnati, who, with one son, survives him.

On his return from Europe in 1871, he returned to duty in the Indian Territory, and was with his regiment in Kansas and Dakota, except for a short absence, until December 15, 1880, when he was, by President Hayes, appointed Brigadier-General and Chief Signal Officer, and has since then been stationed at Washington. The absence just referred to was occasioned by his again visiting Europe as Military Attaché to the United States Legation at Vienna, for the purpose of studying the operations of European armies during the Turko-Russian War. He was absent on this service from December 1876 to June 1877, and the results of his observations were published subsequently in a highly interesting popular volume.

The general account of his activity during the war of the Rebellion was published by him in his "Narrative of Military Service" (Boston, 1885).

His letters and pamphlets on the "Bad Lands" show that for many years General Hazen had been studying the relations of meteorology and agriculture. After his appointment as Chief Signal Officer, he was indefatigable in his efforts to improve the military and departmental relations of the Signal Service, its scientific character, its practical usefulness to farmers and herders, and its popular influence. His labours in Washington stirred up most virulent opponents, first when it became necessary for him to expose and prosecute the corruption of Capt. Howgate; again, when it became necessary in self-defence to expose the true reasons of the failure of the War Department to properly support and

succour the Signal Service Expedition to Fort Conger; and again, when he had occasion to defend the advantages of the military character of the combined Signal Service and Weather Bureau organisation against those who would take it from the army without making a proper provision for its work in any other Department. The records of his successful defence against attacks prompted by implacable hate, official stubbornness, and personal ignorance, are to be found in the proceedings of "Courts-Martial," "Courts of Inquiry," "Committee of Congress on Expenditure," and especially in the "Testimony before the Joint Commission to consider the present organisation of the Signal Service," &c., which latter voluminous report and testimony was presented in June 1886.

General Hazen's interest in meteorology, as before said, properly dated back earlier than 1873, at which time he prepared a letter "On our Barren Lands, or the interior of the United States, West of the 100th Meridian, and East of the Sierra Nevadas." This was published in the *New York Tribune*, February 27, 1874, and led to a discussion in that paper and in the *Minneapolis Tribune* between himself and General A. A. Custer, which is summarised in a pamphlet of the above title, published by Robert Clarke and Co., of Cincinnati, in 1875. The motive of General Hazen evidently was the protection of investors and settlers against the too glowing accounts, which amounted to virtual misrepresentation on the part of the *employés* of the Northern Pacific Railroad. His compilation of climatological data, and his statement of personal experience based on long residence in that region, largely contributed to prevent blind emigration into an inhospitable country, while they doubtless also contributed to direct attention to the really valuable portions of our north-west territory, so that the permanent development of that portion of the United States has been furthered by his action. It was, however, at the time, on his part a very characteristic outspoken exposition of what seemed to him a fraud and imposition perpetrated by unscrupulous financiers upon foreign immigrants and over-confiding settlers and investors.

During his connexion with the Signal Office, General Hazen frequently took occasion to show his appreciation of the fact that the weather predictions were essentially not a matter of mere military routine, but that in all its details the office had need of the work of specially trained experts, that it was a mistake to shut one's eyes to the fact that, in a matter of applied science like this, some of those whom the scientific world recognises as meteorologists and physicists must be employed, and be required to keep the chief fully informed of the progress of science. Perhaps this is best exemplified by a quotation from his letter of March 24, 1886, addressed to a Committee of the House on Expenditures of the War Department:—"At the beginning of the work of the Signal Service the duty of giving notice of the approach and force of storms and floods for the benefit of commerce and agriculture throughout the United States implied that the notices should be correct, reliable, and timely, as none others could possibly be of benefit; it was therefore absolutely necessary to provide for the careful study of the atmosphere. On my accession I found every evidence from popular criticism that still further progress in weather predictions was expected. I therefore emphasised especially the necessity of the study of the instruments and methods of observing, and the investigation of the laws of the changes going on in the atmosphere. . . . It is evident by these successive steps that in addition to knowledge gained for current work the office is powerfully contributing towards the establishment of a deductive science of meteorology which will eventually give us a solid, rational basis for predictions, thereby improving on the empirical rules by which predictions have generally been made hitherto." And he adds that he was led more

especially to assist in the researches on the sun's heat by reason of the encouragement given him by the late President Garfield, whose "last words to me were, 'Give both hands of fellowship and aid to scientific men.'"

As a further illustration of General Hazen's appreciation of the scientific needs of the office must be noted his appointment of Prof. William Ferrel as meteorologist, and of Prof. T. C. Mendenhall as electrician. To the latter, all matters relating to standards, instruments, and instrumental research were also committed. Nor did General Hazen stop here; by appointing several younger men to positions as junior professors he largely increased the amount of study and research that the office was able to perform, and by publishing a series of professional papers and smaller notes, he took the final steps necessary to stimulate every man to do his best.

Labouring in this same direction, he sought to elevate the intelligence and scientific training of the Signal Corps proper by enlisting College graduates as far as possible, by extending the course of instruction for observers, and by establishing a course of higher instruction for commissioned officers.

In still another direction General Hazen showed his devotion to scientific interests, namely, by his desire to conform as thoroughly as possible to the recommendations of the International Meteorological Conferences. These recommendations, as soon as received in the printed Minutes of the Conferences, were, by General Hazen's orders, carefully examined, and instructions at once prepared calculated to introduce methods of observation and publication in conformity with the recommendations of the leading meteorologists of the world.

Among the items specially noteworthy wherein General Hazen developed new paths of activity for his service, may be especially mentioned the study of local storms: first, tornadoes, which were especially assigned to Prof. Hazen so far as a collection of general statistics is concerned, and to Prof. Mendenhall so far as concerns the electrical phenomena proper. The study of atmospheric electricity was especially authorised, in 1884, by an order of the Secretary of War transmitting the resolutions of the International Electrical Conference held in Paris the preceding year. After full consultations with numerous electricians throughout the country, General Hazen decided that a daily map of electric potential showing lines of equi-potential similar to the iso-barometric lines, offered hopeful prospect of eventually leading to a method of predicting the formation and motion of thunderstorms and tornadoes. But the methods of observation and the apparatus needed first to be determined upon after careful experimental work. This whole matter was, therefore, in 1885, committed to the hands of Prof. Mendenhall.

Perhaps the most important item in internal administration, so far as it affects the permanent scientific value of the office work, was the effort heartily furthered by General Hazen to improve the accuracy and international comparability of our instrumental equipment. The standards of the International Bureau of Weights and Measures were recognised by him as being the proper legal standards for this office, and every effort was made to determine the corrections needed to reduce the past as well as the current meteorological observations of the office to agree therewith.

Perhaps the generous breadth of General Hazen's views, the absence of injurious jealousies, and his confidence in the principle that the Weather Bureau would be strengthened by the widest diffusion of an intelligent appreciation of meteorology, are in nothing more clearly shown than in the earnestness with which he stimulated the formation of State weather services and encouraged the study of meteorology in every school and college. He was painfully impressed by the disastrous influence upon individuals and business of the widespread and utterly absurd predictions of the storms and weather of

March 9, 1884, which were distributed broadcast throughout the country, and emanated from Mr. Vennor. He saw clearly that all this harm could only be prevented by increasing the intelligence of the people in scientific matters, and heartily indorsed every effort to diffuse a more correct idea as to what constituted legitimate meteorology.

Although his duties demanded the maintenance of a great central office at Washington, yet General Hazen realised that centralisation could easily be carried too far in scientific matters, and would thus react injuriously upon the work of his office. He was desirous of rapid progress in all directions, and, to secure this, welcomed every prospect of co-operation with other institutions as well as with individuals. One of his first acts was the request for co-operation on the part of the National Academy of Science. He improved the opportunity to help Prof. Angley in the determination of the absorbing power of the atmosphere; he accepted Prof. King's offer to carry observers on his balloon voyages; he heartily encouraged Lieut. Greely's efforts to maintain an International Polar Station, and joined with the Coast Survey in establishing a similar station under Lieut. May at the northern point of Alaska; he co-operated with the Bureau of Navigation in securing weather reports from the ocean; he powerfully assisted the Meteorological Society in its labours for the reformation of our complicated system of local times, the result of which was the adoption by the country of the present simple system of standard meridians one hour apart.

Equally successful was he in his efforts to co-operate in various methods of disseminating and utilising the knowledge obtained by the Weather Bureau for the benefit of the business interests of the country. With the telegraph companies he published the daily telegraph bulletin. Through the railroad companies, he displayed the railroad train-signals visible to every farmer along the railroads. With local Boards of trade and other business interests he elaborated our system of flood warnings in the river valleys.

General Hazen was especially clear in his views as to the importance of giving personal credit to each man for his own personal work. Routine work was credited to the assistants in charge and not to the impersonal office. Having assigned a special work to the best man available, he took pains to give him the credit and make him personally responsible for its success, thus securing more enthusiasm in the work.

This notice of a few prominent features in the intense activity of General Hazen's life seems eulogistic rather than historical; but the fact is that military life rarely offers a position that requires the promotion of any special science, and still more rarely do official or military circles present an officer who so thoroughly desired, as far as allowable, to relax stringent military law and liberally interpret cumbersome official regulations, so that scientific men might successfully promote their special work.

Washington, February

CLEVELAND ABBE

SIR WALTER ELLIOT, K.C.S.I., LL.D., F.R.S.

By the death at an advanced age of Sir Walter Elliot, we lose one of the few survivors from a group of men who, in the second quarter of the present century, laid the foundations of our present knowledge. The subject of the present notice was, however, so widely known for his acquaintance with the history, coins, languages, and ancient literature of Southern India, that his biological work might easily be overlooked.

Sir Walter Elliot was born in 1803 at Edinburgh. He is the son of Mr. James Elliot, of Wolfelee, Hawick,

Roxburghshire, and after being educated at Doncaster, and later at Haileybury, where he received a "highly distinguished" certificate, he entered the East India Company's Madras civil service in 1820. In that service he held many posts of distinction. From 1822 to 1833 he was assistant to the political agent of the Southern Mahratta country, and during this period he collected the information subsequently embodied in his Catalogue of the Mammalia inhabiting the region, and also commenced the series of archæological studies, some of the first-fruits of which in 1836 were presented to the Royal Asiatic Society in the shape of a paper on Hindu inscriptions. With this paper were sent two manuscript volumes containing copies of no less than 595 sculptured records from the Southern Mahratta country and the neighbouring territory.

In 1837 he was private secretary to Lord Elphinstone, then Governor of Madras, and he was subsequently for twelve years a member of the Madras Board of Revenue. The value attached to his linguistic knowledge was shown by his being at one time Canarese translator, and at another acting Persian interpreter to the Government. From 1849 to 1854 he was Commissioner for the Northern Circars. During this period he made the collection of Cetacea subsequently described by Sir R. Owen in the Transactions of the Zoological Society, vol. vi. Finally he was Senior Member of Council in Madras from 1854 to 1859, when he retired from the service, and returned to pass the remainder of his life at Wolfelee, the residence of many generations of his ancestors. Almost his last official act in India was, when in charge of the Madras Government in 1858, to take the principal part in the transfer of the Presidency from the rule of the East India Company to the direct government of the Queen. He was created a K.C.S.I. in 1866, and became a Fellow of the Royal Society in 1878, and he was Deputy-Lieutenant of his county.

In his retirement his attention was much given to numismatics, and despite the complete loss of his eyesight in his later years, he carried to completeness the studies commenced in his "Numismatic Gleanings on South Indian Coins," published in the *Madras Journal of Literature and Science* for 1857. He brought out in 1885, with the aid of Mr. Thomas, General Pearse, and other friends, a general work on the "Ancient and Mediæval Coins of Southern India." Up to the very last his interest in Oriental literature remained unabated. One of his friends received a letter signed by him and dated March 1, the day of his death, containing inquiries as to the forthcoming edition of a Tamil work, and suggesting that the attention of Madras native students should be bestowed upon the early dialects of their own language. During the last ten years numerous notes by Sir W. Elliot have appeared in the *Indian Antiquary*, the latest in the September number of last year. Largely through his efforts the Amravati sculptures, now in the British Museum, were added to the national collection, and this was but one of the valuable additions due to him. His Southern Indian coins, a very large and important series, were presented to the same institution, and his numerous zoological collections enriched the Natural History Museum.

Although his published papers on zoology give but an imperfect idea of his contributions to the science, for many of his observations were freely communicated to other naturalists, and published by them, his "Catalogue of the Species of Mammalia found in the Southern Mahratta Country," which appeared in the *Madras Journal* for 1842, was of unusual merit. It had the peculiar advantage that it was a list, not of museum specimens, but of the wild animals inhabiting the country, several of which, and indeed nearly all the smaller rodents, were discovered by the author. The habits of the larger animals were described from personal observation, not, as has so

frequently been the case, from information derived from native collectors.

Personally, Sir Walter Elliot was one of the kindest of men, with a charming manner and generous disposition. At Wolfelee, as formerly in India, he was widely known and universally respected. W. T. B.

NOTES

HE must be a very dull Englishman whose imagination has not been touched by the assembling of the Colonial Conference, an event which may hereafter be seen to have marked the first stage in one of the greatest movements in the history of mankind. In describing the commercial relations of the colonies, Sir Henry Holland, in his opening speech as President, had occasion to bring some very eloquent figures to the notice of the Conference. The imports and exports of the colonies were, in 1885, eleven times what they were in 1837. The British shipping trade with the colonies rose from 3,700,000 tons in 1837 to 56,600,000 tons in 1885, while, in the same period, British exports to the colonies rose from 11,300,000*l.* to 54,500,000*l.* This astonishing material progress, accompanied by an increase of population from 4,204,700 in all the colonies in 1837 to 15,763,072 in 1881, would, of course, have been impossible but for the rapid development of physical science and the steadily increasing application of its principles to the methods of industry. And it is interesting to note that, of all the questions which the Conference will have to discuss, by far the greatest are those most directly connected with the results of scientific investigation—questions relating to the naval and military defence of the Empire, and to the improvement of postal and telegraphic communication. In speaking of telegraphic communication, Sir Henry Holland quoted a striking letter he had received from Mr. Pender. Some of the facts brought together in this letter must have reminded the delegates very vividly of the debt which commerce owes to science. Twenty years ago there were only about 2000 miles of submarine cables, and some of the earlier cables were so badly constructed that they were practically useless. "Science has now, however," wrote Mr. Pender, "aided so greatly in the manufacture of cables that they can at the present time be laid with comparatively little risk of breakage and with an almost certainty of efficient repair." The consequence is that there are now 107,000 miles of submarine cables, which have cost something like thirty-seven millions sterling. The whole of this vast system, with the exception of about 7000 miles, is entirely under British control. To show the relative importance of the submarine cables, Mr. Pender stated that the length of all the land telegraphic lines now in existence in the world is about 1,750,000 miles, representing an estimated cost of 52,000,000*l.*

DR. BROWN-SEQUARD has been elected President of the Society of Biology, Paris. His immediate predecessor was the late M. Paul Bert.

A BILL was lately submitted to the U.S. Senate, providing for the creation of a Department of Agriculture and Labour. Various amendments were proposed, and among them was one for the transfer of the Weather Bureau from the Signal Office of the Army to the new Department. This amendment was accepted by the Committee on Agriculture, and *Science* says that it would certainly have been passed by the Senate had not difficulties unexpectedly arisen with regard to the Bill as a whole. The President, it seems, did not wish to have an additional member in his Cabinet. The Bill was therefore referred back to the Committee on Agriculture, and it did not again come before the House. According to *Science*, there can be no doubt that the Bureau will be transferred next year to some

Civil Department, public opinion being decidedly in favour of the change. In the meantime General Greeley, General Hasso's successor, will retain the position of Chief Signal Officer.

IN the Report of the Scottish Meteorological Society, to which we referred last week, it is stated that during the winter Mr. Cunningham, Superintendent of the Zoological Laboratory of the Marine Station at Granton, and Mr. Ramage, have been continually engaged in a systematic study of the *Chaetopoda* of the Firth of Forth. In the course of this work all the specimens obtained by dredging have been determined, and their anatomy has been investigated. Fresh specimens, and ova and young forms, have been collected on the shore at low tide, and by means of low nets; and a large number of drawings and descriptions have been made, among which are accounts of some species new to the district, and additions to the knowledge of anatomy and development. The results of this work are being prepared for publication.

THE Report for the year 1884 of the United States National Museum, under the direction of the Smithsonian Institution, has just been issued. It contains (1) the Report of the Assistant Director, (2) Reports of the Curator and Acting-Curators, (3) papers based on collections in the Museum, (4) bibliography of the Museum for 1884, and (5) a list of accessions to the Museum in 1884. Among the papers based on collections in the Museum are two admirable anthropological studies by Mr. Otis T. Mason—one on throwing-sticks, another on the basket-work of the North-American aborigines. There is also an excellent study, by Mr. John Murdoch, of the Eskimo bows in the Museum. These papers are carefully illustrated.

ON March 9 a Conference met in the Senate House, Cambridge, to discuss various questions in connexion with the Cambridge University Local Lectures. A report of the proceedings has been printed for the Syndics at the University Press, and it ought to be read by all who are interested in the subject of University Extension. Attention may especially be called to a speech by Dr. Westcott, who argued with much force that the affiliation of local centres to the University might provide an adequate foundation for a national system of higher education. Mr. Browne, Secretary of the Syndicate, who made a financial statement, set forth the claims of the movement to the support of all "who feel that the University Extension system has great powers for good, and has already done excellent work."

Science and Art, the first number of which has just been issued, deserves, and will no doubt receive, a cordial welcome from the class of readers to whom it appeals. Its principal object is to bring the schools of science and art into closer contact with one another. The articles, notes, and correspondence will be on subjects likely to be of especial interest to teachers in those schools, and it is also hoped that the journal may be of benefit to students. Each issue is to contain test-questions in science and art subjects, for which prizes of books and instruments will be given.

ON Tuesday last Messrs. Mourlen, Belgian electricians, had an interview at Brussels with M. Granet, the French Minister of Posts and Telegraphs, relative to the establishment of a telephone line from Paris to London.

AN excellent "General Guide" to the Natural History Museum, Cromwell Road, has just been printed by order of the Trustees. It contains plans and a view of the building.

MR. T. B. COOMBE WILLIAMS has compiled an interesting bibliography of the books, in his own library, on fancy pigeons. The authorship of the works in his list may, he says, be apporportioned as follows: English writers, 58; German (including

lations), 45; French, 21; Dutch, 3; Latin, 3; Italian, 5; Ash, 1; Arabic, 1. More books on this subject have been written in English and German than in any other language.

In a recent Bulletin of the U.S. Fish Commission, Mr. J. Collins describes the finding of a knife of curious workmanship in the thick flesh of a large cod. The "find" was made at Gloucester, Mass., on September 15, 1886, by Capt. Q. Getchell, when discharging a fare of codfish from his boat. He had lifted several fish from a tub, and, running his hand over the thicker portion of one of them to call the attention of the by-standers to its fatness, he felt something hard with his fingers. Further examination produced a knife. The handle of the knife is of brass, curved and tapering anteriorly, with a longitudinal incision, on the concave side, to give the edge of the blade. The form is remarkable, and resembles "the handiwork of some savage tribe, or the scrimshaw work of a sailor." The blade, which is of a lanceolate shape, has been corroded a good deal, and the extreme point is very thin. The total length of handle and blade together is 10 inches. "As to where the fish got the knife," says Mr. Collins, "we can only conjecture, unless some ethnologist can point out its origin. In any case, the finding of such a remarkable implement in such a strange place must be a matter of interest to the ethnologist and naturalist alike."

THE Colonial Council of Cochin China has decided to grant a pension of 6000 francs a year for life to M. Pierre, the Director of Botanical Gardens at Saigon, provided he undertakes to publish in Paris the publication of his "Flore de la Cochinchine," which will leave all the manuscripts and collections which he has employed in the preparation of this work to the colony. The Council has granted La Société des Études Indo-Chinoises a pension of a thousand francs to aid in the publication of its Bulletin.

WE have received the numbers of the *Essex Naturalist*, the journal of the Essex Field Club, for January, February, and March of the present year. The steady growth of the Club has led the Council to decide upon the issue of a monthly journal in place of the former Transactions and Proceedings at regular intervals. It is scarcely surprising that residents of the county of Essex should appreciate the labours of the Society, inasmuch as they are wholly devoted to the county, and are of interest even to persons who know little of Essex. The Society's respect—namely, the thorough examination of the facts lying at their doors—the members of the Essex Field Club set an example that similar Societies elsewhere would do well to follow. Anything relating to the natural history, geology, and prehistoric archaeology of Essex is welcomed. In the present number, amongst the papers in the three numbers before us, are: a discussion on a curious subsidence near Colchester in 1862; a report on the flowering plants in the neighbourhood of Colchester, by Mr. Shenstone, which is a kind of precedent for that particular district to Gibson's "Flora of Essex," published twenty years ago; notes on the saffron plant in England and its connection with the name of Saffron Den; a paper on primæval man in the valley of the Ilen, by Mr. Worthington Smith; and a paper on the deer of the Forest, by Mr. Harting. Apart from a succession of papers such as these, it is scarcely necessary to remind our readers of NATURE of such excellent special work as Prof. Huxley and Mr. White's report on the East Anglian earthquake of April 1884, published by the Society. There are few associations in the United Kingdom which perform so adequately and so judiciously the proper functions of a local Field Club or Naturalists' Society, as the Essex Field Club.

EARTHQUAKES are reported from Travnik, in Bosnia, where a shock, lasting for five seconds, and followed by two others,

was felt on March 22, about 3 a.m. On March 23 three shocks were noticed about 11.15 a.m. at Campfer and St. Moritz (Grisons). At Stuttgart, on March 25, about 4 a.m., a perpendicular shock was felt in the direction from west to east, followed by oscillations continuing for ten seconds. At Savona, in Italy, an earthquake was noticed about the same time. According to a telegram from Aden, dated the 5th inst., shocks of earthquake had been repeatedly felt there during the previous four days, but no damage had been reported.

MR. EDWARD WOODS, President of the Institution of Civil Engineers, will give a *conversazione* on Wednesday, May 25 (Derby Day). It will take place in the South Kensington Museum by permission of the Lords of the Committee of Council on Education.

THE semi-centennial anniversary of the University of Louisville was celebrated on March 2. The doctorate address on the occasion was delivered by Dr. David W. Yandell, who offered some interesting reminiscences of teachers of medicine in the University. When the institution was founded, it was the fourth medical school west of the Alleghenies. "There are as many schools now in Louisville alone," said Dr. Yandell, "as there were then in all the territory which extended from the Ohio River to the Pacific Ocean." Dr. Yandell claimed on behalf of the University that it is "a school where practical medicine is taught in all its branches in a thorough, practical way." "It points to its record with becoming pride, and finds there its guerdon and its hope for the future."

ON April 1 the fine Botanic Garden of Glasgow passed from the hands of the shareholders of the Royal Botanic Institution into the possession of the Corporation of Glasgow. The Garden was founded in 1816. Shortly after this date the Botanic Institution received a Royal Charter, and in consideration of the importance of the teaching of botany in the University, as well as for the general encouragement of the study of this science, a sum of 2000*l.* was granted from the Treasury. A further sum of 2000*l.* was advanced by the University of Glasgow, on condition that special facilities should be given to the Professor of Botany in the University for teaching his science; and it need hardly be said that from this point of view the maintenance of the Garden is of primary importance. The financial history of the Garden has at no time been fully satisfactory, and the Institution has at the end of seventy years found itself in the position of a debtor to the Corporation to the extent of 46,000*l.* The greater part of this sum has been expended in recent years in the erection of fine conservatories, which, in point of condition and extent, place the Garden at the head of provincial establishments. The collections of plants date back to the foundation of the Institution, but the bulk of them have been acquired within the last ten years, very large and valuable donations having been received from Kew, Edinburgh, and Glasnevin, while large contributions have also been made by the leading growers throughout the country. Owing to peculiar municipal complications, following on the totally unexpected rejection of a Bill in Parliament for the annexation of Hillhead and Kelvinside to the city of Glasgow, by a Committee of the Lords, after it had passed through the House of Commons, it is as yet uncertain what line of action the Corporation may adopt with regard to this valuable property which has fallen into their hands. It is in their power to disperse the collections, sell the fine and costly houses, and dispose of the twenty-three acres of land for building-purposes. This course would be deplored not only by the citizens of Glasgow, who would thus lose forever a most picturesque open space, but also by all who are interested in the botanical progress of the country. Were the establishment maintained on its present footing as a Botanic Garden, the Corporation would do credit to itself, and would materially assist in the advance of that which has always been

the most generally popular of the sciences. Already the Corporation has shown that it is disposed to further botanical science by admitting students of the University to the Gardens under certain conditions, while the gates are locked to the general public. It is earnestly to be hoped that this may be the first step towards a permanent policy of encouragement of the study of botany in one of the most densely populated centres in the United Kingdom.

SOME of the American whitefish (*Coregonus albus*) turned into the waters of the Marquess of Exeter at Burghley Park a year ago, were lately caught. They were 7 inches long. This is important evidence as to their adaptability to English waters. The National Fish-Culture Association are incubating a large quantity of the ova of this species for acclimatisation purposes.

SINCE 1878 the Ontario and Western Railway Company has been engaged in re-stocking streams in America within the area of its route. Mr. J. C. Anderson, general freight and passenger agent of the Company, writes to the *American Angler* to the effect that, within the past nine years, 2,220,000 trout have been planted by the Company in the Beaverkill, Willowemoc, Neversink, the east and west branch of the Delaware, and their tributaries.

WE have received vols. xxxix. and xl. of the Proceedings of the Literary and Philosophical Society of Liverpool, containing the principal papers read to the Society during the Sessions 1884-85 and 1885-86. Among the papers of scientific interest in vol. xxxix. are: "Observations on the Nematocysts of *Hydra fusca*," and "The Relationship of Palæontology to Biology," by Mr. R. J. H. Gibson; "On a New Organ of Respiration in the Tunicata," and other papers, by Dr. W. A. Herdman; two papers on "Technical Education," by Mr. F. H. Edwards; "The Armorial Bearings of the Isle of Man, their Origin, History, and Meaning," by Mr. John Newton, and "On the Rocky Mountain Goat," by Mr. T. J. Moore. Vol. xl. contains an address on "Modern Scientific Theories of Man," by the President, Dr. William Carter; "Two Curious Papyri in the Khedivial Museum," by Mr. R. L. Benas; "Recent Locust Plagues in Cyprus and North America," by Dr. Nevins; and "Report on a Successful Importation of Living Soles to the United States," by Mr. T. J. Moore. With vol. xl. is bound "The First Report upon the Fauna of Liverpool Bay and the Neighbouring Seas," written by the members of the Liverpool Marine Biology Committee, and edited by Dr. W. A. Herdman.

THE additions to the Zoological Society's Gardens during the past week include two Macaque Monkeys (*Macacus cynomolgus* ♂ & ♀) from India, presented respectively by Mr. W. Spooner and Mr. F. A. Adeney; a Purple-faced Monkey (*Semnopithecus leucoprymnus* ♂) from Ceylon, presented by Mr. W. H. Markham; a Black-tailed Godwit (*Limosa ugocephala*), British, presented by Mr. Robert Barclay; a Common Guillemot (*Lonvia trailei*), British, presented by Mr. Howard Bunn; a Ring-hals Snake (*Sepedon hamachates*) from South Africa, presented by Mr. W. L. Holms; a Pinche Monkey (*Midas adipus*) from Central America, deposited; two Blue-bonnet Parrakeets (*Psephotus hamatogaster*) from Australia; two Blue-crowned Conures (*Conurus leucorrhous*) from Brazil, purchased; two Viscachas (*Lagostomus trichodactylus*) born in the Gardens.

OUR ASTRONOMICAL COLUMN

BARON D'ENGELHARDT'S OBSERVATORY.—Baron D'Engelhardt has recently published the first volume of the results of the astronomical observations obtained at his private observatory in Dresden. At first the observatory was erected in the Rue

Leubnitz, but was found to be too far from the dwelling-house, and in 1879 the present edifice was erected in the Rue Liebig, close to the Baron's residence, with which it is connected by a covered gallery. The observatory is very completely fitted up. The principal instrument is a fine equatorial by Grubb of 12 inches aperture, replacing one of 8 inches which had been erected in the first observatory. There are two sidereal clocks, a chronograph, a transit-instrument of the bent form, which replaces one by Cook, a very complete Repsold micrometer, and two comet-seekers of special construction. The conduct of the screw of the Repsold micrometer has been very carefully investigated and the inquiry occupies a dozen pages. The observations are principally micrometer measures of nebulae and star-clusters; but besides these there are very many observations of comets and minor planets, of the phenomena of Jupiter's satellites and of the new stars in the great nebula of Andromeda and near α , Orionis, besides meridian observations of the moon and culminating stars. The volume, which is a very handsome one, contains four plates representing different parts of the observatory. The geographical position of the centre of the transit-instrument is given as lat. = $51^{\circ} 2' 19''$ N., and long. = oh. 54m. 54.74s. East from Greenwich.

NEW RED STAR.—Circular No. 16 of the Liverpool Astronomical Society states that on the nights of March 23 and 27 a red star, 7.5 magnitude, was observed 5s. f and 3 s of 26 Cygni. There is no star in the D.M. at this place. The spectrum of the new star is a fine specimen of type III. Place of 26 Cygni for 1887, R.A. 19h. 58m. 9s., Decl. $49^{\circ} 46' 9''$ N.

THE PARALLAX OF Σ 1516.—It appears, from the researches of M. O. Struve on the relative motion of the components of this double star, that the fainter star does not participate in the proper motion of the brighter component, and that they therefore, in all probability, constitute a merely optical pair without physical connexion. Herr Berberich, from a discussion of a series of measures of distances made by Prof. Winnecke, found the relative parallax of the brighter star, compared with the fainter component, to be $0''.199 \pm 0''.05$ (*Astron. Nachr.*, No. 2624). Recently, Dr. L. de Ball has made a series of observations with the equatorial of the Cointe Observatory at Liège, extending from 1885 April to 1886 June, for the purpose of determining this quantity. From sixty-seven observations of relative position-angle he finds $\pi = 0''.091$, and from sixty-four observations of relative distance, $\pi = 0''.112$, and combining these according to their respective weights, $\pi = 0''.104$, with mean error $\pm 0''.008$.

ASTRONOMICAL PHENOMENA FOR THE WEEK 1887 APRIL 10-16

(FOR the reckoning of time the civil day, commencing at Greenwich mean midnight, counting the hours on to 24, is here employed.)

At Greenwich on April 10

Sun rises, 5h. 18m.; souths, 12h. 1m. 21.4s.; sets, 18h. 45m.; decl. on meridian, $7^{\circ} 56' N.$; Sidereal Time at Sunset, 8h. 0m.
Moon (at Last Quarter on April 15) rises, 20h. 34m.*; souths, 1h. 47m.; sets, 6h. 50m.; decl. on meridian, $11^{\circ} 44' S.$

Planet	Rises		Souths		Sets		Decl. on meridian
	h. m.	h. m.	h. m.	h. m.	h. m.	h. m.	
Mercury	4 42	...	10 30	...	16 18	...	$3^{\circ} 8' S.$
Venus	6 15	...	13 59	...	21 43	...	$18^{\circ} 32' N.$
Mars	5 25	...	12 14	...	19 3	...	$8^{\circ} 47' N.$
Jupiter	19 44*	...	0 51	...	5 58	...	$10^{\circ} 55' S.$
Saturn	9 46	...	17 55	...	2 4*	...	$22^{\circ} 28' N.$

* Indicates that the rising is that of the preceding evening and the setting that of the following morning.

Occultations of Stars by the Moon (visible at Greenwich)

April	Star	Mag.	Disap.	Resp.	Corresponding angle from vertex to right for inverted image
			h. m.	h. m.	°
11	49 Librae	5 $\frac{1}{2}$	0 13	near approach	318 —
12	29 Ophiuchi	6	1 16	...	24 274
15	57 Sagittarii	5 $\frac{1}{2}$	2 56	...	79 238
April	h.				
15	3	...	Mercury at greatest distance from the Sun.		

Star	Variable Stars		Decl.	h. m.	h. m.	M
	R.A.	h. m.				
Ceti	2 20'3	0 41 S.	Apr. 14,	14,	3	7 m
gol	3 0'8	40 31 N.	" "	14,	23	56 m
lemnorum ...	6 57'4	20 44 N.	" "	10,	2	0 m
				15,	2	0 M
Monocerotis ...	7 25'4	9 35 S.	" "	15,		m
Virginis ...	12 32'8	7 37 N.	" "	13,		m
Jbræ	14 54'9	8 4 S.	" "	13,	21	29 m
Herculis ...	16 1'2	18 41 N.	" "	15,		M
Ophiuchi... ..	17 10'8	1 20 N.	" "	13,	3	24 m
		and at intervals of 20		8		
Sagittarii ...	17 57'8	29 35 S.	Apr. 10,	3	0	m
Sagittarii... ..	18 25'2	19 12 S.	" "	11,	21	0 m
			" "	14,	20	0 M
			" "	15,		M
Lyræ	18 51'9	43 48 N.	" "	14,	2	0 m
lquise	19 46'7	0 43 N.	" "	14,	2	0 m
ephei	22 25'0	57 50 N.	" "	13,	4	0 m

M signifies maximum; m minimum.

Meteor-Showers

	R.A.	Decl.
Near β Ursæ Majoris..	162	57 N.
ν Virginis...	180	7 N.
μ Draconis	249	51 N.
μ Herculis	270	25 N.

GEOGRAPHICAL NOTES

MR. GEORGE GRENFELL has recently made a successful ascent of the great Quango tributary of the Congo. In company with Mr. Bentley, in the steamer *Peace*, he succeeded in reaching Kikunji Falls, the point at which Major von Mechow, ascending the Quango from the south, was obliged to turn back in 1880. About six miles above the junction of the Kasai and Quango they found another large tributary, the Djuma, entering the river from the east, which presented so great a volume of water that it was a matter of uncertainty which was the larger stream. A little beyond this the course of the Quango turned round, first south-south-west, and then west; at 4° 30' S. it had come back to its usual northerly course, and maintained it for the remainder of the journey. The Kikunji Falls (8° S. lat.) are about 3 feet high, and though insurmountable to the *Peace*, are said by Mr. Grenfell to be no obstacle to communication by canoes and small craft.

IN a letter from the Rev. W. G. Lawes, dated Port Moresby, January 20, it is stated that an Expedition is being equipped under the leadership of Mr. Vogan, the Curator of the Auckland Museum, with the intention of attempting, as soon as the dry season was over, to cross South-East New Guinea, from Ashwater Bay to Huon Gulf.

THE April number of the Proceedings of the Royal Geographical Society is largely devoted to papers on Central Asia. First we have Mr. Delmar Morgan's account of Prjevalsky's journeys and discoveries in Central Asia. Mr. Morgan also contributes a translation in abstract of a recent lecture by M. Anin on his journey in North-Western China and Eastern Tibet, which is followed by an account of the travels of Messrs. Lees, Younghusband, and Fulford in Northern and Eastern Manria. In this last will be found some welcome details concerning the country not previously described.

ACCORDING to Dr. Haas Schinz, who has been recently in the Congo-Ngami region, that lake is not dried up, though its dimensions are gradually decreasing. The River Okovango forms an extensive marsh on the north-west, which sends very little water into the lake during the dry season.

IN a paper by Dr. Ochsenius in the *Zeitschrift* of the Berlin Geological Society, on the age of certain parts of the South American Andes, are some details of geographical and ethnological interest. The author believes that the South American dilleras, or at least a portion of them, are no older than the terraces (as contrasted with the certainly older coast Corrales), and infers, therefore, that Lake Titicaca and the adjoining region must have been raised to its present elevation

of about 13,000 feet within the historical period. Dr. Ochsenius therefore maintains that the enormous ruins of the old Inca city Tihuanaco on that lake admit of no other explanation than that these colossal monoliths were not worked at their present elevation, far less transported thither; it is incredible that the highly civilised Incas would have located their emporium on a tableland now almost uninhabitable. The author supports his conclusions by the fact that representatives of the Pacific fauna still live in Lake Titicaca.

NEWS of Herr G. A. Krause, who is now investigating the district between the Gold Coast and Timbuctoo, has reached Berlin. The traveller arrived at Woghodogho, the capital of Mosi, in October 1886. He obtained permission from the King of Mosi to continue his journey in a northerly direction to Duensa, on his way to Timbuctoo. He hoped to reach the former place in seventeen or eighteen days, to arrive at Sarafaram in four or five days more, and then to descend the Niger to Kabara, the port of Timbuctoo. Herr Krause describes the country between Salanga and the capital of Mosi as being perfectly plain at first, and then followed by a district of low hills and another plain. A day's journey north of Walawala, the traveller crossed the Upper Volta, the source of which lies probably in a north-easterly direction.

ON CERTAIN MODERN DEVELOPMENTS OF GRAHAM'S IDEAS CONCERNING THE CONSTITUTION OF MATTER¹

II.

A QUARTER of a century has elapsed since Graham formulated his conceptions concerning the constitution of matter. I wish now to indicate, as briefly as may be, how these conceptions have developed during these five-and-twenty years.

The idea of the essential unity of matter has a singular fascination for the human mind. It may be that it has its germ in the persistency with which every mind, even that of a child, seeks to get at first principles. The most superficial reader of the history of intellectual evolution cannot fail to perceive how greatly it has modified and directed the development of scientific thought. The whole course of chemistry, for example, has been controlled by this fundamental conception. The half-educated student of to-day may smile at the notion of the transmutation of the metals which held such sway over the minds of the early alchemists, but the men who followed this "*Ignis fatuus*" with weary faltering steps, and who frequently sank under the burden of disappointed hope and the sense that to them it was not given to know the light, felt that this idea rested on a rational basis. They, like we, could give a reason for the faith that was in them. And yet no article of scientific doctrine has in these later times suffered greater vicissitude. Men's ideas concerning the essential unity of things must have received a rude shock when it was found that such a thing as water was not only complex, but was made of bodies strangely contrasted in properties; that the air was still less simple in composition; and that, as it appeared, almost every form of earth could, by torture, be made to give up some dissimilar thing. The brilliant discoveries of Davy, which made the early years of this century an epoch in the history of science, seemed to open out a vista to which there was no conceivable ending. The order of things was not towards simplification: it tended rather towards complexity. And yet Davy himself seemed unable or unwilling to push his way along the path of which the world regarded him as the pioneer. It may be that he was unable to shake himself free from the domination of the schoolmen, or that he unconsciously felt the truth of the principles to which his own discoveries seemed opposed. It is difficult otherwise to account for the tardiness with which he accepted the hypothesis of Dalton; even to the last the Daltonian atom had nothing distinctive to Davy beyond its combining weight. Davy never wholly committed himself to a belief in the indivisibility of the atom: that indivisibility was the very essence of Dalton's creed. In arguing with a friend concerning the principle of multiple proportion, Dalton would clinch the discussion by some such statement as "Thou knows it must be so, for no man can split an atom." Even Thomas Thomson, whom I have already characterized as the

¹ The Triennial "Graham Lecture," given in the Hall of the Andersonian Institution, Glasgow, on March 16, by Prof. T. E. Thorpe, F.R.S. Continued from p. 524.

first great exponent of Dalton's generalisation, was torn by conflicting beliefs until he found peace in the hypothesis of Prout and Meinecke that the atomic weights of all the so-called elements are multiples of a common unit, and which he sought to establish by some of the very worst quantitative determinations to be found in chemical literature. It is curious to note the bondage in which the old metaphysical quibble concerning the divisibility or indivisibility of the atom held the immediate followers of Dalton. Graham, however, never felt such trammels. To him the atom meant something which is not divided: not something which cannot be divided. With Graham, as with Lucretius, the original atom may be far down.

Every philosophic thinker to-day has, I should imagine, come to be of this opinion. Not many years ago it was the fashion to maintain that Stas's great work had for ever demolished the doctrine of the primordial *ylle*, and that Roger Bacon's aphorism that "barley is a horse by possibility, and wheat is a possible man, and man is possible wheat," was henceforth an idle saying. Stas's work is a monument of experimental skill, and it has furnished us with a set of numerical ratios which are among the best determined of any physical constants. It may be that it demolished Prout's hypothesis in its original form, but it has not touched the wider question. Whether indeed the wider question is capable of being reached by direct experiments of the nature of those of Stas is very doubtful, unless the weight of the common atom is some very considerable fraction, say one-half or one-fourth, of that of the hydrogen atom. Dumas has, as you know, modified Prout's hypothesis in this sense, by assuming as the common divisor half the atomic weight of hydrogen, but there is no *a priori* reason why we should stop at this particular subdivision. The exact relation of Stas's work to Prout's law has, I think, been fairly stated by Prof. Mallet at the conclusion of his admirable paper on the atomic weight of aluminium, in the Philosophical Transactions for 1880 (vol. clxxi. 1033). Stas's main result, says Mallet, "is no doubt properly accepted if stated thus, that the differences between the individual determinations of each of sundry atomic weights which have been most carefully examined are distinctly less than their difference, or the difference of their mean from the integer which Prout's law would require. But the inference which Stas himself seems disposed to draw, and which is very commonly taken as the proper conclusion from his results, namely, that Prout's law is disproved, or is not supported by the facts, appears much more open to dispute. It must be remembered that the most careful work which has been done by Stas and others only proves by the close agreement of the results that fortuitous errors have been reduced within narrow limits. It does not prove that all sources of constant error have been avoided, and, indeed, this never can be absolutely proved, as we never can be sure that our knowledge of the substances we are dealing with is complete. Of course, one distinct exception to the assumed law would disprove it, if that exception were itself fully proved, but this is not the case. As suggested by Marignac and Dumas, anyone who will impartially look at the facts can hardly escape the feeling that there must be some reason for the frequent recurrence of atomic weights differing by so little from accordance with the numbers required by the supposed law." Prof. Mallet, in tabulating the atomic weights which may be fairly considered as determined with the greatest attainable precision, or a very near approach thereto, and without dispute as to the methods employed, points out that out of the eighteen numbers so given ten approximate to integers, within a range of variation less than one-tenth of a unit. And he then proceeds to calculate the degree of probability that this is purely accidental, as those hold who carry to the extreme the conclusions of Berzelius and Stas, and he finds that the probability in question is only equal to 1:10978. And he concludes that not only is Prout's law not as yet absolutely overturned, but that a heavy and apparently increasing weight of probability in its favour, or in favour of some modification of it, exists, and demands consideration.

It would be impossible for me to attempt to traverse the whole ground of this question which has been opened up during the past fifteen or twenty years. Even if I could claim the time and your indulgence, there is hardly the necessity for such a demand on your patience. Mr. Crookes, only so recently as September last, gave an admirably complete exposition of the present state of the case in his address to the Chemical Section of the British Association at the Birmingham meeting, and for me to go over the ground again with you would be simply to plough with Mr. Crookes' heifer. Some years ago Mr. Norman Lockyer, as you doubtless

know, approached the subject from another point of view, and in his recent work, "The Chemistry of the Sun," you will find a summary of the evidence which the spectroscopes has afforded us concerning the dissociation of "elementary" matter at such transcendental temperatures as we have in stars like the sun.

Now, when we pass in review all this evidence; when we reflect upon the mode of distribution of the elements, and especially their tendency to associate in correlated groups; when we bear in mind the absolute analogy which exists in the general behaviour and mode of action of the radicles which are confessedly compound with those which are assumed to be simple; when we have regard to the phenomena of allotropy, isomerism, and homology,—the mind insensibly appeals to the principle of continuity, and refuses to believe that the seventy and odd "elemental" forms, to which our processes of analysis have reduced all the kinds of matter we see around us, differ in essence from bodies which are known to be compound.

The connexion between the properties of the "elements" and the relative weights of their atoms, as developed by Newlands, Mendelejeff, Lothar Meyer, Carnelley, and others, has served to strengthen this conviction. The discovery that the physical and chemical properties of the elements are as periodic functions of their atomic weights, is unquestionably the most important generalisation we have had in chemical philosophy during the last five-and-twenty years. Its bearings upon the question of the origin of the "elements" have been worked out in the Presidential address I have already referred to. Mr. Crookes, like Mr. Lockyer before him, in seeking to apply to this question of the genesis of the elements the same principles of evolution which Laplace has already applied to the creation of the heavenly bodies, and which Lamarck, Darwin, and Wallace have applied to that of the organic world, is again appealing to the law of continuity. The mind which holds that Nature is one harmonious whole is fain to believe that the probability that the elements have originated by chance and are eternally self-existent is just as remote as that the animals and plants of to-day are primordially created things. I think in what I am now saying I may fairly claim to be reflecting the opinion on this matter of every philosophic thinker of to-day. Nay more, you must allow that the germ which has been kept alive for so many centuries, and which has come down to us through the brains of a succession of thinkers like Leucippus, Aristotle, Lucretius, Bacon, Newton, Dalton, and Graham, has become quickened and endowed by the light which modern science has shed upon it from all sides, with a vitality which will persist and strengthen.

Having thus traced the development of the idea held by Graham of the essential oneness of matter, let us spend the few remaining moments in considering, in the most general way, how the science of the last twenty-five years has worked out and extended his conceptions concerning the properties of the atom and its mode of motion.

The treatment which "the few grand and simple features of the gas," to quote Graham's phrase, have received at the hands of Clausius, Clerk Maxwell, Helmholtz, Sir William Thomson, and a score of workers in this country and on the Continent who have been actuated by their influence, has served to dispel much of the metaphysical fog which has enshrouded the notion of the atom, and to-day we are able to reason about atoms, as physical entities, having extension and figure, and of their number and dimensions and peculiarities of movement, with the confidence which is based on well-ascertained facts.

We have, of course, not yet attained to a complete molecular theory of gases. But we know the relative masses of the molecules of various gases, and we have calculated in miles per second their average velocity. The phenomena of diffusion indicate that the molecules of one and the same gas are all equal in mass. For, as was pointed out by Clerk Maxwell, if they were not, Graham's method of using a porous septum would enable us to separate the molecules of smaller mass from those of greater, as they would stream through porous substances with greater velocity. We should thus be able to separate a gas, say hydrogen, into two portions, having different densities and other physical properties, different combining weights, and probably different chemical properties of other kinds. As no chemist has yet obtained specimens of hydrogen differing in this way from other specimens, we conclude that all the molecules of hydrogen are of sensibly the same mass, and not merely that their mean mass is a statistical constant of great stability (see art. "Atom," "Encyclopædia Britannica," 9th edition). This line of argument

It seems to me, an important bearing upon a question which has been raised by Marignac, Schutzenberger, and others, and which has again been raised by Mr. Crookes in the address I have just referred to. Mr. Crookes thinks that it may well be questioned whether there is an absolute uniformity in the mass of every ultimate atom of the same chemical element, and that it is probable that our atomic weights merely represent a mean value, around which the actual atomic weights of the atoms vary within certain narrow limits, or in other words that the mean mass is a statistical constant of great stability. The facts of diffusion would seem to lend no support to such a supposition.

Graham was still living when Loschmidt published what Prof. Exner calls his "epoch-making paper" on the "Size of the Air Molecule." Although the numerical estimate which Loschmidt deduced from the mean free path of the molecules and their volume has now only an historical interest, it has exercised a profound influence on the development of molecular physics in demonstrating that in dealing with molecules we are dealing with masses of finite dimensions, and further that these dimensions are by no means immeasurably small. The very manner in which Loschmidt stated his conclusions was well calculated to attract attention. He showed that these magnitudes, small as they are, are yet comparable with those which can be reached by mechanical skill. The German optician Nobert has ruled lines on a glass plate so close together that it requires the most perfect microscopes to observe the intervals between them; he has drawn, for example, as many as 4000 lines in the breadth of a millimetre, that is about 112,000 lines to the inch. Now, if we assume, with Maxwell, that a cube whose side is $1/4000$ of a millimetre is the smallest volume observable at present, it would follow that such a cube would contain from 60 to 100 millions of molecules of oxygen or nitrogen, and if we further assume that the molecules of organised bodies contain on an average 50 "elementary" atoms it further follows that the smallest organised particle visible under the microscope contains about two million molecules of organic matter. And as at least half of every living organism is made up of water, we arrive at the conclusion that the smallest living being visible under the microscope does not contain more than about a million organic molecules. I could have wished, had time permitted, to have dwelt a little upon the intensely interesting questions which such a conclusion at once raises. In the article "Atom" in the present edition of the "Encyclopædia Britannica," from which I have quoted, you will find Clerk Maxwell points out its relation to physiological theories, and especially to the doctrine of Pangenesis. Molecular science, says Maxwell, "forbids the physiologist from imagining that structural details of infinitely small dimensions can furnish an explanation of the infinite variety which exists in the properties and functions of the most minute organisms."

In the year following Graham's death Sir William Thomson still further developed the modes of molecular measurement, and from a variety of considerations based upon the kinetic theory of a gas, upon the thickness of the films of soap-bubbles, and from the electrical contact between copper and zinc, he arrived at estimates which, although sensibly different from that of Loschmidt, are still commensurable with it. In a subsequent lecture to the Royal Institution, given about four years ago, he extended the lines of his argument and arrived at the conclusion that in any ordinary liquid, transparent solid, or seemingly opaque solid, the mean distance between the centres of contiguous molecules is less than $1/5,000,000$ and greater than $1/1,000,000,000$ of a centimetre. And in order to give us some conception of the degree of coarse-grainedness implied by this conclusion he asks us to imagine a globe of water or glass as large as a football to be magnified up to the size of the earth, each constituent molecule being magnified in the same proportion. The magnified structure would be more coarse-grained than a heap of small shot, but probably less coarse-grained than a heap of footballs (NATURE, vol. xxviii. p. 278).

Here I think we may leave the subject, at all events for tonight. I am painfully conscious that I have left unsaid much that ought to have been said, and possibly said some things that might well have been left unsaid. But my main purpose will have been served if I have succeeded in indicating to you Graham's position as an atomist, and in showing you how his ideas respecting the constitution of matter have germinated, and, like the seed which fell upon good ground, have borne fruit an hundredfold.

SOCIETIES AND ACADEMIES

LONDON

Royal Society, March 17.—"On the Total Solar Eclipse of August 29, 1886 (Preliminary Account)." By Arthur Schuster, F.R.S.

The instrument intrusted to me by the Eclipse Expedition was similar to that employed in Egypt during the eclipse of 1882. The equatorial stand carried three cameras, one of which was intended for direct photographs of the corona, while the two others were attached to spectroscopes.

Photographs of the Corona.—The lens had an aperture of 4 inches, and a focal length of 5 feet 3 inches; giving images of the moon having a diameter of about 0.6 of an inch.

During the first minute of totality the corona was covered by a cloud, which was, however, sufficiently transparent to allow the brightest parts of the corona to show on the ten photographs exposed during that time.

During the remaining time, that is to say, during about two minutes and a half, the sky was clear, but there were clouds in the neighbourhood of the sun.

The time of exposing the photographs which had been fixed beforehand had to be altered in consequence of the uncertainty of the weather, and for this reason I can only give the actual times of exposures very approximately and from memory. One photograph on sensitive paper shows only little detail; but three photographs on glass were obtained, which, as regards definition, I believe to be equal to those obtained in Egypt. The approximate exposures were 15 to 20 seconds, 10 to 15 seconds, and about 5 seconds.

With the view of possibly increasing the amount of detail which it has hitherto been possible to obtain on the photographs of the corona, I have, on this occasion, given considerable attention to the different adjustments, so as to fix the cause which at present limits the definition, and I have come to the conclusion that, if we are to obtain better photographs of the corona, we can only hope to do so by means of a better mechanical arrangement for moving the camera.

Photographs of the spectrum of the corona were obtained by means of two instruments, one being identical with that employed at Caroline Island in 1883. This spectroscope has two prisms of 62° refracting angle, the theoretical resolving power being about 10 in the yellow. (The unit of resolving power is the resolving power which allows of the separation of two lines differing by the thousandth part of their own wave-length.) The slit of this spectroscope was placed so that it was tangential to the image of the sun formed by the condensing lens. One plate was exposed during the whole of totality. The results are good; a number of lines belonging to the prominences and to the corona are very distinct and can be measured with fair accuracy. The difficulty of measurement lies in the multitude of lines. I have measured at present between forty and fifty distinct corona lines between the solar lines F and H, and a number remain unmeasured.

A comparison between the photographs of 1882 and 1886 shows that, although the lines seem to be in the same position, their relative intensity has greatly altered. The strongest corona line during the last eclipse had a wave-length of about 4232; it is slightly but distinctly less refrangible than the strong calcium line at 4226.

The second spectroscope had its slit placed so as to take a radial section of the corona. It had one large prism giving a theoretical resolving power of 11.4; slightly larger therefore than the two-prism spectroscope.

The film was one prepared by Capt. Abney so as to be more sensitive in the green than the ordinary plates.

The photograph obtained is faint, but I believe will ultimately give good results.

A good drawing of the corona was obtained by Capt. Maling at the station occupied by Capt. Darwin and myself.

The plates were prepared by Capt. Abney, whose valuable help I have had in the whole of the preliminary arrangements.

March 24.—"Preliminary Note on the 'Radio-Micrometer,' a New Instrument for measuring the most Feeble Radiation." By C. Vernon Boys.

The author considered that, if the thermo-electric power of a
 I have learnt that an instrument essentially the same in principle as the radio-micrometer was made and shown by M. D'Arsonval to the French Physical Society; it is hardly necessary to say that I was not aware of this before reading the paper.—C. V. B.

junction were properly utilised, a more sensitive instrument would be made than the bolometer, which depends on the change of resistance of a conducting filament with temperature. After showing the defects of the ordinary thermopile, he explained the construction of his instrument. A circuit is made of one turn of 1 square centimetre, of which three sides are thin copper wire, and the fourth is a compound bar of antimony and bismuth, each piece being $5 \times 5 \times \frac{1}{2}$ mm., soldered edge to edge. This circuit is supported by a thin rod, to which is fastened a mirror, and the whole is hung by a torsion fibre, so that the circuit is in the field produced by a powerful magnet with suitable pole pieces.

When radiant energy falls on the centre of the bar, the circuit is deflected, and the amount of the deflection measures the energy. The instrument supplies the most delicate means of detecting radiant heat yet made. For instance, the particular instrument made by the author—having proportions which he now knows to be not the best, and with the keeper on the magnet, so that the field was one of 100 units only—was capable of showing the heat which would be cast on a halfpenny by a candle-flame at a distance of 1168 feet, and as the sensibility is proportional to the strength of the field, it would be fully ten times as sensitive with the keeper off.

By calculation it may be shown that an instrument made with certain given proportions, which are easily obtainable, would be capable of showing a change of temperature of the junction of 1/100,000,000 of a degree of heat.

The author also showed a motor consisting of a cross of metal, the centre being antimony and the arms bismuth, to the ends of which are soldered four copper wires, whose free ends are joined by a ring of copper which rotates rapidly when the spark at the end of a blown-out match is held near it.

If the spark is held on the right-hand side of the north pole, the motor will start itself oscillating through angles which increase until it at last begins to revolve, which it will do indifferently in either direction. If the spark is held on the left-hand side, the motor at once stops.

This is interesting in that it is an electro-magnetic motor which goes, having neither sliding nor liquid contacts.

The author promises, shortly, a complete paper in which the best proportions for the various parts are given, and to show an instrument in which these proportions are employed.

Geological Society, March 23.—Prof. J. W. Judd, F.R.S., President, in the chair.—The following communications were read:—Notes on the structure and relations of some of the older rocks of Brittany, by Prof. T. G. Bonney, F.R.S. These notes are the results of a visit to some of the more interesting geological sections in Brittany, in the autumn of last year. The author is greatly indebted for information to the Rev. E. Hill, who took part in the summer excursion of the Société Géologique de France, and to Dr. Charles Barrois, who has for long been engaged in investigating the geology of Brittany. (1) The author briefly noticed the glaucophane-amphibolites and the associated schists of the Ile de Groix, which have been already admirably described by Dr. C. Barrois. (2) The next part of the paper treated of sections in the district about Quimperlé. (3) In this part of the paper were noticed the crystalline rocks of Roscoff, and (more briefly) the Palæozoic strata about Morlaix, with the mineral and structural modifications due to pressure and to the action of intrusive igneous rocks. The author pointed out that, in the latter case, the results either of pressure-metamorphism or of contact-metamorphism differ much from the crystalline schists, which, both in Brittany and elsewhere, are regarded as of Archæan age; and that here in the north at Roscoff, we have a series of banded gneisses, less modified by subsequent pressure than in the south, the structures of which are very difficult to explain on any theory of a "rolling out" of a complicated association of igneous rocks, but which are such as would naturally result from some kind of stratification of the original constituents. The result of the author's work is to strengthen the opinion which he has already expressed, that while the structures of some foliated rocks may be regarded as primarily due to pressure operating on suitable materials, the structure of others seems opposed to this explanation. At any rate the latter rocks appear to have assumed a crystalline condition with a semblance of stratification in Pre-Cambrian times; so that, whatever may be their genesis, they are rightly called Archæan gneisses and schists.—The rocks of Sark, Herm, and Jethou, by Rev. E. Hill.—In opening the

discussion which took place after the reading of these papers, the President remarked on the value attaching to Prof. Barrois's work in Brittany, and on the interest of the observations made on the country by Prof. Bonney. The conclusions as to the Archæan age of the lower gneissose rocks would probably be generally accepted; but a question which must still be regarded as an open one was, whether foliation ever corresponded with original bedding. The supposed instances of unconformity and current-bedding depended on the assumption that such was the case. Mr. Becker, Mr. Rutley, and Dr. Hicks, also took part in the discussion.—Quartzite boulders and grooves in the Roger Mine at Dukinfield, by Mr. James Radcliffe. The statements made in this paper were discussed by Mr. W. W. Smyth, Prof. Boyd Dawkins, Mr. Blanford, and Prof. Bonney.

Royal Microscopical Society, February 9.—Annual Meeting.—Dr. Dallinger was re-elected President for the fourth time. We have already printed the remarks made by Dr. Dallinger in his annual address on the value of the new apochromatic lenses. Having dealt with this subject, he proceeded to record the results of experiments as to the changes of temperature to which the lower forms of organisms can be adapted by slow modifications. For nearly seven years continuous experiments and observations were made, with the result that several organisms had gradually become adapted to live and thrive under a high temperature. Commencing at the normal temperature of 60° F., the first four months were occupied in raising the temperature 10° without altering the life-history. When the temperature of 73° was reached, an adverse influence appears to be exerted on the vitality and productiveness of the organisms. The heat being left constant for two months, they regained their full vigour, and by very gradual stages of increase 78° was reached in five months more. Again a long pause was necessary, and during the period of adaptation a marked development of vacuoles was noticed, which again disappeared when it was possible to raise the temperature farther. The farther history of the experiments presented practically the same features—long pauses, vacuolation, slow advance—until at last the high temperature of 158° F. was reached, when the research was accidentally terminated. It is because it is so difficult to observe the effects of changes through a sufficient number of generations of larger animals that results obtained on the simpler forms are so valuable. Darwin distinctly insisted on the slowness of the process of adaptation. The organisms examined by Dr. Dallinger are incessantly multiplying by dividing, the longest interval being four minutes: half a million generations must therefore have been observed, giving the "countless generations" required. At the end of the series the organisms were found to be fully adapted to a change in the essential condition of life, sufficient to produce death originally.

March 9.—Mr. W. T. Suffolk, Vice-President, in the chair.—Mr. E. C. Bousfield exhibited photomicrographs of *Amphipleura pellucida*, to show what may be expected from the employment of Prof. Abbe's new lenses. The objective employed was a very fine 1/8 apochromatic homogeneous-immersion 1.4 N.A. He also exhibited photomicrographs of salicine crystals as viewed by polarised light, and the colours were purposely selected to test as severely as possible the capacity of the plate used—a Dixon's orthochromatic.—Dr. Crookshank exhibited two photomicrographs of flagellated Protozoa of the blood. These were taken with Zeiss's 1/18 homogeneous-immersion from a preparation stained with magenta. The amplification (1750) was obtained by enlargement from the original negatives. They illustrated the employment of the Eastman bromide paper, and the value of photomicrographs for teaching purposes. The flagella and the delicate longitudinal membrane were clearly demonstrated.—Mr. W. Watson exhibited and described the Watson-Draper microscope, which he had made on the designs of Mr. E. T. Draper. The microscope is an elaboration of the Watson-Crossley form, and the idea of the designer is "that when the object is on the stage, either it may be made to rotate in any direction, horizontal or vertical, round a fixed beam of light without the light ever leaving the object, or the stage may be kept fixed while the light is revolving round it in any direction, horizontal or vertical, always however remaining upon the object."—Mr. J. Mayall, Jun., described the Nelson model microscope exhibited by Mr. C. Baker.—Two papers were read: by Mr. G. Massee, on the differentiation of tissues in fungi; and by Drs. H. J. Johnston-Lavis and G. C. J. Vosmaer, on cutting sections of sponges and other similar structures with soft and hard tissues.

specimens of sections of sponges were exhibited of exceptionally large size.—An arrangement by Mr. W. A. Haswell exhibited for mounting series-sections to the number of sands on one disk for consecutive examination.

EDINBURGH

Royal Society, March 7.—Sir W. Thomson, President, in the chair.—The President read a third communication on the equilibrium of a gas under its own gravitation alone. He finds a large part of his former conclusions has been anticipated by Mr. Homer Lane.—Sir W. Thomson also communicated a paper on Laplace's nebular theory, considered in relation to no-dynamics. In the light of thermo-dynamical principles, ace's theory is seen to be not a mere plausible hypothesis but a statement of actual fact.—Dr. Thomas Muir read part of a paper on the history of the theory of determinants, treating of Gauss from Hindenburg (1784) to Reiss (1829).—Dr. Muir communicated papers on a class of alternating functions, on the quotient of a simple alternant by the difference-product of the variables.—Mr. J. Aitken read notes on solar radiation and hoar-frost.—An account of researches on the influence of certain rays of the solar spectrum on root-absorption and the growth of plants, by Dr. A. B. Griffiths, was submitted by Prof. Crum Brown.

March 21.—Lord MacLaren, Vice-President, in the chair.—Mr. Nicholson read a communication on variations in the value of the monetary standard.—Mr. J. Y. Buchanan read a paper on ice and brine, and another on the distribution of temperature in the Antarctic Ocean.

PARIS

Academy of Sciences, March 28.—M. Janssen, President, in the chair.—On the calorimetric bomb and measurement of heats of combustion, by MM. Berthelot and Recoura. The experiments are described which have been made in this apparatus, originally invented by MM. Berthelot and Vieille for the purpose of measuring the heats of combustion of organic compounds. The method, already applied to slightly volatile substances and gases, may now be easily extended to all volatile compounds, and is consequently a universal method.—On aerial currents, by M. D. Colladon. The author announces that he has succeeded in carrying out on a small scale the experiment described in his note of March 3, demonstrating that in a fluid a vortex may be set up a vortex with vertical axis and ascending movement.—On the variation of solubility of substances according to the amount of heat liberated, by MM. G. Chancel and F. Mentier. The experiments here described show that the solubility increasing with the temperature there does not necessarily correspond an absorption of heat, so that one of the relations established by M. Le Chatelier must be rejected.—On facts from various reports of the local engineering service on effects caused by the earthquake of February 23, communicated by the Minister of War. Among the results recorded at the fissures produced in the Barbonnet Hill running along its entire elevation almost vertically to the magnetic north.—The same earthquake as observed at Moncalieri, by M. Denza. The diagram is given which was traced by the anemograph (Cecchi system) at the Moncalieri Observatory.—On latent heats of vaporisation of some very volatile substances, by M. James Chappuis. The process here applied to the study of the chloride of methyl, sulphurous acid, and cyanogen is based on the employment of the Bunsen calorimeter, by means of which may be determined with considerable accuracy the latent heats of ebullition at 0° under the maximum tension corresponding to the melting of snow. The mean results obtained were for the chloride of methyl, 96.9; sulphuric acid, 91.7; cyanogen, 117.—On the determination of the coefficient of self-induction, by MM. P. Ledebour and G. Maneuvrier. The method here employed to determine this quantity consists of a new adaptation of those of Maxwell and Lord Rayleigh to a particular case in which the coefficient is too weak to produce an appreciable deflection in the galvanometer. It possesses the advantage of dispensing with the use of the ballistic galvanometer, and of rendering possible the employment of an ordinary galvanometer with a mirror.—A study of the alkaline vanadates, by M. A. Le. With a view to determining the place that vanadium should occupy in a classification of simple elements, the author begins a study of the little-known metallic vanadates, taking

first the vanadates of potassa: (1) VO_5KO ; (2) $2\text{VO}_5\text{KO}$; (3) $3\text{VO}_5\text{KO}$, &c.—Double phosphate and arseniate of strontian and soda, by M. H. Joly.—On some ammoniacal combinations of the chloride of cadmium, by M. G. André. This subject, already treated by Croft and Hauer, is here resumed chiefly from the stand-point of the comparisons that it suggests between the three metals zinc, copper, and cadmium, whose oxides are soluble in ammonia.—Action of nitric acid on the solubility of the alkaline nitrates, by M. R. Engel.—On the metallic propionates, by M. Adolph Renard. Among the propionates here studied are those of aluminium, barium, calcium, cadmium, chromium, cobalt, copper, lithium, magnesium, manganese, lead, potassium, sodium, strontium, and zinc.—Age of the upheaval of the Montagne Noire, French Pyrenees, by M. A. Caraven-Cachin. This upheaval is regarded as comparatively recent, being referred to the beginning of the Upper Eocene. It is more recent than the profoundly dislocated Lutetian and Bartonian beds, but older than the Ligurian system.—On the dolmens of Enfida, Central Tunisia, by M. Rouire. For the first time a systematic description is given of this remarkable group of dolmens, about 800 of which are found concentrated in a space of some 250 hectares, disposed without any apparent order, at distances of from 10 to 50 metres from each other. All belong to a perfectly uniform type, consisting of a long horizontal slab resting on upright stones joined at right angles. Except in a few depressions of the ground, none are covered with heaps of earth or stones so as to form true mounds or barrows, and all that were examined had the entrance on the east or south-east side. Like those of Constantine (Algeria), they are all of small size, the vertical stones scarcely exceeding 1 metre in height, and varying from 0.20 to 0.25 metre in thickness. In the few that were opened, little was found except some human bones and very coarse pottery, now deposited in the Ethnographic Museum.

BERLIN

Physiological Society, March 11.—Prof. Munk in the chair.—Dr. A. Baginski communicated the results of his observations and experiments respecting acetonaemia in children. He found that acetone was present in small quantities in the urine of healthy children, though not in all; and that in the case of fever attending any of a very wide range of diseases, the quantity of acetone present in the urine was increased. When children were affected with eclampsia, attended, as such disease mostly was, by serious disorders in the digestion, a larger proportion of acetone was regularly observed in their urine. In regard to the formation of acetone in the blood, experiments in feeding, on different sorts of animals, showed that it was not produced by carbohydrates, as might be conjectured from the composition, $\text{CH}_3\text{—CO—CH}_3$, but from the decomposition of albumen. A longer course of flesh food yielded a very considerable increase in the secretion of acetone, whereas during a course of feeding with farinose and fatty foods, the yield of acetone very rapidly declined, and at length ceased altogether. When a large deposit of albumen occurred in the animal body, after the period of lactation for example, no acetone was found in the urine, even though food rich in albumen was administered. No causal connexion between acetonaemia and eclampsia could be demonstrated either clinically or experimentally. In rickets, in which eclamptic attacks often occurred, no acetone was found in the urine, nor was the administration of large quantities of acetone, even though continued for a considerable length of time, found to produce any effect on the nervous system.—Dr. Frenzel produced a long series of zoological and anatomical preparations preserved in accordance with his method. The preparations were hardened by means of alcohol containing sublimate, and injected with glycerine. The glycerine injection was effected first with a more diluted and then with a more concentrated solution, to which a solution of sugar was added as an ingredient. The relative proportion of glycerine and sugar was determined by the nature of the object.—Dr. Blaschko demonstrated, by drawings and very beautiful microscopic preparations, the structure of the epidermis. Starting with the assumption that the final endings of the nerves of feeling must be sought in the layer of the epidermis and not in the cutis, he had studied the structure of the upper skin at the boundary between epidermis and cutis. He distinguished the main parts of direct feeling (the hairless parts of the skin) from the parts of indirect feeling (the hairy parts of the skin). The former

possessed on the under side of the epidermis very beautifully developed grooves (*Leisten*) forming a reticular system with spiral longitudinal and transverse lines. The hairy parts of the skin were influenced in their structure by the hairs, which likewise stood in spiral series, and had but very indistinct reticulations in the intermediate spaces.

Physical Society, March 4.—Prof. von Helmholtz in the chair.—Dr. Pringsheim reported on a further research into the chemical action of light on mixed hydrogen and chlorine gas (*Chlorknallgas*). This investigation respected the peculiar inductive action of light observed by Bunsen and Roscoe, during which the formation of hydrochloric acid was not effected, although the mixture of chlorine and hydrogen absorbed light, and at all events became changed, seeing the further influence of the like quantity of light at the end of the induction produced a chemical combination of the gases. In a former research (*vide NATURE*, vol. xxxiii. p. 287), Dr. Pringsheim showed that during the inductive action of the light an increase of volume in the gas mixture took place. If by means of electric sparks he illuminated the gas mixture in a glass globe above water, and shut off by a water index, then, on subjection to the first and each following spark up to the fourth, there occurred each time only an increase of volume which rapidly passed away; with the fifth and following sparks the effect was an increase of volume succeeded by a diminution; the latter a proof that hydrochloric acid was now formed and absorbed by the water. The speaker demonstrated at length that the assumption of a thermic influence as the cause of the increase of volume was excluded. On the contrary, he argued, there could here be a case only of chemical change in the gas mixture. It was probably an intermediate condition we had here to deal with, which of course refused explanation from the contemplation of the two gases Cl and H. Seeing that aqueous vapour was also present in the glass globe, the part it played in the reaction was now examined, and the fact was established that its presence was absolutely indispensable in effecting the chemical light effect. Dry chlorine and hydrogen did not unite into hydrochloric acid under the influence of the light; or the process was in such a case effected only very slowly. In all probability, therefore, the induction would have to be explained on the ground that intermediate products with larger volume were formed from the molecules ClCl, HH, and HHO, products whose chemical nature it had not yet been possible to determine.—Prof. Neesen made some supplementary communications respecting the tuning-forks filled with quicksilver, and stated that they had been constructed at an earlier date by Herr König.—Prof. von Bezold described a simple method of presenting complementary colours by means of prism, lens, and a special screen.—Prof. Vogel produced three fluids in three flat phials—one yellow and two blue fluids—which he made use of in demonstrations regarding colour-mixture in order to dispel the belief which prevailed very largely amongst the public that yellow and blue when mixed yielded only green. Phial 1 contained "acid yellow" (*Säuregelb*); phial 2, solution of ammoniacal copper; phial 3, aniline blue. 1 and 2 superimposed on each other gave green; 1 and 3 a fiery red.

Chemical Society, February 14.—Prof. H. Landolt in the chair.—F. Tiemann gave an account of Kiliani's research, according to which arabinose-carboxylic acid has the same composition as gluconic and galactonic acids. Arabinose is regarded as an aldehyde of normal pentahydroxypentane.—Amongst the other papers may be mentioned:—A contribution to our knowledge of secondary and tertiary quinones, by R. Nietzki and F. Kehrman.—Tetramidobenzene and its derivatives, by R. Nietzki and E. Hagenbach.—Substitution of the amido-group in aromatic compounds, by the groups SH and SO₂H, the change being effected by means of a new diazo-reaction, by P. Klason.—The six toluenedisulphonic acids, by the same.—The constitution of pyrene and its derivatives, by E. Bamberger and M. Philip.—The action of chlorine on acet- α -naphthalide, by P. T. Cleve.

February 28.—A. W. Hofmann, President, in the chair.—G. Kraemer gave an account of the work done by himself in conjunction with W. Böttcher on the constituents of mineral naphtha. They have examined naphthas from Tegernsee, Pechelbronn, and Oelheim, and find they consist of a mixture of hydrocarbons which are not acted on by concentrated sulphuric or nitric acid, and of such as are dissolved by the acids with formation of sulphonates and nitro-derivatives; also

small quantities of acids. The indifferent hydrocarbons distinguished by their low specific gravity; they constitute a greater portion of the naphthas, and they consist partly paraffins and partly of hydrocarbons isomeric with the olefins these are called naphthenes. The authors consider the aromatic hydrocarbons which are soluble in acid to be derived from the naphthenes by condensation, in the same way as naphthalene, anthracene, &c., are derived from benzene. The authors also discuss the question of the origin of mineral naphtha.—Amongst the other papers may be mentioned: J. W. Brühl, on J. Thomsen's theory of the heat of formation of organic substances.—C. Gottig, on a new hydrate of soda.—Claisen and Lowman, on a new method of producing benzoic acetic ether.—A. Piutti, synthesis of trimesic ether.

BOOKS, PAMPHLETS, and SERIALS RECEIVE

Smithsonian Report, 1884, part 2 (Washington).—Supplement to Harmonies of Tones and Colours Developed by Evolution: F. J. Hugh (M. Ward and Co.).—Researches into the Etiology of Dengue (Chicago).—On the Influence of Fluctuations of Atmospheric Pressure on the Evolution of Fire Damp (Vienna).—On a Seismic Survey made in Tokio in 1884-85: J. Milne.—Über die Liassischen Cephalopoden des Hierlitz bei Hallstatt: G. Geyer (Fischer, Wien).—Mind, April (Williams and Norgate).—Jahrbuch der k. k. Geologischen Reichsanstalt, 36 Band, 4 Heft (Holder, Wien).

CONTENTS

	PAGE
A Naturalist in South America, I.	51
Coleoptera of the British Islands	51
British Stalk-eyed Crustacea and Spiders	51
Our Book Shelf:—	
Lydekker: "Catalogue of the Fossil Mammalia in the British Museum (Natural History)"	51
Letters to the Editor:—	
Iridescent Clouds.—James C. McConnel	51
Aino Hairiness and the Urvolk of Japan.—F. V. Dickins	51
Units of Weight, Mass, and Force.—Rev. Edward Geoghegan	51
The Earthquake in the Riviera.—Clement Reid	51
Scorpion Virus.—Prof. C. Lloyd Morgan	51
The Supposed Myzostoma-cysts in <i>Antedon rosacea</i> .—Dr. P. Herbert Carpenter, F.R.S.	51
On some Observations on Palaeobotany in Goebel's "Outlines of Classification and Special Morphology of Plants."—Prof. W. C. Williamson, F.R.S.	51
A Sparrow chasing Two Pigeons.—E. A. C.	51
Top-shaped Hailstones.—Alexander Johnston. (Illustrated)	51
A Peculiar Radiation of Light.—Robert D. Gibney	51
The Chemical Society's Anniversary Meeting	51
The Institution of Naval Architects	51
Stromeyer's Strain-Indicator. (Illustrated)	51
William Babcock Hazen. By Prof. Cleveland Abbe	51
Sir Walter Elliot, K.C.S.I., LL.D., F.R.S.	51
Notes	51
Our Astronomical Column:—	
Baron D'Engelhardt's Observatory	51
New Red Star	51
The Parallax of α 1516	51
Astronomical ———— for the Week ending April 10-16	51
Geographical Notes	51
On Certain Modern Developments of Graham's Ideas concerning the Constitution of Matter, II. By Prof. T. E. Thorpe, F.R.S.	51
Societies and Academies	51
Books, Pamphlets, and Serials Received	51

THURSDAY, APRIL 14, 1887

A NATURALIST IN SOUTH AMERICA¹

Notes of a Naturalist in South America. By John Ball, F.R.S., M.R.I.A., &c. (London: Kegan Paul, Trench, and Co., 1887.)

II.

LEAVING Valparaiso, and steering southwards amongst the evergreen islands of the South Chilian Archipelago and Fuegia, Mr. Ball encountered all the disagreeables of those inhospitable and desolate regions, signalled by a fall of the barometer and thermometer, gales of wind, the rolling seas of a tempestuous ocean, fogs, and darkness. And here he observes (and the observation is new to us) that one of the main features of the Andes suffers a great change. The western chain, which runs for 900 miles as an almost continuous range of high land on the coast of Chili, from lat. 40° S. to the Straits of Magellan becomes separated from the range to the east of it by a broad belt of low country including several large lakes. Further south the chain first dips under the ocean, to emerge as the great Island of Chiloe and the Chonos Archipelago, after which it joins the continent again at Cape Tres Montes. Further south is the Gulf of Peñas, forty miles wide, beyond which are the famous channels that lead into the Straits of Magellan. The new geographical features are accompanied by a change of climate, and this again is marked by the appearance of many types of the so-called Antarctic (or rather Fuegian) flora, which may be traced northward from Fuegia to the Mountains of Valdivia, and some few of which types, profiting by the fogs of the desert region of the Andes, straggle northwards into Northern Chili. In Messier's Channel, lat. 50° S., the wild celery of Europe was found, of which Mr. Ball says: "Growing in a region where it is little exposed to sunshine, it has less of the characteristic smell of our wild plant, and the leaves may be eaten raw as salad, or boiled, which is not the case with our plant until the gardener, by heaping soil about the roots, diminishes the pungency of the smell and flavour." "The 5th of June," he goes on to say, "my first day in the channel, will ever remain a bright spot in my memory. Wellington Island, which lay on our right, is over 150 miles in length, a rough mountain range, averaging apparently about 300 feet in height, with a moderately uniform coast-line. On the other hand, the mainland presents a constantly varying outline, indented by numberless coves and several deep narrow sounds running far into the recesses of the Cordillera. In the intermediate channels crowds of islands, some rising to the size of mountains, some mere rocks peeping above the water, present an endless variety of form and outline. That which gives the scenery a unique character is the wealth of vegetation that adorns this seemingly inclement region. From the water's edge to a height which I estimated at 1400 feet, the rugged slopes were covered with an unbroken mantle of evergreen trees and shrubs. Above that height the bare

declivities were clothed with snow, mottled at first by projecting rocks, but evidently lying deep upon the higher ranges. I can find no language to give any impression of the variety of the scenes that followed in quick succession against the bright blue background of a cloudless sky, and lit up by a northern sun that illumined each new prospect as we advanced."

In another passage the scenery is compared to that of the Upper Lake of Killarney, where the evergreen beeches of Fuegia are represented by the arbutus; and where, Mr. Ball might have added, similar climatal features nurture a similar wild variety, profusion, and luxuriance of cryptogamic plants, mosses, ferns, and hepaticæ, and especially broad foliaceous lichens that grow nowhere else in the northern hemisphere in like number and variety. A further similitude between Fuegia and the south-west of Ireland may be traced in the rock-girt deep sounds that run far into the land of both, and which harbour a marine vegetation that has perhaps no parallel for variety, luxuriance, and beauty in their respective hemispheres.

The meeting with floating masses of glacier ice in Eyre Sound suggests some excellent remarks on the well-known phenomenon of the depression of the snow-line and of glaciers in this region, as compared with the northern hemisphere. Threading a devious course through the Straits of Magellan, Mr. Ball's enthusiasm rises to a white heat, that warms the land- and sea-scapes of the grim "Land of Desolation." In his eyes, Fuegia's midwinter glows with brilliant hues. It would make Magellan and Del Canot, Narbough and Davis turn in their coffins could they but read Mr. Ball's ecstasies over the features of the countries in which they starved and froze, and where so many of their ill-starred comrades left their bones, after their bodies had endured incredible sufferings. No doubt we may attribute much of the rapture experienced by our traveller to the contrast which the luxuriant vegetation and picturesque scenery of Fuegia presented to the dismal sterility of the Peruvian and North Chilian coasts, and more to the keen interest which he took in the botany of the region. Still, though "Tantus amor florum" may account for a good deal, there is a large measure of beauty in the scenery of Fuegia that he has been the first to analyse, appreciate, and describe with truth and picturesqueness. Take his picture of Mount Sarmiento, for example, a mountain 7000 feet high. "Sole sovereign of these Antarctic solitudes, I know of no other peak that impresses the mind so deeply with a sense of wonder and awe. As seen from the north, the eastern and western faces are almost equally precipitous, and the broad top is jagged by sharp teeth, of which the two outermost—one to the east, the other to the west—present summits of apparently equal height." Speculating on its geological age, he considers it evident that it is not of volcanic origin, for that no volcanic rock can retain slopes so nearly approaching the vertical. He regards it as a portion of the original rock-skeleton that formed the axis of the Andean Chain during the long ages that preceded the great volcanic outbursts that have covered over the framework of the western side of South America, and that in the course of upheaval its flanks have been carved by marine action to the nearly vertical form which impresses the beholder.

¹ Continued from p. 551.

After a short stay at Sandy Point, a Chilian settlement at the eastern mouth of the Straits, Mr. Ball proceeded to Monte Video and Buenos Ayres, from whence he ascended the Uruguay River; and, passing Fray Bentos, the great factory of "Liebig's Extract of Beef," finally reached Paysandu, equally familiar to English house-keepers for its preserved tongues. This digression gave him a fair view of the aspect of the flora of a great extent of the Argentine Confederation, which, with its Pampas, Salinas, and riparian vegetation differs wholly from that of all the regions he had hitherto visited. For the Argentine Confederation he proposes the term "Argentaria," a good one, which will, we hope, be acceptable to biologists, and to geographers too.

Santos, in South Brazil, was the next point visited, and from there Mr. Ball took the rail to Sto. Paolo, and thence on to Rio de Janeiro. Here he is upon ground familiar to naturalists, and we need only allude to the singular speculation to which his observations on the geology of that part of Brazil, and his reading of the observations of others on the same subject, have given birth. After dwelling on the enormous area of Brazil occupied exclusively by granite and gneiss, and the extent and depth of the deposits of the disintegrated materials formed out of the same matrix, including 200,000 square miles of the plateau of Brazil, the Argentine Pampas, and Paraguay, he goes on to say: "To my mind the conclusion is irresistible that ancient Brazil was one of the greatest mountain regions of the earth, and that its summits may very probably have exceeded in height any now existing in the world." And it is these mountains which he regards as the probable birthplace of the chief types of the phanerogamous vegetation of South America. A few peculiar types, indeed, may have been developed in the Andes, but not such as have stamped their features on the vegetation of the continent. Mr. Ball further correlates this speculation with another as bold, which he gave to the Geographical Society in 1879 (Proceedings, p. 464), and which is, that the chief types of existing flowering-plants originated in the higher mountain regions of the globe "at a period when the proportion of carbonic acid gas present in the atmosphere was very much greater than it has been since the deposition of the Coal-measures." To discuss these novel ideas would be out of place here; but we must, in justice to our author's candour, add his avowal that he regards them "as having no claim to rank as more than probable conjectures, but that, as they rest on some positive basis of facts, they may be serviceable to the progress of science by stimulating inquiry."

It remains to add that the work concludes with two appendixes—one "on the fall of temperature in ascending to heights above the sea-level," which is a model of painstaking research into the methods and observations hitherto adopted, but which leaves this complex subject no further advanced; the other, "on Mr. Croll's theory of secular changes of the earth's climate," is a really valuable contribution to that fascinating inquiry. And here we take leave of Mr. Ball, congratulating him heartily on having added to our library of South American travels a volume that well deserves a corner of the shelf that contains those of Humboldt, Darwin, and Bates.

PALÆOLITHIC MAN IN NORTH-WEST MIDDLESEX

Palæolithic Man in North-West Middlesex. By J. A. Brown. (London: Macmillan and Co., 1887.)

THIS work has two faults by no means peculiar to itself, but which it shares with many books on science.

One of these is the large amount of introductory matter that bars the way to the special subject of study. Thus we do not get into Middlesex until reaching page 42, and then we quit it again after p. 120, to return at p. 185. Certainly, our author shows us how much trouble he has taken in looking up authorities on palæolithic and savage man in general; but he should remember that some folk don't like their whisky to be over-watered.

The second fault one must allude to with sorrow. Why is it that so many scientific scribes have such a weakness for slipshod English? Is it that they feel the advance of science to be so rapid that their works will be passed by in a few years, as out of date, so that it is not worth while to cultivate style, and grammar is hardly essential? Or is it that they expect the bad language of to-day to be the good language of the future, by an evil process of evolution, the survival of the unfittest? Let Prof. Lankester note this as a possible case of degeneration.

One cannot resist giving some examples. On p. 11 we are told that "abundant traces of man in the Neolithic Age are found on the surface of the ground, which may be picked up on ploughed fields." The surface of the ground is usually a good deal picked up on ploughed fields; but of course that is not what is meant. An author who has written much on prehistoric man might perhaps be justified in bringing an action for libel for the remark on p. 67 that "the fauna—as Prof. Dawkins says—is the same, and are referable to the same geological horizon." On p. 90 it is said of a certain tool that "it certainly has the appearance of greater antiquity as an implement, than do a very large proportion," &c. In the middle of p. 94 three successive sentences begin with "It," but that awkward little word in two cases stands for one particular implement, whilst in the third the general type to which that implement belongs must be referred to, as the particular "it" cannot have been found, in these unmiraculous times, in three distinct places: at Ealing, in Kent, and in Surrey. At p. 112 the singular "No. 131" is shortly followed by the plural "They," the latter being meant to refer to other numbers as well.

Having said this much as to things in general, we may say that Mr. Brown's book is a praiseworthy account of a particular district, and that it would not be amiss if other districts had as careful an observer in their midst, eager to see every section, and to record every find. It is a work that London antiquaries and geologists should possess.

Up to the time when Dr. Evans's great work on stone implements was published, but few specimens of worked flints had been recorded from the metropolitan district; but in the same year, Colonel Lane-Fox (now General Pitt-Rivers) recorded the finding of a large number in the

gravels round Ealing. Notwithstanding this, however, hardly any addition was made to London implements for some years, when Mr. Worthington Smith developed the marvellous faculty of finding them in nearly every gravel-pit he went into. Our author makes a good third to these two, and that is saying a great deal. It is to be hoped that his book may lead other observers to join in the work that he has so much advanced, and to do for other parts of London and the surrounding country what he and the above-named authors have done on the north-west and north-east, and Mr. F. Spurrell on the south-east.

The antiquity of man is so controversial a subject that anyone who writes on it must expect to find more foes than friends. Mr. Brown, therefore, must not be surprised at exception being taken to some of his views, and in noticing his work one may fairly point out some matters on which opinions are likely to differ.

The remark, on p. 13, of piles (for dwellings) having been found at Moorfields received a curious illustration whilst it was in the press; for a building in that district was then being underpinned, on account of part of the pile-structure on which it was based having decayed; that building being none other than the lecture-hall of the London Institution.

The name "chalky boulder clay" was given by Mr. S. V. Wood, Jun., and not by Mr. Skertchly, as the footnote on p. 27 says.

That the brick-earths of Erith, Crayford, &c., are pre-glacial few geologists will be found to believe; perhaps, indeed, only Prof. Dawkins; and our author wisely throws the burden of this belief on that gentleman (p. 33).

As to the Tilbury man, alluded to on p. 42, there can be no doubt that his remains were found in a very late post-glacial deposit, simply the alluvium of the Thames. Mr. T. V. Holmes has set this question at rest (Trans. Essex Soc.).

By a slip, on p. 45, hard chalk, flint, and greywethers have been classed amongst rocks that do not occur in the valley of the Thames.

Probably there are geologists who would be disposed to question the strictly glacial origin of the furrowed gravel and the bent loam carefully described on pp. 45-47. Such irregular surface-deposits are so common in districts far from undoubted glacial beds as to leave their origin doubtful.

"The large encroachments of the sea which have taken place . . . in historic times" are no proof of depression (p. 48). They are simply the result of denudation along coasts.

The term "alluvium" should be confined to the deposits of rivers and not applied generally to surface-soil, as on p. 50, in which case it becomes a useless synonym.

The peculiar black bands often seen in gravels have troubled many observers, but from finding particles of carbonised wood occasionally in them Mr. Brown is not justified in saying that "there seems to be no doubt that such black strata are due to vegetable life," especially as he recognises the fact that the colour (which is what he refers to) is generally due to oxide of iron or of manganese. And even were the blackness due to vegetation, it is by no means a reasonable assumption that the beds were land-surfaces (p. 54), for the vegetable remains may

have been carried down by water. That the white beds occasionally seen are "probably the result of decomposition of animal or vegetable matter" is also rather doubtful, the colour (which here again is what the author refers to, though his language implies the beds themselves) being often the result simply of the washing-out of the iron-oxide, which gives the usual brown tint, by percolating water.

There may be some doubt whether, when man first invaded England, the connexion of our country with the mainland was caused "by the uprise of the bottom of what is now the . . . North Sea." The present severance need not have been brought about by depression, but perhaps is owing simply to denudation, so that there is no need to invoke uprise to account for former connexion. There is also some difficulty in the uprise in question, as Mr. Brown thinks that Middlesex, &c., "was slowly emerging from the sea," and therefore must have been at a lower level than now. It is most likely indeed that at that time the whole land was higher than now, as otherwise it would be hard to account for the greater size of the rivers, as compared with their present descendants, for higher land would give greater rainfall, and greater rainfall means stronger streams. If "man beheld the land now under the 300-foot contour in Middlesex as an arm of the sea," there could have been nothing worthy the name of river, or even of brook, in the county, and the deposition of such coarse matter as our river-gravels would be out of the question (pp. 67, 68), those gravels certainly not being marine deposits.

In the picture of a Palæolithic scene from Castlebar Hill (pp. 185, &c.), it would seem as if the author were, as is often the case with geologists, a little too much impressed with the present features of the country, so as to allow too little for the amount of denudation that has happened since the time his picture represents. Instead of water then occurring over the whole of the low clay-country to the north, is it not possible that the tract in question was much higher than now, a great sheet of clay having been gradually swept off it since? Indeed, the author distinctly recognises the great amount of denudation that has occurred south of Castlebar Hill, along the valley of the Thames (pp. 191, 192), and of course there is no possibility of the process being confined to one side of the ridge.

The conclusions of Dr. Hicks as to the Glacial or pre-Glacial age of man in North Wales, noticed at the end of the work, are not altogether accepted, and should be considered as still waiting for the verdict of geologists.

Mr. Brown is clearly a positivist, as far as worked flints are concerned, and one is tempted to speculate on his direct descent from Palæolithic ancestors, for, as if by some hereditary instinct, he is enabled to be quite positive as to the uses to which sundry implements have been put, to an extent, indeed, to which probably few or even that highly imaginative class of men, antiquaries, will follow him. Some examples of this positivism may be noticed. Thus certain flakes were "evidently intended for spear-heads" (p. 53); and certain "triangular stones . . . could hardly have been intended for use in any other way" than as arrow-heads, "they were no doubt hafted" (p. 117); but from the figures given of some of these stones one would be inclined to regard them as little else

than castaways (Nos. 167, 169). In another case, "as the greater part of one side is flat . . . it is evidently done for the purpose of being held in the hand" (p. 86). Again, "the object of making such an instrument is clear," namely, "for insertion in a club" (pp. 94, 95). "There can be no doubt that . . . they have been, or were intended to be, inserted into sockets" (p. 109). No. 159, in which "we have a shaft-smoother, borer and knife included in one object" (p. 116)," must have been the delight of some Palæolithic schoolboy! Where statements of opinion occur in such form as "*I* have no doubt," they are of course justifiable; but in this sceptical age it is risky to say "there can be no doubt." It is quite refreshing to hear that there are implements whose "use is almost beyond conjecture" (p. 98). Most likely differentiation in the use of tools did not go far in Palæolithic times.

In the illustrations it would seem that in some cases justice has hardly been done to the specimens, or we should not be told by so experienced a person as the author that No. 144 (Plate ii.) is "the finest example of Palæolithic work" that he has seen. There is, too, a deficiency that should be supplied in another edition: a map and a general section of the district would much help most readers; and these could well be given instead of some of the foreign objects, such as the eternal carved reindeer, &c., without which no anthropological work seems to be thought complete, and which, by frequent repetition, have grown to be nearly as irritating as the faces and figures ever obtruding themselves from the advertising columns of newspapers and magazines.

The frontispiece, by Mr. Worthington Smith, should be acceptable to the advocates of women's rights. The woman is represented as the skilled artist, whilst the man is the mere labourer!

OUR BOOK SHELF

Hand-book of Practical Botany for the Botanical Laboratory and Private Student. By Prof. E. Strasburger. Edited from the German by W. Hillhouse, M.A., F.L.S. (Swan Sonnenschein, Lowrey, and Co., 1887.)

PROF. STRASBURGER'S well-known work, "Das Botanische Practicum," has already been reviewed in the pages of NATURE (vol. xxx. p. 214), so that a short notice may suffice for the present hand-book, which is essentially a translation of the smaller German edition. Only the account of the fall of the leaf (pp. 156-59) has been taken from the larger work.

The present edition has been fully revised by the author, and also contains a considerable number of editorial notes and additions. The latter are usually indicated by being inclosed in brackets. It would, perhaps, have been better if this had been done throughout, especially in the introduction. A number of additional figures have been inserted by the editor. These are almost all reproductions of familiar text-book illustrations. Many of them certainly come in well, but we cannot help feeling that the constant reappearance of old figures has become rather wearisome, and that in this instance it tends to take off from the freshness which was so pleasant a characteristic of Prof. Strasburger's "Practicum."

We much regret that no account of any of the seaweeds finds a place in this edition. The admirable description of *Fucus* in the larger treatise of the author might well have been introduced here, while we think that the editor would have been well advised to add an

example of the real seaweeds on his own account, or at least to reproduce Prof. Strasburger's description of the fresh-water *Batrachospermum*. It is easy to see why the author, writing for German elementary students, omitted all reference to seaweeds in his smaller edition. In England we are in a very different position, and it is a pity that students should not at once be made acquainted with plants which are so instructive and so easily accessible.

As the editor explains in his preface that the translation was executed at a time of serious pressure, it would be unfair to enter into any detailed criticism. It must, however, be admitted that the signs of haste are very frequent, and that there is much need for revision in a future edition. There are one or two instances of this which cannot be quite passed over. At p. 11, "durchschnittlich," which means *on the average*, is translated "sectionally," while at p. 49 we have "carefully," where the author says "with advantage" ("mit Vortheil"). At p. 169, note 2, "perfection" should be "development," while on p. 208 the statement that "we know the angular outline of the crystals [in *Spirogyra*] even without reagents," has an odd effect. The word should of course be *recognise*. At p. 67 the use of the word "pits" for the deep depressions ("Grübchen") which lead down to the stomata in *Aloe*, &c., seems to us likely to confuse the beginner. The phrase "starch-builders" (p. 43, &c.) strikes us as awkward, and is certainly not accurate as a translation. The use of the term *luticiferous cells*, in speaking of *Chelidonium*, is unfortunate. The organs in question of course come under the head of *luticiferous vessels*.

In conclusion we may express a doubt whether the un-English form "fibro-vasal" has any advantages over the familiar word "fibro-vascular."

The appendixes have been much expanded from the original indexes of the author, and should be of great use to the student, to whom the book as a whole will be extremely welcome.

D. H. S.

Elementary Practical Biology—Vegetable. By Thomas W. Shore, M.D., B.Sc. (London: Churchill, 1887.)

THIS book is welcome more as a sign of the ever-growing attention paid to plant-structure than for any peculiar merit it has as a guide to the subject. The author fairly expresses his indebtedness to such practical books as Bower and Vines's, and claims originality only for his arrangement and treatment of the subject. The arrangement is as follows:—First comes an introduction dealing with the necessary apparatus and the preparation, &c., of objects. This is very concisely and sensibly done. Part I. deals with general vegetable morphology, treating in due sequence of the cell, the tissues, the systems of tissues, the apices of stems and roots, and cell-multiplication or cell-reproduction. Part II. is devoted to the Cryptogamia, beginning with the Fungi and working up to the vascular forms. Part III. is confined to the Gymnosperms, and Part IV. to the Angiosperms. So much for the arrangement. There may be no guide to practical work covering precisely all these types in this way, but text-books are by no means wanting which contain this arrangement of matter. The originality here is therefore not at all striking—perhaps fortunately so. As for the treatment, the student is conducted through the course with a baldness in the directions to note this and observe that, which reminds one of the style of a personal conductor through an historic building. The book has a purely practical aim, with the excellent purpose of preventing "cram"; but a student who should undergo this course of instruction, noting and observing no more than he is here directed to do, would find himself, at the end of it, the dispirited possessor of a mass of information which would result in a sad fit of mental indigestion. A practical guide of this kind throws too much of the burden of instruction upon the lecturer whose course accompanies

it. The style of the whole book leads one to doubt the author's claims as a botanist to write it, and though it may be a suitable guide to those who have to acquire a knowledge of botany in the course of their studies, it is practically useless for the rearing of botanists. Though one is reluctant to attribute a wrongly-spelt word to other than the conveniently necessary printer, the occurrence of *Felicinea*, not once, but regularly, and, moreover, in the boldest and most conspicuous type of the headings of sections, does tempt one to think that the printer's fault lay in not having corrected it. A detailed criticism of the book would exhibit the author's imperfect acquaintance with the types discussed and his errors in description. Such, however, is beyond the scope of this notice.

LETTERS TO THE EDITOR

[The Editor does not hold himself responsible for opinions expressed by his correspondents. Neither can he undertake to return, or to correspond with the writers of, rejected manuscripts. No notice is taken of anonymous communications. The Editor urgently requests correspondents to keep their letters as short as possible. The pressure on his space is so great that it is impossible otherwise to insure the appearance even of communications containing interesting and novel facts.]

A Plant which destroys the Taste of Sweetness

DURING his tenure of office as Governor of Madras, Sir Mountstuart Grant Duff found time, in a way at which I never ceased to marvel, to correspond with this establishment about every kind of detail connected with the botanical productions of Southern India. In one of the last letters which I received from him at the close of last year, before his departure from India, he writes:—"I send you inclosed in this a portion of that delightful plant *Gymnema sylvestre*, an Asclepiad. I shall be curious to know whether when it gets to you it retains the very interesting property that, if you chew carefully two or three leaves of it, it absolutely abolishes for the time the power of tasting sugar. This is no fable, for three of us, I being one, tried it this morning at breakfast with the most complete success. I ate pounded sugar after it without the faintest perception of its saccharine character. I also drank coffee without any sugar in it, and tasted it just as well as I ever did.

"General Elles has just been up to my room to tell me that he also found it abolish the power of enjoying a cigar. Do try it, and report to me, when we meet, whether it stands the long journey. This *Gymnema* might conceivably be important medically."

We found that the leaves sent by Sir Mountstuart Grant Duff did retain the property he described in a marked way. I immediately wrote to Mr. Lawson, the Director of Public Gardens and Plantations, Ootacamund, to endeavour to procure some seed which we might grow at Kew, so as to obtain material for future experiment. In a letter received from him this morning he promises to do this when the fruit is ripe. He has, in the meantime, been so good as to inclose in his letter a paper by Mr. Hooper, the Government Quinologist, which appears to me to well deserve the wider publicity of the pages of NATURE.

The whole matter is a good illustration of the useful work which can be done by scientific men in distant parts of the Empire, which indeed could hardly be done in any other way.

W. T. THISELTON DYER

Royal Gardens, Kew, April 11

[Mr. Hooper's paper will be found on pp. 565-67.]

Units of Weight, Mass, and Force

It is not easy to follow Mr. Greenhill in his letter which appeared in NATURE of March 24 under the above heading. His main contention appears to be that "weight" connotes not "force" but "mass" in engineering formulæ. Surely it would be more correct to say that the primary idea among engineers is that of force, mass being of secondary consideration and being measured by means of force: the force most commonly referred to being that of gravitation, which is the force, *par excellence*, with which the engineer has to deal. And I think it would be impossible to find any ordinary engineering formula involving W (which is generally supposed to stand for weight) in which W does not

mean gravitation force. Also, in formulæ which have nothing to do with gravitation, and in which M (or mass) would naturally appear, the engineer puts $W \div g$ instead of M , so as to enable him to express it in terms of his unit of force, the weight of a pound. Thus, the kinetic energy of a moving body is $\frac{1}{2}Mv^2$ (where M is its mass and v its velocity), and is quite independent of its position in space. Engineers, however, who only care about bodies near the earth's surface, express the energy in terms of the merely local phenomenon, the weight or gravitation force acting on the body, which is sufficiently constant for their purposes, and write $\frac{1}{2}Wv^2 \div g$. There is consequently a struggle between engineers and physicists as to whether "pound," "ton," &c., shall connote the fundamental engineering quantity, namely, weight, or the fundamental physical quantity, namely, mass; and, naturally, neither side is very willing to give way. The easiest way perhaps would be for the physicists to give another name to the mass-unit, and leave engineers to the enjoyment of their use of the word "pound"; though meanwhile the word might very well connote either mass or weight (i.e. gravitation force) according to the context, the terms pound-mass and pound-weight being used when special clearness is desired. But do not let us, as Mr. Greenhill seems to desire, use weight and mass as synonyms, so losing the advantage of a good word for no good reason.

But Mr. Greenhill's most incomprehensible attack is on the formula $W = Mg$.

The equation means fundamentally neither more nor less than that the force of gravitation on any mass near the earth's surface gives, or tends to give, to that mass a constant acceleration called " g ," and is to be measured by mass and acceleration conjointly, in accordance with Newton's second law, the fundamental law connecting force and motion. The symbol = means "equivalent to," as it often does.

From this fundamental equation can be deduced special numerical equations by means of definitions of arbitrary standards. Thus a "poundal" is the force which will produce in a pound-mass an acceleration of a foot-per-second per second;

$$\therefore W(\text{in poundals}) = M(\text{in pounds}) \times g(\text{in ft.-per-sec. per sec.}) \\ = M(\text{in pounds}) \times 32, \text{ approximately,}$$

this equation being merely a numerical equation deduced from the fundamental physical equation above. For W (in poundals) means the ratio of the weight of a body to the force called a poundal, or weight per poundal, or $\frac{\text{weight}}{\text{one poundal}}$, and so is a mere number depending on the particular mode of measuring W : and similarly with the other quantities.

Again, a pound-weight is the force which produces in a pound-mass the acceleration g ;

$$\therefore W(\text{in pound-weights}) = M(\text{in pound-masses}), \\ \text{or ambiguously}$$

$$W(\text{in pounds}) = M(\text{in pounds}),$$

which is another merely numerical equation, and of course also only an approximate one; as Mr. Greenhill incidentally shows by means of his hypothetical balance at the coal-pit.

Too much importance can hardly be laid on the radical distinction between a physical equation and the various numerical equations which by choice of special units can be deduced from it. This must be my excuse for dwelling so much on the above example. It throws light on the way in which the error cited by Mr. Greenhill in his last paragraph can creep in. Thus, if the mass of a body of weight W is $W \div g$, it really follows that the mass of a body whose weight is W pounds (or, less ambiguously, W pounds-weight) = W pounds-weight $\div g$; but by definition one pound-weight $\div g$ = one pound-mass, \therefore the mass = W pound-masses. In Mr. Greenhill's example W is a mere number, and he shows the error caused by trying to insert it in a formula where W means a weight.

In conclusion, if Mr. Greenhill insists on the abolition of the equation $W = Mg$, will he kindly say how he would symbolise the connexion between the force of gravitation on a freely falling body and the induced acceleration g ? ALFRED LODGE

Cooper's Hill, March 30

The Association's "Geometry"

As the President of the Association for the Improvement of Geometrical Teaching did me the high honour to mention with special approval my work on geometry in his remarks before the

Association, printed in the twelfth Annual Report, 1886, I feel impelled, on at length receiving to-day, at this frontier outpost of scientific civilisation, a copy, long ordered, of the Association's "Plane Geometry," Part 2, to say a few words suggested by it, favouring accord in these fundamental matters.

The very first definition and first theorem show the glaring need in English for a word which the Germans have in *Strecke*. Such a word, meaning a piece of a straight line, is needed in the first definition, the definition of a circle, for all straight lines are infinite in size, and radii are pieces of straight lines, and not whole straight lines. This is unconsciously recognised, even in the first theorem, where for "piece of a straight line" the undefined word *distance* is used, inappropriate because of its association with ideas of measurement by a unit and length, and because of its different and confusing use in the phrase "shortest distance."

In the demonstration of this first theorem, "straight line" is used in its proper sense, though just before, in the first definition, it was bunglingly used in the sense here given to *distance*. For the part of a straight line between two definite points I have long used the word "sect," which, carried over to the sphere with the meaning part of the spherical line less than half, gives the key to two-dimensional spherics.

And this suggests another objection to the same first definition. It says a circle is a plane figure. Now one cannot even think of spherics without seeing how immeasurably better it is to define a circle as a curve. It will be so defined as soon as the student reaches analytics, so why have him learn something only to unlearn?

In the fourth definition we have an over-used word, "conjugate." Two arcs which together make a circle should be called *explemental*. Explement is a natural third to complement and supplement. Again *converse* is a term of logic, and does not mean what it is here used to mean, that is, *inverse*.

In the introductory remarks to the fourth book I think it is a mistake to call hunger, love, courage, talent, wisdom, *magnitudes*.

A magnitude is whatever can be added to itself, so as to double. The very first sentence says: "In this book the subjects of the propositions . . . are magnitudes in general;" but the whole treatment is founded upon *multiples*, and is only applicable where multiples can be made. Not only must we have an exact criterion of equality, we must be able to add without shrinkage.

A little farther on we meet the absurd statement, "Fundamentally, number is counting."

Now we know that counting is establishing a one-to-one correspondence between the individuals of an aggregate and of a standard group which was primarily the fingers. But a number is fundamentally a picture of an aggregate which for all counting purposes is as good as the aggregate itself—a picture consisting of a mark for each distinct individual in the aggregate, as III.; and then secondarily a symbol for that picture, as 3.

It is questionable whether Book IV. Part 1, has any valid excuse for existing. Proportion for commensurable magnitudes neither calls for nor warrants treatment by multiples. Sandeman, in the preface to his "Pelicotetics," speaks of "the phenomenon of incommensurability, through which alone arises any need of ratio, either the thing or the name." Euclid's marvellously elegant treatment of proportion is only admirable because of the difficulty it so deftly overcomes. To use it on commensurables is to use a Gatling gun on a plucked chicken. The illustration given under Definition 4 of this Part 1 (which definition needs the word commensurable inserted in it), "4 half-crowns = 5 florins," reminds one how badly England needs a decimal system of coinage, weights, and measures. No light is thrown on the compounding of ratios, but the error of A. J. Ellis is avoided. He says: "The ratio of B to A means the order in which the multiples of B are distributed among those of A."

These are points suggested in first turning the leaves of a new book of most gratifying soundness. May it ward off from England the misfortune America now suffers, in that our most popular book on geometry makes the fundamental blunder of basing the treatment of parallels on direction, uses in its proofs the stultifying formula, "a straight line is the shortest distance between two points," and from one end to the other makes us wish for an American Association for the Improvement of Geometrical Teaching.

GEORGE BRUCE HALSTED
University of Texas, Austin, Texas, March 3

The Svastika as both Sun and Fire Symbol

THE late Prof. Dr. Worsaae ("Industrial Arts of Old Den-

mark") claims the ring-cross , as he terms it, as a sun

symbol, and a small cup-shaped hollow for the moon; both these he places as belonging to the *later* Stone Age of Scandinavia, and, apparently, the only recognised emblems of that period. He observes, in one place: "How many hundred years, or, indeed, how many thousand years, before the Christian era the earlier Stone Age began, it is impossible to say."

The same writer places amongst the emblems of the *later*

Bronze Age the wheel-cross  (the chariot wheel of the

sun?). To this day, both in Denmark, Holland, and in parts of Germany, a wheel is frequently placed on the roof of a stable or other building, which is thus deemed protected from fire, especially if a stork can be induced to make its nest upon the wheel. The stork, owing to his red legs, was not inaptly considered an emblem of fire; he was also the herald of summer—he brought light and warmth. The Moqui symbol for the sun (as described by Dr. Dyer in NATURE, Feb. 10, p. 345) exists also on articles classed by Prof. Worsaae as belonging to the later Bronze Age in Scandinavia, with the exception of the three marks of which he speaks, as indicating the eyes and mouth of a face.

According to Hyde ("Persian Religion," p. 38), "Idolaters as well as sun-worshippers existed in ancient Persia, and the wor-ship of fire and that of idols were combined at one period."

Quintus Curtius, when describing the march of the army of Darius (writing, however, long after date), says:—"Darius was accompanied by an image of the sun, placed in a crystal, and the sacred fire carried on a silver altar."

The sun, which was regarded as a wheel, a store of gold, an eagle, was also styled the eye of Varuna.¹ The worship of Mithra was likewise a worship of the sun; Mithra was the god of daylight. He and Varuna were fabled to journey at even in a brazen car. From this has probably arisen the horse-sun and the wheel-sun. Euripides gives the sun a winged car; and, on coins from Eleusis, Démêter is represented riding in such a car drawn by two serpents.

The *svastika*  has been very generally allowed

to be a symbol of Thor, who, to the Scandinavians, was the god of thunder and lightning and of the domestic hearth, and therefore of fire also. The arrows in the hand of Jove, the thunderer of Roman mythology, resemble somewhat a compressed or crushed *svastika*. The above form of this symbol,

with a very slight variation , may be seen on a



slab taken out of a Christian catacomb in Naples, and now in the National Museum there. A very natural inference is, that this stone sealed the grave of one who had suffered martyrdom by fire.

The *svastika* has been held to be an emblem of fire, as being the way in which that element was first produced by primitive peoples—a method which is said to be in use in certain Hindû temples at the present day. It consists in two crooked sticks being laid one across the other, and a hole drilled through both; a pointed stick being there inserted, this is rapidly twirled by the hands until the five points of contact become ignited.

¹ To the Persians, Varuna was the god of the clouds and of the celestial sea. When this branch of the Aryans reached Southern India, he there became to them the god of the earthly sea. To the Greeks he was Ouranos; and to the Germans and Anglo-Saxons, the eye of Woden.

The ground-plan of some well-known Hindú temples in India is that of the Greek cross. The lightning, another of the attributes of Thor, the thunderer, from its zigzag course, may not unnaturally have been likened to a serpent. A Hermes, or torso, in the Museum at Arles, and labelled "A Statue of Mithra," shows that the serpent had its place in the celestial mythology of the ancients. This figure is entwined in the folds of a huge serpent, and between these are sculptured the signs of the zodiac.

During the Bronze Age, which, as regards Scandinavia, Dr. Worsaae fixes at from about 500 B.C. to 100 A.D., the form of the *svastika* received several modifications: amongst others, it

became what he styled the single , or the double 

thus, and also the three-armed figure , or triskele. In

another place he says (*ibid.*): "Curiously enough, in the new Runic alphabet which was adopted at this time (later Iron Age or Viking period), the letter S, which recalls one of the old sun symbols, was called Sol or Sun."

The connection of the triskele with the serpent may possibly seem to some far-fetched, but a tolerably certain proof that it is not so is shown in a bronze brooch found, a few years ago, when excavating the Roman camp on the Saalberg, near Frankfurt-on-the-Maine. This ornament is now in the local Museum of Homburg-v.-d.-Hohe. Inclosed in a ring of bronze is a triskele; each arm has a distinct serpent's head; they all turn the same way, as, it may be observed, do the arms of the *svastika* (or *Crux Gammata*). The connection of this symbol with the serpent survived even down to the so called "cinque-cento" period. It survived in Christian times—under the name of the *fyfot*—even down to the fourteenth or fifteenth centuries, and is alluded to by Sir J. Gardner Wilkinson ("Dalmatia and Montenegro," vol. i. p. 23). He speaks of finding

this emblem, in the form of two snakes  entwined,

"as a device upon some tombs in those provinces"; and adds:—"This symbol was used in early Christian times in England and other countries, among ornamental devices, in manuscripts, on tombs, and on church ornaments and vestments, from about 1011 to 1400 A.D., after which it is not met with in England. It is very common on monumental crosses of the fourteenth century, and was a favourite ornament of the Greek Church, whence it probably came into England and Western Europe: it is known in heraldry as the *fyfot*."

In the treasury of the Cathedral at Valencia, in Spain, there are two richly embroidered altar frontals, which (as stated by the officials in charge) formerly belonged to the church of old St. Paul's, in London, having been sold into Spain by our King Henry VIII. The needlework is a triumph of art. On each of these frontals is represented a portion of the old church. On one of them—which depicts our Blessed Lord going to crucifixion—a soldier of the Roman army, or of one of their allies, is represented holding a pennant on which is a *svastika* of the *fyfot* type.

In this brief sketch I have endeavoured to show the relations between sun- and fire-worship, both of which may have existed contemporaneously amongst primitive peoples, since light and warmth were naturally highly prized by them.

The Greek cross, or cross of Savoy  (the centre of

the ring-cross of the later Stone Age), appears to be the earliest known form of that symbol. A form of *svastika* of the Bronze Age—the triskele—may still be traced in the trincaria of the arms of Sicily and the Manx-man of our isles.

Did space permit, much more could be said regarding the *svastika* as a pre-Christian and a Christian cross.

Great Brampton, Hereford

HARRIET G. M. MURRAY-AYNSLEY

Important Points in the History of Earthquake Investigation in Japan

As the various instruments for recording earthquakes which have been invented in Japan appear destined to play an important part in future seismometrical investigations, and as the authorship of many of these instruments has recently formed the subject of a discussion, in which, although my name has been freely used, my distance from Europe practically prevents me from taking part, and which, so far as I can see, can only result in confusing those who are unacquainted with the work done in Japan, I venture to give the following notes as an outline of the more important points in the history of seismometry in this country.

In 1872, Dr. Verbeck, of Tokio, obtained approximate measurements of the range and direction of earthquake motion by means of an instrument consisting of a heavy slab resting on balls, the slab being the steady-point (*Trans. Seis. Soc. vol. i. p. 23*). The resemblance of this instrument to the lighthouse tables the invention of the late Mr. Stevenson is apparent.

In 1879, results which were probably more accurate than those of Dr. Verbeck were published in the *Transactions of the Seismological Society* (vol. i. p. 91), and the residents in Japan were astonished to learn that the amplitude of what were apparently severe earthquakes were to be measured in millimetres and fractions of millimetres rather than in inches. The results were obtained partly by Dr. Wagener and partly by myself. I worked with pendulums writing their records by what I still find to be the most delicate kind of pointers upon the surface of smoked glass. Dr. Wagener used a pendulum which was practically "dead-beat," and a pointer which gave a multiplied representation of the earth's movement. This was the first time that the necessity of multiplying-levers was recognised.

Shortly after this I published examples of diagrams of earthquake motion obtained by allowing smoked glass plates, at the time of a disturbance, to move for a period of three or four seconds beneath the pointers of a pendulum. The diagrams were short, but the results obtained respecting period, amplitude, and quantities calculable from these data, have not been shown by subsequent investigations to have been unsatisfactory (*Trans. Seis. Soc. vol. i. p. 91, &c.*).

About this time Prof. Chaplin and Mr. T. Gray independently constructed bracket seismographs (*Trans. Seis. Soc. vol. i. p. 25*). Mr. Gray's bracket seismographs were never specially described, but they still exist in the Imperial College of Engineering. Mr. Gray's next invention was a torsion pendulum seismograph, which, being suspended from horizontal levers which in turn were held up by horizontally placed springs, also recorded vertical motion. A curious feature in this instrument was that the horizontal levers were so supported that for slight displacements they had a constant leverage. In the same paper describing this instrument, Mr. Gray emphasises the importance of having seismographs so constructed that the steady-point should be in neutral equilibrium (*Trans. Seis. Soc. vol. i. p. 48*).

The next advance was made by Prof. Ewing, who, by using a bracket seismograph with a pivoted weight and a multiplying-lever writing on a continuously moving plate, obtained diagrams which inasmuch as they extended over a considerable portion of time were superior to all that had preceded them.

This instrument was described in Europe and Japan without the briefest mention of the fact that bracket seismographs, multiplying-levers, smoked glass plates, continuous records, &c., had a previous existence. Two of such publications are before me (*Trans. Asiatic Soc. of Japan, vol. ix. p. 40*, and *Trans. Seis. Soc. vol. ii. p. 45*).

At the time this excited no public comment, and it was not until Prof. Ewing distinctly claimed at least a joint authorship, not only of all bracket seismographs, but of all instruments which might involve the same principle, like the various forms of rolling spheres, rolling cylinders, conical pendulums, double brackets, &c., the inventions of Mr. Gray, that discussions arose. For one of these discussions see *Trans. Seis. Soc. vol. iii. p. 9*.

Although Mr. Gray distinctly stated that he had experimented with bracket seismographs prior to the one introduced by Prof. Ewing (*Trans. Seis. Soc. vol. iii. p. 5*), and although I personally acquainted Prof. Ewing with this fact, so far as I am aware Prof. Ewing has never in any manner whatever referred to this. Mr. Gray's seismograph for registering vertical motion, which in its principle was a new departure in seismometric methods, was constructed and described in April 1881 (*Trans. Seis. Soc. vol. iii. p. 137*).

At the following meeting of the Seismological Society, Prof. Ewing described an instrument of a similar nature, and only differing from the one described by Mr. Gray in the details of an arrangement for compensating the variable leverage, an arrangement practically adopted by Mr. Gray in the above-mentioned torsion pendulum. This seismograph is now distinctly claimed by Prof. Ewing as his own (*NATURE*, December 23, 1886, p. 172).

In June 1881, Mr. Gray suggested several methods by which a pendulum might be rendered astatic (*Trans. Seis. Soc.* vol. iii. p. 145). This was followed by Prof. Ewing's device to obtain the same result by an arrangement which was closely foreshadowed by Dr. Wagener, who *endeavoured* to compensate the movement of a pendulum by a heavy-headed recording index (*Trans. Seis. Soc.* vol. i. pp. 66 and 67).

In addition to the seismographs here referred to, there are many others that might be mentioned. Amongst them we find the parallel-motion instrument of Mr. West, which was immediately followed by parallel-motion instruments the invention of Prof. Ewing and Prof. Alexander (*Trans. Seis. Soc.* vol. iv. pp. 22 and 30).

The development of the parallel-motion instruments may be taken as illustrative of what has happened with regard to nearly all the other seismographs, which in great measure have been gradually developed from something which preceded them.

By improving the bracket seismograph, Prof. Ewing made a considerable advance in seismometry, for which the workers in this country undoubtedly accord him their hearty thanks; but while describing a beautifully constructed, but at the same time inconvenient and obsolete arrangement of seismographs (*NATURE*, vol. xxx. pp. 149 and 175, and vol. xxxiv. p. 343), it is hardly fair that his fellow-workers, especially Mr. Gray, the most prolific of earthquake inventors, should be passed by unnoticed, and have their work practically appropriated.

Tokio, February 10

JOHN MILNE

Supposed Suicide of the Cobra

THE following observations may be of interest as bearing on the reputed suicide of snakes.

Yesterday, while riding over a bare sandy plain I caught sight of a large black cobra moving leisurely along. Having no other weapon with me but a .450 express rifle, I halted my camel and fired, at about 50 yards, just as it was disappearing down a rat-hole. The bullet passed through the middle of its body without severing the spine; the head was immediately withdrawn from the hole, and the snake began to writhe in agony, rearing its head, spreading its hood, and striking wildly in all directions. I was about to put it out of its agony by a second shot when it struck close to its own tail, and my orderly cried out that now it had bitten itself and would soon die.

Though I had clearly seen that it did not bite itself, I thought this a good opportunity of seeing whether there was any truth in the popular superstition, and if not whether I could obtain any light on the mode of its origin. The following is the result.

The snake repeatedly reared its head, and after holding it reared, struck wildly at some piece of grass or stick; twice again it struck at its own tail, and on each occasion the natives with me declared it had bitten itself. This, however, I can assert, it did not: on one occasion it stopped just short of the skin; on the other, being apparently unable to check itself, it swerved slightly and struck the ground close alongside. It appeared to me that the snake in its agony struck wildly at the first thing that caught its eye and irritated it; in three cases this was its own tail, but as soon as it realised what it was doing—so far from there being a deliberate attempt at suicide—it did all in its power to prevent a fatal result.

It is conceivable that, under similar circumstances, owing to loss of control over its own actions a snake might actually bite itself, and there would be what might pass for a well-authenticated case of suicide; but such a case, did it ever occur, would probably be due to an accident and not to deliberate intention. I have no doubt, however, that the popular superstition finds its support in cases like that described; for the natives with me, if questioned, would reply that the snake had certainly bitten itself three times, the other apparently aimless strikes at sticks or grass having escaped their notice.

A similar explanation of the reputed suicide of scorpions was given in *NATURE* some time ago, but not having the file with me I cannot give the reference.

R. D. OLDHAM

Camp near Pokran, in the Indian Desert, March 4

THE RETIREMENT OF DR. TYNDALL

WE have had on more than one occasion during the last six months to refer with regret to Dr. Tyndall's impaired health brought about by overstrain. Our readers will have gathered from the daily papers during the present week that although much recruited by rest, Dr. Tyndall has yet sent in to the managers of the Royal Institution his resignation of the Chair of Natural Philosophy, which he has held since 1853, and that the resignation has been accepted.

The managers and members, cordially appreciating Prof. Tyndall's services, and being anxious to mark their sense of the benefits he has conferred on the Institution during his long connexion with it, have done what was still open to them in the way of honourable recognition and regard. He has been nominated for election as Honorary Professor, a title previously borne by Sir Humphry Davy and Prof. Brande; and one of the annual courses of lectures will be called "the Tyndall Lectures." He has also been requested to sit for his bust, to be placed in the Institution, in memory of his relations with it.

At the monthly meeting held last week the following letter was read:—

Hind Head, April 3, 1887

DEAR SIR FREDERICK BRAMWELL,—I have halted in my reply to your letter of March 23, through sheer inability to express the feeling which the action of the managers, at their meeting on the 21st, has called into life.

And my reply must now be brief, for I hardly dare trust myself to dwell upon the "resolutions" which you have conveyed to me. Taken in connexion with the severance of my life from the Royal Institution, and with the flood of memories liberated by the occasion, this plenteous kindness, this bounty of friendship, this reward so much in excess of my merits, well-nigh unmans me.

And, let me add, the noble fullness of style and expression, which I owe to yourself, and in which the good will of the managers takes corporate form, is in perfect harmony with the spirit which it enshrines.

Of the managers existent when I joined the Institution, one only remains upon the present Board. The beneficent work of many of them is for ever ended; but I do not forget the sympathy and support which they extended to me during their lives. And now the long line of kindnesses culminates in words and deeds so considerate and appreciative—so representative of their origin in true gentlemanhood and warmth of heart—that they have almost succeeded in converting into happiness the sadness of my farewell.

With heartfelt prayers for the long-continued honour and prosperity of the Institution which I have served so long, and loved so well, believe me, dear Sir Frederick, most faithfully yours,

JOHN TYNDALL

However much it may be regretted that Prof. Tyndall has felt himself compelled to withdraw from the onerous duties of a particular office, we may hope that, so far from this being a withdrawal from science itself, further leisure and rest may soon be followed by the old vigour, and that a fresh series of services may reward the labours of future years; for the work in which Profs. Huxley and Tyndall have been the best known among the pioneers is not yet half accomplished.

On this subject the *Times* writes as follows:—

"Dr. Tyndall's name, in conjunction with that of Mr. Huxley, stands for a symbol of the nationalisation of natural science as an educational instrument. Sir Humphry Davy and Michael Faraday, in the same position, flashed the light of science into minds already prepared by leisure and cultivation to receive it. Dr. Tyndall's professorship in Albemarle Street has synchronised, and by no casual coincidence, with the recognition of the claims of the masses to be scientifically instructed. Contracted as Sir John Lubbock complains the domain of natural

science is still among educational appliances in general, it is extraordinarily large in proportion to the place permitted it when Dr. Tyndall commenced his courses a third of a century back. Scientific truth was valued and sought by the few then as now. They themselves scarcely regarded it as a subject which concerned the rest of the community. At large the most extraordinary obtuseness prevailed. The feeble attempts to impart a little superficial information in schools and lecture-halls rendered the darkness more visible. From the Royal Institution, as from the several centres occupied at various times by Mr. Huxley, poured a continuous expostulation against popular ignorance of the very bases of physical existence. The force of the appeals lay in their tone of moral anger at an apathy represented as a degrading baseness. Their special virtue was the determination, which never flagged, to abandon nothing of the exactness of science in popularising it. Prof. Tyndall, like his constant fellow-worker, has never for an instant looked upon the masses as entitled only to second-rate knowledge. They have had it of the highest and purest which it was within his means to supply. He has admitted no distinction between esoteric and exoteric teaching. He has not put off an audience even of children with the modern equivalents for the worsted orreries and Prince Rupert's drops of elementary philosophy fifty years ago. In his hands science for the most rudimentary educational purposes has been treated as reverentially as for the most transcendental. It has walked with head as erect in the Royal Institution theatre during the Christmas holidays as at a session of the Royal Society or the British Association. The result has been that, if the country has not learnt all it might and ought, it has learnt little which it will have to unlearn. It has not been condemned to drink either scientific dregs or scientific scum."

We regard the appearance of the article from which the above quotation has been taken as one of the results of the increased appreciation of science which has followed from the crusade in which Prof. Tyndall has played so important a part, and we confess it is not without misgivings that we contemplate a future, which we trust may be a distant one, in which Prof. Tyndall's unswerving advocacy of research for its own sake, and the example of his devotion to science, unswayed by considerations of filthy lucre, are no more among us.

We believe that all the arrangements at the Institution consequent upon Prof. Tyndall's retirement are not yet completed, but we learn that Lord Rayleigh has all but agreed to take some part, at all events, of the duties of the Chair.

This will be good news to all true friends of science. The Institution has a long and noble reputation to keep or to lose. In Lord Rayleigh's hands we know it will be safe.

PRIMROSES

THE very word awakens the pleasantest memories that remain to us from the time when we almost lived in the open air and enjoyed the intense delight of plucking wild flowers without let or hindrance; a pure and unalloyed delight actually experienced only in childhood, though it lives ever green in our hearts, and leavens the more serious pleasures of riper years. The primrose of primroses for all Britons is the wild yellow primrose that adorns woods, hedgerows, and banks from Cornwall and Sussex to the Shetlands, Orkneys, and Hebrides; for none is more lovely, though many among the endless variety spread over the north temperate and cold regions excel it in warmth and brilliancy of colouring. It is now about a year since botanists and gardeners met at South Kensington, whither they had brought their collec-

tions of living plants, comprising a large number of species and varieties of *Primula*, solely for the purpose of seeing and talking about primroses, polyantheses, and auriculas; and the vast amount of information contained in the report of the proceedings of those assembled merits the attention of all naturalists, to say nothing of those who love flowers merely for the pleasure they afford the eye. Being hardy, primroses were among the first plants cultivated in this country when ornamental flower-gardening began, little more than three centuries ago. The old masters—Turner, Gerard, and Parkinson—introduce us to them, the first including in his "Libellus" only the *primrose*; but at that date (1538) there seems to have been no such thing in England as the cultivation of flowers for their beauty alone. Gerard's first catalogue of plants cultivated in his garden at Holborn, and published in 1596, contains "primroses, birds eies, paigles, cowslips, and beares eares": respectively *Primula vulgaris*, *P. farinosa*, *P. veris*, and *P. auricula*; and this is the earliest English catalogue of professedly cultivated flowers. Parkinson describes in his "Paradisus" (1629) twenty-one sorts of "beares eares" or auriculas, and he mentions that the varieties cultivated were much more numerous than he intended describing. In the report alluded to, Shirley Hibberd states that in the year 1570 many artisans, driven from the Netherlands, settled in this country, bringing with them their favourite flowers, including the best of their auriculas. Thus it would appear that the auricula was one of the very earliest "florists' flowers" cultivated in this country; and it is hardly necessary to say that it is one of the chief favourites of the present day. One of the questions discussed at the Conference was the parentage of the true auriculas and the Alpine auriculas, a question upon which florists and botanists did not quite agree; and the only way of obtaining a solution of the problem is by experiment. It is nearly certain, however, that more than one species has been concerned in the production of the various cultivated races. On the one side it has been argued that the presence of true blue is almost absolute proof that they cannot all have descended from a species having yellow flowers; and it is true that both wild and cultivated plants which exhibit great variety in the colour of their flowers rarely offer both pure blue and pure red. The china-aster (*Callistephus chinensis*) is an exception, but whether both colours exist in the wild plant I cannot ascertain. Philip Miller, who was the first to cultivate it in this country, states that he received seeds from France of the red and white varieties in 1731 and of a blue in 1736. Amongst our native plants a very large number of those having normally blue or red flowers frequently produce white varieties; and I have myself picked red as well as white varieties of the bluebell (*Scilla nutans*), though it is true the red was not a very pure one. On the other hand, normally yellow flowers rarely sport into other colours.

To return to the primroses: the introduction in 1820 of the Chinese primrose added a permanently popular greenhouse flower, which is now raised by hundreds of thousands, indeed one might say millions, annually; and almost every florist of note has his special "strains" or varieties, varying in colour from pure white to crimson, and equally in the size and cutting of the leaves and flowers, which are either double or single. The double-flowered varieties are relatively difficult to cultivate, as they are propagated by offsets, and are less vigorous in constitution. Like the china-aster, this was unknown in a wild state until recently, when the Abbé David discovered it in the province of Hupeh.

Persons familiar only with the species of *Primula* hitherto mentioned can form no idea of the amount of variation exhibited by the whole genus, which embraces at least 110 distinct species, widely spread in the temperate and cold regions of the northern hemisphere, rare in

warmer countries; and one is found in the extreme south of America. But some further particulars of their distribution may be interesting. The forms in Europe are numerous, and the number of species to which they may be referred varies from twenty to nearly forty, according to the views of different botanists. They are most numerous in the Alps, where they constitute one of the most charming features of the vegetation. In Asia, too, the genus is generally diffused, though by far the greatest concentration of species is in the mountains of Northern India, where upwards of fifty species occur, some of them ascending almost to the altitudinal limits of flowering plants. Quite recently Mr. Franchet has described a dozen new species from Eastern Tibet and the Chinese province of Yunnan; and Eastern China and Japan possess their peculiar species; one at least of the latter (*P. japonica*) being now common in English gardens. An isolated species, the gigantic *Primula imperialis*, inhabits the mountains of Java, and the genus is represented in South-Western Asia, in Arabia, even to the neighbourhood of Aden, by *P. verticillata*, the same species recurring in Abyssinia; yet none apparently is found in the mountains of Morocco. In America the distribution of the genus is peculiar, no species having been found in Eastern North America south of Canada, while in the western and central regions three or four endemic species inhabit New Mexico, Arizona, and California, though in the last-named country the genus does not extend south of the Yosemite Valley, where the charming *Primula suffrutescens* is at home. The latest discovery is a new species in the Santa Rita Mountains, near the Mexican boundary. Altogether, nine species are now known from North America, five of which, those in the Arctic regions, are also natives either of Europe or Asia, or both. But the most remarkable fact in the distribution of the genus *Primula* is the presence of a species in the extreme south of South America—a species so closely allied to the northern *P. farinosa*, which is common to Europe, Asia, and North America, that it has been alternately held as a variety of it and an independent species. When writing his "Flora Antarctica," Sir Joseph Hooker could find no character whereby to distinguish the South American primrose as an independent species; but in his recent "Flora of British India" he states that it differs in having large granulate seeds. On the other hand, Dr. Asa Gray ("Synoptical Flora of North America") treats it as the same as *P. farinosa*; yet it is probable that he did not examine the South American plant, although he includes South America in the range of *P. farinosa*, therefore it can hardly be cited as an expression of opinion on the subject. The plant is common in Fuegia and the Falkland Islands. Even admitting that it is sufficiently distinct to be admitted as a species, the genetic connection with *P. farinosa* is so close that as a phenomenon in distribution the question is immaterial. The southern limit of *P. farinosa* in North America, so far as known, is Colorado; therefore there is a break of nearly 90° of latitude.

The greatest diversity is exhibited by the Asiatic species, alike in stature, foliage, and floral structure. In a comparatively restricted region of the Himalayas grow the moss-like species, scarcely an inch high, including the flower, such as *P. minutissima*, and the tall *P. sikkimensis*, with an umbel of twenty to thirty delicate yellow flowers on a scape 2 to 3 feet high. Between these extremes there are all sizes and several distinct types of foliage. The Javan species alluded to above is perhaps the largest of the genus, having whorl above whorl of golden flowers, though it is closely approached by the beautiful and many-coloured *P. japonica*.

The recent novelties from Tibet and Western China include some of the most distinct and peculiar forms of the genus, but none of them is in cultivation.

There are many other interesting things connected with primroses, but I have perhaps already covered too much space. I may add, however, that by far the richest collection of living species was contributed to the show by the Royal Gardens, Kew—a collection largely brought together by Mr. G. C. Churchill, part author of the well-known book on the Dolomite Mountains, and cultivated by Mr. Dewar. It contained about fifty species, besides many hybrids and seminal varieties.

The report from which some of the foregoing particulars were extracted forms a part of the seventh volume of the Journal of the Royal Horticultural Society.

W. BOTTING HEMSLEY

ON THE ESTABLISHMENT OF THE ROMAN DOMINION IN SOUTH-EAST BRITAIN

BEFORE entering upon the matter which I have stated as the subject of this paper, I think it will be well to premise three notes: (1) on the general authority for the accuracy of the history; (2) on the geography of the approaching coasts of Gaul and Britain; (3) on the pronunciation of names delivered to us in the spelling of the Greek language.

(1) The account of the invasions which I adopt is that of Dion Cassius. His history, in general, is orderly and full. He appears to have been a man of rank, and doubtless had command of State documents. He seems to have been well acquainted with every movement in the Courts of several successive Emperors. He has carefully explained why he was unable to continue his Roman history beyond the time of Severus with due accuracy. The time of the invasion of Britain was about 170 years before the composition of his history—an interval almost equal to the length of our Hanoverian dynasty; and his account of the wars in Britain may claim to be considered as trustworthy as our histories of the campaigns of Marlborough.

(2) In regard to the geography, it is to be observed that the coast-tract in the north of France, apparently from the mouth of the Seine to the mouth of the Scheldt, is called *Γαλατία* (Galatia). This name occurs at least twice, in separate books of Dion. By Ptolemy it is called *Κελτογαλατία Βελγική*.

(3) The English writers who have given any attention to this history have had, I believe, no knowledge of the pronunciation of the Greek words. Mitford, however, in his "History of Greece," had pointed out some of its peculiarities. The difficulty is now greatly removed by the publication, at Boston, U.S., of the "Grammar of Modern Greek," by E. A. Sophocles. I extract the substance of his notes which apply best to the present purpose:—

β is the English *v*, or sometimes *bh*.

δ is the English *hard th*, as in *that*, *those*.

θ is the English *soft th*, as in *thin*, *thorn*.

$\mu\pi$ is the English *b*.

$\nu\delta$ or $\nu\tau$ is the English *d*.

ι is the English *ee*, as in *seen*.

ov is the English *oo*, as in *soon*.

There is no reason to think that the pronunciation has changed for many centuries. In the Byzantine Greek histories of the Crusades, there are many opportunities of making comparisons of the Greek and the Latin names of places and persons, which appear to follow the same rules as at the present time.

Thus, the name given by Dion to the lady who commanded the Britons in their grand movement against the Romans is spelt by him *Βουρδοίκαια*. Interpreted by the list of equivalents just given, it becomes in English letters and sounds, Voo-doo-ee-ka; and this I believe to be the true rendering of the name. Still, I dare not depart from the established custom; and I shall therefore (unwillingly) adhere to the long-used English spelling, "Boadicea."

I now enter upon the national history.

In the reign of the Emperor Claudius (there is no farther indication of time) Kunobellin reigned at Camalodunum (undoubtedly the modern or Saxon Colchester, "the fortress on the River Colne": the Latinised original name is literally "Camal-hill" or "Camal-fort" (a name somewhat similar to this occurs in Arthurian legends). Kunobellin is mentioned by others as King of the Trinobantes. Dion remarks, "they (the people) were not self-governors, but lived under kings."

Vericus (Βέρικος), a political exile from Camal-dun, persuaded the Emperor Claudius to give him military assistance (apparently for restoration); and the Roman general Aulus Plautius was sent from Galatia, and (after a ridiculous mutiny of the soldiers) landed in England. Remarking that he had no motive for entering Kent, and that his object was to reach Camal-dun as soon as possible, I think it likely that he rounded the North Foreland, and debarked at Southend on the west side of Shoeburyness; where there is an excellent beach two or three miles long, sheltered from the open sea, for landing; and a good plain, for temporary encampment.

Without detailing all the affairs of Plautius with Kunobellin and Kunobellin's two independent sons, Kataraktos and Togodumnos, I shall only say that, after a very unsuccessful struggle with the Britons, apparently among the woods and marshes of the Crouch (a complicated river), Plautius retreated, in veritable flight, towards the west. He had, however, made peaceable terms with the Vothuni (a tribe not otherwise known, I believe); and, leaving a guard there, proceeded till he came to a river, deep but fordable, which he passed with some difficulty. This river, I have no doubt, was the Lea, the largest of the Essex rivers, and running in a valley which is in some parts marshy. In crossing this river, he was greatly assisted by the Κέλτοι, who were accustomed to cross rivers in their armour. (It seems not improbable that these Κέλτοι had been levied in the eastern parts of Galatia and the regions of the Scheldt.) The Roman army, by this real flight, reached the tract opposite London. We have now to consider the state of land and water before them.

So far as we can judge, there had never been any power in the country which could have embanked any of the marshes as we see them now. The sea-water, scarcely salt (much fresh water having entered from the Thames and the smaller rivers) ran up with an insignificant tide, above Rotherhithe and to the borders of Southwark, in a great arm of the sea, never less than two miles wide. This gulf is called by Dion Ὠκείανος. It was shallow, in some places actually bearing trees. (See Mr. Spurrell's "Early Sites and Embankments on the Margin of the Thames Estuary," *Archæological Journal*, vol. xlii.) To the point opposite London applies the sentence of Dion, "ἐπὶ τὸν Τάμεσσαν ποταμὸν, καθ' ὃ εἰς τε τὸν Ὠκείανον ἐκβάλλει." And this was Dion's mouth of the Thames, and here was the head of the gulf. There was a bridge at a small distance, which I conceive to have been near the site of William the Conqueror's bridge or modern London Bridge. It is remarkable that there is no mention of a town; but probably Southend was the real port of Britain, and the march of the Romans was on the harbour-road.

The sea-water, after the long passage up the shallow gulf, had almost lost its tidal character, and become a mere lake. The Kelts of the army forded the water, and the Romans crossed at the bridge. And now the army, much shattered, was in Kent or Surrey. The Emperor Claudius, on hearing the state of affairs, sailed in person with troops to Marseilles, crossed France to the north coast, and landed in Britain to join Plautius. There can be no doubt that he landed at one of the southern ports of Kent, as Winchelsea or Rye (the whole of Kent being evidently held in perfect quiet); and the question arises, Where was Plautius waiting? and where did Claudius join him?

It is possible that Plautius may have waited in the neighbourhood of London Bridge; but I offer a conjecture which I think more probable. In the grounds of Holwood (near Farnborough) at the eastern corner of Hayes Common, at an easy day's march from London, and in the direct line from London to the south-eastern parts, are the extensive remains of the earthworks of a large fort, in the best style of Roman permanent encampments. In its straight lines of outline (where circumstances permit), its rounded angles, its lofty inner rampart and its lower second rampart, it admits of comparison with the most complete of those which Agricola established in his marches through the Scotch Highlands, and which are described in General Roy's "Military Antiquities." It is called, in the neighbourhood, Cæsar's Camp. The little river Ravensbourne (which ultimately joins the Thames at Deptford Creek) rises in a strong spring close to the entrance. I think it probable that Plautius wintered here, and was joined here by Claudius.

The united armies marched at once for Camal-dun, and captured it. And it would seem probable that they immediately gave it its present form, and a fairer or nobler provincial and military capital (as adapted to ancient warfare) within my knowledge nowhere exists. It is planted on a steep parallelogrammic hill. The slope of the ground at the east gate was eased, within my recollection, in the year 1816. On the south side, a little less steep than the other sides, the ground has been heavily scarped, and faced with a stone wall. The whole town is surrounded by a stone wall at the brow of the slope, rounded at the angles; the little river Colne is on the north side, and there the wall is lower in the valley. The dells on the south and west sides converge to an angle, near which is placed the principal gate of the town. The great streets are in the true Roman form of capital T, and all the small streets are at right angles. The citadel, I suppose, was in the space on the north side of High Street, in which the castle (a Norman building) now stands.

It would appear that the Romans, as residing in a country which was likely to be troublesome, took early steps for making a great road across it; and then was made the great western road by Marks Tey, Coggeshall, Braintree, Dunmow, to Stortford, on the River Stort (which is the largest affluent of the Lea); and then was formed the large entrenched camp of Wallbury, about two miles south of Stortford, on the Essex side of the river.

And after this was made the road to London. The reason for my placing its date subsequent to that of the western road is singular, but certain. The road to London does not start independently from Colchester: the western road is used as far as Marks Tey, and there the London road branches off at an angle of about 40° (roughly estimated). I have personally surveyed this, taking views from the neighbouring grounds, and can assert that the road from Colchester to Coggeshall passes straight through Marks Tey, totally unaffected by the London road. The same thing is exhibited clearly on our Ordnance map.¹

All appeared to be peaceably established. And now came the terrible outbreak.

Dion suddenly states that two cities were destroyed (their names or positions are not mentioned), and 80,000 of the Romans and their allies killed, and that this was done by a woman, to the great shame of the Romans; that this was foretold by divine inspiration (τὸ θεῖον); that there came from the Senate-house (βουλευτήριον), at night, barbarous noises, with laughter; from the theatre came a sound of tumult with lamentation, when nobody was near; some houses were seen under water in the Thames; the ocean between Britain and Galatia was disturbed, and had a bloody colour. The cause of the war was the exaction, by Claudius, of money raised by confiscation (δήμεναι), which Claudius gave to the principal men of the Britons

¹ The modern name Marks Tey is an error for Marks Tye, Tye being the customary word in Essex and Suffolk for a bifurcation of roads.

(if I have correctly translated the passage); and Decianus Kalus (the Superintendent of the island) asserted that these sums were to be treated as contributions (*ἀναπόμισμα*) to be sent to Rome. To this was added that Seneca—who was not only philosopher, poet, and Minister of State, but also the greatest usurer in Rome—having lent (*δανείσας*) ten millions (*χιλιάδας μυριάδας*; which if in sestertii would amount to about 80,000!) *ἀκουσεν* (I do not understand this word) on sound hopes of interest, suddenly, and with violence, exacted the return of the whole; that it was Boadicea (*Βοο-δοο-εε-κα*) who principally caused the rising of the Britons. In the usual history of this lady there is much to be corrected. She was *not* Queen of the Iceni, though of the royal family (*γένους τοῦ Βασιλέως*). She had *no* husband or children. There is not the slightest allusion to *any* personal insult. She did *not* die in battle, but died from disease (*νόσῳ*) after the battle.

Boadicea, as Dion remarks, was greater than woman. She collected the army of about 120,000 men. She mounted a *βήμα*, made in the Roman fashion, to raise her from the mud. She was tall in person, very awful in countenance, with keen eyes and a rough voice; her abundance of yellow hair fell far down her body; she had chain-armour of gold, a variegated vest, and a thick cloak.

A very long speech is given, of which the following are the principal heads:—The superiority of liberty to slavery; the criminal character of the taxes, some even levied from the dead; the Britons themselves are the cause of these evils, not having resisted them soon enough; the habits of our enemies expose them to far greater difficulties than those which we endure; and other remarks, finishing with a kind of enchantment over a hare.

The Britons proceeded to terrible and savage excesses, the worse because Plautius was absent, having gone to *Μόνα*; which, if it be the same as the *Μόνα* of Ptolemy, is the Isle of Anglesey. But this appears to me to be, etymologically, very doubtful; and, practically, I think it very improbable that, in such a state of affairs, Plautius would have gone, by a difficult march, to such a distance. Plautius however returned, and a battle soon took place.

There is no difficulty in fixing on the site of this, one of the great battles of history. In the neighbourhood of Linton, at the north boundary of Essex, in a space perhaps of two square miles, are places which still bear the names of Shudy Camps, Castle Camps, Camp's End, Camp's Green, Camp's Castle. Every one of these has undoubtedly been the scene of a desperate struggle. And, finally, there are the three mighty mounds, known as the Bartlow Tumps, which, as I understand, have been identified as containing Roman remains.

Dion has given a long account of the various phases of the battle. Boadicea died of illness (*νόσῳ*), and the Britons were driven off the field. The battle was sufficiently decisive to prevent the re-appearance of the Britons in force; but still it appears, I think, not to have made a complete conquest.

The news was welcomed at Rome with very great interest by the Emperor, the Senate, and every rank of society.

G. B. AIRY

THE EUROPEAN PREHISTORIC RACES

IT would be difficult to overrate the scientific value of the discovery of human remains made last summer in Belgium, and briefly noticed in *NATURE* of February 24 (p. 405). Hitherto serious doubts have prevailed regarding the true character of the Canstadt, Neanderthal, Eguisheim, Olmo, and four or five other skulls, which are collectively referred to the oldest known race in Europe, but which, owing to their apparently exaggerated simian features, have been looked on with suspicion by Pruner, Virchow, and others, as possibly exceptional or

even mere pathological specimens. But these doubts have at last been set at rest by the lucky find made last June by MM. Max Lohest and Marcel de Puydt, who, during their explorations of a cave on the slope of a wooded hill on the banks of the Orneau, in the commune of Spy, province of Namur, came upon numerous remains of two individuals amid hitherto undisturbed Lower Quaternary deposits, and in association with the bones of *Rhinoceros tichorinus*, *Elephas primigenius*, *Ursus spelæus*, *Hyæna spelæa*, *Felis spelæa*, the horse, wolf, sheep, and other now extinct and surviving Pleistocene animals. These remains have been carefully examined by M. Julien Fraipont, Professor of Animal Paleontology in the University of Liège, who unhesitatingly refers them to the Palæolithic race, to which King's expression "*Homo neanderthalensis*" may now be confidently applied. Taken especially in combination with the peculiarities of other parts of the skeleton, such as the evidently angular position of femur and tibia, implying a non-erect or stooping attitude in standing or walking, the skulls of the two Spy men show clearly that those of the Canstadt and Neanderthal men are in no way aberrant, but perfectly normal specimens. They obviously represent a Palæolithic and pre-Glacial race, the earliest of which there is any distinct record, which was already spread over West Central Europe in early Quaternary times, and which De Quatrefages and Dr. Hamy now believe may ultimately be traced back to the later Tertiary epoch.

A far better idea of the physical characteristics of the *Homo neanderthalensis* can be had from the remains of the Spy men, than from any others hitherto brought to light. Prof. Fraipont, who devotes a lengthy memoir to the subject in the *Bulletin* of the Royal Belgian Academy for December, gives detailed osteological descriptions of the two more or less perfect skeletons, from which it appears that of one there are extant: the skull, relatively very complete; the right portion of the upper jaw, with five molars; a fragment of the left portion, with the two premolars, incisor and canine; the under jaw, nearly complete, with sixteen intact teeth *in situ*; a left clavicle; the right humerus, less the upper epiphysis; the left humerus, less both epiphyses; the left radius; the right femur, nearly complete; the left femur, complete; the left tibia, complete; the right heel. Several of the parts here missing are supplied by the second skeleton; and there are also numerous vertebræ, fragments of ribs, &c., which cannot with certainty be referred to one rather than the other.

The first skull (No. 1) includes: the frontal bone from the superciliary arches and naso-frontal suture to the parieto-frontal suture; the right parietal, nearly complete; the upper half of the left parietal; the occipital, less a considerable portion of the region of the cerebellum. Of the second skull (No. 2) there remain: the frontal, very nearly complete; the right and left parietals, complete all but a few fragments of the former: the right temporal, nearly complete; the left temporal, complete; the occipital, less a portion of the region of the cerebellum.

The first is very long, very depressed from above, and narrow, being decidedly platidolichocephalic, with cephalic index 70, as compared with 72 of the Neanderthal skull, and 67.65 of the Clichy. The second is subplatidolichocephalic, with apparent index 74.80, and general characters less pronounced than those of No. 1, but not to such a degree as to prevent the two from being referred to the same race. Of both, the longest antero-posterior diameter is about the same, 200 and 198 to 200 mm. respectively, the former corresponding exactly with the Neanderthal. But the transverse differs considerably, being 140 and 150, between which comes the Neanderthal with 144 mm. On the other hand, the antero-posterior frontal curve of the first coincides exactly with that of the Neanderthal, the frontal itself being, like it, low and retreating. Another typical feature of this

al is the great development of the superciliary arches, which are slightly less prominent than those of the Neanderthal and Eguisheim. The distance between their extremities is no less than 122 mm., while the orbits converge at the very root of the nose, leaving a slightly depressed intervening glabellar region, this being differing perceptibly from that of the Neanderthal, in which the glabella is prominent.

Although otherwise well preserved, the under jaw of No. 1 unfortunately lacks the condyles, which would have enabled us to settle the important question of its relative gnathism. This jaw is very high and massive, and the well-preserved teeth of both present the general characters found amongst the New Caledonians and other modern races of low type. The canines and incisors of the under jaw are worn obliquely and outwardly, those of the upper jaw obliquely and inwardly, although in general to a less extent than amongst the Neolithic races. The right femur of No. 1 is not large, but very strongly developed, and is especially remarkable for its typical inward curvature. The great posterior development of the articular surface of its condyles, taken in connection with the general curvature of the body, shows that the men of Spy walked with the knees bent forward, the thigh being obliquely curved forward and downward, and the trunk reversed backwards. In other words, the femur was used obliquely to the tibia, which was itself strong, thick and heavy, but very short.

The discoveries at Spy are specially valuable because they are associated with other remains which enable us to determine approximately the epoch of analogous finds elsewhere. The already mentioned fauna, as well as the character of the coarse flints occurring in the same undisturbed strata, would seem to indicate that both the men of Spy, and their Canstadt and Neanderthal congeners, must have flourished in the *époque Moustérienne* of French writers, that is, during the early period of the mammoth, and long before the beginning of the Reindeer Age. They are consequently more recent than the race of the *époque Chelléenne*, which was contemporary with *Elephas antiquus*, but of which no actual remains, beyond the objects of its industry, have yet been discovered. That they belonged in any case to pre-Glacial times seems evident from the remarkable absence of the reindeer, which is not numerously met in West and Central Europe during the Ice period.

M. Fraipont's comparative study of these remains makes it thus abundantly evident that they belong to the Neanderthal type. The two skulls even serve as a sort of missing link between the Neanderthal and the others usually referred to the same race. This race, whose presence in Europe during the early Mammoth Age has now been clearly traced from Stængenæs in Scandinavia to Olmo in Italy, seems in a way to have been resuscitated by the fortunate discovery in the limestone cave on the banks of the Orneau. Their dry bones again assume flesh and blood, and science is enabled confidently to describe the men of Spy as a short, but far from "feeble" thick-set, robust, walking on their knees foremost, and with a figure somewhat analogous to that of the modern Lapps, who also still waddle and are nearly all more or less rickety-legged. Their broad shoulders supported a long, heavy, and depressed head (different therefore from that of the true Papuan, which is long, narrow, and high), with very prominent superciliary arches, enormous orbits, low and retreating brow, high and massive cheek-bones, receding chin. No modern race, however low in the scale of humanity, is collectively characterised by all these traits, so that it may be safely affirmed that the typical type of the men of the Mammoth Age has become practically extinct, either through further evolution of the type itself, or by extirpation, or more probably by fusion with the men of a higher physical standard.

It is noteworthy that the points which most separate

the men of Spy from the present inhabitants of the globe are precisely those which bring them into closer relation with the anthropoid apes in general, rather than with any particular species of anthropoids. These points, which may thus fairly be described as pithecoïd or simian, are chiefly: the prominent superciliary arches, normal in the young male gorilla and adult female orang; the extremely low retreating frontal, constant in the chimpanzee of both sexes and all ages; the almost chinless receding lower jaw, highly typical of gorilla and chimpanzee; lastly, the peculiar curvature of the femur, combined with its adjustment to the tibia, suggesting in the vertical position an attitude somewhat analogous to that of chimpanzee and gorilla. On the other hand, all the other features of cranium, trunk, and limbs are distinctly human, while the cranial capacity alone would suffice to justify the claim of *Homo neanderthalensis* to membership with the human rather than with the simian family. However great the distance separating him even from the lowest of modern races, far greater, undoubtedly, is the interval between him and the highest of the modern anthropoids. At the same time this interval becomes perceptibly diminished by Gaudry's discovery of *Dryopithecus fontanii*, an anthropoid ape of the middle Miocene epoch certainly less simian, or rather more human, than any of its present congeners. Its lower jaw is perceptibly less receding than that either of the gorilla, orang, or chimpanzee. The interval tends to be still further reduced when we remember that, although the *Homo neanderthalensis* is the earliest human type of which any bodily remains have hitherto been discovered, there is a still more primitive race revealed to us by the rude palæolithic implements frequently occurring in association with *Elephas antiquus*, and in later Tertiary deposits considerably older than the Lower Quaternary of the Spy cave. Whenever any characteristic remains of this primæval race come to light, a distinct approach will have been made towards a solution of the difficult questions connected with the genetic descent of mankind.

A. H. KEANE

AN EXAMINATION OF THE LEAVES OF *GYMNUMA SYLVESTRE*¹

GYMNUMA SYLVESTRE (R. Br.) is an asclepiadaceous plant growing in the Deccan peninsula, from Concan to Travancore; it is also met with in Assam, and on the Coromandel coast, and is distributed in the continent of Africa. It is a stout woody climber, with long slender branches.

The leaves are opposite, entire, from 1½ to 3 inches long, and from 1 to 2 inches broad, elliptic or obovate, acute or cuspidate, rarely cordate at the base, membranous, thinly pubescent on both sides, the upper surface of a darker green than the lower. *Gymnema sylvestre* is mentioned in the non-official list in the Pharmacopœia of India (1868), and in Dr. Dymock's "Materia Medica of Western India." The powdered root has for a long time been known among the Hindus as a remedy for snake-bites; in such cases it is applied locally to the part affected, and also taken internally in the form of a decoction. But the most curious circumstance connected with this plant was first noticed by Mr. Edgeworth, who discovered that by chewing some of the leaves it destroyed the power of the tongue to appreciate the taste of sugar; he found that powdered sugar, taken immediately after masticating some of the leaves, tasted like so much sand in his mouth, and this effect lasted for twenty-four hours. Dr. Dymock, reviewing this property, said he was unable entirely to confirm this statement; his experience was that sugar taken into the mouth after chewing the fresh plant had a saltish taste, but was still easily recognisable.

¹ A paper read at a meeting of the Nilgiri Natural History Society, Ootacamund, by David Hooper, F.C.S., March 7, 1887.

Some authentic leaves were procured by Mr. Lawson from Guindy Park, Madras, who placed them at my disposal for chemical examination. They had a bitterish astringent and slightly acid taste. After chewing one or two leaves it was proved undoubtedly that sugar had no taste immediately afterwards; the saltish taste experienced by others was due to an insufficiency of the leaf being used. Sugar in combination with other compounds in dietetic articles is plainly destroyed as to its taste after using these leaves. In ginger-bread, for instance, the pungency of the ginger is alone detected, the rest is tasteless meal; in a sweet orange the taste of the sugar is so suppressed and that of the citric acid consequently developed that in eating it resembles a lime in sourness. Among the several kinds of foods, drugs, and beverages which affect the palate *Gymnema* does not pretend to render them all tasteless; it does not affect pungent and saline things, astringents, and acids. It is limited to apparently two diverse substances, sweets and bitters. It has been noted that sugar taken after the leaf tastes like sand, so I have found that sulphate of quinine taken after a good dose of the leaf tastes like so much chalk. I am not going to propose its use in the administration of nauseous drugs, until the medical properties of the *Gymnema* have been more studied, otherwise the quantity of the vehicle taken may prove to counteract the effect of the medicines. The experience of several friends as well as my own is that the effect does not last for twenty-four hours as stated, but for only one or two hours; after that time the tongue resumes its appreciation of all that is sweet or bitter.

The powdered leaves were submitted to the action of various solvents, and by this means it was ascertained that the peculiar property of *Gymnema* leaves was dissolved out by alcohol, and, as it occurred in the aqueous extract of the residue, it was therefore soluble in water. As benzene and ether took from the leaves certain principles of the same appearance and weight, it was conceived that nothing would be gained by using both solvents; the preliminary extraction was therefore made with ether rectified from water and spirit. The ether extract consisted of chlorophyll and two resins separated by their solubility in alcohol. The resin insoluble in spirit formed the larger portion; it was soluble in chloroform, bisulphide of carbon, and benzene. It was elastic and tenacious, decomposed by warming with nitric acid, the product being precipitated with water; only partially saponified with caustic potash. Sulphuric acid dissolved it in the cold, giving a green solution. It seemed to consist principally of a neutral resin. The resin soluble in spirit was readily saponified with soda, and gave a permanent bluish-green colour with sulphuric acid; like the former resin, it was of an acrid nature, and left a tingling sensation in the throat.

The alcoholic solution of the leaves was almost entirely soluble in water; in fact, by treating the leaves separately by alcohol and water, 36.37 per cent. organic matter was extracted; by treating the drug with water alone 36 per cent. was removed. By direct experiment it was found that in the former extract 0.47 per cent. was an acrid resin similar to those found in the ether extract. The aqueous solution of the substances soluble in alcohol had a decidedly acid reaction; it gave no coloration with ferric chloride, showing absence of tannin. It was deepened in colour with alkalis, but gave a bulky precipitate with sulphuric, nitric, hydrochloric, and acetic acid. It reduced Fehling's solution on boiling, and gave a cloudiness with Nessler, a precipitate with lead acetate, but none with tannin or picric acid. The precipitate caused by sulphuric acid was collected on a filter and washed till it ceased to give a cloudiness with barium chloride. It yielded a greenish powder, insoluble in water, but soluble in alcohol, ether, benzene, and chloroform. With

potash, soda, and ammonia it afforded fine red solutions with orange-coloured froth, but they were both precipitated on the addition of the mineral acids. It dissolved in concentrated sulphuric and nitric acids with intense red colour, but in both mixtures it was destroyed and precipitated by water. It fused at about 60° C. into a blackish brittle mass. Heated in a test-tube it gave off fumes of creosote, but no crystals were obtained in a subliming apparatus. Gently ignited it burned with a bright flame, leaving no ash. It was thrown down as a bulky gray mass by acetate of lead; the lead salt decomposed by sulphuretted hydrogen in water left the substance in the reddish evaporated filtrate from the lead sulphide. The body just described has the characteristics of an organic acid related in some particulars to chrysophanic acid, but having some distinctly peculiar reactions, and possessing the anti-saccharine property ascribed to the leaves. I propose to call it *Gymnemic acid*.

Gymnemic acid forms more than 6 per cent. of the constituents of *Gymnema* leaves, in combination with a base which has not been isolated. Another organic acid was present in the lead acetate precipitate, which was identified as tartaric acid. The filtrate from the insoluble lead compounds was treated with sulphuretted hydrogen gas, and the clear liquor after evaporation was examined for sugar. Glucose was detected in some quantity by its immediate and abundant reduction of Fehling's solution; the sugar examined in a polariscope had a left-handed rotation.

Chloroform agitated with an alkaline solution of the leaf left a crystalline residue of a brownish colour; it had a bitter taste, and acted as a sialagogue. With the ordinary alkaloidal reagents it afforded coloured precipitates, but was a neutral principle. Its further examination together with that of *gymnemic acid* are reserved for further investigation.

The leaves after being exhausted with ether and then alcohol were treated with water. The gum was detected and estimated in the usual manner. A carbohydrate, optically inactive, and, after boiling with acid, reducing Fehling's solution, was found in this extract.

Diluted soda removed a brownish liquid which consisted of albuminous matters only partially soluble in alcoholic and acetic acid. These were not weighed but calculated by difference.

A solution of 1 per cent. hydrochloric acid was employed to remove the oxalate of calcium. A microscopical examination of the powdered leaves showed a fair sprinkling of the conglomerate crystals or raphides so well known to exist in rhubarb. The dilution of the acid menstruum rendered this process very tedious, so a stronger acid was used and the marc washed with it until ammonia produced no cloudiness. The collected liquors were allowed to deposit, the sediment was then collected on a filter, dried and weighed; then incinerated and weighed again. The calcium carbonate was calculated into oxalate, and the difference between this and the first weighing was reckoned as pararabin. No oxalic acid was found in a free state.

The ash of *Gymnema sylvestre* is very high, a fact in accordance with the amount of lime salts it contains. Gentle ignition of the air-dried leaves left as much as 11.65 per cent., and about one-half of this was calcium carbonate. One hundred parts contained—

15.41 soluble in water.

78.71 soluble in acid.

5.88 sand and siliceous residue.

The cellulose was estimated by steeping the leaves in sulphuric acid of specific gravity 1.50 for 30 hours, washing, drying, burning, and deducting the ash; this result did not differ materially from the weight of the totally exhausted powder treated with chlorine water.

The following is a tabulated analysis of the powdered sun-dried leaves :—

Ether extract (chlorophyll and resins) ...	5.51
Alcoholic extract (gymnemic acid, tartaric acid, glucose, neutral bitter principle, resin, &c.)	19.50
Aqueous extract (gum 1.45 per cent., glucose, carbohydrate, and extractive) ..	16.87
Alkaline extract, by difference (albuminous and colouring matters)	8.15
Acid solution { calcium oxalate	7.64
{ pararabin	2.74
Ash (balance of)	5.69
Cellulose	27.86
Moisture	6.04

100.00

NOTES

THE Conference called by the French Government to consider the means to be adopted for the construction of a photonic chart of the heavens, meets at Paris on Saturday next. We believe that the Astronomer-Royal and Mr. Common have been delegated to represent the Royal and the Astronomical Societies.

THE Rev. S. J. Perry and Dr. Copeland have accepted Dr. Michin's invitation to observe the total solar eclipse in August next at his residence near Moscow.

WE regret to announce the death of Dr. Daniel Rutherford Baldane, who was for some time President of the Royal College of Physicians of Edinburgh. In response to a request by that body he represented the College in the General Council of Medical Education and Registration in the United Kingdom. He died at his residence in Edinburgh on Tuesday last.

THE annual Conference of the National Union of Elementary Teachers, which has met this week at Portsmouth, has been remarkably successful. It has been attended by about 400 delegates from the different affiliated associations, and by a number of individual members. In his inaugural address, Mr. Girling, the President, made some sensible remarks on technical education in elementary schools. Handicrafts could not be taught in elementary schools, but he was decidedly of opinion that our system of primary education ought to be better adapted to fit children for work when they leave school. He testified to the enterprise and public spirit of the City Guilds, and their Secretary Sir Philip Magnus, who had started handicraft classes for elementary teachers in London. But he would ask them to cooperate in helping to make our educational system a more national one. Then the teachers would have most valuable aid in preparing the future working-men of the country on intellectual lines, and the technical training of children, now so well begun in our infant-schools through the medium of kindergarten, might be carried still further in the senior schools.

At a meeting on Tuesday, a resolution was unanimously passed in favour of the appointment of a Minister of Education. Mr. St. John, by whom this resolution was proposed, maintained that educational questions of the highest importance could be settled only by a Minister of much ability and wide experience, invested with large authority and bearing direct and responsible responsibility. Given such a Minister, with great energy and noble opportunities, they could justly look to him for the most successful efforts and noble issues.

THE fourth Bulletin of Miscellaneous Information, issued by the Royal Gardens, Kew, contains papers on Manilla hemp, cotton and banana fibre, and pine-apple fibre. Manilla hemp is one of the most important of cordage fibres, and the whole

supply comes from the Philippine Islands. Everything made from it can be easily converted into paper of excellent quality. A plant of Manilla hemp may be seen in the Palm House at Kew; and sets of exhibits in the Kew Museum, No. 2, include the raw fibre, cables, ropes, twine, fine muslin fabrics, "half-stuff," and paper of all kinds, the latter being made from old Manilla ropes. Manilla hemp plants have been introduced from Kew to Jamaica, and to other portions of the West Indies. In favourable situations they grow well, but not so readily as the ordinary bananas and plantains. As the fruit is valueless, they can only be grown for the sake of the fibre, and this alone does not appear to offer sufficient inducement to plant up large areas.

AN Exhibition of the products of the Philippine Archipelago is to be opened at Madrid on June 1. It is to be divided into eight sections, with corresponding sections in the Central Commission at Manilla. Amongst these the following are of specially scientific interest :—(1) For the study of the geography, meteorology, terrestrial magnetism, orography, hydrography, anthropology, geology, and mineralogy of the Philippines; (2) the botanical geography of the archipelago, its fauna and flora; (3) general education, public instruction, and the arts and sciences in the Philippines generally. Sub-commissions have been appointed in all the chief places in the archipelago to collect objects for exhibition and information, to be forwarded to the Central Commission, and thence to Madrid.

DURING the next three months a course of lectures on zoology will be delivered at the Zoological Gardens, Regent's Park, by Prof. Beddard. The lecturer will try to make the subject intelligible and attractive to young people, and as the cost will not exceed the bare price of admission to the Gardens, it may be hoped that the course will be largely attended. The arrangements have been made by the Association for the Extension of University Education.

A SMALL Industrial Exhibition was opened on Tuesday last at the Flora Gardens Board School, Hammersmith. Its object is to encourage home industries among the poor.

THE twelfth annual meeting of the members of the Sunday Society was held on Monday, April 4, at the Conduit Street Galleries, Mr. R. Carter in the chair. Mr. Mark H. Judge, Hon. Sec., read the annual report, which claimed for the past year that never before had there been so many or such decisive expressions of public opinion in favour of the Society's object.

A REMARKABLE illustration of the puzzling migratory habits of the herring has just been observed on the south-west coast of Norway, at the so-called Jæderen, between the towns of Stavanger and Egersund. This district used to be one of the richest herring-fishing grounds in Norway during the spring, but about twenty-five years ago the fish suddenly and completely disappeared from the coast. Last month enormous shoals once more came under shore, first "striking land" at the same spot as in former times. The quality of the herring is exactly the same as it was twenty-five years ago, and the shoals were accompanied by numerous "herring" whales.

THE first and second parts of a Catalogue of the remains of Siwalik Vertebrata contained in the Geological Department of the Indian Museum, Calcutta, have been sent to us. The work is compiled by Mr. Richard Lydekker, who says that the magnificent Siwalik collection in the Indian Museum is equalled only by that of the British Museum.

AN Exhibition of Seeds will take place at Trondhjem, from July 4 to 10, in connection with the eighth general Norwegian Agricultural Meeting. At the same time, lectures on the subject will be delivered to the meeting, and a Fisheries Exhibition will also be held.

DR. FRANZ BOAS, who visited the Indian tribes of British Columbia in the autumn of 1886, has presented in a preliminary Report some of the results of his journey. The large wooden huts of these tribes, their canoes, their fishing-gear, and hunting-methods have often been described, but Dr. Boas points out that their traditions, religious ideas, and social organisation are not equally well known. The principal figure in the mythology of several of them is a raven, who created all things, not for the benefit of mankind, but "in order to revenge himself." Cannibalism is practised by some tribes in connexion with the winter dances; and there is a Kwakiutl tradition, to the effect that one of their ancestors descended from heaven, wearing a ring of red-cedar bark, and taught the people the cannibal ceremonies. These ceremonies have been adopted only in part by the Qomoks, who content themselves with eating "artificial" bodies, which they prepare "by sewing dried halibut to a human skeleton." Among the Tsimpshian, the Tlingit, and the Haida, children belong to the mother's gens; among the Kwakiutl and Selish tribes they belong to the gens of the father. In some tribes there are as many as from fifteen to twenty gentes. Members of the same gens are not allowed to intermarry.

A WORK on "Physiological Psychology," by Prof. George T. Ladd, of Yale, will shortly be published. The writer, according to *Science*, maintains "a philosophical and psychological stand-point, while admitting to their proper place the conclusions reached by physiology respecting the nature and functions of the nervous system."

THE new numbers of "Studies in Microscopical Science," edited by Mr. A. C. Cole, deal with defoliation, spermatozoa in the Invertebrata, acute parenchymatous nephritis, fibrosis of kidney, and microbes.

THE seventh Deutsche Geographentag will be held at Carlsruhe to-day. The chief papers will relate to the German African colonies.

SHOCKS of earthquake were felt at Friedau (Carniola) on March 27, and at Travnik, in Bosnia, on March 31, at 3.30 a.m. In the night of April 1 there was a severe shock at Forli, in Italy.

WE have received from the Johns Hopkins University a new number (vol. iii. No. 9) of the series of "Studies from the Biological Laboratory." These "Studies," issued from time to time, contain most of the original scientific papers published by members of the Biological Department of the University. The editor and associate-editor are Dr. H. Newell-Martin and Dr. W. K. Brooks. The present number is a paper, by Dr. J. R. Duggan, on the influence of alcohol on the conversion of starch by diastase.

IN a statistical work which is being published, M. E. Levasseur, of Paris, shows that the chances of living long at any given age are much greater now in France than they were before 1789. Of 2000 infants (under one year) 1186 survived in 1789; 1460 survive at present. In 1789, 738 persons out of 2000 reached the age of 40; the number now is 1110. In 1789, 144 persons out of 2000 lived to the age of 75; the number now is 360. The death-rate of France is much the same as that of England, being rather superior at some ages, and inferior at others.

DR. DUDGEON, of Pekin, has at last published in Chinese a complete work on anatomy, at which he has been working for some years past. The printing was done by the press of the Tung-Wên or Foreign Language College, and the whole expense was borne by the Chinese Government. In accordance with Eastern custom, the title-page of the book is written by one of the Chinese Ministers who is celebrated for his beautiful calli-

graphy, and there are several prefaces by some of the highest officials of the Empire commending the work to the study of their countrymen. There are in all six volumes, two containing the illustrations, six hundred being plates. The latter were cut on blocks by native artists. Copies were presented to all the Ministers and other high officials. The companion work on physiology is almost ready for the press.

IN an article on "The Phylogeny of the Camelidæ," lately printed in the *American Naturalist* extra, Mr. E. D. Cope points out that the development of the camel in North America presents a remarkable parallel to that of the horse. The ancestors of both lines appear together in the Wasatch or lowest Eocene, and the successive forms develop side by side in all the succeeding formations. Both lines died out in North America, and of the two, the camels only have certainly held their own in South America. The history of the succession of horses in Europe, although not so complete as that in America, extends over as wide a period of time. Not so with the camels. There is no evidence of the existence of the camel line in the Old World before the late Miocene epoch; and so far as the existing evidence goes, the New World furnished the camel to the Old.

IN the *American Meteorological Journal*, Mr. M. W. Harrington is giving a full and very interesting account of the Chinook winds. The "Chinooks" are warm, dry, westerly or northerly winds occurring on the eastern slopes of the mountains of the north-west, beginning at any hour of the day, and continuing from a few hours to several days. Mr. Harrington says they may occur when a cyclone or anticyclone passes on such a course that the air is forced over the mountains from the western to the eastern slope. They are, therefore, winds similar to the "föhn" of Switzerland. In adding them (as Mr. G. M. Dawson, of the Geological Survey of Canada, had already done) to the class of winds of which the "föhn" is the type, Mr. Harrington points out that he is simply adding another to an already extensive list. Dr. Jelinek, in 1867, called attention to the fact that winds on the eastern slopes of the Caucasus were of this character. A similar wind occurs under the lee of the Elburz Mountains. Trebizond is in the lee of a high range of mountains, and has similar winds. They are common on the north side of the Pyrenees, and on the south coast of the Bay of Biscay. A similar wind has long been known in West Greenland, and Hoffmeyer proved, some years ago, that it is of the same character as the "föhn." It has been felt as far north as 82½° of latitude. Mr. Scott suggests that the hot winds of South Africa and parts of Australia are of the same character, while the analogy is proved complete for the hot "north-westers" of the Canterbury Plains of New Zealand.

THE first number of the American journal *The Stevens Indicator*, in its new form as a quarterly, contains an article giving a glowing account of the general prosperity of the Stevens Institute. The advance secured is attributed mainly to the wise and energetic leadership of President Morton. "To him," says the *Indicator*, "belongs the honour of realising, more than twenty years ago, when the Institute was first planned, that it would find its most useful work in the then almost unoccupied field of mechanical engineering, and that to this work it should confine, for a series of years at least, all its resources and efforts. How well the plans have succeeded is borne out by the long list of graduates who have been sent forth into positions of honour and trust, of influence and remuneration, by Stevens Institute during the last twelve years."

CAPT. GATES, of the ship *L. Sch 1886*, has reported to the U.S. Hydrographic Office that on April 19, 1886, when he was off Cape Horn, on a voyage from San Francisco to Liverpool, the

perature of the water suddenly rose from 42° to 44°. Thinking that the vessel was too close in shore, he hauled off three fms, and, after he had stood four hours on this course, he found that the temperature had fallen to 42°. On a previous voyage Capt. Gates noticed this warm belt.

COMMISSIONER COLMAN, of the Department of Agriculture in the United States, has issued a Circular relating to the so-called Australian rabbit. He points out that this animal—the common bit of Europe—has been very mischievous in Australia, and expresses his belief that its introduction into America would be unnecessary and hazardous experiment. Mr. Colman is of opinion that Congress should pass a law conferring upon the Commissioner of Agriculture the power to prevent the landing of any animal, bird, or other pest that might be injurious to agriculture; and he cites the case of the English sparrow as an example of the harm that may be done by species taken without consideration from the Old World to the New.

THE Swedish Government is anxious to acquire a colony in Africa, and is consequently preparing an Expedition under the direction of Lieut. A. Wester, formerly Chief of the Congo Station, Leopoldville. At the last meeting of the Stockholm Society of Anthropology and Geography, Lieut. Wester reported the subject. The Expedition may probably start next summer, and will be absent about a year, making Cameroon its base of operations. The cost will be about 160,000 kroner (8000*l.*).

MR. PAUL BEDFORD ELWELL will publish shortly, with Messrs. Whittaker and Co., an English translation of Gaston Planté's work on "The Storage of Electrical Energy."

THE eighth volume of the Journal of the Royal Horticultural Society, just issued, consists of a valuable Report on the effects of the severe frosts on vegetation during the winters of 1879-80 and 1880-81. The Report has been prepared by the Rev. Geo. Henslow, Honorary Secretary to the Scientific Committee of the Royal Horticultural Society. Most of the facts were obtained by means of schedules issued in 1880 and 1881.

A WORK entitled "The Australasian Federal Directory of Commerce, Trades, and Professions," will shortly be published in London under the direction of Mr. J. W. F. Rogers, of Melbourne and Sydney. It has been compiled by the assistance of the thousands of persons, many of them Colonial Government officials, and will give both in an alphabetic and a classified form business addresses for over three thousand Australasian firms, large and small. Reviews of the social and commercial development of the eight colonies of this group will appear in the Directory, with maps and gazetteer.

AN ingenious system of gas-lighting by electricity has been introduced by Messrs. Woodhouse and Rawson. Gas can be turned on, lit, and turned off from any convenient position irrespective of where the gas-fittings are placed. The principle of attachment is like that of the portable electric gas-lighter—the gas is lighted by an electric spark—but the general arrangements are for permanent fitting.

WE have received the fifth and sixth parts of the fourth volume of Dr. L. Rabenhorst's elaborate "Kryptogamen-Flora Deutschlands, Oesterreich, und der Schweiz." The subject of the fifth is Bryineæ: Stegocarpeæ (Acrocarpeæ). The text is well illustrated.

THE second part of the Report for 1885 of the Chief Signal Officer of the United States, is a separate treatise by Prof. Liam Ferrel, entitled, "Recent Advances in Meteorology, systematically arranged in the form of a Text-book, designed for use in the Signal Service School at Fort Meyer, and also for use as a text-book in the Office of the Chief Signal Officer." It is an octavo volume of 440 pages, and is published by the U.S. Government.

THE sixty-fourth number of the Journal of the Society of Telegraph-Engineers and Electricians, contains "The Determination of the Characteristics of Dynamos," by Mr. Gisbert Kapp; "Some Experiments on Secondary Cells," by Mr. James Swinburne; and "Some Magnetic Problems," by Prof. George Forbes. Reports of the discussions on these papers are also given.

A PERMANENT matrix excluder of draught and dust has been sent to us by Mr. T. J. Porter, the inventor. The excluder is made of a special composition inclosed in long, narrow strips of warm-coloured cloth, and moulded into a suitable form. The application of hot water enables the excluder to be formed into a long, narrow, solid, and permanent matrix round doors and windows. Mr. Porter says that it makes a practically air-tight joint, and entirely precludes the passage of draught and dust between doors and their casings, and windows and their casings.

A HALIBUT weighing thirty-four pounds and measuring 41 inches in length was captured lately in the lower Potomac, near Colonial Beach. It has been preserved in alcohol by the Smithsonian Institution, and a cast has been made and placed on exhibition in the U.S. National Museum. *Science* says this is the first authentic case of a halibut in fresh water.

THE additions to the Zoological Society's Gardens during the past week include a Short-tailed Wallaby (*Halmaturus brachyurus*) from Australia, presented by Mr. Herbert Maude; an American Flying Squirrel (*Sciuropterus volucella*) from North America, presented by Mr. A. R. Verschoyle; an Egyptian Mastigure (*Uromastix spinipes*) from North Africa, presented by Mr. V. J. Chamberlain; a Nepal Hornbill (*Aceros nepalensis*) from Nepal; a Tuberculated Iguana (*Iguana tuberculata*) from the West Indies, deposited; a Burchell's Zebra (*Equus burchelli*) from South Africa; two Adorned Ceratophrys (*Ceratophrys ornata*); an Anaconda (*Eunectes murinus*) from South America, purchased; a Rhesus Monkey (*Macacus rhesus*), a Sambur Deer (*Cervus aristotelis*), two Collared Fruit-Bats (*Cynonycteris collaris*), born in the Gardens.

OUR ASTRONOMICAL COLUMN

ORBIT OF THE BINARY STAR 14 (*β*) ORIONIS.—In the *Monthly Notices* for March, Mr. J. E. Gore publishes elements of the orbit of this binary, which is identical with O 298. Mr. Gore's results, which he regards as only provisional, give a period of 190.48 years, time of periastron passage 1959.05, eccentricity 0.2465, and semi-axis major 1"22. A comparison of places computed from these elements with the observations extending from 1844 to 1887, shows considerable discordances in the position-angles, whilst the distances agree very closely. The orbit of this double star does not appear to have been previously computed.

THE WASHINGTON OBSERVATORY.—Capt. R. L. Phythian, U.S.N., the Superintendent of the U.S. Naval Observatory, has published the programme of work to be pursued at the Observatory during the year 1887. From it we learn that with the 26-inch equatorial the observations of double stars, of the fainter stars in the Pleiades, and of the conjunctions of the five inner satellites of Saturn with the minor axis of the ring, and of the angles of position and distances of Hyperion will be continued during the year. The small equatorial will be used for observations of comets and of occultations of stars by the moon, as well as of stars and asteroids required for purposes of identification. With the transit-circle it is proposed to complete the observations of miscellaneous stars for the forthcoming transit-circle catalogue and also to observe the sun, moon, planets (major and minor), and stars of the American Ephemeris. Photographs of the sun will be taken daily, when practicable, with the photo-heliograph of the Transit of Venus Commission pattern.

NAMES OF MINOR PLANETS.—Minor planets Nos. 263 and 265 have been named *Dresda* and *Anna* respectively.

ASTRONOMICAL PHENOMENA FOR THE
WEEK 1887 APRIL 17-23

(FOR the reckoning of time the civil day, commencing at Greenwich mean midnight, counting the hours on to 24, is here employed.)

At Greenwich on April 17

Sun rises, 5h. 2m.; souths, 11h. 59m. 33'gs.; sets, 18h. 57m.; decl. on meridian, 10° 28' N.; Sidereal Time at Sunset, 8h. 39m.

Moon (New on April 23) rises, 3h. 3m.; souths, 7h. 53m.; sets, 12h. 49m.; decl. on meridian, 14° 2' S.

Planet	Rises h. m.	Souths h. m.	Sets h. m.	Decl. on meridian
Mercury ...	4 29 ...	10 22 ...	16 15 ...	2 9 S.
Venus ...	6 6 ...	14 5 ...	22 4 ...	20 54 N.
Mars ...	5 8 ...	12 7 ...	19 6 ...	10 45 N.
Jupiter ...	19 11* ...	0 20 ...	5 29 ...	10 37 S.
Saturn ...	9 20 ...	17 29 ...	1 38* ...	22 26 N.

* Indicates that the rising is that of the preceding evening and the setting that of the following morning.

April	h.	
18 ...	21 ...	Mercury at greatest elongation from the Sun, 27° west.
20 ...	21 ...	Mercury in conjunction with and 0° 31' north of the Moon.
21 ...	11 ...	Jupiter in opposition to the Sun.

Variable Stars

Star	R.A.		Decl.	h. m.
	h. m.	h. m.		
U Cephei ...	0 52.3	81 16 N.	Apr. 19,	4 42 m
Algol ...	3 0.8	40 31 N.	"	17, 20 45 m
β Libræ ...	14 54.9	8 4 S.	"	20, 21 3 m
			"	23, 4 54 m
U Coronæ ...	15 13.6	32 4 N.	"	17, 5 0 m
U Ophiuchi ...	17 10.8	1 20 N.	"	18, 4 10 m
				and at intervals of 20 8
W Sagittarii ...	17 57.8	29 35 S.	Apr. 20,	22 0 M
β Lyræ ...	18 45.9	33 14 N.	"	20, 0 0 M
S Vulpeculæ ...	19 43.8	27 0 N.	"	20, m
S Sagittæ ...	19 50.9	16 20 N.	"	18, 22 0 m
β Cephei ...	22 25.0	57 50 N.	"	20, 4 0 M
			"	23, 22 0 m

M signifies maximum; m minimum.

Meteor-Showers

The most interesting shower of the week is that of the *Lyrids*, April 18-20, R.A. 268°, Decl. 33° N. Other showers are as follows:—Very slow meteors from a radiant between Bootes and Virgo, R.A. 213°, Decl. 9° N.; very swift meteors from near α Herculis, R.A. 255°, Decl. 37° N., and from Vul. ecula, R.A. 299°, Decl. 24° N.

VALENCY AND RESIDUAL AFFINITY¹

I.

IN my address to the Chemical Section of the British Association at Aberdeen, I specially called attention to the "affinity" of negative elements—chlorine, oxygen, sulphur, &c.—for negative elements; and I sought to show that the formation of so-called *molecular compounds* is largely, if not entirely, an outcome of this peculiarity of negative elements. I also ventured to suggest "that in electrolysing solutions, the friction arising from the attraction of the ions for each other is perhaps diminished, not by the mere mechanical interposition of the neutral molecules of the solvent—in the manner suggested by F. Kohlrausch—but by the actual attraction exercised by these molecules upon the negative ion in virtue of the affinities of the negative radicles." In this passage I but vaguely hinted at a modification of the current theory of electrolysis which had occurred to me: as further consideration of the question, especially of Ostwald's electro-chemical studies, has strengthened my views, I am led to think that it may be justifiable to submit them for discussion.

It is usual to divide bodies into three classes according to the mode in which they are acted on by an electromotive force: metals forming one class, electrolytes a second, and dielectrics a

third. In making this division, perhaps the fact is not sufficiently borne in mind that some compounds—silver chloride, for example—are *per se* electrolytes, while others—such as hydrogen chloride and water—are *individually* dielectrics, but behave as electrolytes when conjoined. On this account, it appears to me desirable to distinguish between—

(a) Metals.

(b) Simple electrolytes—compounds like silver chloride which in the pure state are electrolytes.

(c) Pseudo-dielectrics—compounds like water, hydrogen chloride, and sulphuric acid, which behave as dielectrics when pure, but as electrolytes when mixed with other members of their own class. Conducting mixtures of members of this class may conveniently be termed *composite electrolytes*.

(d) Dielectrics.

Simple Electrolytes.—It is undoubtedly a fact that only a limited number of binary compounds are simple electrolytes; and it is especially noteworthy that, with the single doubtful exception of liquefied ammonia, no hydrogen compound—whether binary or of more complex composition—can be classed with the simple electrolytes. Indeed, all the simple electrolytes with which we are acquainted are either compounds, such as the metallic chlorides; or metallic salts—nitrates, sulphates, &c. Including metallic chlorides and their congeners and the corresponding oxides and hydroxides among salts—regarding water as an acid, in fact—and denying the title of salts—hydrogen salts—to the acids, Hittorf's proposition (*Wied. Ann.*, 1878, iv., p. 374), "Electrolyte sind Salze" may be safely upheld. But only some of the binary metallic salts are electrolytes: beryllium chloride, for example, belongs to the class of "pseudo-dielectrics" (Nilson and Petterson, *Wied. Ann.*, 1878, iv., p. 565; Humpidge, *Phil. Trans.*, 1883, p. 604); and in the case of those elements which readily form two classes of salts—so-called *ous* or *proto*-salts and *ic* or *per*-salts, the *ous* compounds alone appear to be electrolytes.

It is highly remarkable that whereas fused silver chloride is easily decomposed on passage of a current of low electromotive force, hydrogen chloride is a "pseudo-dielectric" which forms when coupled with the "pseudo-dielectric" water a readily conducting "composite electrolyte"; while mercuric chloride conducts with great difficulty—possibly not at all when pure—not only in the fused state, but even when coupled with water. No explanation of these facts seems to be afforded by thermo-chemical data.

The consideration of these and other similar cases, I think, can but lead to one conclusion: that electrolysis is conditioned both by the nature of the elements in the compound and its molecular structure.

The remarkable difference in the electrical behaviour of two compounds of the same element, such as stannous chloride, in which the ratio of tin to chlorine atoms is as 1 to 2, and stannic chloride, in which Sn: Cl = 1: 4—the one being a simple electrolyte, the other a pseudo-dielectric, if indeed it be not a dielectric—would appear almost to justify the conclusion that in the case of per-salts such as stannic chloride the metal is, as it were, enveloped in a non-conducting sheath of the negative radicle. But whether this be so or not, if—as appears to be the case—all simple electrolytes are *metallic* compounds, and if only proto-salts are electrolytes, may it not be that electric conduction in simple electrolytes is of the nature of ordinary metallic conduction, differing from it only in the circumstance that the compound is decomposed as a consequence of the passage of the current?

This would lead to the conception of an electrolyte as being a metallic compound of such elements, and so constituted, that electric conduction may take place through its mass in a manner similar to that in which it takes place through a mass of metal: in fact, through the agency of its metallic atoms. On this view, it is essential that the metallic atoms in the molecules comprising a mass of an electrolyte should be in proximity—as they probably are in proto-salts, but not in many per-salts. The conductivity of two-metal alloys is in many cases much less than that of either of the contained metals: for example, the conductivity of the alloy SnCu₂ is about one-fourth that of tin and about one-thirtieth that of copper. The specific conductivity of metals may, therefore, be much reduced by association with one another; and this being the case, it appears probable that the specific conductivity of a metal would be still more reduced by association with a non-metal, and that if the metal were one of low specific conductivity, it might thus practically become altogether deprived of conducting power: perhaps the "except-

¹ Revision and extension of a paper by Prof. H. E. Armstrong, F.R.S., communicated to the Royal Society last year.

mal" behaviour of mercuric and beryllium chlorides is to be explained by considerations such as these.

To discuss such questions at all satisfactorily, however, we are to know much more of the electrical behaviour of pure salts. It is surprising how little accurate knowledge we possess on this subject.

Composite Electrolytes.—I assume it to be admitted that ether water nor liquid hydrogen chloride, for example, is an electrolyte, although an aqueous solution of hydrogen chloride conducts freely, and is electrolysed by an electromotive force of little more than a volt.

The theory put forward by Clausius in 1857 in explanation of electrolysis (cf. Clerk Maxwell's "Elementary Treatise on Electricity," p. 104), has been widely accepted by physicists; but it seems to me that, on careful consideration of the evidence, and especially of recent exact observations on conditions of chemical change, it must be admitted, as I have elsewhere contended (A. Address), that proof is altogether wanting of the existence of a condition such as is postulated by Clausius. Moreover, as has been shown by Hittorf that cuprous and silver sulphides, and by F. Kohlrausch that silver iodide, all undergo electrolysis in the solid state: the partisans of the dissociation hypothesis would, I presume, scarcely contend that it is easily applicable to such cases as these. It also does not appear to afford any explanation of the abrupt change in conductivity which occurs in solid silver iodide and sulphide as the temperature is raised; or of the peculiar variation in conductivity which is observed in diluting sulphuric acid with water.

Again, I venture to think that the conductivity of a mixture of compounds which themselves have little or no conducting power is accounted for in but an unsatisfactory and insufficient manner by the hypothesis put forward by F. Kohlrausch (*Pogg. Ann.*, 1876, clix., p. 233); there appears to be *far too great a difference* in the behaviour of the pure compounds, water and liquid hydrogen chloride for example, and of a mixture—no composition apparently of either compound being effected by an electromotive force short of that which produces disruptive charge, although the mixture of the two will not withstand an electromotive force of little more than a volt. Influenced by these considerations, I am led to conclude that there is no satisfactory evidence that the constituents of the electrolyte either free prior to the action of the electromotive force, or are merely set free by the effect produced by the electromotive force upon either member separately of the composite electrolyte; that an additional influence comes into play, viz. that of the member of the composite electrolyte upon the other while both are under the influence of the electromotive force. This influence, I imagine, is exerted by the negative radicle of the ether member. Assuming, for example, that in a solution of hydrogen chloride in water the oxygen atom of the water molecule is straining at the chlorine atom of the hydrogen chloride molecule, if when subjected to the influence of an electromotive force the molecules are caused to flow past each other—the phenomena of electric endosmosis may be held to afford evidence that in composite electrolytes the molecules are set in motion—it is conceivable that this influence, superadded to that of the electromotive force upon the electrolyte, may bring about the disruption of the molecule and conduction: short, that a state may be induced such as Clausius considers to be the state prior to the action of the electromotive force.

A large amount of most valuable information on the condition of dilution and electrical conduction in aqueous solutions has been recently published by Arrhenius, Bouty, F. Kohlrausch, and Ostwald. In his most recent paper, Ostwald (*Journal für praktische Chemie*, 1885, xxxii., p. 300) has given the results of his determinations of the molecular conductivity in the case of no less than about 120 different acids; and it appears to me that many—indeed all—of his observations afford most distinct evidence in favour of the view I have expressed above. The general result of his investigation is that the molecular conductivity increases with dilution; in other words, that the dissolved substance exercises a greater specific effect, finally attaining a maximum; it then diminishes, but he believes this to be due to impurities in the water, especially to neutralisation of the acid traces of ammonium carbonate. The maximum, he appears to think, would be the same for all acids if the dilution could be pushed far enough: in the case of monobasic acids it is about 90 (arbitrary units); it is twice this in the case of dibasic, four in the case of tribasic, and so on.

I will quote first his results in the case of solutions of hydro-

gen chloride, bromide, iodide, fluoride, and silicon fluoride. v is the volume in litres which contains a weight in grammes corresponding to the formula of the dissolved substance—35.4 grammes of hydrogen chloride, for example.

v	HCl	HBr	HI	HF	H_2SiF_6
2	77.9	80.4	80.4	...	47.81
4	80.9	83.4	83.2	6.54	57.29
8	83.6	85.1	84.9	7.59	62.20
16	85.4	86.6	86.4	10.00	67.08
32	87.0	87.9	87.6	13.14	71.52
64	88.1	88.9	88.7	17.38	75.61
128	88.7	89.4	89.4	23.11	79.22
256	89.2	89.6	89.7	30.30	83.39
512	89.6	89.7	89.7	39.11	91.62
1024	89.5	89.5	89.3	49.49	109.5
2048	89.5	88.9	89.0	59.56	144.0
4096	88.6	87.6	87.8	69.42	187.1
8192	226.6
16384	258.6
32768	282.6

It will be observed that hydrogen chloride, bromide, and iodide practically behave alike; the numbers for the chloride are, however, slightly lower than those for the bromide and iodide, and the maximum is not reached quite so soon in the case of the chloride. Hydrogen fluoride is altogether different; its molecular conductivity is exceedingly low to begin with, and is considerably below the maximum even when $v = 4096$. But I would call special attention to the numbers for hydrogen silicon fluoride, which is commonly regarded as a dibasic acid: at first, as Ostwald says, it behaves as a monobasic acid of moderate strength—iodic acid, for example; but the maximum for monobasic acids being exceeded, the molecular conductivity increases more and more rapidly, ultimately exceeding the treble value, 270. It must be supposed that it undergoes decomposition in accordance with the equation—

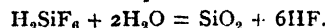

The noteworthy point is the large excess of water required to initiate this change: when $v = 16$ the solution contains less than 1 per cent. H_2SiF_6 , and at this point, according to Ostwald, decomposition probably begins; but that it is far from complete even when a very much larger excess is present is evident from the fact that the maximum when $v = 32,768$ is 282 and not above 400.

Now it is well known that hydrogen chloride, bromide, and iodide are, practically speaking, perfect gases under ordinary circumstances: in other words, masses of these gases would mainly consist of molecules such as are represented by the formulæ HCl, HBr, and HI. It has been proved, however, by Mallet, that hydrogen fluoride at temperatures near to its boiling-point mainly consists of molecules of the formula H_2F_2 . In the aqueous solution the molecules would be brought more closely together, and therefore it is probable that, even in the case of hydrogen chloride, bromide, and iodide, a certain proportion of more complex molecules would result: the relatively high boiling-point of hydrogen fluoride ($19^{\circ}.4$) renders it probable that in the liquid state this compound would at least partially consist of molecules more complex even than is represented by the formula H_2F_2 . On the hypothesis put forward in this paper, the influence exercised by the one member of the composite electrolyte upon the other member during electrolysis is at all events mainly exercised by their respective negative radicles, and the extent of the influence thus mutually exerted by these radicles would depend on the extent to which they are still possessed of "residual affinity." If the hydrogen chloride, bromide, and iodide are present chiefly as simple molecules, they should exert, *ab initio*, almost the full effect which they are capable of exerting; and the chief effect of dilution being to decompose the more complex molecules, conductivity should increase to but a slight extent if the extent to which simplification can take place be but small. On the other hand, if owing to the formation of molecular aggregates the residual affinity be more or less exhausted, the initial conductivity will be low, and it will increase on dilution only in proportion as these aggregates become broken up.

It appears to me that the behaviour of the four hydrides under discussion is absolutely in accordance with these requirements of the hypothesis. Evidence of the same kind is afforded by all of Ostwald's results.

The behaviour of solutions of neutral metallic salts on dilution

is very similar to that of acids; abundant proof of this is afforded especially by F. Kohlrausch's refined measurements, of which an account has recently been published (*Wied. Ann.*, 1886, xxvi., p. 162). I venture to think that a similar explanation to that above given for oxides will apply to salts; and also that the low molecular conductivities of salts as compared with corresponding acids may be regarded as confirmatory of my hypothesis. I think we must admit that the metals generally have less affinity than hydrogen for negative radicles; if this be granted, we have at once an explanation of the fact that metallic salts are mostly fixed solids, few of which are more than moderately soluble in water while many are very difficultly soluble or insoluble, whereas the corresponding acids are mostly volatile and readily soluble in water, if not miscible with it in all proportions. The affinity of the negative radicles being less exhausted by union with metals than with hydrogen, the fundamental molecules of salts are more prone to unite together to form complex aggregates.

Arrhenius, who has studied the electrical behaviour of solutions of a number of salts, attributes the change observed in molecular conductivity on dilution—as I have done—to molecular changes; but his deductions are all based on the acceptance of the Williamson-Clausius hypothesis of dissociation.

My hypothesis would also account for the increase in conductivity in composite electrolytes with rise of temperature. It is true that as temperature rises the influence which individual molecules exert upon each other would be lessened; but, on the other hand, the complex aggregates would become more and more completely resolved into their fundamental molecules, the velocity of molecular motion would increase, and the tendency of the constituent atoms to remain united would be lessened. From this point of view the determination of the coefficient of change of conductivity with temperature in the case of substances whose molecular conductivity increases considerably on dilution in comparison with allied compounds which exhibit only a slight variation in molecular conductivity on dilution affords an interesting subject for investigation. F. Kohlrausch has already pointed out (*Pogg. Ann.*, 1875, cliv., p. 236) that in the case of all neutral salts, "der Einfluss der Temperatur auf das Leitungsvermögen mit wachsender Verdünnung sich Anfangswerten nähert, die zwischen engen Grenzen liegen;" and the experiments of F. Kohlrausch and Nippoldt on solutions of sulphuric acid (*ibid.*, 1869, cxxviii., p. 286) show that the resistance diminishes to a much greater extent for equal increments of temperature in concentrated than in dilute solutions.

As concentrated solutions would be richer in complex aggregates than dilute solutions, these results are in entire accordance with my hypothesis: it does not appear to me that they can be satisfactorily interpreted in terms of the dissociation hypothesis.

In cases where the influence of the one member of the composite electrolyte upon the other is but slight, it may happen that the effect of temperature in diminishing this influence will outweigh that due to molecular simplification, and that, in consequence, conductivity will diminish with rise of temperature; a mixture of alcohol and ether would appear to furnish an example of this kind: according to Pfeiffer's recent observations (*Wied. Ann.*, 1886, xxvi., p. 216), such a mixture behaves as a metallic conductor of very high resistance.

The increase in conductivity of graphite and gas-retort carbon on heating, and the effect of light on the conductivity of (? impure) selenium and some other substances (Shelford Bidwell, *Phys. Soc. Proc.*, pp. 122, 256), appear to me to be also explicable on the assumption that in all these cases we are dealing with composite electrolytes.

If any further proof be needed of an intimate connexion between molecular composition and electrolytic conduction, it is most conclusively afforded, I think, by the observations of W. Kohlrausch on chloride, bromide, and iodide of silver (*Wied. Ann.*, 1882, xvii., p. 642). In the fused state, these compounds are better conductors than the most highly-conducting mixture of sulphuric acid and water, which of all liquids is the best conductor at ordinary temperatures, but when the change from the fused to the solid state sets in the resistance of both silver chloride and bromide suddenly increases. No such change takes place, however, in the case of silver iodide. This iodide fuses at 557° according to Rodwell, but at about 540° according to Kohlrausch; its electrical resistance increases only gradually after it has become solid, and remains almost a linear function of the temperature during an interval of 400°, until suddenly at

near 150° it increases enormously, this change taking place at the moment when, according to Rodwell (*Phil. Trans.*, 1882, p. 1153), it passes from the transparent, plastic, amorphous solid to the opaque, crystalline state, the volume increasing considerably. Kohlrausch has proved most conclusively that the solid iodide may undergo electrolysis. It would seem that almost immediately after solidification in the case of silver chloride and bromide practically the whole mass consists of complex aggregates so constituted as to be exceedingly bad conductors, but that such aggregates are formed much less readily by silver iodide.

(To be continued.)

THE MAZAPIL METEORIC IRON¹

AMONG the large number of meteoric irons which have been described, only eight² are recorded as having been seen to fall. It is my privilege to be able to add a ninth fall to this short list, and one which may prove to be of exceptional scientific importance. This mass of meteoric iron I received in August last as a gift from my friend, Prof. José A. y Bonilla, Director of the Astronomical Observatory at Zacatecas, Mexico. He stated that it was seen to fall at about 9 p.m. on November 27, 1885, during the periodical star-shower of the "Bielids." Such is the unique interest of this meteorite, as shown by its history, that I have delayed announcing it until the evidence of its fall had been substantiated as thoroughly as possible.

The general freshness of surface, which shows very perfectly the flow of the melted crust; the presence of unusually large nodules of a very compact graphite; the very slight superficial oxidation, and its dissimilarity to other meteorites of the region, are all interesting features of this iron, and serve to confirm the statement of its recent fall. When received it weighed about 3950 grammes. Its present weight is 3864 grammes, or 10 pounds 4½ ounces, troy. Its greatest length is 175 millimetres as measured diagonally across the mass. In its thickest part it measures about 60 millimetres. It could be described as a flat irregular mass, covered with deep depressions, having a smooth surface (see Fig. 1).

The evidence of the fall is set forth in the following communication from Prof. Bonilla.

(Translation).—"It is with great pleasure that I send to you the uranolate which fell near Mazapil, during the night of November 27, 1885. That you may the better appreciate the great scientific interest which this uranolate possesses, I will state that everything points to the belief that it belongs to a fragment of the comet of Biela-Gambart, lost since 1852. I here give you the history of this celestial wanderer. On December 2 (1885) I received, to my great delight, from Eulogio Mijares, who lives on the Conception Ranch, 13 kilometres to the east of the town of Mazapil, a uranolate, which he saw fall from the heavens, at nine o'clock on the evening of November 27, 1885. The fall, simply related, he tells as follows, in his own words:—

"It was about nine in the evening when I went to the corral to feed certain horses, when suddenly I heard a loud hissing noise, exactly as though something red-hot was being plunged into cold water, and almost instantly there followed a somewhat loud thud. At once the corral was covered with a phosphorescent light and suspended in the air were small luminous sparks as though from a rocket. I had not recovered from my surprise when I saw this luminous air disappear and there remained on the ground only such a light as is made when a match is rubbed. A number of people from the neighbouring houses came running toward me and they assisted me to quiet the horses which had become very much excited. We all asked each other what could be the matter, and we were afraid to walk in the corral for fear of getting burned. When, in a few moments, we had recovered from our surprise, we saw the phosphorescent light disappear, little by little, and when we had brought lights to look for the cause, we found a hole in the ground and in it a ball of fire. We retired to a distance, fearing it would explode

¹ From the March number of the *American Journal of Science*, vol. xxxiii. pp. 221-26.

² Agram, Croatia, May 26, 1751; Charlotte, Dickson Co., Tenn., August 1, 1835; Braunau, Bohemia, July 14, 1847; Tabarz, Saxony, October 18, 1854; Victoria West, Africa, in 1862; Nejed, Arabia, spring of 1865; Nedagolla, India, January 23, 1870; Rowton, Shropshire, England, April 20, 1876. See the Catalogue of the Meteorites in the Mineral Department of the British Museum, by L. Fletcher, p. 41.

d harm us. Looking up to the sky we saw from time to time halations or stars, which soon went out, but without noise. e returned after a little and found in the hole a hot stone, which we could barely handle, which on the next day we saw soked like a piece of iron; all night it rained stars, but we saw ne fall to the ground as they seemed to be extinguished while ll very high up.

"The above is the simple recital of the ranchman, and the anolite which fell is the one I send to you. From the merous questions I have asked Sr. Mijares, I am convinced at there was no explosion or breaking up on falling. Others to saw the phosphorescence, &c., were Luz Sifuentes, Pascual euz, Miguel Martinez, Justo Lopez, and some whose names I ve not obtained. Upon visiting the place of the fall I was rticular to examine the earth in and around the hole, and by reful search and washing the earth I found a few small bits of n, which must have become detached from the uranolite when penetrated the earth.

"The hole was 30 centimetres deep. Probably the light which was seen came from the volatilisation of the surface of the celestial body due to the high temperature acquired by friction with the atmosphere, and of this volatilised matter falling to the earth as an incandescent powder."

The above communication was followed by an account of the observation of the Biela meteors at Zacatecas by Prof. Bonilla and his assistants. (See *Annals N.Y. Acad. Sci.* 1887.)

The locality of the fall is situated in latitude 24° 35' N. and in longitude 101° 56' 45" West of Greenwich.

That no explosion was heard when this iron fell, is paralleled by the account of the fall of the fifty-six pound aërolite near Wold Cottage, Yorkshire, England, on December 13, 1795. "This stone fell within 10 yards of where a labourer was at work. No thunder, lightning, or luminous meteor accompanied the fall; but in two of the adjacent villages the sounds were so distinct of something passing through the air towards Wold

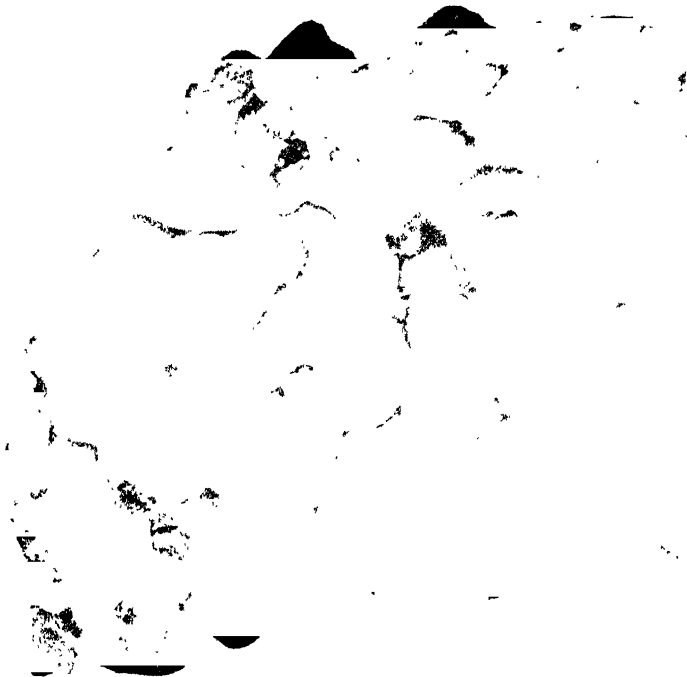

FIG. 1.—Mazapil Meteoric Iron. Weight 10 lbs. 4½ oz. troy (¾ natural size.)

ottage that several people went to see if anything extraordinary had happened to the house or the grounds" (L. Fletcher, "An Introduction to the Study of Meteorites," 1886, p. 22). Concerning the aërolites which fell at 11.50 a.m., on June 28, 1876, Stålldalen, in Sweden, "it is remarkable that no meteor was visible at the place where the stones fell, though it was seen over nearly all Sweden."

The surface of the Mazapil iron is of great interest. The deeply hollowed depressions entirely cover the mass (see Fig. 1). A thin black crust coats the surface, and exhibits well the striae of flow, as seen on meteorites whose fall has been observed. In even places nodules of graphite are noticed extruding from the surface (the engraving shows some of these), one of them is nearly an inch in diameter. The graphite is very hard and apparently amorphous; troilite and schreibersite were noticed in a section cut off for analysis and for the development of the figures of Widmanstätten. The crystalline structure (see Fig. 2) is well shown in the engraving (Ives' process) which is of natural size. The lines are somewhat similar to that of the Rowton iron in their width and distribution, and are very unlike the brown Mexican irons from Toluca, &c.

In its surface and general flatness the mass bears a remarkable

resemblance to the Hraschina, Agram, iron¹ which fell May 26, 1751. In its weight it is nearly like the irons of Rowton

FIG. 2.—Section of Mazapil Meteoric Iron (natural size.)

(7½ lbs.), Charlotte (9½ lbs.), Victoria West (6 lbs. 6 ozs.), and Nedagolla (9½ lbs.), which were all seen to fall.

¹ See "Beiträge zur Geschichte und Kenntnis meteorischer Stein- und Metallmassen," by Dr. Carl von Schreibers, Wien, 28ao, plate VIII.

Mr. J. B. Mackintosh has kindly analysed a small fragment with the following results, which, for comparison with other irons seen to fall, I have placed in tabular form:—

	Mampil.	Rowton. Flight.	Charlotte. Smith.	Escherville. Smith.
Iron.....	91.260	91.250	91.15	92.000
Nickel.....	7.845	8.582	8.05	7.100
Cobalt	0.653	0.371	0.72	0.690
Phosphorus...	0.300	0.06	0.112
	100.058	100.203	99.98	99.902

Carbon is distributed all through the iron between the crystalline plates, and it is noteworthy that this element was observed with the spectroscope as present, in the "Bielids" of November 27, 1885. Chlorine is also present and shows itself by a slight superficial deliquescence. Of this latter I will state that most of the surface oxidation of the ferrous chloride has occurred since August last. As yet no tests have been made to ascertain the amount of occluded gases, or to analyse the graphite nodules, and it is probable that this might only lead to results similar to those already obtained. Over the mass, where the crust has been accidentally removed, the lines of crystallisation (Widmanstätten figures) can readily be traced without etching the surface. The abrasion due to impact was very slight.

In conclusion, we cannot, from the very circumstantial account of the fall, and the corroborative evidence of the iron itself, which in several particulars contains heretofore unrecorded observations, decline to receive this meteorite as the ninth recorded fall of an iron mass to the earth; and perhaps at another period of the November "Bielids" this fall will be confirmed in all its interesting details. The interest connected with this meteorite, because of its beautifully marked and fresh surface, is enhanced by the concurrence of the time of its fall with the shower of the Biela meteors.

I wish to express here my deep obligation to Prof. Bönilla for the interesting data concerning this meteorite and for the gift of the meteorite itself, and to Mr. Mackintosh also for his kind interest in making the chemical analysis.

WILLIAM EARL HIDDEN

SOCIETIES AND ACADEMIES

LONDON

Royal Society, March 24.—"On Ellipsoidal Current Sheets." By Horace Lamb, M.A., F.R.S.

The paper treats of the induction of electric currents in an ellipsoidal sheet of conducting matter whose conductivity per unit area varies as the perpendicular from the centre on the tangent plane, or (say) in a thin shell of uniform material bounded by similar and coaxial ellipsoids. The method followed is to determine in the first instance the normal types of free currents.

When the normal types and their persistencies have been found, it is an easy matter to find the currents induced by given varying electromotive forces. Supposing that we have an external magnetic system whose potential varies as $e^{i\omega t}$, we can determine a fictitious distribution of current over the shell, which shall produce the same field in the interior. If ϕ denote the current-function for that part of the distribution which is of any specified normal type, ϕ that of the induced currents of this type, it is shown that

$$\phi = - \frac{i\omega r}{1 + i\omega\tau} \bar{\phi},$$

where τ is the corresponding persistency of free currents. When $\omega\tau$ is very great this becomes

$$\phi = - \bar{\phi},$$

in accordance with a well-known principle.

This method can be applied to find the currents induced by rotation of the shell in a constant field, it being known from Maxwell's "Electricity," § 600, that the induced currents are the same if we suppose the conductor to be fixed, and the field to rotate in the opposite direction. When the conductor is symmetrical above the axis of rotation, the current-function of any normal type contains as a factor $\cos s\omega$ or $\sin s\omega$, where ω is the azimuth, and s is integral (or zero). When we apply Maxwell's article, the corresponding time-factor is $e^{i\omega t}$, where ω is the angular velocity of the rotation; and we easily find that the

* Fell May 10, 1879, and contained embedded nodules of nickeliferous iron surrounded by silicates.

system of induced currents of any normal type is fixed in space, but is displaced relatively to the field through an angle,

$$\frac{1}{s} \text{arc tan } \rho s r$$

in azimuth, in the direction of the rotation.

In the most important normal types the distribution of current over the ellipsoid is one which has been indicated by Maxwell ("Electricity," § 675) as giving a uniform magnetic field throughout the interior.

In the higher types the current-function ϕ is a Lamé's function, degenerating into a spherical harmonic when two of the axes of the ellipsoidal shell are equal. Of the special forms which the conductor may assume, the most interesting is that in which the third axis (that of symmetry) is infinitesimal, so that we have practically a circular disk, whose resistance ρ' varies according to the law

$$\rho' = \rho_0 \sqrt{1 - r^2/a^2},$$

where ρ_0 is the conductivity at the centre, a is the radius, and r denotes the distance of any point from the centre. In the most persistent type

$$\tau = \frac{\pi^2 a}{2\rho_0}$$

This result is of some interest, as showing that the electrical time-constant for a disk of uniform resistance ρ_0 must at all events be considerably less than $4.93 a/\rho_0$.

The problem of induced currents is then discussed, more particularly in the case of a circular disk, of the kind indicated, rotating in any constant magnetic field. In view of the physical interest attaching to the question, it would be interesting to have a solution for the case of a uniform disk; but in the absence of this, the solution for the more special kind of disk here considered may not be uninteresting.

In the most important types of induced currents, the magnetic potential $\bar{\Omega}$ due to the field $\propto xz$, so that the lines of force at the disk are normal to it, but the direction of the force is reversed as we cross the axis of z . The current-function relatively to axes displaced through the proper angle η in the direction of rotation, varies as

$$y \sqrt{1 - r^2/a^2}.$$

In the next type $\bar{\Omega} \propto z(x^2 - y^2)$, and the current-function, relatively to displaced axes as before, varies as $xy \sqrt{1 - r^2/a^2}$.

"Note to a Memoir on the Theory of Mathematical Form" (Phil. Trans. 1886, vol. clxxvii. p. 1). By A. B. Kempe, M.A., F.R.S.

The object of this note is to make some slight but important amendments of certain sections of the original memoir (viz. secs. 5, 7, 73 to 77, and 167), relating to the definition and use of what the author terms "aspects" of collections of things. An "aspect" of a collection of n things is that which is under consideration when to each individual thing of the collection we mentally affix a distinctive degree of prominence or other mark. These n marks may be regarded as interchangeable with each other, and we thus get $|n|$ aspects of the collection, of which some are undistinguishable from each other. If the interchanges corresponding to a complete system of undistinguishable aspects of the collection are given we know the "form" of the collection.

March 31.—"On Clausius's Characteristic Equation for Substances applied to Messrs. Ramsay and Young's Experiments on Alcohol." By Prof. Fitzgerald, Trinity College, Dublin.

This paper is an investigation of how far Clausius's equation

$$\frac{P}{R\tau} = \frac{1}{v-a} - \frac{1}{\Theta(v+\beta)}$$

represents accurately Messrs. Ramsay and Young's experimental results. It is shown that, considering the enormous range of values to be represented, it represents the results remarkably accurately, except that from the volume of the liquid, where alone the value of a is of much consequence, it follows that a is not constant, but is a function of both the temperature and pressure.

The paper contains a short discussion of the geometrical forms of the curves—a particular case of which is represented by this equation.

I find by methods similar to those employed by Lord Rayleigh for the approximate determination of various acoustical constants, that the true value lies between $\pi\omega\rho'$ and $s\omega\rho'$. For a disk of copper (London C.G.S.), whose radius is a decimetre and thickness a millimetre, the former limit is 0.0014 sec. For disks of other dimensions the result will vary in the ratio and the thickness conjointly.

It concludes with a hope that the velocity of sound in a substance near the critical point may be investigated, in order that we may know the two specific heats under these exceptional circumstances.

Physical Society, March 26.—Prof. Balfour Stewart, *resident in the chair.*—The following paper was read:—On the production, preparation, and properties of the finest fibres. **Mr. C. V. Boys.** The inquiry into the production and properties of fibres was suggested by the experiments of Messrs. Gibson and Gregory on the tenacity of spun glass, described before the Society on February 12, and the necessity of using thin fibres in experiments on which Prof. Rücker and the author are engaged. The various methods of producing organic fibres such as silk, cobweb, &c., and the mineral fibres, volcanic glass, slag wool, and spun glass, were referred to, and experiments shown in which masses of fibres of sealing-wax or Canada balsam were produced by electrifying the melted substance. In producing very fine glass fibres, the author finds it best to use very small quantities at high temperatures, and the velocity of rotation should be as great as possible. The oxyhydrogen jet is used to attain the high temperature, and several methods of obtaining a great velocity have been devised. The best results obtained are given by a cross-bow and straw arrow, to the tail of which a thin rod of the substance to be drawn is attached. Pine is used for the bow, because the ratio of its elasticity to its density (on which the velocity attainable depends) is great. The free end of the rod is held between the fingers, and when the middle part has been heated to the required temperature the string of the cross-bow is suddenly released, thus projecting the arrow with great velocity and drawing out a long fine fibre. By this means fibres of glass less than 1/10,000 of an inch in diameter can be made. The author has also experimented on many minerals, such as quartz, sapphire, ruby, garnet, feldspar, fluor-spar, augite, emerald, &c., with more or less success. Ruby, sapphire, and fluor-spar cannot well be drawn into fibres by this process, but quartz, augite, and feldspar give very satisfactory results. Garnet, when treated at low temperatures, yields fibres exhibiting the most beautiful colours. Some very interesting results have been obtained with quartz, some of which fibres less than 1/100,000 of an inch in diameter have been obtained. It cannot be drawn directly from the crystal, but has to be slowly heated, fused, and cast in a thin rod, which rod is attached to the arrow as previously described. Quartz fibre exhibits remarkable properties, as it seems to be free from torsional fatigue, so evident in glass and metallic wires, and on this account is most valuable for instruments requiring torsional control. The tenacity of such fibres is about twenty tons on the square inch. In the experiments on the fatigue of fibres great difficulty was experienced in obtaining a cement magnetically neutral, and sealing-wax was found the most suitable. An experiment was performed illustrating the fatigue of glass fibres under torsion, and diagrams exhibited showing that the effect of annealing them is to reduce the sub-permanent deformation to about 1/10 its original amount under similar conditions. Annealing quartz fibres does not improve their torsional properties, and renders them rotten. Besides the use of quartz for torsional measurements, the author believes that quartz thermometers would be free from the change of zero so annoying in glass ones. He exhibited an annealed glass spiral capable of weighing a millionth of a grain fairly accurately, and also a diffraction grating made by placing the fine fibres side by side in the threads of a fine screw. Gratings so made give rounded spectra of white light. The author regretted that his paper was so incomplete, but thought the results already obtained would be of interest to the Society. Prof. W. G. Adams consulted the author on his most interesting paper, and considered the results to be of great importance. He believed the rounded spectra exhibited by the grating were probably due to internal reflection within the fibres. Mr. Cunyngnam asked whether the glass mirror used in the torsional experiments was magnetic, to which the author replied that this was probable, but even this assumption did not explain all the peculiarities observed.—A paper by Prof. Pickering was postponed till the next meeting, on April 23.

EDINBURGH

Scottish Meteorological Society, March 30.—Half-Yearly Meeting.—Mr. John Murray in the chair.—It was reported that four new stations had been recently added, viz., Aberlour, Perth, and Alton Craig and Oxcarr Lighthouses; and an arrangement had been entered into with the Meteorological Council by

which daily observations of temperature and rainfall are transmitted for the Weekly Weather Report issued by the Council for agricultural and sanitary purposes from the Society's stations at Lairg, Glencarron, Fort Augustus, Braemar, Ochtertyre, Marchmont, and Glenlee. Messrs. R. M. Smith, John Murray, and J. Y. Buchanan were re-elected members of the Council. The work of collecting and discussing the sea temperatures round the Scottish coast, for which a grant of 50% has been obtained from the Government Grant Committee, has been transferred to Mr. H. N. Dickson. The report from the Council enters somewhat in detail into the physical and biological work carried on at the Scottish Marine Station. Six trips have been made since July by the *Medusa* in the Firth of Clyde and connected lochs, during which observations of sea temperatures were taken at all depths from the surface to the bottom, special attention being directed to the further investigation of the remarkable and unexpected distribution of temperature occurring in this part of the ocean at certain seasons, as disclosed during previous trips of the *Medusa*. Dredging was also vigorously prosecuted, and all the specimens obtained have been determined, their anatomy investigated, and the results prepared for publication by the staff of the Scottish Marine Station. This Station continues to be largely taken advantage of by biologists, for whom tables are provided in the laboratory free of charge, for prosecuting their zoological researches. As regards the Ben Nevis Observatory, it was reported that the subscriptions raised since the commencement of the present year for clearing off the debt and founding a low-level station of the first order at Fort William now amounted to 822l., thus bringing up the amount contributed by the public since the establishment of the Observatory in 1883 to nearly 8000l.—An address was then delivered by the Hon. Ralph Abercromby, at the request of the Council, on modern developments of cloud knowledge, with lime-light illustrations of clouds from all parts of the world. It was shown that clouds were everywhere the same, and that the different forms of clouds which he had exhibited from all regions of the globe could be seen in Scotland. A modification of the present classification of clouds which has been proposed by Prof. Hildebrandsson, of Upsala, and himself, was explained and illustrated. He then dealt successively with the structure of clouds and their height, the atmospheric conditions concerned in the formation of the different kinds of clouds, the remarkable results to which cloud-motions led as regards the nature of cyclones and anticyclones, the forecasting value of clouds, and finally the necessity of attending, in all efforts to interpret the indications of clouds, not merely to their forms, but also to their surroundings. In moving a vote of thanks to the lecturer, Prof. Chrystal took occasion to refer to the great beauty of the photographs shown by the lime-light, which were highly appreciated by a large and influential audience.

PARIS

Academy of Sciences, April 4.—M. Janssen, President, in the chair.—Researches on certain phenomena connected with the aberration of light, by M. Fizeau. The paper deals chiefly with the nature of the phenomena that may be produced in the reflection of a pencil of light on the surface of a mirror, assuming this mirror to be endowed with a velocity comparable to that of light.—Stroboscopic method for comparing the duration of vibration of two diapasons, or that of the oscillation of two pendulums, by M. Lippmann. A description is given of a very accurate process of making these comparisons derived from the stroboscopic method.—On the central calm in cyclonic storms, by M. H. Faye. This central stillness is found to be present in all tropical cyclones, persisting even beyond the 50° latitude, but becoming modified according as the storm approaches the Pole without ever disappearing altogether.—On various effects of irritation in the throat, and especially on loss of sensibility and sudden death, by M. Brown-Séquard. Numerous experiments tend to show that the skin of the throat possesses, like the larynx, but to a less degree, the power of arresting sensibility; also that the larynx, the trachea, and also, perhaps, the cuticle covering them, possess the power of causing death under a mechanical irritation in the same way as the rachidian bulb.—On the seismic phenomena of February 1887, by M. Ch. V. Zenger. A parallelism is suggested between these disturbances and atmospheric, electric, and magnetic phenomena and volcanic eruptions so often occurring simultaneously.—Rectification of right, unicursal, circular cubics by means of the elliptical integrals, by M. G. de Longchamps. In supplement to his recent note, the author

here establishes the important generalisation that all these cubics may be rectified by means of the elliptical integrals.—On the voltaic arc, by M. G. Maneuvrier. A new process is described, by means of which the voltaic arc may be excited without previous contact of the two electrodes.—Law of distribution of the rays and bands common to several spectra of bands, by M. Deslandres. Having already shown that the rays composing the same band may be divided into a series of identical rays, such that in each series the intervals between one ray and the following run pretty well in arithmetical progression, the author here extends this simple law of distribution to the bands of the same spectrum of bands, indicating an analogy with the law of succession of sounds in a solid body.—Fatal accidents in electric workshops, by M. A. d'Arsonval. Some remarks are presented on the causes of these accidents, on their physiological effects, and on the means of preventing them.—Quantitative analysis of vanadic acid, by M. A. Ditte. It is shown that by observing certain precautions the method indicated by Berzelius, based on the insolubility of the vanadate of ammonia in sal ammoniac may be applied to the analysis of vanadium in the form of vanadic acid with satisfactory results.—On some ammoniacal combinations of the sulphate and nitrate of cadmium, by M. G. André. Some details are given for the preparation of the ammoniacal sulphates and nitrates of cadmium, with indications of their possible relations to the corresponding salts of zinc and copper.—On the extraction and analysis of the vanadium occurring in rocks and mineral ores, by M. L. L'Hôte. The method here described involves two operations: the extraction of the vanadium in the form of vanadic solution, and its analysis by means of titrated liquors, or by weighing.—On the preparation of the propylamines and iso-amylamines, by M. H. Malbot. The observations recently made by the author on the isobutylamines are here extended to the amines derived from various alcohols.—On the power of multiplication of the ciliated Infusoria, by M. E. Maupas. This power is shown to depend on three factors: the quality and abundance of nourishment; temperature; and the biological adaptation of each species from the alimentary standpoint.—Results obtained by the preventive inoculation of the attenuated virus of yellow fever at Rio de Janeiro, by MM. Domingos Freire, Paul Gibier, and C. Rebourgeon. Of the 1675 cases terminating fatally between January 1885 and September 1886, only 8 had been vaccinated, and these at a time when the treatment was still imperfectly understood. In general, the mortality is now 1 per 1000 for the vaccinated, and 1 per 100 for all others.

BERLIN

Physiological Society, March 25.—Prof. du Bois-Reymond, President, in the chair.—Prof. Falk spoke on the influence of extremes of temperature on the colour of blood. In persons either burnt or frozen to death the *post-mortem* patches present a strikingly bright red colour. The speaker has found, as the result of an experimental investigation, that temperatures of 0° C., and below, lead to the colour of the blood becoming bright red by causing the oxygen of the air to be more readily fixed and more stably retained by the corpuscles than is the case at ordinary temperatures. If, however, the blood has stood exposed to the air until putrefactive changes have set in, in this case the action of cold no longer makes the blood brighter in colour. Other experiments have shown that in animals killed by low temperatures the blood is bright red, not only in the peripheral parts but also in the heart and great vessels. Also in human beings frozen to death the blood even in the heart is sometimes observed to be bright red, although in most cases only the blood of the peripheral parts presents this appearance; probably death has ensued from freezing only in cases presenting the first of these two appearances.—The President read a communication from Prof. Fredericq, of Louvain, on Traube-Hering curves. As is well known, a blood-pressure tracing recorded by a mercurial manometer, shows three distinct kinds of curves:—(1) Curves of the first order, which are caused by the systole of the heart. (2) Curves of the second order, which make their appearance at lengthy intervals and are synchronous with the respiratory movements: these curves represent the influence of the respiration on the blood-pressure. (3) Curves of the third order, which make their appearance at still longer intervals and were first described by Siegmund Meyer: these have usually been regarded as due to a rhythmic increase and diminution in the activity of the vaso-motor centre. The curves described by Traube and Hering have until now been regarded

as belonging to the above-mentioned third order of curves. Prof. Fredericq, however, regards this as an incorrect view; he regards them as belonging to the second order, corresponding to and produced by the respiratory movements.—Dr. Wurste stated that he has treated the caseine-like substance (see NATURE vol. xxv. p. 455) obtained by the addition of hydrogen-peroxide to white of eggs with ammonia, and finds that a portion of this substance is thereby dissolved. Another portion however, is converted into a rosy mass, which on being dried yields a horny substance, with a very marked affinity for colouring matters, and which exhibits nearly all the characteristics of horn. He has further found that these two bodies undergo a change by the action of nitrite of soda on the white of eggs. By the addition of lactic or acetic acid he has obtained a yellow precipitate which turned intensely red on exposure to the air; the same reagents applied to blood produced a black coloration.—Prof. Zuntz gave a short communication on the course of experiments which he has made in conjunction with Prof. Virchow and Senator on Cotti during his fast lasting over eleven days. The results of the investigation have not yet been completely put together, but will be communicated at an early sitting of the Physiological Society.

BOOKS, PAMPHLETS, and SERIALS RECEIVED

Calendar of the Royal University of Ireland, 1887 (Thom, Dublin).—Studies from the Laboratory of Physiological Chemistry, Sheffield Scientific School of Yale University, vol. ii. (New Haven).—Transactions of the Edinburgh Geological Society, vol. v. Part 2 (Edinburgh).—The Treatment and Utilisation of Sewage, 3rd edition: W. Corfield and L. Parkes (Macmillan).—Practical Solid Geometry: W. G. Ross (Cassells).—Bees and Bee-Keeping, vol. ii. Part 7: F. R. Cheshire (Gill).—British Dogs, No. 6: H. Dalziel (Gill).—Catalogue der Bibliotheek van 'Slands Plantentuin te Buitenzorg (Batavia).—Nitrate of Soda: A. Stutzer (Whitaker).—Mystery of Gravity: J. Fraser (Wyman).—England as a Petroleum Power: C. Marvill (Anderson).—Circulars of Information of the Bureau of Education, Nos. 1 and 2, 1886 (Washington).—Report of the Mitchell Library, Glasgow, 1886 (Glasgow).—Geological Magazine, No. 274 (Trübner).—Journal of the Chemical Society, April (Gurney and Jackson).—Journal of the Straits Branch of the Royal Asiatic Society, June 1886: Notes and Queries (Singapore).

CONTENTS

PAGE

A Naturalist in South America, II.	551
Palæolithic Man in North-West Middlesex	552
Our Book Shelf:—	
Strasburger: "Hand-book of Practical Botany for the Botanical Laboratory and Private Student"	556
Shore: "Elementary Practical Biology—Vegetable"	556
Letters to the Editor:—	
A Plant which destroys the Taste of Sweetness.—W. T. Thiselton Dyer, C.M.G., F.R.S.	557
Units of Weight, Mass, and Force.—Prof. Alfred Lodge	557
The Association's "Geometry."—Prof. George Bruce Halsted	557
The Svastika as both Sun and Fire Symbol.—Mrs. J. C. Murray-Aynsley. (Illustrated)	558
Important Points in the History of Earthquake Investigation in Japan.—Prof. John Milne	559
Supposed Suicide of the Cobra.—R. D. Oldham.	560
The Retirement of Dr. Tyndall	560
Primroses. By W. Botting Hemsley	561
On the Establishment of the Roman Dominion in South-East Britain. By Sir G. B. Airy, F.R.S.	562
The European Prehistoric Races. By Prof. A. H. Keane	564
An Examination of the Leaves of <i>Gymnema sylvestre</i> . By David Hooper	565
Notes	567
Our Astronomical Column:—	
Orbit of the Binary Star 14 (γ) Orion	569
The Washington Observatory	569
Names of Minor Planets	569
Astronomical Phenomena for the Week 1887	
April 17–23	570
Valency and Residual Affinity, I. By Prof. H. E. Armstrong, F.R.S.	574
The Masapai Meteoric Iron. By William Earl Hidden. (Illustrated)	575
Societies and Academies	574
Books, Pamphlets, and Serials Received	576

THURSDAY, APRIL 21, 1887

GOEBEL'S OUTLINES OF THE CLASSIFICATION OF PLANTS

Outlines of Classification and Special Morphology of Plants. By Dr. K. Goebel. A New Edition of Sachs's "Text-book of Botany," Book II. Authorised English Translation by Henry E. F. Garnsey, M.A. Revised by Prof. I. Bayley Balfour, M.A., M.D., F.R.S. (Oxford: Clarendon Press, 1887.)

ALL botanists who have been familiar, since 1882, with the original of this admirable work, will welcome the present translation, while it will be of even greater value to the large class of students who were unable to make use of the German edition. The full importance of Prof. Goebel's work will only be realised by those who have some acquaintance with the immense progress made in the morphology of plants since 1874, when the last German edition of Sachs's "Text-book" was published. Not a few of the most important of these discoveries are due to Goebel himself, and this fact, no doubt, partly explains the remarkable success with which he accomplished the difficult task of re-writing Sachs's Second Book. Goebel's work is, to all intents and purposes, a new one; but, at the same time, Sachs's own words have been incorporated in the new text in every case where the progress of the science did not actually demand a change.

Important additions to our knowledge have of course been made since the first appearance of this work in Germany. These have been duly recorded, in the English edition, by Prof. Balfour, who has wisely limited the additions to foot-notes. In one or two cases it might, perhaps, have been wished that these notes had been a little fuller.

It will not be without interest to enumerate some of the more striking differences between this work and the corresponding portion of Sachs's treatise. It must not be forgotten that Dr. Vines's revised edition of the latter work had already brought many of these points before English readers.

The same fourfold division of the vegetable kingdom which was adopted by Sachs is maintained here, though it is pointed out that a division into three (Thallophytes, Archegoniatae, and Angiosperms) would be equally justified. The practical advantages of the former arrangement are obvious. In the classification of the Thallophytes we at once recognise a great advance. The artificial "sexual system," as it has been called, is quite given up, and an arrangement adopted which is based, as far as possible, on the entire life-cycle of the plants in question. Most teachers of botany will already have long abandoned the groups of "Protohyta, Zygosporae, Oosporae, and Carposporae," but it will be an immense gain to students to have a more natural system embodied in a text-book. In Goebel's system we have five main groups. Of these, the first two (Myxomycetes and Diatoms) are kept separate from the rest, on the ground of their uncertain relationships. Then we have the Schizophytes, including the Cyanophyceae or blue-green

Algæ on the one hand, and the Schizomycetes or Bacteria on the other. Then come the two main lines of the Algæ and the Fungi, which are thus again recognised as constituting natural classes, after the separation of the lower groups above mentioned.

The present arrangement is essentially that of De Bary, and no one will doubt that it approximates as nearly to a natural classification as our existing knowledge admits of. The fact that the conditions on which Sachs based his division have been repeatedly shown to vary among the most nearly related plants, is sufficient proof of the necessity for a return to less artificial views. It is to be regretted that no satisfactory place for the Diatoms has yet been found in classification. As regards the Myxomycetes, it will scarcely be doubted that they have no near relationship to any of the higher groups of plants. The fact that the fusion of the plasmodia is not accompanied by a union of their nuclei shows that this process cannot be regarded as a sexual one.

It will be observed that the Yeast-Fungi no longer appear side by side with the Bacteria, but are treated, in accordance with De Bary's views, as reduced Ascomycetes.

In the Algal series, attention may be called to the interesting section on the Volvocineae, among which the transition from zygosporous to oosporous reproduction can be traced with special clearness. The discoveries relating to Acetabularia, Dasycladus, &c., show that a similar advance has taken place within the very distinct group of the Siphoneae, while even among the simpler Protococcaceae indications of an external differentiation between the sexual cells are not wanting. The account of the Phæophyceae is of special interest from the same point of view, the series from Ectocarpus through Cutleria to Fucus showing the passage from simple conjugation of motile gametes to typical fertilisation of an oosphere by a spermatozoid.

The treatment of the red sea-weeds shows, on the whole, a great advance, though we anticipate still greater changes when the next edition comes to be written. We may venture to express a doubt as to the view here adopted, that the Bangiaceae are simple forms of the Florideae. Schmitz has already shown how slight are the grounds on which this arrangement is based. It seems to us probable that a relationship of the Bangiaceae to the Ulvaceae may again be recognised in the future, as has already been suggested by Mr. Bennett.

The account of the Characeae is little modified from that in Sachs, but it will be noticed that they are here treated as oosporous Chlorophyceae. The question of their systematic position will probably long remain insoluble, but there can be no doubt that they have little in common with any of the carposporous forms of Algæ.

Among the Fungi many changes will be found, of which only one or two can be referred to here. The gradual progress of apogamous degeneration among the Peronospora and Saprolegnieae, so important for the whole question of sexuality in Fungi, is fully described in the light of De Bary's researches.

Among other points, we may mention the advances in our knowledge of the Lichens, especially of their reproduction, and also the view here adopted, that the Basidio-

mycetes are wholly asexual forms, their so-called fruit representing a complex gonidiophore.

Leaving the Thallophytes, many signs of advance will be found in the description of the Muscineæ. Attention may especially be called to the very clear account now given of the embryology both of the Liverworts and of the true Mosses. In a future edition a fuller account of the vegetative anatomy of the latter class may perhaps be looked for.

In the group of the Vascular Cryptogams the changes have been very numerous. Goebel's view of the essential distinction between the forms in which the sporangium arises from a single cell, and those in which a whole group of cells takes part in its formation, gives the clue to the arrangement here followed. Indeed, there is no part of the book in which the author's own researches have given rise to more important results. The whole subject of the development of the sporangia, both among vascular cryptogams and flowering plants, is one which Goebel has especially made his own.

As regards other points, we may mention that the important subject of apogamy in Ferns is treated at length in the text, while the converse phenomenon of apospory, more recently investigated by Prof. Bower, is dealt with in an editorial note. The embryology of the whole group is treated much more completely than before, and illustrated by new figures. The brilliant discoveries of Treub in the Lycopodiaceæ are shortly recorded in a note, but his most recent work did not appear in time to be noticed.

Going on to the Gymnosperms, we find that the researches of Treub have here led to important advances in our knowledge of the Cycadææ. The Coniferæ are treated very fully, and here it is more especially to the labours of Strasburger that the most important progress is due. To him are to be attributed most of the recent discoveries on the development of the macrosporangium and of the prothallus and embryo. It need scarcely be pointed out that these results, in conjunction with the investigations of the author himself, have demonstrated in every detail the homologies between Gymnosperms and Pteridophyta long ago detected by the genius of Hofmeister.

Before leaving the Coniferæ, attention must be called to an error which has, curiously enough, survived through several editions of Sachs's "Text-book," and through both the German and the English versions of the present work. At the middle of p. 337 it is stated that in *Juniperus* the lowest of the three cells derived from the oospore divides into four cells, each of which gives rise to a rudimentary embryo, so that four rudimentary embryos proceed from one archegonium. At the bottom of the same page we find the following sentence: "But *Picea vulgaris* agrees with *Juniperus*, inasmuch as the lowest of the three primary cells of the suspensor does not divide, but forms only one rudiment." Of these two contradictory statements the former is, of course, the correct one; in the sentence last quoted, *Thuja* should be read for *Juniperus*.

As regards the Angiosperms, the most considerable changes introduced relate to the development of the stamen on the one hand, and of the ovule and embryo-sac on the other. In the former case it is especially the

work of Warming, in the latter that of Strasburger, to which our present knowledge of the facts is due. The treatment of all these subjects by the author of this book is singularly clear. The student will see how the homologies, which were so evident in the case of the Gymnosperms, can also be traced here up to a certain point, while he will also see exactly where our knowledge is still deficient.

The improved account of the embryology of Angiosperms may also be noticed, especially the interesting summary of Strasburger's investigations on polyembryony.

As regards the translation, both Mr. Garnsey and Prof. Balfour may be warmly congratulated on their success. Here and there a slight want of clearness may perhaps be noticed, but this is very rare, and scarcely any errors have been detected. One on p. 17 may, however, be pointed out. It is there stated that in the *Myxomycetes* "a plasmodium moves away from illuminated spots; if a stronger light is thrown directly upon these spots, a number of plasmodia collect in them." This does not express the fact as stated in the original, which is that, if the plasmodia be directly exposed to strong light, they form larger conglomerations. Again, at the top of p. 97, the phrase "*ins Freie*" should scarcely have been translated "into the air," in speaking of a submerged aquatic plant.

The explanation of terms at the end of the book will be of the greatest possible value not only to students but to botanists. We may hope that it will materially contribute to introduce order into the chaos of our terminology. We are glad to see the good old term *spermatozoid* replacing the inaccurate *antherozoid*, and we could wish that ovum could constantly be used for oosphere. Where clear homologies with the animal kingdom can be traced, it seems a distinct loss to ignore them.

On the other hand, we cannot feel satisfied with the word "sporophyte" for the asexual generation in the higher plants. "Sporophyte" is the correlative of "spermaphyte," and has actually been used by Luerssen and others in the sense of a Cryptogam, as distinguished from the seed-bearing Phanerogam. We should have thought that the older terms "sporophore" and "oophore" would answer every purpose.

In conclusion, we can only say that the appearance of this book marks the most important addition to our morphological literature since 1875. D. H. S.

MINERAL PHYSIOLOGY AND PHYSIOGRAPHY

Mineral Physiology and Physiography. A Second Series of Chemical and Geological Essays, with a General Introduction. By Thomas Sterry Hunt, M.A., LL.D. Pp. 638. (Boston: Samuel E. Cassino, 1886.)

THIS work, as its sub-title implies, is a continuation of the series of essays first published by Dr. Sterry Hunt in 1874, of which a second and revised edition appeared in 1878. The essays which make up the present volume have with one exception, that on "The Genetic History of Crystalline Rocks," already appeared in various scientific journals.

The principal title of the work is explained and justified by its author in the two first essays. Dr. Sterry Hunt advocates a return to the older and wider meaning of the term "physiology" as it was employed two

centuries ago; he maintains that all the natural sciences fall into two great divisions, the descriptive or physiological, and the philosophical or physiological. It seems scarcely necessary to point out that the term physiology is now so universally restricted to the study of the actions of organised beings that any attempt to make it include physics and chemistry, with a large part of geology and astronomy, as the author proposes, can scarcely be expected to meet with much success. In scientific terminology a struggle for existence is continually going on, and it is hopeless to fight against the results of selection: to endeavour at the present day to revive the older and wider meaning of the term "physiology," and to use it as a synonym for "natural philosophy" side by side with the modern and more restricted sense, must almost infallibly lead to confusion. Still more hopeless would it be to try and abolish the use of the term in its present accepted sense.

In the third essay, on "The Chemical and Geological Relations of the Atmosphere," Dr. Sterry Hunt states and defends his well-known speculation concerning the replacement of the carbonic dioxide which is being continually removed from the atmosphere by the processes of kaolinisation and of coal-formation. Rejecting the too obvious suggestion advanced by Stanislas Meunier and others, that the equivalent of the carbonic dioxide abstracted from the atmosphere by the processes in question may be returned to it from subterranean sources, the author insists that such supplies can only come from outside the earth's atmosphere, and must be cosmical in their origin. The fourth essay, following up some of the ideas hinted at in the third, deals with "Celestial Chemistry from the Time of Newton," and is principally occupied with a discussion of the nature of interstellar matter.

The two essays dealing with "The Origin of Crystalline Rocks" and "The Genetic History of the Crystalline Rocks" are devoted to a destructive criticism of various theories which have been propounded to account for the origin of the crystalline schists and gneisses, and the attempt to supply a new one. As is well known, Dr. Sterry Hunt is one of those who maintain that all rocks of this class are necessarily of Archæan age; unlike some of his contemporaries who share the same views, however, he does not shrink from what he believes to be the logical conclusion from these premises, and maintains that the formation of such rocks must result from actions of a very different kind from any now going on upon the globe. According to Dr. Sterry Hunt's idea, which he calls the "crenitic hypothesis," "the crystalline stratiform rocks, as well as many erupted rocks, are supposed to be derived from a primary superficial layer, regarded as the last portion of the globe solidified in cooling from a state of igneous fluidity." After the wonderful speculative flights of these two essays, Dr. Sterry Hunt returns to the ground of sober scientific thought in several essays where ordinary chemists and geologists will not find themselves altogether out of their depth.

The solid contributions made to mineralogical science by the author of these essays may perhaps warrant an attempt on his part to deal with the difficult and involved question of mineralogical classification. This subject he has treated in his essay, "A Natural System of Mineralogy," an elaboration of which is promised in a treatise

on mineralogy now in preparation. Dr. Sterry Hunt adopts, as might be anticipated, a purely chemical classification; but his results, which differ in many important particulars from those both of Rammelsberg and Tschermak, do not attract us by their simplicity, and seem perhaps needlessly obscured by the adoption of a very cumbrous terminology.

The essay on "The Geological History of Serpentine" is one in which all the author's peculiar originality and boldness are displayed in their highest perfection. That in the face of the results obtained by the study of rocks with the microscope, anyone could be found to maintain at the present day the *aqueous origin* of many, if not all, serpentine, may seem startling to those who have not read the author's previous writings on the subject. The dexterous gliding over difficult and dangerous places, and the elaborate "figure-cutting" on a few strips of apparently solid ice, constitute one of the most remarkable displays of courage and skill ever exhibited—even by the great mental athlete of Canada himself!

The "Taconic" rocks have formed in North America the battle-ground for two rival schools of geological thought, exactly comparable to that afforded by the Alps to European geologists, and the Scottish Highlands to those of Britain. In the ninth and eleventh essays of the present volume, Dr. Sterry Hunt maintains and stoutly defends his well-known views concerning the origin and succession of the Archæan rocks. For him the most highly foliated schists and gneisses exhibit a stratification clearly due to some kind of sedimentation; in the mineralogical constitution of these rocks he finds evidences of geological age more trustworthy even than those of the organic remains in the later aqueous deposits, and relying implicitly upon this kind of evidence, he has evolved a universal classification for the Archæan deposits which he can apply equally to the rocks of Southern Europe and of British North America. At some of these results persons of less robust faith in Dr. Sterry Hunt's methods can only give way to "admiration," as, for example, when igneous rocks which have been demonstrated to be intrusive in Secondary deposits, are boldly claimed, on account of their mineral characters, as members of some Archæan "system"!

Throughout the present volume, as in the former one, Dr. Sterry Hunt keeps prominently in view his claims to priority, and jealously defends the originality of many of the ideas he puts forward. We cannot but think ourselves that the claim to originality is one which he need take the smallest care to insist upon. If no name had appeared upon the title-page of this remarkable work, every chemist and geologist glancing at its pages would have felt assured that its author could be no other than Dr. Sterry Hunt.

OUR BOOK SHELF

Through the Fields with Linnæus. By Mrs. Florence Caddy. Two Vols. (London: Longmans, Green, and Co., 1887.)

THIS enthusiastic book is the fruit of the author's visit to the land of Linnæus, and her journeys in his track. Its purpose is to tell the story of the life and labours of Linnæus with the local colour so far as it may be restored from contemporary and other records, and from the author's own experiences of travel. We find Linnæus here presented to us

sometimes, as in the story of his early struggles while a student at Upsala, and again at the period of his courtship and his absence from the object of his affections, with the air of the hero of a romance rather than the subject of sober biography. It was to be expected that such periods in his life-history would properly take forcible hold of the sympathies of a lady biographer. It may be said at once that the author has carefully consulted the proper authorities—Stoever, Pulteney, Smith, Jackson, &c., and duly acknowledged her indebtedness to them; and occasionally, with more jubilation than mere complacency, her disregard for them when they fail by disagreement among themselves, or otherwise, to satisfy her. One can hardly say fairer than that. The first impression of the book is unfavourable; in fact, it is felt that one cannot take it seriously. That it is not meant to be so taken altogether is manifest from such statements as that "by Hök rather than by Krök Carl's name was enrolled," &c. Apart from this kind of thing, however, there is often a temptation to smile at the wrong places. The author's observations on men and things in general are frequent and fearless. For example, in discussing an architectural matter she wonders at "the usually perceptive Fergusson" not recognising the significance of a feature well known to ordinary writers on Swedish architecture. Doubtless Mr. Fergusson would have valued this gentle way of describing him, so unlike the manner of those "cock-a-hoop and overbearing young scientific men" whom the author prophesies will be "charming at forty." There is a superabundance too of quotations in the book beyond the legitimate quotations from Linnæus himself and writers of his life. Indeed, to put it in the fashion of that biographer of Linnæus whom she calls "dear old Stoever," she can rarely keep her course clear of the Scylla of her own wisdom and the Charybdis of miscellaneous quotations from Carlyle and a great variety of other writers.

The ancestors of Linnæus, his life from boyhood and school-days, throughout his University career, are discussed with picturesque descriptions of the land and the people. We then come to his *début* in the treatise on the sexes of plants, in answer to Wahlin's "Nuptiæ Arborum Dissertatio." "This," we are told, "was a blooming new idea in the summer of 1730." He is then followed throughout his travels in Lapland, Dalecarlia, his fruitful visits to Holland, England, and France, his return to Sweden and career at home, including his subsequent journeys—to the end. The following passage will give a fair illustration of the style of the more extravagant passages in the book:—

"Linnæus broke down: he dropped like the begonia at the last—the flower that had always interested him so much, with its male and female flowers so graceful and so differing. The common begonia, that most interesting and elegant of plants, is jointed all the way up, and as it withers the joints become separated and in shape like the bones of the human limbs; they drop apart, and fall like dry bones upon the ground. This family is a botanical study in itself. 'Many begonias are remarkable for the production of adventitious buds,' &c.

In spite of this amazing style it must be owned that apart from such small matters as spelling Linnean, in the name of the Society, "Linnæan," the book is wonderfully correct in the main features of the life of Linnæus, and once the reader is accustomed to absurdities such as we have noted, it becomes a readable narrative. The worst of it is that one is hurried off to somewhere between China and Peru for an illustration of some sober fact, and this without sufficient warning to the unwary reader.

Sur une nouvelle Méthode de faire des Mesures absolues de la Chaleur rayonnante. Par Knut Angström. (Upsal: Berling, 1886.)

IN this quarto pamphlet of seventeen pages (with a plate) the author claims to give a simple method for determin-

ing the absolute measure of radiant heat, and describes a self-registering apparatus which gives the intensity of solar radiation at any instant, as also the total heat received by the absorbing surface in a given time. Two circular copper disks are alternately exposed to the source of heat and screened from it, and a thermo-electric couple and galvanometer give the differences of their temperature. The method consists in finding accurately the average time for the temperature-difference of the two plates to be a given (small) amount, positive and negative in turns. By the aid of Newton's law of cooling, which is applicable in this case, the author proves that the intensity of the radiation is proportional to the temperature-difference directly, and the time inversely, and that it is quite independent of the constant of cooling. To verify the last conclusion, the author measured with an instrument of this kind the radiation of a constant source of heat under varying conditions of cooling, and he found that the influence of cooling was completely eliminated.

In the construction of the self-registering actinometer founded on this principle, the absorbing surfaces are those of a differential thermometer, and the temperature-differences are marked by the movement of a thread of mercury in the communicating glass tube. When the thread has moved a certain distance, corresponding to known temperature-difference in the two bulbs, an electric circuit is completed, and an electro-magnet turns the instrument through 180°, thus reversing the positions of the screened and unshielded bulbs. By the usual clock-driven pencil and revolving cylinder, a curve is drawn of which the abscissa is proportional to the time, and the ordinate to the number of turns which the instrument has made in the time. It is then shown that at any instant the intensity of the radiation is proportional to the tangent of the angle which the curve makes with the axis of abscissæ, and that the total heat received in a given time is proportional to the difference of the ordinates corresponding to the beginning and end of the time. The constants by which these variables are to be multiplied must be found by comparison with an absolute instrument like that already mentioned, and the necessity for this comparison may prove an obstacle to the general use of the instrument. Notwithstanding this drawback, the author claims for his invention that it gives results in accordance with those of the absolute instrument, and that it works as satisfactorily on stormy days as on calm ones. There is no doubt that the instrument is deserving of a fair trial, and a comparison of the results obtained from it and from some other recent forms of actinometer would be of great value.

The paper is carefully written and printed, and we have noticed only two unimportant slips: one on p. 9, last line but one, where 40°0 should be 41°0; and another on p. 16 line 9, where *plus* should be *moins*. T. H. C.

LETTERS TO THE EDITOR

- [The Editor does not hold himself responsible for opinions expressed by his correspondents. Neither can he undertake return, or to correspond with the writers of, rejected manuscripts. No notice is taken of anonymous communications.]
- [The Editor urgently requests correspondents to keep their letters as short as possible. The pressure on his space is so great that it is impossible otherwise to insure the appearance even of communications containing interesting and novel facts.]

Vitality and its Definition

WHILE warmly congratulating Prof. Judd upon the ability with which he has brought "out into clear relief the analogie between the science dealing with the mineral kingdom and that concerned with the animal and vegetable kingdoms," I but think he has a little understated the difference between organic and inorganic matter. As this has arisen from a mis-conception of Mr. Spencer's definition of life—a

which has previously come before my notice in cases where other minds have looked at this same question—I venture to think you will allow me a few lines to show from what it arises, in the hope of expounding a subject which, popularly understood, must undoubtedly appear a little complex.

If, instead of taking the "concrete equivalent" of the definition, which the Professor has taken, though it is only used in the original "for our present purpose," we take "the broadest and most complete definition of life," . . . "the continuous adjustment of internal relations to external relations" ("Principles of Biology," vol. i. p. 80), we shall find that the changes undergone by minerals, even the physiological changes, will not obviously come within it; for it appears to me that, in the illustrations named in last week's NATURE, the minerals only display a continuous adjustment of internal changes to external changes. A change in the incident forces produces a change in the internal molecular arrangement of the mineral; a further change in the forces is followed by a further molecular, or molar, rearrangement in the mineral, and so on. There is no *anticipatory*, or *induced*, change—this is the point—in the mineral, which will correspond with the change which usually is connected with, and is sequent upon, the first environmental change, as is the case with living organisms. A quotation from the "Principles of Biology" (vol. i. p. 79) in conclusion will, I hope, now make my meaning clear. "If a creature's rate of assimilation is increased in consequence of a decrease of temperature in the environment; it is that the relation between the food consumed and heat produced, is so re-adjusted by multiplying both its members, that the altered relation in the surrounding medium between the quantity of heat absorbed from, and radiated to, bodies of a given temperature, is counterbalanced. If a sound or a scent wafted to it on the breeze, prompts the stag to dart away from the deer-stalker; it is that there exists in its neighbourhood a relation between a certain sensible property and certain actions dangerous to the stag, while in its organism there exists an adapted relation between the impression this sensible property produces, and the actions by which danger is escaped." The importance attaching to the word *relation* in this quotation has led me to emphasise it by italics.

Churchfield, Edgbaston

F. HOWARD COLLINS

Oldhamia

PROF. SOLLAS'S ingenious suggestion as to the origin of *Oldhamia* (NATURE, p. 515; Proc. R.D.S. p. 355) undoubtedly deserves very careful consideration; but it appears to me to leave some serious difficulties unexplained. For instance, the following occur to me after reading his paper and after examining two very fine specimens—one of *O. antiqua*, the other of *O. radiata*—recently placed in my hands by Mr. R. H. Scott, F.R.S.:—(1) The "puckerings," which are supposed to simulate the organism, are more definite in their boundaries than is usually the case with the ridgy or wavy "rucking up" which often occurs in phyllites as a first stage in the production of *Ausweichungsschivage*. (2) While I can trace down into the mass of the slate a certain puckering, I am at present unable to connect it with the *Oldhamia* visible on the upper surface. (3) As Prof. Sollas himself remarks, it is difficult to account for the peculiar branching form of *Oldhamia*. As it happens, during the last two or three years I have seen many examples of puckered phyllites, but never met with anything like *Oldhamia*. This difficulty in the case of *O. antiqua* seems to me almost insuperable. (4) In some cases I can detect two sets of markings crossing one another, so that the surface of the stone shows a reticulate structure, one set of lines being less definite than the other. This looks very much as if one branch of an organism were lying on the top of another; but I cannot account for it by mechanical movements alone. (5) The constancy of character in the markings is also a difficulty. One would expect every stage of development from the least to the most imitative. Now, though the *Oldhamia* is often indistinct, it certainly seems to me more like bad preservation than imperfect development of a structure.

Of course I do not in the least question the accuracy of the observations made by Mr. Teall and Prof. Sollas on the structure of the Bray Head rock; I only doubt whether the relation of this to *Oldhamia* can be regarded as proved. However, I am having some slides prepared from the above-named specimens, and hope that they may help in solving my difficulties.

23 Denning Road, N.W., April 5

T. G. BONNEY

Disappearance of Bishop's Ring in Colorado

THE reddish ring about the sun first distinctly appeared here (at the base of Pike's Peak) on November 22, 1883. For several days before that date, a faint discoloration of the region about the sun had attracted my attention. This gradually grew more intense, and, on the day mentioned, became unmistakable. The subsequent history of Bishop's ring as seen at this place is, in brief, as follows:—

The colour was most intense during the winter of 1883-84, and diminished in brightness from that time until its disappearance. At first it was visible almost all the time. Later, it appeared only at the time of cold storms, which were accompanied by great vertical movement of the air, or when, for any reason, the clouds reached to a great height. It was, on the average, brighter during the winters than in the summers; also, it was brighter when the sun was near the horizon. Many times in cold weather there has been not a trace of the ring, although the air was so clear that peaks a hundred miles distant were distinctly visible from the heights behind this city. At other times the ring has been very bright when the air was so hazy that the mountains only ten miles away were hardly visible. During the later months of 1885 it was invisible most of the time, but suddenly flamed out in wonderful intensity at the time of the great norther of January 9-11, 1886. Then for about two months it frequently appeared in the morning, or towards evening. During the warm months of 1886 it was not seen. On October 15 it appeared distinctly. About a week later it appeared very faintly a few times, and since then I have not been able to see a trace of it. My observations have been made at elevations of from 6000 to about 13,000 feet, and there was but little apparent difference in intensity at the different elevations. It is well known that the atmosphere here is, in general, very dry and transparent.

The diffraction-ring was often more coppery, almost rosy, in tint at the time of the northers, and in the thickening haze in the upper air preparatory to hailstorms. The great intensity of the colour at such times, and its peculiar tint, and that, too, irrespective of the amount of haze in the lower atmosphere, makes it probable that the ring was in part due to diffraction on ice-particles. If so, the ice-particles may themselves have been due to precipitation on dust-particles. The fact that no diffraction-ring has been seen around the sun during the past winter is not conclusive, for we have had no great northers, the season being unusually mild. But the disappearance of Bishop's ring for so long a time makes it certain that, even if there can be a circum-solar glow due to diffraction on ice-particles, yet the proper conditions for such a ring are realised only rarely, except when there is a great amount of volcanic dust in the air.

Colorado College, Colorado Springs

G. H. STONE

Iridescent Clouds

SEVERAL brilliant displays of iridescent clouds have appeared here during the past winter. One, on January 19, lasted for more than two hours during a "Chinook" wind. A mass of closely-connected cirro-cumulus clouds formed at a great elevation directly over the eastern base of the Rocky Mountains, and thence extended eastward as far as the eye could reach. The western sky was clear. As the clouds drifted slowly eastward, new clouds formed along their western border. The western limit of the clouds was for several hours nearly stationary, then slowly advanced westward opposite the direction of cloud-motion. Along the western border of the clouds were many projecting tongues of cloud. At one time I counted seven complete spectra at the thinner parts of the clouds—all showing bands of red, green, and violet. There were also about twenty-five spectra showing only one or two of the colours. The larger of these iridescent spots were about 10° in diameter, and they varied in distance from 5° to more than 45° from the sun. Their tints were intensely brilliant. There were also great numbers of minute iridescent spots where the colours were in great confusion—a phenomenon which is very common here. They sometimes are so numerous as to simulate Bishop's ring.

Colorado Springs, Colorado

G. H. STONE

A Claim of Priority

IN connexion with the letter of M. Ventosa headed as above in your issue of March 31 (p. 513), I should be glad if you would let me refer to a note which was appended to my paper

on "Continuous Calculating Machines," in the Philosophical Transactions of the Royal Society, part ii., 1885.

This note, whilst giving due priority to M. Ventosa in the matter of one of the two features of the sphere and roller integrator, described in the above paper, a feature at which I need scarcely say I arrived quite independently, points to the fact that this forms but a part of the integrator in question. When combined with the other portion, that integrator is a calculating machine in the widest sense of the term. I have shown that in addition to giving the value of

$$\int y dx,$$

where y is any linear function of x , other varieties of the mechanism obtain the value of such expressions as

$$\int F_1(x)F_2(x) \dots F_n(x) dx,$$

and

$$\iint \phi(x, y) dy dx,$$

and also by a converse process give approximately the value at any instant of R where

$$R = \frac{dy}{dx}.$$

I had not before to day seen the paper of Mr. F. J. Smith in the *Phil. Mag.* (August 1886), referred to by M. Ventosa. On pp. 381 and 382 of my paper above alluded to will be found a description of an integrator which is practically identical with that of Mr. Smith, as I have no doubt he will admit when he reads that description. With that integrator *hollow* brass balls were employed for the very purpose suggested by Mr. Smith. The instrument was, however, abandoned in favour of more convenient forms, one of which was actually employed by that gentleman upon his "ergometer" at the Inventions Exhibition, together with some very ingenious integrators of his own design. There is, I would say, one point of difference between the integrator described by Mr. Smith, and that by myself. The movable arm in the former appears to be guided by a pin in a straight slot. Now in the "sine" form, of which this integrator is an example, this pin should move in the arc of a circle, and it would be interesting to know if approximately correct results have been obtained with what is in some respects a more convenient practical device.

H. S. HELE SHAW

University College, Liverpool, April 9

The Vitality of Mummy Seeds

I READ with much surprise in NATURE of March 31 (in Prof. Judd's defence of his statement as to the longevity of seeds) that "competent botanists have cited the case of the germination of seeds taken from ancient Egyptian tombs as authentic." Many experiments have been made as to the length of time seeds may retain their power of germinating, by Robert Brown, Henslow, and others, with interesting results as to the longevity of some; but my impression is, and I venture to make it public, that competent botanists have universally condemned as utterly worthless the evidence given in support of alleged instances of the germination of mummy seeds. No scientifically responsible person has, so far as I am aware, put the fact on record. In these circumstances, therefore, the results of the successful experiments referred to farther on by Prof. Judd as having recently been made, possess the greatest interest, and botanists will look forward eagerly to the details which it is to be hoped will soon be made public. Hitherto the fruitful source of error has been the deception at the outset of the credulous experimenter by the Arab. In fact, the mummy wheat of one well-known traveller grew up in the form of *oats*—a plant not cultivated by the ancient Egyptians, but now grown in the land they inhabited—though this did not shake his faith in the genuine source of his supply. In the present case, however, the statement made in faith by so high an authority as Prof. Judd leads us to anticipate that the undertaking has been hedged in with all the safeguards demanded by a pure cultivation of undoubtedly genuine material.

GEORGE MURRAY

7 Onslow Place, South Kensington, S.W., April 5

Solar Halos

In the forenoon of March 6 the sun was surrounded by a series of halos of the form shown in the diagram. The side of each arc, marked with a wavy or saw-toothed outline, was red, and the opposite edge blue; but no colour at all was visible in the horizontal belt nor in the farthest-out halo (H_2). This sketch shows the appearance at about 9 a.m.; as the sun rose higher, the horizontal belt got a curve upwards at each side—i.e. it continued to be parallel to the horizon—and was prolonged inside H_1 till it almost touched the sun. The two mock-suns

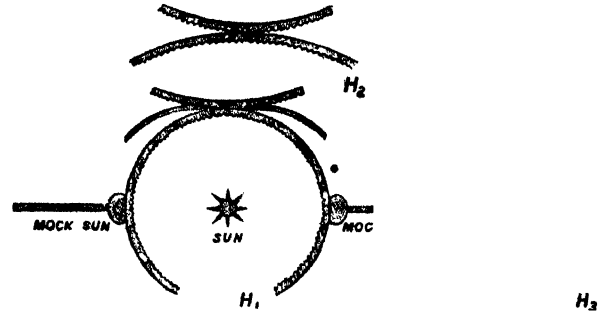

were distinctly on the outside of H_1 , and were coloured red next the sun, and blue outside, their reds about coinciding with the blue of H_1 . The following are some of the measurements:—

Sun to western mock-sun	23 46
„ eastern „	23 42
H_2 (two measurements)	{ 79 56
	{ 81 23

The halo H_2 has, I believe, been very seldom seen, and there are only three estimates of its radius on record: two of these make it 90° , and the third makes it 85° to 90° . It will be seen that our measurements—both about 81° —are considerably less than any of the former ones.

R. T. OMOND

Ben Nevis Observatory

On the Character of the Beds of Chert in the Carboniferous Limestone of Yorkshire

It may be of interest to geologists to know that I have lately ascertained that the beds of chert which occur in the limestones of the Yoredale series of Yorkshire are distinctly of organic origin, and that, in fact, they are composed of the heterogeneously-mingled spicules of disintegrated siliceous sponges. The beds vary from 3 inches to 18 feet in thickness, and the limestones in which they are interbedded are nearly exclusively composed of the broken-up remains of crinoids, thus showing a well-marked alternation of periods in which sponges and crinoids succeeded each other. The spicules can only be studied in thin microscopic sections of the rock; in some cases they are very perfectly preserved and their axial canals are clearly shown; in other examples only very faint outlines can be made out. They appear to belong for the most part to the same group of Hexactinellid sponges as the recent genus *Hyalonema*, but Monactinellid spicules, like those of the existing genus *Reniera*, are also very numerous in some of the beds. Such an enormous accumulation of the debris of siliceous sponges proves that these organisms were as abundant in the Carboniferous as in the Cretaceous seas.

The beds of chert referred to are exposed near Harrogate, and at Richmond, Yorkshire, and they are remarkably developed at Arkendale, about fourteen miles above Richmond. I am indebted to Mr. J. G. Goodchild, of the Geological Survey, for directing my attention to this last-named locality. Owing to their resistant character, fragments of the beds are also widely distributed in the boulder-clays to the south of their outcrops, and I have met with them in these clays near York.

It has been known for some time that the remains of siliceous sponges are of common occurrence in the Carboniferous chert beds of Ayrshire and of certain parts of Ireland, but they do not appear to have been noticed hitherto in the corresponding beds of Yorkshire. I hope shortly to give a more detailed description of their principal characters.

GEORGE J. HINDS

Croydon, April 2

The Zirconia Oxy-hydrogen Light

I HAVE been interested in the brief note you gave upon Prof. Linnemann's zirconia light, and as I have for several years been endeavouring to obtain the alleged advantages of this earth as a luminant, and with very different comparative results, if you will allow me briefly to state these, it may possibly be of service. Zirconia has been stated by Du Motay to be the "most luminous" as well as most refractory of earths, and if it indeed be so, its advantages would be very great. I have made many fruitless attempts to procure one of Du Motay's own pencils as prepared and sold many years ago, but none seem now obtainable; if any reader possesses, and can lend me, one for trial (all the better if he can share in or witness it), I shall be exceedingly obliged, in the interests of improved optical projection.

With the assistance of Mr. Chadwick, of Manchester, Mr. H. G. Madan, of Eton College, and a third gentleman, of Leeds, my own experiments have been made with small cylinders about 9 millimetres diameter, compressed from three different samples of zirconia. The incandescent surface was the flat end of such a cylinder.

The first sample was sold as "pure" by Hopkin and Williams, and many cylinders were tried of it. It was very largely contaminated with soda, which might in time have volatilised; but a more hopeless impurity was the large quantity of silica, which quickly fused into a thick yellow glaze. The light was most inferior, but the reddish tinge presently noticed was not conspicuous in this sample, which was worthless as an illuminant.

The second sample was prepared by my Leeds colleague, largely by blow-pipe processes. It stood the flame much better, and contained far less soda, which rapidly lessened under the flame. It contained, however, considerable silica, which could be observed through dark glasses to seethe and melt into ridges. When this took place, the light rapidly diminished, and was never near that of a lime cylinder, though at one time respectable. Also, fissures appeared in the face. But the peculiar physical properties of the earth were conspicuous, and chiefly its extraordinary non-conducting power. With a powerful jet (capable of yielding 700 candle-power on a lime cylinder) playing upon the small surface described, the full incandescence barely reached the edge of the disk, and the bright portion only extended about $2\frac{1}{2}$ millimetres up the cylinder, bounded by a definite line. At this line a crack all round began to appear, which gradually deepened, until at length the incandescent layer separated and fell off. The glow was of a most pronounced reddish character.

The third sample was procured by Mr. Madan from Herr Schuchardt, of Görlitz; it is stated to be prepared "especially" for the oxy-hydrogen light, and is sold at the rate of 18 marks for 10 grammes, of which about half is required to form a cylinder. This sample shrank enormously when heated, both in powder and when first compressed—showing that it was very largely hydrated—and had to be re-crushed and compressed again before anything could be done with it. It was much more free from silica, and half an hour of a powerful jet only produced a slight glaze or polish on the face. The reddish glow was very prominent in it also. The most serious fault, or difficulty, was that the circular crack formed and deepened much more rapidly than in the preceding, and the layer separated in less than half an hour. I fear this unequal shrinkage and its effects will alone be a great obstacle, unless—which I much regret we did not test experimentally—the thin layer itself, as detached, should prove sufficient, held in a platinum loop. Possibly it might crack no further.

But the light was again *poor* compared with a good lime. Mr. Madan had the plug crushed and re-made, and tested the light photometrically in his own laboratory at Eton. Compared with a good quarry lime, the zirconia taken as unity was only 1 : 2.88, with the same jet. That is a very startling difference. It is true that the incandescent surfaces are probably in about the same proportion, so that the brilliancy *per unit of surface* may be about the same. But then the incandescent surface of the zirconia cannot be increased, owing to the non-conducting properties already alluded to; so that the fact remains, so far as illumination is concerned, that we can only get with zirconia, or with such samples as I was able to obtain, about *one-third* of the light we can get from a good lime.

This result is so different from that stated by Prof. Linnemann, and years ago by Du Motay, that some explanation seems necessary. I think it lies in the fact that Continental operators do

not use nearly such powerful jets as are often used in England, where we obtain 600 to 700 candle-power. Several Continental jets have come into my hands, none of which would give a good light, as a first-class "magic-lantern" lecturer understands it, *i.e.* sufficient to illuminate a disk 25 feet in diameter. Prof. Linnemann's own jet, of which I have seen the drawings, though it has the useful property of condensing the heat into a very small spot, is only a form of the "blow-through," as usually called; and when he remarks upon the "unsteadiness" of the mixing jet, he shows that he is not practically acquainted with it in a good form. Again, I was given by Mr. W. G. Lettsom some time ago a sample of an "improved" composition sold in Germany instead of limes, and stated to be "much better" for oxy-hydrogen purposes; my jets simply burnt holes clean through it (a prism of about 18 mm. diameter) in less than a minute. Now it is noticeable that with a blow-through jet, of about 200 candle-power, the zirconia does compare much more favourably, and is about as bright as the lime.

I write this, however, with a last hope of getting "more light" on the subject. If we could only get the whole light of a good lime-cylinder into the small disk (which is all that can be heated) of zirconia, the advantage would be very great: the parallel or other beam from the lantern from such a radiant is *as sharp* as from an arc light, and every Professor knows what that means. 700 candle-power without trouble—who does not long for it? It will be observed that each of the three samples described behaved differently, and it is in this fact lies my chief hope of any success yet; otherwise it is the decided opinion of all who have shared in these experiments, that the vaunted zirconia light is a sheer delusion. If any reader of these columns knows of purer samples to be procured commercially (I know Draper's process, but am no practical chemist, and have neither time nor means to prepare samples myself); or can tell me if the peculiar *red glow* noticed is characteristic of the earth itself or of some impurity; or has tested lanthana or any other of the more refractory earths; or can in any way assist me in what is, in its way, a matter of some importance to the science lecture-room, I shall feel much obliged for any communication from him, either here, or to

LEWIS WRIGHT

7 Beaumont Road, Hornsey Rise, N.

The Production of Newton's Rings by Plane Soap-Films

LORD RAYLEIGH, in his recent lecture at the Royal Institution on "The Colours of Thin Plates," introduced Sir D. Brewster's experiment, in which circular rings instead of the usual straight bands are produced in a vertical soap-film by causing a jet of air to impinge very obliquely upon the film near its edge. The particles are thus thrown into a vortex motion, and the centrifugal tendency causes the film to become *thinner* at the centre than at the edge, so as to produce very fair rings of colour.

Perhaps it may be worth mentioning that the same effect may be produced with greater regularity and less risk to the film, by giving the ring to which it is attached a rapid movement of rotation in its own plane. A shallow brass cup, about 8 or 9 cm. in diameter, the edge of which is turned inwards and rounded so as to give it the following section, is mounted on a horizontal spindle so that it can be turned rapidly in a vertical plane (any ordinary smooth-running multiplying-wheel arrangement will answer, but a small electromotor is by far the most convenient). The edge of the cup is just dipped below the surface of the soap-solution, and then the socket at the back is fitted on the spindle and rotation commenced. At first the straight horizontal bands of colour maintain their form and position, for the reason which Lord Rayleigh well explained; but, as the speed increases, the adhesion of the film to the edge of the cup, and the cohesion of its particles, cause it to take up gradually the motion of the cup; and, as the mass accumulates at the circumference, very perfect circular rings are formed, which can be projected with brilliancy on a screen by the lime-light.

H. G. MADAN

Eton College

Barnard's Second Comet

THERE would appear to be some danger that the observation of the above comet may be relinquished rather prematurely, as

it is still sufficiently bright for observation when viewed with our larger telescopes; and, as far as I am aware, there are no published ephemerides later than March 27. To remedy this want, I subjoin places calculated from the elements of Dr. Palisa for Greenwich mean midnight for the period during which the moon will be absent.

	R.A.	Decl.	Log
	h. m. s.		
April 13 ...	2 52 34 ...	+36 54'6 ...	0'0183
" 15 ...	2 51 2 ...	+37 3'2 ...	0'0222
" 17 ...	2 49 36 ...	+37 12'3 ...	0'0265
" 19 ...	2 48 12 ...	+37 20'6 ...	0'0311
" 21 ...	2 46 52 ...	+37 28'6 ...	0'0360
" 23 ...	2 45 35 ...	+37 36'4 ...	0'0412

JOHN I. PLUMMER

Orwell Park Observatory, April 11

Sunspots

IN the summary in regard to solar activity in 1886, published in NATURE for March 10, p. 445, it is stated that, during the period from October 31 to December 12, "on six days only out of the forty-two could there be discovered on the sun any trace even of a spot, and on those days only one tiny spot could be seen." As observed in this locality, there were formed, in the midst of the faculæ which came into view on November 14, one spot on November 15 and two spots on November 16; all having disappeared on November 18, when observation again became possible. On December 8 the first of a group of spots which made a complete transit across the sun's surface appeared. On December 9 this group consisted of three spots, which persisted until the 13th at least, gradually increasing in size. A period of sunspot minimum is best adapted in certain regards to the study of the relations of solar outbursts to magnetic and auroral phenomena; hence precision at such times, in reference to details of the character here indicated, is not unimportant.

Lyons, N.Y., March 30

M. A. VEEDER

Ozone

MY attention has been drawn to a letter in your issue of January 13 (p. 248), respecting the production of ozonized air for respiration in pulmonary complaints. I beg to inform "W. H." that there is at present no convenient electrical apparatus devised for use in a room, that would electrify the air with sufficient power to be of much service. A simple plan for obtaining ozone in small quantities is to mix very gradually three parts of strong sulphuric acid with two parts of permanganate of potash in a jam-pot, and place the vessel under the bed. Ozone will be given off from this mixture for some weeks.

I should be glad to hear the experiences of "W. H." inhaling ozonized air "just sensible to the smell," as I am of opinion that this strength of ozone is rather too great.

Your correspondent is misled in supposing that the Engadine hotels possess appliances for ozonizing the air of corridors, &c. It is only the Maloja Kursaal which has adopted my device for this purpose. The electric current used is taken off from one of the dynamos used for lighting. A short description of the plan is given in the third edition of my "Alpine Winter," p. 84.

Upper Engadine

A. TUCKER WISE

Electrical Discharges in the Doldrums

I QUITE agree with the Hon. Ralph Abercromby as to the continuous electrical discharges in the doldrums; so is there a continuous discharge of rain. I do not, however, agree with him in thinking that the electrical discharges are in any way directly connected with earth-currents. I should say they are due to electrical discharges on the top of the shower clouds, unaccompanied by thunder. It would be interesting to know if travellers in the centres of Africa and South America have observed this phenomenon there.

DAVID WILSON-BARKER

Green Light at Sunrise and Sunset

MR. R. T. OMOND, of the Ben Nevis Observatory, in NATURE of February 24, p. 391, asks whether the cause of the

green colour at sunset at sea is the sun shining through the water? This cannot be the cause, for I have many times observed this colour at sunrise behind the mountains Madoni or Copo Zaferano, which, from the Observatory, appear higher on the sea horizon than the sun's disk. That is to say, the phenomenon occurs when, for the observer, the sun is entirely above the marine horizon, and no part of the disk can shine through the water.

A. RICCO

Palermo Observatory

[This is a well known and obvious effect of atmospheric refraction.—ED.]

A Sparrow chasing Pigeons

"E. A. C." inquires in NATURE of last week (p. 536), whether any of your readers have observed the sparrow chasing pigeons. This habit of the sparrow is very common; I have myself often observed it, and I apprehend that few who keep pigeons have not frequently seen such attacks. The pugnacity of the sparrow did not appear to me to be the result of any previous quarrel with the pigeon, as I never saw the former attack the latter except on the wing, and always from underneath.

Chirbury, Beckenham, Kent, April 12 J. JENNER WEIR

A Question for Chemists

Is it known that a mixture of glycerine and permanganate of potassium will take fire spontaneously immediately after being mixed? If so, I should be glad of any reference to the fact.

Bradford

WM. WEST

THE PARIS ASTRONOMICAL CONGRESS

THE International Congress called together by the French Government to take steps to obtain a photographic chart of the heavens was opened on Saturday at the Observatory of Paris, and, from the information which has reached us so far, it would seem that its labours are likely to have a result of the highest importance for the science of this and succeeding centuries. The following Directors of Observatories are already in Paris, or are expected: if half of them really come, there will be such a meeting of astronomers as has rarely been seen:—

Baillaud, Toulouse Observ- atory	Perry, Stonyhurst
Bakhuyzen, Leiden	Peters, Clinton (U.S.A.)
Beuf, La Plata	Pujazon, San Fernando
Christie, Greenwich	Rayet, Bordeaux
Cruls, Rio de Janeiro	Russell, Sydney
Donner, Helsingfors	Schoenfeld, Bonn
Dunér, Lund	Struve, Pulkowa
Folie, Brussels	Tacchini, Rome
Gill, Cape Town	Thiele, Copenhagen
Gylden, Stockholm	Trépied, Algiers
Krueger, Kiel	Vogel, Potsdam
Oom, Lisbon	Weiss, Vienna

Besides these Directors of Observatories, and of course all the astronomical members of the Institute, there are other astronomers, such as Messrs. Common and Roberts from our own country, and Messrs. Lohse (from Germany), Winterhalter (from Washington), and Hasselberg (from Pulkowa), whose presence is most important.

The French Government, the Academy of Sciences (with Dr. Janssen as President), and Admiral Mouchez (the Director of the National Observatory of Paris), seem to have done all in their power to facilitate the labours, and even to provide for the comfort, of the various delegates and others representing the various nationalities; and at the opening ceremony the manner in which the Institute and Government are doing all they can was evidenced by the fact that the address which was delivered by M. Bertrand, the eminent mathematician, on behalf of

the Academy of Sciences, was followed by another, made by M. Flourens, the Minister of Foreign Affairs.

They certainly manage these things better in France! Fancy a scientific meeting at Greenwich Observatory, addressed by the head of the English Foreign Office!

What M. Flourens said had better be given in his own words:—

Messieurs,—

J'ai l'honneur de vous souhaiter la bienvenue au nom de la France, qui vous offre ici sa cordiale hospitalité.

Je me félicite que cette mission me soit échue de vous complimenter au nom du gouvernement de la République, de vous remercier d'avoir accepté les invitations qui vous ont été adressées par l'éminent et sympathique directeur de notre Observatoire.

C'est une grande œuvre que celle que vous allez entreprendre, et, grâce aux lumières que vous nous apportez de tous les points du globe, mener à bonne fin. Dans la poursuite de cette œuvre, vous aurez, je n'en doute pas, l'appui de tous les gouvernements, qui sont animés aujourd'hui d'une noble émulation pour le développement de la science. En tout cas, le concours du gouvernement de la République française, au nom de laquelle j'ai l'honneur de parler, vous est dès à présent acquis.

Vous allez, dans une féconde et cordiale entente, jeter les bases de l'exécution d'une carte du ciel dont la précision dépassera de beaucoup non seulement tout ce que l'on avait réalisé, mais encore tout ce que l'on avait osé rêver jusqu'à ce jour. Par une merveilleuse application de la photographie, de cet art si riche en résultats imprévus, vous allez diriger l'œil humain dans des profondeurs où, à l'aide des plus puissants télescopes, on n'avait pas cru possible de le faire pénétrer. Le nombre des étoiles inconnues jusqu'ici, dont l'existence sera ainsi révélée, est incalculable.

Ce sera pour votre nom, messieurs, une gloire éternelle d'avoir apporté votre précieuse collaboration à l'inauguration de cette grande entreprise, et le jour de l'ouverture de ce congrès marquera dans les annales de la science humaine.

Une ère nouvelle s'ouvre pour l'astronomie physique comme pour l'astronomie mathématique, qui vont avoir à leur disposition un moyen d'investigation, de contrôle, de précision qui étendra dans une proportion indéfinie la fécondité de leurs recherches. Vous allez écrire la première page authentique des transformations et des modifications de la matière cosmique, c'est-à-dire l'histoire de l'univers lui-même.

Je voudrais complimenter, par leurs noms et par leurs œuvres, chacun des savants illustres qui sont réunis dans cette enceinte. Mais j'abuserais des précieux et trop courts instants de notre réunion. Nos hôtes trouveront bon que je les honore tous en la personne de leur doyen, de l'illustre M. Struve, dont le nom est si sympathique à la France et dont on fêtait naguère le vingt-cinquième anniversaire comme directeur du célèbre observatoire de Poulkova.

Agréez, messieurs, avec mes vœux les plus sincères pour la réussite de vos efforts, la nouvelle assurance du concours du gouvernement de la République.

Prof. O. von Struve replied to this address in a short and impressive speech, and the Conference proceeded to elect officers.

Admiral Mouchez, the Director of the Observatory, was elected Honorary President, and Prof. O. von Struve Acting President. As Vice-Presidents, Messrs. Auwers, Christie, and Fizeau were elected; as Secretaries, Messrs. Tisserand and Bakhuyzen, assisted by Dunér and Trépiéd.

The Conference then proceeded to pass the following resolutions:—

(1) The progress realised in astronomical photography renders it absolutely necessary that the astronomers of the

present century should undertake a conjoint photographic record of the heavens.

(2) This work shall be undertaken at certain stations to be selected, and with instruments identical in all essential points.

(3) The principal objects sought to be attained shall be:—

(a) To record the general state of the heavens at the present time by obtaining data which will enable us to determine the position and brilliancy of all the stars down to a certain magnitude, to be hereafter agreed on, with the greatest precision possible; the magnitudes to be expressed according to some photographic standard to be hereafter determined.

(b) To fix upon the best means to utilise at the present time the various data furnished by photographic processes.

After these resolutions were passed, the Conference proceeded to appoint a Committee of nineteen members to consider the kind of instrument to be employed, and the lowest magnitude of star it will be necessary to register. The Committee appointed consists of the following astronomers:—MM. Auwers, Bakhuyzen, Christie, Common, Dunér, Fizeau, Gill, Paul Henry, Janssen, Kapteyn, Lœwy, Rayet, Roberts, Peters, O. von Struve, Tacchini, Thiele, Vogel, and Weiss. When this Committee has brought up its Report, the other questions will be considered by a number of Sections, to be appointed to consider and report upon them to the Conference.

Hospitality is not lacking to make the labours of the Conference as light as possible. Admiral Mouchez, who gave a *soirée* on the evening of the 19th, gives a banquet on the 24th. The astronomers are to be received by the President of the Republic, and also at the Théâtre Français by the members of the Institute, on Saturday. There is also to be a ball at the Hôtel Continental, given by Le Comité des Amis de Science.

We warmly congratulate French men of science upon the magnificent results obtained by their countrymen the Brothers Henry, which have been among the causes that have brought the Conference together. If all goes well, the work of the Conference will mark an epoch in the history of astronomy.

HOMERIC ASTRONOMY

I.

THE Homeric ideas regarding the heavenly bodies were of the simplest description. They stood, in fact, very much on the same level with those entertained by the North American Indians, when first brought into European contact. What knowledge there was in them was of that "broken" kind which (in Bacon's phrase) is made up of wonder. Fragments of observation had not even begun to be pieced in one with the other, and so fitted, ill or well, into a whole. In other words, there was no faintest dawning of a celestial science.

But surely, it may be urged, a poet is not bound to be an astronomer. Why should it be assumed that the author (or authors) of the "Iliad" and "Odyssey" possessed information co-extensive on all points with that of his fellow-countrymen? His profession was not science, but song. The argument, however, implies a reflecting backward of the present upon the past. Among unsophisticated peoples, specialists, unless in the matter of drugs or spells, do not exist. The scanty stock of gathered knowledge is held, it might be said, in common. The property of one is the property of all.

More especially of the poet. His power over his hearers depends upon his presenting vividly what they already perceive dimly. It was part of the poetical faculty of the Ithacan bard Phemius that he "knew the works of gods and men" ("Od." i. 338). His special function was to render them famous by his song. What he had heard

concerning them he repeated; adding, of his own, the marshalling skill, the vital touch, by which they were perpetuated. He was no inventor: the actual life of men, with its transfiguring traditions and baffled aspirations, was the material he had to work with. But the life of men was very different then from what it is now. It was lived in closer contact with Nature; it was simpler, more typical, consequently more susceptible of artistic treatment.

It was accordingly looked at and portrayed as a whole; and it is this very *wholeness* which is one of the principal charms of primitive poetry. An irrecoverable charm; for civilisation renders existence a labyrinth of which it too often rejects the clue. In olden times, however, its ways were comparatively straight, and its range limited. It was accordingly capable of being embraced with approximate entirety. Hence the encyclopædic character of the early epics. *Humani nihil alienum*. Whatever men thought, and knew, and did, in that morning of the world when they spontaneously arose, found a place in them.

Now, some scheme of the heavens must always accompany and guide human existence. There is literally no choice for man but to observe the movements, real or apparent, of celestial objects, and to regulate his actions by the measure of time they mete out to him. Nor had he at first any other means of directing his wanderings upon the earth save by regarding theirs in the sky. They are thus to him standards of reference and measurement as regards both the fundamental conditions of his being—time and space.

This intimate connexion, and, still more, the idealising influence of the remote and populous skies, has not been lost upon the poets in any age. It might even be possible to construct a tolerably accurate outline-sketch of the history of astronomy in Europe without travelling outside the limits of their works. But our present concern is with Homer.

To begin with his mode of reckoning time. This was by years, months, days, and hours ("Od," x. 469, xi. 294). The week of seven days was unknown to him; but in its place we find (in the "Odyssey" xix. 307) the triplicate division of the month used by Hesiod and the later Attics, implying a month of thirty, and a year of 360 days, corrected, doubtless, by some rude process of intercalation. A corresponding apportionment of the hours of night into three watches (as amongst the Jews before the Captivity), and of the hours of day into three periods or stages, prevails in both the "Iliad" and "Odyssey." The seasons of the year, too, were three—spring, summer, and winter—like those of the ancient Egyptians and of our Anglo-Saxon forefathers;¹ for the Homeric *Opora* was not, properly speaking, an autumnal season, but merely an aggravation of summer heat and drought, heralded by the rising of Sirius towards the close of July. It, in fact, strictly matched our "dog-days," the *dies caniculares* of the Romans. This rising of the dog-star is the only indication in the Homeric poems of the use of a stellar calendar such as we meet full-grown in Hesiod's "Works and Days." The same event was the harbinger of the Nile-flood to the Egyptians, serving to mark the opening of their year as well as to correct the estimates of its length.

The annual risings of stars had formerly, in the absence of more accurate means of observation, an importance they no longer possess. Mariners and husbandmen, accustomed to watch, because at the mercy of the heavens, could hardly fail no less to be struck with the successive effacements by, and re-emergences from, the solar beams, of certain well-known stars, as the sun pursued his yearly course amongst them, than to note the epochs of such events. Four stages in these periodical fluctuations of visibility were especially marked by primitive observers. The first perceptible appearance of a star in the dawn was

known as its "heliacal rising." This brief glimpse tended gradually as the star increased its seeming distance from the sun, the interval of precedence in rising lengthening by nearly four minutes each morning. At the end of close upon six months occurred its "acronychal rising," or last visible ascent from the eastern horizon after sunset. Its conspicuousness was then at the maximum, whole of the dark hours being available for its shining. To these two epochs of rising succeeded and corresponded two epochs of setting—the "cosmical" and the "heliacal." A star set cosmically when, for the first time each year, it reached the horizon long enough before break of day to be still distinguishable; it set heliacally on the last evening when its rays still detached themselves from the background of illuminated western sky, before getting finally immersed in twilight. The round began again when the star had arrived sufficiently far on the other side of the sun to show in the morning—in other words, to rise heliacally.

Wide plains and clear skies gave opportunities frequently and continually observing these successive moments in the revolving relations of sun and star which were soon found to afford a very accurate index to the changes of the seasons. By them, for the most part, Hesiod's prescriptions for navigation and agriculture are timed; and although Homer, in conformity with the nature of his subject, is less precise, he was still fully aware of the association.

His sun is a god—Helios—as yet unidentified with Apollo, who wears his solar attributes unconsciously. Helios is also known as Hyperion, "he who walks on high," and Elector, the "shining one." Voluntarily he pursues his daily course in the sky, and voluntarily he sinks to rest in the ocean-stream. Subject, however, at times to a higher compulsion. For, just after the rescue of the body of Patroclus, Here favours her Achaian clients by precipitating at a critical juncture the descent of a still unwearied and unwilling luminary ("Iliad," xviii. 239). On another occasion, however, Helios memorably asserts his independence, when, incensed at the slaughter of his sacred cattle by the self-doomed companions of Ulysses, he threatens to "descend into Hades, and shine among the dead" ("Od," xii. 383). And Zeus, in promising the required satisfaction, virtually admits his power to abdicate his office as illuminator of gods and men.

Once only, the solstice is alluded to in Homeric verse. The swineherd Eumæus, in describing the situation of his native place, the Island of Syrie, states that it is over against Ortygia (Delos), "where are the turning-places the sun" ("Od," xv. 404). The phrase probably indicates the direction in which Delos lay from Ithaca, being just so much south of east as the sun lies at rising on the shortest day of winter. To those early students of Nature the travelling to and fro of the points of sunrise and sunset, furnished the most obvious clue to the yearly revolution; so that an expression, to us somewhat condite, conveyed a direct and unmistakable meaning to hearers whose narrow acquaintance with the phenomena of the heavens was vivified by immediate personal experience of them.

Selene first takes rank as a divine personage in the Homeric hymns. No moon-goddess is recognised in the "Iliad" or "Odyssey." Nor does the orbed ruler "ambrosial night," regarded as a mere light-giver time-measurer, receive all the attention that might have been expected. A full moon is, however, represented: the other "heavenly signs" on the shield of Achi and figures somewhat superfluously in the magical passage where the Trojan watch-fires are compared to the stars in a cloudless sky:

"Even as when in heaven the stars about the moon shine clear to see, when the air is windless, at the peaks appear and the tall headlands and glades,

¹ Lewis, "Astr. of the Ancients," p. 11. Tacitus says of the Germans: "Autumni perinde nomen ac bona ignorantur" ("Germania," cap. xxvi).

from heaven breaketh open the infinite air, and all stars are seen, and the shepherd's heart is glad; even in like multitude between the ships and the streams of Xanthos appeared the watch-fires that the Trojans kindled in front of Ilios."¹

Here, as elsewhere, the simile no sooner presents itself than the poet's imagination seizes upon and develops it without overmuch regard to the illustrative fitness of its details. The multitudinous effect of a thousand fires blazing together on the plain inevitably suggested the stars. But with the stars came the complete nocturnal scene in its profound and breathless tranquillity. The "rejoicing shepherd," meantime, who was part of it, would have been ill-pleased with the darkness required for the innumerable stellar display first thought of. And since, to the untutored sense, landscape is delightful only so far as it gives promise of utility, brilliant moonlight was added, for his satisfaction and the safety of his flock, as well as for the perfecting of that scenic beauty felt to be deficient where human needs were left uncared for. Just in proportion, however, as rocks, and peaks, and wooded glens appeared distinct, the lesser lights of heaven, and with them the fundamental idea of the comparison, must have become effaced; and the poet, accordingly, as if with a misgiving that the fervour of his fancy had led him to stray from the rigid line of his purpose, volunteered the assurance that "all the stars were visible"—as, to his mind and eye, they doubtless were.

Of the "vivid planets" thrown in by Pope there is no trace in the original. Nor could there be; since Homer was totally ignorant that such a class of bodies existed. This curious fact affords (if it were needed) conclusive proof of the high antiquity of the Homeric poems. Not the faintest suspicion manifests itself in them that Hesperus, "fairest of all stars set in heaven," is but another aspect of Phosphorus, herald of light upon the earth, "the star that saffron-mantled Dawn cometh after, and spreadeth over the salt sea" ("Iliad," xxiii. 226-27). The identification is said by Diogenes Laertius to have been first made by Pythagoras; and it may at any rate be assumed with some confidence that this elementary piece of astronomical knowledge came to the Greeks from the East, with others of a like nature, in the course of the sixth or seventh century B.C. Astonishing as it seems that they should not have made the discovery for themselves, there is no evidence that they did so. Hesiod appears equally unconscious with Homer of the distinction between "fixed" and "wandering" stars. According to his genealogical information, Phosphorus, like the rest of the stellar multitude, sprang from the union of Astræus with the Dawn ("Theogony," 381), but no hint is given of any generic difference between them.

There is a single passage in the "Iliad," and a parallel one in the "Odyssey," in which the constellations are formally enumerated by name. Hephæstus, we are told, made for the son of Thetis a shield great and strong, whereon, by his exceeding skill, a multitude of objects were figured.

"There wrought he the earth, and the heavens, and the sea, and the unwearied sun, and the moon waxing to the full, and the signs every one wherewith the heavens are crowned, Pleiads, and Hyads, and Orion's might, and the Bear that men call also the Wain, her that turneth in her place, and watcheth Orion, and alone hath no part in the baths of Ocean" ("Iliad," xviii. 483-89).

The corresponding lines in the "Odyssey" occur in the course of describing Ulysses' voyage from the isle of Calypso to the land of the Phæacians. Alone, on the raft he had constructed of Ogygian pine-wood, he sat during seventeen days, "and cunningly guided the craft

with the helm; nor did sleep fall upon his eyelids, as he viewed the Pleiads and Boötes, that setteth late, and the Bear, which they likewise call the Wain, which turneth ever in one place, and keepeth watch upon Orion, and alone hath no part in the baths of Ocean" ("Odyssey," v 271-75).

The sailing-directions of the goddess were to keep the Bear always on the left—that is, to steer due east.

It is clear that one of these passages is an adaptation from the other; nor is there reason for hesitation in deciding which was the model. Independently of extrinsic evidence, the verses in the "Iliad" have the strong spontaneous ring of originality, while the Odyssean lines betray excision and interpolation. The "Hyads and Orion's might" are suppressed for the sake of introducing Boötes. Variety was doubtless aimed at in the change; and the conjecture is at least a plausible one, that the added constellation may have been known to the poet of the "Odyssey" (admitting the hypothesis of a divided authorship), though not to the poet of the "Iliad." Known, that is, in the sense that the stars comprising the figure of the celestial Husbandman had not yet, at the time and place of origin of the "Iliad," become separated from the anonymous throng circling in the "murk of night."

The constellation Boötes was invented to drive the Wain, as Arctophylax to guard the Bear, the same group in each case going by a double name. For the brightest of the stars thus designated we still preserve the appellation Arcturus (from *arktos*, bear, *ouras*, guardian), first used by Hesiod, who fixed upon its acronychal rising, sixty days after the winter solstice, as the signal for pruning the vines ("Works and Days," 564-70). It is not unlikely that the star received its name long before the constellation was thought of, forming the nucleus of a subsequently formed group. This was undoubtedly the course of events elsewhere; the Great and Little Dogs, for instance, the Twins, and the Eagle (the last with two minute companions) having been individualised as stars previous to their recognition as asterisms.

There is reason to believe that the stars enumerated in the "Iliad" and "Odyssey" constituted the whole of those known by name to the early Greeks. This view is strongly favoured by the identity of the Homeric and Hesiodic stars. It is difficult to believe that, had there been room for choice, the same list *precisely* would have been picked out for presentation in poems so widely diverse in scope and origin as the "Iliad" and "Odyssey" on the one side, and the "Works and Days" on the other. As regards the polar constellations, we have positive proof that none besides Ursa Major had been distinguished. For the statement repeated in both the Homeric epics, that the Bear *alone* was without part in the baths of Ocean, implies, not that the poet veritably ignored the unnumbered stars revolving within the circle traced out round the pole by the seven of the Plough, but that they still remained a nameless crowd, unassociated with any terrestrial object, and therefore attracting no popular observation.

The Greeks, according to a well-attested tradition, made acquaintance with the Lesser Bear through Phœnician communication, of which Thales was the medium. Hence the designation of the group as *Phoinike*. Aratus (who versified the prose of Eudoxus) has accordingly two Bears, lying (in sailors' phrase) "heads and points" on the sphere; while he expressly states that the Greeks still (about 270 B.C.) continued to steer by *Helike* (the Twister, Ursa Major), while the expert Phœnicians directed their course by the less mobile *Kynosoura* (Ursa Minor). The absence of any mention of a Pole-star seems at first sight surprising. Even the *froquois* Indians directed their wanderings from of old by the one celestial luminary of which the position remained sensibly invariable (Lafitau, "Mœurs des Sauvages Américains,"

¹ "Iliad," viii. 551-57. Mr. Andrew Lang's admirable prose-versions are employed throughout this article.

p. 240). Yet not the gods themselves, in Homer's time, were aware of such a guide. It must be remembered, however, that the axis of the earth's rotation pointed, 3800 years ago, towards a considerably different part of the heavens from that now met by its imaginary prolongation. The precession of the equinoxes has been at work in the interval, slowly but unremittingly shifting the situation of this point among the stars. Some 600 years before the Great Pyramid was built, it was marked by the close vicinity of the brightest star in the Dragon. But this in the course of ages was left behind by the onward-travelling pole, and further ages elapsed before the star at the tip of the Little Bear's tail approached its present position. Thus the entire millennium before the Christian era may count for an interregnum as regards Pole-stars. Alpha Draconis had ceased to exercise that office; Al-rucabah had not yet assumed it.

The most ancient of all the constellations is probably that which Homer distinguishes as never-setting (it then lay much nearer to the pole than it now does). In his time, as in ours, it went by two appellations—the Bear and the Wain. Homer's Bear, however, included the same seven bright stars constituting the Wain, and no more; whereas our Great Bear stretches over a sky-space of which the Wain is only a small part, three of the striding monster's far-apart paws being marked by the three pairs of stars known to the Arabs as the "gazelle's springs." How this extension came about, we can only conjecture; but there is evidence that it was fairly well established when Aratus wrote his description of the constellations. Aratus, however, copied Eudoxus, and Eudoxus used observations made—doubtless by Accad or Chaldean astrologers—above 2000 B.C.¹ We infer, then, that the Babylonian Bear was no other than the modern Ursa Major.

But the primitive asterism—the Seven Rishis of the old Hindus, the Septem Triones of the Latins, the Arktos of Homer—included no more than seven stars. And this is important as regards the origin of the name. For it is impossible to suppose a likeness to any animal suggested by the more restricted group. Scarcely the acquiescent fancy of Polonius could find it "backed like a weasel," or "very like a whale." Yet a weasel or a whale would match the figure equally well with, or better than, a bear. Probably the growing sense of incongruity between the name and the object it signified may have induced the attempt to soften it down by gathering a number of additional stars into a group presenting a distant resemblance to a four-legged monster.

The name of the Bear, this initial difficulty notwithstanding, is prehistoric and quasi-universal. It was traditional amongst the American-Indian tribes, who, however, sensible of the absurdity of attributing a conspicuous protruding tail to an animal almost destitute of such an appendage, turned the three stars composing it into three pursuing hunters.

The same constellation figures, under a divinified aspect, with the title *Otawa*, in the great Finnish epic, the "Kalevala." Now, although there is no certainty as to the original meaning of this word, which has no longer a current application to any terrestrial object, it is impossible not to be struck with its resemblance to the Iroquois term *Okowari*, signifying "bear," both zoologically and astronomically (Lafitau, *op. cit.*, p. 236). The inference seems justified that *Otawa* held the same two meanings, and that the Finns knew the great northern constellation by the name of the old Teutonic king of beasts.

It was (as we have seen) similarly designated on the banks of the Euphrates; and a celestial she-bear, doubtfully referred to in the Rig-Veda, becomes the starting-point of an explanatory legend in the Rāmāyana (De Gubernatis, "Zoological Mythology," vol. ii. p. 109).

¹ According to Mr. Proctor's calculation. See R. Brown, "Eridanus: River and Constellation," p. 3.

Thus, circling the globe from the valley of the Ganges to the great lakes of the New World, we find ourselves confronted with the same sign in the northern skies, the relic of some primæval association of ideas, long since extinct.

Extinct even in Homer's time. For the myth of Callisto (first recorded in a lost work by Hesiod) was a subsequent invention—an effect, not a cause—a mere embroidery of Hellenic fancy over a linguistic fact, the true origin of which was lost in the mists of antiquity.

There is, on the other hand, no difficulty in understanding how the Seven Stars obtained their second title of the Wain, or Plough, or Bier. Here we have a plain case of imitative name-giving—a suggestion by resemblance almost as direct as that which established in our skies a Triangle and a Northern Crown. Curiously enough, the individual appellations still current for the stars of the Plough, include a reminiscence of each system of nomenclature—the legendary and the imitative. The brightest of the seven, a Ursa Majoris, the Pointer nearest the Pole, is designated *Dubhe*, signifying, in Arabic, "bear"; while the title *Benetnasch*—equivalent to *Bendten-Nasch*, "daughters of the bier"—of the furthest star in the plough-handle, perpetuates the lugubrious fancy, native in Arabia, by which the group figures as a corpse attended by three mourners. A. M. CLERKE

(To be continued.)

RAINBAND OBSERVATIONS AT THE BEN NEVIS OBSERVATORY

RAINBAND spectroscopy is one of the extra subjects taken up at the Ben Nevis Observatory, along with the usual meteorological routine. At every hour, when there is sufficient light, the intensity of the rainband is observed and recorded, and now, the mean daily rainband forms one of the items in the Ben Nevis weather report in the daily newspapers. The scale in use is practically the same as that used by Dr. Mill, of the Granton Marine Station, and described by him in a paper to the Royal Society of Edinburgh (Proc. R.S.E., 1882-84). This scale is in the spectrum itself—a great convenience—being the Fraunhofer lines E, δ , and F of the solar spectrum. After a preliminary set of observations had been made, in various types of weather, for the purpose of determining the relative intensity of these lines, a numerical value was given to each, namely, to E, 2; to δ , 4; and to F, 7. After a little practice, it is quite easy to estimate the values less than 2, which often occur, and the values above 7, which very seldom occur. With this scale, the intensity or darkness of the rainband and D line taken together is compared, and the numerical value of its scale-equivalent entered in the register. The instrument used is one of Hilger's rainband pocket spectrosopes, and the part of the sky always observed is between 30° and 40° above the south-western horizon.

The results obtained in 1885 were communicated to the Scottish Meteorological Society, and are published in their Journal for 1886 (see NATURE, vol. xxxiii. p. 622). In 1886, over 3000 observations were made, and the relative frequency with which each number of the scale was observed will convey an idea of the intensity of the rainband on Ben Nevis. The percentage of observations of each number is as follows:—

Rainband	0	1	2	3	4	5	6	7
Percentage	24	31	27	8	7	1	1	1

The mean of all the observations gives a rainband of 1.7. Now at sea-level, according to Dr. Mill, the rainband is seldom or never less than E, that is, than 2 on our scale. Hence the mean rainband on the Ben is about equal to the minimum at sea-level. About 80 per cent. of these observations were made when the Ben was enveloped in fog or mist. The only effect fog or mist has upon the

rainband is that its intensity is the same in every possible direction, whereas in clear weather, as is well known, it is generally greatest at the horizon and least at the zenith. But as the rainband in fog or mist has been found to be equal to that which is observed in clear weather at an altitude of 30° or 40°—the altitude of that part of sky always observed—the presence or absence of fog and mist has been ignored in working up the observations.

In forecasting the weather for the surrounding low-lands, the rainband observed here, together with similar observations at Fort William, would probably be of great value, but its forecasting power for the summit alone is limited. The lower values generally show indications of rain several hours before it comes on, but the higher values simply indicate a continuation of the heavy rainfall by which they are invariably accompanied. To show that the rainfall increases with the successive numbers of the scale, the mean hourly rainfall has been computed, for each scale value, from the rainfall of the three hours and twelve hours after noon. For the observations of 1885, the mean daily rainband was used. In 1886, each individual observation was taken into account, and, for each number of the scale, the mean rainfall was computed from the rainfall of the three hours after each observation. As the results differ in some respects, they are here given for each year separately:—

Rainband	0	1	2	3	4	5 and upwards
rainfall (1885... inches)	000	006	016	029	050	106
1886... inches)	002	006	012	016	027	076

Owing to the fewness of observations of the numbers 6, and 7, they have been grouped together. The higher values are followed by a rainfall which is proportionally far too high, owing, no doubt, to the fact that these higher values are only observed during the passage of cyclonic disturbances laden with moisture from the Atlantic, when a great amount of this moisture only comes into the spectroscopic field in a condensed state, when it is forced to ascend so as to pass the summit, and consequently does not affect the rainband, but causes a very heavy rainfall. The moisture that ascends the mountain, not being detected below by the spectroscope here, is a constant source of disparities in the agreement of rainband and subsequent rainfall. The fact that our mean rainband is not greater than 1.7, and that the amounts of rainfall were, for 1885, 1.46497 inches, and for 1886, 0.7847 inches, clearly indicates that a great part of our rainfall is due to the condensation of the moisture that is forced up from below the level of the summit.

In comparing rainband with subsequent rainfall, the temperature of the air at the time of observation, as well as the variation in the temperature, must be taken into account. With the view of ascertaining the relations between rainband, subsequent rainfall, and temperature, the mean hourly rainfall for the three hours after an observation, for each number of the rainband scale, and for every 5° of temperature from 15° to 50°, has been calculated, and the results for rainbands of values 1, 2, and 3, are as follows:—

Temperature	15°	20°	25°	30°	35°	40°	45°	50°
Rainband { 1 ...	003	005	010	006	006	004	000	000
2 ...	005	010	024	015	012	006	003	000
3 ...	007	013	026	019	016	015	009	003

The means for temperatures of 25° and upwards show that for any one rainband, when the temperature rises the rainfall decreases, and when the temperature falls the rainfall increases. The results being as yet only tentative, it cannot be definitely stated by how much the mean hourly rainfall increases or decreases per degree of fall or rise in the temperature, for any one value of the rainband. The means for temperatures below 25° seem to indicate that a fall in the temperature causes a decrease in the rainfall, which is not at all probable. If it be the

case that low temperatures do not affect the absorbing powers of aqueous vapour, which is not likely, the small amount of rainfall at these low temperatures may be due to the necessarily unsatisfactory measurements of precipitation obtained from the rain-gauge when the temperature is below 32°. In truth, snowfall and rainfall as measured by the rain-gauge, can hardly be compared with each other. For a full account of these and other questions of rainfall here, see Mr. Omond's articles and also Mr. Buchan's "Meteorology of Ben Nevis" in the Journal of the Scottish Meteorological Society for the last two years.

The mean rainbands at the different temperatures are:—

Temperature	15°	20°	25°	30°	35°	40°	45°	50°
Rainband ...	0.4	1.1	1.1	1.5	1.9	2.4	2.5	2.3

The greatest number of observations at any one temperature was 724 at 30°, and the least 35 at 50°.

The reason why so many observations were made in 1886 was to find whether there was any daily variation in the rainband. That there is a slight variation will be seen from the following results, which are for the summer months only, viz.:—

Hour	6	7	8	9	10	11	12 noon
Rainband	1.4	1.4	1.6	1.5	1.6	1.6	1.7
Temperature	32°0	32°3	32°7	33°2	33°5	34°0	34°4
Hour	13	14	15	16	17	18	
Rainband	1.7	1.7	1.8	1.7	1.8	1.7	
Temperature	34°8	35°0	35°0	34°9	34°7	34°3	

The rise in the rainband from 6 a.m. till 3 p.m. following the temperature, points to the cause of this daily variation as being the expansion of the lower atmosphere by the rising temperature, and the consequent raising of the vapour above the level of the Ben. This is almost the same cause to which Mr. Buchan ascribes the rise in the barometric pressure for the same daily period. Prof. Piazzi Smyth says that the rainband does not increase for a rise of temperature at sea-level, because the total quantity of vapour over the place of observation is pretty constant (Journal Scot. Met. Soc., vol. v.). But over this summit the quantity of vapour is not constant, but varies, and the rainband varies with it.

Remarkable variations in the rainband occur in the course of a single day, often amounting to 3, and sometimes to 5 and 6. On March 26, 1886, when a cyclone was passing to the north of the Observatory, the rainband varied from 6 at 10 a.m., to 3 at 12 noon, and to 1 at 5 p.m. The strongest mean for any one day was 8 on January 1, 1886, while a mean of 0 has frequently occurred. On December 18, 1885, a rainband, estimated at 12, was observed on the rising sun—this was one of the noted "fore-glow" mornings. In anticyclonic weather, which is characterised by great dryness of the air, with all the clouds at lower levels, a strong rainband is always obtained from the layer of air close over the clouds, in summer, when not a trace is detected at the usual height of observation; but in similar weather in winter the rainband is often entirely absent, even over the clouds. It is noteworthy that on days with little or no rainband, when not actually looking at the sun, the spectrum as a whole is darker than usual, and on days with strong rainbands, the parts of the spectrum not occupied by lines are brighter than usual. In a certain type of weather, when the rain-gauge completely fails to record the precipitation, the rainband always indicates the presence in the air of the vapour which gives it. This occurs when snow-crystals are deposited with low temperatures and strong winds, as described in NATURE (vol. xxxi. p. 532). The importance of rainband observations will be greatly increased when similar series can be undertaken at the sea-level simultaneously with those on the summit of Ben Nevis.

A. RANKIN

DO SCORPIONS COMMIT SUICIDE?

CORRESPONDENTS OF NATURE have repeatedly raised the question whether there is any truth in the old legend that a scorpion, when placed within a ring of red-hot embers, will, after making futile efforts to pass the fiery circle, deliberately kill itself by inflicting a wound with a sting in its own head. Surgeon-General Bidie, of Madras (vol. xi. p. 29), Dr. Allen Thomson (vol. xx. p. 577), and Mr. Gillman (vol. xx. p. 629), have answered the question in the affirmative. The other side has been taken by Mr. Hutchinson (vol. xxi. p. 226), Mr. Curran (vol. xxi. p. 325), and Mr. Lloyd Morgan (vol. xxvii. p. 313). Mr. Hutchinson maintained that the animals experimented on by Mr. Gillman had died from excessive heat. To this Mr. Gillman replied, that the temperature in the centre of such a circle of glowing charcoal as he used does not exceed 50° C.

The subject has lately been thoroughly investigated by Mr. Alfred G. Bourne, Professor of Biology in the Presidency College, Madras; and the results of his observations have been set forth in a paper communicated to the Royal Society by Prof. Ray Lankester. Some of the details of his experiments are not very pleasant reading, but it must be remembered that the question is one of considerable importance, because, if it could be proved that the scorpion commits suicide, its impulse to do so would be, as Mr. Romanes has pointed out, "a unique case of an instinct detrimental alike to the individual and to the species."

One of the arguments used to disprove the existence of the supposed instinct is, that it is physically impossible for a scorpion to sting itself in a vulnerable place. Mr. Bourne shows that this statement is inaccurate. If, he says, a dead scorpion be taken which is quite limp and not in a state of rigour, it will be easily seen that the last four segments of the tail are about the only portions of the body, whether on the dorsal or ventral surface, where a scorpion could *not* sting itself. Further, if two fighting scorpions be watched, it will be seen that the extent to which the sting can be moved about is perfectly wonderful. Moreover, he has noticed that, when the scorpion is placed in very unpleasant circumstances, it not unfrequently lashes its tail about and causes actual penetration of the sting. If, for instance, the rays of a burning-glass be concentrated on any part of the body, the scorpion brings its sting there, and tries to strike away the source of irritation. Occasionally its efforts become more and more frantic, and the point of the sting catches somewhere. The scorpion, however, does not die unless the heat is concentrated on the back. In that case it soon succumbs, even if the sting has been tied down or previously removed.

The most important of Mr. Bourne's propositions is that the poison of a scorpion is quite powerless to kill the same individual, or another individual of the same species, or even scorpions of other species. If this proposition is established, there can, of course, be no further controversy about the matter. *A priori*, it is not improbable, for Sir Joseph Fayrer has shown that the cobra poison will not affect a cobra. Mr. Bourne frequently took a scorpion in his hand, and, holding the sting between a pair of forceps, pricked the scorpion with the sting and squeezed out its poison. There was a little bleeding from the wound, but in every case the scorpion lived for days. He also tried stinging one scorpion with another, using in the first instance specimens of the same species, then specimens of different species. Occasionally, he thinks, the stung individual became a trifle sluggish, but it never died from the sting. In order to make sure that his method of squeezing out the poison was perfectly effective, Mr. Bourne, after stinging a scorpion, sometimes continued to hold the sting, and, taking a cockroach, squeezed out into it some more of the poison. The cockroach in-

variably became very sluggish at once, and died in an hour or so. He also used a large cricket, stinging it in the femur of the large hind-leg; that leg became paralysed. When the animal was stung in the same place on both sides, both the hind-legs became useless, and it crawled away on the two anterior pairs of legs. Stung in the thorax it became quite torpid; when placed on its back it was not able to turn over. After considerable search, Mr. Bourne procured some specimens of *Thelyphonus*, which he chose as being the nearest relatives of the scorpions. He stung these in his usual method, and in each case they died within six seconds. He then tried some spiders, and they died in a few minutes when well stung. The slower general action in cockroaches and crickets is probably, he supposes, to be explained by the very inefficient circulation of the blood in insects as compared with Arachnida.

In all cases of artificial stinging Mr. Bourne took especial care to avoid mechanical injury to the nerve ganglia. And he tried puncture without the introduction of scorpion poison. Using large insects for this purpose, he obtained complete freedom from ill effects when using simple puncture, whereas the same species of insects when punctured with introduction of scorpion poison were instantly paralysed, and died in half an hour. He also procured two small shore crabs. One he punctured between two joints of the great chela of one side; several drops of blood exuded, but they coagulated, and the crab remained well. The second he stung in the same place with scorpion's sting, squeezing it to insure poisoning. The claw was immediately paralysed, and the crab gradually became torpid, and died in less than an hour.

When a number of scorpions are kept together in captivity, it is not difficult to induce a couple to fight. Mr. Bourne isolated such a couple, and they fought on and off for two days, during which time each repeatedly stung the other. On another occasion he separated two scorpions which had been fighting, and which had repeatedly stung one another. They lived perfectly well.

Apropos of Mr. Gillman's remarks about the actual temperature to which the scorpion is subjected in the "fiery circle," Mr. Bourne tried this experiment. He placed a scorpion and a cockroach (for comparison) in an incubator with glass sides, and gave them a piece of wood to walk about upon, and gradually raised the temperature. At 40° C. both seemed uncomfortable, and the cockroach performed a sort of licking action on all its legs and antennæ. At 45° C. the scorpion became very sluggish, and at 50° C. it was nearly dead. A large furious scorpion before the experiment, it now lay on its back and did not attempt to get up. Mr. Bourne took it out and gave it a cold bath, and put it in a cool earthenware vessel, and in the course of two hours it recovered. The cockroach was left in the incubator till the temperature reached 52° C. When nearly dead, it was taken out, and very gradually recovered. To try the effect of a wet heat, a scorpion and a cockroach were placed in water at 43° C., and they both died almost immediately, whereas they would both have lived in cold water for hours.

The inference drawn by Mr. Bourne from his experiments is that scorpions do not commit suicide, and that when they die within a ring of fire, heat is the cause of death. After he had reached this conclusion he was told that according to some authorities inclosure in a circle of oil, or inclosure under an inverted tumbler, will cause a scorpion to kill itself. He accordingly placed a scorpion on a plate within a ring of cocoa-nut oil. It calmly walked through. He placed another scorpion on a plate, and round the edge a thick roll of rag dripping with kerosene oil. The animal walked out over the rag. When daubed with oil, it appeared uncomfortable, but did nothing remarkable. The experiment with an inverted tumbler was made, and gave the same negative result.

THE MYTHICAL ZOOLOGY OF THE FAR EAST

A SHORT time ago the British Museum acquired a comprehensive collection of Japanese and Chinese pictures, made by Mr. William Anderson, for some years medical officer to the British Legation in Tokio. This gentleman's magnificent work on the "Pictorial Arts of Japan" has already been noticed in these columns; and he has just placed students of the arts of the Far East under an additional debt of gratitude to him by the preparation of a catalogue of his collection in the British Museum, which has just been published by the Trustees of that institution. With this volume, except for a special purpose, we have nothing to do; but it is impossible to glance through it without being struck by the amount of labour which the author has devoted to his dissertations on the various schools of painting, to his descriptions of characteristic examples of these schools, and to his explanation of the motives which inspired the artists. The word "catalogue" is a modest one to employ in describing the work, for though it contains the numbers and names of the pictures, this is the least part of its contents.

Amongst the motives of the artists of China and Japan, mythical zoology held a very important place; it evidences, says Mr. Anderson, "a courage of invention almost unparalleled in the pseudo-science of Oriental races." It holds, too, a disproportionate place in the folk-lore and superstitions of the people of both countries. Yet it has scarcely received any attention in Europe. In Prof. Angelo de Gubernatis's great work on "Zoological Mythology" there is but a single reference to China, and none at all to Japan, while the myths of Aryan nations occupy the greater part of his volumes. Here and there in books relating to the countries of Eastern Asia scanty references to popular myths respecting animals are found, but, so far as we are aware, Mr. Anderson's is the first work which gives any adequate conception of the marvellous extent of this species of lore amongst the Chinese and Japanese. As the latter owe their art, literature, and religion to China, so they owe also their scientific myths. The Chinese have developed mythical zoology to a greater extent than any other nation. "Their literature teems with strange conceits, some of which appear to be transcripts of local folk-lore, others appertain to Buddhism or Taoistic legends, and others are accepted as sober facts of natural history." These have almost all been adopted and improved in treatment by the Japanese.

Mr. Anderson divides the anthropological myths into three classes:—

(1) Persons born of woman with or without divine agency, who develop magical powers, work miracles, and attain a fabulous longevity.

(2) Those distinguished by physical peculiarities of a fabulous nature. Amongst these are giants; dwarfs; perforated men, who are conveyed about by coolies by means of poles put through holes which conveniently exist in their bodies for this purpose; stomachless men, who, according to popular belief, "dare not laugh for they have no sides to hold"; men with enormously long legs, and those with similarly long arms; men with tails, who carefully dig holes where they sit in order to provide a receptacle for the appendage; and many other extraordinary beings, all of which are truthfully described, from Chinese works of authority and repute, in the great Japanese encyclopædia *Wa-Kan-San-Sai tsu-yé*.

(3) Transitional beings, who combine with human elements parts naturally appertaining to the lower animals: such are feathered men; those with human faces, but the wings and beak of a bird; mermen, who have human heads and arms attached to the body of a fish, and learn the secrets of the deep from the murmuring hollow of the Conchifer. To this section also belongs the vampire

bride who lures men to her deadly embraces till she has drained away their life-blood.

Mythical animals are similarly classified:—

(1) Those without any remarkable peculiarities of conformation, but gifted with supernatural attributes. Thus the tiger is classed in Chinese mythology as one of the supernatural animals, the king of beasts, and the representative of the masculine or active principle of Nature. It attains the age of a thousand years, and after passing the half of this term its hair becomes white. It is sometimes seen in association with the dragon, apparently as the emblem of the power of faith; it is also regarded as the type of wisdom, and in illustration of this attribute Mr. Anderson gives a story (p. 51) which has a familiar analogy in European folk-lore. The fox, again, is the demon of mischief, with the power of changing his shape at will, but ever with some evil design on the comfort of mankind. When he reaches the age of fifty, Mr. Anderson tells us, he is able to accomplish at will his most favourite and baneful metamorphosis into the resemblance of womankind; at a hundred he can take the shape either of a young and beautiful girl, or of a wizard strong in all the powers of magic; and when he reaches the term of a thousand years he becomes a Celestial Fox, characterised by a golden colour and nine tails, and may be admitted to heaven. But it appears he does not always avail himself of this privilege, for the possession of the extra tails only gives him an augmented cunning and capacity for wickedness. The tortoise also attains a marvellous longevity, and is variously represented as the embodiment of a star in Ursa Major, and as a descendant of the first dragon. In Hindoo mythology the tortoise supports the elephant which supports the world; in Japanese art it is represented as bearing on its back the mountain abode of the immortals. The horse is also associated with longevity, and it is still a popular belief that the female is delivered of its progeny through the mouth. The crane is one of the commonest figures in Japanese art: in Chinese mythical zoology there are four varieties, distinguished by their colours; they all live to a fabulous age, and after completing six hundred years are superior to the necessity of other sustenance than water. Many other notices of animals belonging to this class are scattered throughout Mr. Anderson's book in connection with pictures in which they are represented.

(2) Animals differing from their fellows only in size, or in alterations of the due number of parts. Such are serpents eight hundred feet long, which devour elephants; nine-tailed foxes; the four-eared monkey which heralds the deluge; the fish with ten bodies and one head, whose flesh is a sure preventive of boils; and many others.

(3) Creatures made up by the amalgamation of parts of various animals. Amongst these composite monsters the principal is the dragon, which, according to the Japanese encyclopædia already mentioned, has the head of a camel, the horns of a deer, the eyes of a demon, the ears of an ox, the body of a serpent, the scales of a carp, and the claws of an eagle. It is not necessary to say more by way of description, for it is the most familiar object in the art of China and Japan. It is treated by writers of the last century as really existing. It becomes at will, according to a Chinese author of the seventh century B.C., reduced to the size of a silkworm, or swollen till it fills the space of heaven and earth. "In Chinese Buddhism it plays an important part, either as a force auxiliary to the law, or as a malevolent creature to be converted or quelled." It is a guardian of the faith, an attribute of saintly or divine personages, an enemy of mankind, an emblem of majesty, the presiding genius of rainfall, and a symbol of time and place, giving its name to certain days and years, and to a point of the compass. Many more details about this extraordinary creature will be found scattered through Mr. Anderson's book, especially on pp. 48 *et seq.* The *kilin* or *kirin*, "the noblest form of the animal creation,

and an emblem of perfect good," also belongs to this class. It has the body of a deer, the tail of an ox, and a single horn, so that it resembles the unicorn. The phoenix is another animal of this kind, with the head of a pheasant, the beak of a swallow, the neck of a tortoise, and the outward resemblance of a dragon. It is regarded as an omen of good, and heralds the advent of a beneficent reign. "In works of art it is a nondescript bird of gorgeous plumage, intermediate between that of the peacock and bird of paradise, and bears flame-like appendages where the neck joins the body."

All the creatures referred to here, and many more belonging to one or other of the classes of zoological myths, are represented pictorially in the *Wa-Kan-San-Sai dzu-yé*, already mentioned, and in the *Mangwa* of Hokusai, a book to which access can be obtained without difficulty in most of the capitals of Europe.

To the mythical animals already mentioned, which are common to China and Japan, the Japanese have added some of their own invention. Such are serpents, giant centipedes, monster devil-fishes; earth-spiders, probably representing the troglodytes of old Japan; the raccoon-faced dog, which possesses in a minor degree the evil powers and tendencies of the fox; the wolf-like animal which produces thunder; the "whirling neck," or being which has the power of so elongating the neck that the head appears in places remote from the body; the mandevouring *kappa*, which frequents rivers and ponds, and politely challenges wayfarers to single combat; and many other equally strange creatures. An outline sketch of Japanese demonology will be found at p. 59, and a striking myth of a demon spider at p. 109.

Enough, however, has been said to show that if Mr. Anderson, in his catalogue and larger work on the "Pictorial Arts of Japan," has revealed to British readers a new and most important branch of art, he has incidentally indicated to his readers a new world of myth, which has hitherto found no place in the consideration of students of comparative mythology in Europe, but which can now be no longer neglected. Mr. Anderson of course treats it almost solely in its relation to art, but he informs the reader in every case where further and more detailed information may be obtained. The task of tracing these myths to their source and of finding analogies elsewhere is one for the scientific inquirer. Mr. Anderson has done the more laborious part of the work in bringing them together. He also suggests that very many of them will be found to have their homes in India, and to have spread with the doctrines of Buddha to China and other far eastern countries. One great advantage which the student of the zoological and other myths of China and Japan will have is that in the exhibition of the Anderson Collection, which is shortly to be opened at the British Museum, he will be able to see in the most graphic form the conceptions of successive generations of artists of the beings to which the myths relate—an advantage which could not be obtained even in the countries themselves without considerable expenditure of money, time, and labour. It only remains to be said that we have adopted Mr. Anderson's classifications, and in many instances have employed his own words in the descriptions of the myths scattered in so much profusion throughout the catalogue.

NOTES

WE regret to have to announce the death, on Good Friday, at the Nice Observatory, of M. Thollon, the eminent spectroscopist. Few men devoted to spectroscopic inquiry have worked so unceasingly and successfully; and in him Science loses one of the most single-minded of her votaries. He has been cut off in the midst of his labours, which, especially since his loca-

tion at M. Bischoffsheim's magnificent observatory and the completion of the spectroscopic installation there, have borne such rich fruit in the shape of a method of sorting out the telluric from the true solar lines (a method slightly modified by Cornu), and of a map of the solar spectrum as observed by the new form of spectroscope of his own invention, which vastly surpasses in dispersion and purity of image anything that preceded it. Dr. Thollon has not only worked at Nice, but at the Pic du Midi and the Paris Observatory; he was also one of the observers of the total solar eclipse in Egypt in 1882. In all his wanderings, as in his work, he made many friends, and all who knew him will mourn his loss, not only as a man of science, but as one possessing, above the ordinary degree, a true and genial nature.

ON March 5 a drawing-room meeting for the promotion of technical education was held at the house of Mr. E. C. Robins, under the presidency of Prof. Huxley. A Memorandum of the proceedings has now been printed for private circulation. An address on the technical training at the Central Institution at South Kensington was delivered by Prof. Ayton. The address was followed by a discussion, in which Prof. Silvanus Thompson, Mr. Brewin, Prof. Perry, Prof. Henrick, and others took part. In summing up the debate, Prof. Huxley remarked that something had been said about rivalry between the Central Institution and the Finsbury School. That most excellent and vigorous school which the City and Guilds Institute had established at Finsbury was chiefly intended to give primary technical instruction to workmen and others who could snatch only a few hours a week from their daily labour for the purpose of receiving it. The Central Institution, on the other hand, was chiefly intended for the advanced instruction of persons who could give up their time for one or more years to the higher branches of technology. Exhibitions enabled the promising student of the schools at Finsbury and elsewhere to pass to the Central Institution, and profit by the advantages it offered him. To talk of rivalry between the two was like talking of a rivalry between Eton and Cambridge. No doubt the day would come when a score of such schools as that at Finsbury would be sending their picked scholars to the Central Institution; but, before that day could come, the organisation of the Central Institute must be so far completed that it could receive them and deal with them. A great deal had been said about the 100,000*l.* or 150,000*l.*, or whatever it was, that had already been spent on the Central Institution, and of the 10,000*l.* a year that it cost. He begged leave to repeat that which he had said elsewhere, that if in the course of the next ten years the City and Guilds Institute could succeed in catching and training another Faraday or Whitworth or Armstrong, he would from a mere commercial point of view be worth all the expenditure initial and assured.

A HIGHLY interesting series of experiments has recently been successfully carried out by M. Olszewski. The more permanent gases have not only been liquefied at pressures averaging only 740 mm. by aid of excessively low temperatures, but the boiling-points, melting-points, and densities of these so-called gases have been determined at atmospheric pressure. The glass tube in which the condensation was effected was surrounded by a bath of liquefied ethylene, which could be caused to boil by reduction of its pressure, and, by use of a specially constructed air-pump, was reduced in temperature to -150° . When this point was reached, the gas to be liquefied was admitted into the tube from a Natterer cylinder containing the gas at about 40-60 atmospheres pressure, and was readily liquefied. A hydrogen thermometer was used to determine the temperature of the liquid, and the boiling-point of methane at

atmospheric pressure was found to be -164° C., that of oxygen $-181^{\circ}4$, nitrogen $-194^{\circ}4$, carbon monoxide -190° , and nitric oxide $-153^{\circ}6$. The melting-point of carbon monoxide was also determined to be -207° , and that of nitrogen as low as -214° . M. Oszewski's nearest approach to absolute zero was -225° for solid nitrogen. The density of methane at 736 mm. and -164° was found to be 0.415, that of oxygen at 743 mm. and $-181^{\circ}4$ was 1.124, while that of nitrogen at 741 mm. and $-194^{\circ}4$ was found to be 0.885. The densities were determined by reading off the position of the liquid meniscus in the tube, volatilising a portion by means of an aspirator, and again reading off the height of the column, the volume of the volatilised portion being measured by the amount of water running out of the aspirator. At the fifth experiment with nitrogen, the tube, which had survived two years' experiments, burst, and destroyed the apparatus, so that the densities of carbon monoxide and nitric oxide must be left for future experiments.

ON Saturday next, and the two following Saturdays, Dr. R. von Lendenfeld will deliver a course of lectures at the Royal Institution on recent scientific researches in Australasia.

ON the 4th inst. the first meeting of the Sanitary Legislation Conference was held in the rooms of the Sanitary Assurance Association. The following resolutions were passed: (1) that the sanitary registration of all buildings is desirable in the interest of the public health; (2) that it is desirable that the law should forbid any building being used for public or semi-public purposes, unless and until the arrangements for the water-supply, drainage, and ventilation of such building have been certified as satisfactory by some properly-qualified person; and (3) that the provision of a public sanitary register for the voluntary registration of private houses would be instrumental in promoting sanitary improvement.

AN important topographical and geological Expedition has been organised by the Canadian Government for the exploration of the country watered by the River Yukon. According to Lieut. Schwalk, who went over much of the ground for the U.S. Government in 1883, this river is over 2000 miles in length, and it is believed that in many districts there are valuable deposits of gold. The Expedition will start from Victoria, British Columbia, early in May. The part of the work relating to geology and natural history will be conducted by Dr. Dawson, Assistant-Director of the Canadian Geological Survey; and under him Mr. W. Ogilvy will take charge of the topographical work, and make an accurate survey and measurement of as much of the Yukon as lies within British territory.

It has been determined to transfer the Observatory of Rio de Janeiro to Santa Cruz, nearly on the same parallel, and a little more to the west. The Observatory is of considerable importance, owing to its position, being nearly on the Tropic of Capricorn, and it has recently been greatly improved by the present Director, Sr. Cruls. It is stated in the *Bollettino mensuale* of the Italian Meteorological Society, that from January of the present year the Observatory will commence the publication of a monthly Bulletin containing *inter alia* the meteorological observations made at fifteen stations in Brazil. Hitherto observations from that country have been very scarce indeed.

AFTER the first International Ornithographical Congress at Vienna in 1884, numerous stations for observing the habits of birds were organised all over the world. Dr. A. B. Meyer, the Director of the Zoological Museum at Dresden, was appointed Director for the erection of all such stations in Saxony. This

gentleman, together with Dr. F. Helm, of Arnoldsgrün, has just published the first Annual Summary for the year 1885. It contains the results of about forty-eight series of observations from thirty-six stations, and articles on 180 species of birds.

WE have received four numbers of the "Encyclopædie der Wissenschaften," edited by various eminent German men of science, and issued by Trewendt of Breslau. One of these numbers concludes an elaborate dictionary of mineralogy, geology, and palæontology. Two others form part of an equally elaborate dictionary of chemistry, and the remaining number contains some sections of a treatise on botany.

THE Religious Tract Society are about to publish "Pioneering in New Guinea," by the Rev. James Chalmers, who has lived and travelled in New Guinea during the last eight years. A special chapter contains answers given by natives to 115 questions carefully drawn up by Mr. Chalmers.

"A LIST OF BRITISH BIRDS," revised by Mr. Howard Saunders, will be found of much service both for the labelling of specimens and for reference. It has just been issued by Messrs. Gurney and Jackson.

EARTHQUAKES on April 1, 2, 3, and 4 are reported from Aden. No damage was done.

WE hear that Mr. Murray has resigned the post of Librarian and Curator to the Karachi Museum. During his tenure of office he has written several hand-books on the zoology of Sind, and his Catalogue of the vertebrate fauna of that province is a valuable epitome of the subject. He will be succeeded by Mr. W. D. Cumming, who was for some time stationed at Fao, in the Persian Gulf. While there Mr. Cumming devoted himself with much energy to the study of the avifauna of the neighbourhood, and sent several interesting collections to England, where they have been described by Mr. Bowdler Sharpe. The collections proved to be one of the most important acquisitions of the British Museum during the year 1886.

LARGE cases, showing the nests of the Heron, Hen-harrier, Starling, Sand-Martin, and Common Tern, have been lately added to the Natural History Museum. Prof. Flower has also placed in the great hall a large case illustrating the principal breeds of domestic pigeons derived by man's selection from the common blue Rock-pigeon (*Columba livia*). Popular guides to most of the departments have recently been published by the Trustees, and the Index Museum in the great hall bids fair to supply the student with a complete introduction to the study of zoology and botany. In face of the energetic labours of the staff of this Museum to render the collections under their charge educational for the masses, it is satisfactory to learn that several members of Parliament have announced their intention of questioning the wisdom of reducing the grant to the British Museum, as has been done this year in deference to the rage for economy at present in vogue.

PROF. BARBOZA DU BOCAGE has recently described a Sunbird and a Grass-warbler from the Island of St. Thomas as *Cinnyris newtonii* and *Prinia molleri*. Zoologists will welcome the return of Prof. Bocage from the realms of politics back to the charge of the Lisbon Museum, which, under his care, rose to a position of first-rate importance.

VOLUME I. of the Journal of the Science College of the Imperial University, Japan, which has been recently published, contains a valuable paper by Mr. Sekei Sekiya, Professor of Seismology in the University, on the comparison of earthquake records given at the same station by different seismographs, the

comparison being made as a test of the accuracy of the instruments. Two recent earthquakes are discussed, each of which was recorded in duplicate at the Tokio Observatory, by two somewhat different forms of Ewing's horizontal pendulum seismograph, and the autographic records are reproduced in the paper. Prof. Sekiya compares the corresponding motions as recorded by different instruments, and remarks that when the records are gone through, wave by wave, the corresponding pointers are found to have drawn waves of exactly the same amplitude and period, and even the irregular minor ripples which are superposed on the principal undulations are reproduced faithfully by both. He concludes that this exact coincidence proves conclusively the trustworthiness of the horizontal pendulum seismograph. The diagrams reproduced in the Journal also show the vertical motion of the ground, as recorded by Ewing's vertical motion seismograph. This motion, the author points out, is much less in amplitude than the horizontal motion (usually from $\frac{1}{4}$ to $\frac{1}{2}$), and its average period is only about half that of the horizontal motion. The three components of motion, when combined, give a resultant form of extraordinary complexity for the path pursued by particles on the surface of the ground during an earthquake shock.

THE Association Scientifique de France has discontinued the publication of its weekly Bulletin, and will issue, instead, a *Compte rendu* of the Conferences of the Association in half-yearly volumes. A few advance parts will be published fortnightly, for the use of such of the members as may desire to have them. The Bulletin has been published since 1864.

MR. JAMES WILD, Geographer to the Queen, died at his London residence, at the age of seventy four, on the 17th inst. He was educated at Woolwich for the army, but afterwards devoted himself to the production of scientific and educational works. He soon became a member of various scientific Societies, and his maps and geographical works secured for him the position of Geographer to the Queen. For a good many years he had a seat in Parliament. After his retirement from political life he represented the Ward of Cornhill in the Common Council, and he took a leading part in directing the attention of the Cloth-workers' Company, of which he was a member, to the subject of technical education. It was mainly through his efforts that the technical schools of Bristol, Manchester, and Leeds were erected. Among the many honours conferred upon him was the gold medal for scientific merit, granted by the present German Emperor as King of Prussia.

IN a paper entitled "Field Notes from Afghanistan," printed in the new number of Records of the Geological Survey of India, Mr. C. L. Griesbach gives an account of instances of recent glacial action observed by him when crossing the Hindu Kúsh by the Chahárdar Pass in October 1886. The road which leads from Chápdarra camping-ground on the north side of the Hindu Kúsh to the top of the pass ascends a narrow straight valley, bounded on each side by steep cliffs, some of them crowned with perpetual snow. The bottom of the valley itself is greatly choked and partially filled with debris, which might be simply the detritus from the hill-sides. Large cones and fans of fragmentary material descend from each small ravine on both sides. So far only the configuration of the valley, its nearly straight course and absence of larger side streams, would suggest the former presence of glaciers. But on reaching an elevation of 12,000 feet, one suddenly comes to a huge mass of debris, which closely resembles the recent accumulations near the lower end of a glacier. Large blocks, some of them of immense dimensions, are loosely mingled with angular fragments of every size, and the whole is arranged like a dam across the valley. The hill-sides (gneiss) are polished and grooved, and the blackened surfaces glisten and shine in the distance like metal. All

the larger blocks show extensive grooving and deep ice-scratches on their polished sides. This mass of debris lies at the base of a terrace filling the valley. The former glacier, of which this is the end moraine, was on the upper and raised portion of the valley. The latter bears the remarkable appearance of an ice-worn trough; it is wider than the valley below, and its base is now partially filled by finer debris, through which a small stream winds its way amidst a series of swampy pools. It is within the area of perpetual snow, and the latter with frozen patches of ice lies on the hill-sides and in sheltered depressions. The valley looks as if the glacier had only quite recently left it. Moraines and glacial silt still lie as they were deposited. The head and catchment area of the valley close to the top of the pass (14,100 feet) is still rather thickly covered with frozen snow. Near the head of a narrow valley leading from the Chahárdar Pass to the Deh-i-Tang, at an elevation of 12,050 feet above sea-level, several small ravines join. Mr. Griesbach noticed that three of these ravines were still filled with glaciers. Although they were very small, the moraine accumulations near their lower ends were enormous.

IN a highly important and interesting paper on the structure of the Nostochineæ, contained in the first volume of the new Italian botanical journal *Malpighia*, Prof. A. Borzi, of Messina, states the very interesting fact that, in *Vosloe ellipsoidesporus* and other species of the same genus, a distinct communication can be detected between adjacent cells. If the cell is an intercalary one, it has two pores at opposite poles; if apical, only one; and through these pores pass very delicate threads of a substance which sometimes gives the reactions of protoplasm, sometimes of cyanophycin, the substance of which, according to Borzi, both the cell-contents and the investing gelatinous sheath of the Nostocaceæ are composed. This intercommunication between the cells is always interrupted in the formation of heterocysts. During the transformation of ordinary cells into heterocysts, the walls become thicker, the gelatinous substance of which they are composed collecting especially round the pores through which the strands pass, and eventually completely closing them up. In this way is formed a short conical projection pointing towards the interior of the heterocyst. In the vegetative cells of the filament, that is, those which are not destined to become heterocysts, the connecting threads appear always to consist of protoplasm. In the hornogones this connexion between adjacent cells is especially evident. In addition to several species of *Nostoc*, Prof. Borzi has observed this interesting phenomenon in several of the other families of Nostochineæ or filamentous Cyanophyceæ, viz. in the Scytonemaceæ, Stigonemaceæ, and Rivulariaceæ.

PROF. D. KIKUCHI, of Tokio, who graduated at Cambridge in 1877, is editing, at the request of the Education Department of the Japanese Government, text-books of geometry and algebra, those in use at present being very unsatisfactory. He has already translated and published the syllabus of plane geometry drawn up by the Association for the Improvement of Geometrical Teaching, and has also done the same for Clifford's "Common Sense of the Exact Sciences." His principal course of lectures—a two years' one—is on dynamics, commencing with statics, and including sound and liquid waves.

WITH reference to Mr. Hooper's paper on *Gymnema sylvestre*, printed by us last week, Mr. J. C. Shenstone writes to us that the peculiar properties of the plant were described in a communication to the Linnean Society, December 7, 1847, by Capt. Edgeworth. The plant was pointed out to him by the natives, who were aware of its peculiarity. "No doubt," says Mr. Shenstone, "this is the Mr. Edgeworth alluded to by Mr. Hooper in his paper as having first discovered the property of the plant, but a reference to the original communication may interest some of your readers."

AN experimental passenger-train, lighted throughout by electricity, and heated by steam from the engine, is now running between New York and Boston. Each car is illuminated by fifteen 16-candle glow-lamps, the current being derived from storage-batteries beneath the floor-timbers, charged for ten hours by dynamos. Both light and heat are said to be ample, and science believes that danger from fire, in case of accident to the train, is much lessened, if not almost wholly done away with.

MACHINERY for winding silk from cocoons was lately set up in Washington by the Department of Agriculture. Much interest manifested in the experiments, and the demand for copies of the Bulletin on Silkworm Culture is so great that it has been necessary to issue seven or eight editions. According to officials of the Department of Agriculture, the requests for silkworm eggs have never been so numerous since the Department began its distribution. It is expected, therefore, that large quantities of American-grown silk will be placed upon the market this year.

WHEN crossing the Atlantic, Prof. Dennis, of New York, recently made some observations to test the purity of the ocean. He had previously prepared capsules of sterilised gelatine. One which was exposed in a state-room on the main deck of the steamer developed five hundred points of infection in eighteen hours; one exposed in the cabin on the main deck developed only five or six points in ten days; a third, hanging over the bow of the ship for ten days, remained uncolonised.

MR. V. G. EATON, writing to the *Popular Science Monthly*, says that in most of the eastern cities of the United States fully 30 per cent. of the men over thirty years of age show unmistakable signs of baldness, while nearly 20 per cent. have spots on their heads that are not only bald, but polished with a gloss that is supposed to belong to extreme old age alone. There has been in most of the churches and theatres in all the large eastern cities, as well as in Chicago, St. Louis, and other places on the West, and has verified his assertion by actual count. He is found that bald-headed men are most plentiful in New York and Boston, and that after these cities come Philadelphia, Washington, and the western towns. The following are a few of his observations taken in Boston:—Trinity Church: 243 men; 71 actually bald, 46 indications of baldness. King's Chapel: 86 men; 38 actually bald, 14 indications of baldness. Follen Street Theatre, orchestra at performance of the *Mikado*: 63 men; 27 actually bald, 10 indications. Boston Theatre, Judic: 126 men; 51 actually bald, 43 indications.

THE additions to the Zoological Society's Gardens during the past week include two Polar Bears (*Ursus maritimus*), from the Polar Regions, presented by Mr. Joseph Monteith; two Brown-headed Cougars (*Canis aruginosus*), from South America, presented by Lieut. General Newton; a Ring Dove (*Columba lunularius*), a Turtle Dove (*Turtur communis*), British, presented by Mr. C. L. Sutherland, F.Z.S.; a Secretary Vulture (*Argentarius reptiliivorus*), from South Africa, presented by Mr. Newbury; a White-tailed Buzzard (*Buteo albicaudatus*), from America, presented by Mr. John Lloyd; two Common Gulls (*Larus canus*), British, presented by Mr. J. A. Cotton; two Ducks (—) from the Falkland Isles, presented by Mr. F. Cobb, C.M.Z.S.; two Viscachas (*Lagostomus trichodactylus*), from the Gardens.

OUR ASTRONOMICAL COLUMN

THE U.S. NAVAL OBSERVATORY.—We learn from *Science*, l. ix. No. 217, that the new Naval Observatory, for which Congress appropriated 400,000 dollars several years ago, is to be built forthwith. Mr. R. M. Hunt, of New York, has been appointed architect of the building, and operations will shortly begin.

RESEARCHES ON THE SUN'S DIAMETER.—Prof. Di Legge, of the Campidoglio Observatory, Rome, has published in *Atti della R. Accademia dei Lincei*, ser. 4, vol. i., a discussion of the meridian transit observations of the sun's diameter taken at the Observatory during the years 1874-83. From May 1876 the observations were made by projecting the sun's image on a screen, so that two or more persons could observe simultaneously, and thus determine their "personal equations" from observations made under precisely similar circumstances. Altogether, 5796 transits were observed on 2213 days, giving an average of 221 days per annum. The mean resulting horizontal semi-diameters of the sun, collected in biennial groups, show a progressive diminution, which, taking into consideration Auwers' researches on the subject (*NATURE*, vol. xxxv. p. 496), are most probably due to change in the habits of the observers, as the table of mean annual personal equations given by Prof. Di Legge would also lead us to infer. The mean values of the horizontal semi-diameter at mean distance found from each observer's transits are respectively as follows:—Di Legge, 961".329 ± 0".011; Respighi, 960".760 ± 0".013; Giacomelli, 961".307 ± 0".012; and Prosperi, 961".356 ± 0".014; the combined mean value being 961".188.

ASTRONOMICAL PHENOMENA FOR THE WEEK 1887 APRIL 24-30

(FOR the reckoning of time the civil day, commencing at Greenwich mean midnight, counting the hours on to 24, is here employed.)

At Greenwich on April 24

Sun rises, 4h. 48m.; souths, 11h. 58m. 5".6s.; sets, 19h. 8m.; decl. on meridian, 12° 51' N.; Sidereal Time at Sunset, 9h. 18m.
Moon (at First Quarter on April 30) rises, 5h. 48m.; souths, 12h. 55m.; sets, 20h. 14m.; decl. on meridian, 12° 11' N.

Planet	Rises h. m.	Souths h. m.	Sets h. m.	Decl. on meridian
Mercury ...	4 17	10 23	16 29	0° 20' N.
Venus ...	6 1	14 13	22 25	22 50' N.
Mars ...	4 50	11 59	19 8	12 37' N.
Jupiter ...	18 34	23 45	4 56*	10 17' S.
Saturn ...	8 54	17 3	1 12*	22 24' N.

* Indicates that the setting is that of the following morning.

Occultations of Stars by the Moon (visible at Greenwich)

April	Star	Mag.	Disap.	Reap.	Corresponding angles from vertex to right for inverted image
25 ...	48 Tauri ...	6	21 0	21 36	85° 35'
30 ...	3 Cancrī ...	6	0 13	1 4	119 293
30 ...	54 Cancrī ...	6½	21 36	22 27	74 330

April h. m. Mars in conjunction with the Sun.
24 ... 23 ...
26 ... 6 ... Venus in conjunction with and 6° 19' north of the Moon.
29 ... 7 ... Saturn in conjunction with and 3° 6' north of the Moon.

Variable Stars

Star	R.A.	Decl.	h. m.
U Cephei ...	0 52.3	81 16 N.	Apr. 29, 4 0 m
S Canis Minoris ...	7 26.6	8 34 N.	" 29, m
S Cancrī ...	8 37.5	19 26 N.	" 28, 21 13 m
T Ursæ Majoris ...	12 31.3	60 7 N.	" 27, m
δ Libræ ...	14 54.9	8 4 S.	" 27, 20 37 m
U Coronæ ...	15 13.6	32 4 N.	" 24, 2 42 m
R Draconis ...	16 32.4	67 0 N.	" 28, M
U Ophiuchi ...	17 10.8	1 20 N.	" 24, 21 11 m

and at intervals of 20 8
S Delphini ... 20 37.9 ... 16 41 N. ... Apr. 24, M
δ Cephei ... 22 25.0 ... 57 50 N. ... " 30, 22 0 M
R Lacertæ ... 22 38.3 ... 41 47 N. ... " 27, m

M signifies maximum; m minimum.

Meteor-Showers

	R.A.	Decl.
Near ζ Ursæ Majoris ...	206	57° N. Bright, slow meteors.
" β Libræ ...	228	5 S.
" α Serpentis ...	235	0 N. Swift meteors.

GEOGRAPHICAL NOTES

THE new volume (xi.) of the *Geographisches Jahrbuch*, edited by Prof. Hermann Wagner, begins a new series, and assumes a new form. It has been elongated from the small square form with which we have been familiar, into a respectable octavo, containing about 500 pages. Moreover the present volume is entirely devoted to what in former years was only a section: an account of progress in the various departments into which scientific geography is divided. The next volume will no doubt contain memoirs on various subjects of geographical interest. The subject of physical geography (or rather geophysics) is treated by Dr. Hergesell and Dr. Rudolph. Prof. Toula deals with the investigations of the last four years in the geognostic structure of the earth's surface in all parts of the world. The progress of oceanography is of course dealt with by the great authority on the subject, Dr. O. Krummel, while Dr. Hann does a similar service for geographical meteorology, or climate. Botanical geography is treated by Dr. Oscar Drude, and zoological geography by Dr. L. K. Schmarda. Dr. G. Gerland gives the results of research in ethnology during 1884-86 in the various quarters of the globe. Under Dr. Wagner's sole editorship the *Jahrbuch* is becoming more valuable than ever as a book of reference in scientific geography.

THE Rev. George Grenfell, the explorer of the Mobangi and other important tributaries of the Congo, has arrived in London. Unfortunately his health is by no means satisfactory, and it will be necessary for him to rest for some time, therefore his appearance at the Royal Geographical Society must be delayed. He has brought home with him his original maps, which are admirable specimens of such work. They are on a scale of about 5 inches to a mile, and are evidently plotted with the greatest care; his work is therefore likely to take a high place. Dr. Lenz, who has arrived in Vienna, it is hoped will be in London at the end of this month, and as Dr. Junker may be here about the same time, it is just possible that both these eminent explorers may appear together at the first meeting of the Geographical Society in May.

UNDER Colonel Woodthorpe, the work of surveying our new Burmese territory is proceeding apace. Up to the end of January the out-turn of work amounted to 800 square miles on the $\frac{1}{4}$ -inch, and 260 miles on the $\frac{1}{8}$ -inch scale.

THE narrative of Baron Nordenskjöld's memorable journey into the interior of Greenland in 1883, is now appearing in instalments in the German journal *Globus*, profusely illustrated.

Two Expeditions are being sent out by the Russian Geographical Society this year: one, under J. P. Kusnetzow, to investigate the flora of the Northern Urals; and another, under Prince Massalsky, to continue his Transcaucasian researches, which include both botany and ethnography.

VALENCY AND RESIDUAL AFFINITY¹

II.

METALLIC CONDUCTION.—I do not propose in any way to discuss metallic conduction, but merely to call attention to some of the analogies between it and electrolytic conduction.

It is conceivable, and it would appear probable from the fairly regular manner in which the electrical resistance of most pure metals decreases as the temperature falls, the coefficients of change being practically very nearly the same in all cases, that the increase in resistance as temperature rises is mainly due to the increase in molecular inter-distances. As a rule, resistance increases on the passage of a metal from the solid to the liquid state, but there are noteworthy exceptions from which it would appear probable that even in pure metals conductivity to some extent depends on molecular composition: thus the conductivity of bismuth increases at the moment of fusion from 0.43 to 0.73 of that of mercury at 31°, and that of antimony from 0.59 to 0.84 (L. de la Rive, *Compt. rend.*, 1863, lvii., p. 691); it is well known that bismuth contracts considerably on fusion, and this is probably also the case with antimony. Again, according to Bouty and Cailletet (*ibid.*, 1885, c., p. 1188), the resistance of mercury decreases at the point of solidification in the ratio 4.08 : 1; this is a remarkable increase in

conductivity, and it is difficult to believe that it is wholly due to mere contraction of volume.

That the behaviour of alloys is worthy of far more attention than it has hitherto received appears most clearly from the few data at disposal. I would specially call attention to the curve given by Prof. Lodge as representing the specific conductivities of the copper-tin alloys (*Phys. Soc. Proc.*, 1879-80, iii., p. 158). The general resemblance of this curve to that given by F. Kohlrausch for mixtures of sulphuric acid and water appears to me to be in the highest degree suggestive.

Valency—Chemical Change.—Notwithstanding the fierce controversy which has been waged between the advocates of the doctrine of fixed valency, our views on the subject are still in an unfortunate degree unsatisfactory and indefinite. Even those—and they probably form a large majority—who regard valency as a variable, dependent both upon the nature of the associated radicles and the conditions—especially as to temperature—under which these are placed, often hesitate to attribute a valency sufficiently high to account for every case of combination; in fact, both parties agree in distinguishing “atomic” from “molecular” compounds, and differ only as to where the line shall be drawn.

It is difficult to over-estimate the importance of the theory of valency: its application has led to an enormous extension of our knowledge of carbon compounds especially, and it has furnished us with a simple and consistent system of classifying the mighty host of these bodies; but, on the other hand, it may be questioned whether it has not led us away from the search into the nature of chemical change, and even if the introduction of the terms saturated and unsaturated has not had a directly pernicious effect. The almost universal disregard of molecular composition as an important factor in chemical change in the case of solids and liquids, and the popular tendency to overlook the fact that our formulæ of such bodies are purely empirical expressions, has undoubtedly exercised a prejudicial influence.

No known compounds are saturated: if any were, such would be incapable, I imagine, of directly taking part in any interaction, and in their case decomposition would necessarily be a precedent change. The paraffins are apparently, of all bodies, the most inert and the most nearly saturated,¹ and next to them comes hydrogen—the unsaturated character of which is displayed in interactions such as occur at atmospheric temperatures between it and platinum and palladium, and when it displaces silver from silver nitrate or certain of the platinum metals from their salts. One of the most striking instances, perhaps, of popular error in this respect is water, which is always regarded as a saturated compound, although its entire behaviour, and especially its physical properties, characterise the molecule H₂O, I think, as that of an eminently unsaturated compound: I fail to see how, otherwise, we are to explain the high surface-tension and high specific heat of liquid water, its high heat of vaporisation, and its imperfectly gaseous behaviour up to temperatures considerably above its boiling-point, let alone its great solvent power and its tendency to form hydrates with a multitude of compounds—especially oxygenated compounds, be it added.

The theory was brought most prominently under the notice of chemists by Helmholtz in the last Faraday Lecture, that electricity, like matter, is, as it were, atomic, and that each unit of affinity or valency in our compounds is associated with an equivalent of electricity—positive or negative; that the atoms cling to their electric charges, and that these charges cling to each other. Thus barely stated, this theory does not appear to take into account the fact that the *fundamental* molecules, even of so-called atomic compounds, are never saturated, but more or less readily unite with other molecules to form molecular compounds—molecular aggregates; and unless the application of the theory to explain the existence of such compounds can be made clear, chemists must, I think, decline to accept it. The impression which the facts make upon the mind of the chemist certainly is (1) that no two different atoms have equivalent affinities; and (2) that affinity is a variable depending on the nature of the associated elements: but, owing to the recognised complexity of nearly all cases of chemical change, it is difficult to draw any very definite conclusion on this point.

If, however, the nature and properties of so-called molecular compounds generally be considered, and if an attempt be made to form any conception of their constitution, one striking fact is

¹ Revision and extension of a paper by Prof. H. E. Armstrong, F.R.S., communicated to the Royal Society last year. Continued from p. 572.

² It is probably more correct to place nitrogen first in the list, as being the most inert substance known.

discernible, viz. that the *metals* in them apparently retain the properties which they exhibited in the parent atomic compounds. Everyone knows the marked difference in properties of ferrous as contrasted with ferric salts: they differ not only in chemical behaviour, but also in their physical properties, and are readily distinguishable by their colour. The properties of the ferrous molecular compounds, however, are those of the simple ferrous compounds: ferrous potassium chloride, for example, $\text{FeCl}_2 \cdot \text{Cl}_2 \cdot \text{K}_2$, is a green salt much like ferrous sulphate. Facts such as these have led me to suggest that in such cases the formation of the molecular compound is due to the attraction of the negative element of the one "atomic" compound by the positive element of the other, the metal having no influence except that the amount of affinity of which the negative element possessed depends on the nature of the metal with which it is associated. It would in fact appear that hydrogen and the metals generally may be regarded as the analogues of the H_{2n+1} and $\text{C}_n\text{H}_{2n-7}$ hydrocarbon radicles, and that their compounds with negative elements may be likened to unsaturated hydrocarbons of the form $\text{C}_n\text{H}_{2n+1} \cdot \text{CH} \cdot \text{CH}_2$. We now that whenever such a compound enters into combination, the $\text{C}_n\text{H}_{2n+1}$ radicle takes no part in the change, combination of whatever kind being effected by means of the unsaturated radicle, $\text{CH} \cdot \text{CH}_2$, with which it is associated. I do not mean to contend that the metals are fully neutralised in their compounds, but merely that as a rule they behave as though they were saturated, just as do the $\text{C}_n\text{H}_{2n-7}$ radicles derived from the benzenes. There can be little doubt that an absolute distinction must be drawn between hydrogen and the metals on the one hand, and the non-metals on the other. Regarding the facts in the light of our knowledge of carbon compounds, it is difficult to resist the conclusion that the differences observed are due to differences in structure of the stuffs of which the elements as we know them are composed, the which differences condition perhaps a different distribution of the electric charge or its equivalent, in the case of each element.

ADDENDUM, April 1887.—I will now venture to call attention to the points which after a year's further consideration of the subject appear to me of special importance.

We are as far as we ever were from being able to define a "simple electrolyte" in the chemical sense—that is to say, to define the class or classes of compounds to which simple electrolytes belong. The investigation of the electrical behaviour of *these* compounds is therefore of the highest importance; it is essential, however, to bear in mind that not only must pure compounds be studied, but scrupulous care must be taken to guard against a possible decomposition of the substance under examination, either by heat alone, or by contact with the electrodes or the containing vessel. I believe that the conclusions which Clark based on his most interesting observations on the electrolysis of mercuric salts are vitiated by some such effect having been overlooked. The experimental difficulties surrounding the problem are therefore very great; and the more hopeful method of attacking it in many cases would appear to be that adopted in Kohlrausch's experiments on the specific resistance of water: in other words, to determine the influence of impurities.

A similar problem relates to the possibility of basing a definition of a non-metal as distinct from a metal on electrical properties. It is well known that no consistent definition can be given, and that we are at present obliged to base our division of the elements into metals and non-metals on general considerations. Now, although metals differ enormously in specific resistance, the metals as a class oppose a comparatively feeble resistance to the passage of electricity, and moreover resistance always increases as the temperature of a metal rises; it is therefore noteworthy that not only is the specific resistance of non-metals, such as carbon, phosphorus, selenium and sulphur, enormously great in comparison with that of metals, but that it diminishes as temperature rises: non-metals therefore behave in this respect as electrolytes, and as no special precautions have hitherto been taken to obtain pure non-metals for the purpose it is well worth while to ascertain if the specific resistance offered by non-metals be not the greater the nearer the approximation to purity.

To determine the valency or atom-fixing power of an element, according to present views, it is necessary to determine the number of atoms which can enter into direct association with an atom of the element considered; and this necessarily involves a discussion of the nature of "atomic" as distinct from "mole-

cular" compounds. The electrical hypothesis that an atom of unit valency carries unit charge, a dyad two such charges, a triad three, involves the more specific determination of the number of charges which are associated with any particular atom; but, again, on this hypothesis we have to determine whether any real distinction can be drawn between atomic and molecular compounds, and whether an atom having, say, unit charge, has the power of combining with more than a single atom. My own view certainly is that atomic and molecular compounds are specifically distinct; and that in the latter the number of atoms associated with what may be regarded as the grouping element or elements in the compound is in excess of the number of unit charges which the particular element or elements of necessity carry. Taking nitrogen as an example, it appears to me that the whole of the evidence to be derived from the study of nitrogen compounds is compatible with the assumption that nitrogen carries at most three charges: that it is a triad, in fact; and I am inclined to regard the ammonium compounds of the type $\text{NH}_3 \cdot \text{HX}$ as molecular compounds in which the residual affinities of N and X^1 serve to unite H_3N with X^1H . The more I study the question the more I incline to the belief that sooner or later we must accept Kekulé's ruling, unfashionable as this has become of late years.

The foregoing may appear to many to be but a restatement of the tenets of the advocates of the doctrine of fixed valency. It appears to me, however, that in the hypothesis of a definite unit charge—in other words, of a definite unit valency—we have a conception which for the first time enables us to frame a consistent doctrine of valency: a given atom may be assumed to carry under all circumstances a certain definite charge, and the problem which the chemist has to determine is, firstly, the number of unit charges associated with any particular atom, and, secondly, the manner in which the charge is, as it were, distributed when the atom is brought into association with other atoms. The following illustration will perhaps serve to make my meaning clear. Let unit charge or unit valency be regarded as a unit "line of affinity" passing through the atom, and let it be supposed that the atom moves upon this line of affinity with a degree of freedom depending on its nature; then it may be supposed that combination between two atoms consists in the overlapping of the lines of affinity. If each atom move out to the end of its line of affinity, no part of the line will overhang; the molecule will consequently be saturated; there will be no residual affinity. On this view the stability of a molecule will depend on the extent to which the lines of affinity of the constituent atoms *overlap*, and its tendency to associate with other molecules will depend on the extent to which the lines of affinity of the constituent atoms *overhang*. For example, it may be supposed that in ordinary chlorine the two atoms of which the molecule consists have moved out near to the end of the lines of affinity, so that there is but little overhang: the molecule is therefore of considerable stability, but forms unstable combinations with other molecules; in iodine, on the other hand, it may be supposed that the atoms are closer together, the lines of affinity overlapping less than those of chlorine; consequently the molecule is less stable than that of chlorine, but may form more stable molecular compounds as the lines of affinity overhang to a greater extent than do those of chlorine. It is possible in this way to understand that an atom which carries but unit charge—a monad, in fact—may enter into association with two distinct atoms. Adhering to the above symbolic language, it may even be suggested that perhaps the difference between a non-metal and a metal may be that the structure of the non-metals is such that they move with difficulty upon their lines of affinity, and probably in a very limited number of directions, and with unequal freedom in different directions; and that the structure of metals is such that they move with comparative freedom upon their lines of affinity, in some cases even with complete freedom, and almost equally so in several directions.

Speculations such as these are of value only if they serve as a guide to further inquiry. I venture to put them forward in the hope of inducing chemists to devote more attention to the study of molecular compounds, for it is in this direction that we are likely to gather most important information as to the valency of elements other than carbon and hydrogen. Of late years such inquiries have been but rarely pursued, and no doubt they are less attractive than those which result in some new synthesis or the determination of the constitution of an organic product; but their future value will be great, and the number of workers is

now so large that our sense of proportion demands that attention should no longer be directed almost exclusively to the study of carbon compounds.

There is one other problem to which I would direct attention—the study of liquid diffusion. No interpretation of the remarkable results obtained by Graham has yet been given, and they appear in many cases to be quite at variance with the results of chemical inquiries. But there is a striking parallelism to be observed between Graham's results and those obtained on determining the electrical conductivity of solutions. Applying the view which I hold regarding the electrolysis of composite electrolytes to liquid diffusion, it appears to me not improbable that diffusion may be to a large extent the outcome not so much of the proper motion of the molecules of the dissolved substance as of a propulsive action exercised by the molecules of the solvent. The molecules in a mass of water we know may be assumed to be moving in every direction, and this being the case they would tend to carry other molecules along with them: the extent to which this action would take place would, however, largely depend on the attraction which exists between the molecules of water and those of the dissolved substance. From this point of view it appears of considerable importance to extend the study of liquid diffusion to dilute solutions. It may be added that this hypothesis would probal y account for the behaviour of colloids, as these are known to be chemically neutral substances; in fact, they are compounds almost destitute of residual affinity.

UNIVERSITY AND EDUCATIONAL INTELLIGENCE

KING'S COLLEGE, LONDON.—Prof. W. Grylls Adams, F. R. S., will deliver a course of lectures on Electro-Magnetism, Magneto-Electricity, the Testing of Motors and Dynamos, Electric Lighting, and Transmission of Power, during the present Term.

A course of practical work in Electrical Testing and Measurement with especial reference to Electrical Engineering will also be carried on under his direction in the Wheatstone Laboratory.

The lectures will be given once a week—on Mondays, at 2 p.m.,—and the Wheatstone Laboratory is open daily from 1 to 4, except on Saturdays.

SOCIETIES AND ACADEMIES

LONDON

Royal Society, March 31.—“Note on the Development of Voltaic Electricity by Atmospheric Oxidation.” By C. R. Alder Wright, D.Sc., F. R. S., Lecturer on Chemistry and Physics, and C. Thompson, F. C. S., Demonstrator of Chemistry, in St. Mary's Hospital Medical School.

Whilst investigating processes for the manufacture of cuprammonium hydroxide (now used commercially on a considerable scale) we noticed that if the air supply be greatly in deficiency relatively to the bulk of the copper, under certain conditions the solution is but little coloured, containing copper dissolved principally as cuprous, and not as cupric, oxide. This might, perhaps, be anticipated *a priori*, inasmuch as it is well known that blue cupric solution in ammonia, when digested with metallic copper in the absence of air, takes up a second equivalent of copper, becoming colourless cuprous solution; but further experiments seem to indicate that the production of cuprous oxide under the oxidising influence of a limited supply of air is the primary action, and not merely a secondary result.

When a sheet of copper is kept out of direct contact with air by being immersed in ammonia solution, oxidation of the metal is gradually effected by virtue of the dissolving of oxygen from the air at the surface of the fluid, and diffusion of the oxygen solution to the vicinity of the copper. This action is an extremely slow one if the copper be covered by some depth of fluid, and if the setting up of convection currents through heating or evaporation be prevented by keeping the vessel perfectly at rest and at an equable temperature, and well closed to prevent escape of ammonia; but if these precautions be neglected it goes on much more rapidly, and the liquid comparatively soon becomes blue; it can, however, be also materially accelerated by arranging horizontally on the surface of the fluid a plate of platinum or other electrically conducting material not chemically acted upon by the fluid, and connecting this by means of a wire, &c., with the copper plate. The upper conductor, or *aération*

plate as it may be conveniently termed, being simultaneously in contact with the atmosphere and fluid, attracts to its surface a film or aura of condensed gases, the oxygen of which becomes gradually transferred to the copper, a voltaic current circulating through the fluid and connecting wire. Cuprous, and not cupric, oxide thus results, dissolved in the ammonia solution in contact with the copper plate, the mechanism of the reaction being conveniently represented by the scheme—

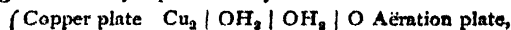

water being represented as the electrolyte for simplicity's sake. The air film on the aération plate being constantly renewed by absorption from the atmosphere, the process goes on continuously as long as the two plates are connected together by the wire. This wire may be lengthened at will so as to make the current which passes through it whilst the action goes on relatively stronger or weaker according to the amount of resistance introduced into the circuit; and by including a galvanometer or silver voltameter in the circuit the ordinary phenomena due to the passage of currents are readily recognisable.

The maximum E. M. F. thus capable of development varies considerably with the strength of the ammoniacal solution, being the less the weaker the fluid; addition of common salt or of sal ammoniac to the liquid notably increases the E. M. F. and diminishes the internal resistance of the cell. Spongy platinum in a thin layer as the aération plate gives higher values than thin platinum foil; the highest numbers thus obtained, using pretty concentrated ammoniacal brine, fell but little short of 0.8 volt; or somewhat less than the E. M. F. corresponding with the heat of formation of cuprous oxide,¹ since, according to Julius Thomsen, $\text{Cu}_2\text{O} = 40,810 = \text{about } 0.88 \text{ volt}$.

It is obvious that this copper atmospheric oxidation cell has a close connexion with the “air-battery” described in 1873 by Gladstone and Tribe (Roy. Soc. Proc., vol. xxi. p. 247) in which what is virtually an “aération plate,” consisting of a tray full of crystals of silver is used, opposed to a copper plate immersed in a solution of copper nitrate. Cuprous oxide is formed in both cases, in virtue of the indirect combination brought about between the oxygen of the air and the copper: but there is this great difference between the two (apart from the cuprous oxide being deposited as such in Gladstone and Tribe's arrangement, and being kept in solution in ours), that in the one the cuprous oxide is formed at the surface of the copper plate itself, and in the other at the surface of the aération plate. This essential difference is embodied in the above depicted scheme as compared with the following one which represents the action in Gladstone and Tribe's cell:—

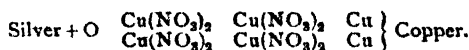

One result of this difference is that the surface of the aération plate in the ammonia cell is kept constantly the same, whereas in the nitrate cell it is continually changing its character through deposition of solid cuprous oxide on the silver: in consequence of this deposition, whilst the E. M. F. of the ammonia cell, *ceteris paribus*, is constant, that of the nitrate cell is continually varying. Gladstone and Tribe, moreover, only obtained an E. M. F. of $\frac{1}{3}$ to $\frac{1}{2}$ of a Daniell, or about 0.104 to 0.143 volt, even under the most favourable conditions, viz. when the cell was connected with an electrometer; whilst four or five times this amount is indicated by the cells examined by us.

Following up the ideas suggested by the above observations, we are making a number of experiments with a variety of analogous combinations, in which atmospheric oxidation constitutes the essential chemical action taking place; by varying the nature of the aération plates, the metals dissolved, and the liquids employed (as also by substituting other gases, e.g. chlorine, for air), a large number of combinations are obviously obtainable. Some of those which we have so far examined present points of considerable interest, the oxidising action exerted under favourable conditions being strongly marked: so much so that certain metals, e.g. mercury and silver, not ordi-

¹ The actual chemical change going on in the cell is the synthesis of cuproso-ammonium hydroxide, so that the (unknown) heat of solution of cuprous oxide in ammonia should be added to this to obtain the total heat development.

prone to atmospheric oxidation, can under suitable conditions be gradually oxidised and dissolved in appropriate fluids, just as the copper is dissolved in the ammonia in the cell as described; these actions, moreover, being accompanied by the development of currents of strength sufficient to cause sensible amounts of electrolytic decomposition outside the cell, e.g. in a silver voltameter.

Action of Caffein and Theine upon Voluntary Muscle.—T. Lauder Brunton, M.D., F.R.S., and J. Theodore Cash, M.D.

Caffein and theine both cause rigor in the voluntary muscles of frogs (*Rana temporaria*). The action is, however, very variable, the rigor being sometimes exceedingly well marked, at other times not observable. Theine seems to be rather more powerful than caffein, but the quantitative difference between them is slight. There is, however, a marked qualitative difference between them, inasmuch as theine tends to produce rhythmical contractions in the muscle. A variation is observed in the action of the alkaloids on the different muscles of the same frog.

The addition of lactic acid to a solution of theine or caffein causes the rigor to appear sooner, develop more rapidly, and in a greater maximum, and a somewhat similar effect is produced by calcium chloride. Potash retards and diminishes the action of theine or caffein. One phenomenon which seems deserving of attention is the rhythmic contraction of the muscle produced by theine. This rhythm is so slow that it would attract attention unless a very low rate of speed were used in the recording apparatus; it is sometimes as slow as from three to four contractions per hour; it may continue for twenty hours. In one instance we observed the remarkable phenomenon which we have given the name of pseudo-rigor; in this experiment the application of the theine was followed by slight relaxation of the muscle, to this succeeded an equal contraction, which then followed great relaxation below the normal, so great indeed that the negative curve below the abscissa strongly resembled the positive curve of contraction due to rigor in most of our experiments.¹

Contributions to our Knowledge of the Connexion between Chemical Constitution and Physiological Action. Preliminary Communication on the Action of certain Aromatic Bodies.—By T. Lauder Brunton, M.D., F.R.S., and J. Theodore Cash, M.D. The distinctive action of the lower members of the fatty series is neither stimulant and anæsthetic action on the nerve-centres.

The members of the aromatic series also affect the nervous system, but they appear to affect the motor centres more than sensory, so that instead of producing anæsthesia, like the members of the fatty series, they tend rather to produce tremor, convulsions, and paralysis. Benzene, chlorobenzene, bromobenzene, and iodobenzene are all somewhat similar in their action on frogs; the halogen radicals not modifying the action of the benzene to such an extent as they do in the case of nonium salts. The voluntary muscles are weakened by them, and there is a slight tendency to paralysis of the motor nerves; but the action is chiefly exerted upon the brain and spinal cord. The brain is first affected, as shown by general rigidity and disinclination to move. Next the cord is affected; the motions are imperfectly performed, and there is a tendency to general tremor on movement resembling that observed in disseminated sclerosis; sometimes, however, the tremor is observed independently of movement.

The addition of hydroxyl to the benzene nucleus intensifies convulsant action, so that oxybenzene (carbolic acid) and cybenzene cause convulsions in frogs, and trioxybenzene causes jerkings, though of a slighter character.

Zoological Society, April 5.—Prof. W. H. Flower, F.R.S., President, in the chair.—The Secretary read a report on the operations that had been made to the Society's menagerie during the month of March 1887.—Mr. F. Day exhibited and made remarks on a specimen of a Mediterranean fish (*Scorpana* sp.), taken by a trawler off Brixham early in March last, new to the British fauna.—Mr. J. H. Leech exhibited some specimens of new butterflies from Japan and Corea, and gave an account of his recent journeys to those countries in quest of Lepidoptera.—The Secretary read a letter addressed to him by the Rev. G. H. R. Fink, of the Cape Colony, respecting the

¹This phenomenon is difficult to explain, but it suggests the possibility of an inverse as well as a longitudinal contraction in muscular fibre.—*ibid.* p. 587.

killing and eating, by a shrew, of a young venomous snake (*Sepeidon hamachates*).—Prof. Flower, F.R.S., communicated, on behalf of Messrs. John H. Scott and T. Jeffery Parker, of the University of Otago, N.Z., a paper containing an account of a specimen of a young female *Ziphidus*, which was cast ashore alive at Warrington, north of Dunedin, New Zealand, in November 1884.—Mr. Richard S. Wray read a paper on the morphology of the wings of birds, in which a description was given of a typical wing, and the main modifications which are found in other forms of wings were pointed out. One of the principal points adverted to was the absence, in nearly half the class of birds, of the fifth cubital remex, its coverts only being developed. The peculiar structure of the wings in the Ratitæ and the *Sphenisci* was also commented upon.—A communication was read from the Rev. H. S. Gorham, on the classification of the Coleoptera of the division Langurides. The author pointed out the characters which, in his opinion, were available for the systematic arrangement of this family of Coleoptera, and for its division into genera. The subject had hitherto not received the attention it deserved, and several errors had gained currency, owing to the hasty and insufficient way in which the structure of these insects had been analysed. He added an analytical table of about forty genera, many of those proposed being new. Further notice of the American genera would soon appear in Messrs. Godman and Salvin's "Biologia Centrali-Americana."

Mathematical Society, April 7.—Sir J. Cockle, F.R.S., President, in the chair.—The following papers were read, or taken as read:—On the intersections of a circle and a plane curve, by Prof. Genese.—A new theory of harmonic polygons, by the Rev. T. C. Simmons.—On some properties of simplicissima, with especial regard to the related spherical loci, by Mr. W. J. C. Sharp.—On Briot and Bouquet's theory of the differential equation $F(u, \frac{du}{dx}) = 0$, by Prof. Cayley, F.R.S.—

Two points in the plane of a triangle and a cubic through them, by R. Tucker.—A tetrahedral note, by Dr. Wolstenholme.

EDINBURGH

Royal Society, April 4.—Dr. J. Murray, Vice-President, in the chair.—Prof. Tait communicated a note by Prof. Cayley, on a formula for $\Delta^n \sigma^n / n!$, when n and i are very large numbers.—Mr. R. Kidston read the first part of a paper on the fossil flora of the Radstock series of the Somerset and Bristol coal-fields (Upper Coal-measures).—Dr. Sang read a paper on the achromatism of the four-lens eye-piece, describing a new arrangement of the lenses. He also read a note on an effective arrangement for observing the passage of the sun's image across the wires of a telescope.—Prof. Turner read a communication by Mr. F. E. Beddard, on the structural characteristics of certain new or little-known earthworms. Five new species found in Australia and New Zealand were treated of.—Prof. J. Geikie discussed the geology and petrology of St. Abb's Head.

PARIS

Academy of Sciences, April 12.—M. Janssen, President, in the chair.—On the relations that exist between cyclones and concurrent storms and hurricanes, by M. H. Faye. From an attentive study of the synoptical storm charts of the United States Signal Service, the author is able to confirm the conclusions already drawn by M. Marié-Davy from the meteorological observations made at the Paris Observatory so far back as the year 1864. It is shown (1) that tornadoes, hurricanes, and hailstorms are simply secondary phenomena directly associated with the central cyclonic movement; (2) that in the United States their trajectories have no general relation either to the isobars or to the normal atmospheric currents; (3) that these relatively short trajectories are parallel to the vast cyclonic trajectories at the moment when these local phenomena arise; (4) that they all lie on the right flank of the cyclone itself, which may thus be regarded as a complex meteorological system accompanied on its right side by whole colonies of destructive tornadoes and hurricanes with their attendant waterspouts, hailstorms, and torrential downpours, all moving together across seas and continents. The whole movement is regulated by the simple law of the mechanics of fluids, which determines the formation of spirals or vortices in the upper atmospheric regions. The surprising variety of the physical effects produced by the movement is simply due to the descending vortex, which, as in our electric machines, suffices to bring into contact and set in violent motion aerial masses lying far apart, with their consequent differences of temperature, and aqueous particles either frozen or

in a state of vapour and of positive or negative tension.—On the term "latex" in botany, by M. A. Trécul. In reply to some recent objections made to his comprehensive use of this term, the author here justifies its application both to the contents of the laticiferous vessels and to the product of the secreting ducts. The numerous facts brought together in this communication tend clearly to establish the fundamental resemblance between the physical and physiological properties of the contents of the laticiferous vessels properly so called, and of the secreting tubes, so that these two classes of vessels are properly grouped together under the common designation of vessels of the latex.—On some essays made at sea with Capt. Fleuriats' new collimating gyroscope, by M. de Jonquières. The results are given of the observations made with this instrument by Lieut. Baule, of the steamer *La Gascogne*, during a recent trip from Bordeaux to Brazil. Although this was the first application of the apparatus, the observer was able by its means to record the rolling of the vessel with considerable accuracy.—On earthquakes, by M. Oppermann. The author substantially accepts the general view of seismologists, that these disturbances are mainly due to the pressure exercised on the upper crust by the aqueous vapour formed at great depths below the surface by filtration through fissures or porous rocks.—On the winter egg of Phylloxera, by M. P. de Lafitte. The author replies to some misleading statements recently made by M. Donnadieu, and calculated to affect the issue of the experiments which are now being carried on throughout the wine-growing districts of France.—On a complementary experiment relative to waterspouts, by M. Ch. Weyher. The experiments hitherto described had reference only to the artificial formation of the "buisson," that is, of the two inverted cones superimposed at their summits. Here a further process is described, by means of which the author has succeeded in producing the complete waterspout, with its tube of vapour attached on the one hand to the centre of the *buisson* and on the other to the centre of the revolving drum placed 3 metres above the surface of the water. To effect this all that is needed is to project a jet of vapour to the neighbourhood of the axis of the vortex, or, better still, simply to heat the water in the large reservoir sufficiently to cause some vapour to rise.—A study of the alkaline vanadates (continued), by M. A. Ditte. Here are treated the vanadates of soda: VO_5NaO ; $2VO_5NaO$; $3VO_5NaO$; $3VO_5NaO$; VO_5NaO ; VO_5NaO ; VO_5NaO ; and VO_5NaO .—On the upheaval of the south-west coasts of Finland, by M. Venukoff. The topographic surveys recently carried out in Finland show once more that the shores of the Baltic are continually rising. Since the surveys of 1810–15 several islands have become peninsulas, while many shallows have become islands or beaches. On the south-west coast and in the neighbouring Aland Archipelago many places are pointed out by the inhabitants which a few years ago were under water, but which are now grazing-grounds, market-gardens, or corn-fields. The local authorities are now taking steps, by means of which the progress of this geological phenomenon may in future be determined with absolute certainty and accuracy.—The sudden death was announced of M. Thollon in the midst of his labours connected with the construction of a great solar chart, on which the distinction between the telluric and solar rays would have been indicated. M. Thollon's name will always be remembered in connexion with spectroscopic studies, which have been greatly advanced by his improved spectroscope and by the device suggested by him for distinguishing rays of solar origin from those due to the terrestrial atmosphere.

BERLIN

Physical Society, April 1.—Prof. von Helmholtz in the chair.—Dr. Pernet spoke on the comparison of barometers, and drew attention to a number of sources of error which must be avoided when reading off a barometer. The speaker has carried out a series of comparisons with corrected standard barometers, aneroid barometers, and the standard barometers of different stations. He finds that the standard barometers of Berlin and Paris correspond exactly within the limits of errors of observation; aneroids do not yield anything like the same exactness that may be obtained with syphon-barometers.—Dr. Pernet also brought a new form of standard mercurial thermometer before the Society, and explained its construction. It consists essentially of the usual bulb and fine tube, which is widened out above and below into two receptacles each of which is capable of holding a mass of mercury corresponding to a column representing 50°. By means of this arrangement the instrument is easily graduated, and admits of any desired adjustment of the zero and gradua-

tion; also by varying the amount of mercury with which it filled the same exactness in reading which is possible between and 50° can be obtained even up to 200°.—Dr. Kötter spoke the mean rate of flow of a fluid from a small aperture. The rate, as is well known, depends not only upon pressure, weight, &c., but upon a certain constant which is called the coefficient of efflux, and which has been determined to be 0.62. The speaker gave an account, in their historical order, of a number of researches which have been made with a view to determine this coefficient mathematically, and then proceeded to explain his own methods of calculation, which lead to the value $\frac{1}{2}$ —established by Kirchoff and Rayleigh.—Dr. König exhibited direct-vision spectroscopes constructed by Wernicke, which contained in a glass tube instead of a wooden one, and the admits of the internal arrangement of the instrument be seen.

BOOKS, PAMPHLETS, and SERIALS RECEIVED

Journal of the College of Science, Imperial University, Japan, vol. Part 1 (Tokio).—Monthly Weather Report of the Meteorological Office October 1886.—Beiblätter zu den Ann. der Physik und Chemie, 1887, No. 1 (Barth, Leipzig).—Journal of the Society of Telegraph-Engineers and Electricians, No. 65, vol. xvii. (Spou).—Journal of Anatomy and Physiology, April (Williams and Norgate).—Mind-Cure on a Material Basis: S. Titcomb (Trübner).—Annalen der k. k. Universitäts-Sternwarte in Wien, Band, Jahrgang 1884 (Williams and Norgate).—Quarterly Journal of Microscopical Science, March (Churchill).—The Auk, April (New York).—Journal of the Royal Microscopical Society, December 1886 and April 1887 (Williams and Norgate).—Bulletin of the American Geographical Society, vol. xix. No. 1, 1887 (New York).—Annalen der Physik und Chemie, No. 5 (Barth, Leipzig.)

CONTENTS

Goebel's Outlines of the Classification of Plants	5
Mineral Physiology and Physiography	5
Our Book Shelf:—	
Mrs. Caddy: "Through the Fields with Linnæus"	5
Ångström: "Sur une nouvelle Méthode de faire des Mesures absolues de la Chaleur rayonnante"	5
Letters to the Editor:—	
Vitality and its Definition.—F. Howard Collins	5
Oldhamia.—Prof. T. G. Bonney, F.R.S.	5
Disappearance of Bishop's Ring in Colorado.—G. H. Stone	5
Iridescent Clouds.—G. H. Stone	5
A Claim of Priority.—Prof. H. S. Hele Shaw	5
The Vitality of Mummy Seeds.—George Murray	5
Solar Halos.—R. T. Omond. (Illustrated)	5
On the Character of the Beds of Chert in the Carboniferous Limestone of Yorkshire.—George J. Hinde	5
The Zirconia Oxy-hydrogen Light.—Lewis Wright	5
The Production of Newton's Rings by Plane Soap-Films.—H. G. Madan. (Illustrated)	5
Barnard's Second Comet.—John I. Plummer	5
Sunspots.—Dr. M. A. Veeder	5
Ozone.—Dr. A. Tucker Wise	5
Electrical Discharges in the Doldrums.—David Wilson-Barker	5
Green Light at Sunrise and Sunset.—Prof. A. Riccio	5
A Sparrow chasing Pigeons.—J. Jenner Weir	5
A Question for Chemists.—Wm. West	5
The Paris Astronomical Congress	5
Homeric Astronomy, I. By A. M. Clerke	5
Rainband Observations at the Ben Nevis Observatory. By A. Rankin	5
Do Scorpions Commit Suicide?	5
The Mythical Zoology of the Far East	5
Notes	5
Our Astronomical Column:—	
The U.S. Naval Observatory	5
Researches on the Sun's Diameter	5
Astronomical Phenomena for the Week 1887	
April 24–30	5
Geographical Notes	5
Valency and Residual Affinity, II. By Prof. H. E. Armstrong, F.R.S.	5
University and Educational Intelligence	5
Societies and Academies	5
Books, Pamphlets, and Serials Received	6

THURSDAY, APRIL 28, 1887

PRACTICAL ELECTRICITY

Practical Electricity. By W. E. Ayrton, F.R.S. (London: Cassell and Co., 1887.)

PROF. AYRTON'S book on Practical Electricity fills a gap, and is well fitted for the purpose for which its author has designed it. The book comprises the substance of the first year's course for students of electrical technology in the City and Guilds Central Institution at South Kensington, with some additional matter, which is chiefly in small type. The subject of Current is treated first, then comes Electromotive Force or Potential Difference, and afterwards Resistance. This is undoubtedly the logical order, though, as Prof. Ayrton points out, this sequence appears complicated to the minds of learners, from the fact that in the definitions of the Paris Congress the volt is made to depend on the ohm and the ampere. The practical units, ampere, ohm, volt, &c., are used throughout, but a little more space might have been given with advantage to the definitions of these units. Take, for instance, the definition of an ampere,

6. After showing by means of a most instructive and well-arranged experiment (Fig. 1) that a current produces magnetic, chemical, and thermal effects, and further, that the chemical changes are the same in two or more volta-meters of the same kind, Prof. Ayrton proceeds:—
 "We shall therefore define the strength of a current as being directly proportional to the amount of chemical decomposition produced in a given time; and the current that deposits 0.0011815 gramme or 0.017253 grain of silver per second on one of the plates of a silver voltameter, the liquid employed being a solution of silver nitrate containing from 15 to 30 per cent. of the salt, we shall call an ampere," and take it as our unit current." But frequently a beginner will at once wish to know why these special numbers, which will seem to him unnecessarily complex, should have been taken. Why not select .001 gramme of silver rather than 0.0011815? will be an obvious question, to which no answer is given. Surely, too, four significant figures would be sufficient. Besides, this is not the definition of ampere adopted by the Paris Congress, and it involves the experiments of someone on the electro-chemical deposition of silver. The experiments given in the early part of Chapter II. do not need the previous definition of the *unit current*, and from them the fact that a current exerts on a magnet a definite force depending on its strength and (§ 22) on the dimensions and position of its circuit is established. Thence the idea of the current which exerts on a definite magnet a unit force is easily reached, and from this we get the ampere of the Congress definition, which is found, by careful experiment, to deposit so many grammes of silver per second.

So, too, the definition of the "volt" would have been clearer if the excellent illustration of difference of potential given in § 40, Fig. 28, had been carried a little further, and it had been pointed out that, just as the water loses potential energy in falling from one level to another, and that loss is measured by the quantity of water multiplied

by the difference in pressure, so the electric current loses energy in passing from one point to another, and that loss is measured by the quantity of electricity multiplied by the difference of electrical potential. But these, perhaps, are points which can be better brought out by a teacher in explaining difficulties to his class.

The book is, we believe, the first in England which accepts distinctly the resolutions of the Paris Congress as a basis. Another novelty to be found in it is the use of the letters P.D. (potential difference) for the old abbreviation E.M.F. This is a change for which, if it can be satisfactorily introduced and accepted, all teachers will be thankful, for it will get rid of the confusion existing between the resultant electrical force at a point, and the electromotive force between two points, which is not a force at all.

The plan of the book has been already indicated. Starting from the definition of an ampere, the various means of measuring currents are described, and full

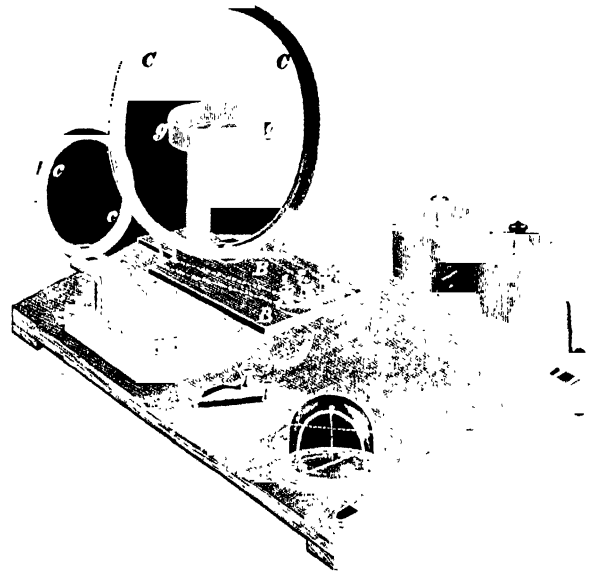

FIG. 15.

details are given of the methods for carrying out the experiments, for recording results graphically and otherwise, and for drawing conclusions from the experiments. The illustrations show clearly the arrangement of apparatus in each case. In Prof. Ayrton's laboratory the apparatus required for any one series of observations is mounted permanently on the same board; the student finds everything ready, and the necessary connexions made when he begins. As to the desirability of this, there will no doubt be some difference of opinion; but with large classes of beginners some such plan is necessary. Thus, Fig. 15 shows the apparatus for investigating the action of a current on a magnet. The large coil C C is so arranged that the current can be made to traverse it eight, twelve, or sixteen times, and its effect on the magnet *gg* observed; or the coil C C can be replaced by *cc* of half the radius, which has four turns on it; or, again, C C can be used simultaneously with *cc*, the current being

¹ We are indebted to Messrs. Cassell for the blocks used to illustrate this article.

sent in opposite directions through the two. ww is a resistance by means of which the current may be varied at will, and G a galvanometer.

Chapter III. introduces us to difference of potential, and here the writer describes in a practical form the experiments for the verification of some of the ordinary laws of statical electricity.

Ohm's law and its proof follow in Chapter IV., and it is shown that the resistance of a conductor remains unchanged so long as its other physical conditions are the same. § 80 gives the definition of the "legal ohm." It is not quite accurate to speak of its having been legalised, at any rate in this country; though, as the letter from the B.A. Committee on Electrical Standards, which is printed at the end of the preface, shows, the question of its adoption as a legal standard is now before the Government. Various methods of comparing resistances follow, with full practical details, but the important one due to Prof. G. C. Foster, for comparing two nearly equal resistances, has been omitted from § 97.

Batteries and other forms of current-generators are next considered, with details as to their construction and



FIG. 157.

use; and an account of the methods of determining their E.M.F. and resistance is given.

"Insulation" is the title of Chapter VI., and many of the practical hints given under this head are of great value.

In the next chapter, condensers, and the methods of constructing them and of measuring their capacities, are treated of. We find also a chapter devoted to commercial ammeters and voltmeters, which gives in an easily accessible form particulars as to some of the best known of these instruments, with practical methods of testing and calibrating. In Fig. 157 we have the arrangement of apparatus for comparing an ammeter with a silver voltameter. R is an adjustable resistance of a useful character, made of a number of washers of carbonised cloth which can be pressed into close contact by a screw. Latimer Clark's cell is described in § 214, in the H form. A simpler pattern consists of a test-tube with a platinum wire sealed through the bottom. The end of this is covered with pure mercury, and above this is a layer of mercurous sulphate, with a saturated solution of sulphate of zinc above all. A rod of clean zinc dips

into the zinc sulphate passing through the cork which closes the test-tube, and the whole is kept tight with marine glue.

In an appendix Kirchhoff's laws of divided circuits are considered. The method of treating such problems introduced by Maxwell, and which has recently been illustrated at some length by Prof. Fleming, is also referred to.

Another point of importance which calls for notice is the number of examples introduced by way of illustration; some of these are completely worked out, others left as exercises for the student.

The book concludes with some specimens of the instructions for experiments which are given to students at the City and Guilds Institution, with the apparatus with which each experiment is performed. Of these instructions there are four; and many who use the book will wish their number was larger. We will close this notice by quoting the last of them.

To calibrate an ammeter by means of a silver voltameter (the apparatus required has been figured above):—

"PRELIMINARY.—The voltameter consists of a platinum dish containing a 25 per cent. solution of silver nitrate, and in which a silver plate is immersed. An adjustable carbon resistance is provided, by means of which the current passing through the voltameter can be maintained constant during each experiment, and can be varied in the different experiments.

"EXPERIMENTS.—(1) Carefully clean, dry, and weigh the platinum dish, the approximate weight of which is 78 grammes.

"(2) Pour the solution of silver nitrate into the dish, and place it on the three brass pins provided for its reception, and which are electrically connected with the left-hand binding-screw on the board. Immerse the silver plate in the solution, and clamp it in such a position that its edges are equally distant from the sides and bottom of the dish.

"(3) Turn the small milled head at the top of the ammeter so that the pointer of the ammeter comes opposite the zero on the scale, if not there already. Place the copper connecting-wire in the mercury cups marked and C (which cuts out the voltameter), and adjust the carbon resistance until a convenient current flows round the ammeter. Remove the connecting-wire.

"(4) Quickly insert the connecting-wire in the mercury cups marked A and B , carefully noting the instant at which the circuit was completed. Allow the current to pass for a convenient time (ten to thirty minutes, according to the strength of the current used), and keep the current constant by the adjustable resistance. Note the temperature of the room during the experiment, and, at the end of the interval decided on, quickly break the circuit.

"(5) Empty the solution from the dish into its bottle and carefully wash the deposited silver with distilled water. Then fill the dish with distilled water, allow it to stand ten to fifteen minutes. Again wash with water, alcohol, and ether, dry over the spirit-lamp, and cool in the desiccator.

"(6) Carefully determine the increase of weight due to the silver deposited on the dish.

"(7) Calculate the strength of current used in the experiment, assuming that one ampere deposits 1.118 milligrammes of silver per second.

"(8) Repeat the experiment with several different strengths of current.

"(9) Tabulate your results in some convenient and write them with your name on the card, on which will find recorded the results of previous experiments."

SPOLIA ATLANTICA

Spolia Atlantica. (1) Contributions to the Knowledge of the Salpidæ, by M. P. A. Traustedt; (2) Remarks on some of the Oceanic Annulata, by G. M. R. Levensen; (3) Contributions towards the Morphology and Systematic Arrangement of the Pteropoda, by J. E. V. Boas. (Copenhagen, 1885-86.)

THE three monographs which at the instance, and under the supervision, of the Directors of the Zoological Museum of Copenhagen, have been included in the quarto volume under the title of "Spolia Atlantica," originally appeared in the Transactions of the Danish Royal Society of Natural Sciences. But although bound together, each monograph in this *édition de luxe* is complete in itself, with separate title-page, table of contents, scriptive plates, and all other necessary means of separate reference, while the convenience of readers not acquainted with Danish has been amply considered by the addition of Latin and French translations of the descriptions of the animals, and of many other important parts of the text.

The first of this triplet of monographs, which deals with the so-called "aggregate" and "solitary" forms of several species of Salpæ, is based on a study of the exceptionally complete collections preserved in the Zoological Museum of Copenhagen, for which that institution is mainly indebted to Prof. Steenstrup, at whose suggestion and under whose direction Herr Traustedt compiled his memoir. The monograph presents a clear and comprehensive description of all the well-established species of Salpæ with their distinctive dual forms, and unqualified praise may be given to the care with which the figures have been drawn, and the admirable manner in which, by means of pale blue outlines, the delicacy and transparency of the bodies of the animals have been represented. In treating of the Salpidæ, it is impossible to forget how much of our knowledge of these curious animals is due to the observations of Chamisso, the clever author of "Peter Schlemihl," who, while serving as naturalist in the exploring expedition of the Russian commander Kotzebue, first discovered that the "aggregate" or chain Salpæ and the "solitary" Salpæ were not distinct species, as had been supposed, but only parts of the perfect organism of one species. By the discovery of this fact, which Chamisso ingeniously, but, as subsequent investigations have shown, too fancifully, explained on the hypothesis that these animals were subject to a law of "alternation of generations," new and highly important paths of morphological inquiry were opened. Yet, regularly enough, nearly thirty years passed after the publication, in 1819, of Chamisso's treatise "De Animalibus quibusdam e Classe Vermium Linneana (de Salpis)" before his observations were tested by further scientific investigation. About the middle of the century Meyen and Vogt turned their attention to the curious and interesting phenomena connected with the embryonic development of the Salpæ. These inquiries were soon followed by the still more important researches of Prof. Dohrn and Huxley, the latter of whom in a paper entitled "Observations upon the Anatomy and Physiology of Salpæ and Pyrosoma," which appeared in the Phil. Trans. in 1841, has shown that Chamisso erred in his explanation

of the nature of a "chain Salpæ," which, to use Mr. Huxley's words, "is nothing more homologically than a highly individualised generative organ."

Herr Traustedt does not enter into the question of the embryonic development of the Salpidæ, and hence his work gives no information regarding the physiology of these animals, nor does he in any way refer to the various hypotheses that have been advanced in explanation of the character of the "aggregate" and "solitary" forms. For such information the student must go elsewhere. As a guide to the anatomical structure of both forms in the eleven species described and drawn by the author, the memoir will, however, be found of great service, while it contains much useful information as to the geographical distribution of these animals not to be found elsewhere.

In the treatise on "Some Oceanic Annulata" Herr Levensen supplies many interesting details regarding various members of the families Alciopidæ and Typhloscolocidæ, together with descriptions of several species of Sagitta, to which are added lists of their geographical distribution. In this, as in the memoir on the Pteropoda, the illustrations are worthy of all praise.

The memoir by Dr. Boas, which constitutes the last and longest of the series, treats at great length of the morphology, systematic arrangement, and geographical distribution of the Pteropoda. The materials employed by the author were derived in part from the extensive collections in the Zoological Museum of Copenhagen made by, or under the direction of, Prof. Steenstrup, and in part from numerous specimens placed at the writer's disposition by Profs. Dohrn, Möbius, Leche, and Spengel. It is worthy of note that a very large proportion of the specimens referred to as belonging to the Museum of Copenhagen were obtained from amateur collectors; Danish naval officers, captains of merchant ships, and travellers having responded with alacrity to Prof. Steenstrup's appeal for help in obtaining samples of these and other animals from remote regions.

OUR BOOK SHELF

Complete Hand-book on the Management of Accumulators. By Sir David Salomons, Bart. Second Edition, revised and enlarged. (London: Whittaker and Co., 1887.)

THE author has for some years past had an installation at his country residence for the purpose of lighting it and for working motors which drive the machinery in his large and well-equipped workshop. He has used accumulators, as he informs us, ever since they may be said to have been produced in commercial form in 1882. No expense nor trouble have been spared in making this installation a model one, and experiments have been made on many points in connexion with the subject. As the whole installation has been made and worked under his immediate personal superintendence, he has acquired a considerable amount of experience, the result of which, as far as it regards the management of accumulators, he places before the public in this work.

After a general description of cells of the E.P.S. and Elwell-Parker type, he proceeds to give directions for setting up and charging them. The causes of, and remedies for, "buckling" and "scaling" are discussed. The harm caused by too rapid a discharge is pointed out, and methods for preventing it are explained, as well as various devices for regulating the E.M.F. of the charging current and that on the line. The method of cleaning and "re-pasting" the plates is explained, and various

hints are given for the management of the battery. In an appendix is a description of the arrangement of his accumulator house, a photograph of the interior of which forms the frontispiece to his book. He also gives a brief account of the history of the installation, from which we learn that the total cost of buildings and installation has been about 6000*l.*, that the number of lamps is about 500 of 20-candle power, but that the greatest number used at any one time has rarely exceeded 200, and that an arc lamp taking 40 or 50 amperes and one or two motors have been used together with them. The expenses—including wages, coal, oil, waste, washers, repairs, lamp renewals, &c.—were, in 1886, 210*l.*, or at the rate of $\frac{1}{2}$ *d.* per 20-candle lamp per hour. He does not, however, say anything as to the cost of the accumulators; and as to the length of time which they may be expected to last he only says vaguely that “the cells may last for years in perfect order if all the instructions here given are properly attended to.” His present accumulators were only put up in August 1885, those previously erected having proved to be unsatisfactory.

It is a pity that the useful information in this work is not conveyed in better language. In what is intended as a workshop hand-book we do not look for the elegance of an Addison; but we do want plain English. As an example of the language we may quote the following sentence from the preface: “Only cells of the Electrical Power Storage Company, of Messrs. Elwell-Parker, and their type, are dealt with, because at this moment there is probably no other better kind, or largely in use.” The meaning of this is clear, though even that is more than may be said of other sentences in the book.

Among minor faults we protest against the coinage of such a hideous word as “acidometer,” by which, apparently, is meant the instrument commonly known as a hydrometer; we do not think “s.g.” is an improvement on the ordinarily accepted abbreviation for specific gravity; and we object to the plural “dynamos” as against the ordinary rule of our language which gives us “potatoes” and “echoes.”

A more serious error is found in the “Index of Terms” on the back of the title-page—

“Watt = volt \times ampere = measure of force or energy.”

We should recommend the author to get the work revised by some onewho understands the rudiments of science as well as those of the English language.

School Hygiene: The Laws of Health in Relation to School Life. By Arthur Newsholme, M.D. (London: Swan Sonnenschein, Lowrey, & Co., 1887.)

ABOUT the importance of the matters dealt with in this little book there can, of course, be no dispute; and, as Dr. Newsholme points out in his preface, they have engaged the serious attention of many School Boards and Committees, and been made the subject of a good deal of useful legislation. Most school-managers still have something to learn about the principles of school hygiene, and many of them will, no doubt, find in Dr. Newsholme's volume exactly the kind of information they want. He discusses the subject under two heads, “Schools” and “Scholars.” Under the first head he presents his ideas on questions connected with the choice of sites for schools, the construction of school buildings, school furniture, lighting of school-rooms, general principles of ventilation, natural ventilation, ventilation and warming, and draining arrangements. In the part relating to “Scholars” he has chapters on mental exercise, excessive mental exercise, age and sex in relation to school work, muscular exercise and recreation, rest and sleep, children's diet, children's dress, baths and bathing, eyesight in relation to school life, communicable diseases in schools, and school accidents. Dr. Newsholme has studied his

subject thoroughly, and his conclusions are all the more valuable because they have been to a large extent suggested by his experience as a medical officer of health, and as a medical referee for various schools and training colleges.

LETTERS TO THE EDITOR

[The Editor does not hold himself responsible for opinions expressed by his correspondents. Neither can he undertake to return, or to correspond with the writers of, rejected manuscripts. No notice is taken of anonymous communications.]

[The Editor urgently requests correspondents to keep their letters as short as possible. The pressure on his space is so great that it is impossible otherwise to insure the appearance even of communications containing interesting and novel facts.]

MASS, WEIGHT, and DYNAMICAL UNITS

IF the laws of dynamics were made solely for the use of engineers, as a celebrated engineer declared of rivers that they were intended to feed canals, it might be conceded to Prof. Greenhill that it would not be necessary that the more abstract notion of mass should be distinguished from that of weight, and that the fundamental equation of dynamics might conveniently be

taken as $P = W \frac{f}{g}$, where W is the weight (or mass) of the body

moved expressed in pounds or tons, &c., and P the force producing in it the acceleration f , and reckoned in the same units. But a pound weight as a force is a variable unit, unless it is taken at some particular place (as Greenwich), and then the corresponding value of g must be employed (though the variation of g on the surface of the earth is not so great as often to need to be taken account of by the engineer); and so the astronomer and physicist, as well as the student of abstract dynamics, are right in demanding a less arbitrary measure of force than one founded on the force acting vertically downwards on a body at the earth's surface, as well as an absolute constant belonging to each body (its mass) independent of time and place. I conceive, therefore, in spite of Prof. Greenhill's arguments, that, in the interest of clearness of thought, as well as to avoid the practical inconvenience of a variable unit of force, the notions of mass and weight must be kept distinct, and the equation $W = Mg$, as a special case of the general equation $P = Mf$, still insisted on by all teachers of dynamics, at any rate to non-engineering students while it would be well for engineers also (*me judice*) to have their dynamics cast in the same mould as the rest of the scientific world.

I should not have troubled you with the above very obvious remarks had I not wished to observe, *à propos* of Mr. Geoghegan's suggestion of names for units of velocity and acceleration in NATURE of April 7 (p. 534), that it is highly desirable that convenient and consistent notation, as well as nomenclature, should be adopted for the several dynamical units.

With respect to the particular suggestion that *vel* and *cel* (*velo* and *celo*, as used by Mr. Lock in his forthcoming book “Dynamics for Beginners”) should be employed for the units of speed and acceleration in the foot-second system, I regard it as an almost fatal objection that the accepted C.G.S. system having appropriated the words *dyne* and *erg* for its units of force and work has a prior right to *vel* and *cel* for its units of speed and acceleration; namely, the centimetre per second, and the centimetre per second per second. If so, the units of the foot-second system might be called the *footvel* and the *footcel*.

Names for the dynamical units are, however, I think, of little importance than a convenient and suggestive notation for them. I have endeavoured to devise such a notation (or, rather, to fill in and complete notations which have more or less come into use in a table, which is now under the consideration of a Committee of the Association for the Improvement of Geometrical Teaching, and which is substantially as follows.

In a perfectly general system, let **L, M, T** stand respectively for the fundamental units of length, mass, and time, and **V, A, U, Δ, E** stand for the units thence derived of speed, quickening (acceleration), momentum or impulse, force, and energy or work respectively: then the statement that the unit-speed is the speed of the unit of length per unit of time,

naturally expressed thus, $V = L/T$. On the same principle we should have—

$$A = V/T = L/TT, U = MV = ML/T, \Delta = MA = ML/TT, E = L\Delta = LML/TT.$$

This may be simplified, using the analogy of the fluxional notation, by writing \dot{L} for L/T and \ddot{L} for L/TT . Then \dot{L} , \ddot{L} may take the place of V and A , and we have—

$$U = M\dot{L}, \Delta = M\ddot{L}, E = L\Delta = LML.$$

Names for the several units are hardly needed in the general system.

In the C.G.S. system the units of length, mass, and time are respectively the centimetre, gramme, and second, denoted by C, G, S . Then if U_G, Δ_G, E_G denote the units of momentum or impulse, force, and energy or work, we have, on the same principle as before, \dot{C}, \ddot{C} to denote the speed of a centimetre per second and the acceleration of a centimetre per second per second respectively, and the equations—

$$U_G = G\dot{C}, \Delta_G = G\ddot{C}, E_G = C\Delta_G = CG\ddot{C}.$$

If names for all these units are required, we may use these: *vel, cel, mom, dyne, erg*; and we may say, a *mom* is a *gramme-vel*, a *dyne* is a *gramme-cel*, and an *erg* a *centimetre-dyne*.

In the F.P.S., or British system, the units of length, mass, and time are respectively the foot, pound, and second, denoted by F, P, S . Then, if U_P, Δ_P, E_P denote the units of momentum or impulse, force, and energy respectively, we have, on the same principles, \dot{F}, \ddot{F} to denote the speed of a foot per second and the acceleration of a foot per second per second respectively, and the equations—

$$U_P = P\dot{F}, \Delta_P = P\ddot{F}, E_P = F\Delta_P = PF\ddot{F}.$$

I propose as names for these units: *footvel, footcel, poundem, poundal, pounderg*. I should have called the unit of force a *pound-dyne* or *poundyn*, but that *poundal* has already obtained general acceptance.

The foregoing are all absolute units. The corresponding (Greenwich) gravitation-units are the *pound-weight* = 32.19 *poundals*, the *foot-pound* = 32.19 *poundergs*, and the *second-pound* (as it has been proposed by Prof. Unwin to name the gravitation-unit of momentum, or time-integral of a pound-weight through one second) = 32.19 *poundems*; so that to convert absolute F.P.S. units into gravitation-units, or *vice versa*, it is only necessary to divide or multiply by 32.19 , since the acceleration due to gravity at Greenwich = $32.19 \ddot{F}$.

It is, I think, comparatively unimportant whether the names above suggested are, all of them, accepted or not; but the notation will, I believe, be found a great aid to the beginner in fixing in his mind the dimensions of the different magnitudes, and an effective safeguard against the too common confusion of units of force, impulse, and work. I doubt whether in speaking much would be gained by saying "*footvel*" instead of "*foot per second*," or "*footcel*" instead of "*foot per second per second*," while in writing, the symbols \dot{F} and \ddot{F} might be always used and read either way.

ROBT. B. HAYWARD

Harrow, April 12

Units of Weight, Mass, and Force

FAR be it from me to interfere between Mr. Alfred Lodge and Prof. Greenhill; but, whilst leaving Mr. Lodge to his fate and Prof. Greenhill, perhaps, as an engineer, I may be permitted to offer a few remarks on the general question. First, then, it appears to me that Prof. Tait's thoroughgoing condemnation of certain phrases of the engineering vernacular, and of the grave errors of certain writers, has been strained in some quarters to mean a general charge against engineers of inability to think or write clearly on the physical laws which lie at the root of their every-day practice. Such an unqualified charge is on the face of it absurd; for otherwise we must confess that the lives' work of Thomson and Tait has been a total failure as regards its influence on the truly practical men of their generation. Can this be so?

Prof. Greenhill's remarks on the abominable semi-numerical equation $W = Mg$, or $\frac{W}{g} = M$, I most heartily welcome [where

W is a mass and g a numeric; the moment writers on dynamics, who use the gravitation system, pass from merely proportional equations to their physical interpretation, then must we face with them this most wretched equation]. But perhaps it will be at once a surprise and a gratification to Prof. Greenhill to know that a whole (academic) generation of Scottish University engineering students has been taught to eschew this same equation as an unclean thing, and to adopt the mode of thought clearly set forth in the last two paragraphs of his letter of February 28. Some five or six years ago I was myself so taught by one who is now, alas! no more. The possibility of thus clearing of cant not only the engineering but the purely mathematical mind seems to me, as indeed Prof. Greenhill indicates, to be a direct consequence of the acceptance by Thomson and Tait of the British Imperial pound as the unit of mass or quantity of matter.

Having fixed, then, for good and all, the unit of mass, and taking the British foot and the second as the units of time and length respectively, the unit of force defines itself in virtue of Newton's Second Law. To this unit—the British unit of force—Prof. James Thomson has given, as nearly everyone knows, the name "*poundal*." Now the most convenient practical unit of force, for physicists as well as engineers, is not the poundal, but the gravitation at the earth's surface of the unit of mass, a quantity which is not absolutely constant, the inconvenience so arising being, however, practically unimportant, or at most involving a reduction to an arbitrary standard. To pass, then, from a force expressed in poundals to a force expressed in units of gravitation of the Imperial pound at the standard place, one simply wants to know how many poundals go to the gravitation of the Imperial pound at that place—in other words, the change ratio. The answer is simple: the numeric g for the standard place; for a force equal to the gravitation of the Imperial pound at the standard place acting upon a mass of one Imperial pound would generate a momentum per second of g (numeric) pounds mass \times feet per sec. per sec.; and the poundal a momentum per second of one pound mass \times feet per sec. per sec.; and by Newton's Second Law the ratio of the forces is, therefore, the numeric g . What more does the physicist or engineer want to know? How many poundals go to the gravitation of a ton mass at the standard place? Answer, the numeric $2240g$. Could anything be simpler? The difficulty is to find the difficulty, or to assign the *raison d'être* of the so-called gravitation unit of mass.

When the old unnatural gravitation unit of mass is abandoned, and the transition from the natural unit to the gravitation unit of force made by means of the change ratio, the vicious use of the word mass to denote the result of dividing by the numeric g the mass of a body in standard pounds (viciously on the same system called the weight and denoted by W) ceases; and the dire confusion between weight and mass becomes a thing of the past. The emancipation of the term weight from its bondage to mass would appear to have afforded opportunity for its use wherever it might be of service in suggesting or denoting gravitation. For example, there are three units, each called a pound, viz. the Imperial British unit of mass, the gravitation of the same mass at any the same place on the earth's surface, and the pound sterling. Physicists, like Sir Wm. Thomson and Prof. Tait, use terms such as "*pound weight*," "*gramme weight*"; similarly we have "*pound mass*" coming into use; and probably we shall soon hear of "*pound money*." Prof. Greenhill, with his strong engineering sympathies, objects to the time-honoured "*pounds per square inch*" being rendered "*pounds weight per square inch*"; and if I may presume to offer an opinion, the old phrase is already cumbersome enough. Still, if Prof. Tait and Prof. Greenhill ultimately agree that there is anything to be gained in perspicuity, for the sake of the weaker members perhaps it might be well for us to put in practice, on some occasions, the injunction to sacrifice all rather than cause our brother to offend.

Some one might possibly step in to draw attention to the fact that the pages of even our own great high priest of exact applied science are disfigured by $\frac{W}{g}$; but sure I am that were Rankine

now with us he would lead the way with Prof. Greenhill in a crusade against the apologists for the obscurity of which W/g is the symbol. Take, for example, Rankine's bold introduction of the dynamical unit of quantity of heat. Take the opinion of

Clausius, than whom none could be a more unprejudiced witness. "At the same time in the theoretical development of the mechanical theory of heat, in which the relation between heat and work often occurs, the method of expressing heat in mechanical units effects such important simplifications that the author has felt himself bound to drop his former objections to the method on the occasion of the present more connected exposition of that theory." ARCHD. C. ELLIOTT
Edinburgh, April 18

Seismometers

I HAVE long ago learnt not to look for any fair recognition of my work in seismometry on the part of Prof. John Milne, and when he accuses me of appropriating without acknowledgment the work of others it is time to decline further controversy with him. The points raised in his last communication (NATURE, April 14, p. 559) are sufficiently answered in mine of December 11 (p. 172). I there quoted part of a letter written by Prof. Chaplin, now of Harvard University, then of Tokio, and Secretary of the Seismological Society of Japan, under whose eyes the events occurred to which Prof. Milne refers. I did not quote the whole of Prof. Chaplin's letter, because it contained sentences I was unwilling to give except under the strongest provocation. After referring to my seismograph in the words already quoted (p. 172), Prof. Chaplin continues:—

"I do not remember that in the discussions on your machine Mr. Gray ever claimed to have invented a similar machine, and I am surprised to know that he makes that claim now. On this and other points it appears to me that Messrs. Gray and Milne have not treated your inventions and investigations with fairness, and that you have just grounds for complaint. I am willing you should make such use of this note as you see fit."

As to the question of priority, this judgment, from a man at once unprejudiced, most competent to form an opinion, and fully informed of the matter in dispute, must (so far as I am concerned) close a discussion of which your readers cannot but be weary. With your permission I shall give, in a later number of NATURE, an example of the excellent work which Prof. Sekiya is now doing with my instruments in Japan.

J. A. EWING

University College, Dundee, April 16

April Meteors

THE Lyrids have, this year, offered a somewhat scanty display, though a few brilliant meteors have been seen shooting from the usual radiant-point.

In 1884 April 19, this shower was very rich, the horary number of its meteors for one observer being about 22, but in the following year, 1885, it exhibited a considerable decline, the hourly rate being only 3. In 1886 I obtained no observations, owing to the bright moonlight and in the present year, on April 20, the horary number was slightly more than 2, so that the numerical character of the recent display has fallen far short of some of its apparitions in preceding years.

On the night of April 17, this year, the shower had not visibly opened, for none of its meteors were recorded in a 2½ hours' watch. On each of the nights of the 18th and 19th the sky was closely observed for 4½ hours, but the Lyrid shower was very feeble, and only furnished 1 meteor per hour. On the 20th, in 3 hours I noted 7 Lyrids, and these were brilliant.

The average radiant-point from the three nights was at 269° + 32°, and there is confirmation that this point advances in R.A. with the time, though not to the marked degree ascribed in NATURE for May 7, 1885, p. 5. But the meteors from this stream have been so scarce at their late recurrence that it has been very difficult to ascertain the exact radiant for each night. Moreover, these Lyrids move with great apparent velocity, flashing out with extreme suddenness and they are gone, together with the faint streaks sometimes accompanying them, before the eye is enabled to catch the directions with satisfactory precision.

On the four nights April 17 to 20 inclusive, I noticed 70 shooting-stars belonging to the minor systems of the Lyrid meteoric epoch, and amongst these the best was that of a radiant of very swift, short meteors at 231° + 17°, a few degrees west of β Serpentis. This stream is not new, for I saw a well-defined shower of Serpentids from the same point during my observa-

tions of the Lyrids in 1885, on April 19-20 (NATURE, May 7, 1885, p. 6).

In this and in previous years I have also recorded some meteors ascending in very long flights from a radiant centre close to θ Libræ, at 235° - 15°. This is the only observation of this shower at the April period, though Lieut.-Colonel Tupman found a pair of radiants near the position assigned in the first week of March 1869-70.

I subjoin a short list of bright meteors seen here while watching the progress of the Lyrids, and I should be glad to hear that any of these had been observed elsewhere.

Date	Hour	Mag.	Apparent Path		Notes	Radiant
			From	To		
1887						
April 19	13 13	9	269 + 0	269 + 0	Swift, streak	Lyrid
20	13 46	7½	308 + 61½	56 + 65½	Swift, streak	279° + 13'
19	9 48	7	211 + 7	194 - 4	Very swift	Lyrid
20	10 29½	> 1	243 + 14	234 + 5	Swift, streak	Lyrid
20	10 47	1	239 + 53	269 + 62½	Slow, train	206° + 18'
20	12 28	> 1	308 + 40	316 + 40½	Very swift	Lyrid

Bristol, April 22

W. F. DENNING

Vertical Decrement of Temperature and Pressure

IN NATURE of March 10 (p. 437), Mr. Maxwell Hall gives an interesting table of the vertical distribution of temperature and pressure in Jamaica, and, apparently in happy ignorance of the dangers of the process known as extrapolation, goes on to apply the results of observations extending to a maximum height of only 7400 feet to the determination of the probable temperature of meteorites in extra-terrestrial space. As he expresses a desire to know whether any similar results have been found in India, and as I have on several occasions during the past ten years discussed the vertical distribution of temperature and pressure in this country, I gladly take this opportunity of referring him to my papers on the meteorology of the North-West Himalaya, and on the temperature of North-Western India published in the "Indian Meteorological Memoirs," vols. i. and ii. From the latter I extract the following table on the mean decrement of temperature up to a height of 12,000 feet, computed from the observations of twenty-five stations combined in various ways. For each month an interpolation formula of the form

$$T = T_0 + ah + bh^2 + ch^3,$$

was computed, and by its means the decrements from sea-level to 1000 feet, 1000 to 2000 feet, &c., were calculated. Finally the average decrement for the twelve months was computed, and is here given in an abridged form. The curves for the several months differ very widely from one another, those for the summer giving the most rapid decrement at sea-level, and the decrement increasing with altitude in winter:—

Height	Mean temperature decrement
Feet	° F.
0 to 2000	6.16
2000 to 4000	5.87
4000 to 6000	5.61
6000 to 8000	5.37
8000 to 10000	5.16
10000 to 12000	4.98

The mean height of the barometer at sea-level in the region in question, the centre of which lies a little north of Simla, is about 29.8 inches; the mean at 6000 feet is 24.1 inches, and the mean at 12,000 feet about 19.4 inches. With these data and adopting Mr. Hall's formula

$$\delta T = \lambda. \delta P + \mu. (\delta P)^2,$$

we find $\lambda = 2^{\circ}979$ and $\mu = 0^{\circ}02$. These coefficients do not differ widely from Mr. Hall's values, which are $2^{\circ}92$ and $0^{\circ}0$ respectively. At the limit of the atmosphere, where $\delta P = 29^{\circ}1$ δT would be $-106^{\circ}5$, which would give, as the mean temperature of external space, about -30° F., the mean temperature at sea-level being 77° F.

Taking the simplest formula, $\delta T = \lambda. \delta P$, we find $\lambda = 3^{\circ}11$ which is almost identical with the value quoted by Mr. Hall from an early volume of NATURE, but which, if it held good to the limit of the atmosphere, would make the temperature of external space about -18° F., since the mean temperature at sea-level is 77° F.

The only conclusion to be drawn from such observations is that the vertical decrement of temperature on mountain varies greatly with locality as well as season, and the result

obtained for one locality cannot be fully applied to another, much less extended to determine the temperature at the superior limit of the atmosphere.

An interesting point of resemblance between Mr. Hall's observations and those made on the Himalaya is that the diurnal range of temperature diminishes to a minimum at about 5000 feet, and then increases with increasing elevation.

Allahabad, March 30

S. A. HILL

Royal Society's *Soirée*

MAY I be permitted, through the columns of NATURE, to ask, on behalf of the Sub-Committee appointed to make arrangements for the forthcoming *soirée* of the Royal Society, that Fellows and others who have apparatus or objects of scientific interest suitable for exhibition on that occasion will communicate at once with the Secretaries or myself.

Royal Society, Burlington House

HERBERT RIX,
Asst. Sec. R.S.

HOMERIC ASTRONOMY¹

II.

TURNING to the second great constellation mentioned in both Homeric epics, we again meet traces of remote and unconscious tradition. Yet less remote, probably, than that concerned with the Bear. Certainly less inscrutable. For recent inquiries into the lore and language of ancient Babylon have thrown much light on the relationships of the Orion fable.

There seems no reason to question the validity of Mr. Robert Brown's interpretation of the word by the Accadian *Ur-ana*, "light of heaven" ("Myth of Kirke," p. 146). But a proper name is significant only where it originates. Moreover, it is considered certain that the same brilliant star-group known to Homer no less than to us as Orion, was termed by Chaldeo-Assyrian peoples "Tammuz" (Lenormant, *Origines de l'Histoire*, t. i. p. 247), a synonym of Adonis. Nor is it difficult to divine how the association came to be established. For about 2000 B.C., when the Euphratean constellations assumed their definitive forms, the belt of Orion began to be visible before dawn in the month of June, called "Tammuz," because the death of Adonis was then celebrated. It is even conceivable that the heliacal rising of the asterism may originally have given the signal for that celebration. We can at any rate scarcely doubt that it received the name of "Tammuz" because its annual emergence from the solar beams coincided with the period of mystical mourning for the vernal sun.

Orion, too, has solar connexions. In the Fifth "Odyssey" (121-24), Calypso relates to Hermes how the love for him of Aurora excited the jealousy of the gods, extinguished only when he fell a victim to it, slain by the shafts of Artemis in Ortygia. Obviously, a sun-and-dawn myth slightly modified from the common type. The post-Homeric stories, too, of his relations with Cenopion of Chios, and of his death by the bite of a scorpion (emblematical of darkness, like the boar's tusk in the Adonis legend), confirm his position as a luminous hero (R. Brown, *Archæologia*, vol. xvii. p. 352; "Great Dionysiak Myth," chap. x. §v.). Altogether, the evidence is strongly in favour of considering Orion as a variant of Adonis, imported into Greece from the East at an early date, and there associated with the identical group of stars which commemorated to the Accads of old the fate of Dumuzi (*i.e.* Tammuz), the "Only Son of Heaven."

It is remarkable that Homer knows nothing of stellar mythology. He nowhere attempts to account for the names of the stars. He has no stories at his fingers' ends of translations to the sky as a ready means of exit from terrestrial difficulties. The Orion of his acquaintance—the beloved of the Dawn, the mighty hunter, surpassing in beauty of person even the divinely-born Aloidae

¹ Continued from p. 588.

—died and descended to Hades like other mortals, and was there seen by Ulysses, a gigantic shadow "driving the wild beasts together over the mead of asphodel, the very beasts which he himself had slain on the lonely hills, with a strong mace all of bronze in his hand, that is ever unbroken" ("Odyssey," xi. 572-75). His stellar connexion is treated as a fact apart. The poet does not appear to feel any need of bringing it into harmony with the Odyssean vision.

The brightest star in the heavens is termed by Homer the "dog of Orion." The name *Scirios* (significant of sparkling), makes its *début* in the verses of Hesiod. To the singer of the "Iliad" the dog-star is a sign of fear, its rising giving presage to "wretched mortals" of the intolerable, feverish blaze of late summer (*opora*). The deadly gleam of its rays hence served the more appropriately to exemplify the lustre of havoc-dealing weapons. Diomed, Hector, Achilles, "all furnish'd, all in arms," are compared in turn, by way of prelude to an "*aristeia*," or culminating epoch of distinction in battle, to the same brilliant but baleful object. Glimmering fitfully across clouds, it not inaptly typifies the evanescent light of the Trojan hero's fortunes, no less than the flashing of his armour, as he moves restlessly to and fro ("Iliad," xi. 62-6). Of Achilles it is said:—

"Him the old man Priam first beheld, as he sped across the plain, blazing as the star that cometh forth at harvest-time, and plain seen his rays shine forth amid the host of stars in the darkness of night, the star whose name men call Orion's Dog. Brightest of all is he, yet for an evil sign is he set, and bringeth much fever upon hapless men. Even so on Achilles' breast the bronze gleamed as he ran" (xxii. 25-32).

In the corresponding passage relating to Diomed (v. 4-7), the *naïve* literalness with which the "baths of Ocean" are thought of is conveyed by the hint that the star shone at rising with increased brilliancy through having newly washed in them.

Abnormal celestial appearances are scarcely noticed in the Homeric poems. There are neither eclipses¹ of sun or moon, nor comets, nor star-showers. The rain of blood, by which Zeus presaged and celebrated the death of Sarpedon ("Iliad," xvi. 459, also xi. 54) might be thought to embody a reminiscence of a crimson aurora, frequently, in early times, chronicled under that form; but the portent indicated is more probably an actual shower of rain tinged red by a microscopic alga. An unmistakable meteor, however, furnishes one of the glowing similes of the "Iliad." By its help the irresistible swiftness and unexpectedness of Athene's descent from Olympus to the Scamandrian plain are illustrated.

"Even as the son of Kronos the crooked counsellor sendeth a star, a portent for mariners or a wide host of men, bright shining, and therefrom are scattered sparks in multitude; even in such guise sped Pallas Athene to earth, and leapt into their midst" ("Iliad," iv. 75-9).

In the Homeric verses the Milky Way—the "path of souls" of prairie-roving Indians, the mediæval "way of pilgrimage"²—finds no place. Yet its conspicuousness, as seen across our misty air, gives an imperfect idea of the lustre with which it spans the translucent vault which drew the wondering gaze of the Ionian bard.

The point of most significance about Homer's scanty astronomical notions is that they were of home growth. They are precisely such as would arise among a people in an incipient stage of civilisation, simple, direct, and childlike in their mode of regarding natural phenomena, yet incapable of founding upon them any close or connected reasoning. Of Oriental mysticism there is not a vestige. No occult influences rain from the sky. Not so

¹ Görlitz finds a prediction of a solar eclipse at "Odyssey," xx 357; but the expression appears quite indefinite and figurative.

² To Compostella. The popular German name for the Milky Way is *Jakobsstrass*, while the three stars of Orion's belt are designated, in the same connexion, *Jakobsstab*, staff of St. James.

much as a square inch of foundation is laid for the astrological superstructure. It is true that Sirius is a "baleful star"; but it is in the sense of being a harbinger of hot weather. Possibly, or probably, it is regarded as a concomitant cause, no less than as a sign of the August droughts; indeed the *post hoc* and the *propter hoc* were, in those ages, not easily separable; the effect, however, in any case, was purely physical, and so unfit to become the starting-point of a superstition.

The Homeric names of the stars, too, betray common reminiscences rather than foreign intercourse. They are all either native, or naturalised on Greek soil. The transplanted fable of Orion has taken root and flourished there. The cosmopolitan Bear is known by her familiar Greek name. Boötes is a Greek husbandman, variously identified with Arkas, son of Callisto, or with Ikaros, the luckless mandatory of Dionysos. The Pleiades and the Hyades are intelligibly designated in Greek. The former word is usually derived from *plein*, to sail; the heliacal rising of the "tangled" stars in the middle of May having served, from the time of Hesiod, to mark the opening of the season safe for navigation, and their cosmical setting, at the end of October, its close. But this etymology was most likely an after-thought. Long before rules for navigating the Ægean came to be formulated, the "sailing-stars" must have been designated by name amongst the Achaian tribes. Besides, Homer is ignorant of any such association. Now in Arabic the Pleiades are called *Eih Thurayyâ*, from *tharwa*, copious, abundant. The meaning conveyed is that of many gathered into a small space; and it is quite similar to that of the Biblical *kimah*, a near connexion of the Assyrian *kimtu*, family (R. Brown, "Phainomena of Aratus," p. 9; Delitzsch, "The Hebrew Language," p. 69). Analogy, then, almost irresistibly points to the interpretation of Pleiades by the Greek *pleiones*, many, or *pleios*, full; giving to the term, in either case, the obvious signification of a "cluster."

Of the Hyades, similarly, the "rainy" association seems somewhat far-fetched. They rise and set respectively about four days later than the Pleiades; so that, as prognostics of the seasons, it would be difficult to draw a permanent distinction between the two groups; yet one was traditionally held to bring fair, the other foul weather. There can be little doubt that an etymological confusion lay at the bottom of this inconsistency. "To rain," in Greek is *hrein*; but *hus* (cognate with "sow") means a "pig." Moreover, in old Latin, the Hyades were called *Suculæ* ("little pigs"); although the misapprehension which he supposed to be betrayed by the term was rebuked by Cicero (*De Nat. Deorum*, lib. ii. cap. 43). Possibly the misapprehension was the other way. It is quite likely that "*Suculæ*" preserved the original meaning of "Hyades," and that the pluvius derivation was invented at a later time, when the conception of the seven stars in the head of the Bull as a "litter of pigs" had come to appear incongruous and inelegant. It has, nevertheless, just that character of *naïveté* which stamps it as authentic. Witness the popular names of the sister-group—the widely-diffused "hen and chickens," Sancho Panza's "las siete cabrillas," met and discoursed with during his famous aerial voyage on the back of Clavileño, the Sicilian "seven dovelets,"—all designating the Pleiades. Still more to the purpose is the Anglo-Saxon "boar-throng," which, by a haphazard identification, has been translated as Orion, but which Grimm, on better grounds, suggests may really apply to the Hyades (*Teutonic Mythology*, trans. by J. S. Stallybrass, vol. ii. p. 729). It is scarcely credible that any other constellation can be indicated by a term so manifestly reproducing the "*Suculæ*" of Latin and Sabine husbandmen.

The Homeric scheme of the heavens, then, (such as it is), was produced at home. No stellar lore had as yet been imported from abroad. An original community of ideas is just traceable in the names of some of the stars;

that is all. The epoch of instruction by more learned neighbours was still to come. The Signs of the Zodiac were certainly unknown to Homer, yet their shining array had been marshalled from the banks of the Euphrates at least 2000 years before the commencement of the Christian era. Their introduction into Greece is attributed to Cleostratus of Tenedos, near, or shortly after, the end of the sixth century B.C. By that time, too, acquaintance had been made with the "Phœnician" constellation of the Lesser Bear, and with the wanderings of the planets. Astronomical communications, in fact, began to pour into Hellas from Egypt, Babylonia, and Phœnicia about the seventh century B.C. Now, if there were any reasonable doubt that "blind Melesigenes" lived at a period anterior to this, it would be removed by the consideration of what he lets fall about the heavenly bodies. For, though he might have ignored formal astronomy, he could not have remained unconscious of such striking and popular facts as the identity of Hesperus and Phosphorus, the Sidonian pilots' direction of their course by the "Cynosure," or the mapping-out of the sun's path among the stars by a series of luminous figures of beasts and men.

Thus the hypothesis of a late origin for the "Iliad" and "Odyssey" is negated by the astronomical ignorance betrayed in them. It has, however, gradations; whence some hints as to the relative age of the two epics may be derived. The differences between them in this respect are, it is true, small, and they both stand approximately on the same astronomical level with the poems of Hesiod. Yet an attentive study of what they have to tell us about the stars affords some grounds for placing the "Iliad" the "Odyssey," and the "Works and Days" in a descending series as to time.

In the first place, the division of the month into three periods of ten days each is unknown in the "Iliad," is barely hinted at in the "Odyssey," but is brought into detailed notice in the Hesiodic calendar. Further, the "turning-points of the sun" are unmentioned in the "Iliad," but serve in the "Odyssey," by their position on the horizon, to indicate direction; while the winter solstice figures as a well-marked epoch in the "Works and Days." Hesiod, moreover, designates the dog-star (not expressly mentioned in the "Odyssey") by a name of which the author of the "Iliad" was certainly ignorant. Besides which an additional constellation (Boötes) to those named in the "Iliad" appears in the "Odyssey" and the "Works and Days"; while the title "Hyperion," applied substantively to the sun in the "Odyssey," is used only adjectivally in the "Iliad." Finally, stellar mythology begins with Hesiod; Homer (whether the Ionian or the Ithacan) takes the names of the stars as he finds them, without seeking to connect them with any sublunary occurrences.

To be sure, differences of place and purpose might account for some of these discrepancies, yet their cumulative effect in fixing relative epochs is considerable; and even apart from chronology, it is something to look towards the skies with the "most high poet," and to retrace, with the aid of our own better knowledge, the simple meanings their glorious aspect held for him.

A. M. CLERKE

ON ICE AND BRINES¹

I.

THE composition of the ice produced in saline solutions and more particularly in sea-water, has frequently been the object of investigation and of dispute. It might be thought that to a question of whether ice so formed does or does not contain salt, experiment would at once give a decisive answer. Yet, relying on experiment alone, competent authorities have given contradictory answers. A

¹ Paper read before the Royal Society of Edinburgh, by J. Y. Buchanan on March 27 last.

agree that ice, whether formed artificially in the laboratory by freezing sea-water, or found in nature as one of the various species of sea-water ice, retains, in one form or another, and with great tenacity, the salt existing in solution in the water. The question at issue is whether this salt is to be attributed to the solid matter of the ice or to the liquor mechanically adhering to it, from which it is impossible to free it. Most bodies, and especially those which take a crystalline form, are easily purified and freed from all suspected foreign matter, with a view to analysis, by the simple operation of washing and drying. It is impossible to wash the crystals, formed by freezing a saline solution, with distilled water, because they melt at a temperature below that at which distilled water freezes. The effect of the addition of a small quantity of distilled water to a quantity of saline ice is at first the anomalous one, that what was a wet sludge is transformed into a dry crystalline powder. It is of course impossible to dry the ice by heat, and to do so by more intense freezing would be begging the question. The experimental difficulties therefore account for some of the divergence of opinion on the subject. The mixed character of the substances examined has also much to do with it. As a rule it may be said that those investigators who have confined their observations to the laboratory have concluded that the ice forming when saline solutions of moderate concentration, including sea-water, are frozen, is pure ice, and the salt from which it is impossible to free it entirely belongs to the mother-liquor, while those who have collected and examined sea-water ice in high latitudes have come to the opposite conclusion.

During the Antarctic cruise of the *Challenger* I made a number of observations on the sea-water ice found in those regions, and relying principally on the fact that the melting temperature of the ice was markedly lower than that of fresh-water ice, and that it was impossible by any of the ordinary means familiar to chemists for freeing crystals from adhering mother-liquor to materially reduce its salinity, I came to the conclusion that the ice forming in freezing sea-water is not a mixture of pure ice and brine, but that it contains the salt found in it in the solid state either as a crystalline hydrate or as the anhydrous salt, but most probably as a hydrate. In dealing with this subject, Dr. Otto Pettersson ("Water and Ice," p. 302) quotes my observations, and also rejects the view that "sea-ice is in itself wholly destitute of salts, and only mechanically incloses a certain quantity of unfrozen and concentrated sea-water." He founds his belief on the fact that numerous analyses of specimens of sea-water ice have shown that the constitution of the saline contents of different specimens of ice differs for each specimen, and is always different from that of the saline contents of sea-water. Were the salinity due to inclosed unfrozen and concentrated sea-water, we "ought to find by chemical analysis exactly the same proportion between Cl, MgO, CaO, SO₃, &c., in the ice and in the brine as in the sea-water itself." He adduces numerous examples of analyses of specimens of sea-water ice from the Baltic and from the Arctic Seas to show that this is not the case. Calling the percentage of chlorine in each case 100, he found in various sea-waters the percentage of SO₃ vary from 11.49 to 11.89. In specimens of sea-water ice it varied from 12.8 to 76.6, and in brines separating from the ice and remaining liquid at -30° C. it varied from 1.14 to 1.16.

This argument appears conclusive. In order to explain all the phenomena observed in connexion with sea-water ice he cites Guthrie's investigations, which went to show that, in freezing saline solutions, under a certain concentration, pure ice is formed at a temperature which falls from 0° C., when the amount of salt dissolved is infinitely small, to a certain definite temperature when the solution contains a certain definite percentage of salt. Further abstraction of heat then produces solidification

of the solution as a whole, in the form of a crystalline hydrate, of constant freezing- and melting-point. To such hydrates, Guthrie gave the name of cryohydrates. Pettersson quotes the following as being particularly applicable to the case of sea-water:—

The cryohydrate of	Contains per cent. of water	Solidifies at °C.
NaCl	76.39	-22
KCl	80.00	-11.4
CaCl ₂	72.00	-37.0
MgSO ₄	78.14	-5.0
Na ₂ SO ₄	95.45	-0.7

And he refers more particularly to the cryohydrate of Na₂SO₄ forming and melting at -0°7.

Now the bearing of Guthrie's experiments is to show that, while at sufficiently low temperatures, and with suitable concentration, the water will solidify along with one or other of the salts in solution, until this low temperature and high concentration are attained, pure ice must be the result of freezing.

The abnormal phenomena attending the formation and the melting of ice in saline solutions and sea-water, find a natural explanation in an observation which I have frequently quoted, and which Dr. Pettersson mentions in a footnote at p. 313, namely, that "a thermometer immersed in a mixture of snow and sea-water which is constantly stirred indicates -1°8 C." If this is true, it is clear that my melting-point observations proved nothing. On repeating the experiment I found it confirmed, and took the opportunity this winter of investigating the matter more closely. The paper read before the Royal Society of Edinburgh contains the first portion of the results. It deals with the subject under two heads, namely, (a) the temperature at which sea-water and some other saline solutions freeze, and the chemical constitution of the solid and the liquid into which they are split by freezing; and (b) the temperature at which pure ice melts in sea-water and in a number of saline solutions of different strengths.

(a) The freezing experiments were limited to sea-water and solutions of NaCl comparable with sea-water.

Chloride of Sodium.—Four solutions were used, and they were intended to contain 3, 2.5, 2, and 1.5 per cent. NaCl respectively. Forty grammes of this solution, in a suitable beaker, were immersed in a freezing mixture of such composition as to give a temperature from 2° to 2°5 C. below the freezing temperature expected. The temperature at which ice began to form (if necessary after adding a minute splinter of ice) was noted, and the freezing was allowed to continue with constant stirring till the temperature had fallen 0°2 C. A specimen of the mother-liquor was removed, and the chlorine in it determined; the chlorine in the original solution had been determined before. The beaker was then removed from the freezing bath and allowed to melt. The temperature in all cases rose during melting exactly as it had fallen during freezing. In the following table are given the means of the temperature at which ice began to form in the original solution, and that of the liquid when the sample of brine was taken, and the means of the chlorine found in the original solution and in the brine sample

Mean Freezing Temp.	-1°875 C.	-1°63	-1°30	-0°975
Mean per cent. Cl.	1.87	1.60	1.30	0.98

It will be seen that, in the dilute solutions experimented with, the percentage of chlorine expresses, in terms of the Centigrade scale, the lowering of the freezing-point of the solution.

Sea-Water.—Similar experiments were made with sea-water of different degrees of concentration. In sea-water from the Firth of Clyde containing 1.84 per cent. of

chlorine, ice forms at $-1^{\circ}9$ C. The following results are from means of closely-agreeing results:—

Freezing temperature	$-2^{\circ}0$	$-1^{\circ}5$	$-1^{\circ}0$	$-0^{\circ}5$
Per cent. chlorine	1.94	1.445	0.963	0.475
Difference	0.06	0.055	0.037	0.025

Sea-water resembles a chloride of sodium solution, containing the same percentage of chlorine, and the resemblance is closer the greater the dilution. When the beaker was removed from the freezing-bath, the temperature rose during melting as it had fallen during freezing. In these experiments, which had for their object the determination of the temperature at which the crystals melted, as well as that at which they began to form in the water, it was impossible to remove a sample for analysis large enough to enable the sulphuric acid to be determined in it.

For this purpose a series of observations were made, using quantities of 300 grammes of sea-water. Freezing was continued usually until the temperature had fallen $0^{\circ}3$ C. below that at which crystals began to form. The mother-liquor was then separated from the crystals by means of a large pipette with fine orifice, before removing the beaker from the freezing bath. The magma of crystals was then brought rapidly on a filter and drained by means of the jet pump. The ice, thus drained, was then melted, and the three fractions were analysed. In the following table (I.) the results of four experiments are given. In the one column (W) will be found the weight of the original water taken and of the fractions into which it was split in freezing; in the other (R) will be found the ratio of SO_3 to Cl found by analysis, the chlorine being set down as 100; thus, in I, the percentage of chlorine found in the crystals, melting at the lowest temperature, was 1.497, and that of the SO_3 , 0.174; the ratio (R) is therefore 11.62.

TABLE I.—Freezing sea-water—Analyses of fractions.

No. of Experiment.	I.		II.		III.		IV.	
	Forth 100%		Mother-liquor		Clyde 100%		Clyde 50%	
Nature of Water...	W	R.	W.	R.	W.	R.	W.	R.
Original water	300	11.83	90	11.67	300	11.53	300	11.21
Mother-liquor	—	—	—	11.83	102	11.57	78	11.67
Drainings	170.6	11.67	—	—	94	11.56	109	—
Crystals	106	11.62	23	11.22	97	11.67	106	11.44
„	22.5	11.11	—	—	—	—	—	—

It will be seen that the ratios (R) found for mother-liquor, drainings, and ice agree with one another quite as closely as those found in samples of pure sea-water from different localities. It is to be remembered that in these experiments the water was frozen *gently*, that is, the rate of abstraction of heat was low, the temperature of the freezing bath being regulated so as to be about 2° C. below the freezing temperature of the solution. Much of the error and uncertainty about the freezing of saline solutions arises from the violence of the methods employed. Judging then by the constancy of the relation of the percentage of Cl to SO_3 we see that in sea-water, frozen at moderate temperatures, the composition of the saline contents of the original water, the mother-liquor and the ice is identical; and we are justified in concluding that it is probable that the saltiness of the ice is due to unfrozen and concentrated sea-water adhering to it. Ice forming in even very weak saline solutions closely resembles snow (which is ice forming in air), and has the same remarkable power of retaining mechanically several times its weight of water or brine.

A strict account was kept of the heat removed from the sea-water while the freezing was going on. In Table II. will be found the number of heat-units (gramme $^{\circ}$ C.)

removed during the freezing in the case of Nos. III. and IV.; and this number, divided by 79.25, gives the weight of pure ice, which could have been formed at 0° C. by the removal of heat.

TABLE II.—Calculation of ice formed.

		III.	IV.
Weight of original water (grammes)	W	300	300
Per cent. Cl in ditto	c	1.836	0.923
Per cent. Cl in mother-liquor	K	2.212	1.153
Weight of mother-liquor	$W \frac{c}{K}$	L	249.0
Weight of ice	$W - L$	I	51.0
Mean freezing temperature ($^{\circ}$ C.)	-2.05	-1.05
Heat abstracted (grammes $^{\circ}$ C.)	423.0	519.3
Equivalent ice formed (grammes)	53.4	65.5

Sea-water, like other saline solutions, is easily cooled several degrees below its freezing-point before crystals begin to form. While cooling down to and below what was known to be its freezing-point, simultaneous observations of the temperature of the sea-water and the freezing bath were made from half-minute to half-minute. From these observations, the rate of abstraction of heat for different differences of temperature of sea-water and bath was found. At a given moment a minute splinter of ice (weighing much less than a drop of water) was introduced. Crystals immediately began to form, and the temperature rose in from ten to fifteen seconds to the freezing-point. During the freezing the temperatures of bath and sea-water were observed at regular intervals. The heat removed is thus made up of that eliminated during the few seconds when freezing began and the temperature rose to the freezing-point, which is found by multiplying the rise of temperature by the weight of liquid, and that removed during the subsequent cooling, which is deduced from the duration of the operation and the rate of loss of heat observed before freezing commenced. The specific heat of the solution is taken as unity. In the table are further given the weight of the sea-water used, the percentage of chlorine in the original water and in the mother-liquor, the weight of the mother-liquor on the assumption that it contains all the salt of the original water, and, by difference, the weight of the ice formed. The agreement between the two quantities of ice formed as calculated by the different methods is as close as could be expected.

It has thus been shown that the composition of the saline contents of the ice formed as above described is the same as that of the original water, and this of itself is almost conclusive that the salt is contained in adhering brine and not as a solid constituent of the ice. Assuming that this is so the amount of ice formed as deduced from the composition of the mother-liquor agrees well with the amount deduced from the thermal exchange taking place during the freezing.

It has, moreover, been proved by Guthrie, Rüdorff, and others, that, in solutions of the salts occurring in sea-water, ice does separate out at first, and continues to separate out until the concentration has become many times greater than that of sea-water. Assuming that in sea-water all the chlorine is united to sodium, 87 per cent. of the water would have to be removed as ice before a cryohydrate would form, and if it contained nothing but sulphate of soda in the proportion corresponding to the sulphuric acid formed in it, over 90 per cent. of the water would have to go as ice, before the cryohydrate would be formed.

In my experiments, about 15 per cent. of the weight of the water was frozen out as ice, causing a lowering of freezing-point by $0^{\circ}3$ C. In nature it is probable that the ice forming at the actual freezing surface does so at an almost uniform temperature, the local concentration pro-

duced by the formation of a crystal of ice being immediately eliminated by the mass of water below. In the interstices of the crystals there will be retained a weight of slightly concentrated sea-water at least as great as that of the ice crystals. These retain the brine in a meshwork of cells, and, as the thickness of the ice covering increases, and the freezing surface becomes more remote, the ice and the brine become more and more exposed to the atmospheric rigours of the Arctic winter. The brine will continue to deposit ice until its concentration is such that, for example, the cryohydrate of NaCl is ready to separate out. It probably will separate out until it comes in conflict with, for instance, the chloride of calcium or the chloride of magnesium, which will retain some of the water, without solidifying, even at the lowest temperatures. At the winter quarters of the *Vega* brine was observed oozing out of sea-water ice and liquid at a temperature of -30°C . It was very rich in calcium and especially magnesium chlorides. In fact, it is probably quite impossible by any cold occurring in nature to solidify sea-water.

The residual and unfreezable brine which remains in considerable quantity liquid when sea-water is frozen, must also remain in greater or less quantity when fresh water is frozen. All natural waters, including rain-water, contain some foreign and usually saline ingredients. If we take chloride of sodium as the type of such ingredients, and suppose a water to contain a quantity of this salt equivalent to one part by weight of chlorine in a million parts of water, then we should have a solution containing 0.0001 per cent. of chlorine, and it would begin to freeze and to deposit pure ice at a temperature of -0.0001°C .; and it would continue to do so until, say, 999,000 parts of water had been deposited as ice. There would then remain 1000 parts of residual water, which would retain the salt, and would contain, therefore, 0.1 per cent. of chlorine, and would not freeze until the temperature had fallen to -0.1°C . This water would then deposit ice at temperatures becoming progressively lower, until, when 900 more parts of ice had been deposited, we should have 100 parts residual water, or brine as it might now be called, containing 1 per cent. of chlorine, and remaining liquid at temperatures above -1.0°C . When 90 more parts of ice had been deposited, we should have 10 parts of concentrated brine containing 10 per cent. of chlorine and remaining liquid at -10°C . In the case imagined, we assume the saline contents to consist of NaCl only, and with further concentration the cryohydrate would no doubt separate out and the mass become really solid. On reversing the operations, that is, warming the ice just formed, we should, when the temperature had risen to -10°C ., have 999,990 parts ice and 10 brine containing 10 per cent. chlorine. Now, owing to the remarkable fact (which is dealt with at length in the second part of the paper) that pure ice, in contact with a saline solution, melts at a temperature which depends on the nature and the amount of the salt in the solution, and is identical with the temperature at which ice separates from a solution of the same composition on cooling, the brine liquefies more and more ice at progressively rising temperatures, until, as before, when the temperature of the mass has risen to -0.1°C ., it consists of 999,000 parts of ice and 1,000 parts of liquid water, containing 1 part of chlorine. The remainder of the ice will melt at a temperature gradually rising from -0.1°C . to 0°C .

The consideration of this example furnishes an easy explanation of the anomalous behaviour of ice, formed from anything but the very purest distilled water, in the neighbourhood of its melting-point. This subject has been studied with great care and thoroughness by Pettersson. The apparent expansion of all but the very purest ice, when cooled below 0°C ., is ascribed by him in part to solid saline contents of the ice which exercise a disturbing and unexplained influence on its physical properties. Viewed in the light of the fact that the presence of even the

smallest quantity of saline matter in solution prevents the formation of ice at 0°C . and promotes its liquefaction at temperatures below 0°C ., we see that this apparent expansion of the ice on cooling is probably due to the fact that we are dealing not with homogeneous solid ice but with a mixture of ice and saline solution. As the temperature falls this solution deposits more and more ice and its volume increases. But the increase of volume is due to the formation of ice out of water and not to the expansion of a crystalline solid already formed.

In Table III. are given the volumes occupied by the ice (with inclosed brine) formed by freezing 100,000 c.c. (at 0°C .) of a water containing chloride of sodium equivalent to 7 grammes chlorine in 1,000,000 cubic centimetres (at 0°C .).

TABLE III.—Water containing 7 parts Cl in 1,000,000.

Temp. $^{\circ}\text{C}$.	Water frozen. c.c.	Ice formed. c.c.	Brine remaining. c.c.	Ice and Brine. c.c.	Pettersson III. Vol. of ice at T . c.c.	Diff.
T	V_1	v_1	V_2	T_2	P	$P - v_2$
-0.07	99000	107979	1000	108979	108980	I
-0.10	99300	108306	700	109006	109007	I
-0.15	99533	108561	467	109028	109038	10
-0.20	99650	108687	350	109037	109048	11
-0.40	99825	108879	175	109054	109057	3

The volume of the ice formed on freezing this water is compared with that observed by Pettersson in freezing a sample of the distilled water in ordinary use in the laboratory.

It will be seen that the volumes observed by Pettersson agree very closely with those calculated for a water containing 7 parts of chlorine in a million.

The irregularities in the melting-points of bodies like acetic acid, to which Pettersson refers, are without doubt due to a perfectly similar cause.

Also the very low latent heat observed by Pettersson for sea-water is to be explained by the fact that the salt retains a considerable proportion of the water in the liquid state even at temperatures many degrees below the freezing-point of distilled water.

The plasticity of ice and the motion of glaciers receive a simple and natural explanation when we see, as in Table III., that, if the water from which this ice is produced contains no more than 7 parts of chlorine per million, it will, in the process of thawing, when the temperature has risen to -0.07°C ., consist to the extent of 1 per cent. of its mass of liquid brine or water. The water considered in Table III. is certainly not less free from foreign ingredients than rain or snow. It follows, therefore, that a glacier, in a climate where the temperature is for the greater part of the year above 0°C ., must have a tendency to flow, owing to the power of saline solutions to deposit ice and to dissolve it at temperatures below 0°C .

(To be continued.)

NOTES

THE Endowed Schools Committee, of which Sir Lyon Playfair is Chairman, after sitting for a year and a half, have agreed to their Report. This is not yet issued, but it is known that the Committee have reported in favour of endowed schools being in future largely used for the promotion of scientific and technical education. The Report also recommends that local authorities should be authorised to employ local rates for founding or contributing to laboratories and workshops in such schools in order to promote practical scientific education.

LAST week an important Conference was held at Oxford for the consideration of questions connected with the University Extension Scheme. The meetings were attended by many members of the University, local delegates, and others interested in

this method of University development. There can be no doubt whatever as to the good work done by University Extension lecturers. Unfortunately, however, it is hard to obtain the funds which are necessary for the complete success of the experiment. One speaker urged that "the University should lead the way by the creation of a Jubilee Fund, and so stimulate local efforts." To this Prof. Rogers replied that the University was "positively poor." Prof. Rogers added that the result of an appeal to London Companies "had not been favourable," but that the Charity Commissioners might perhaps be willing to do something for the movement.

THE American Exhibition to be opened in the Earl's Court neighbourhood on May 9 will contain much that ought to be of scientific interest. The large encampment of American Indians will be found to contain a great variety of types, and ought to prove attractive to ethnologists. The machinery department will contain many illustrations of the successful applications of science, especially in the section directed to machines for the production and application of electricity. Under mining and metallurgy there will be a large collection of minerals, ores, and stones, beside specimens of metallurgical products. In the department of education and science will be found illustrations of the varied educational appliances and apparatus used in the United States, exhibits from the many institutions and organisations which exist in the States, and a very varied collection of scientific and philosophical instruments.

A NEW scientific journal—*Centralblatt für Physiologie*—has made its appearance this month in Germany. It is edited by Dr. S. Exner, of Vienna, and Dr. J. Gad, of Berlin, who have the advantage of the co-operation of the Berlin Physiological Society. The journal will be issued once a fortnight.

A MONUMENT to Galileo has been erected in Rome, on the Via Pincio, fronting the old Medici Palace, now occupied by the French Embassy, where he was kept a prisoner, in 1637, during his prosecution by the Inquisition. The monument consists of a column with a pedestal, on which is the following inscription in the Italian language:—"Erected in memory of Galileo Galilei, who was kept a prisoner in this Palace, for having seen that the earth moves round the sun."

DR. R. MÜLLER publishes, in the April number of *Mittheilungen aus dem Gebiete des Seewesens*, the results of an investigation as to whether or not the popular idea of equinoctial gales, the existence of which was contested some time ago as regards this country by Mr. Scott (*NATURE*, vol. xxx. p. 353), holds good for the Adriatic Sea. For this purpose the hourly records of the anemometer at Pola, from 1876-86, were used. During this period strong winds or gales were registered on 677 days, 63 per cent. of which occurred in the winter season (October to March). The months with least wind were naturally June and July; then a tolerably regular increase in the number of days with stormy winds took place till the end of January. A considerable decrease occurred in February, while March had the greatest number of stormy days. The result arrived at is that, for the Adriatic, no important influence can be attributed to the equinoctial seasons, especially during the autumnal equinox. Dr. Müller also quotes a similar investigation made by the *Deutsche Seewarte*, for the years 1878-83, for the German coasts, with nearly similar results; the percentage of storms for the winter season being 80 per cent., and for the summer season only 20 per cent. The greatest number of storms occurred in November and December, March having 14 per cent., and September 3 per cent. only.

AT a recent meeting of the Italian Meteorological Society, reported in its *Bollettino mensuale* for February last, the Committee enumerated the meteorological stations lately established by it

abroad, viz. one in Tripoli, two in the Argentine Republic, three in Uruguay, one in Colombia (South America), and one in Mexico, and notified their intention of shortly establishing others on the Patagonian coasts of the Pacific, and in some of the islands near Cape Horn. Among other matters discussed was the proposed suppression of the *Bollettino decadico*—which has reached its fourteenth yearly volume, and which contains the observations made at ordinary stations, and at stations in the Alps and Apennines, for decades—as the increasing work of the Society renders its publication difficult. The monthly means of these observations appear in the *Bollettino mensuale*, but the last published are for March 1886.

ON the night of April 12, at about 11.30, a brilliant meteor was seen in Værdalen, in Norway. It appeared in the east, and went in a southerly direction. At first the colour was a pure white, but during the progress of the meteor it changed into green and yellow. The lustre of the body was very bright, and its greatest apparent size was about that of an ordinary plate. On the meteor disappearing from view behind a mountain ridge, a sudden brilliancy seemed to indicate that it had burst into fragments, but no detonation was heard. It left a faint trail of smoke behind, about a few yards in length, which remained for a few seconds in the sky, then disappeared.

ON April 13 a shock of earthquake was felt at Lisbon, and in Malta and Sicily. Considerable alarm was caused in Jersey at a few minutes past 3 o'clock on the morning of April 21 by a slight shock of earthquake, the direction of which was from south-west to north-west. There was so loud a noise that at first some persons fancied guns were being fired. About the same time a smart shock of earthquake was experienced in Guernsey. A decided tremor of the earth, lasting about three seconds, and accompanied by a rumbling noise, was felt in all parts of the island.

THE death is announced of Dr. Nathaniel Lieberkühn, Professor of Anatomy at the University of Marburg, on April 14, at the age of sixty-five; and of Herr J. B. Obernetter, well known by his researches in photographic chemistry, on April 13, at the age of forty-seven.

A NEW GUINEA Exhibition will shortly be opened at Bremen.

MESSRS. R. FRIEDLÄNDER AND SON, of Berlin, send us the first quarterly list for 1887 of their new publications. It includes many valuable works in natural history and the exact sciences.

THE scheme for the formation of a North Sea Fisheries Institute is still under the consideration of the National Fish-Culture Association and of various local authorities, by whom efforts are being made to secure the necessary funds. It is proposed to form a Fish-Culture Station at Cleethorpes, and schools at Grimsby, and to carry out scientific observations wherever the conditions seem to be most favourable. Particular attention is to be given to the culture of the oyster and cod. A meeting has lately been held in London to advance the undertaking, and another is to take place shortly at Grimsby for the same purpose.

THE list of elements whose atomic weights have been determined with great accuracy has just received two valuable additions, for although one of them, silicon, is by no means rare in its occurrence in nature, and the other, gold, is neither among the most recently discovered of metals nor rare from the chemist's point of view, yet past determination of the atomic weights of these important elements have resulted in leaving the subject enshrouded with considerable ambiguity. Prof. Thorpe and Mr. J. W. Young, who have recently determined the atomic weight of silicon, used for this purpose the tetrabromide SiBr_4 ,

and, instead of the small quantities of material used by other experimenters, prepared upwards of half a kilogramme of this substance by passing bromine vapour over a heated mixture of pure silicon dioxide and charcoal. The product was rectified in an atmosphere of nitrogen, and portions for analysis were collected in bulbs without exposure to air; these bulbs were then broken in bottles containing pure water, and in each case the resulting turbid liquid was very slowly evaporated to complete dryness, the relation of the weight of silicon dioxide obtained to that of the tetrabromide used forming the basis of the calculations. The result of this long and difficult series of analyses fixes the atomic weight of silicon as 28.332. The instability of the salts of gold has long been a stumbling-block in the way of obtaining accurate determinations of its atomic weight, but Prof. Thorpe and Mr. A. P. Laurie have overcome this difficulty by utilising the double bromide of gold and potassium, which they prepared by digesting together pure gold, bromine, potassium bromide, and water, the salt being afterwards subjected to several recrystallisations. An unknown quantity of the pure salt was then carefully ignited, and the mixture thus obtained, of potassium bromide and gold, weighed; after removal of the potassium bromide by washing, the weight of residual gold obtained in each analysis furnished data from which one set of values averaging 195.876 was obtained. The bromine in the potassium bromide as determined by titration with silver nitrate gave a second averaging 196.837, and the weight of silver bromide formed yielded a third series of numbers, averaging 196.842. Taking Stas's value for oxygen at 15.96 the atomic weight of gold is fixed by these analyses at 196.85; but if, along with Mendelejeff, we consider oxygen 16, then gold becomes 197.28, and it is interesting to note that Mendelejeff considered the old value, 195.2, to be too low, there being no place in the periodic system for an element of this atomic weight having the properties of gold. Hence the result of the present determination has been to place gold in its proper position in the periodic classification. Prof. Kriess has just published (*Ber. Dut. Chem. Ges. No. 2, 1887*) the results of a determination of the atomic weight of gold recently made by him, according to which the probable value is 196.64. The method employed, however, was slightly different from the above, a weighed quantity of the double bromide itself being used as the basis of a portion of the analyses.

In a paper on Electric Locomotion, read before the Society of Arts on the 20th inst., Mr. Reckenzaun pointed out that in the United States and on the European continent there are dozens of electric tramways at work to the satisfaction of everybody, while we have few opportunities of testing their advantages in England. Yet England is "the home of the dynamo-machine, the country where the electromotor has found its highest development." We have been outstripped in this matter chiefly because an Act of Parliament must be obtained before electric cars can be run, and every company has to apply for it separately.

The other day M. Émile Rivière discovered a prehistoric station in the wood of Chaville, to the right of the Versailles road, in a part where there are comparatively few trees. Some flint implements and weapons were found, and a fragment of coarse pottery without ornament.

At the February meeting of the Pekin Oriental Society, Mr. Owen read a paper on animal worship amongst the Chinese. He referred at considerable length to the worship paid to the fox, weasel, hedgehog, and snake, to which at Tientsin is added the rat. The first four are called the immortals. These deified animals seem to usurp the entire attention of the people, even to the exclusion of the Buddhist and Taoist gods. Dr. Edkins quoted from the Chinese to prove that animal worship was unknown in ancient times, while Dr. Dudgeon pointed out that

it was a mistake to suppose that animal worship was confined to the four animals mentioned. The horse, cow, dog, insects, dragon, lion, &c., are worshipped. In the fifth month the centipede, lizard, scorpion, frog, and snake—the five poisonous animals, as they are called—are also objects of worship. Dr. Martin disputed Dr. Edkin's theory that animal worship was unknown in ancient times because it was not mentioned by Confucius; he (Dr. Martin) believed that it existed to a much greater extent in ancient than in modern times. From the observations of other speakers it is clear that animal worship occupies a very large place in Chinese superstitious observances.

THERE was an interesting Geographical Exhibition in connexion with the meeting of the Deutsche Geographentag at Karlsruhe on the 13th inst. An historical department showed the development of cartography, all the exhibits being from Baden and Württemberg. Water-colour sketches by the well-known African traveller Paul Reichard, and some fine oil sketches by the painter Hellgräve, who was sent to East Africa by the Artists' Club at Berlin, were exhibited. In the plant department were shown cotton plants found growing wild in Togoland, wild coffee and sugar-cane from Cameroons, and tobacco and various seeds from the gardens of the German East African Society.

AN interesting case of "colour-hearing" was recently reported to a meeting of the Société de Psychologie Physiologique. In this case, colour hearing was an hereditary peculiarity, transmitted from father to daughter.

THE third volume of the "Grande Encyclopédie" has just been published. It is expected that thirty volumes will probably be required to complete this great work. Each volume consists of 1200 quarto pages in two columns, printed in small type.

EVERYONE who takes an interest in zoology is probably acquainted with the "Zoological Record," which consists of an annual volume containing a summary of the work done in the various branches of zoology. It was begun in 1865, and for the first six years was published by Mr. Van Voorst. For the last sixteen years it has been carried on by an Association of zoologists called the "Zoological Record" Association, who have received assistance in the shape of grants from the Government Fund of the Royal Society, the British Association, and the Zoological Society of London. The "Zoological Record" Association, having been lately unsuccessful in obtaining the continuance of some of these grants, and being unwilling to carry on the publication of the "Record" any longer, have agreed, upon certain conditions, to transfer their whole stock to the Zoological Society of London, who, for the future, have determined to carry on this most useful publication. The "Zoological Record" will, therefore, beginning with the volume for the present year (which will contain the record of the zoological literature of 1886), be published by the Zoological Society of London, under the management of a Committee of the Council of that Society, and will be edited by Mr. F. E. Beddard, the Society's Prosector. The "Record" will be published for the Society by Messrs. Gurney and Jackson at the former price of 30s. per volume. But all members of the Society will have the privilege of receiving it, including the cost of delivery, at a subscription price of 20s. per annum. This subscription will be due on July 1 in every year, and the privilege of subscription will be forfeited unless the amount be paid before December 1 following. The Zoological Society, having purchased the entire stock of the "Zoological Record," are now able to supply complete sets of the first twenty-two volumes at the price of 5*l.* 10*s.*, that is 5*s.* per volume. Volumes of any single year can likewise be supplied at 10*s.* per volume. Learned Societies and Institutions and members of the former "Zoological Record" Association

will be permitted to subscribe to the "Record" on the same conditions as are accorded to members of the Zoological Society.

It is intended to form a class, including beginners and advanced students, this summer, in the same way as last year, for the study of geology near London, to be conducted on Saturday afternoons, by Prof. H. G. Seeley, F.R.S., King's College. Applications for tickets should be made at once to the Hon. Secretary, W. W. R. May, 16 Bethune Road, Manor Road, Stoke Newington, N.

THE additions to the Zoological Society's Gardens during the past week include two Rhesus Monkeys (*Macacus rhesus* ♂ & ♀) from India, presented by Mr. W. F. Lock; a Common Fox (*Canis vulpes* ♂) British, presented by Mr. Isaac Bell, Jun.; a Bosch-bok (*Tragelaphus sylvaticus* ♂) from South Africa, presented by Capt. Travers; a Vulpine Phalanger (*Phalangista vulpina* ♂) from Australia, presented; two Turkey Vultures (*Cathartes aura*) from the Falkland Islands, presented by Mr. James H. Moore; a Common Viper (*Vipera berus*), British, presented by Mr. S. E. Gunn; a Chinese Lark (*Melanocorypha mongolica*) from China; two Common Rheas (*Rhea americana* ♂ & ♀) from the Argentine Republic, received in exchange; a Burrhel Wild Sheep (*Ovis burrhel*); two White-backed Pigeons (*Columba leuconota*) from the Himalayas; a Hodgson's Partridge (*Perdix hodgsonia*) from Bootan, purchased; four Long-fronted Gerbilles (*Gerbillus longifrons*), born in the Gardens.

OUR ASTRONOMICAL COLUMN

BARNARD'S FIRST AND SECOND COMETS 1887.—Comet *c* 1887, discovered by Mr. Barnard on January 23, has now attained a high declination, and, though faint, may possibly be observed within the next few days. Dr. H. Kreutz gives the following ephemeris for it for Berlin midnight, derived from Dr. H. Oppenheim's elements:—

1887	R. A.	Decl.	log Δ	log r
	h. m. s.			
April 27	1 12 46	65 40.4	0.4742	0.3989
29	1 21 49	65 52.7		
May 1	1 30 47	66 3.8	0.4827	0.4057
3	1 39 38	66 13.7		
5	1 48 22	66 22.5	0.4910	0.4125

Correction of ephemeris for April 15, in R.A. + 3m. 46s.; in Decl. nil.

The second comet discovered by Mr. Barnard, viz. Comet *d* 1887, discovered February 16, is scarcely likely to be seen further. Its present brightness is but one-seventh of that which it had on March 11, and having almost exactly the same R.A. as the sun it scarcely frees itself from the twilight. An ephemeris for its course throughout the month of April, based on Dr. Palisa's elements, was given by Dr. Kreutz in the *Astronomische Nachrichten*, No. 2777, and in the *Observatory* for April; but the probability of its being observed after the April full moon had passed away, except with very powerful instruments, was very slight.

PROBABLE RE-DISCOVERY OF HESPERIA.—Dr. R. Luther detected a minor planet on April 11 which it appears probable is no other than the lost Hesperia, No. 69, as the magnitude and motion resembled those of the missing asteroid. Dr. Luther had previously looked for the planet in vain in 1882, 1885, and in March of the present year.

THE ELLIPTICITY OF URANUS.—Prof. W. Valentiner, of the Karlsruhe Observatory, writing in the *Astronomische Nachrichten*, No. 2781, states that Herr von Rebeur, observing Uranus with the 6-inch refractor of the Observatory on the evening of April 3, noticed that the disk appeared distinctly elliptical. On the following evening Prof. Valentiner himself observed the planet, and found that the direction as estimated of the major axis of the disk, the ellipticity of which was unmistakable, agreed closely

with that of the assumed equatorial diameter as read off from the position-circle of the micrometer. Prof. Valentiner brings the subject forward now in the hope that those astronomers who have the command of powerful telescopes may be induced to give some attention to it.

THE WASHINGTON OBSERVATORY.—It appears from *Science*, vol. ix. No. 218, that the statement (reported in last week's *NATURE*, p. 595) that the sum of 400,000 dollars had been appropriated by Congress for the erection of a new Naval Observatory near Washington is erroneous. The amount actually available is but 100,000 dollars, with the understanding that the entire cost of the work shall not exceed 400,000 dollars.

THE PARIS CONFERENCE.—The same number of *Science* states that Ensign Winterhalter, of the United States Naval Observatory, had sailed for Paris, to represent the Observatory at the Photographic Conference. It is understood that Dr. Peters, of Clinton, and Mr. Rutherford, of New York, will also attend the Conference.

ASTRONOMICAL PHENOMENA FOR THE WEEK 1887 MAY 1-7

(FOR the reckoning of time the civil day, commencing at Greenwich mean midnight, counting the hours on to 24, is here employed.)

At Greenwich on May 1

Sun rises, 4h. 34m.; souths, 11h. 57m. 0.2s.; sets, 19h. 20m.; decl. on meridian, 15° 4' N.; Sidereal Time at Sunset, 9h. 58m.
Moon (Full on May 7) rises, 11h. 27m.; souths, 18h. 59m.; sets, 2h. 19m.*; decl. on meridian, 14° 0' N.

Planet	Rises	Souths	Sets	Decl. on meridian
	h. m.	h. m.	h. m.	
Mercury	4 6	10 30	16 54	3 59 N.
Venus	5 58	14 21	22 44	24 16 N.
Mars	4 32	11 51	19 10	14 24 N.
Jupiter	18 1	23 14	4 27*	9 59 S.
Saturn	8 30	16 38	0 46*	22 21 N.

* Indicates that the setting is that of the following morning.

Occultations of Stars by the Moon (visible at Greenwich)

May	Star	Mag.	Disap.	Reap.	Corresponding angles from vertex to right for inverted image
			h. m.	h. m.	
1	♄ Canceri	6	0 25	0 53	172 236
5	♍ Virginis	2½	0 25	1 8	141 230
5	B.A.C. 4277	6	1 40	1 46	186 199
5	♌ Virginis	5	21 30	near approach	323 —
May	h.				
1	15		Venus at least distance from the Sun.		
6	8		Jupiter in conjunction with and 3° 14' south of the Moon.		

Saturn, May 1.—Outer major axis of outer ring = 39"9; outer minor axis of outer ring = 16"4; southern surface visible.

Variable Stars

Star	R.A.	Decl.	h. m.
	h. m.		
U Cephei	0 52.3	81 16 N.	May 4, 3 40 <i>m</i>
S Aurigæ	5 19.7	34 3 N.	" 3, <i>M</i>
R Canis Minoris	7 2.5	10 12 N.	" 6, <i>m</i>
R Camelopardalis	14 26.2	84 21 N.	" 4, <i>M</i>
♋ Libræ	14 54.9	8 4 S.	4, 20 11 <i>m</i>
U Coronæ	15 13.6	32 4 N.	7, 22 7 <i>m</i>
S Herculis	16 46.8	15 8 N.	" 3, <i>m</i>
R Ophiuchi	17 1.3	15 57 S.	" 2, <i>M</i>
U Ophiuchi	17 10.8	1 20 N.	" 4, 2 37 <i>m</i>
		and at intervals of 20 8	
W Sagittarii	17 57.8	29 35 S.	May 2, 22 0 <i>m</i>
			6, 2 0 <i>M</i>
T Herculis	18 4.8	31 0 N.	" 7, <i>m</i>
U Sagittarii	18 25.2	19 12 S.	" 3, 2 0 <i>m</i>
			" 5, 1 0 <i>M</i>
β Lyræ	18 45.9	33 14 N.	" 2, 22 0 <i>M</i>
			" 6, 4 0 <i>M</i>
R Aquilæ	19 0.9	8 4 N.	" 2, <i>m</i>

M signifies maximum; *m* minimum; *m*₂ secondary minimum.

Meteor-Showers		R.A.	Decl.
Near ν Herculis	...	236	47° N.
η Ophiuchi	...	254	21 S.
ζ Draconis	...	262	64 N.
α Aquilæ	...	298	5 N.

GEOGRAPHICAL NOTES

We are glad to know that General R. Strachey, R.E., F.R.S., has agreed to accept the presidency of the Royal Geographical Society, in succession to Lord Aberdare. The Society's honours or the present year will be conferred as follows:—The Founder's Medal to Lieut.-Colonel T. H. Holdich, R.E., for the eminent services he has rendered to geography in Afghanistan; the Patron's Medal to the Rev. George Grenfell, for the extensive explorations he has carried out during his thirteen years' residence in Africa, partly in the Cameroons country and more recently in the Congo region; the Murchison Grant to Mr. George Bourne, second in command and sole survivor of the Landsborough Expedition, which crossed the continent of Australia in 1861; the Back Premium to Sarat Chandra Das, for his researches in Tibet; the Gill Memorial to Mr. J. F. Needham, for his explorations in the Lohit Valley of the Brahmaputra. The following have been made Honorary Corresponding Members:—H.R.H. Krom Mun Damrong Rajah Nubharp, Director-General of Surveys and Minister of Public Instruction, Siam; Dr. Alfred Kirchoff, Professor of Geography at Hallé University, and President of the Hallé Geographical Society; and Dr. E. Naumann, late Director of the Geographical and Topographical Survey of Japan.

THE paper read at the Royal Geographical Society on Monday was by General J. T. Walker, F.R.S., on the Lu River of Tibet, the Lu-Kiang, or Lu-tse-Kiang of the Chinese. This river is generally held to be the source of the Salwin, but General Walker adduced many reasons for maintaining that it is more probably that of the Irrawadi. In the course of an able paper, the result of much research, General Walker gave a most useful summary of exploration in this highly interesting hydrographical region; more particularly insisting on the value of the work of the late Abbé Krick, who ascended the Lohit in 1852, but of whom little is known in this country. General Walker made out a strong case for his position, but the leading conclusion of his valuable paper is that further exploration in this remarkable region is urgently demanded. Probably no region of the earth would yield more valuable results to scientific geography.

ACCORDING to the latest news, Mr. Stanley is well up to time in his ascent of the Congo with the Emin Pasha Expedition. He is at present on his march across country from Matadi, at the lower end of the Livingstone Falls, to Leopoldville, on Stanley Pool. It is hoped that when he reaches the Pool he will find sufficient vessels in readiness to convey his large following up the river without delay. So far the Expedition has been exceedingly fortunate.

THE statement that Baron Nordenskjöld will undertake an Antarctic expedition at the expense of the King of Sweden and Mr. Oscar Dickson is, to say the least, premature. We are informed by Mr. Dickson that Baron Nordenskjöld is "willing" to undertake such an expedition, but that if he does so neither the King of Sweden nor Mr. Dickson will find the money. No doubt Baron Nordenskjöld would be an excellent leader for such an expedition, and as Committees have been formed both in this country and in Australia to promote Antarctic exploration, would it not be wise in them to unite their forces, and place themselves in communication with the Baron? Those who are competent to give an opinion on the subject maintain that an Antarctic expedition is much less risky than one to the other Pole. There would be no difficulty in a party wintering on some part of the Antarctic continent; a vessel could cruise round the verge of the ice during the winter and watch a favourable opening, of which immediate notice could be given to the exploring party, while a third vessel could leave New Zealand at a suitable time with additional supplies. No doubt the subject will again be brought up at the next meeting of the British Association, when it is hoped a strong and active Committee will be appointed. Baron Nordenskjöld will be among the distinguished foreigners invited to the meeting, and we hope he will accept the invitation.

THE Germans continue to show great activity in the exploration of their portion of New Guinea. Freiherr von Schleinitz has recently accomplished a running survey of Huon Gulf, and besides establishing the direction of the coast-line and the positions of reefs, has laid down eight hitherto unknown harbours and discovered nine new rivers. Some of them, especially the Markham River, would form excellent routes for the exploration of the interior; the broad valley of the latter extends for miles between high ranges of mountains. The south coast of Huon Gulf consists exclusively of primitive and metamorphic rocks, with older sedimentary rocks and volcanic formations. At a later date a further survey was made of the coast from Astrolabe Bay to the mouth of the Empress Augusta River, and led to the discovery of a series of bays, harbours, islands, and rivers.

M. GRIMALLO, in company with his brother, an engineer, and six Cossacks, has set out for a further exploration of the Pamir.

DR. LABONNE left Cherbourg a few days ago for a further exploration of the geysers and glaciers of Iceland.

PRELIMINARY NOTE ON THE FOSSIL REMAINS OF A CHELONIAN REPTILE, CERATOCHELYS STHENURUS, FROM LORD HOWE'S ISLAND, AUSTRALIA¹

THE interesting remains of which I propose to give a brief notice in the present communication are contained in a friable sandstone (apparently formed of concreted blown sand), and they have a very recent appearance. The age of the deposit in which they are found is unknown, but it is probably Quaternary. The specimens have been for some years in the palæontological collection of the British Museum, and, for the most part, they have not yet been submitted to careful examination. But I learn that the greater number of them were long since rightly determined to be Chelonian by Mr. Davis, and set aside as such.

Several of the most important of these numerous and, in general, very fragmentary bones were originally found imbedded close together in the same block of sandstone. They consist of a great part of a pelvis, a caudal vertebra, and an imperfect skull. Of the pelvis, a right ischium and a pubis are imbedded in the rock, while an imperfect right ilium, which fits well on to the ischium, is separate; all these bones are unmistakably Chelonian. The caudal vertebra has remarkable peculiarities. It resembles an ordinary Chelonian caudal vertebra from the anterior half of the tail, in its general characters; but it is strongly opisthocœlous, the centrum having a deep cup behind and a correspondingly curved articular head in front. From the posterior part of the ventral face two stout processes diverge, and present terminal rounded facets for the rami of the large chevron bone which must have articulated with them. As a general rule, the caudal vertebrae of Chelonia are procelous—but *Chelydra* and *Gypochelys* (perhaps also *Staurotypus* and *Platysternum*) form well-known exceptions,² in so far as the vertebrae behind the third and fourth are strongly opisthocœlous. In fact, the vertebra in question closely resembles the sixth or seventh of *Chelydra* or of *Gypochelys* (see Figs. 1 and 2). In the first, however, the transverse processes are very much stronger, and the pentagonal platform into which the upper surface of the neural arch expands, in place of a neural spine, is as long as the vertebra, instead of being only about half as long. The stout pre-zygapophysis of the right side is broken off, leaving only the base visible in the fossil.

¹ Paper read at the Royal Society, by Prof. Thomas H. Huxley, F.R.S., on March 31.

² The opisthocœlous character of most of the caudal vertebrae of *Chelydra* was first pointed out by Von Meyer in his description of the Eningen *Chelydra*. Baur ("Osteologische Notizen," *Zool. Anzeiger*, No. 238, 1886) has gone fully into the question, and has pointed out the exceptional nature of their structure among the Chelonia. Since the above paragraph was written, Dr. Günther has kindly enabled me to examine a spirit specimen and a skeleton of *Platysternum*. The caudal vertebrae resemble those of *Chelydra*, except that the last nine are procelous, while that between these and the more anterior opisthocœlous vertebrae is nearly flat at the ends. In this, as in other respects, *Platysternum* presents characters intermediate between *Chelydra* and the ordinary *Emyda*. Prof. Cope ("Vertebrae of the Tertiary Formations of the West," 1883, p. 111) ascribes opisthocœlous caudal vertebrae to the *Bemida*, but no figures or descriptions of such vertebrae are given. Of the opisthocœlous Chelonian vertebrae figured in Plate XXIV. of the "Report of Extinct Vertebrata obtained in New Mexico" (1887), it is expressly stated that their "correct reference cannot now be made" (p. 143).

Two other caudal vertebræ, having the same structural features, occur among the detached remains, and belong, like the first, to the second fourth of the tail. Another tolerably complete vertebra, with a considerably longer centrum, corresponds very closely with a caudal vertebra of *Gypochelys* from the third fourth of the tail. In this, as in one of the foregoing vertebræ, the chevron bones are ankylosed with the centrum. I conceive, then, that there can be no doubt that the pelvic bones and these caudal vertebræ belonged to a Chelydroid Chelonian, of about the size of the largest "snapping turtles" which are met with in North America at the present day.

Primâ facie, the skull found in the same block might also be expected to be that of a Chelydroid; and, in fact, it is so. I do not base this interpretation on the Chelonian character of the

upper jaw, as there are various extinct Saurian reptiles which closely approximate to Chelonia in this part of their structure. The diagnostic characters lie in the back part of the skull; and especially in the auditory region, which is altogether Chelonian. Not only so, but when this fragmentary skull is compared with that of *Chelydra*, the correspondence between the two is singularly exact (Figs. 3 and 4). In two respects, however, the fossil differs from *Chelydra* and *Gypochelys*.

(1) The roof over the temporal fossa formed by the parietal, post-frontal, and other bones, which leaves the auditory region uncovered in the recent genera,¹ extends back, beyond the occiput, in the fossil, and sends down a broad vertical rim from its margin.

(2) The upper surface of the cranial shield is, at most, rugo-e

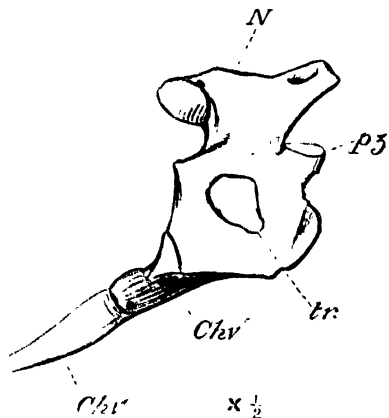

FIG. 1.—Caudal vertebra of *Ceratochelys*. *N*, platform on the neural arch; *ps*, pre-zygapophysis mutilated; *tr*, broken transverse process; *Chv'*, processes for the chevron bone; *Chv*, chevron bone.

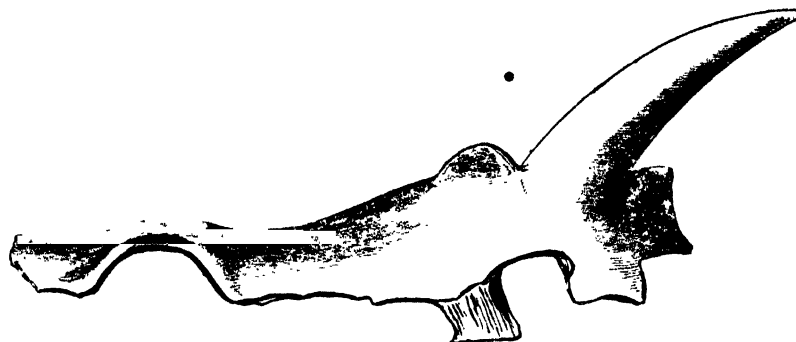

FIG. 3.

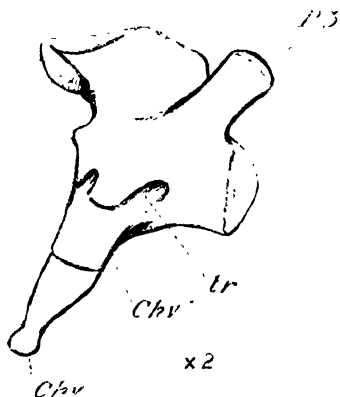

FIG. 2.—Caudal vertebra of *Chelydra*. Letters as in Fig. 1.

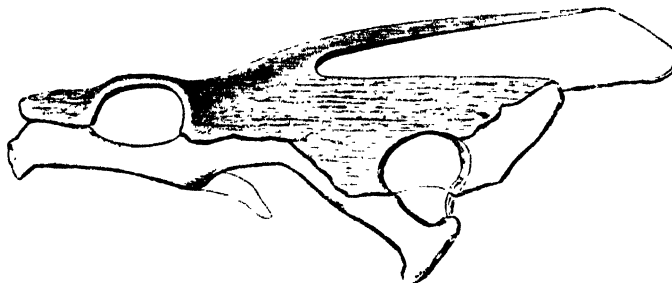

FIG. 4.

FIGS. 3, 4.—Skulls of *Ceratochelys* (Fig. 3) and *Chelydra* (Fig. 4); the latter of the natural size, the former much reduced. The portion of the skull of *Chelydra* which corresponds with the fossil is shaded.

in the recent *Chelydridæ*; in the fossil, three strong conical processes, like horn-cores, of which the middle is the longest, are developed from its posterior and lateral region.¹

This skull is described and figured in the Philosophical Transactions for 1886 (Plate 30, Fig. 1) by Sir R. Owen, under the generic or sub-generic name of *Meiolania*, and is said to belong to a Saurian reptile closely allied to the "*Megalania prisca*" described in earlier communications. But the skull is assuredly that of the Chelydroid Chelonian to which the pelvis and caudal vertebra belong. What *Megalania prisca* may be I do not pretend to say; but the remains which I have described can have nothing to do with any Saurian reptiles; and I propose to confer

¹ It is possible that these may be dermal bones coherent with the proper cranial shield.

on the genus of Chelonia to which they belong the name of *Ceratochelys*.

The singular osseous caudal sheaths described by Sir R. Owen, in the same memoir, also appertain to *Ceratochelys*. They formed part of the series of remains sent to the British Museum along with the foregoing, in which none but Chelonian bones have yet been discovered; and the remains of vertebræ left in these sheaths are similar to the caudal vertebræ of the terminal fourth of the tail in the *Chelydridæ*. The snapping turtles are noted for the length and strength of the tail and for the strong, laterally-compressed, acuminate "scales" which form a crest along the median dorsal line, while others, less strongly keeled, lie at the sides of the tail. In many Chelonia, the extremity of

² The "roof" extends much further back in *Platyserium*.

the tail is enveloped in a continuous sheath. These and other bale-like structures in the Chelonia are usually spoken of as if they were entirely epidermal. But, a day or two ago, Dr. Günther informed me that in the Australian tortoise, *Manouria*, the great imbricated scales of the limbs contain bony scutes; and that similar scutes are to be found in *Testudo graeca*. This, of course, suggested the examination of the caudal scales of *Chelydra* and *Gypochelys*; and, having been enabled by Dr. Günther's kindness to examine the caudal scales of a good-sized specimen of the latter, I have found that those of the crest contain bony scutes.¹ The bony scute corresponds very closely in form with the whole "scale," but the recurved apex of the latter is formed only by epidermal substance (Figs. 5 and 6).

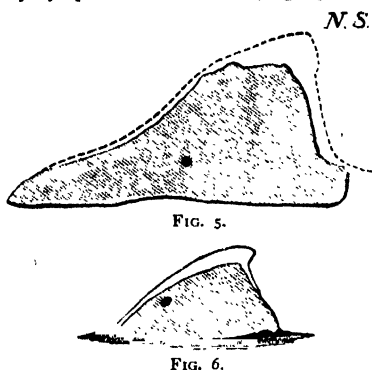

FIGS. 5, 6.—Sectional views of a scute of the tail-armour of *Ceratochelys* (Fig. 5), and of one of the crest plates of *Gypochelys*, both of the natural size.

The living *Chelydra*, therefore, has a caudal armature which, in principle, is similar to that of *Ceratochelys*, but the osseous elements are relatively atrophied. There is exactly the same relation between the armour of species of living *Crocodyles* and *Alligators*, on the one hand, and those of *Facare* and *Caiman* and the extinct *Teleosauria*, on the other. In the former, the epidermal scales remain well developed on the ventral side of the body, while the corresponding osseous scutes, fully developed in *Facare*, *Caiman*, and *Teleosauria*, have vanished.

Among the detached fragments to which I have referred, there are remains of ribs, with their costal plates; marginal and other plates of the carapace; parts of the plastron; part of a scapula; undry limb bones; and several of the cranial processes called "horn-cores." They all agree, so far as they can be compared, with the determination already arrived at; which, to sum up in a few words, is that the remains of crania and caudal sheaths from Australia, hitherto referred to Saurian reptiles, under the names of *Megalanina* and *Microlania*, appertain to a hitherto unknown species of Chelonian, *Ceratochelys sthenurus*, closely allied to the living *Chelydra*, *Gypochelys*, and *Platyternum*.

The evidence of this fact offered in the present note appears to me to be conclusive, but it may be desirable hereafter to figure the parts mentioned and to describe them at length.

The interest which attaches to the discovery of this singular Chelonian arises partly from the fact that the group of Chelonia to which it belongs is wholly unrepresented in the fauna of Australia, as at present known. *Platysternum* is usually said to be found in China. Dr. Günther, however, informs me that Upper Burmah is its proper habitat; otherwise, North America, east of the Rocky Mountains, is the nearest region in which the *Chelydridae* are to be found. But *Chelydridae*, and, indeed, species of the genus *Chelydra*, occur in Upper Miocene (Ennien) and in Eocene formations in Europe. Moreover, *Platyternum*, of the Upper Jurassic series of Bavaria and Switzerland, regarded by Rüttimeyer as an early form of the group.

Lord Howe's Island is about 200 miles from the nearest Australian mainland, and something like 400 miles, as the crow flies, from the Darling Downs, in which the caudal armour, which has been ascribed to *Megalanina*, was found. The discovery of *Ceratochelys*, therefore, has an interesting bearing on

¹ The fact is noted by Rüttimeyer (Lang and Rüttimeyer, "Die Fossilen Bildkröten von Solothurn," *Denkschriften der Allg. Schweiz. Gesellschaft*, vol. xxii.). The armature of the tail in *Platysternum* is for the most part arranged in zones, of four plates in each zone; but I have not yet been able to find any bones in them.

the question of the former extension of Australia to the eastward, on the one hand; and of the possible derivation of such forms as *Ceratochelys* from Asia, on the other hand. An elevation of the sea-bottom of 6000 feet would place Norfolk Island and Lord Howe's Island on a peninsula extending from the region of the present Barrier Reef to New Zealand; and the flora and fauna of those islands are known to have special affinities with those of New Zealand, and none with those of Australia.

Speculations respecting the origin of the Chelonian carapace are suggested by the discovery of osseous scutes in the vertebral region of the tail, and their coalescence in *Ceratochelys* to form a sort of caudal carapace, ridged in a manner resembling that of *Chelydra* and *Platyternum*. But the consideration of these points would take me beyond the limits of the present note.

THE WORK OF THE IMPERIAL INSTITUTE¹

I.

THE Colonial and Indian Exhibition, which owes not only its conception, but also its brilliantly successful realisation to your Royal Highness, will be pre-eminently remarkable in times to come, for having achieved many results of vital importance and highest benefit to Her Majesty's subjects in all parts of her vast realms.

The collection of all that is commercially valuable and scientifically interesting of the natural products of the great Indian Empire and of the Colonies in one Exhibition, embracing as it also did very comprehensive illustrations of the development of commerce, of the arts, and of certain industries, in the many countries beyond the seas which combine with the United Kingdom to constitute our vast Empire, afforded those at home an opportunity, surpassing all previous conception, of studying and comparing the natural history and resources of those distant lands, of which, attached though we might be individually to one or more of them by ties of friendship or of interest, the knowledge of many of us was of a very vague or partial character.

To the Colonists who visited us last year, the Exhibition has been of inestimable value, in affording them a most favourable and appropriate opportunity of becoming acquainted or renewing their old friendship with the mother country, and of examining the progress there made in industrial, educational, and commercial development; in leading to the cultivation of intimacy between Colonists from different sections of the Queen's Dominions; and in affording them invaluable opportunities of comparing the resources and state of development of their respective countries with those of other parts of Europe. No more convincing illustrations than were provided by this great Exhibition could have been conceived of the importance to the home country, to each Colony, and to India, of fostering intimate relationship and unity of action. No more encouraging proof could have been afforded of the desire of all classes of Her Majesty's subjects at home to cultivate a knowledge of those far-off countries which the enterprise and perseverance of the British, and men of British offspring, have converted into prosperous and important dominions, chiefly during the period of the Queen's reign, than was furnished by the interest which the thousands upon thousands, who came from all parts, displayed in the study of the instructive collections in the galleries at South Kensington.

It was the success of the Exhibition which led to the definite formulation of the suggestion first made by your Royal Highness in a letter addressed by you in the autumn of 1884 to the Agent-General of the Colonial Government, that a permanent representation of the resources of the Colonies and India, and of their continually progressing development, might, with great benefit to the Empire at large, be established in this country. That the realisation of this idea upon a sufficiently comprehensive basis might constitute a worthy memorial of the accomplishment of fifty years of a wise and prosperous reign; a memorial not personal in its character excepting so far as it constituted an emblem of the love and loyalty of Her Majesty's subjects, but tending, as she would most desire, to serve the interests of the entire Empire; this had only to be pointed out by your Royal Highness to be heartily concurred in by the official representatives of the Colonies and India, who

¹ Lecture (abridged) delivered at the Royal Institution, on Friday, April 22, by Sir Frederick Abel, C.B., F.R.S.; H.R.H. the Prince of Wales, K.G., F.R.S., Vice-Patron, in the Chair.

were so intimately identified with the triumphs of the recent Exhibition.

The Committee to whom you, Sir, intrusted the elaboration of a scheme for carrying this conception into effect, became persuaded by a careful consideration of the subject that such an Institution as your Royal Highness desired to see spring into life, to be a memorial really worthy of the Jubilee of Her Majesty's reign, and to fulfil the great purposes which you had in view, must not be confined in its objects to particular portions of Her Majesty's Dominions, but must be made thoroughly representative of the interests and of the unity of the whole Empire.

The outline of the scheme for the establishment of an Imperial Institute for the United Kingdom, the Colonies, and India, which met with the cordial approval of your Royal Highness, was necessarily concise in dealing with the very wide extent of ground which the operations of the Institute are intended to cover; but those who have carefully considered it, and rightly interpreted its proposals, have not failed to realise that it aims at very much more than the creation and maintenance of collections illustrative of the natural resources of our Colonies and of India, and of the development and present condition of the chief industries of different parts of the Empire.

One of the primary objects of the Institute will certainly be the establishment of thoroughly well selected, carefully arranged, and efficiently maintained representations of the natural products which constitute the treasures, and are emblematic of the important positions in the Empire, of those great colonial possessions which, during the fifty years of Her Majesty's reign, have, in many instances, experienced a marvellous development in extent, in commercial, social, and even in political importance. The recent Exhibition not only afforded conclusive demonstration of the great interest and value to the United Kingdom which must attach to such collections if properly organised; it also served, by such illustrations as the magnificent collections of valuable woods, from nearly every colony, many quite unknown in England, and the great variety of valuable economic products from India, of the existence of which we at home had little idea, to convince us that our knowledge of the great countries which constitute the chief portion of the Empire is very limited and imperfect, and that their resources are in many directions still in the infancy of development. Our Colonial brethren cannot, on their part, fail to be greatly benefited by being thoroughly represented in a well-selected and carefully organised assemblage of illustrations of the sources of prosperity which constitute the sinews of their commerce, and upon a continued exploration and cultivation of which must depend the maintenance of their influence upon industrial and social progress. Neither can they fail to reap substantial advantages by pursuing a friendly rivalry with each other in demonstrating the advances made from time to time in the development of the resources of the respective portions of the Empire in which their lot is cast.

The hearty co-operation and important material support to which the great Colonies, through their representatives in London, pledged themselves when the scheme for the proposed Imperial Institute was in the first instance limited to this branch of the great work which it is now contemplated to accomplish, afforded conclusive evidence of their earnest desire to be in all respects thoroughly represented in the mother country, and to take their places permanently in our midst as fellow-labourers in the advancement of the prosperity of the Empire. In furtherance of this important end, a notable feature of that building which, in its character, will, it is hoped, be worthy of the momentous epoch which it is to commemorate, will be the attractions and conveniences presented by it, as a place of resort and a rendezvous for Colonists visiting England, and, it is also anticipated, for the important Societies which represent the Colonies and Asiatic possessions in this country, and the facilities which it will afford for reference to literature concerning the Colonies and India, for conferences on matters of common interest and value to the Colonists and those at home, for the interchange of information between the British manufacturer and those in the Colonies who are directly interested in meeting his requirements, and generally for the cultivation of intimate relations and good fellowship between ourselves and our brethren from all parts of the Empire.

The Institute will, however, not only operate actively under its own roof in promoting the cultivation of a better knowledge of

¹ Statistical statements illustrating the development of the colonies during the Queen's reign are appended.

the geography, natural history, and resources of our Colonies, and for the advancement of the interests of the Colonists in this country; it is also contemplated that representative collections of the natural products of the Colonies and India, carefully identified with the more elaborate collections of the head establishment, shall be distributed to provincial centres, and that the provinces shall be kept thoroughly conversant with the current information from the Colonies and India, bearing upon the interests of the commercial man, the manufacturer, and the intending emigrant.

Although the formation and maintenance up to date of collections illustrative of the development and present condition of the important industries of the Empire also forms, as I have stated, a part of the programme of the Institute, the scope of its activity in relation to industry will be of a much more comprehensive character; indeed, it is to be hoped that the work which it will achieve in furtherance of the development and progress of industries and their future maintenance in the United Kingdom at least upon a footing of equality with their conditions in the great Continental States, will be most prominent in securing to the Imperial Institute the exalted position which it should occupy as the National Jubilee Memorial of Her Majesty's reign.

There is no need for me to recall to the minds of an audience in the Royal Institution the great strides which have been made during the last fifty years in the applications of science to the purposes of daily life, to the advancement of commerce, and to the development of the arts and manufactures. Nor is it necessary to dwell upon the fact that this country is the birth-place of the majority of the great scientific and practical achievements which have revolutionised means of intercommunication, and have in other ways transformed the conditions under which manufactures, the arts, and commerce are pursued. These very achievements, of which we as a nation are so justly proud, have led, however, by many of their results, to our becoming reduced to an equality of position with other prominent nations in regard to important advantages we so long derived from the possession in this country of great material resources easy of access and application, and from the consequent pre-eminence in certain branches of the trade and industry which we so long enjoyed.

In 1852, Sir Lyon Playfair was impelled by the teaching of the preceding year's Great Exhibition to point out that "the raw material, formerly our capital advantage, was gradually being equalised in price and made available to all by the improvements in locomotion," and "that industry must in future be supported, not by a competition of local advantages, but by a competition of intellect." If this was already felt to be the state of the case six-and-thirty years ago, how much more must we be convinced of the full truth of this at the present day, by the conditions under which the British merchant and the manufacturer have to compete with their rivals on the Continent and in the United States.

It is still within the recollection of many that almost the whole world was in very great measure dependent upon Great Britain for its supplies of ordinary cast iron. Even as lately as 1871, the United States of America received from Great Britain nearly one-fifth of its total produce of pig iron; but from 1875 all importation of British iron ceased for over three years, and it was only in consequence of requirements in the States exceeding the capabilities of production, that some small demands arose in 1879, which were for some time maintained.

Within three years, however, the make of iron in the United States increased by 70 per cent., and although, since 1882, the actual make has not increased, the capacity of production has risen enormously, it being at present estimated at nearly 300 per cent. greater than it was in 1879. Looking nearer home, we find that the iron of France, Belgium, and Germany not only competes with ours in the open market, but that Belgian and German iron is actually imported into this country to a moderate extent.

From time to time the ground which we have lost through the development of the resources of other countries has been more than retrieved temporarily by improvements effected through the more thorough comprehension and consequent better application of the scientific principles underlying processes of manufacture, but the ultimate effect of advances of importance has not unfrequently been to improve the position, in relation to the manufactures concerned, of other nations less favourably circumstanced than Great Britain.

The history of the development of steel manufacture during the last twenty-five years affords a most instructive illustration of the

fluctuations which may ensue in the value of our natural resources, and the consequent condition of one or other of our important industries, arising out of continued advances made in the application of science to the perfection or transformation of manufacturing processes, and of the stimulating effects of such fluctuations upon the exertions of those who are able to bring scientific knowledge to bear upon the solution of problems in industrial operations which entirely baffle the ordinary manufacturer. Within that period the inventions of Bessemer and of Siemens have led to the replacement of iron by steel in some of its most extensive applications. This important change in our national industry was, ere long, productive of a serious crisis therein, and for the reason that the pig iron produced from a large proportion of those ores which, from their abundance and the cheapness of their treatment, have been greatly instrumental in placing Great Britain in her high position as an iron-producing nation, could not be applied to the production of marketable steel by means of the Bessemer converter. Hence the application of this rapid steel-making process had to be chiefly restricted to particular kinds of ores, free from the impurity, phosphorus, which it was powerless to eliminate; the supplies of such ores being limited to a few districts in this country. These had to be largely supplemented by importations from other countries; nevertheless the cheapness of production and superiority in point of strength, durability, and lightness of the steel rails thus sent into the market from the Bessemer converter combined to maintain a supremacy of them over iron rails, &c., manufactured by the old puddling process from the staple ores of the country.

The advantages presented by steel over the wrought iron of the puddling furnace for constructive purposes speedily became evident, and the effect of the rapid displacement of malleable iron by steel produced from ores of a particular class has been that at least 85 to 90 per cent. of the iron ores of Great Britain could no longer be applied to the production of material for rails, for ships, and for other important structures. Great has been the apprehension among the owners of those ores that the demand for iron which they can furnish could not revive, but the scientific metallurgist has successfully grappled, from more than one direction, with the great problem of restoring their commercial importance; and a simple alteration of the method of carrying out the Bessemer process has within the last few years led to really triumphant results, with the employment of those ores which before could only be dealt with by the searching operation of the old puddling furnace. A new era has thus been established in steel manufacture, there being now but very few restrictions to the application of the quick processes to iron produced from all varieties of ores. Indeed, the treatment is actually being applied profitably to the recovery of iron from the rich slag forming the refuse-product of the puddling furnace in the production of malleable iron, which before had been condemned to a limited usefulness as a material for road-making. Yet another most interesting and valuable result has been achieved by this simple application of scientific knowledge. The slag or refuse-product of the so called *basic treatment* of iron contains, in the form of phosphates of lime and magnesia, the whole of the phosphorus which it is the main function of that treatment to separate from the metal; it was soon found that the phosphoric acid was there presented in a condition as readily susceptible of assimilation by plants as it is in the valuable artificial manure known as superphosphate; this refuse-slag, simply ground up, constitutes therefore a valuable manure which already commands a ready sale at very profitable prices.

The origination of this latest advance in the development of steel manufacture dates back only nine years, and already the year's product of the basic process amounts to over 1,300,000 tons of steel. But although it is to Englishmen that the owner of iron property and the steel-maker are again indebted for these important results, and to English manufacturers that the first practical demonstration of the success of this process is due, its application has been far more rapidly elaborated upon the Continent than here; in Germany the importance of the subject was first realised, and it is there that considerably the largest proportion of steel is produced by the basic treatment; it is in Germany also that the value of the slag for agricultural purposes has been developed, the first steps in its utilisation here being at just now taken, in Staffordshire.

I have already referred to the remarkable strides which have been made in the extension of iron manufacture in the United States; the development there of steel production has been no less marvellous, and the causes of this are evident; the resources of

the country in ore and fuel are gigantic, and the systematic technical training of the people has made its influence felt upon the development of this as of every other branch of industry which our friendly rivals pursue. But it is not only in the United States that the development in the production of iron and steel has greatly increased of late years; thus, in Germany the increase in the production of pig iron alone, during the last twenty-one years, has been 237 per cent., while with us it has been 75 per cent.

Although, however, the increase in actual production of iron and steel in Great Britain has not kept pace with that of some other countries, it is satisfactory to know that our *productive power* has very greatly increased in late years, and there is probably no one branch of our industries in which we have maintained our position so satisfactorily in regard to quality of product as that of iron and steel manufacture, even though, every now and then, we have indications that in the struggle with other nations for superiority of product and for pre-eminence in continuity of progress, we have to look to our laurels.

There are, however, other important branches of industry, for a time essentially our own, the present condition of which, in this country, we cannot contemplate with equal satisfaction. Several instructive illustrations might be quoted, but I will content myself with a brief examination of one of the most interesting.

In illustrating the advances which were being made, thirty-five years ago, as demonstrated by the Exhibition of 1851, Playfair referred to the great development of the value of the evil-smelling coal-tar, which was then made to furnish the solvent liquids benzene and naphtha, and the antiseptic creosote, the residual material being utilised for pavements and for artificial fuel. The chemist little dreamt then that between 1851 and the year of the next great Exhibition, 1862, coal-tar would have become a mine of wealth equally to science, the manufactures, and to the arts, in which fresh workings have ever since continued to be opened up, and still present themselves for exploration. Hofmann, in his valuable report on the chemical products and processes elucidated by that Exhibition, dwells with the enthusiasm of the ardent worker in science upon the brilliant products obtained from coal-tar which had resulted from the labours of the scientific chemist, and had already acquired an almost national importance, although this great industry was then still in its infancy. From the year 1856, when the first colouring-matter, known as *mauve*, was discovered and manufactured by one of Hofmann's most promising young pupils, Mr. Perkin, down to the present time, the production of new coal-tar colours, or of new processes for preparing the known colours in greater purity, has progressed uninterruptedly, this industry having long since become one of the most important, and also one of the most remarkable, as illustrating by each stage of its development the direct application of scientific research to the attainment of momentous practical results.

The difficulties to be overcome before mauve could be produced upon a manufacturing scale were very great, and were only solved by a steady pursuit of scientific research, side by side with practical experiments suggested by its results. Aniline—the parent of the first coal-tar colour, a liquid organic alkali—a most fertile source of interesting and important discoveries in organic chemistry, was produced with difficulty by various methods in very small quantities, so as to be almost a chemical curiosity at the time of the discovery of mauve. Among the substances from which it had been prepared was the volatile liquid known as *benzene*, first discovered in the laboratory of this Institution in 1825 by Faraday, in the liquid products condensed from oil gas, but afterwards obtained by Mansfield, in the College of Chemistry, from coal-tar naphtha. The conversion of benzene into aniline was accomplished as a manufacturing process after many difficulties by Perkin; and within a year after the discovery of mauve by him, it was in the hands of the silk dyer. Perkin's success led other chemists at once to pursue researches in the same direction, especially in France, where the next important coal-tar colour, *magenta* or *fuchsine*, was obtained, by M. Verguin, the successful manufacture of which in a pure state was, however, first accomplished by English chemists. In 1861 beautiful violet and blue colours were produced, again by French chemists, but were manufactured shortly afterwards in a pure state in England.

The six years succeeding those which formed the first period (1854-62) of existence of this industry were fruitful, not only of many beautiful new dyes, first produced in England, but also

of important progress made here, as well as on the Continent, in the development of the manufacture, and of our knowledge of the constitution, of the parent colours.

In the next period of six years (1868-74) another great stride was made in the coal-tar colour industry, due to important scientific researches carried out by two German chemists, Graebe and Liebermann, which led them, in the first place, to obtain an insight into the true nature of the colouring-matter of one of the most important staple dye-stuffs, namely the madder-root. They found that this colouring-matter which chemists call *alizarine* was related to *anthracene*, one of the most important solid hydrocarbons formed in the distillation of coal, a discovery which was speedily followed by the artificial formation of the madder-dye, alizarine, from that constituent of coal-tar. At first, this achievement of Graebe and Liebermann was simply of high scientific interest; but Perkin, and Graebe, and Liebermann, were not long in discovering methods by which the conversion of anthracene into the madder-dye could be accomplished on a large scale, and the manufacture of alizarine was soon most actively pursued in this country, with very momentous results, as regards the market value of the madder root. The latter has long been most extensively cultivated in Holland, South Germany, France, Italy, Turkey, and India, the consumption of madder in Great Britain having attained to an annual value of as much as 1,000,000*l.* sterling. Playfair pointed out in 1852 that important improvements had lately been attained in the extraction of the red colour or alizarine from the madder-root, but those results, most valuable at the time of the first Great Exhibition, became insignificant when once the dye was artificially manufactured from anthracene; the price paid for madder in 1869 was from 5*l.* to 8*l.* per pound, but now the equivalent in artificial madder-dye, or alizarine, of one pound of the root, can be obtained for one-halfpenny.

With the discovery of artificial alizarine the truly scientific era of the coal-tar industry may be said to have commenced, most of the commercially valuable dye-products, obtained since that time, being the result of truly theoretical research by the logical pursuit of definite well-understood reactions. The wealth of discovery in this direction made during the last thirteen years is a most tempting subject to pursue; but I must content myself with mentioning that one of the results was the production of very permanent and brilliant scarlet and red dyes, the manufacture of which has greatly reduced the market value of cochineal; that the careful study of the original coal-tar colours led to their production in a state of great purity by new and beautifully simple scientific methods; and that even the well-known vegetable colouring-matter, *indigo*, one of the staple products of India, now ranks among the colours synthetically obtained by the systematic pursuit of scientific research, from compounds which trace their origin to coal-tar.

The rapid development of the industry has also not failed to exercise a very important beneficial influence upon other chemical manufactures; thus, the distillation of tar, which was a comparatively very crude process, when, at the period of the first Exhibition, benzene, naphtha, dead-oil, and pitch were the only products furnished by it, has become a really scientific operation, involving the employment of comparatively complicated but beautiful distilling apparatus for the separation of the numerous products which serve as raw materials for the many distinct families of dyes. Very strong sulphuric acid became an essential chemical agent to the alizarine manufacturer, and, as a consequence, the so-called anhydrous sulphuric acid, the remarkable crystalline body which was for many years prepared only in small quantities from green vitriol, is now made at a low price upon a very large scale by a beautifully simple process worked out in England. The alkali- and kindred chemical trades have been very greatly benefited by the large consumption of caustic soda, of chlorate of potash, and other materials used in the dye manufactures, and the application of constructive talent, combined with chemical knowledge, to the production of efficient apparatus for carrying out on a stupendous scale the scientific operations developed in the investigator's laboratory, has greatly contributed to the creation of a distinct profession, that of the chemical engineer.

One of the most beneficial results of the rapid development of the coal-tar colour industry has been its influence upon the ancient art of dyeing, which made but very slow advance until the provision of the host of brilliant, readily-applicable colours completely revolutionised both it and the art of calico-printing.

I venture to think that it will be interesting at this point to quote some words of prophecy included in Prof. Hofmann's important "Report on the Chemical Section of the Exhibition of 1862," and to inquire to what extent they have been verified. In commenting upon one of the features of greatest novelty in that world's show, the exhibition of the first dye-products derived from coal-tar, he says:—

"If coal be destined sooner or later to supersede, as the primary source of colour, all the costly dye woods hitherto consumed in the ornamentation of textile fabrics; if this singular chemical revolution, so far from being at all remote, is at the moment in the very act and process of gradual accomplishment, are we not on the eve of profound modifications in the commercial relations between the great colour-consuming and colour-producing regions of the globe? There is fair reason to believe it probable that, before the period of another decennial Exhibition shall arrive, England will have learnt to depend, for the materials of the colours she so largely employs, mainly, if not wholly, on her own fossil stores. Indeed, to the chemical mind it cannot be doubtful that in the coal beneath her feet lie waiting to be drawn forth, even as the statue lies waiting in the quarry, the fossil equivalents of the long series of costly dye materials for which she has hitherto remained the tributary of foreign climes. Instead of disbursing her annual millions for these substances, England will, beyond question, at no distant day become herself the greatest colour-producing country in the world; nay, by the strangest of revolutions, she may ere long send her coal-derived blues to indigo-growing India, her tar distilled crimson to cochineal-producing Mexico, and her fossil substitutes for quercitron and safflower to China, Japan, and the other countries whence these articles are now derived."

So far as concerns the displacement of madder, cochineal, quercitron, safflower, and other natural dye-materials from the positions of command in the markets of England and the world Hofmann's predictions have been amply fulfilled, and it appears in the earlier days of the coal-tar colour industry as though it would be an equally true prophet in regard to England becoming herself the greatest colour-producing country in the world. But although Germany did little in the very early days of this industry, beyond producing a few of the known colours in somewhat impure condition, many years did not elapse ere she not only was our equal in regard to quality of the dyes produced, but, moreover, had outstripped us in the quantities manufactured and in the additions made to the varieties of valuable dyes sent into the market. So far back as 1878 the value of the make of colours in England was less than one-fourth that of Germany, and even Switzerland, which, competing with other countries industrially, is at great natural disadvantages, was not far behind us, ranking equal to France as producers. The superior position of Germany in reference to this industry may be in a measure ascribable to some defect in the operation of our Patent Laws and to questions of wage and conditions of labour; but the chief cause is to be found in the thorough realisation, by the German manufacturer, of his dependence for success and continual progress upon the active prosecution of scientific research, in the high training received by the chemists attached to the manufactories, and in the intimate association, in every direction, of systematic scientific investigation with technical work.

The young chemists whom the German manufacturer attracted to his works rank much higher than ours in the general scientific training which is essential to the successful cultivation of the habit of theoretical and experimental research, and in the consequent power of pursuing original investigations of a high order. Moreover, the research laboratory constitutes an integral part of the German factory, and the results of the work carried on in and under the eminent professors at the universities and technical colleges are closely followed and studied in their possible bearings upon the further development of the industry.

The importance attached to high and well-organised technical education in Germany is demonstrated not only by the munificent way in which the scientific branches of the universities and technical colleges are established and maintained, but also by the continuity which exists between the different grades of education; a continuity, the lack of which in England was recently indicated by Prof. Huxley with great force.

The important part taken by the German universities in the training of young men for technical pursuits has often been dwelt upon as constituting a striking feature of contrast to our university systems. The national appreciation of the opportunities the

presented for scientific training is demonstrated by the large number of students which are always working in the university laboratories, while the expenditure of 30,000*l.* upon the physical laboratory, and 35,000*l.* upon the chemical department, of the New University of Strasburg, serves to illustrate the unsparing hand with which the resources of the country are devoted to the provision of those educational facilities which are the very life-spring of the industrial progress whence those resources are derived.

In France, higher education had been allowed to sink to a low ebb after the provincial universities had been destroyed in the great Revolution, and the University of Paris had been constituted by the first Napoleon the sole seat of high education in the country. Before the late war, matters educational were in a condition very detrimental to the position of the country among nations. There was no lack of educational establishments, but the systems and sequence of instruction lacked organisation, but since the war, France has made great efforts to replace her educational resources upon a proper footing. The provincial colleges have been re-established at a cost of 3,280,000*l.*, and the organisation of industrial education has now been greatly developed, though still not on a footing of equality with that of Germany. Every large manufacturing centre has its educational establishment where technical instruction is provided, with special reference to local requirements; and, in order to render these colleges accessible to the best talent of France, more than 500 scholarships have been founded, at an annual cost of 30,000*l.* The Ecole Centrale des Arts et Manufactures, of Paris, still maintains the reputation as the great technical university of the country which it earned many years ago, and receives students from the provincial colleges, where they have passed through the essential training preliminary to the high technical education which that great institution provides.

Switzerland has often been quoted as a remarkable illustration of the benefits secured to a nation by the thoroughly organised education of its people. Far removed from the ocean, girt by mountains, poor in the mineral resources of industry, she yet has taken one of the highest positions among essentially industrial nations, and has gained victories over countries rich in the possession of the greatest natural advantages. Importing cotton from the United States, she has sent it back in manufactured forms, so as to undersell the products of the American mills. The trade of watch-making, once most important in this metropolis, passed almost entirely to Switzerland years ago; the old-established ribbon trade of Coventry has had practically to succumb before the skilled competition of Switzerland; and although she has no coal of her own, Switzerland is at least as successful as France in her appropriation of the coal-tar colour industry and her rivalry in rate of production with England, the place of its birth and development. Comparative cheapness of labour will not go very far to account for these great successes; they undoubtedly spring mainly from the thoroughly organised education of scientific with practical education of which the entire people enjoys the inestimable benefit.

Holland furnishes another brilliant example of the success with which a nation brings the power of systematic technical education to bear in securing and maintaining industrial victories in the face of most formidable disadvantages, while the United States of America, so rich in natural resources, have long since realised the immensity of additional advantages to be gained over European nations in the war of industry by a wide diffusion and thorough organisation of technical education. So long as forty years ago the States already possessed several excellent educational institutions established upon the basis of the Continental polytechnic schools, but it was not until about fifteen years later that the country became thoroughly impressed with the great advances achieved by Germany in technical education, and that the subject was made a thoroughly national one. It is now just upon a quarter of a century ago since Congress ordained that each State should provide at least one college, having for its leading objects the diffusion of scientific instruction in its relations to the industry of the country, and decreed that public lands should be granted to the States and Territories providing such colleges. The combined effect of this State action, and of great private munificence, was a remarkably rapid development of scientific and technical education throughout the country; besides some fifty colleges, with eight or nine thousand students, which sprang out of the Land Grant Act for Industrial Education, there are now in the States about 400 other universities and colleges, in a large proportion of which efficient

instruction in applied science is provided. To the useful work accomplished within a few years by these and many other highly important educational institutions, which have placed the acquisition of scientific knowledge within the reach of the very humblest, the enormous strides made by the United States in the development of home industries must unquestionably be in the main ascribed.

(To be continued.)

UNIVERSITY AND EDUCATIONAL INTELLIGENCE

OXFORD.—There are only a few alterations and additions to the usual scientific lecture-list to report, as most of the courses are in continuation of those given last term. Prof. Sylvester is to lecture on the theory of numbers; in the Chemical Department, Mr. Wyndham Dunstan lectures on organic chemistry in relation to medicine and physiology; Prof. Prestwich is to have his usual summer geological excursions; Dr. Tylor continues his exposition of the development of arts, as illustrated in the Pitt-Rivers Museum.

The Sibthorpean Professorship of Rural Economy has been filled up by the re-election of Dr. Gilbert. The Radcliffe Travelling Fellowship has been awarded to Mr. W. Overend, B.A., of Balliol. The statutes of the University Commissioners, which limited the competition for most college scholarships to candidates under nineteen, seem to be having an unfortunate, though not unexpected, effect, as several colleges have lately found it impossible to award scientific scholarships, owing to the want of sufficiently qualified candidates.

There is a good deal of strong feeling in the University with regard to the approaching appointment of a Reader in Geography, and the action of the Delegates of the University Fund in transferring a Readership from History to Geography, just after the offer of the Royal Geographical Society for a similar purpose had been refused, is the subject of much unfavourable comment. There is no thought of opposition to the study of geography, even of scientific geography, but history lecturers not unnaturally complain that the only University appointment open to them should be abolished to make a post for a lecturer in another subject.

CAMBRIDGE.—Among the seven courses on chemistry being delivered this term are lectures on gas analysis and on aromatic bodies, by Dr. S. Ruhemann. Prof. Dewar and Dr. Ruhemann also superintend laboratory practice specially directed to research.

The course given by Mr. Lyon, the Superintendent of the Mechanical Workshops, this term is on machine construction.

Mr. Langley is giving a special course on the central nervous system, with demonstrations and practical work.

Prof. Macalister's lectures this term are on the history of human anatomy. It is to be hoped that he will publish them.

Mr. M. A. Fenton is lecturing on elementary comparative osteology: Dr. Gadlow on the morphology of Mammalia, recent and extinct, and on the palaeontology of the Vertebrata.

Dr. Vines has a course of advanced embryology of plants, and Mr. F. Darwin is giving advanced demonstrations in the physiology of plants.

In geology, Prof. Hughes is taking the geology of the neighbourhood of Cambridge, by lectures and field excursions; Mr. Marr, foreign stratigraphy; and Mr. Roberts, the Trilobites.

Prof. Roy has classes for general pathology, morbid anatomy, and practical morbid histology, bacteriology, &c.

The lectures mentioned above are only a selection of the more interesting courses. The lists from which the above are selected announce about seventy-five courses of lectures and practical work.

Candidates for the John Lucas Walker Studentship, the holder of which must devote himself or herself to original research in pathology, should send their applications to Prof. Roy, Trinity College, Cambridge, not later than May 31 next. The Studentship is of the annual value of 250*l.*, and is tenable under certain conditions for three years.

SCIENTIFIC SERIALS

The American Journal of Science, April.—Contributions to meteorology, twenty-second paper, by Elias Loomis. In this communication the author treats of areas of high pressure, their

magnitude and direction of movement, and their relation to areas of low pressure. The latter subject is illustrated with a plate giving the isobars for December 15, 1882, in the northern hemisphere, and it is shown generally that the movement of areas of high pressure depends upon very different causes from that of areas of low pressure, which seem to be endowed with a power of locomotion residing within themselves. Areas of high pressure exhibit no such power, their movement seeming to depend entirely on external forces.—The faults of South-West Virginia, by John J. Stevenson. Here is given a summary of the information communicated by the author in several memoirs read before the American Philosophical Society (1880-84) on a reconnaissance made by him of the faulted region in Virginia from the Tennessee line to nearly twenty miles beyond New River, a total distance of 150 miles.—On Taconic rocks and stratigraphy, with a geological map of the Taconic regions, part 2, by James D. Dana. The general facts are here detailed which bear on the geographical distribution of the limestone and other rocks. A description is given of Williamstown, regarded as the birthplace of the Taconic system, and it is shown generally that the great quartzite formation, forming the foundation of the Palaeozoic of the region, derived its material from Archaean formations of the vicinity and not from the fabled "Atlantis" as some geologists have supposed.—Irish esker drift, by G. H. Kinahan. It is pointed out that, in common with some other observers, Prof. Carvill Lewis confounds true esker drift and ridges of esker-like drift. His statement in the December number of the *American Journal of Science* that the Irish eskers appear to be adjuncts of the melting of the ice-sheets is shown to be impossible.—Physical characteristics of the northern and north-western lakes, by L. V. Schermerhorn. The results are given of the lately completed surveys made by the United States of all the great lakes draining through the St. Lawrence to the Atlantic. The total water-area is 95,275, and the total area of the lacustrine basin over 270,000, square miles. The length of shore-line with connecting rivers is about 5400 miles, the extreme depth of Superior 1008 feet, or over 406 below sea-level, the mean annual rainfall of the whole basin 31 inches, the volume of water in the lakes about 6000 cubic miles, and the discharge of Ontario at St. Lawrence River 300,000 cubic feet per second.—Mineralogical notes from the laboratory of Hamilton College, by Albert H. Chester. Specimens are described and analysed of fuchsite, pink celestite, zinkenite, brochantite, pectolite, crystals of barite, scorodite, and bismuthite.—The topography and geology of the Cross Timbers and surrounding regions in Northern Texas, by Robert T. Hill. This wooded zone penetrating in two belts from Indian territory through the surrounding prairie southwards to 32° N. lat., is explained by the detritus of arenaceous strata which occupy well-defined horizons in the geological series, and which have been exposed by the denudation of the overlying strata.—American Jurassic mammals, by Prof. O. C. Marsh. In this paper are described the remains of several hundred individual, which have come to light since the appearance of the author's previous papers on the subject. Although fragmentary, the remains are usually well preserved, comprising the lower jaws, teeth *in situ*, various portions of the skull, vertebrae, and other parts of the skeleton. Placental as well as marsupial mammals occur in the oldest formations, whence the inference that the former do not derive from the latter evolutionally, as is supposed, but that both of these orders descend in independent lines from a common ancestor.

SOCIETIES AND ACADEMIES

LONDON

Royal Society, March 24.—"On the Magnetisation of Iron in Strong Fields." By Prof. J. A. Ewing, University College, Dundee, and William Low.

The behaviour of iron and steel when subjected to very strong magnetising forces is a matter of considerable practical and very great theoretical interest, especially from its bearing on the molecular theory of magnetisation, which assigns an upper limit to the intensity of magnetism that a piece of iron can acquire, and even suggests that the metal may become diamagnetic under the influence of a sufficiently great force. All experiments hitherto made, by magnetising iron in the field of an electric solenoid, have shown that the intensity of magnetism, \mathfrak{M} , as well as the induction, \mathfrak{B} , is increasing with the highest values

actually given to the magnetising force, \mathfrak{H} . It is scarcely practicable, however, to produce by the direct action of a magnetising solenoid, a field whose force exceeds a few hundreds of C. G. S. units.

In the space between the pole-pieces of a strong electro-magnet we have a field of force of much greater intensity than it is practicable to produce by the direct action of the electric current. This field is not well adapted for experiments whose object is to determine with precision the relation of magnetisation to magnetising force, on account of the distortion which it undergoes when the piece of iron to be magnetised is introduced into it. It is, however, well suited for experiments whose object is to determine how much magnetism the metal can be forced to take up.

In the authors' experiments, bobbins of Lowmoor and Swedish wrought-iron and cast-iron were magnetised by placing them between the pole-pieces of a large electro-magnet. The bobbins consisted of a short narrow central neck with conical ends. The magnetic induction in the neck was measured ballistically by means of an induction coil, consisting of a single layer of fine wire, wound on the neck; and the magnetic field in the air-space immediately contiguous to the neck was also measured by means of a second induction coil wound over the first, and of slightly greater diameter. This enabled the non-ferrous space under the inner induction coil to be corrected for, and also gave an approximation to the value of \mathfrak{H} , the magnetic force acting on the metal. The magnetic force varied up to about 11,000 C. G. S. units, and the highest induction observed (in a sample of Lowmoor wrought-iron) was 32,880 C. G. S. units. In some instances the magnetic induction was observed by withdrawing the bobbin; in others the bobbin was turned round suddenly so that its magnetism was reversed. The following results refer to Lowmoor wrought-iron and to cast-iron.

Lowmoor wrought-iron

Field round iron neck per sq. cm.	Magnetic induction in the metal	Current in field magnets, amperes	\mathfrak{B} -outside field	\mathfrak{H} outside field
			4*	
3,630	24,700	1.98	1680	6.80
6,680	27,610	4.04	1670	4.13
7,800	28,870	5.81	1680	3.70
8,810	29,350	7.60	1630	3.33
9,500	30,200	11.0	1650	3.18
9,780	30,680	13.5	1660	3.14
10,360	30,830	16.2	1630	2.98
10,840	31,370	21.6	1630	2.89
11,180	31,560	26.8	1620	2.82

Cast-iron

Field round iron neck per sq. cm.	Magnetic induction in the metal	Current in field magnets, amperes	\mathfrak{B} -outside field	\mathfrak{H} outside field
			4*	
3,900	19,660	1.97	1250	5.04
6,400	21,930	3.75	1240	3.42
7,710	22,830	5.38	1200	2.96
8,080	23,520	7.08	1230	2.91
9,210	24,580	13.15	1220	2.67
9,700	24,900	16.9	1210	2.57
10,610	25,600	22.6	1190	2.46

The magnetic force within the metal (\mathfrak{H}) differs from the field in the surrounding space by an amount which cannot be estimated without a knowledge of the distribution of free magnetism on the pole-pieces and conical faces of the bobbin. It appears probable that, with the dimensions of the various parts used in these experiments, the magnetic force within the metal is less, but not very greatly less, than the outside and closely neighbouring field. In the absence of any exact knowledge of \mathfrak{H} , it is interesting to examine the relation of \mathfrak{B} to the outside field. Thus, $(\mathfrak{B}-\text{outside field})/4^*$ gives a quantity which is probably not much less than the intensity of magnetism \mathfrak{M} . The values of this quantity and also of the ratio $\mathfrak{B}/\text{outside field}$ for Lowmoor wrought-iron and cast-iron are stated in the tables above.

Curves are given showing the relation of \mathfrak{B} to $\mathfrak{H}/\text{outside field}$ for Lowmoor iron and for cast-iron, in the manner introduced by Rowland for showing the relation of \mathfrak{B} to μ (the permeability). The curves have the same kind of inflection that a curve of μ and \mathfrak{B} begins to have when the magnetising force is raised sufficiently high. The range through which the permeability of iron may vary is well shown by comparing the value

ached here (probably in the extreme case less than 3), with a value 20,000, which was found by one of the authors in the case of a soft wire exposed to a very small magnetising force and kept at the same time in a state of mechanical vibration. The experiments give no support to the suggestion that there is a maximum of the induction, &c. The value of $\frac{1}{3}$ capable of being reached by the method here employed depends mainly on the scale of the experiments. Larger field magnets with iron-pieces tapering to a narrow neck should yield values of $\frac{1}{3}$ nearly in excess even of those that were observed.

Linnean Society, April 7.—Mr. William Carruthers, F.R.S., resident, in the chair.—Mr. Hunter J. Barron, Mr. Jas. H. Ugdale, and Mr. Edwd. B. Poulton were elected Fellows of the Society.—Fresh specimens were exhibited of a pure white variety of primrose, which had been gathered, growing wild, near Biarritz, France, by Mr. W. D. Godolphin Osborne.—A large series of instantaneous photographs of storks nesting, &c., were exhibited for Mr. E. Bidwell. These had been taken in Germany, and were specially interesting as showing the peculiar attitudes assumed in flight, &c.—Some malformed trout in an early stage of development were shown and commented on by Dr. Day.—A paper was read by Prof. Huxley on "The Gentians; Notes and Queries." Taking the flower as a basis, he divides the Gentianæ into two great series, each of which is characterised by a peculiar disposition of the nectarial organs, and a radiation of forms of the corolla from the deeply cleft rotate or stellate condition, through the campanulate to the extreme subfundulate kind. In one series termed (I.) Perimelitæ, the nectarial cells are aggregated in a single or two patches; in the other series (II.) Mesomelitæ, the distinguishing characters are a zone of secreting cells encircling the ovary, or absence of such, with presence of a honey-secreting surface which may exist in the central parts of the flower. He assumes, on morphological grounds, a hypothetical ancestral flower or Ur-Gentian = Hap-anthe. As a starting-point, this would lead, on the one hand, to the series of Perimelitæ, with four subsidiary types; and on the other to the Mesomelitæ, also with four subsidiary types of floral structure. The Perimelitæ comprise the groups:—1. Actinanthæ, 2. Keratanthæ, 3. Lophanthæ, and 4. Stephananthæ; the Mesomelitæ comprise:—1. Asteranthæ, 2. Limnanthæ, 3. Lissanthæ, and 4. Ptychanthæ. The one series appears to bear a certain progressive relation in its evolution to the leading morphological modifications of the opposite series. In treating of the geographical distribution of the gentians, Prof. Huxley adopts the lines previously followed by him on animal distribution. Under (I.) Arctogea he includes Europe, Africa, Asia, and North America as far as Mexico; South Africa, Madagascar, Hindostan, and Indo-China forming a sub-province = South Arctogea; the remainder = North Arctogea. (II.) Austro-Columbia comprises South America, isthmus and islands as far north as Mexico. (III.) Australia is another province; and (IV.) New Zealand with adjoining islands. Species of the Gentianæ are found in all these provinces, the head-quarters being North Arctogea and Austro-Columbia. The Ptychanthæ are predominant in North Arctogea; the Lissanthæ in South Arctogea; and Actinanthæ, Lophanthæ, and Lissanthæ in Austro-Columbia. In Australia and New Zealand there is a paucity of species. He considers that the present distribution of the Gentianæ is not to be accounted for by migration from any given centre, whence diffusion to their present localities. Borrowing analogy from zoological distribution, he likens the gentians to the tapirs, at present only represented in South America and the Indo-Malayan region. Yet the Tapiridæ in the Middle Tertiary epoch were distributed everywhere in the intermediate areas. Though fossil remains of gentians are not yet known, Prof. Huxley nevertheless suggests that in Pliocene and Miocene times their distribution may have been substantially similar to what is now extant. He further throws out the hint that, could the age of the first appearance of dipterous, hymenopterous, and lepidopterous insects provided with long caustra be indicated, we should then be in a position to guess approximately when specialisation of the types of the gentians and their ultimate distribution occurred.

Geological Society, April 6.—Prof. J. W. Judd, F.R.S., President, in the chair.—The following communications were read:—On the rocks of the Malvern Hills, part 2, by Mr. Frank Rutley. The details of the microscopic examination of the rocks constituted the principal part of the present paper. The author concluded that the rocks of the Malvern Hills

represent part of an old district consisting of plutonic and, possibly, of volcanic rocks associated with tuffs, sedimentary rocks composed mainly or wholly of eruptive materials, and grits and sandstones; that the structural planes in these rocks (sometimes certainly, at others possibly) indicate planes of stratification, and that the foliation, in many cases if not in all, denotes lamination due to deposition either in water or on land surfaces, probably more or less accentuated or altered by the movements which produced the upheavals, subsidences, and flexures prevalent in the range.—On the alleged conversion of crystalline schists into igneous rocks in County Galway, by Dr. C. Callaway.—A preliminary inquiry into the genesis of the crystalline schists of the Malvern Hills, by Dr. C. Callaway. The author's researches amongst the crystalline rocks of Connaught had suggested certain lines of investigation which had subsequently been followed out in the Malvern district. He had satisfied himself that many of the Malvern schists had been formed out of igneous rocks; but at present he limited himself to certain varieties. The materials from which these schists were produced were diorite (several varieties), granite, and felsite. The metamorphism had been brought about by lateral pressure. Evidence of this was seen in the intense contortion of granite-veins and in the effects of crushing as observed under the microscope. The products of the metamorphism were divided into two groups:—(1) Simple schists, or those formed from one kind of rock. (2) Injection schists, formed by the intrusion of veins, which had acquired parallelism by pressure. Veins of diorite in diorite produced *duplex diorite gneiss*, and veins of granite in diorite originated *granite diorite-gneiss*. It was further noted that (1) generally the particular varieties of schist occurred in the vicinity of the igneous masses to which they were most nearly related in mineral composition; (2) the mineral banding of the rocks in the field was more like vein-structure than stratification. The author accepted the received view of the age of the schists. The parallel structure was clearly antecedent to the Cambrian epoch, and the occurrence of similar rocks as fragments in the Uriconian conglomerate of Shropshire seemed to indicate that the Malvernian schists were older Archaean. The reading of this paper was followed by a discussion in which the President, Mr. Teall, Dr. Hicks, Colonel McMahon, Dr. Callaway, and Mr. Rutley took part.

Entomological Society, April 6.—Dr. David Sharp, President, in the chair.—Mr. Francis Galton, F.R.S., Mr. J. H. Leech, B.A., F.L.S., and Mr. G. S. Parkinson were elected Fellows.—Mr. S. Stevens exhibited specimens of *Arctia mendica*, collected in the county of Cork. The peculiarity of the Cork form of the species is that the majority of the males are as white as the female of the English form, and the typical black or English form appears to be unknown in Cork.—Mr. McLachlan exhibited a zinc box used by anglers for the purpose of keeping living flies in, which he thought might be adapted to practical use in the field by entomologists.—Mr. G. T. Porritt exhibited specimens of *Hybernia progemma*, from Huddersfield. All the females and a large proportion of the males were of the dark variety *fusca*, which formerly was almost unknown in Yorkshire, but which now seemed likely to replace the original type. Mr. Jenner-Weir and Lord Walsingham both remarked that the number of melanic forms appeared to be on the increase in the north, and suggested explanations of the probable causes of such increase.—Mr. Gervase F. Mathew, R.N., exhibited several new species of Rhopalocera taken by him in the Solomon Islands during the visits to those islands of H.M.S. *Espergle* in 1882 and 1883. Amongst them were species of *Euplaus*, *Mycalesis*, *Messarus*, *Rhinopalpa*, *Cyristis*, *Diadema*, *Parthenos*, *Pieris*, *Papilio*, &c.—Mr. E. B. Poulton exhibited a large and hairy lepidopterous larva brought from Celebes by Dr. Hickson, and made remarks on the urticating properties of the hairs of the species, which were said by the natives to produce symptoms similar to those of *erysipelas* if the larva was handled. Lord Walsingham, Mr. McLachlan, Dr. F. A. Dixey, Mr. Jenner-Weir, Dr. Sharp, Mr. Slater, and Mr. Poulton, took part in a discussion as to whether urtication was due to the mechanical action of the hairs in the skin, or to the presence of formic acid, or some other irritant poison, in glands at the base of the hairs. There appeared to be no doubt that in some species the irritation caused by handling them was merely due to the mechanical action of the hairs.—Mr. P. Crowley exhibited a collection of Lepidoptera recently received from West Africa, including several new or undescribed species of *Mylothris*, *Diadema*, *Harma*, *Rhombaleo-*

soma, &c.—Mr. H. Goss announced the capture by Mr. G. D. Tait, at Oporto, of a specimen of *Anosia flexippus*, and remarked that, although some twenty specimens had been caught in the South of England, only two specimens had been previously recorded from the continent of Europe.—Lord Walsingham read a paper entitled "A Revision of the Genera *Acrolophus* (Poey) and *Anathora* (Clem.)"; and exhibited about twenty new species of these and allied genera. Mr. Stainton made some remarks on the genera, and said he was glad Lord Walsingham was working at them and their allies.—Mr. Poulton read "Notes in 1886 on Lepidopterous Larvæ." In the discussion which ensued, Lord Walsingham referred at some length to instances of protective resemblance in larvæ, and alluded to the existence in certain species, especially of the genus *Melipotæ*, of prothoracic glands.—Dr. F. A. Dixey remarked on the extraordinary powers of contraction which appeared to be possessed by the retractor muscle of the flagellum in *D. vinula*, and inquired whether any corresponding peculiarities of minute structure had been observed in it. The discussion was continued by Mr. G. F. Mathew, Mr. W. White, Dr. Sharp, Mr. Porritt, and others.

PARIS

Academy of Sciences, April 18.—M. Janssen, President, in the chair.—On an absolute unity of time; electric standards of time and chronoscopes of their variations, by M. Lippmann. It is shown that from the study of certain electric phenomena an absolute invariable unity of time may be obtained. The electric apparatus here described yields more accurate results than the best constructed astronomical clock. It has the further advantage of indicating, recording, and, where needed, automatically correcting, its variations of velocity.—Solar observations made at Rome during the first quarter of the year 1887, by M. Tacchini. The period of minimum activity for the spots and faculæ, as recorded in November 1886, has continued throughout the first three months of 1887. The protuberances also continued to decline during the same period.—On antipyrine, an antidote against pain, by M. Germain Sée. Antipyrine, with the formula $C_{11}H_{12}N_2O$, discovered by Knorr in 1884, is shown to be not only a good febrifuge, but also a most efficacious remedy for gout, rheumatism, and similar affections.—On the earthquake of February 23, by M. J. L. Soret. Certain derangements of the telephonic apparatus in the central office at Cannes seem to show that the violent shock which occurred at 5.50 a.m. was accompanied by strong electric discharges.—On a special circumstance connected with the production of the bicarbonate of soda, by M. Paul de Mondésir. An experiment here described shows that the carbonate of soda, combined with a single equivalent of water, scarcely absorbs carbonic acid at the ordinary temperature at all. But when it is mixed with a slight portion of dry bicarbonate the reaction on the contrary begins at once, and with an energy in direct proportion to the quantity of the bicarbonate and the thoroughness of the mixture.—Method of determining the relative value of the four unities of chemical action of the atom of carbon, by M. Louis Henry. At the base of the doctrines of organic chemistry as now understood lie the two principles of the quadrivalence of the atom of carbon, and the identity in value of its four unities of chemical action. The former is an accepted fact proved by experiment, while the latter is far from possessing the same degree of objective certainty. The author here proposes a method by means of which its truth may be rigorously determined.—Artificial reproduction of rose-red spinel (balas ruby), by M. Stanislas Meunier. The author, who has been for several years incidentally occupied with the synthesis of spinel, has lately again attacked the problem in a way quite different from his first method. He now crystallises the aluminate of magnesia, tinted a rose colour by traces of chromium, the result being a stone absolutely identical with the balas ruby of nature. The experiment here described has already been varied in several ways, yielding a series of products, such as the aluminates of zinc, iron, &c., besides secondary compounds, whose study is still in progress.—On the functions of the semicircular ducts, by M. J. Steiner. From experiments made on Crustaceans at the Zoological Station at Naples, the author shows that these organs exercise little or no influence on the locomotion of the lower animals, as supposed by Delage, Viguier, and others.—On a station of the Stone Age discovered at Chaville, by M. E. Emile Rivière. This station of Chaville lies on the skirt of the wood of like name on the right side of the road between Paris and Versailles. Here the author has just

discovered a large number of flint implements of the Neolithic epoch, scrapers, knives, arrow-heads, and the like. All lay on or near the surface, and were of a more or less deep grey colour some showing clear traces of the action of fire. They closely resemble the objects found by the author at the Neolithic station of Trou-au-Loup, Clamart, in 1884-85. Amongst them was a small fragment of black, siliceous pottery without any ornamentation, and also perfectly analogous to the pottery of the Neolithic beds in the same neighbourhood.—The members of the International Conference on Celestial Photography were present at the sitting, and were welcomed by the President in an appropriate address dwelling especially on the importance for astronomy of the photographic labours of MM. Henry, of Paris.

BOOKS, PAMPHLETS, and SERIALS RECEIVED

Hyderabad, Kashmir, Sikkim, and Nepal: Sir R. Temple and Capt. R. C. Temple (Allen).—Geology of England and Wales, 2nd edition: H. L. Woodward (Philip).—An Elementary Treatise on the Mathematical Theory of Perfectly Elastic Solids: W. J. Ibbetson (Macmillan).—Dynamics for Beginners: Rev. J. B. Lock (Macmillan).—Catalogue of Lizards, and the United States, 1885 (Washington).—Photography of Bacteria: E. M. Crookshank (Lewis).—Chemistry for Beginners: R. L. Taylor (Low).—Woodland Tales: J. Stinde (Unwin).—Geological and Natural History Survey of Minnesota, 13th and 14th Annual Reports: W. H. Woodworth (St. Paul).—Lammann's New Geographical Readers, Standard VII. (Longmans).—The Prevention of Consumption: C. Candler (K. Paul).—Pictographs of the North American Indians: G. Mallory (Washington).—De Bau des Menschen: Dr. R. Wiedersheim (Williams and Norgate).—Thomas Young, Prof. Tyndall.—Oberfläch-Flora aus den Baugruben des Klirbackens bei Niederrad und der Schleiße bei Höchst A. M.: Drs Geyler and Kinkel (Frankfurt).—The Eruption of Krakatö: E. D. Archibald.—City Government of St. Louis: M. S. Snow (Baltimore).—Notes to Accompany a Geological Map of Northern Canada: G. M. Dawson (Montreal).—Étude Numérique des Concours de Compensation de Chronomètres G. Cellérier (Genève).—Journal of the Royal Statistical Society March (Stanford).—Zeitschrift für Wissenschaftliche Zoologie, xiv. Band 2 Heft (Leipzig).—Bulletin de l'Académie Royale des Sciences de Belgique No. 3 (Bruxelles).

CONTENTS

	PAGE
Practical Electricity. (Illustrated)	601
Spolia Atlantica	602
Our Book Shelf:—	
Salomons: "Complete Hand-book on the Manage-	
ment of Accumulators"	603
Newsholme: "School Hygiene"	604
Letters to the Editor:—	
Mass, Weight, and Dynamical Units.—Robt. F.	
Hayward, F.R.S.	604
Units of Weight, Mass, and Force.—Archd. C.	
Elliott	605
Seismometers.—Prof. J. A. Ewing	606
April Meteors.—W. F. Denning	606
Vertical Decrement of Temperature and Pressure.—	
S. A. Hill	606
Royal Society's <i>Sorité</i> .—Herbert Rix	607
Homeric Astronomy, II. By A. M. Clerke	607
On Ice and Brines, I. By J. Y. Buchanan	608
Notes	611
Our Astronomical Column:—	
Barnard's First and Second Comets 1887	614
Probable Re-discovery of Hesperia	614
The Ellipticity of Uranus	614
The Washington Observatory	614
The Paris Conference	614
Astronomical Phenomena for the Week 1887	
May 1-7	614
Geographical Notes	615
Preliminary Note on the Fossil Remains of a	
Chelonian Reptile, <i>Ceratohelys sthenurus</i> , from	
Lord Howe's Island, Australia. By Prof. Thomas	
H. Huxley, F.R.S. (Illustrated)	615
The Work of the Imperial Institute, I. By Sir	
Frederick Abel, C.B., F.R.S.	615
University and Educational Intelligence	615
Scientific Serials	615
Societies and Academies	615
Books, Pamphlets, and Serials Received	615

