

始



0 1 2 3 4 5 6 7 8 9 10 1 2 3 4 5

京都市水道圖譜

- 第一號 取入口附近及淨水地平面圖
- 第二號 京都市內配水管布設圖
- 第三號 京都市內制水瓣及防火栓配置圖
- 第四號 取入口附近及淨水地高低圖
- 第五號 取入口并除砂井構造圖
- 第六號 除砂井上屋圖
- 第七號 沈澱池附屬井構造圖
- 第八號 沈澱池附屬井上家圖
- 第九號 沈澱池構造圖 其一
- 第十號 沈澱池構造圖 其二
- 第十一號 沈澱池構造圖 其三
- 第十二號 沈澱池構造圖 其四
- 第十三號 濾過場平面圖
- 第十四號 濾過場建圖 其一
- 第十五號 濾過場建圖 其二
- 第十六號 濾過場縱橫斷圖
- 第十七號 濾過場特別基礎之圖
- 第十八號 濾過場事務室側基礎詳細圖
- 第十九號 濾過場事務室側詳細圖
- 第二十號 濾過場事務室側階上下天井平面圖
- 第二十一號 濾過場硫酸礬土溶解室床圖

大正
2. 7. 9
內文

第二十二號	濾過場鐵筋壁圖	其一
第二十三號	濾過場鐵骨圖	其二
第二十四號	濾過場鐵骨圖	其三
第二十五號	濾過場鐵骨圖	其四
第二十六號	濾過場鐵骨圖	其五
第二十七號	濾過場鐵骨圖	其六
第二十八號	濾過場鐵骨圖	其一
第二十九號	急速濾過裝置圖	其二
第三十號	急速濾過裝置圖	其三
第三十一號	急速濾過裝置圖	其四
第三十二號	急速濾過裝置圖	其五
第三十三號	急速濾過裝置圖	其六
第三十四號	急速濾過裝置圖	其七
第三十五號	急速濾過裝置圖	
第三十六號	濾過槽構造圖	
第三十七號	濾過槽遣型圖	
第三十八號	導水溝構造圖	
第三十九號	硫酸礬土溶液裝置圖	其一
第四十號	硫酸礬土溶液裝置圖	其二
第四十一號	硫酸礬土溶液裝置圖	其三
第四十二號	硫酸礬土溶液裝置圖	其四
第四十三號	硫酸礬土溶液裝置圖	其五
第四十四號	硫酸礬土溶液裝置圖	其六

第四十五號	淨水集合井圖	
第四十六號	淨水集合井上家圖	
第四十七號	唧筒配置圖	
第四十八號	唧筒詳細圖	其一
第四十九號	唧筒詳細圖	其二
第五十號	唧筒室建圖	
第五十一號	配水池構造圖	(高區)其一
第五十二號	配水池構造圖	(高區)其二
第五十三號	配水池構造圖	(低區)其三
第五十四號	配水池構造圖	(低區)其四
第五十五號	配水池構造圖	其五
第五十六號	配水池構造圖	其六
第五十七號	配水池構造圖	其七
第五十八號	配水池構造圖	其八
第五十九號	配水池構造圖	其九
第六十號	配水池構造圖	其十
第六十一號	配水池構造圖	其十一
第六十二號	配水池周壁基礎拱橋圖	
第六十三號	低區配水池 _{入口} 上家圖	
第六十四號	高區及低區配水池周壁圖	
第六十五號	高區配水池 _{入口} 井上家圖	
第六十六號	計量器配置圖	
第六十七號	計量室地下室構造圖	

- 第六十八號 計量室建圖
- 第六十九號 華頂川暗渠構造圖
- 第七十號 高區配水池東法裾石垣及地下水渠構造圖
- 第七十一號 淨水地東法裾石垣圖
- 第七十二號 疏水廣道鐵管橋圖
- 第七十三號 疏水二條鐵管橋圖
- 第七十四號 新一條鴨川橫斷布設圖
- 第七十五號 二條鴨川橫斷布設圖
- 第七十六號 四條鴨川橫斷布設圖
- 第七十七號 七條鴨川橫斷布設圖
- 第七十八號 制水瓣圖
- 第七十九號 制水瓣圖
- 第八十號 制水瓣圖
- 第八十一號 制水瓣圖
- 第八十二號 制水瓣圖
- 第八十三號 制水瓣圖
- 第八十四號 制水瓣圖
- 第八十五號 防火栓圖
- 第八十六號 排氣瓣圖
- 第八十八號 制水瓣防火栓及排氣瓣蓋圖
- 第八十九號 鐵管寸方圖
- 第九十號 鐵管寸方圖

其一

其二

1

2

第一號

取入口附近及淨水地平面圖

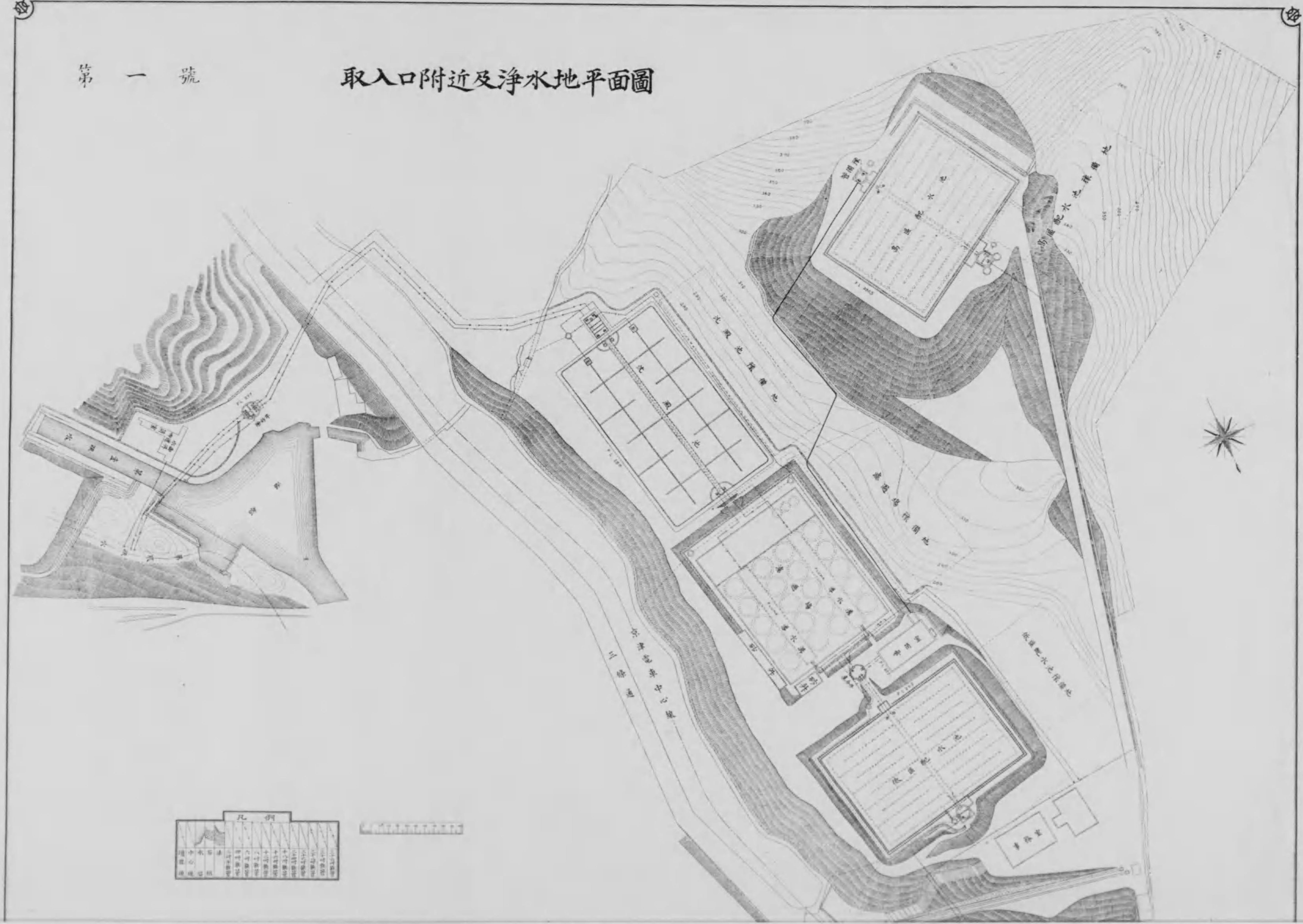

凡例

1	2	3	4	5	6	7	8	9	10	11	12	13	14	15	16	17	18	19	20
...

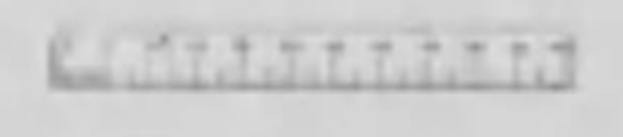

0 1 2 3 4 5 6 7 8 9 10 1 2 3 4 5

京都市内配水管布設圖

第二號

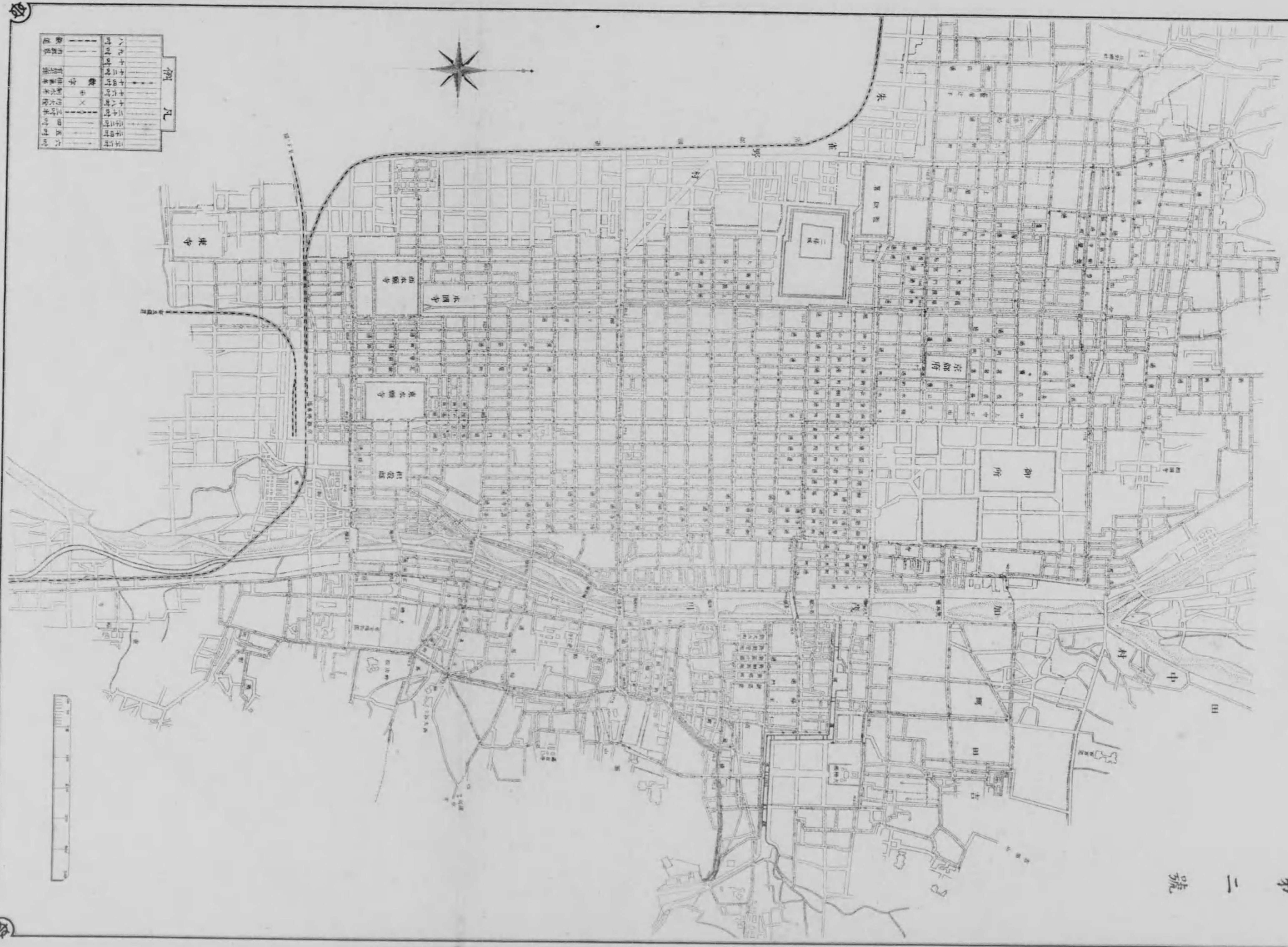

京都市内制水辨及防火栓配置圖

第三號





凡例	
○	公園
●	寺廟
▲	學校
△	官署
▽	市場
◇	車站
□	工廠
◇	碼頭
○	公園
●	寺廟
▲	學校
△	官署
▽	市場
◇	車站
□	工廠
◇	碼頭



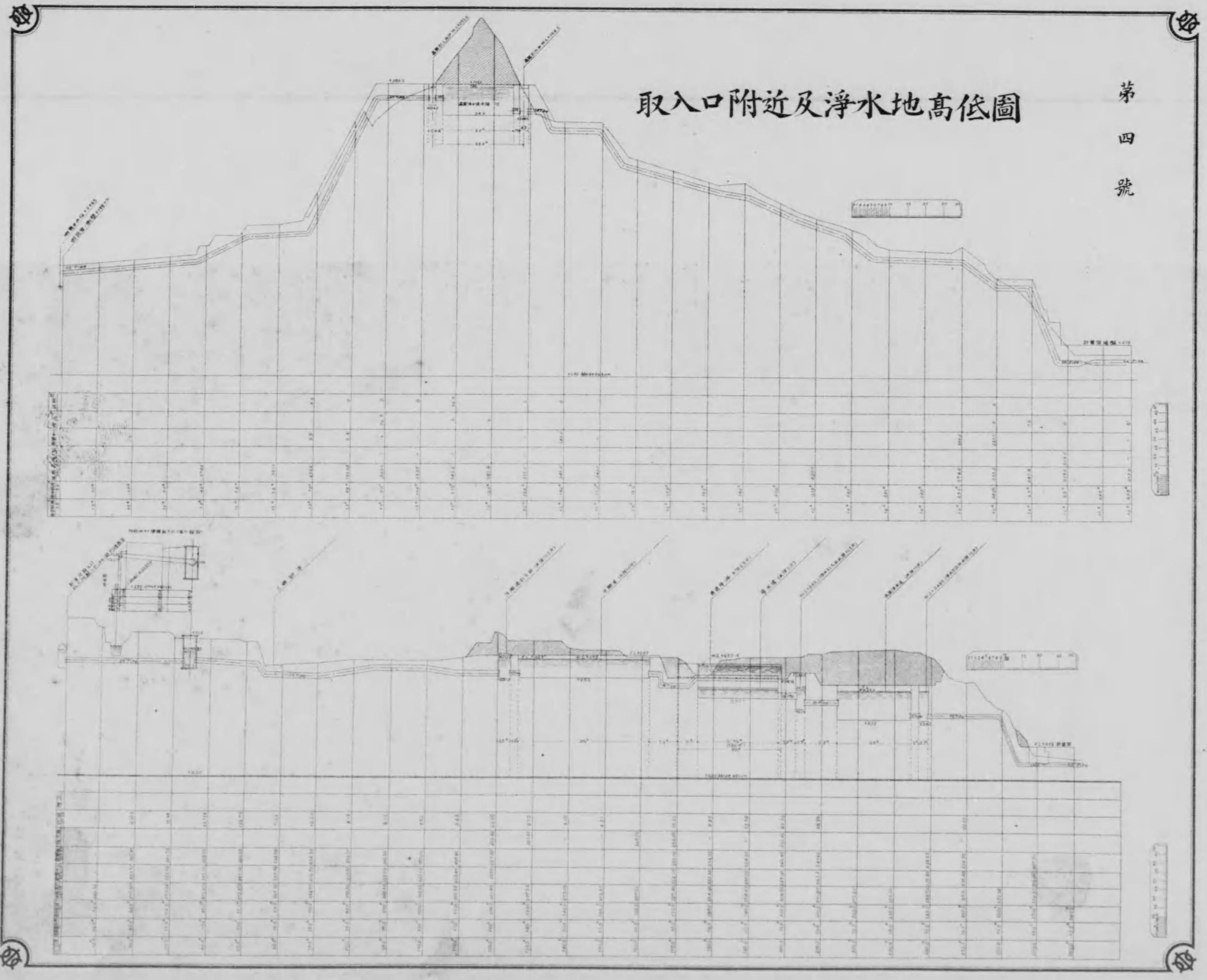

取入口附近及淨水地高低圖

第四號

取入口井除砂井構造圖

第五號

第二疏水取入口圖

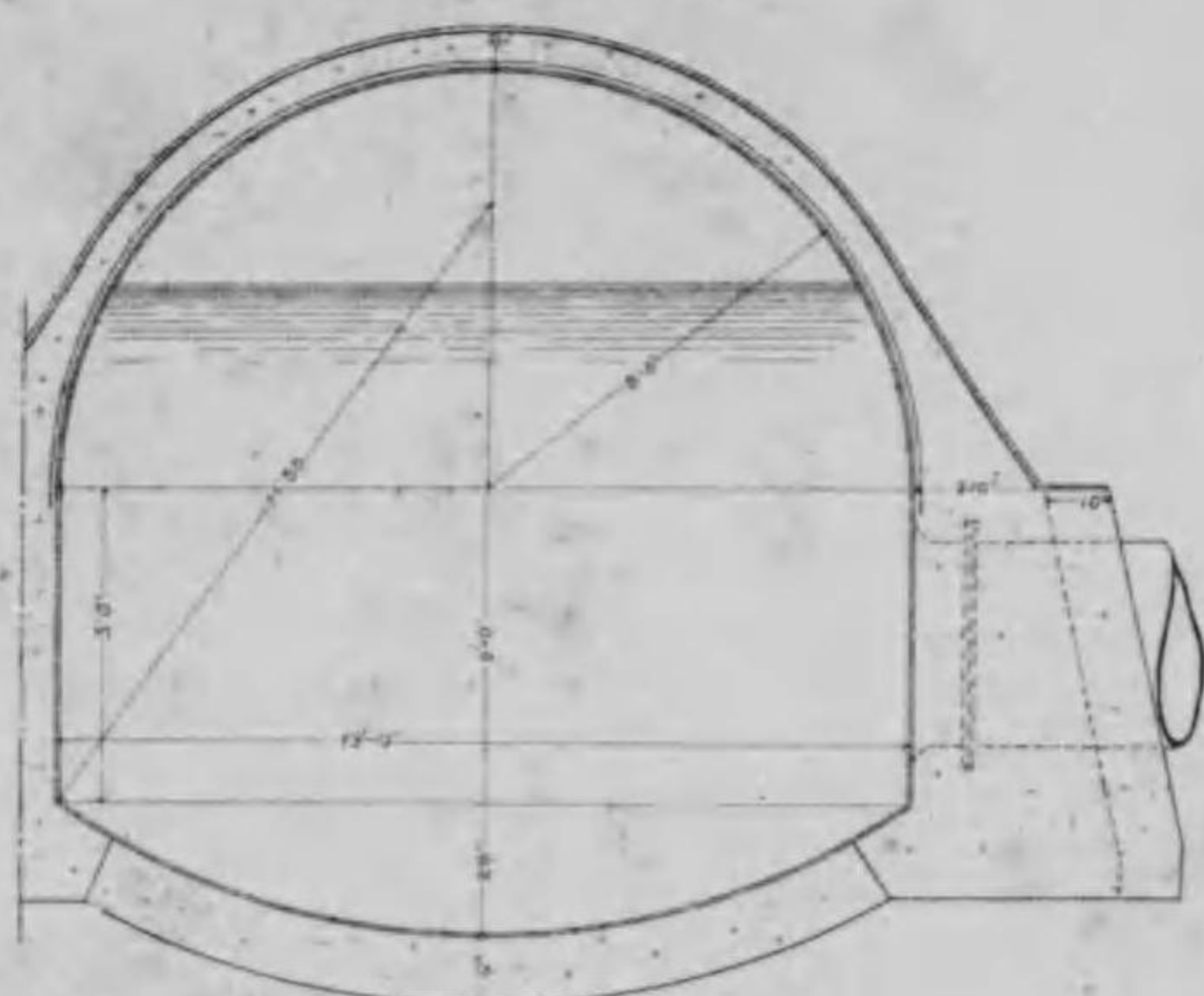

第一疏水運河橫斷圖

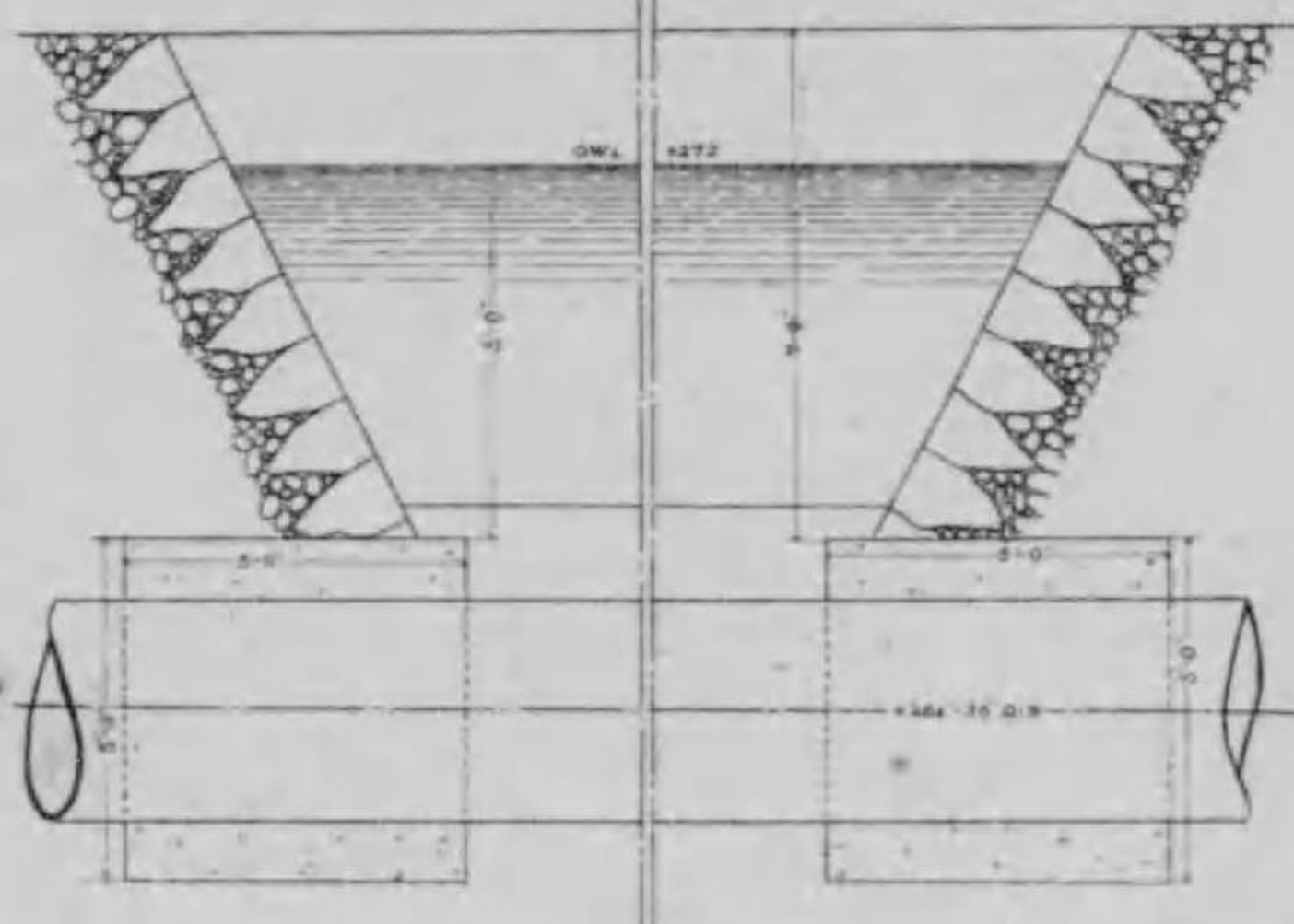

除砂井構造圖

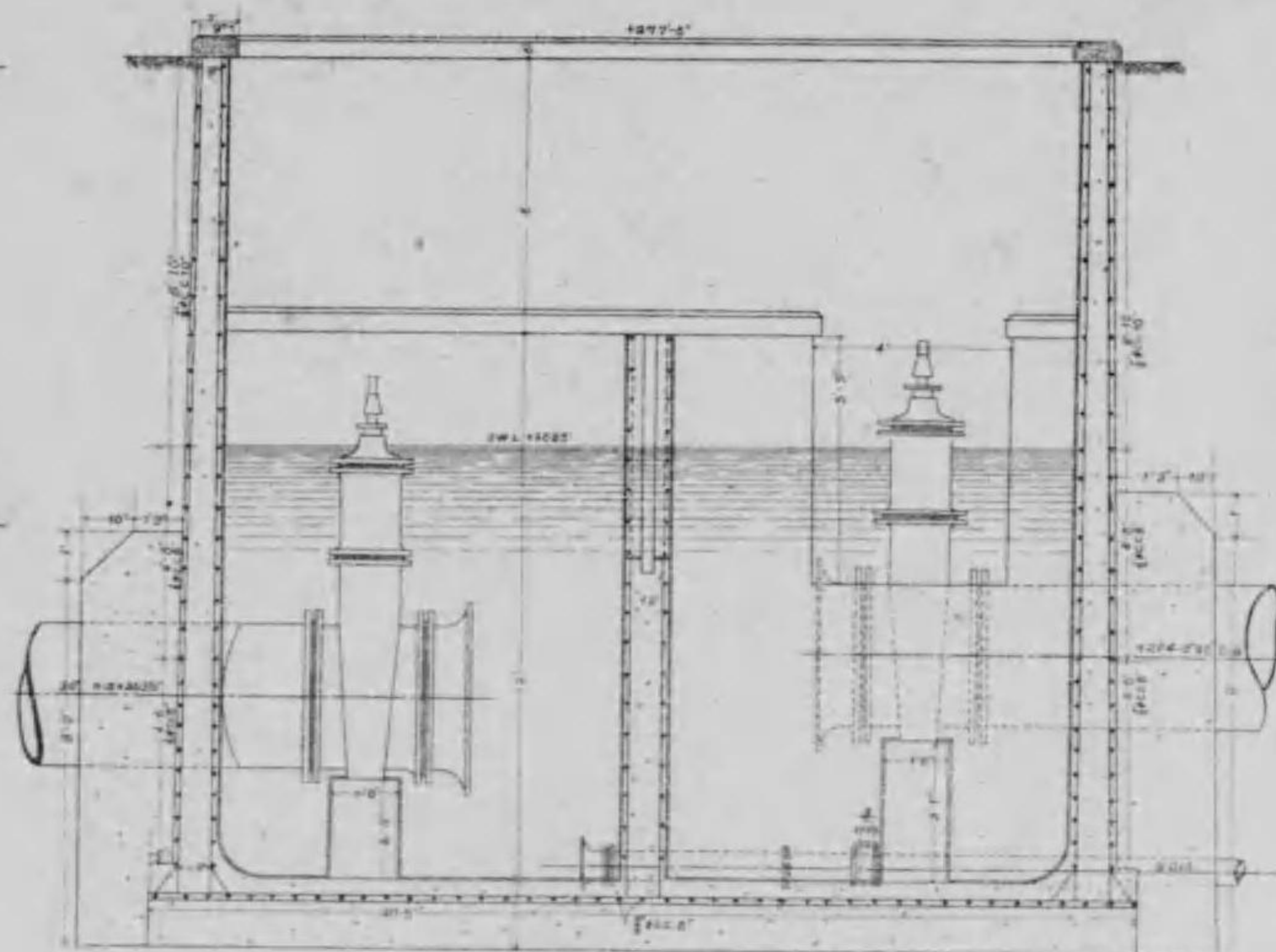

第一疏水預備管取入口圖

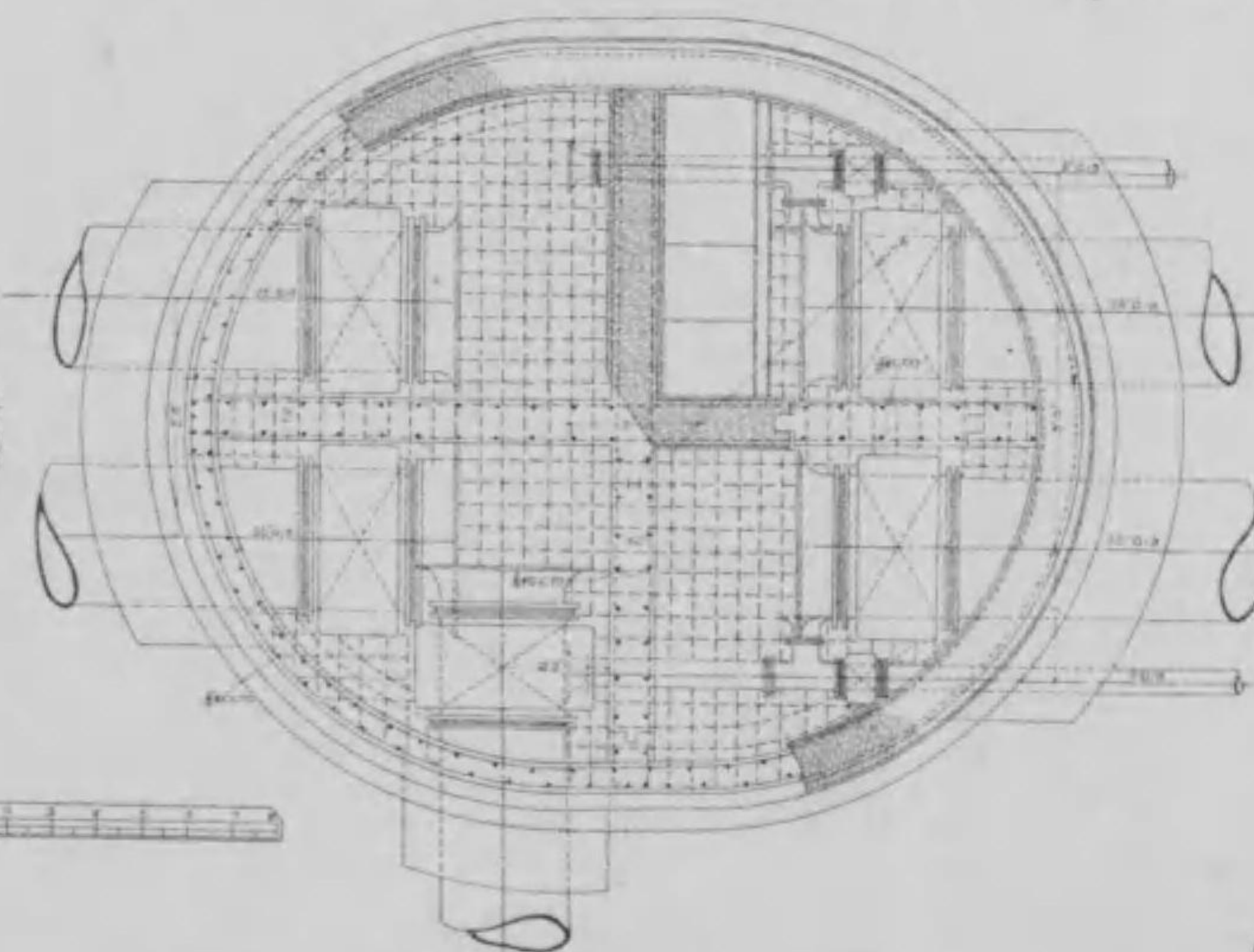
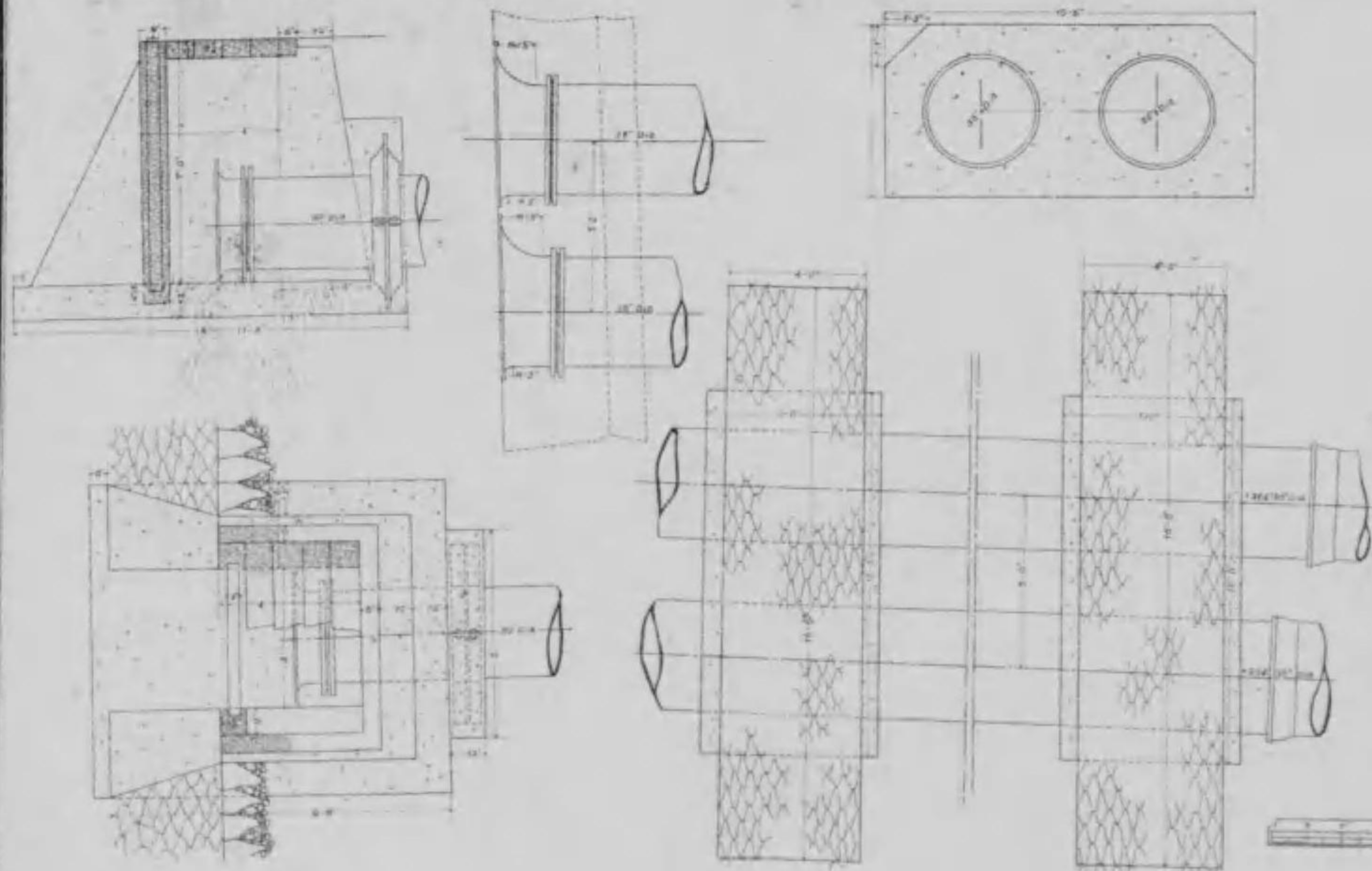

除砂井上屋圖

第六號

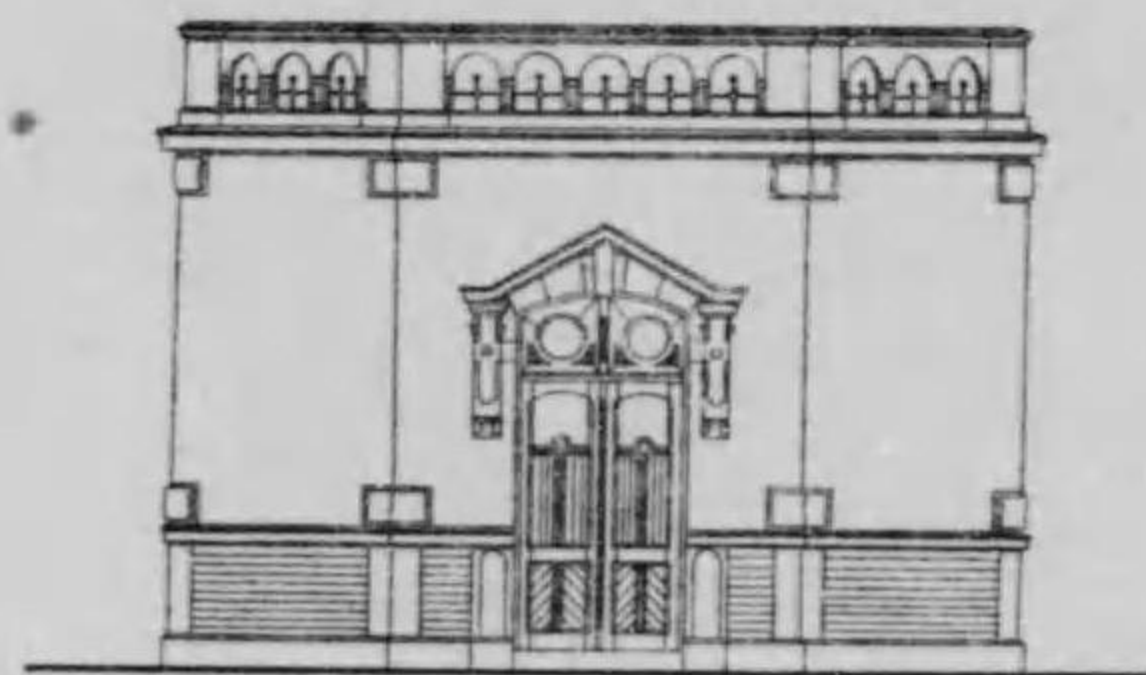

正面圖

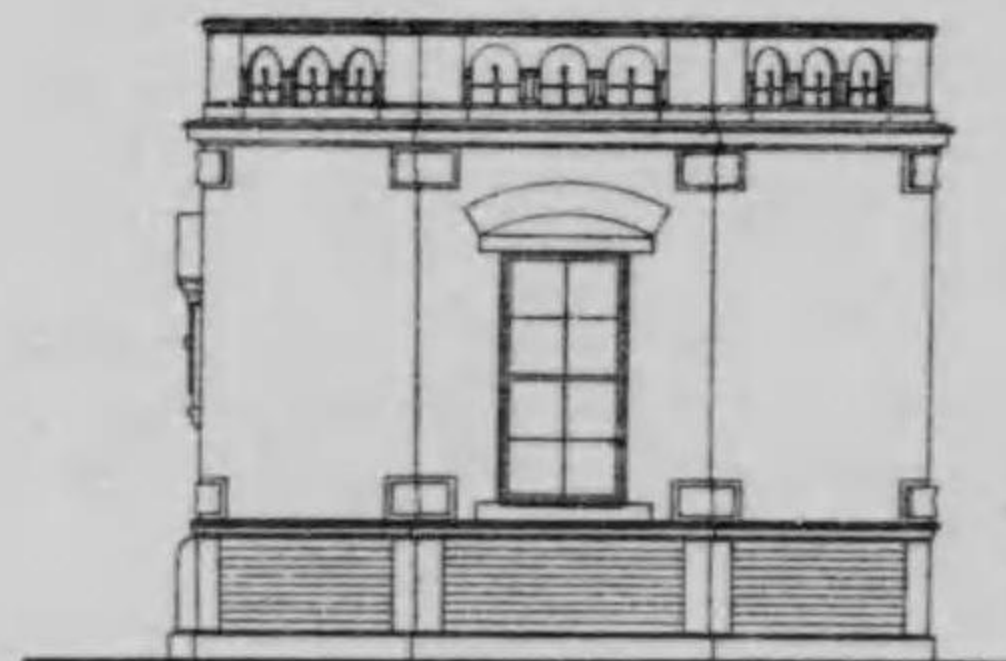

側面圖

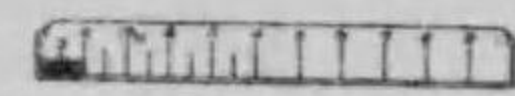

縮尺

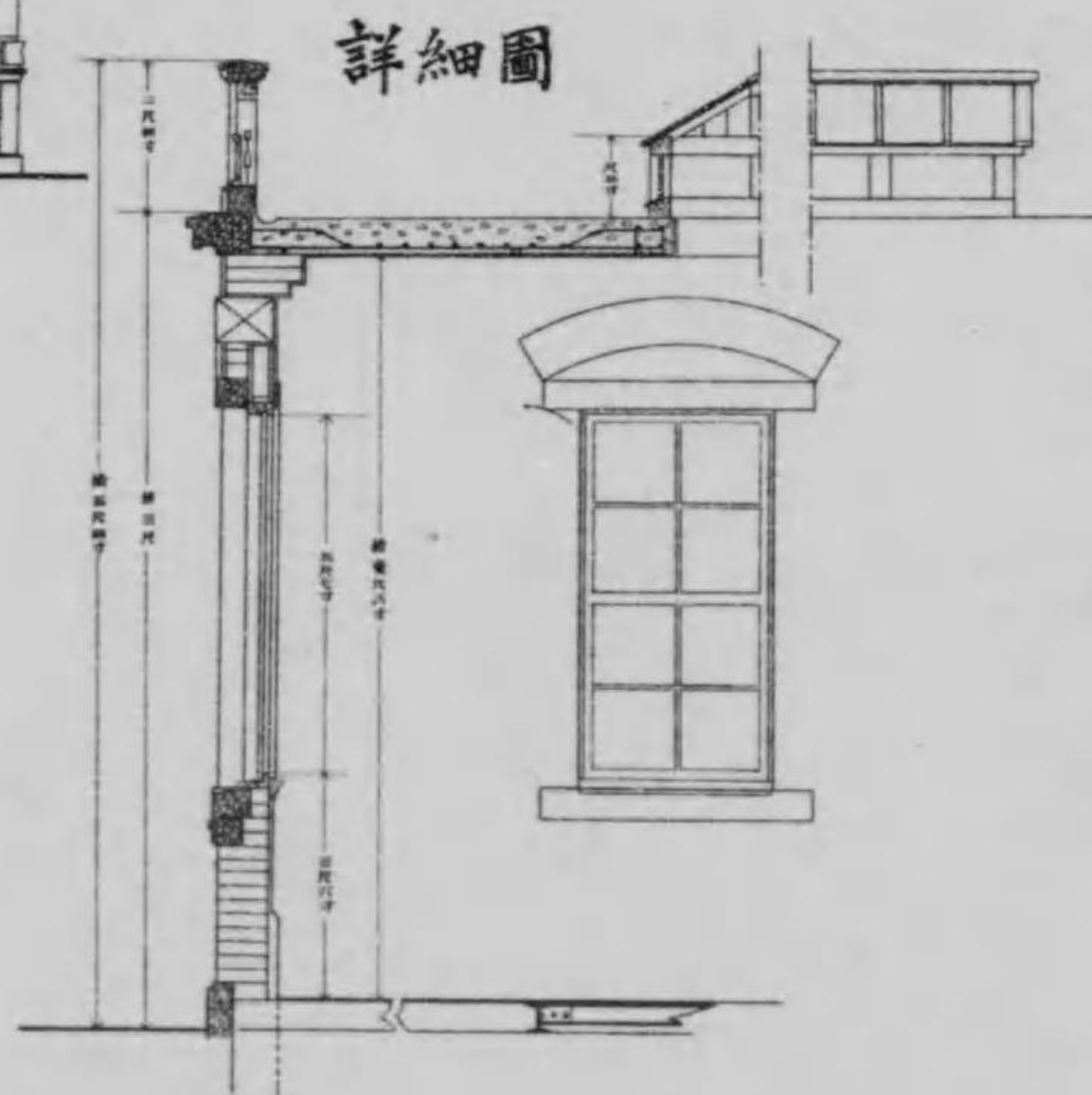

詳細圖

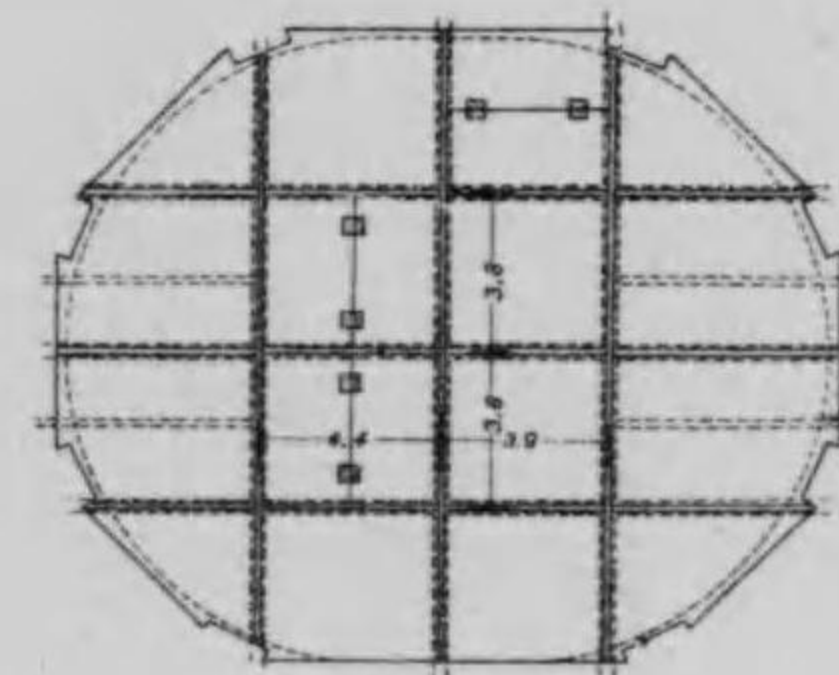

床鉄板平面圖

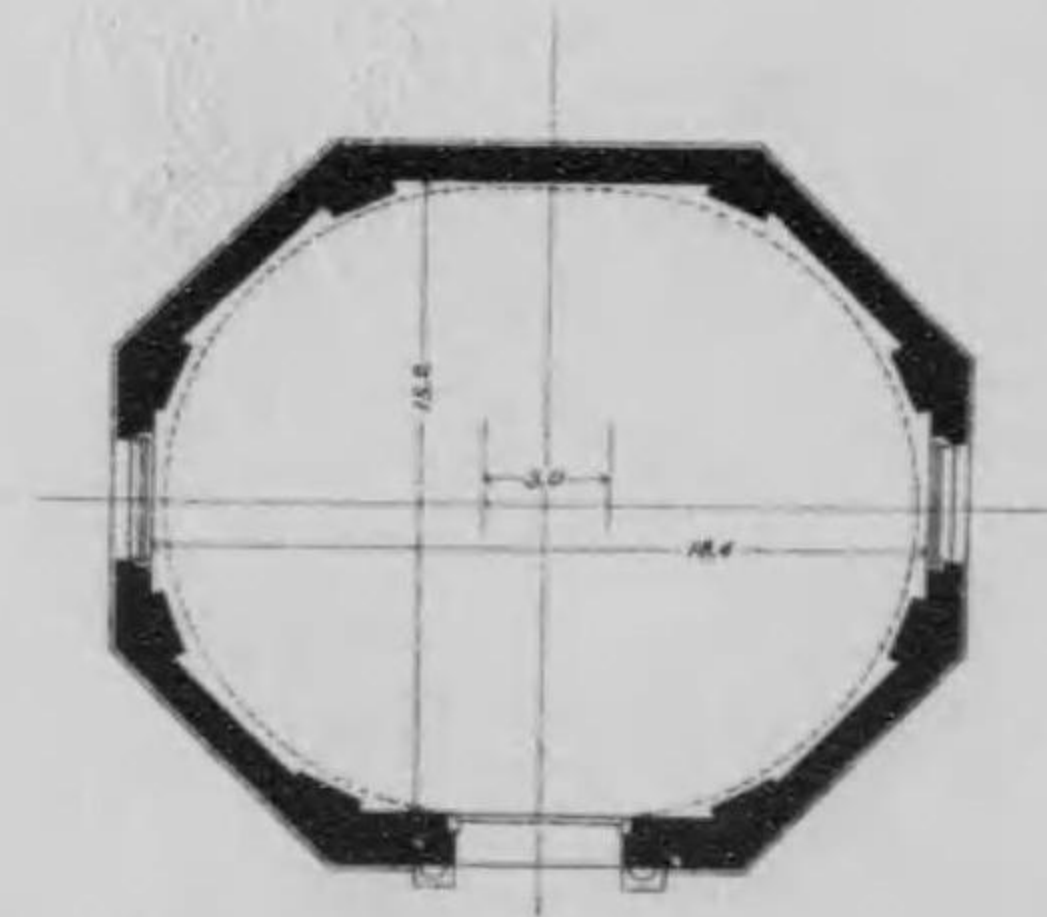

平面圖

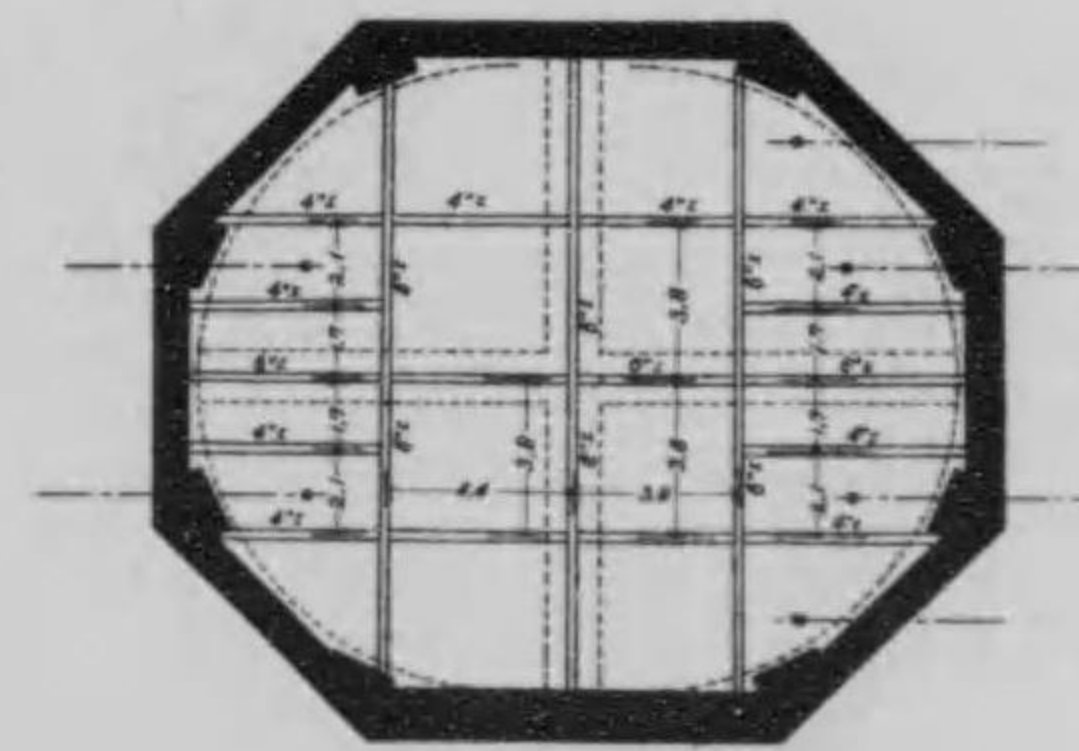

床梁配置圖



詳細圖縮尺

SECTION-A.A 沈澱池附属井構造圖

第七號

SECTION-B.B

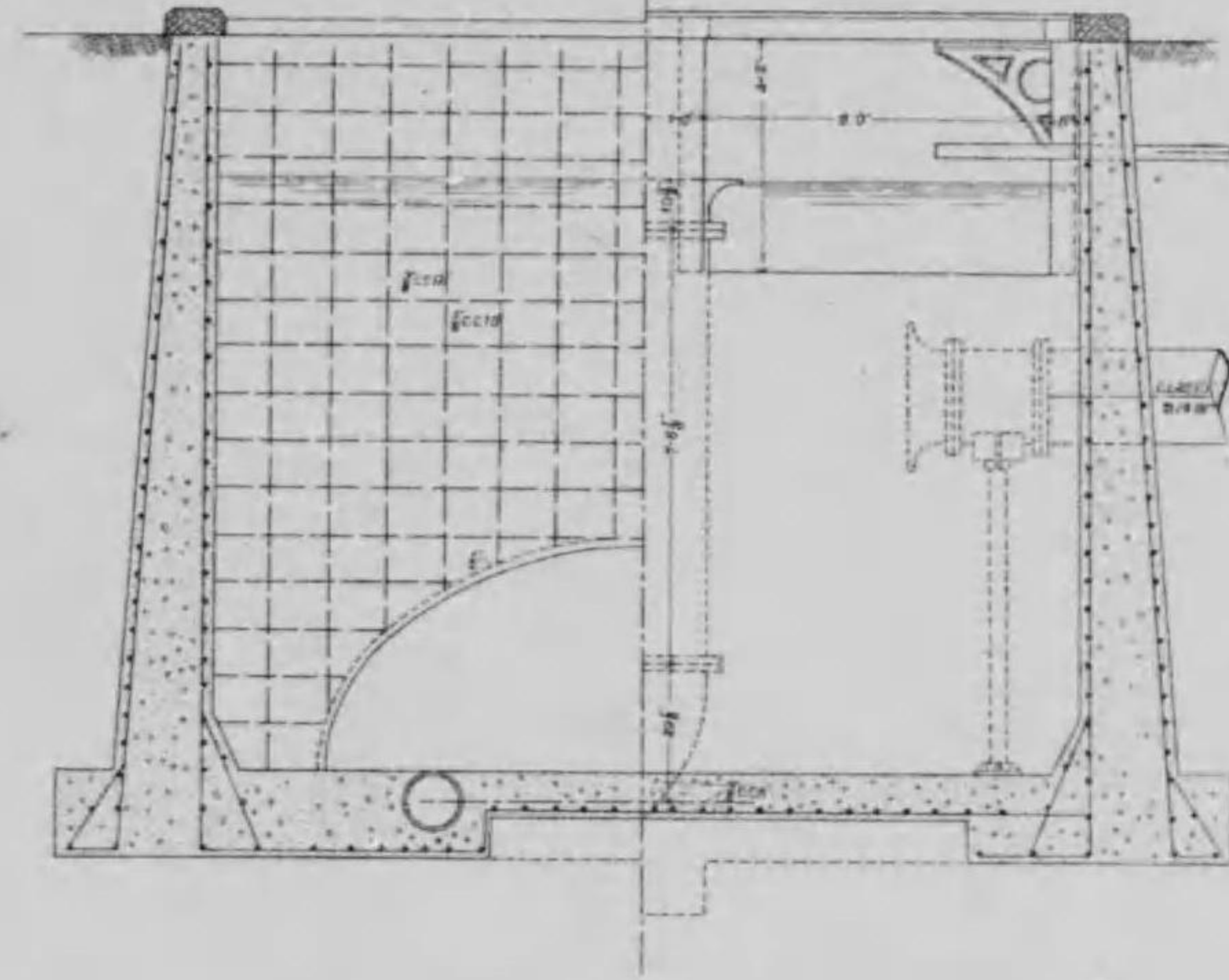
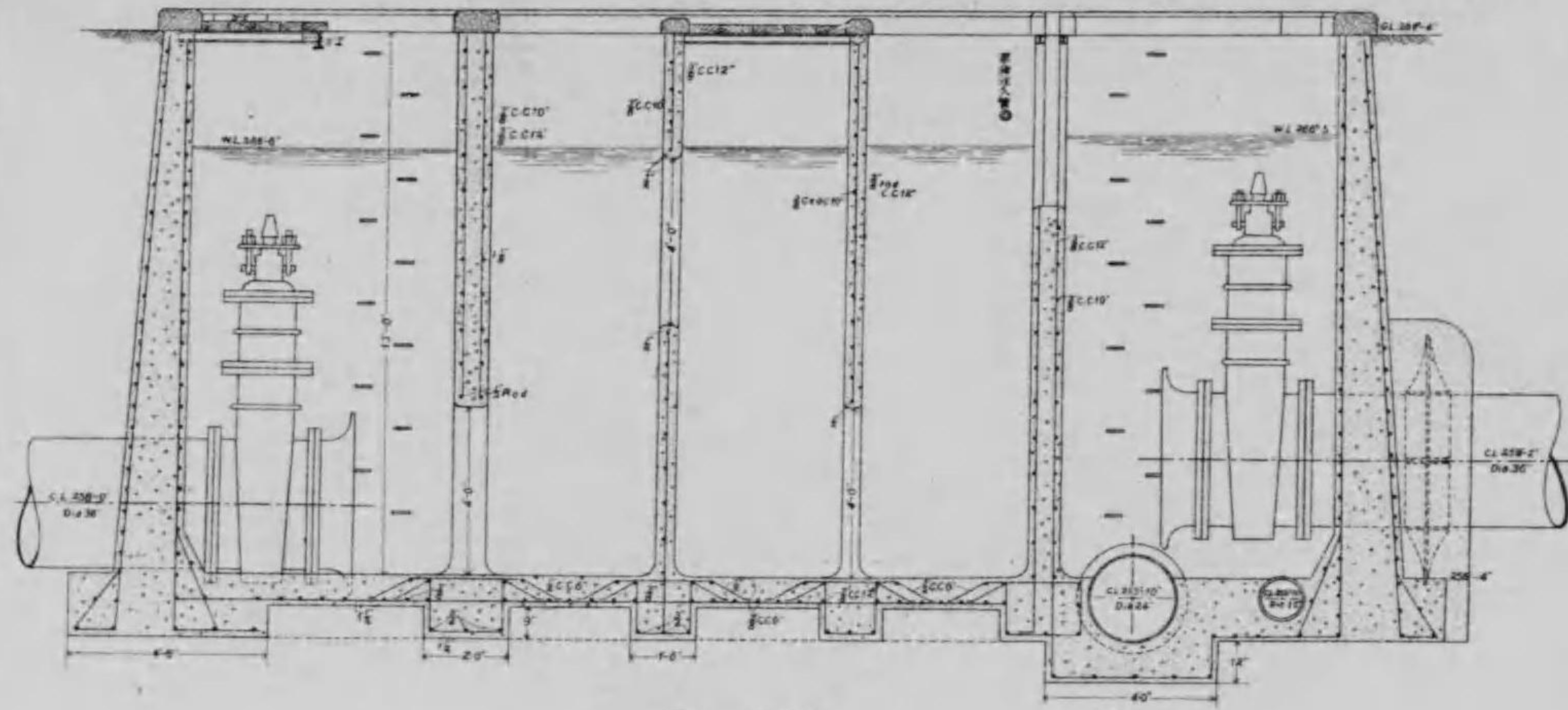

PLAN

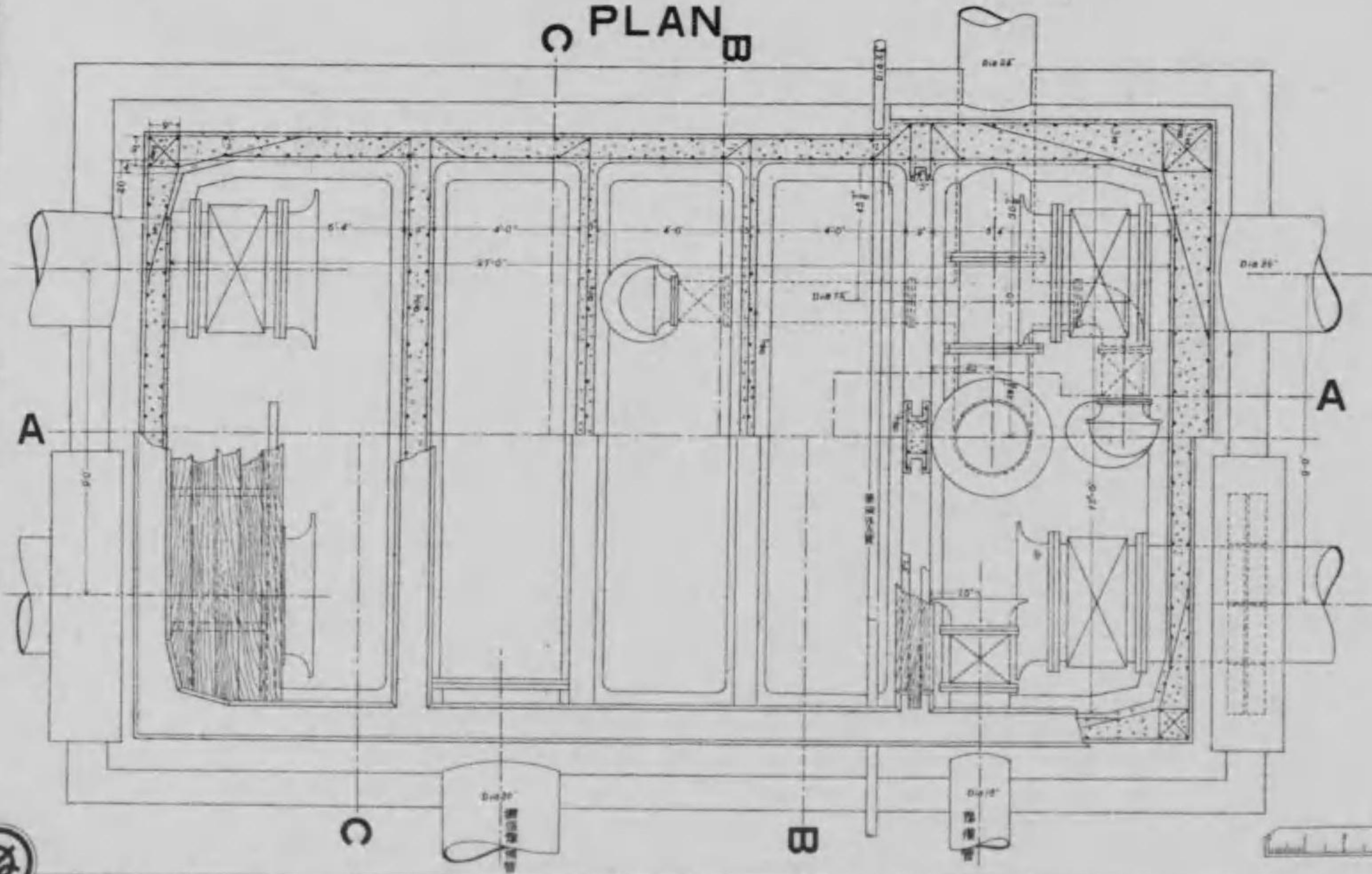

SECTION-C.C

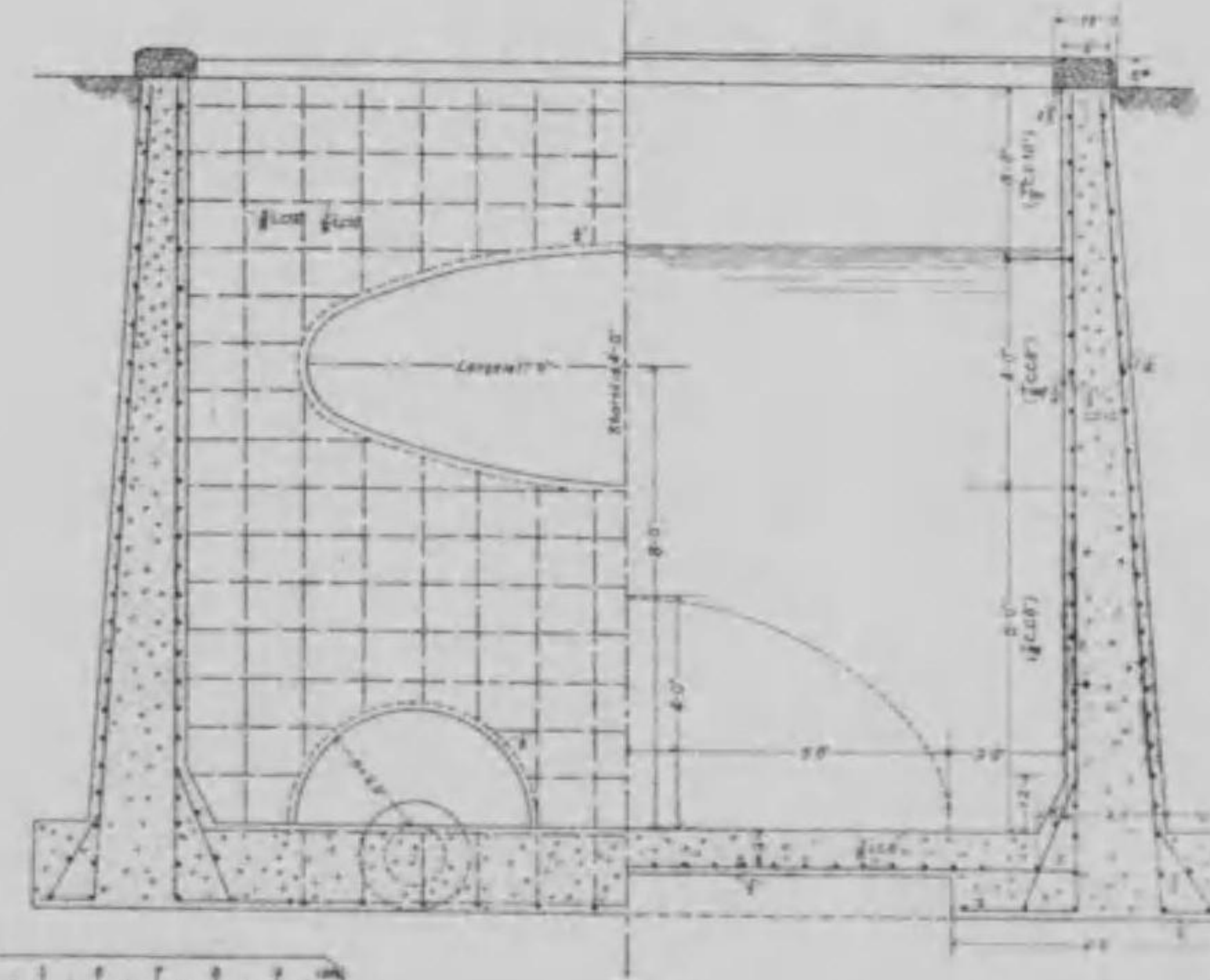

沈澱池附屬井上家圖

第八號

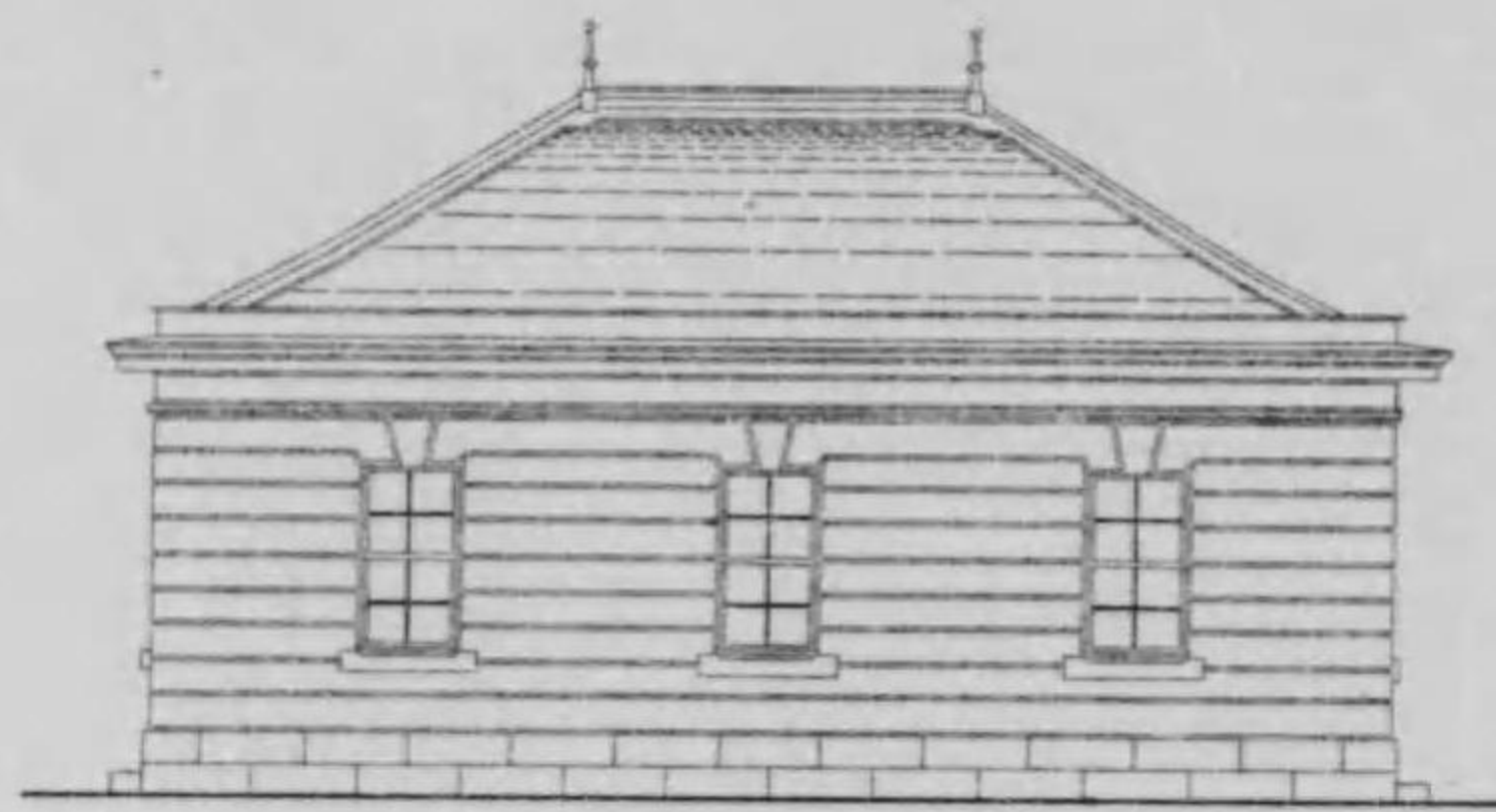

側面圖

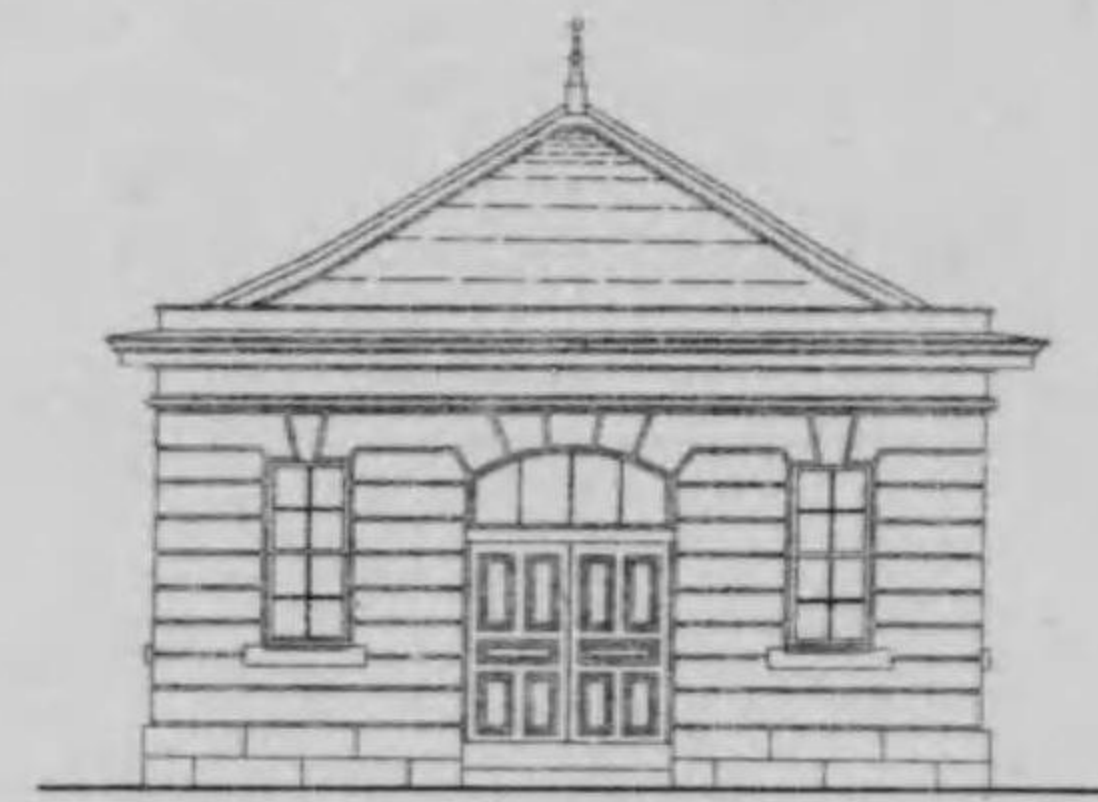

正面圖

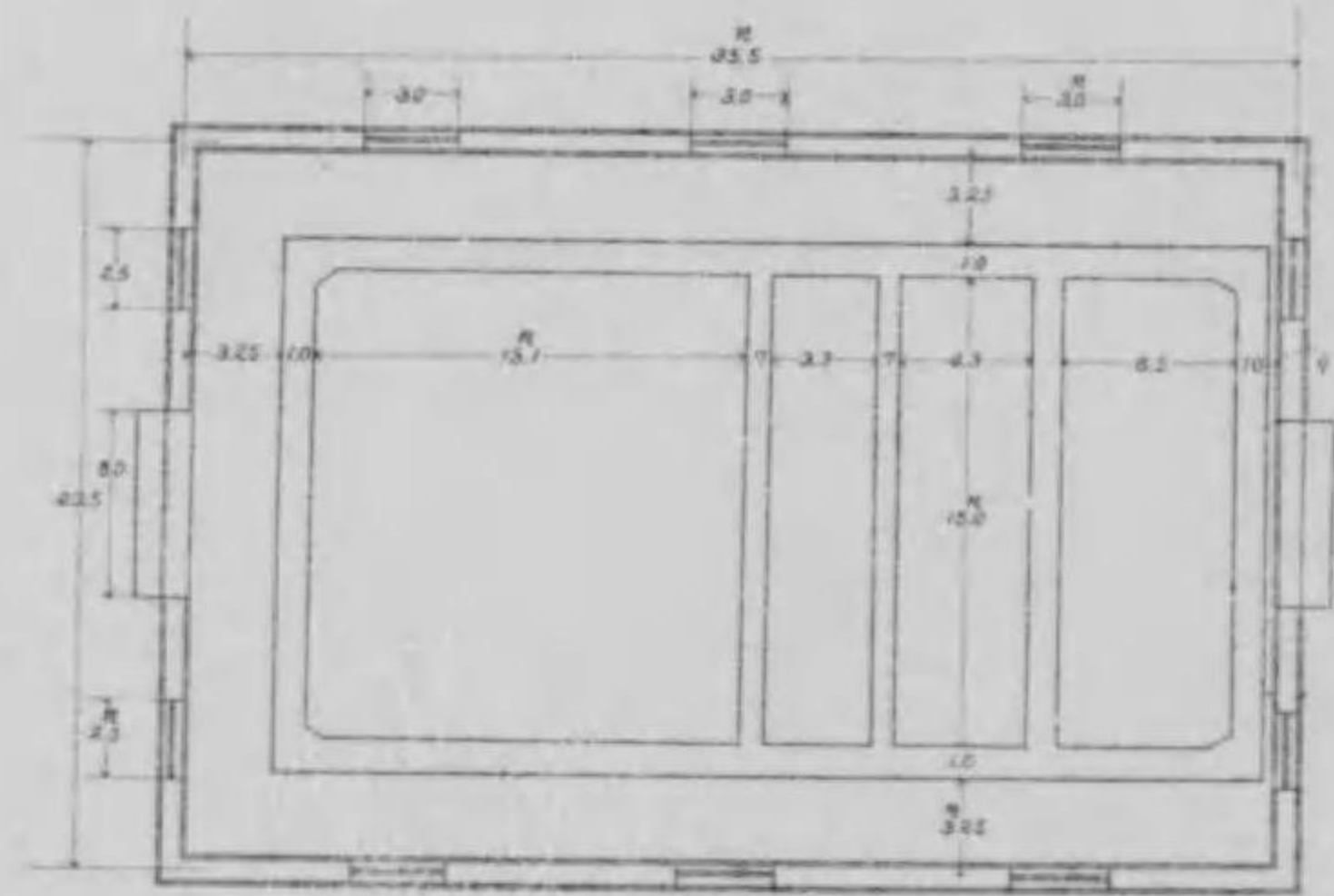

平面圖

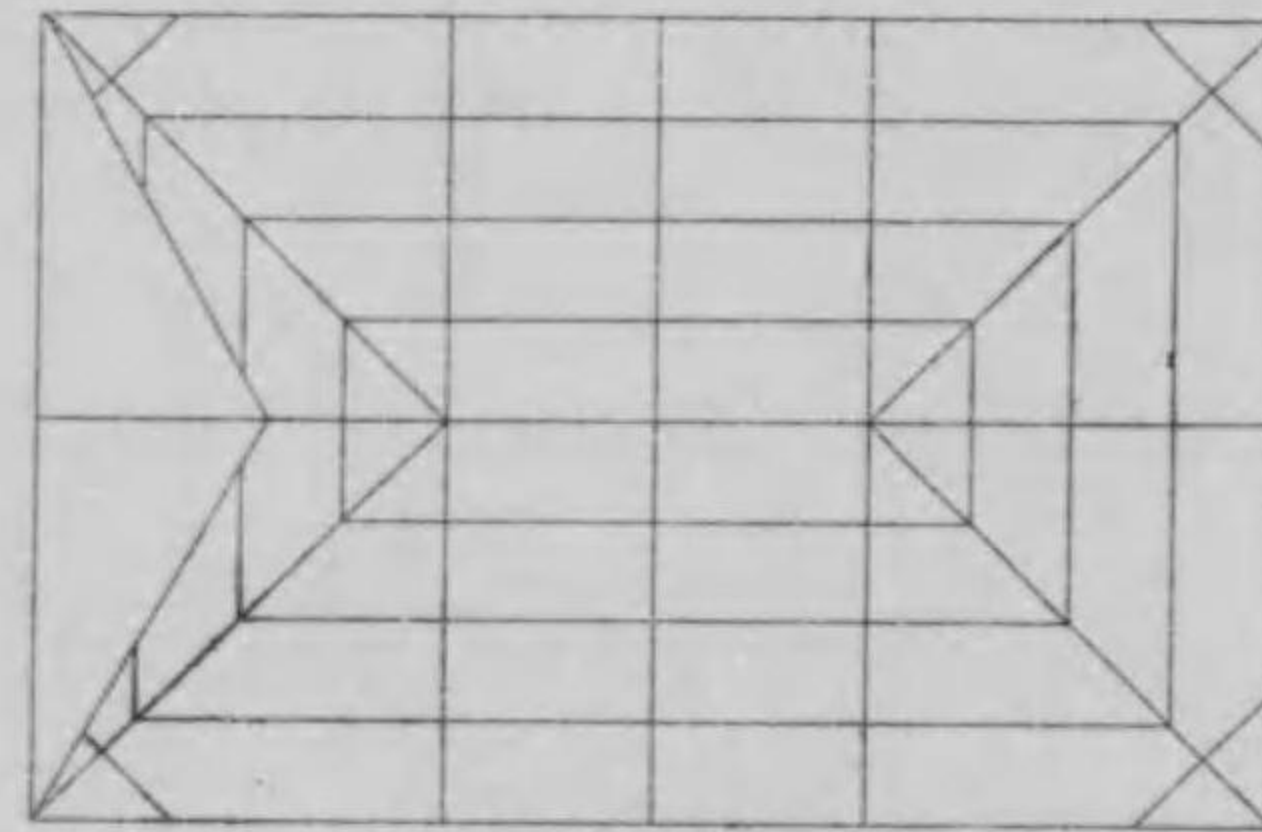

小屋伏圖

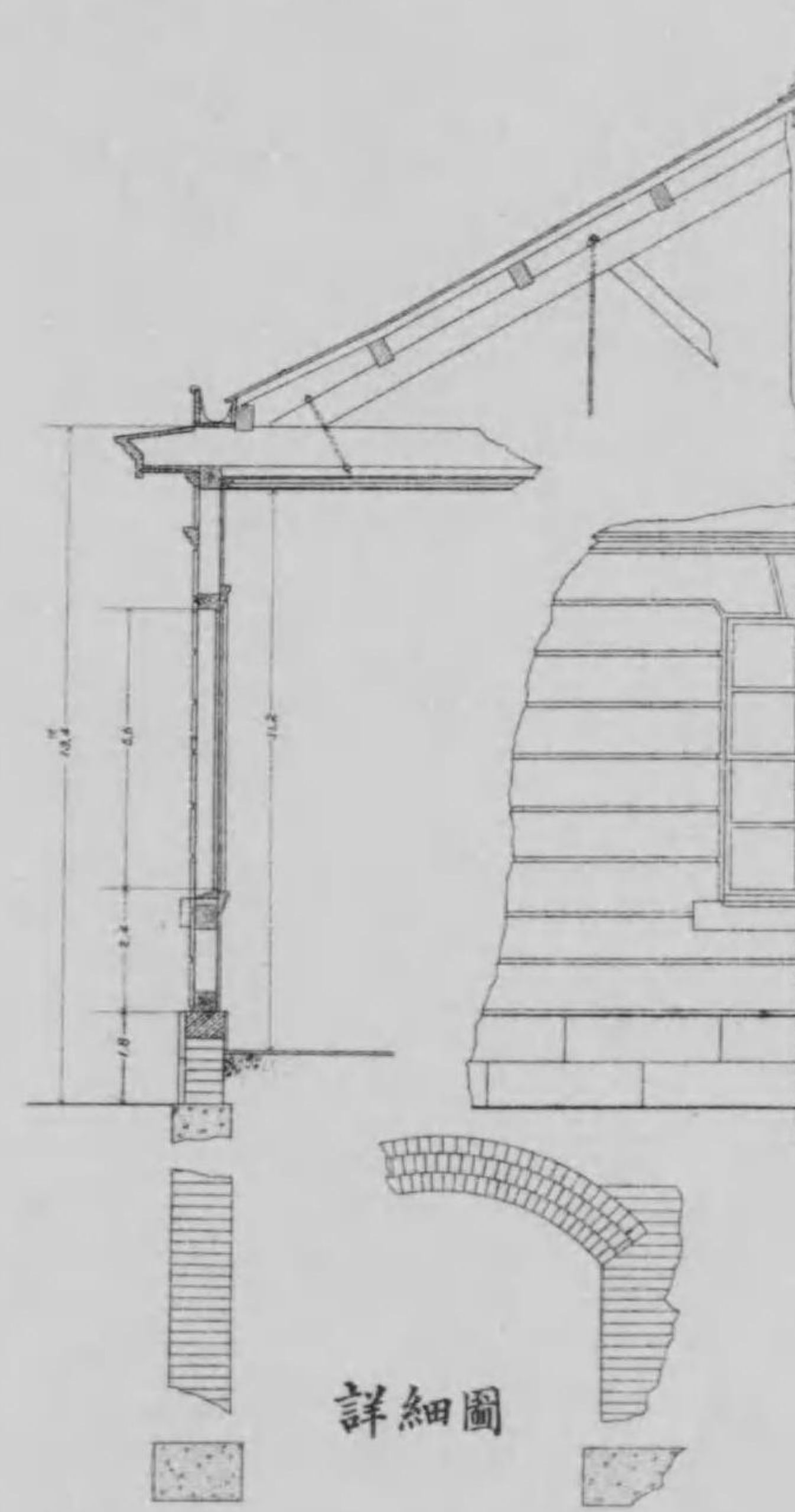

詳細圖

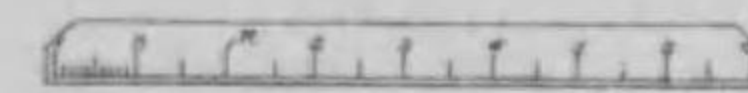
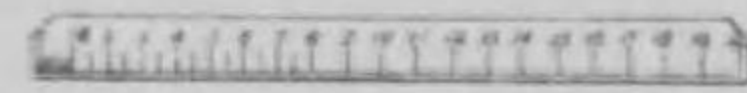

沈澱池構造圖(其一)

第九號

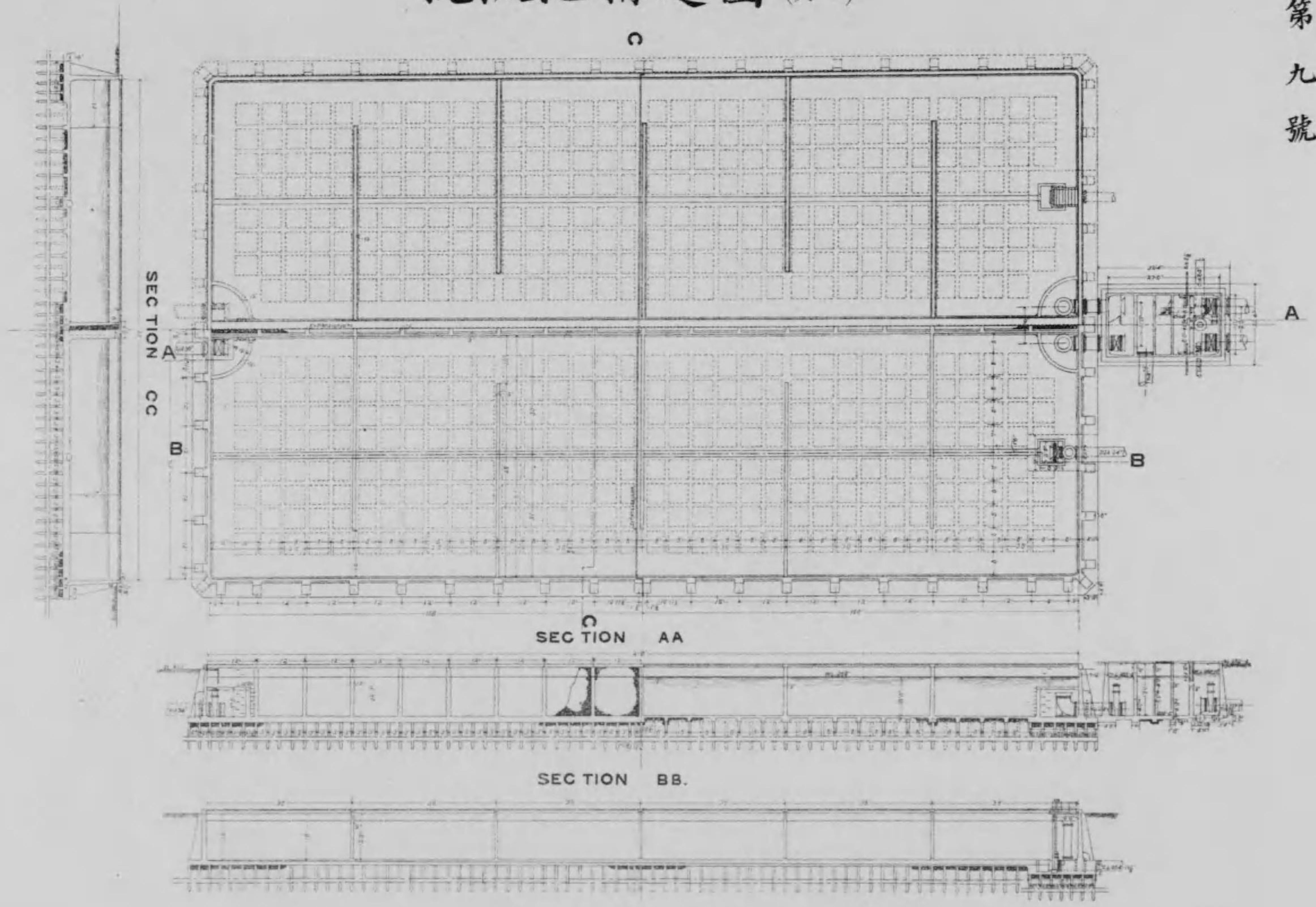

沈澱池構造圖(其二)

第十號

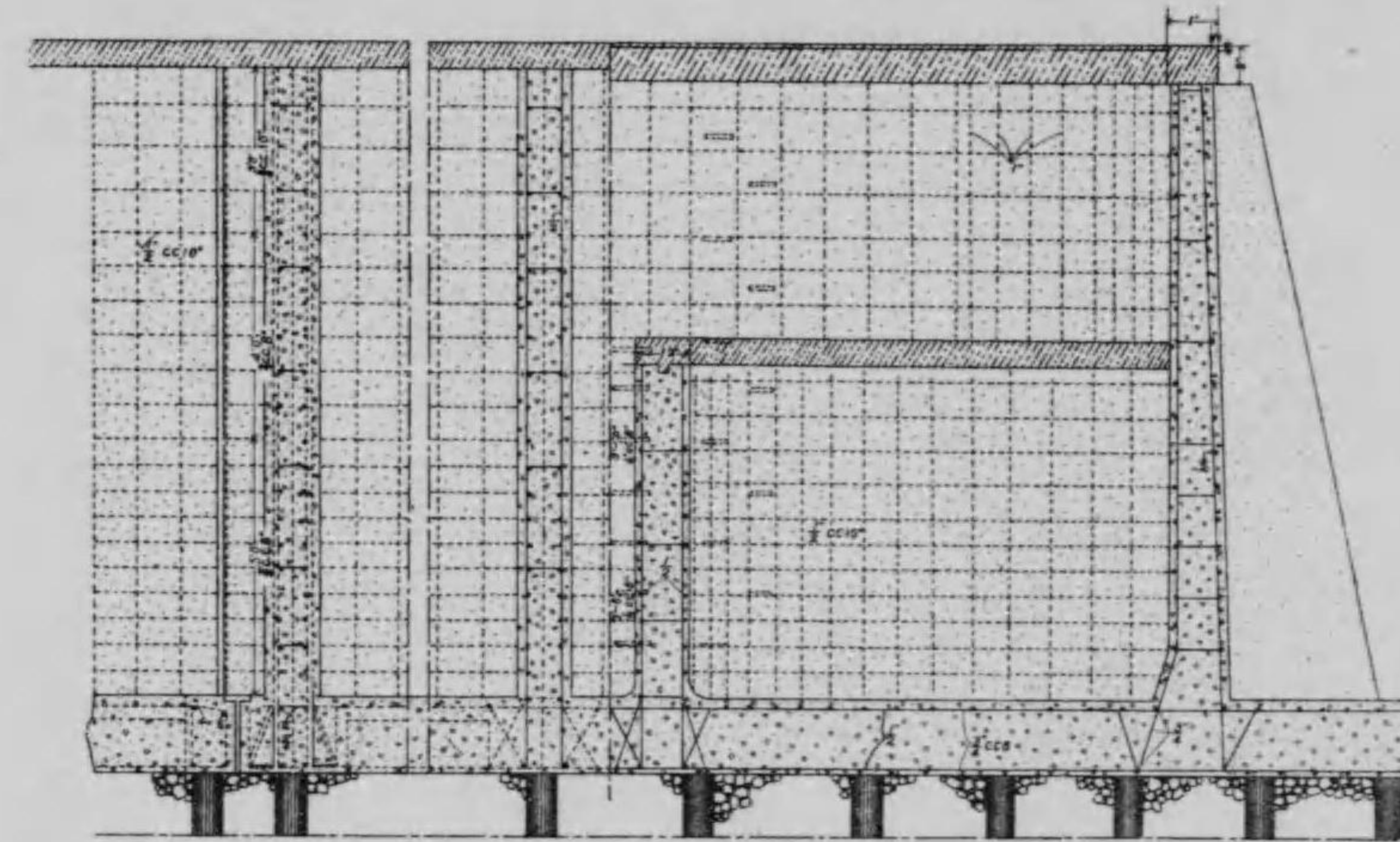

B—B

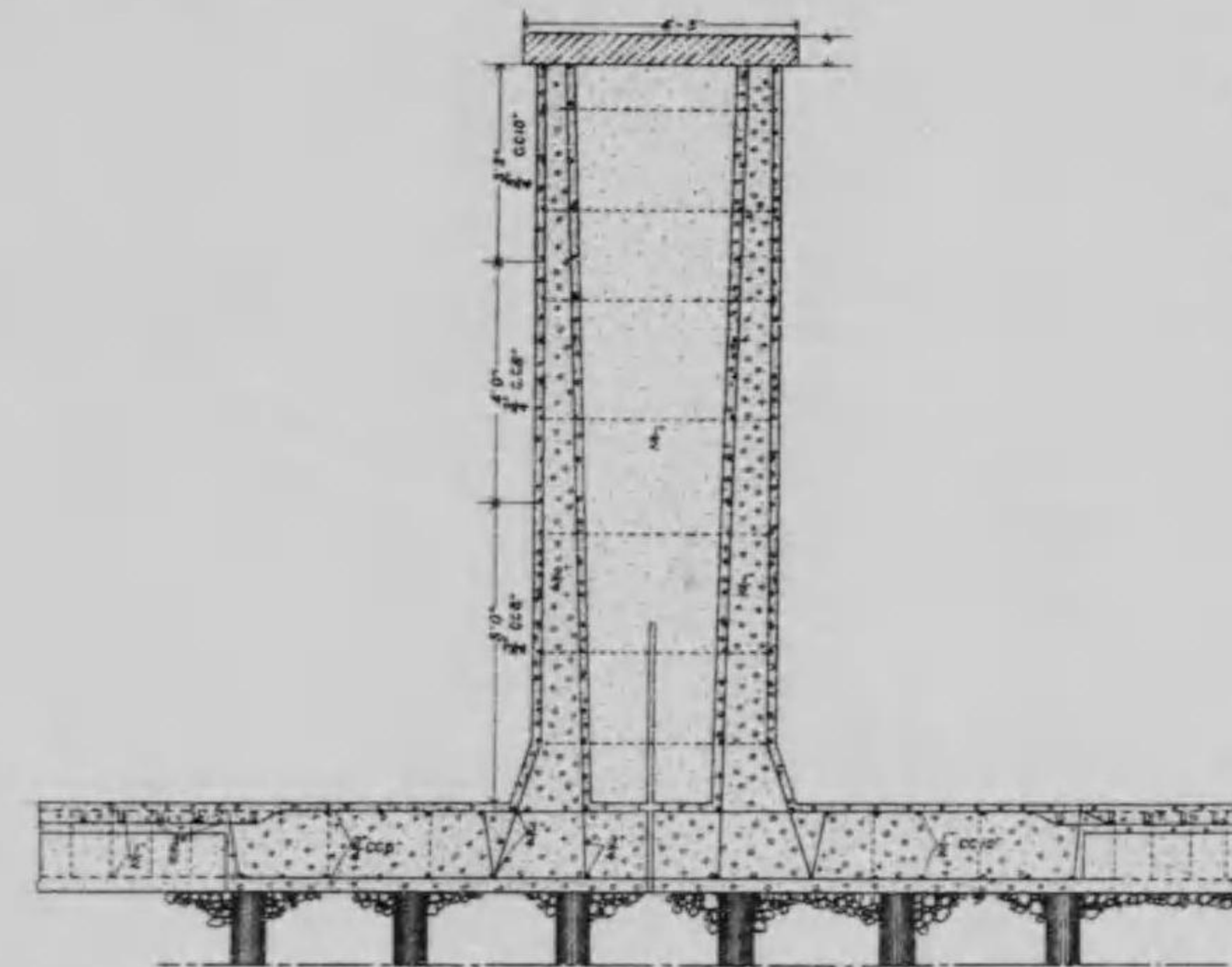

A—A

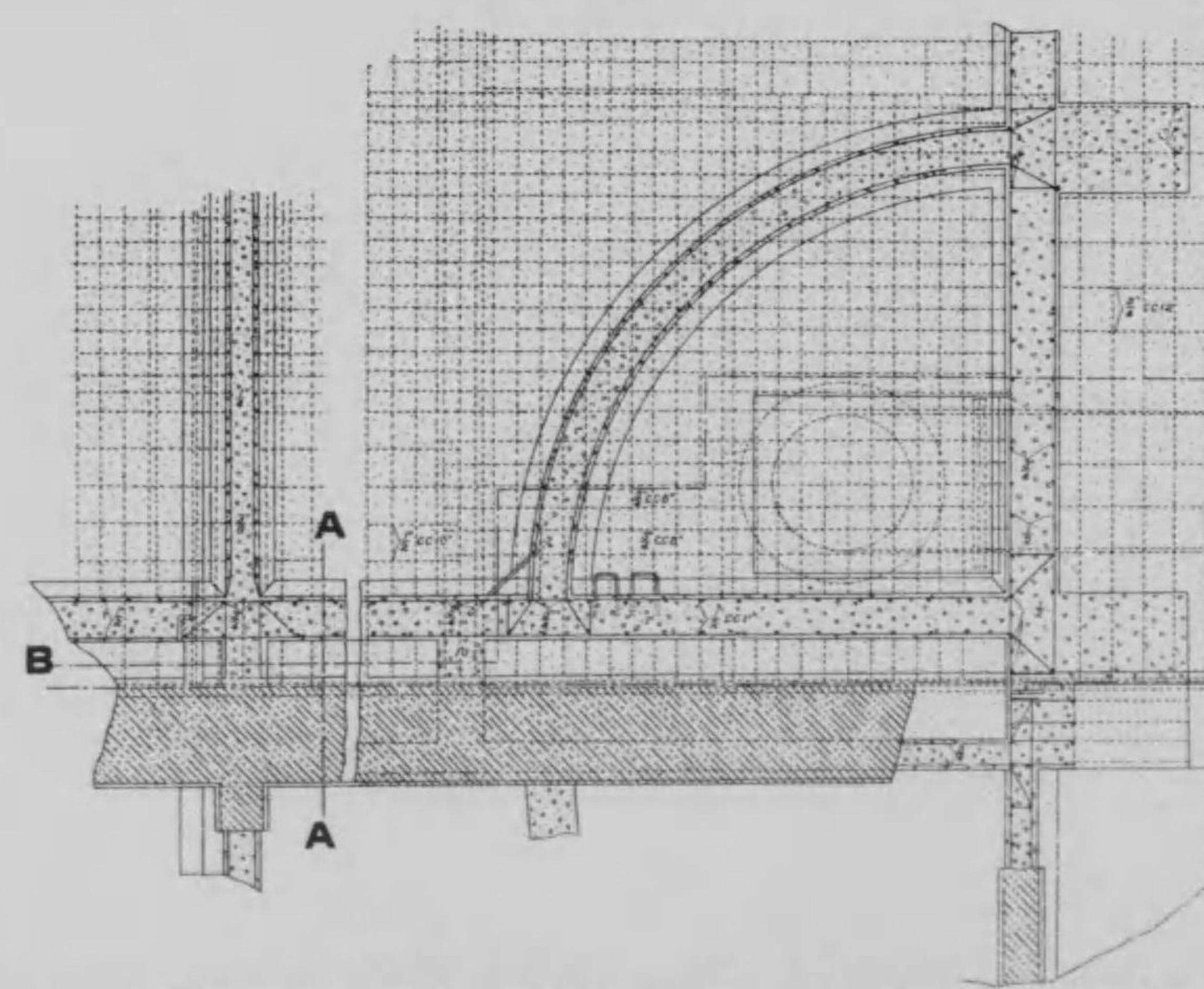

入口平面圖



沈澱池構造圖 (其三)

導流壁圖

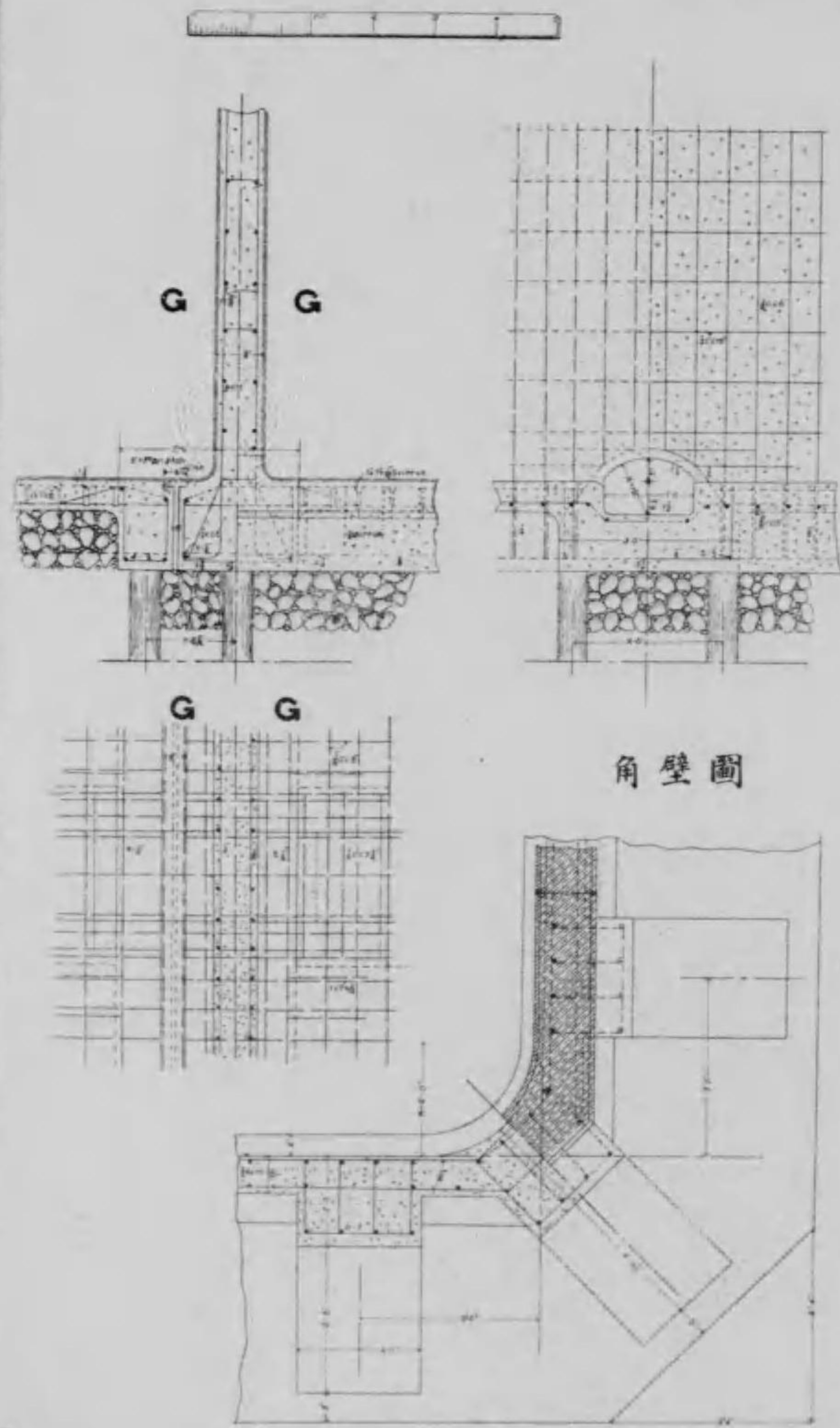

側壁圖

第十一號

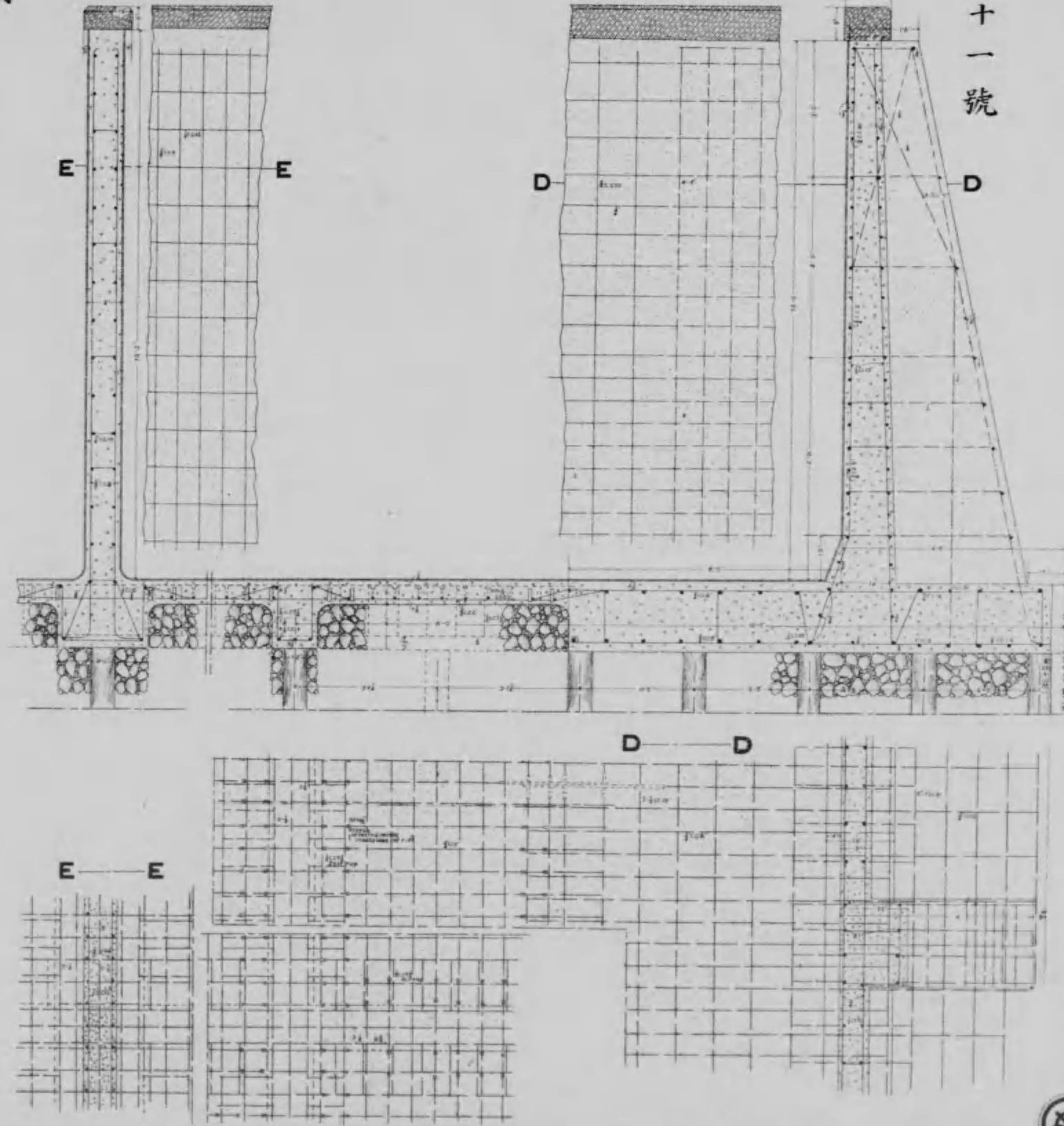

沈澱池構造圖(其四)

第十二號

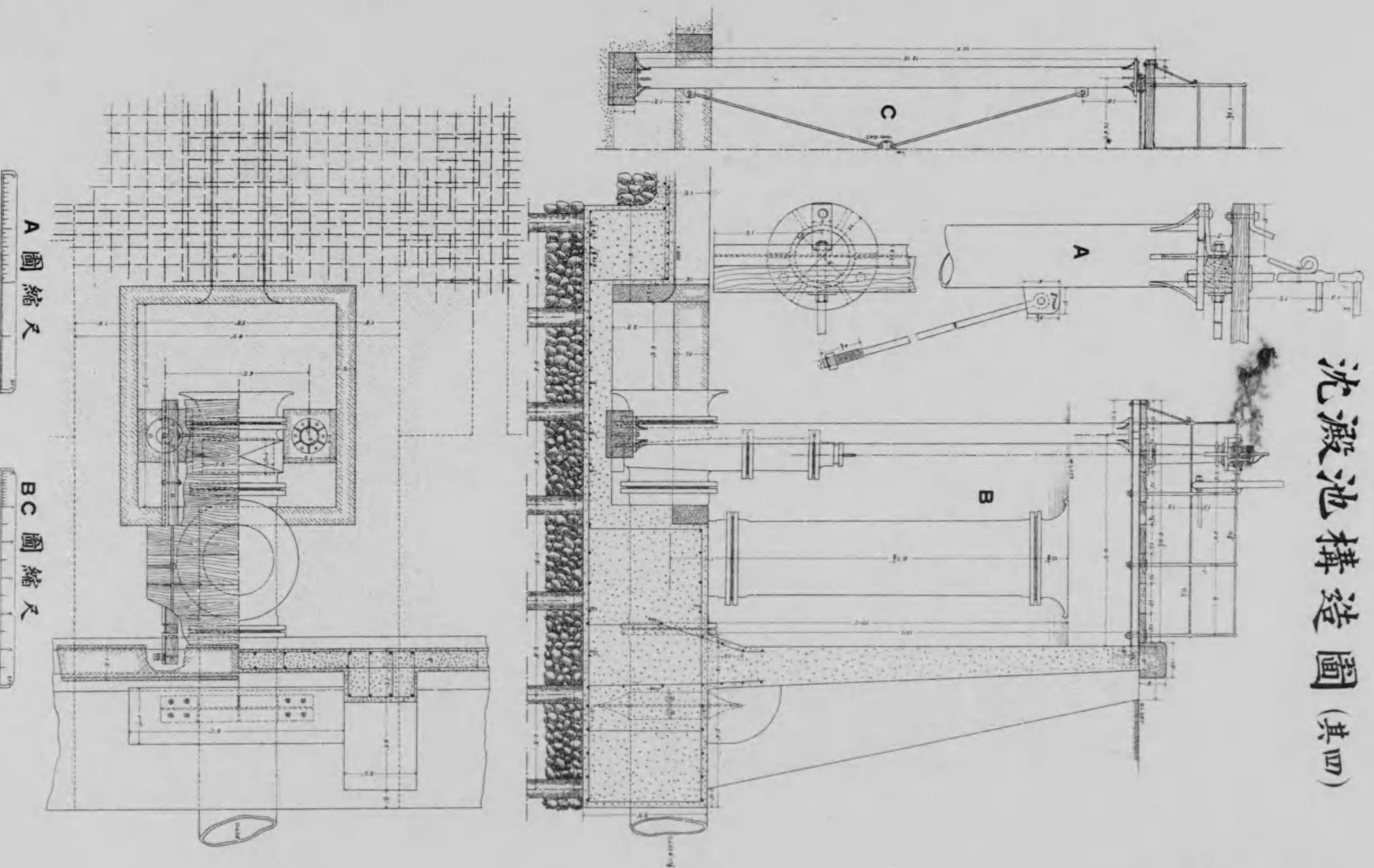

A圖縮尺

BC圖縮尺

濾過場平面圖

第十三號

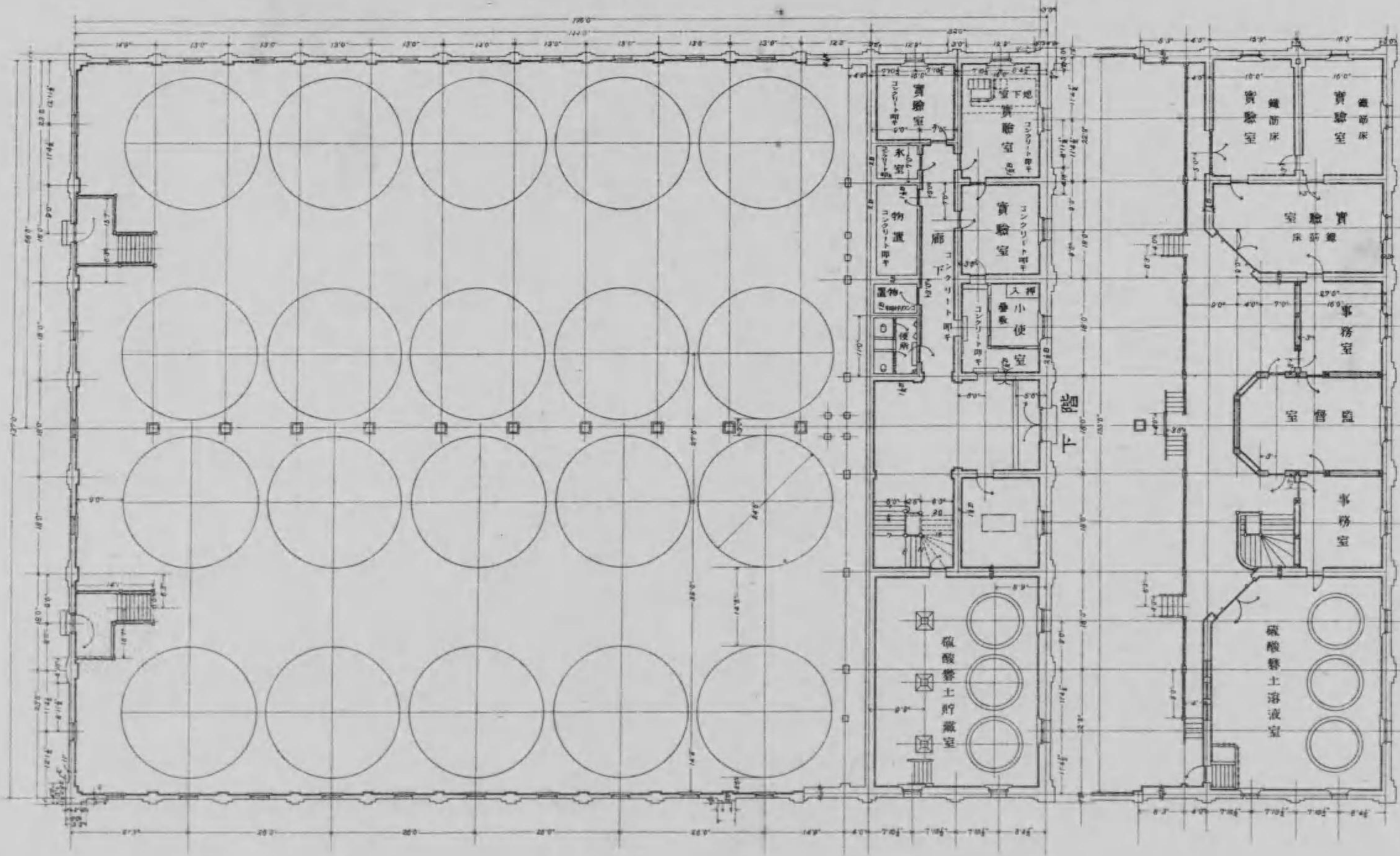

濾過場建圖(其一)

第十四號

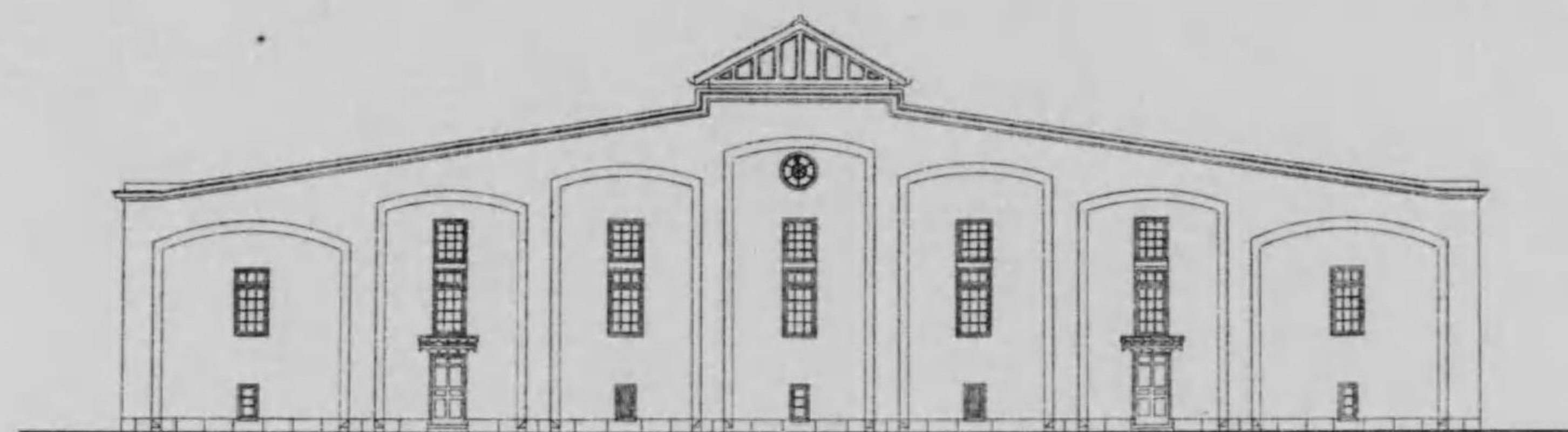

正面建圖

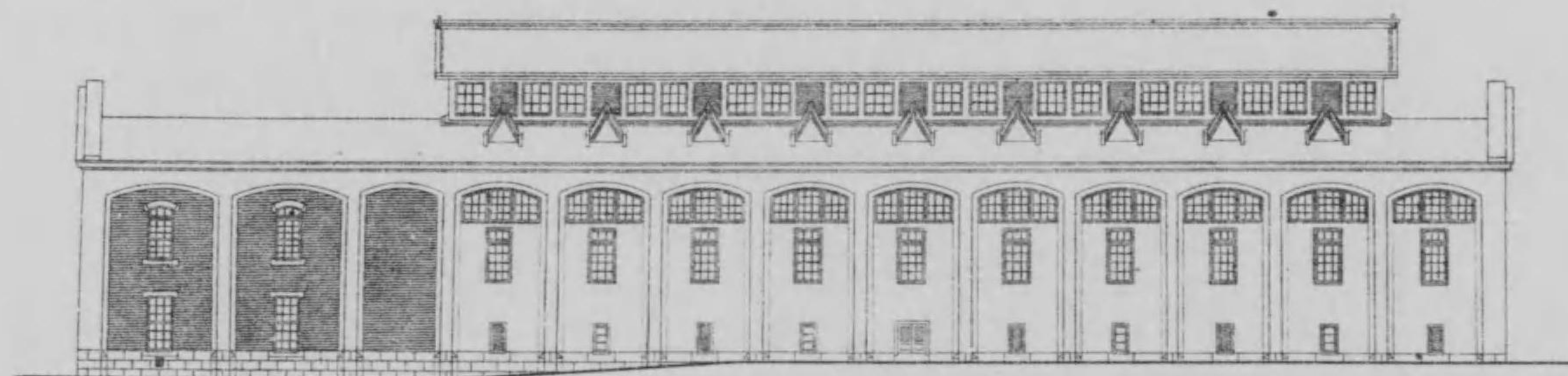

東側建圖



濾過場建圖(其二)

第十五號

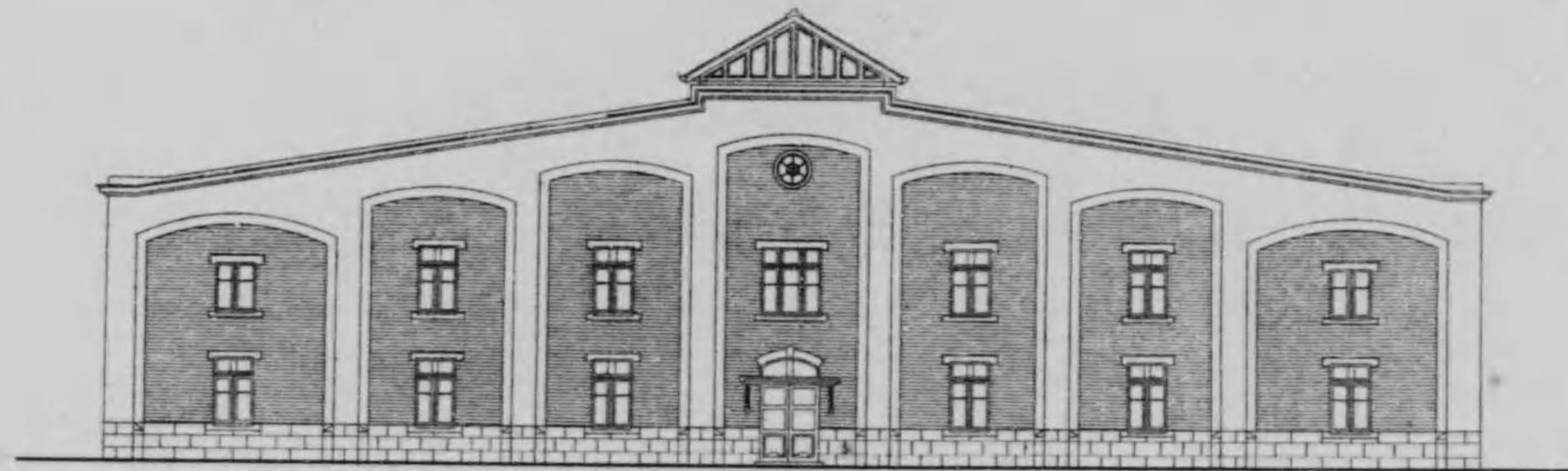

背面建圖

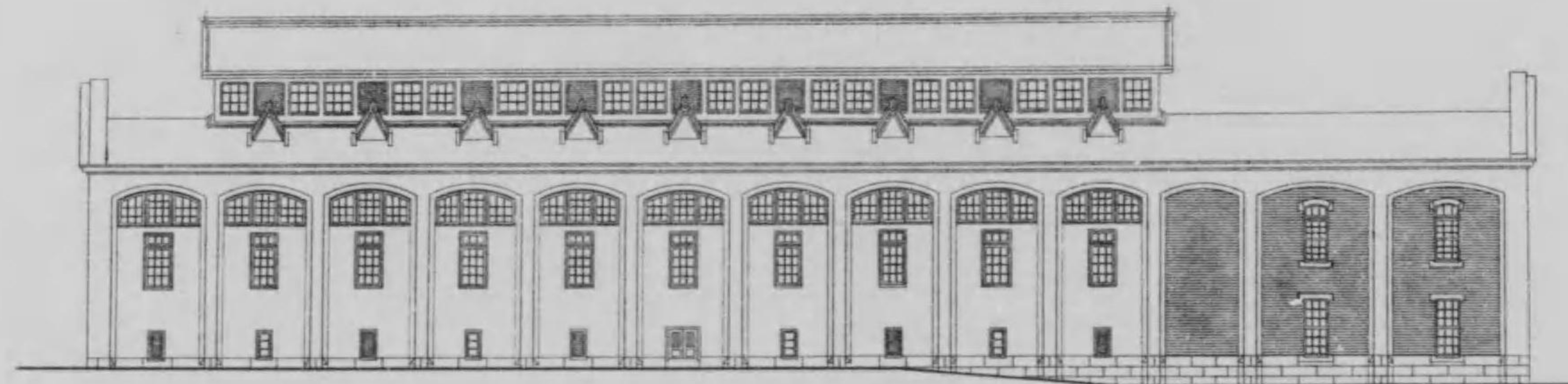

西側建圖



濾過場縱橫斷圖

第十六號

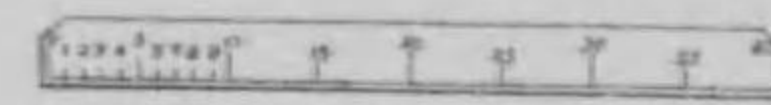
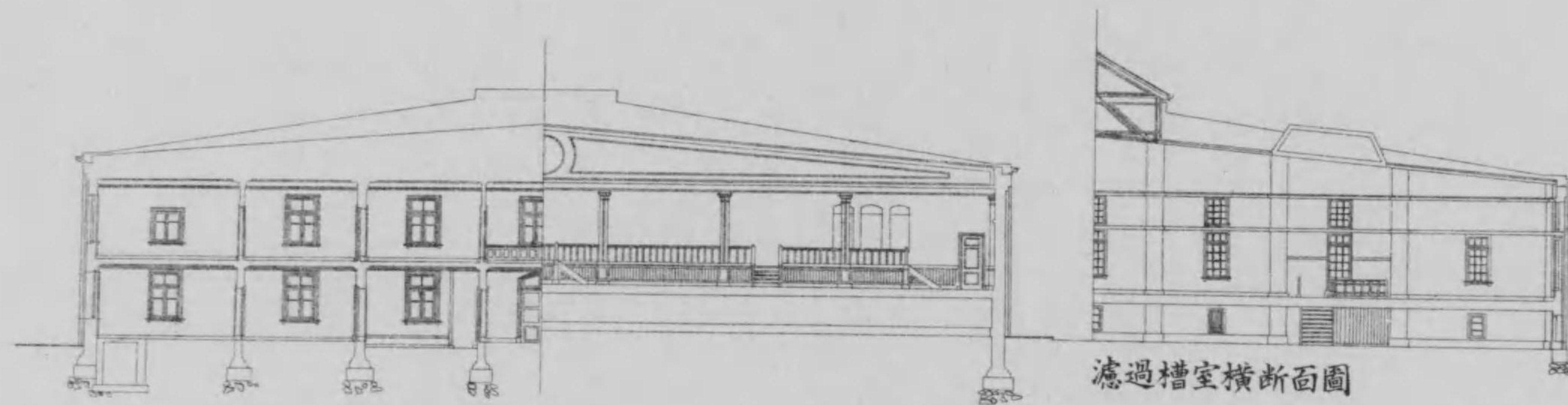
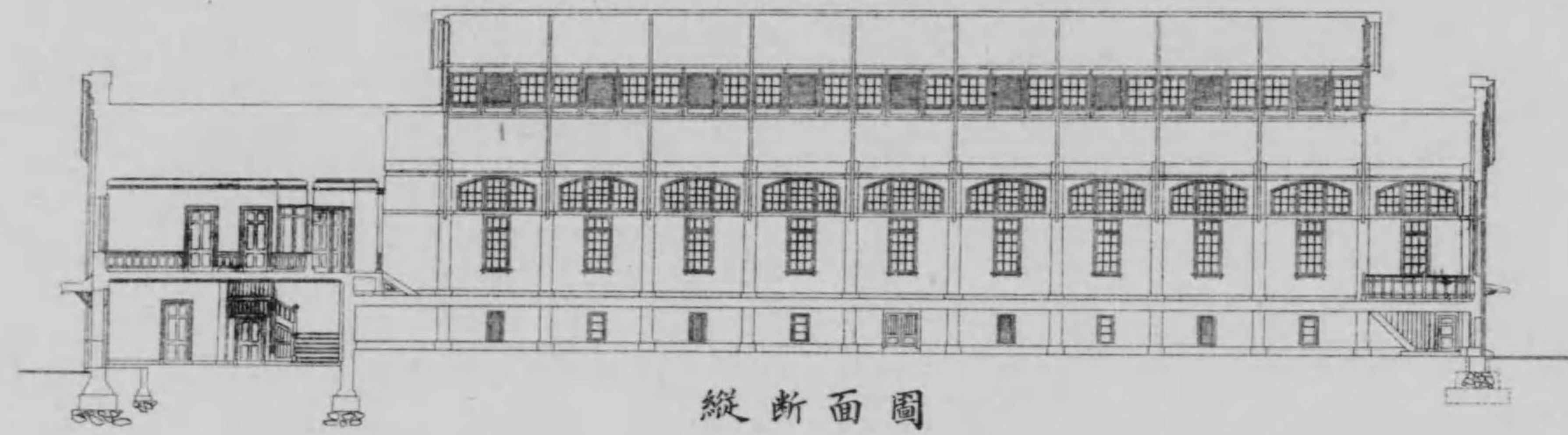

濾過場特別基礎之圖

第十七號

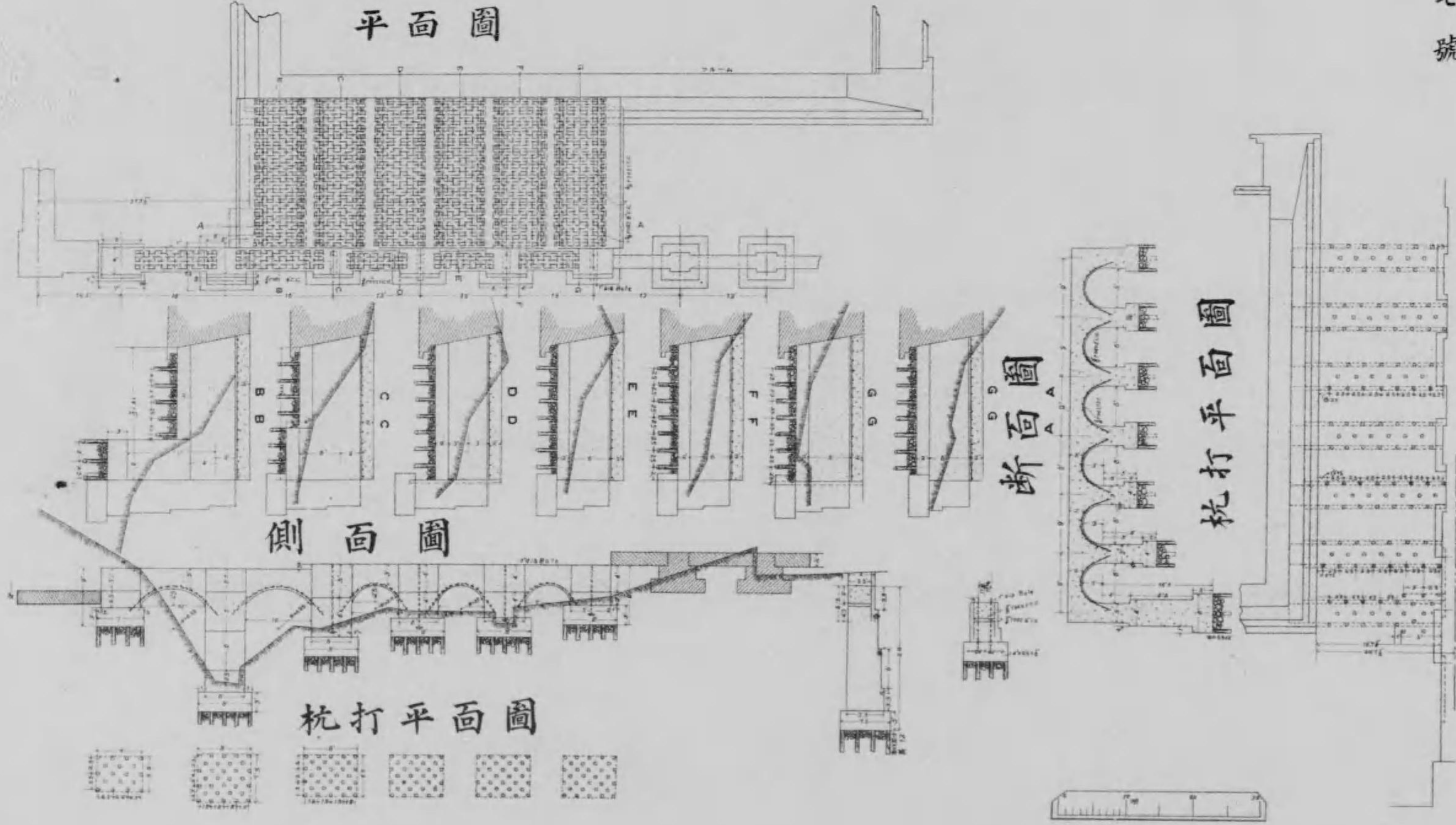

濾過場事務室側基礎詳細圖

第十八號

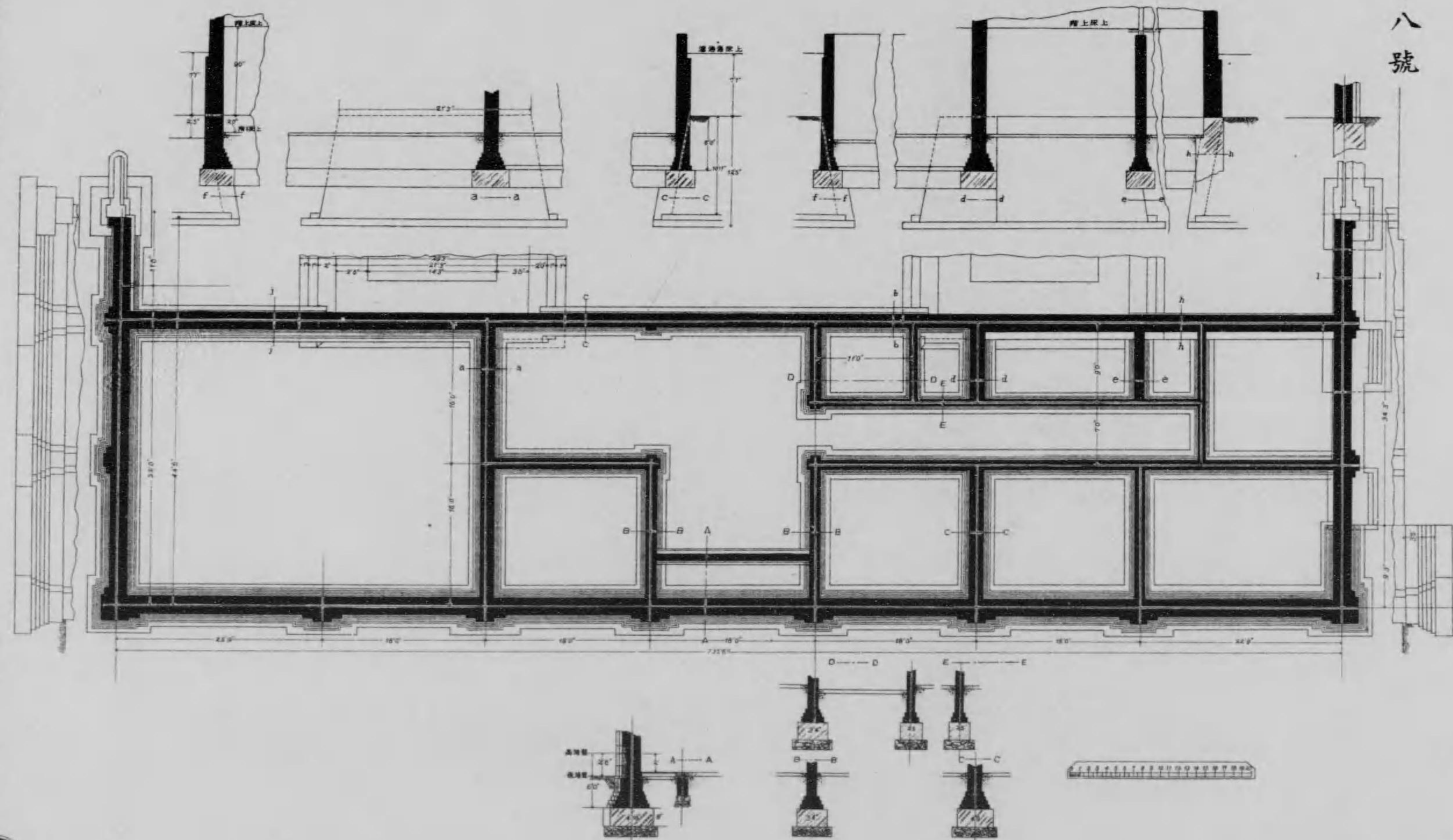

瀘過場事務室側詳細圖

第十九號



正面圖

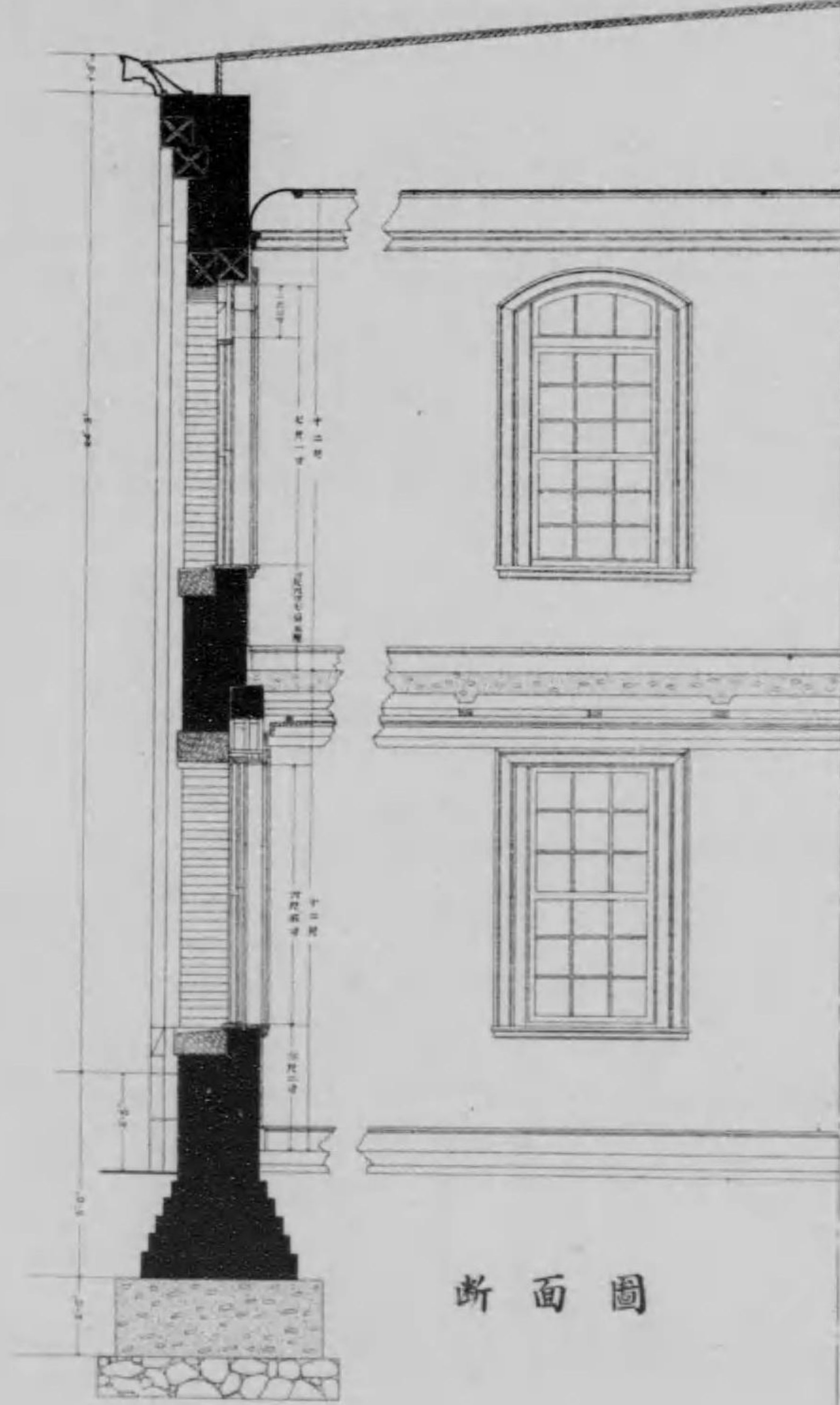

断面圖

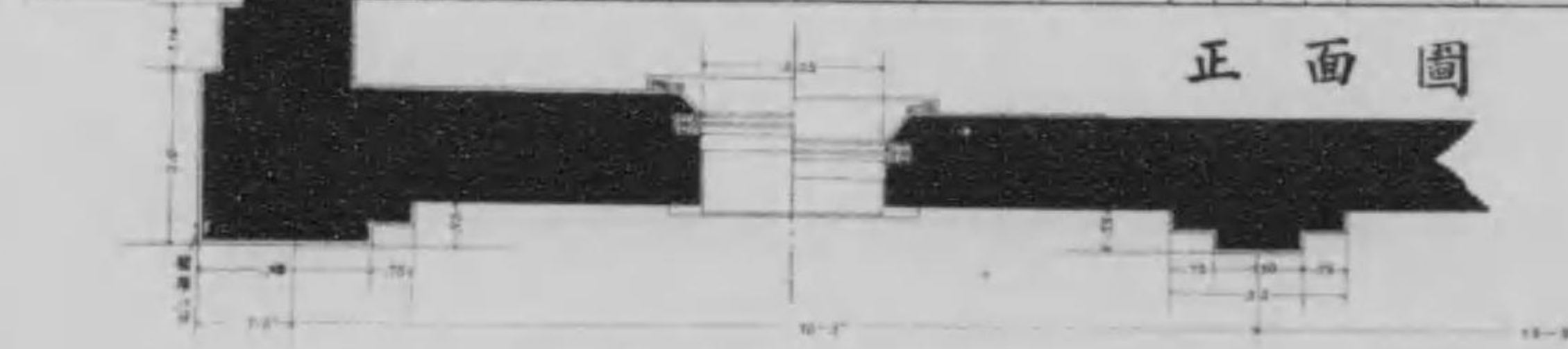

平面圖



濾過場事務所側階下天井平面圖
階下天井平面圖

第二十號

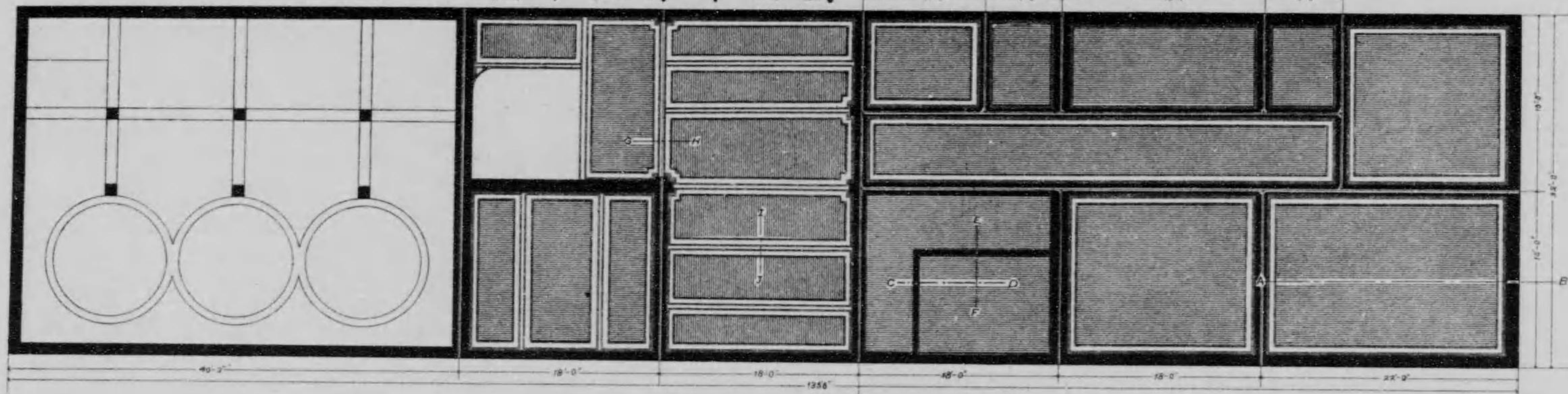

階上床張配置圖

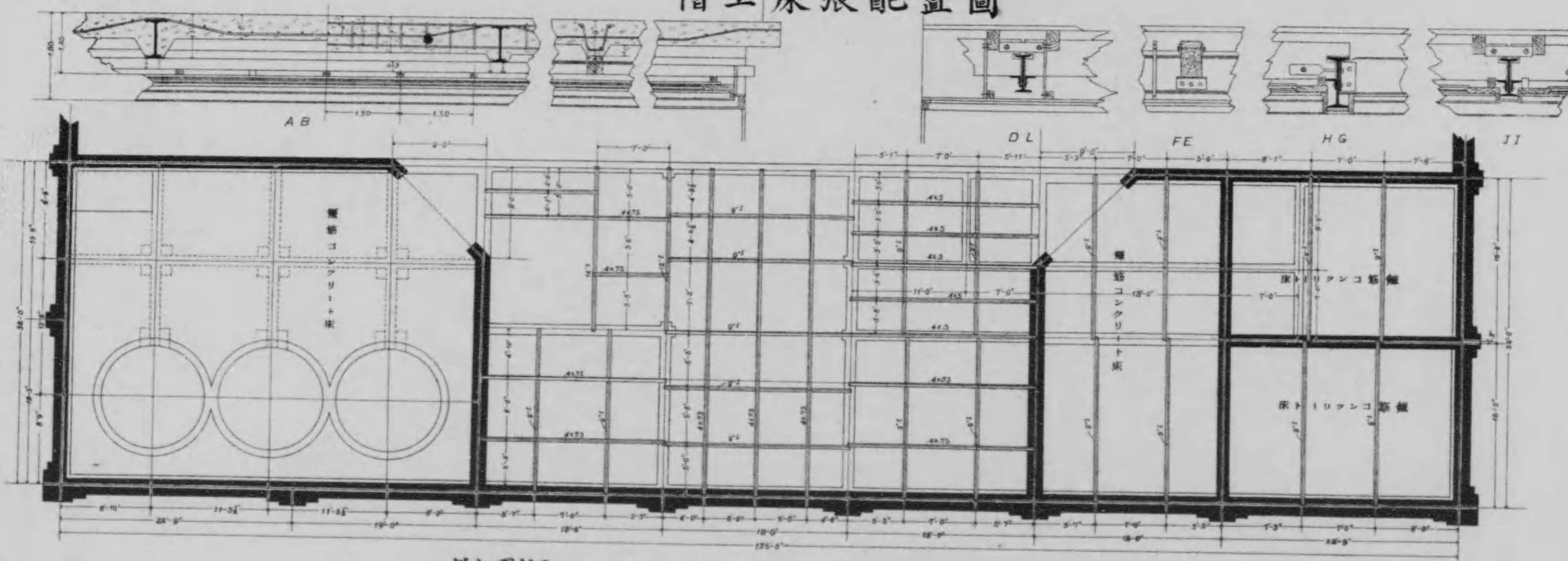

床張配置図



濾過場硫酸礬土溶解室床圖

第二十一號

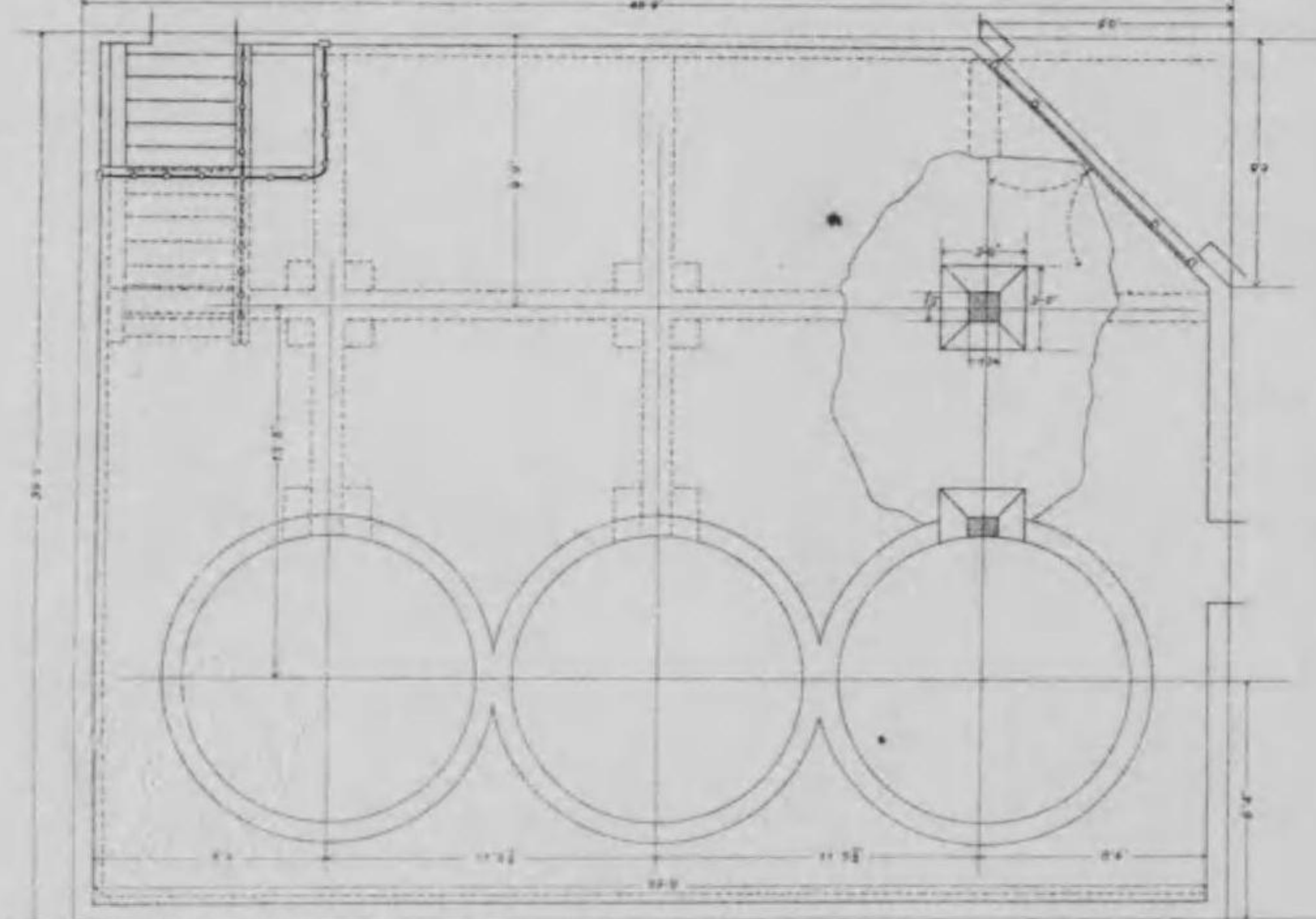
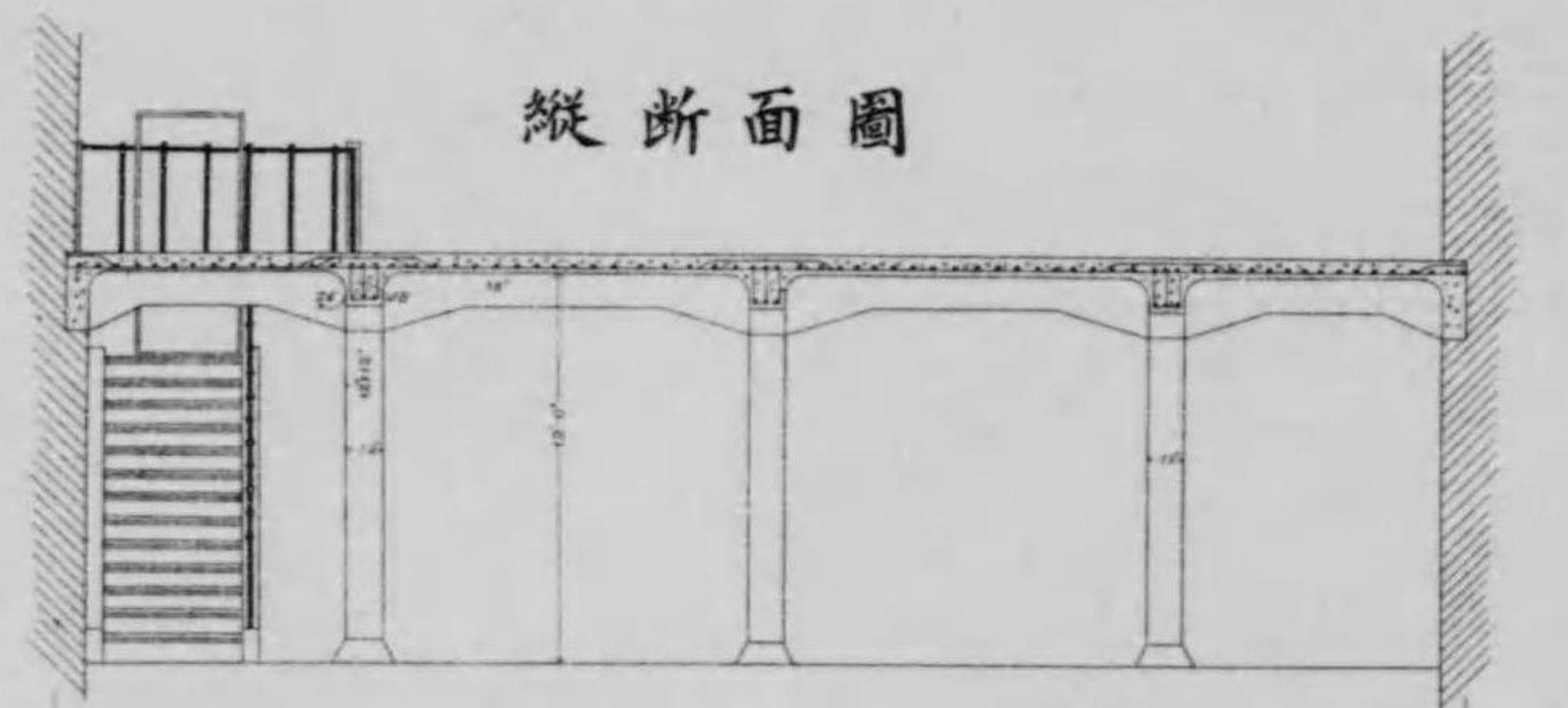

平面圖

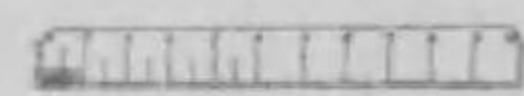

断面圖

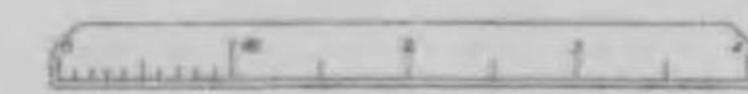
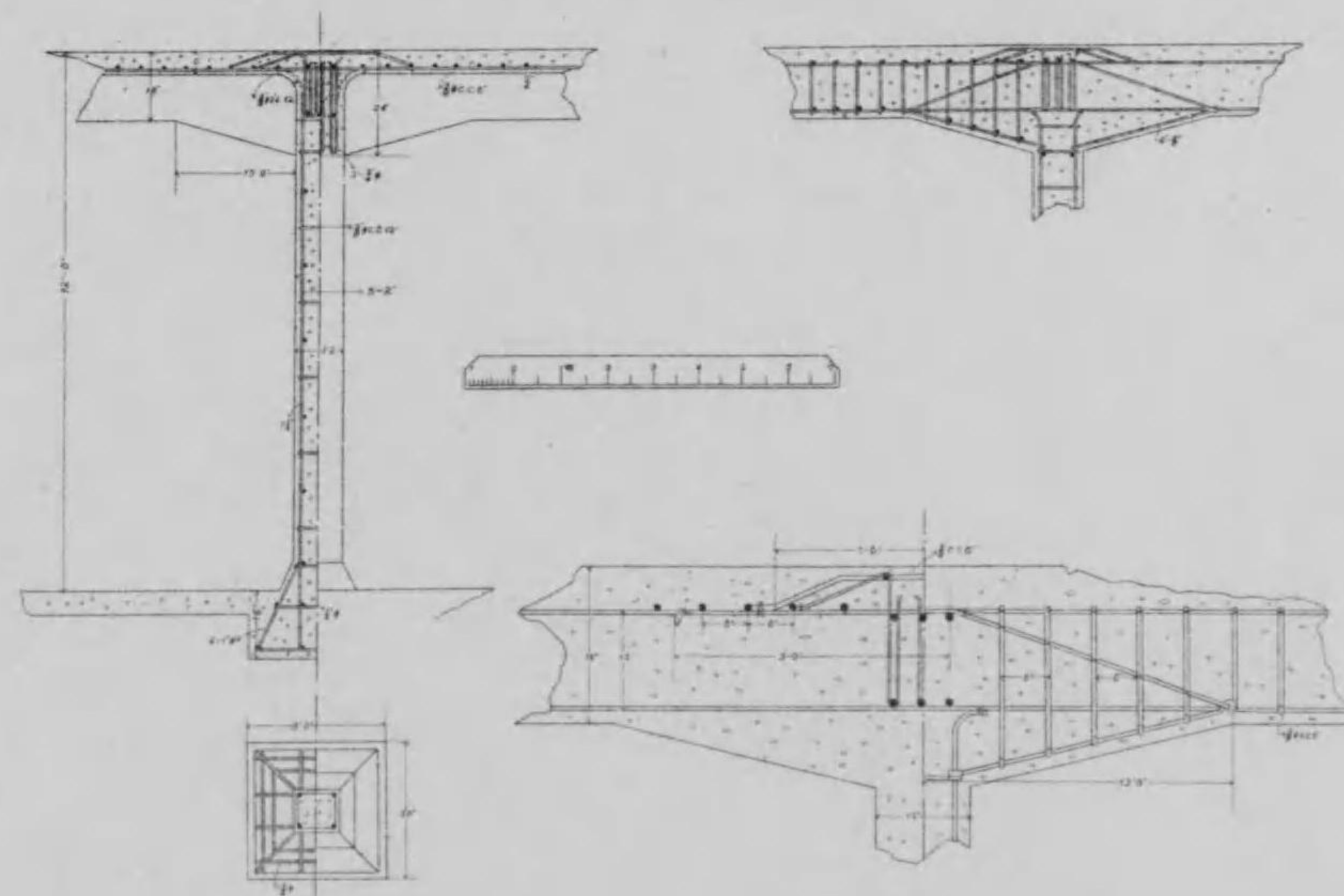

濾過場鐵筋壁圖

第二十二號



AB 断面

断面圖

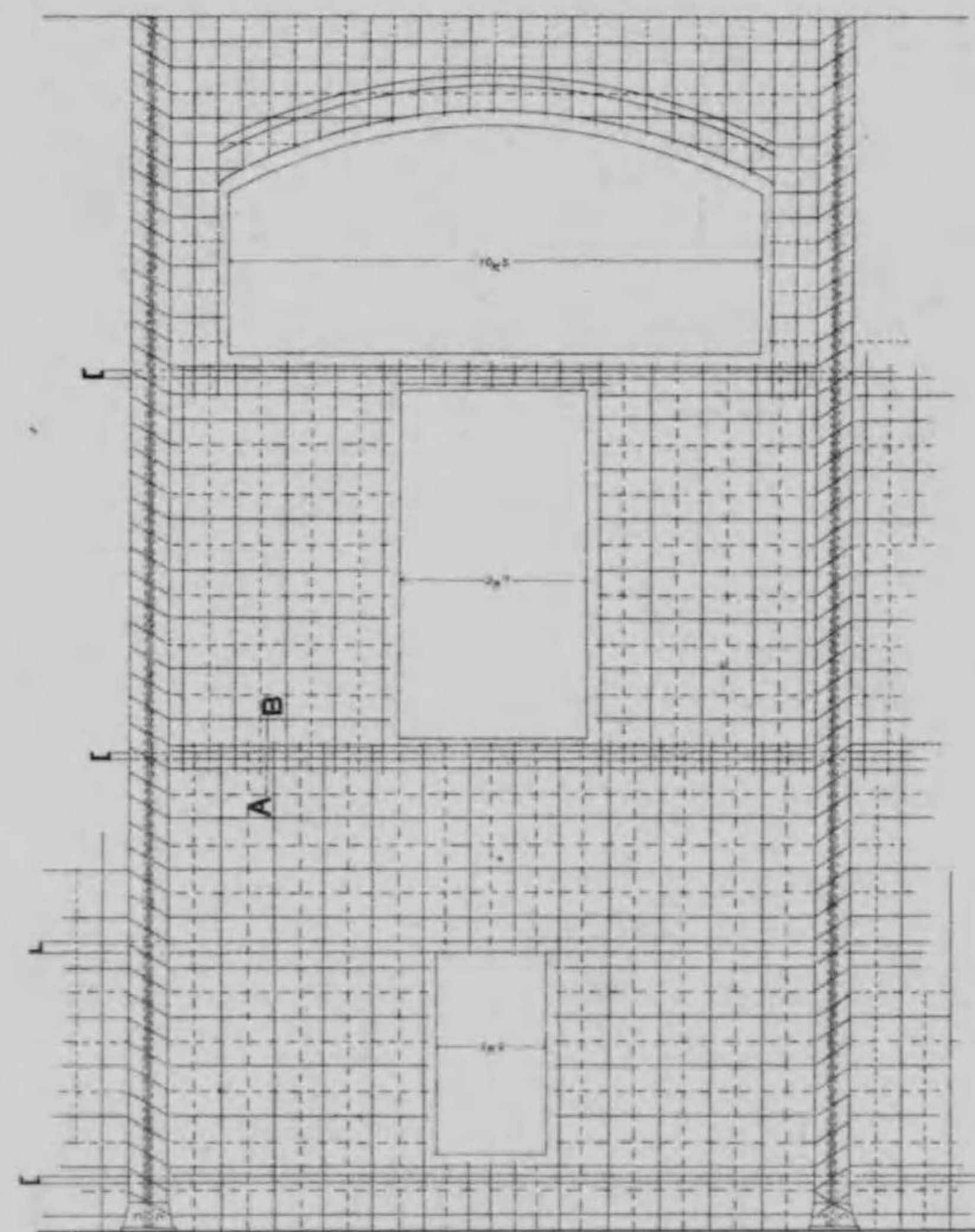

正面建圖

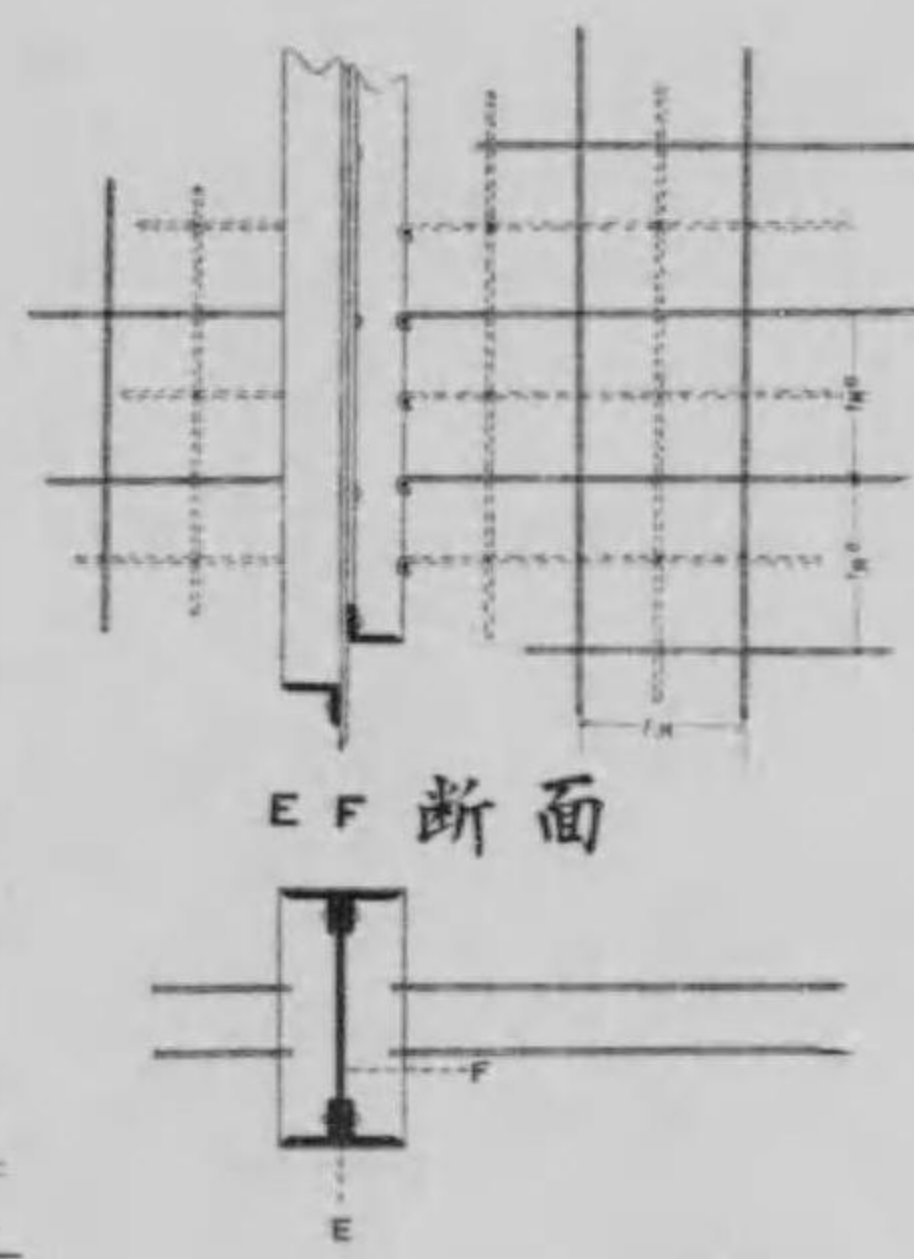

EF 断面

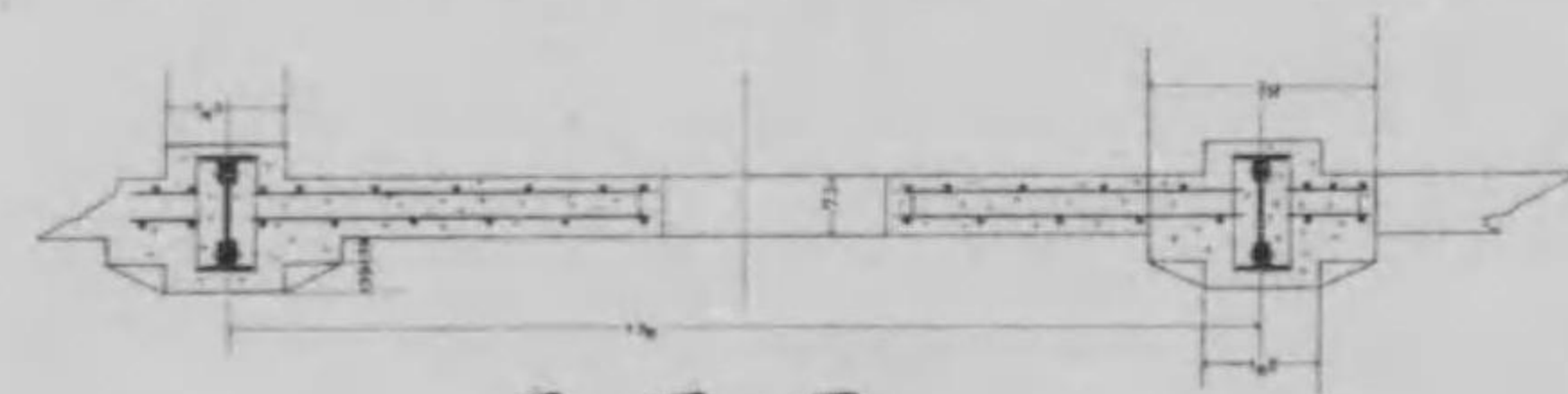

平面圖

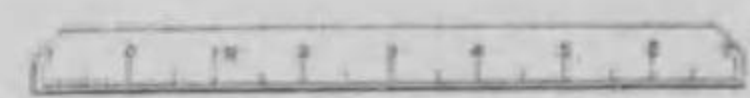

濾過場鉄骨圖(其一)

第二十三號

屋構之圖

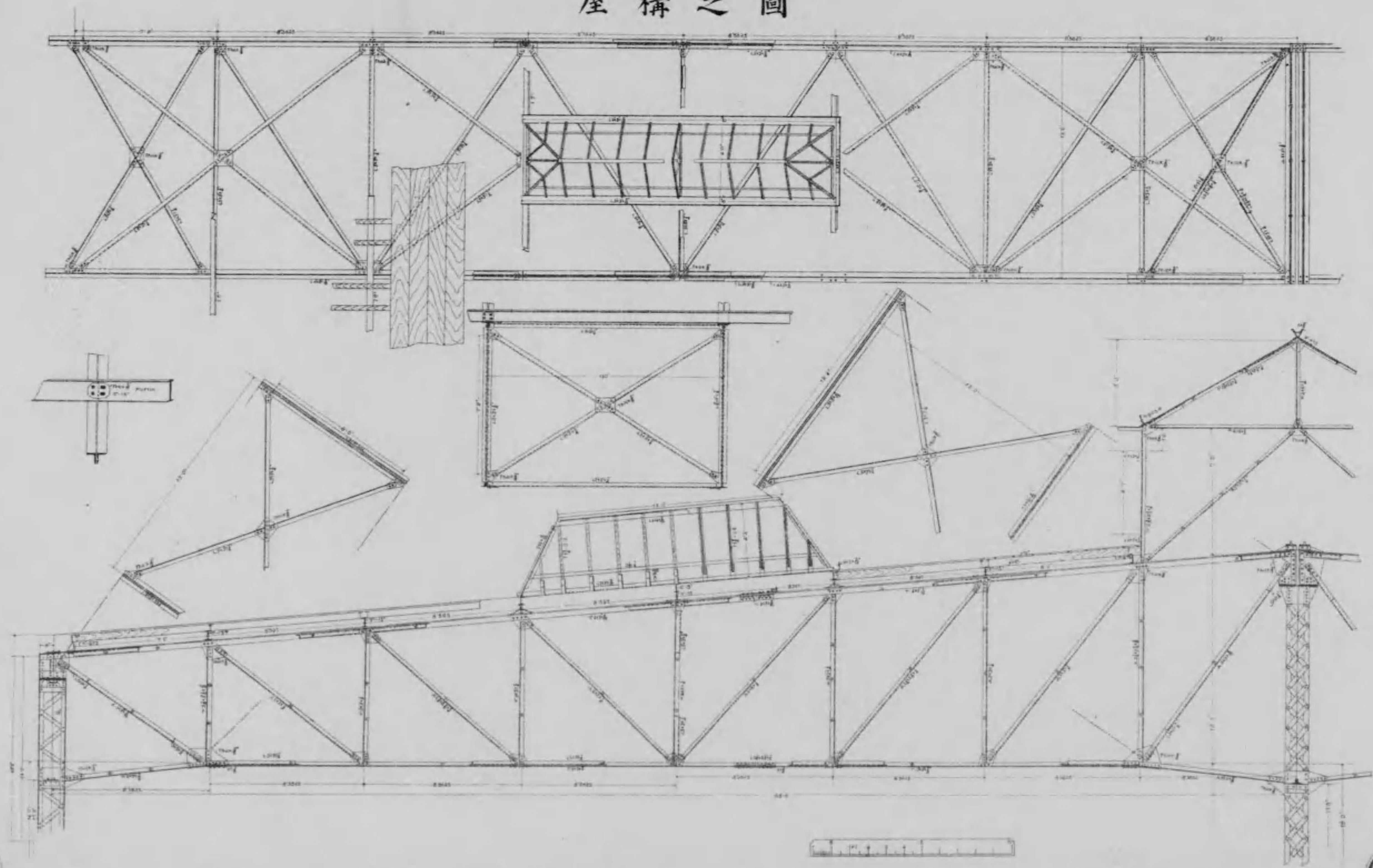

濾過場鉄骨圖(其二)

第二十四號

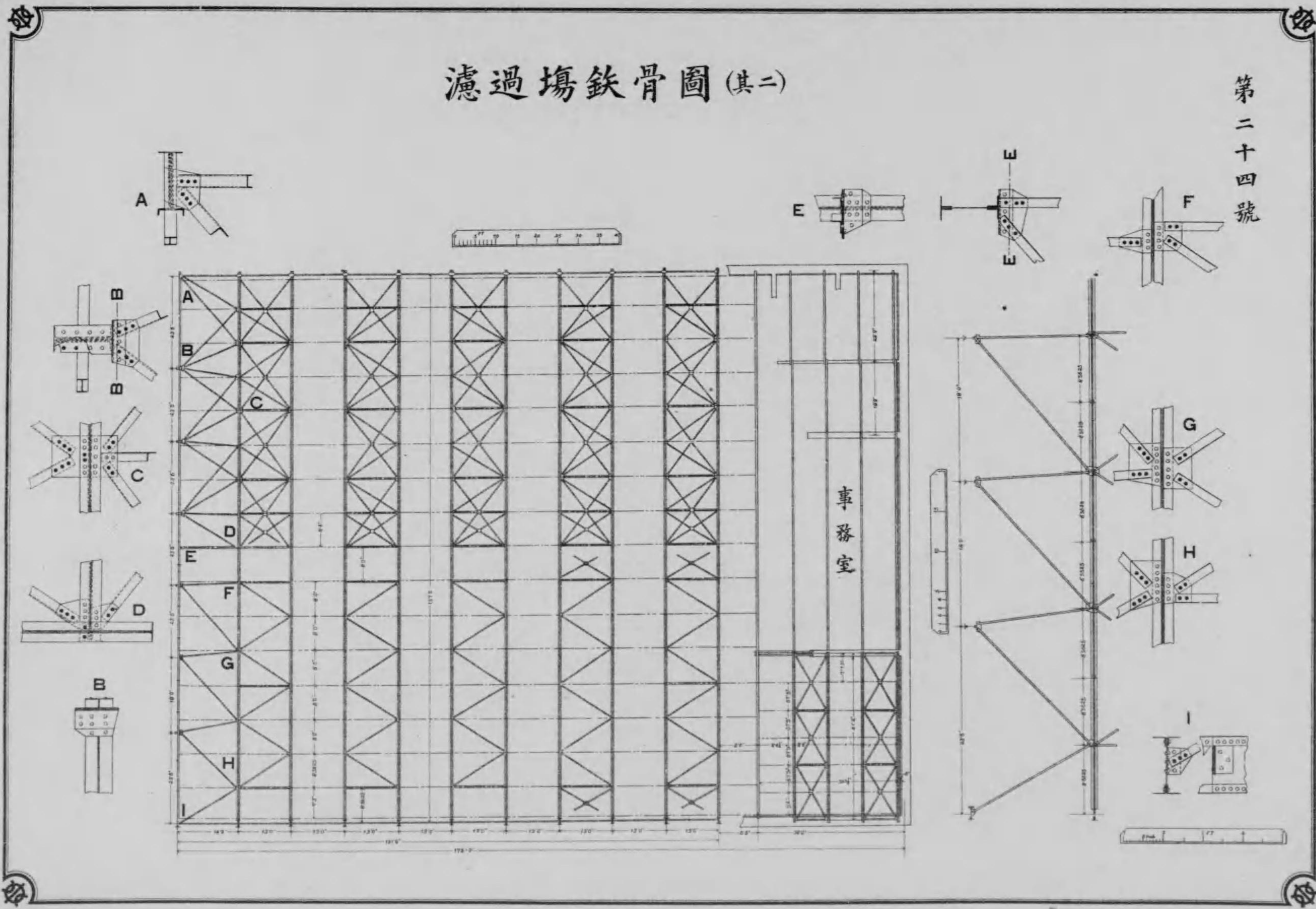

濾過場鉄骨圖(其三)

第二十五號

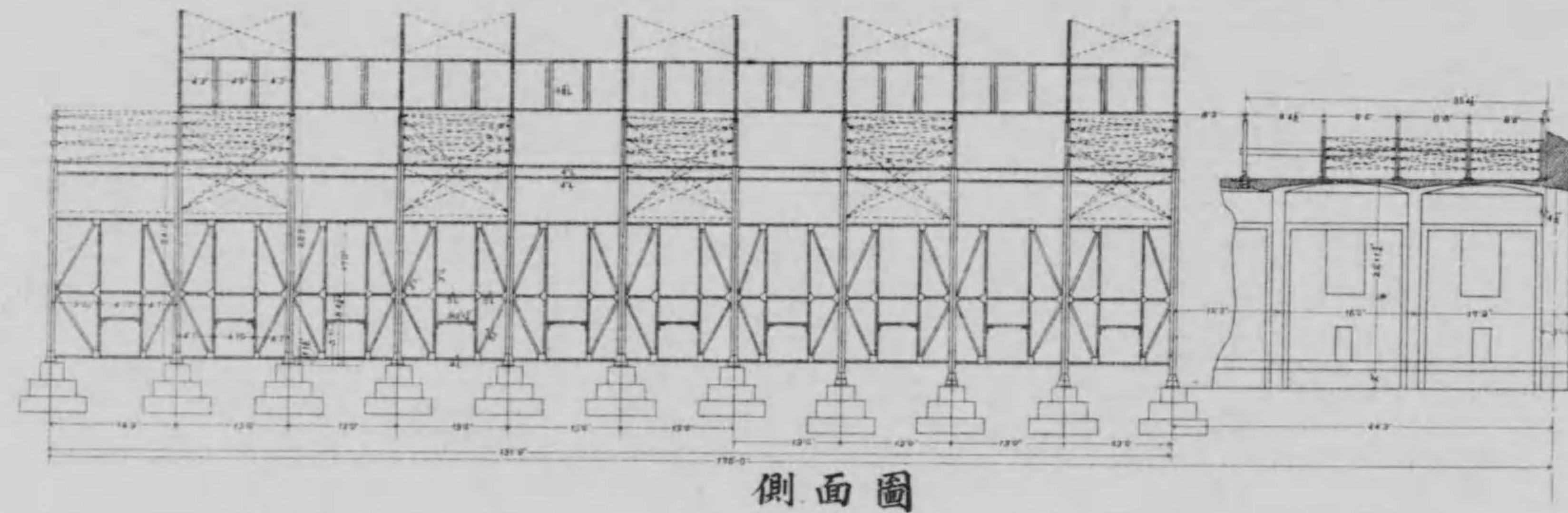

側面圖

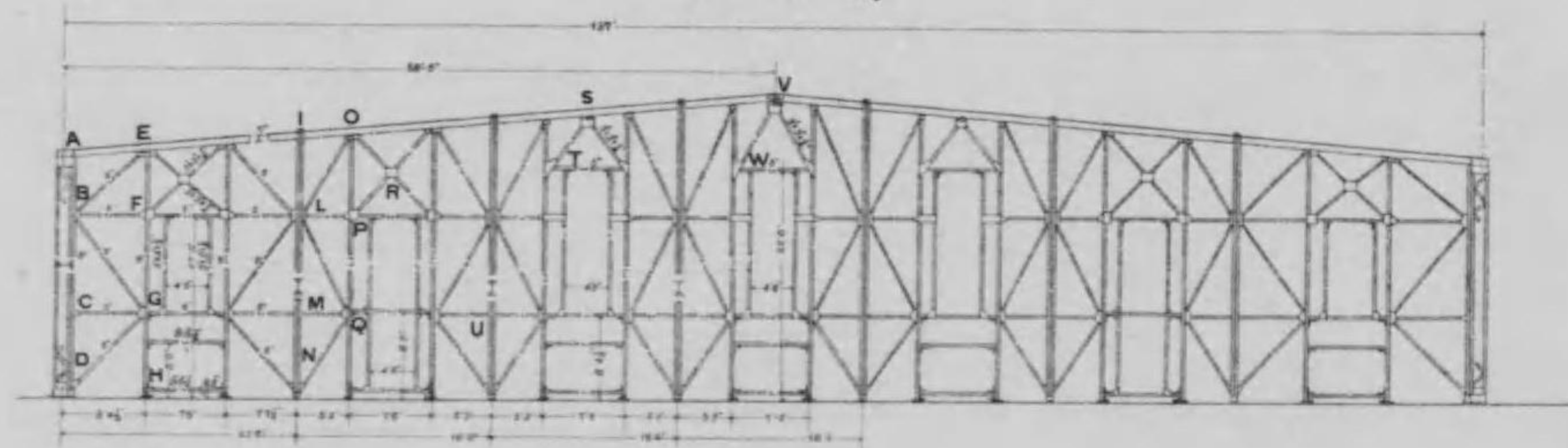

正面圖



濾過場鉄骨圖 (其四)

第二十六號

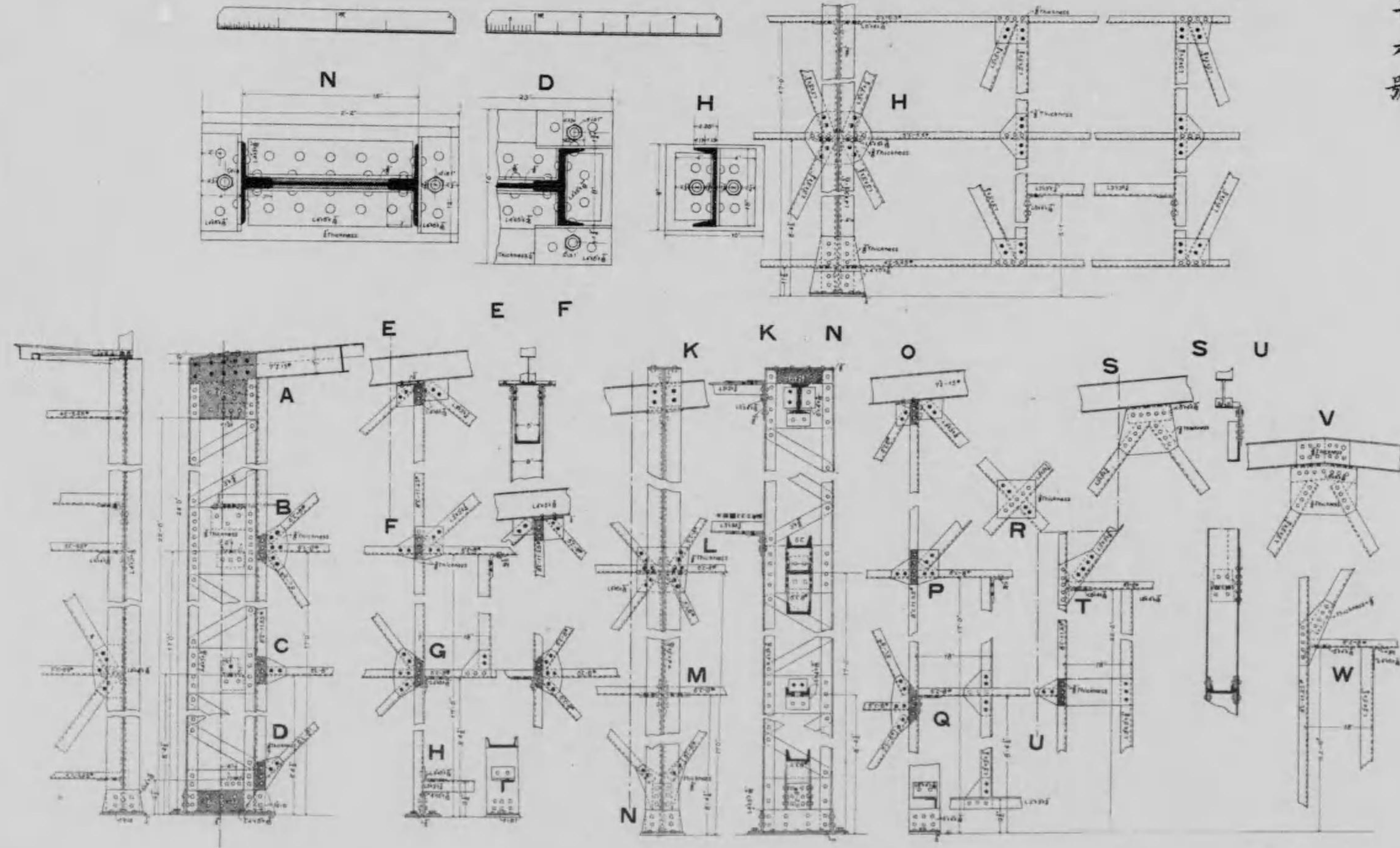

濾過場鉄骨圖 (其五)

中央柱圖

側柱圖

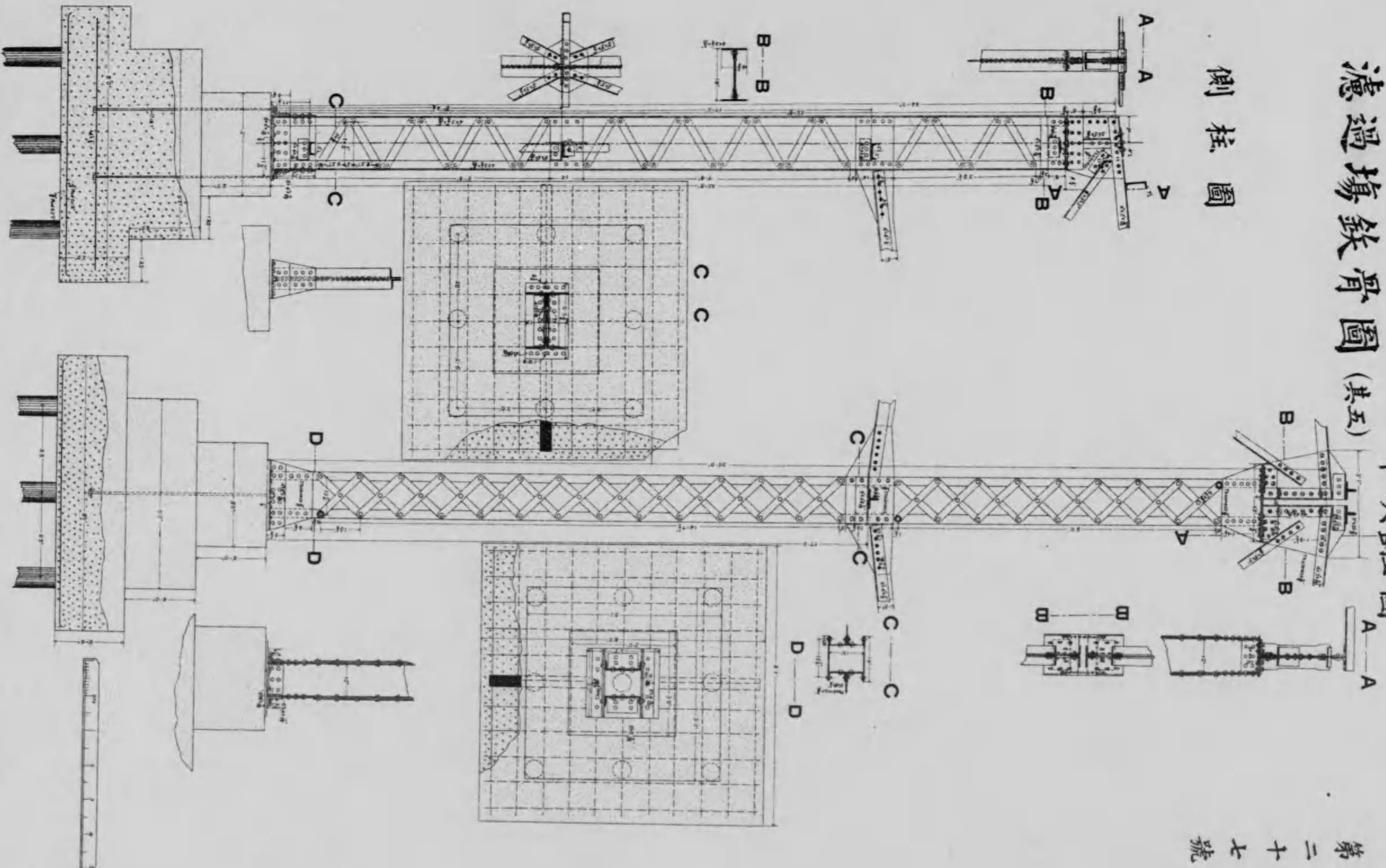

濾過場鉄骨圖 (其六)

第二十八號

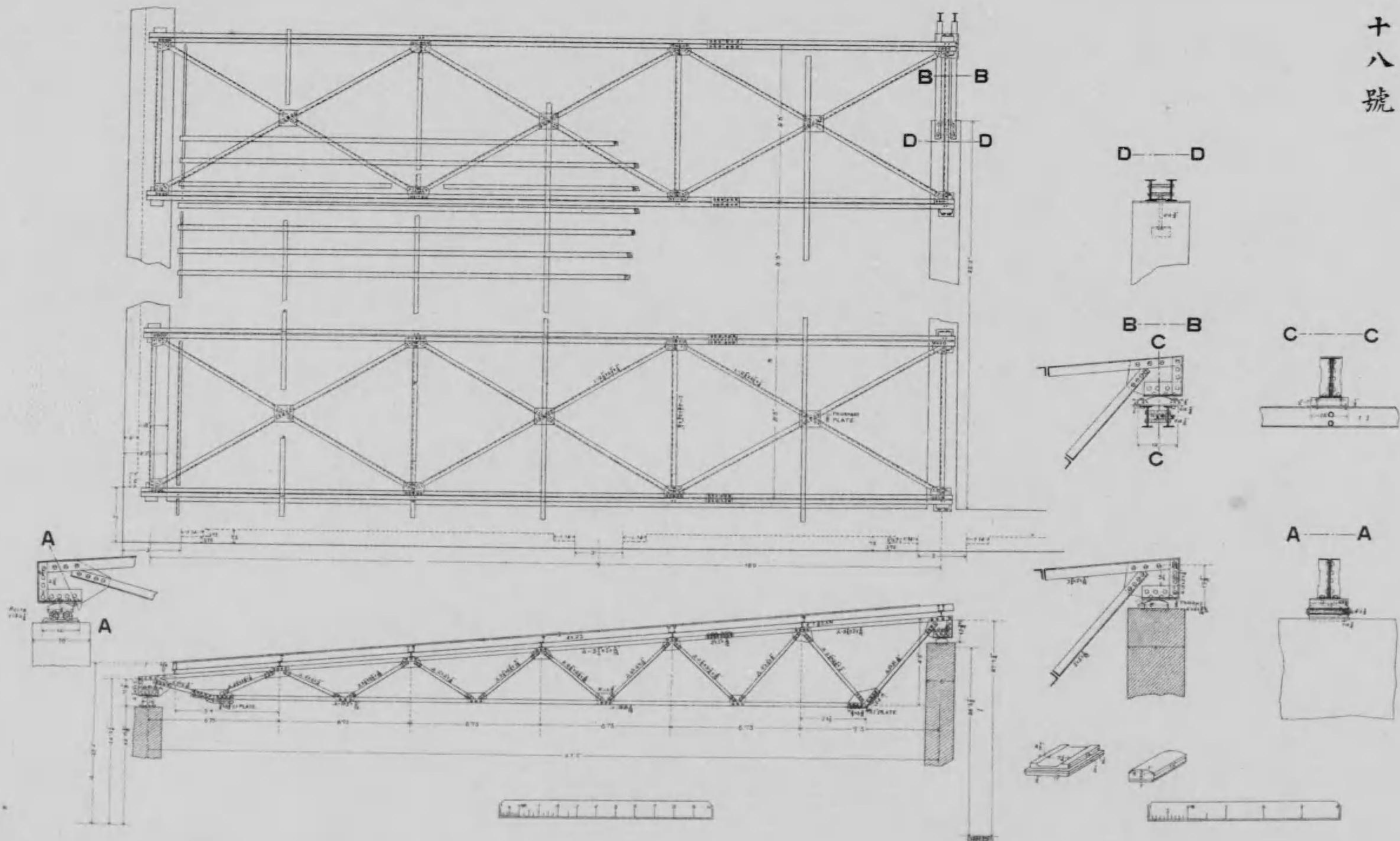

急速濾過裝置圖 (其二)

第三十號

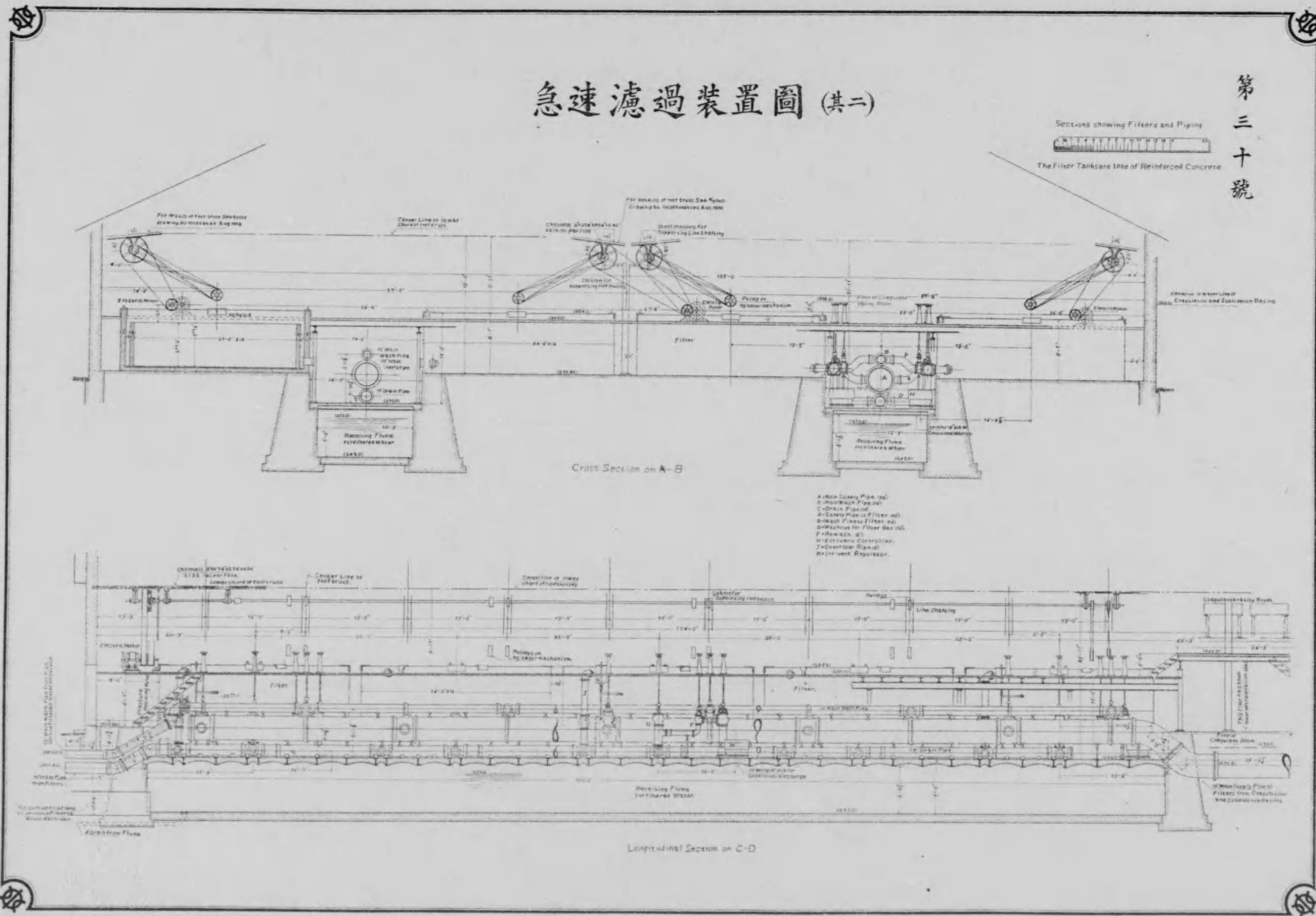

急速濾過裝置圖 (其三)

第三十一號

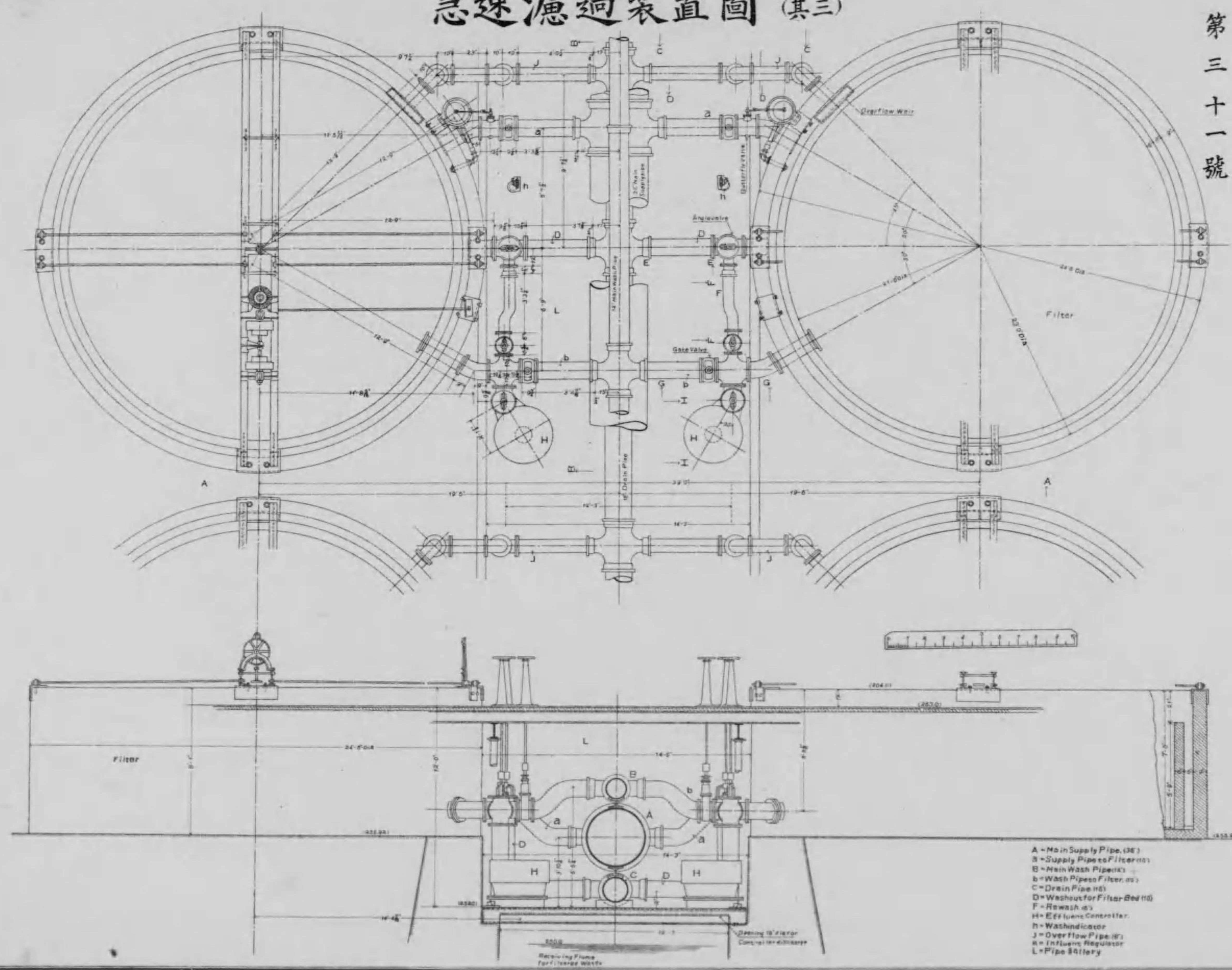

- A - Main Supply Pipe (36")
- B - Supply Pipe to Filter (12")
- b - Main Wash Pipe (12")
- c - Wash Pipes Filter (12")
- d - Drain Pipe (12")
- D - Washout for Filter Bed (12")
- F - Rowash (12")
- H - Effluent Controller
- h - Wash Indicator
- J - Over flow Pipe (12")
- K - Influent Regulator
- L - Pipe Sill (12")

急速濾過裝置圖 (其四)

第三十二號

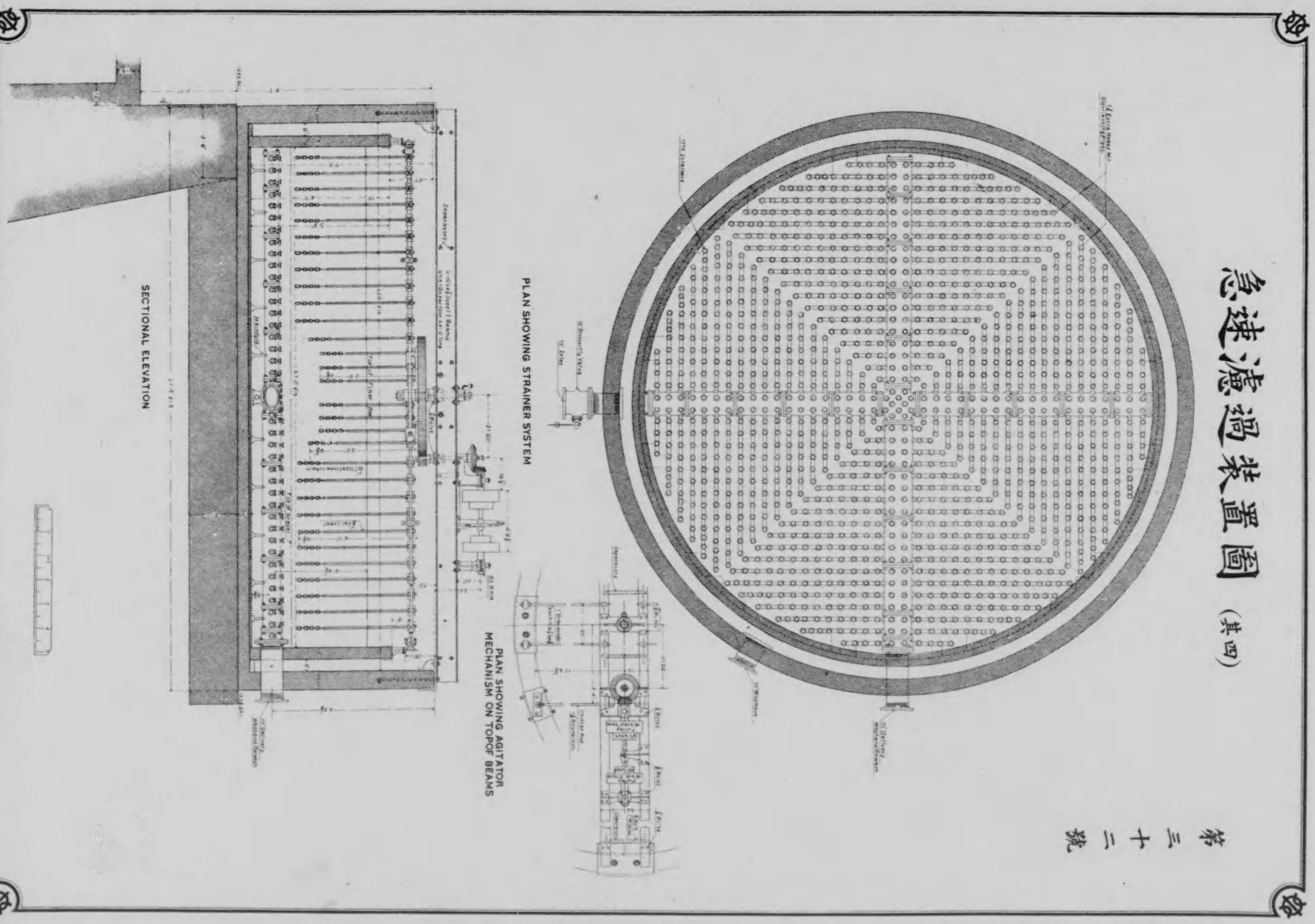

急速濾過裝置圖 (其六)

第三十四號

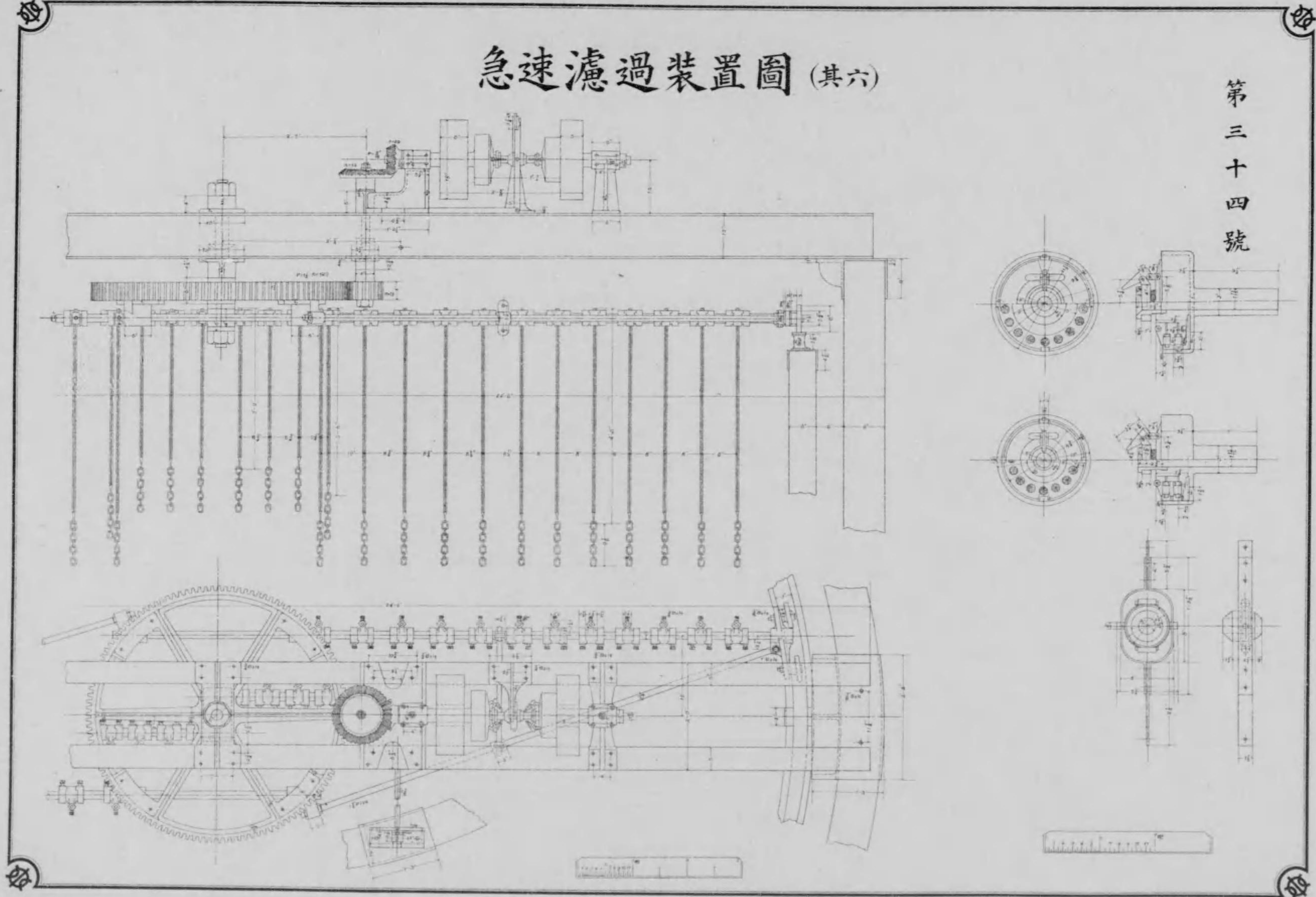

急速濾過裝置圖 (其七)

第三十五號

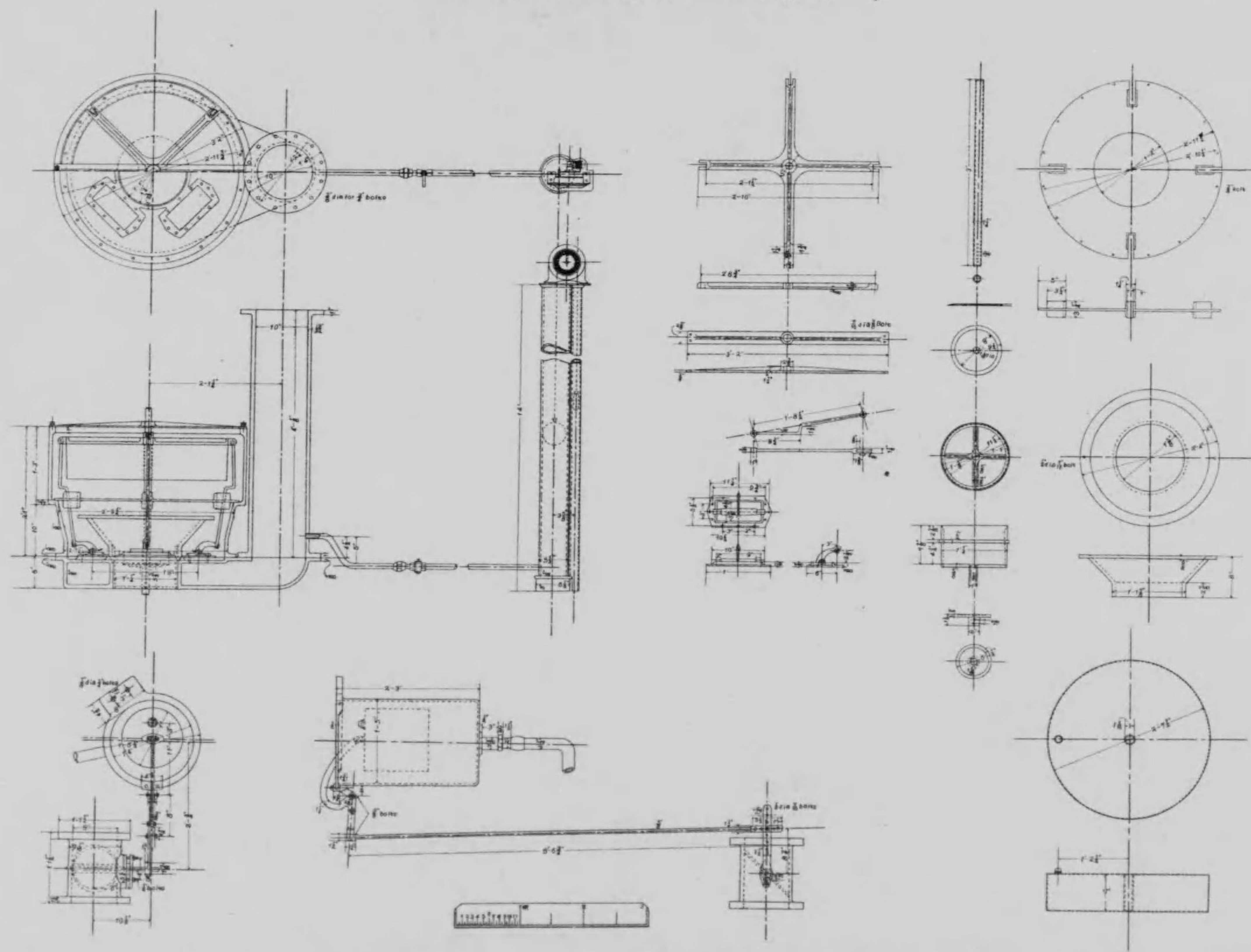

濾過槽構造圖

第三十六號

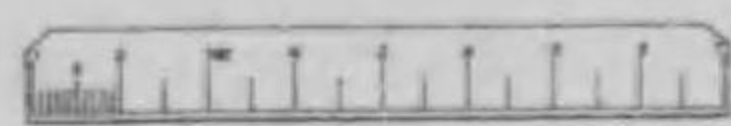
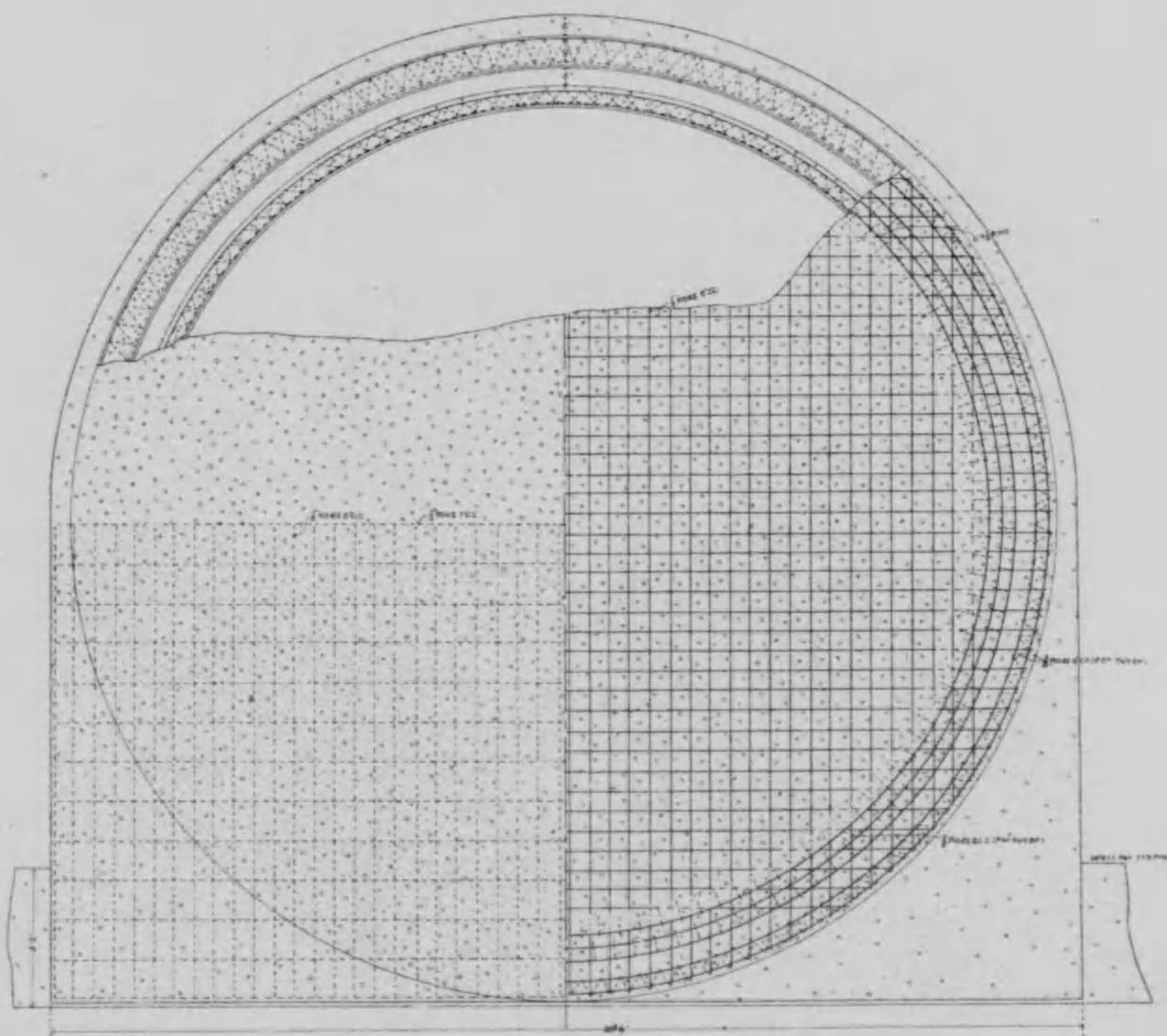
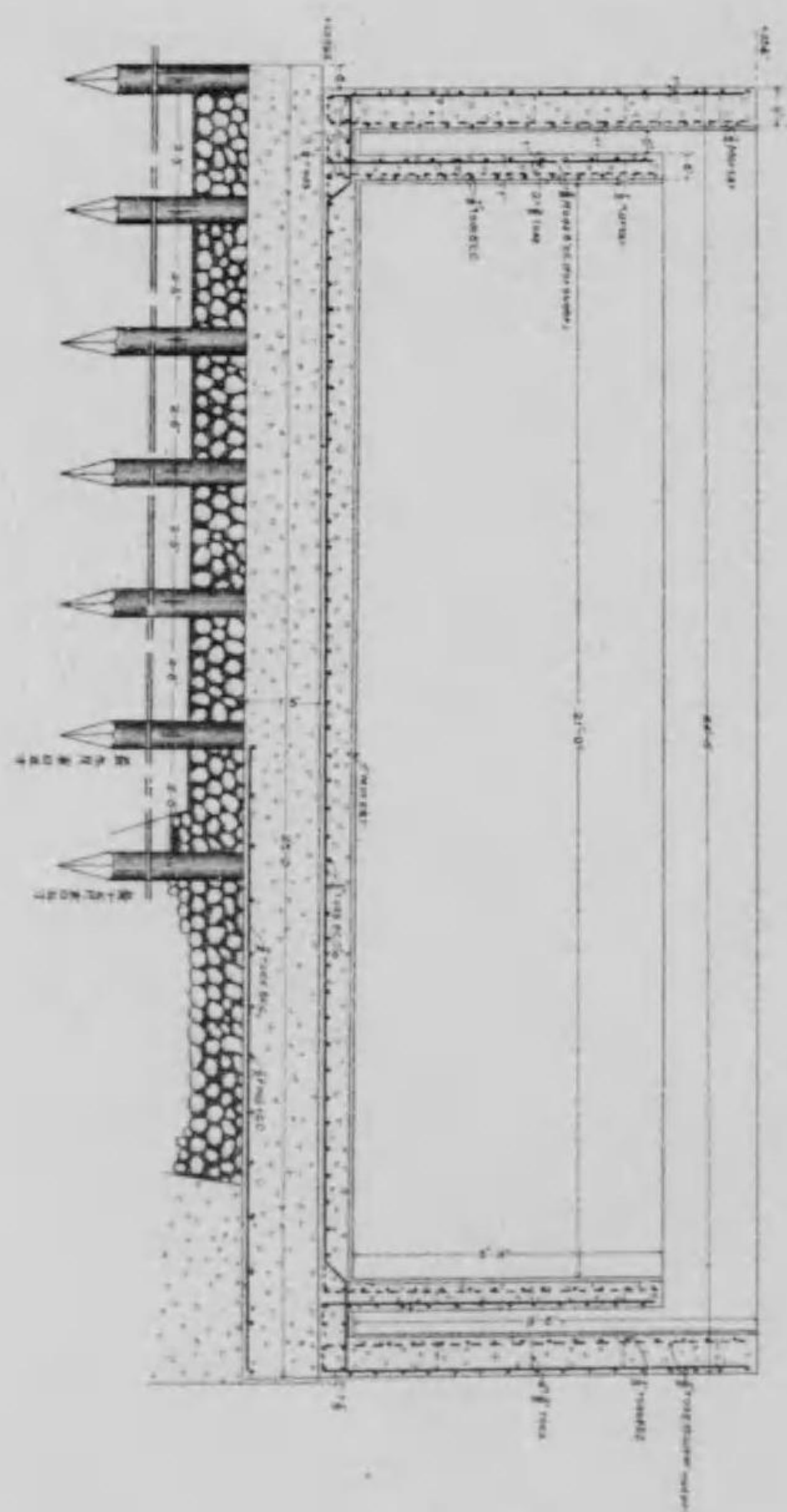

濾過槽造型圖

第三十七號

SECTIONAL PLAN

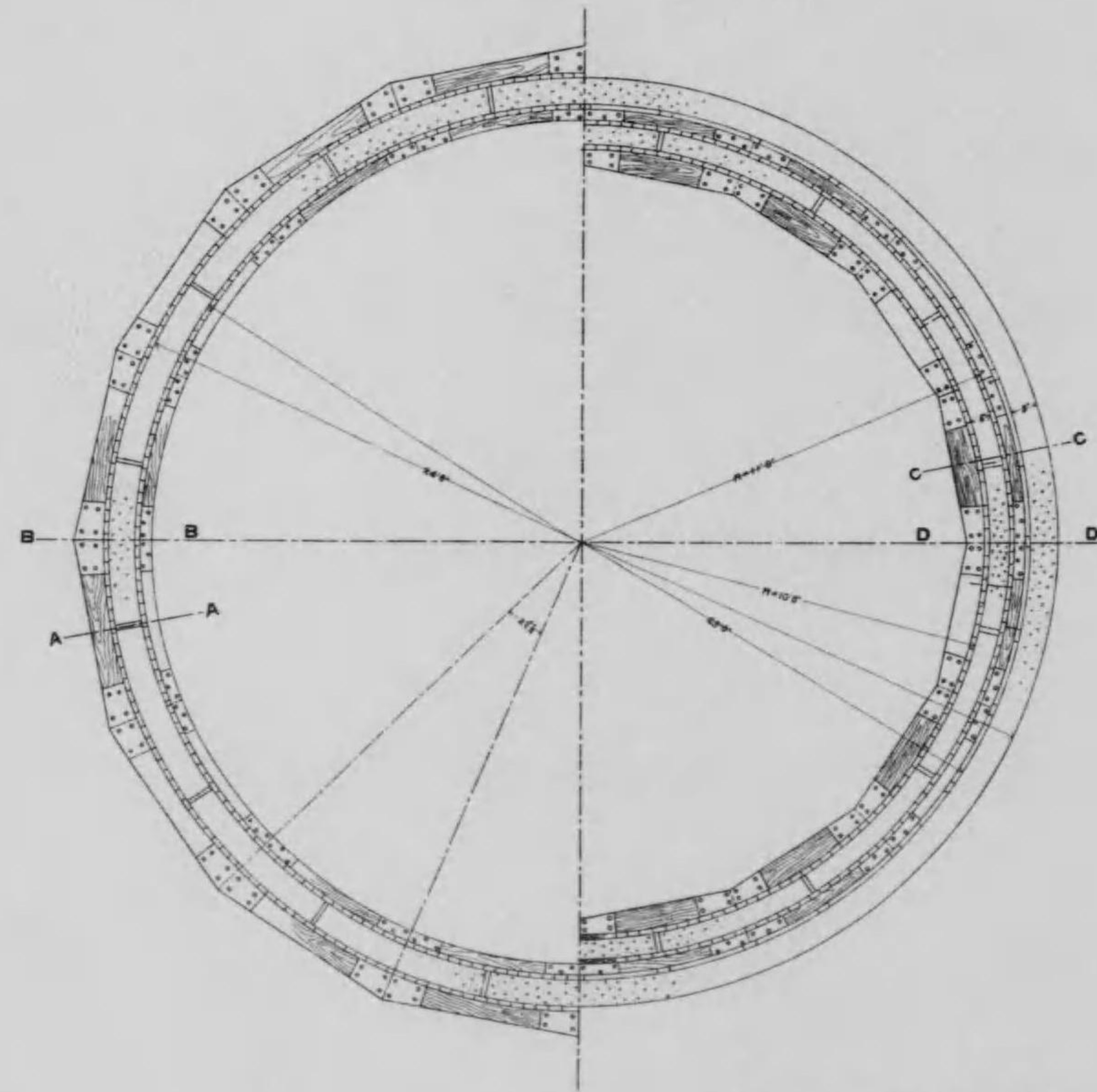

SECTIONAL ELEVATION

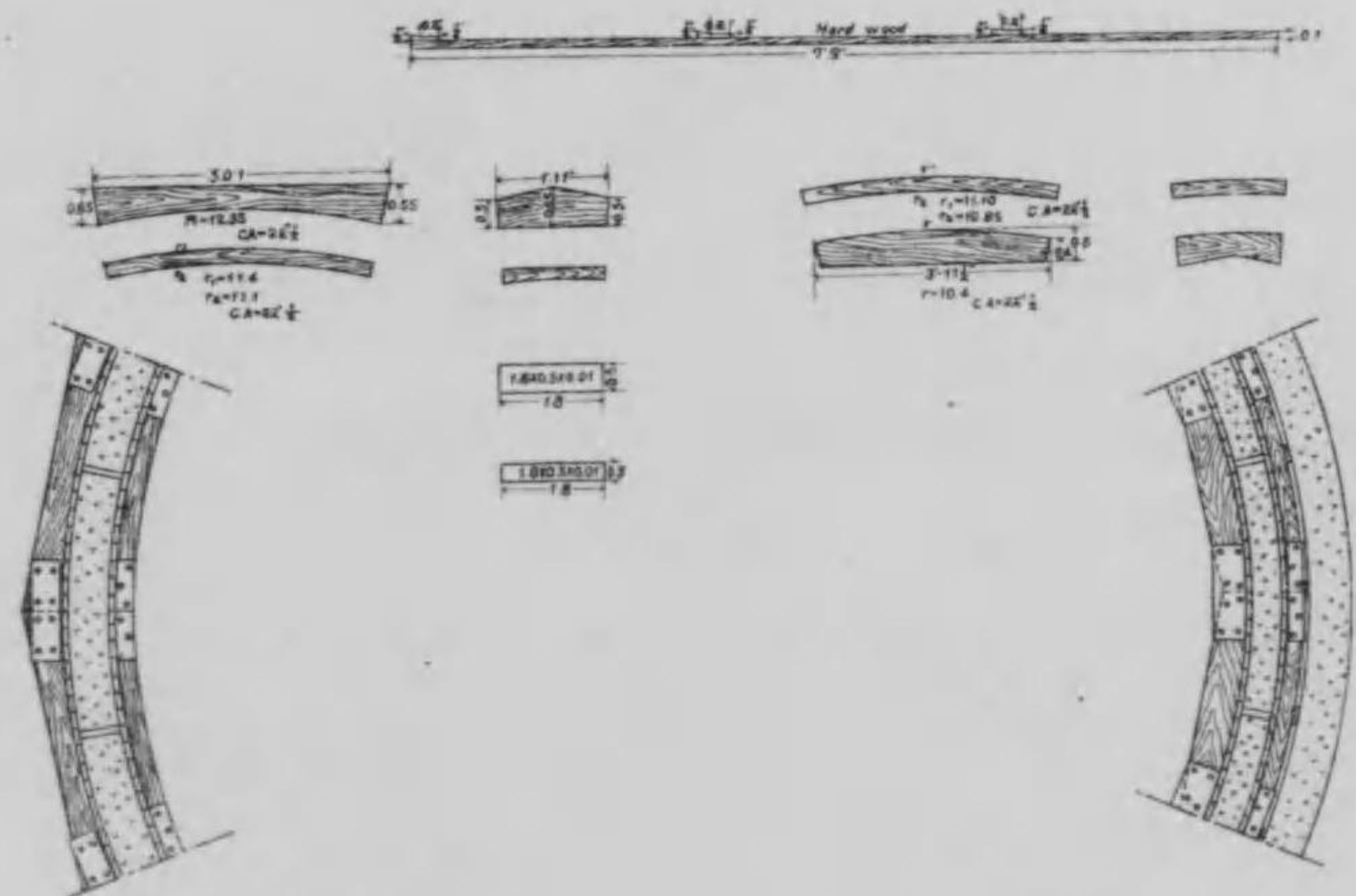
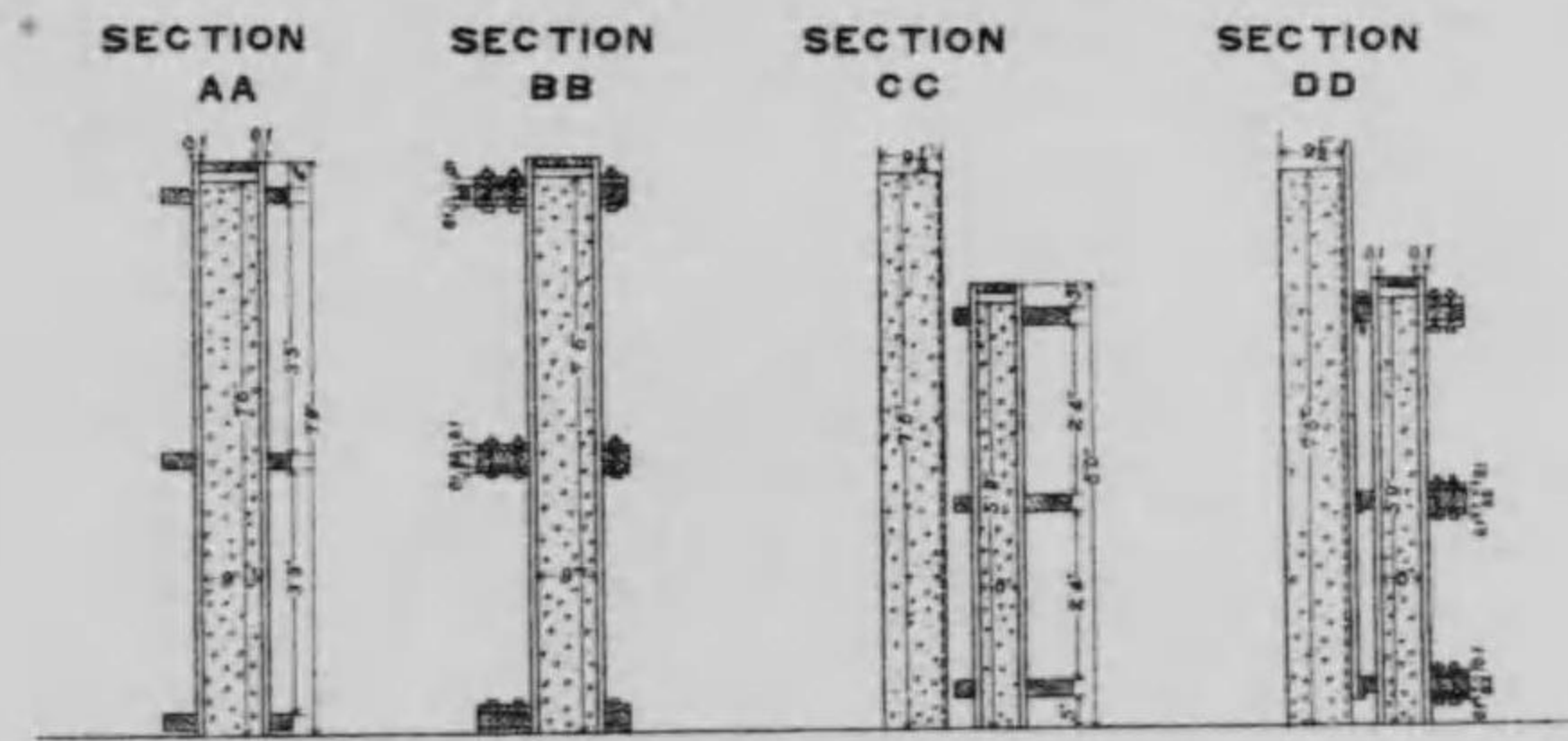

導水溝構造圖

第三十八號

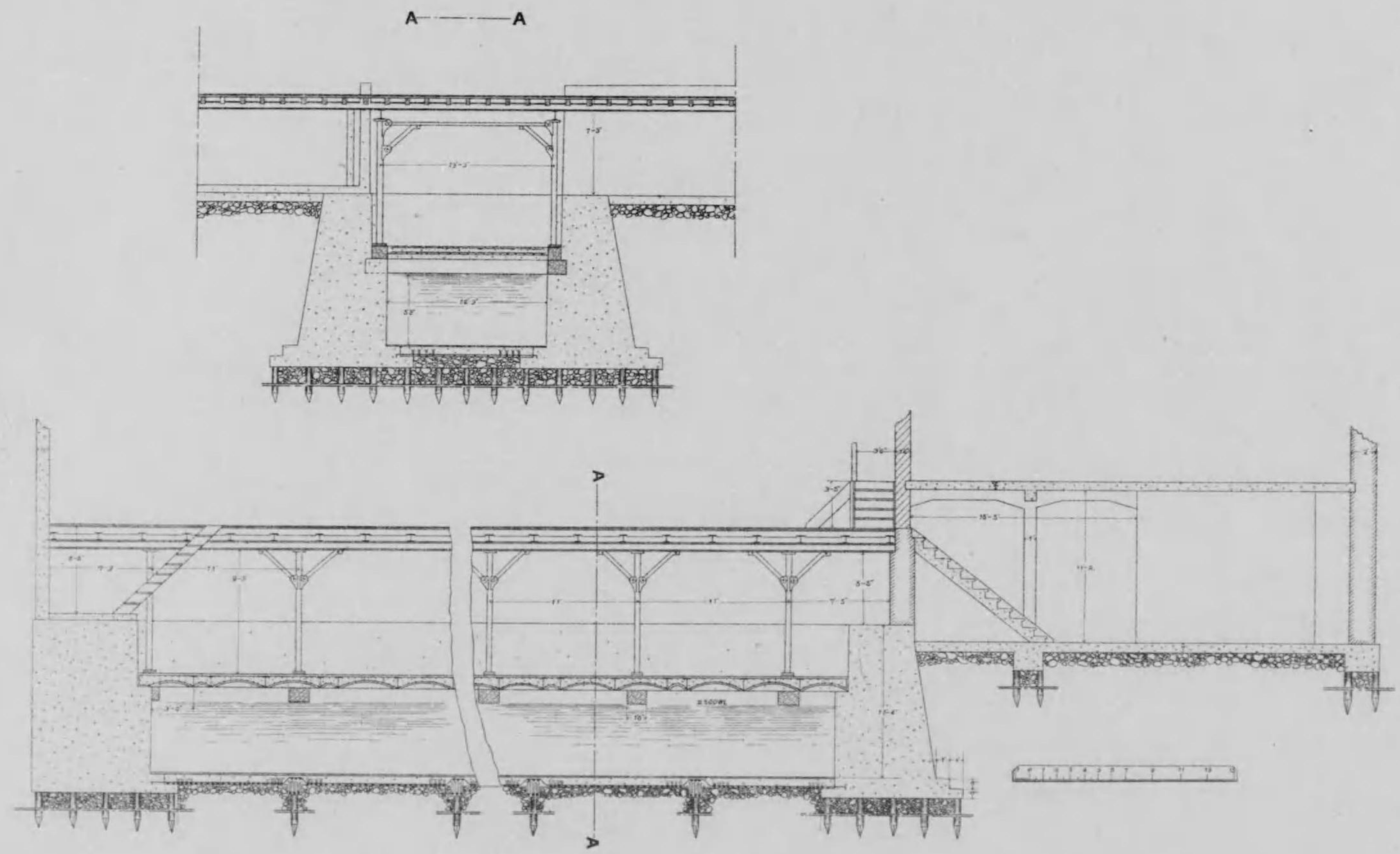

硫酸礬土溶液裝置圖 (其一)

第三十九號

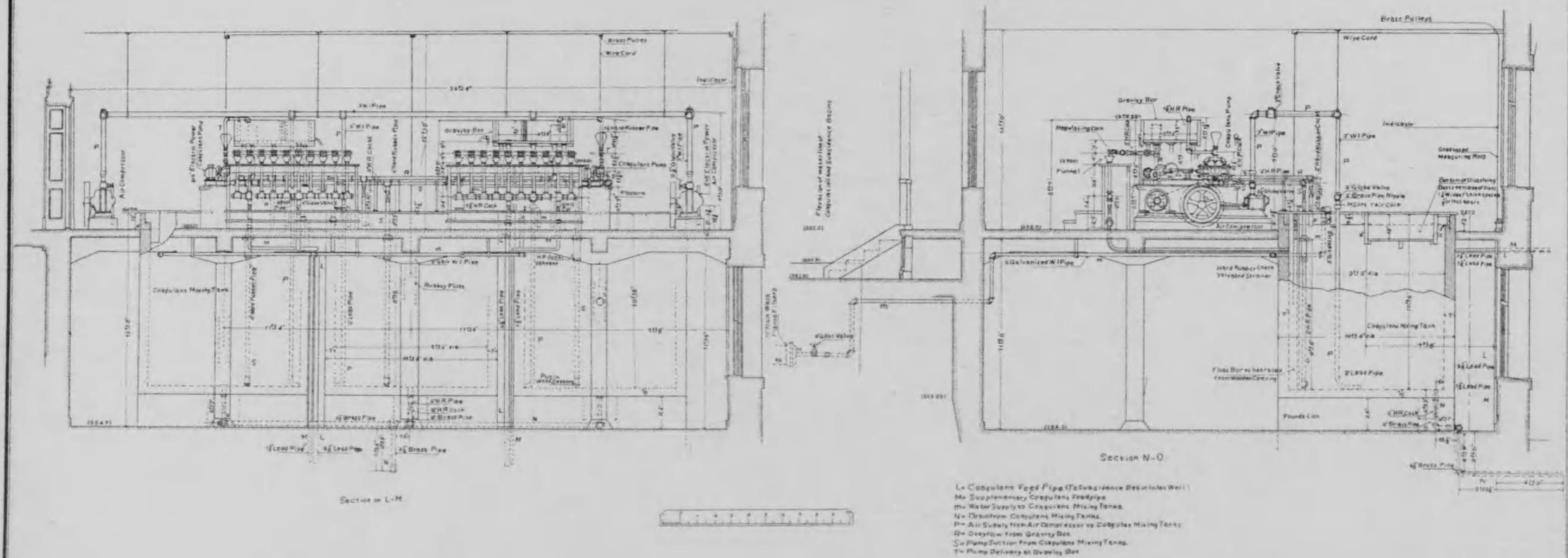

硫酸礬土溶液裝置圖 (其二)

第四十號

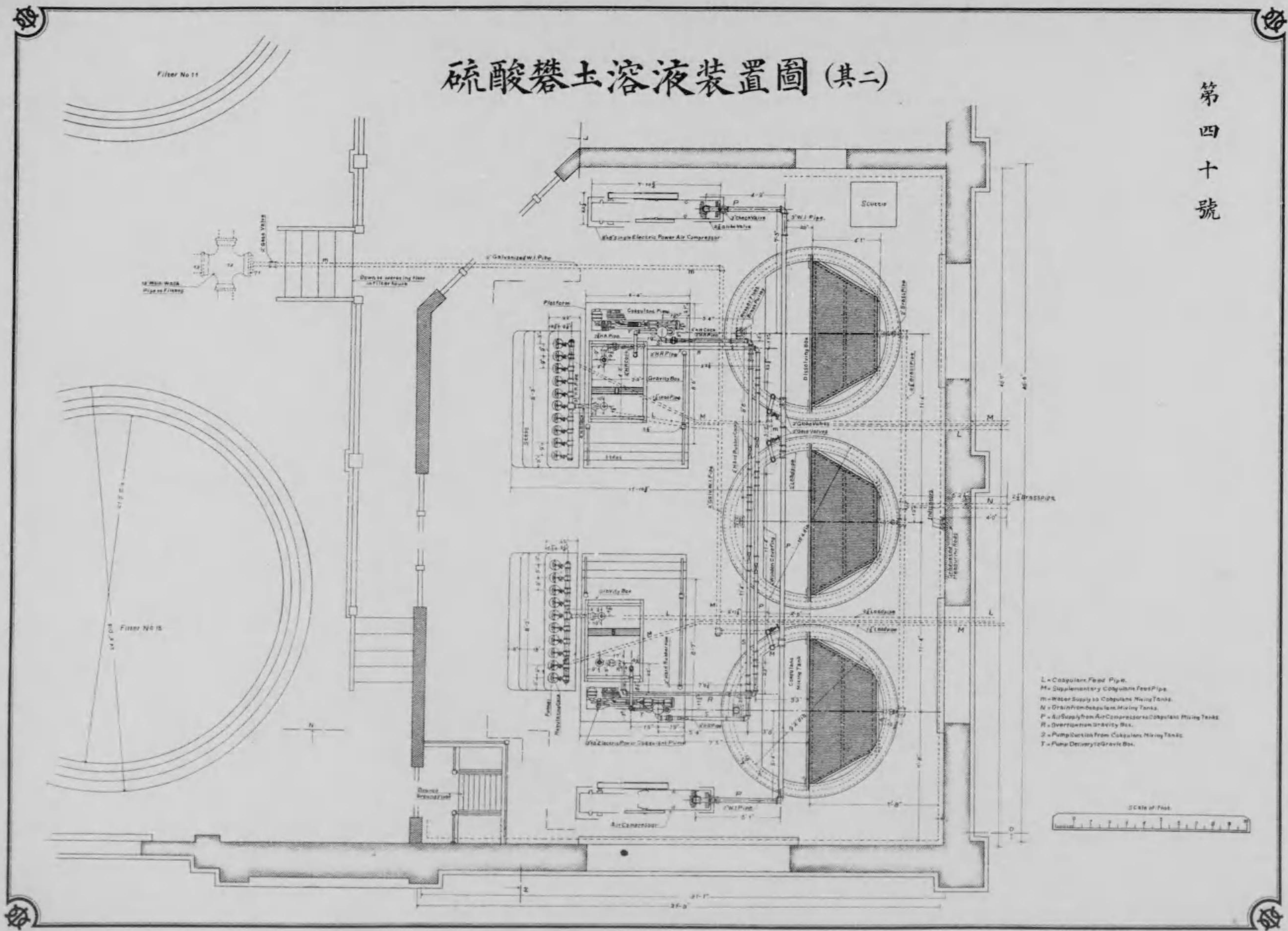

- L = Coking Pan Feed Pipe
- M = Supplementary Coking Pan Feed Pipe
- N = Water Supply to Coking Pan Mixing Tanks
- P = Air Supply from Air Compressor to Coking Pan Mixing Tanks
- R = Overflow from Gravity Box
- S = Pump Discharge from Coking Pan Mixing Tanks
- T = Pump Discharge to Gravity Box

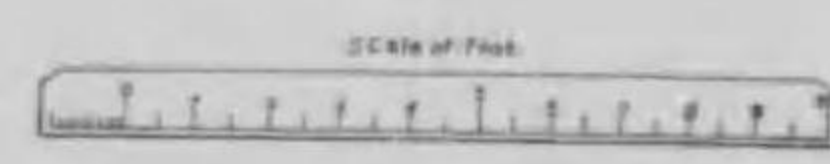

硫酸礬土溶液裝置圖 (其三)

第四十一號

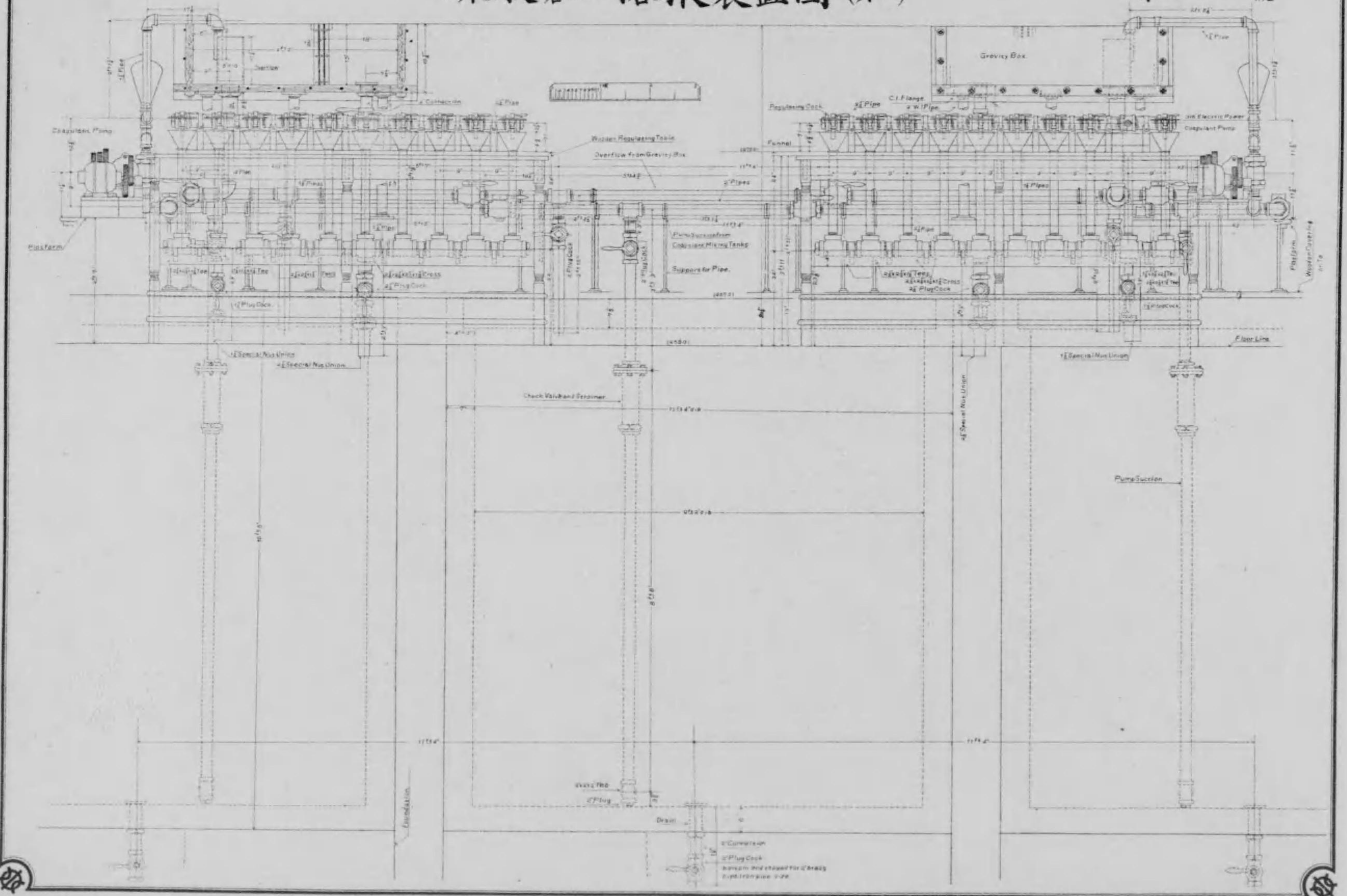

硫酸礬土溶液裝置圖 (其四)

第四十二號

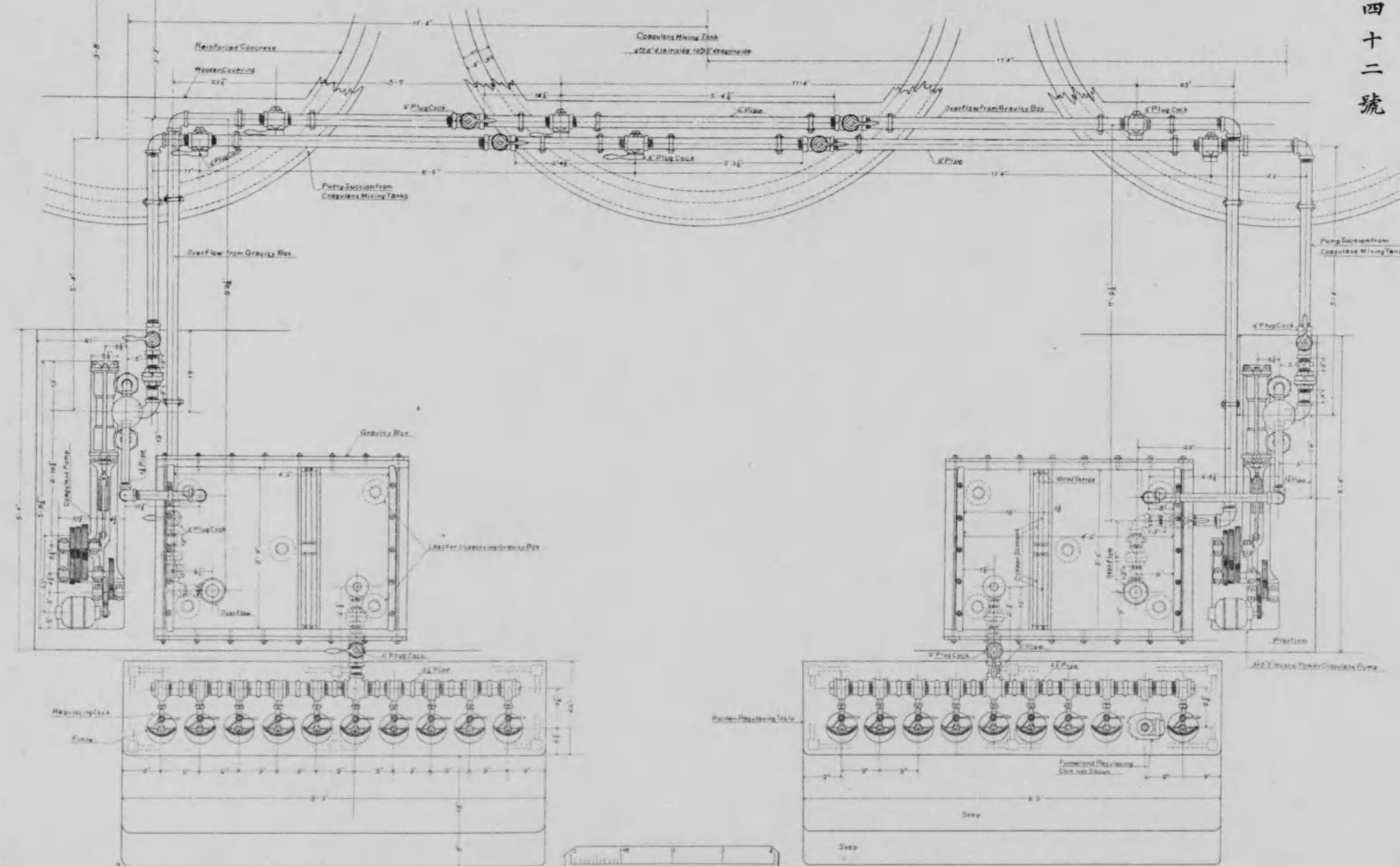

硫酸礬土溶液裝置圖 (其五)

第四十三號

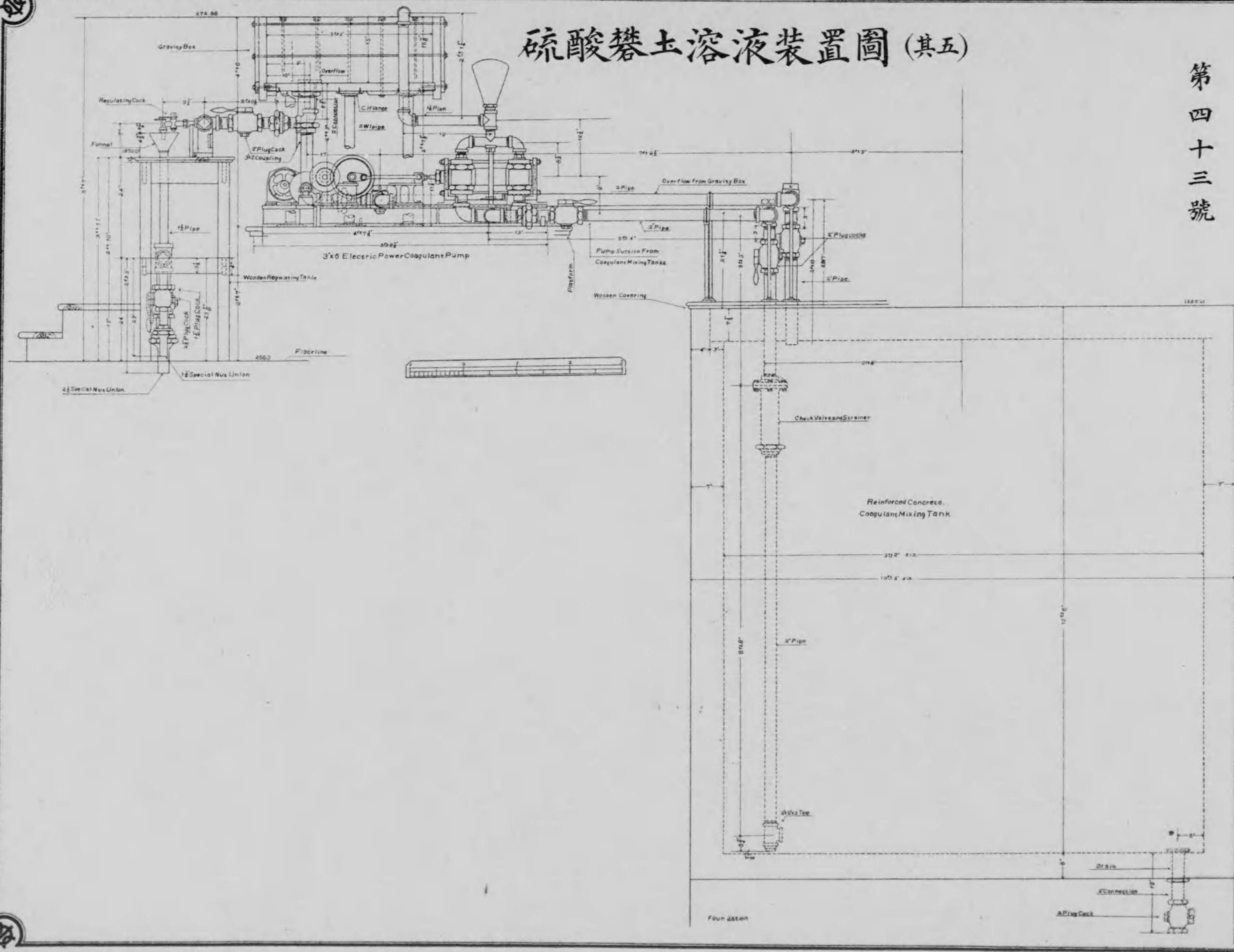

硫酸礬土溶液裝置圖 (其六)

第四十四號

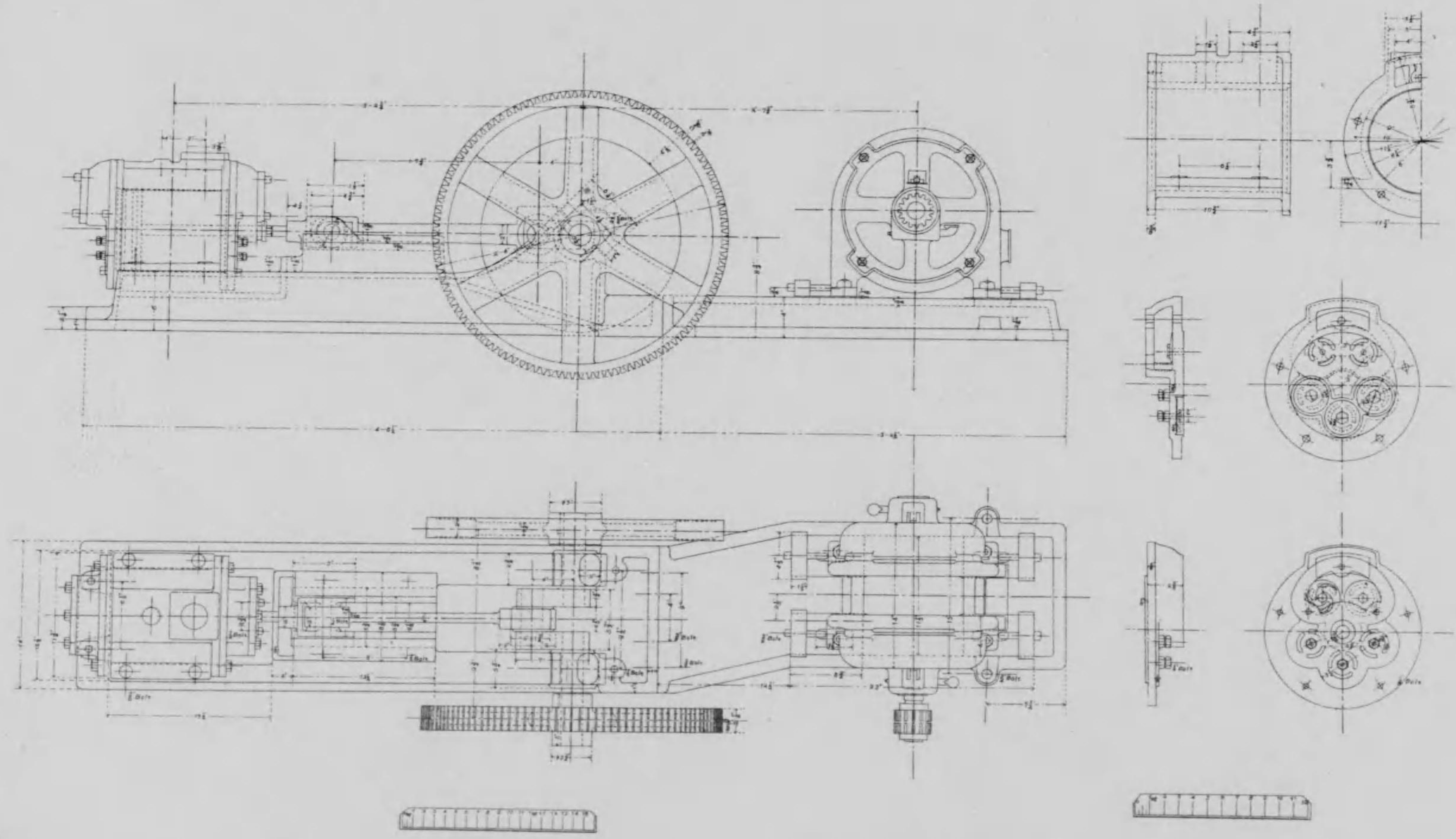

淨水集合井圖

第四十五號

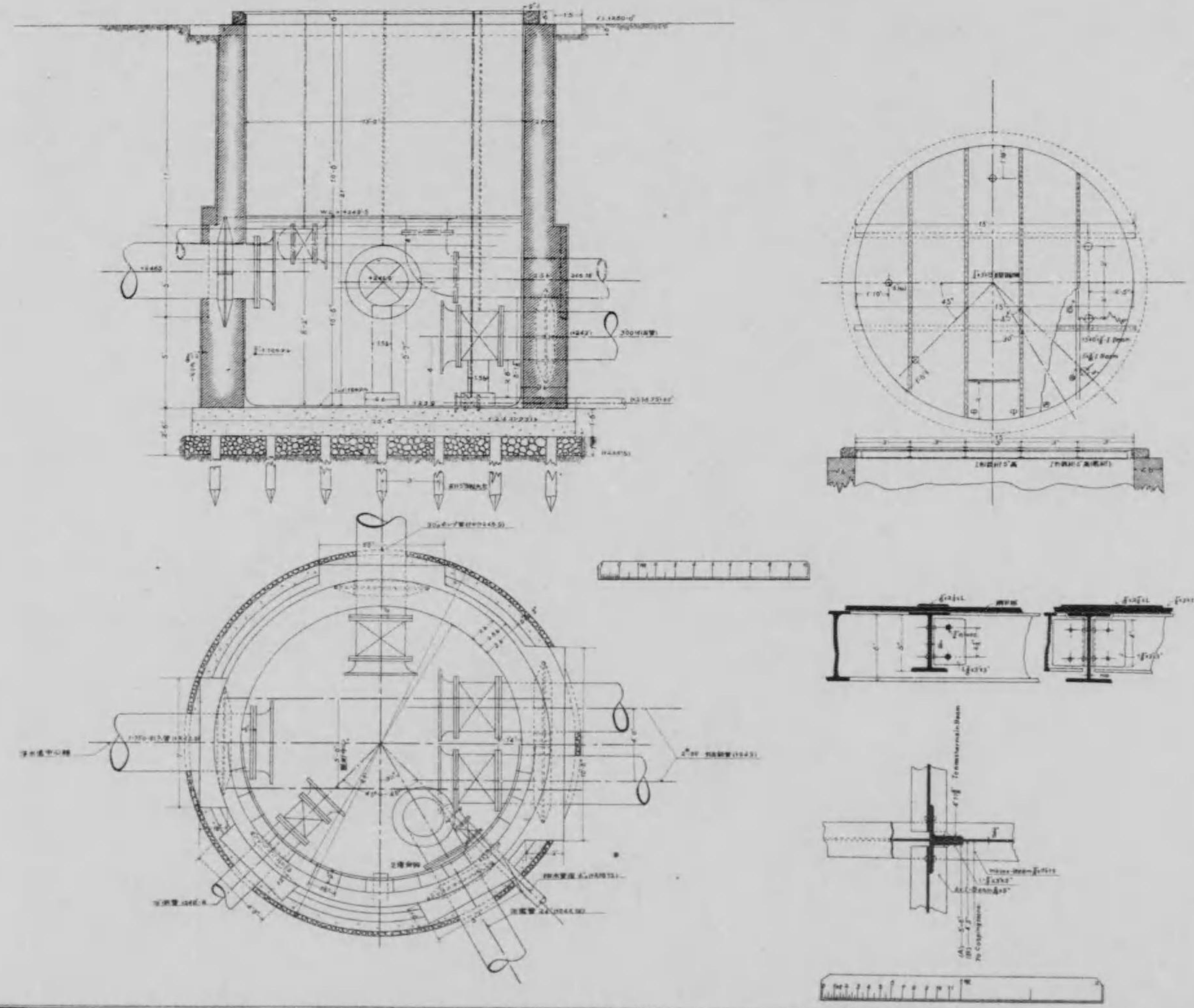

淨水集合井上家圖

第四十六號

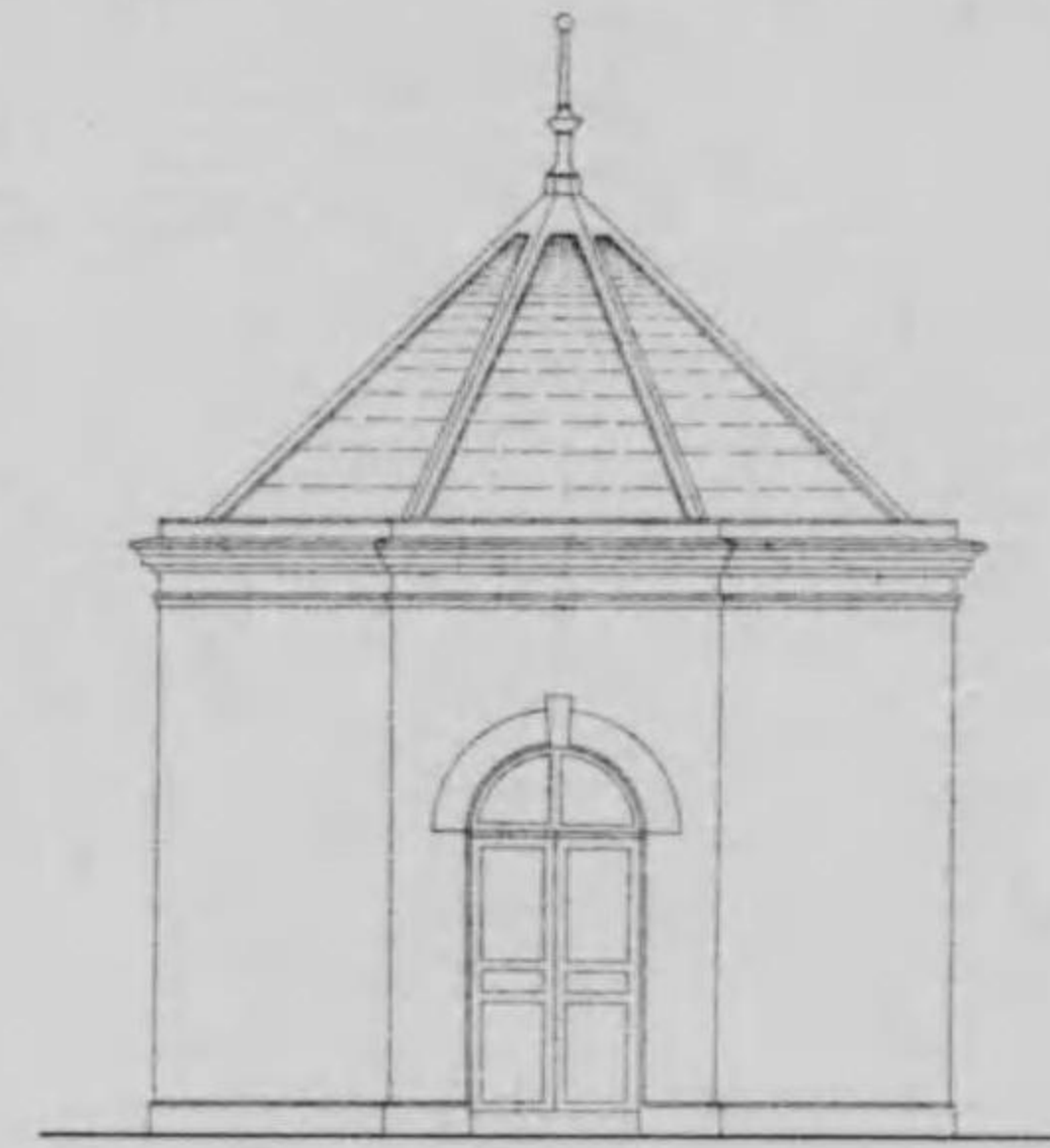

正面圖

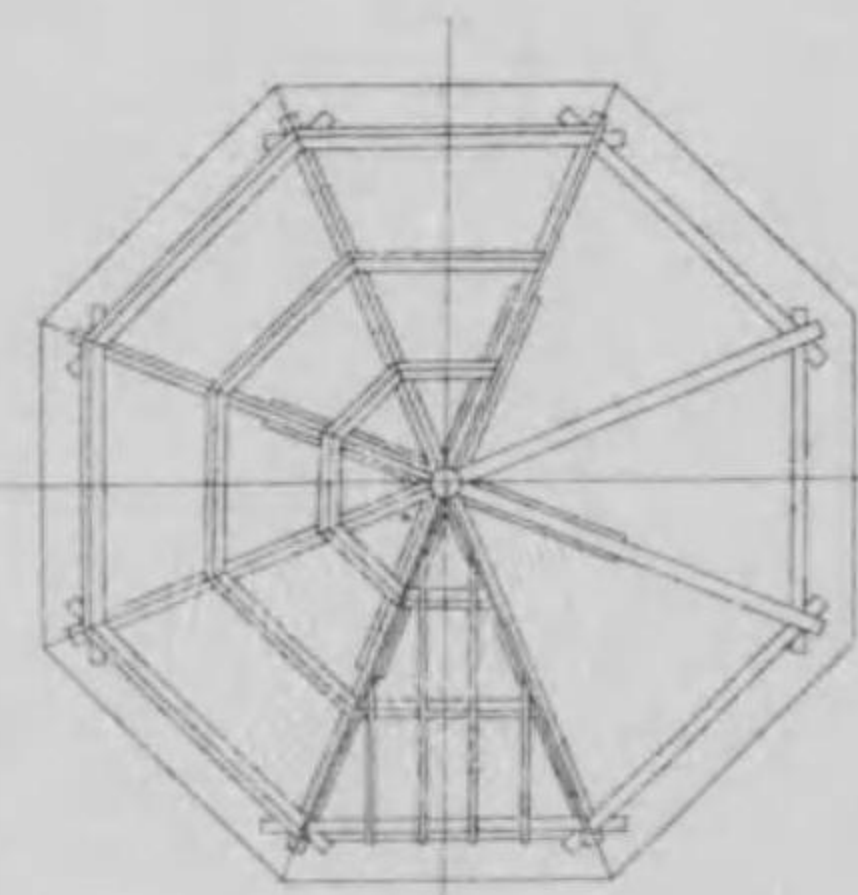

家根平面圖

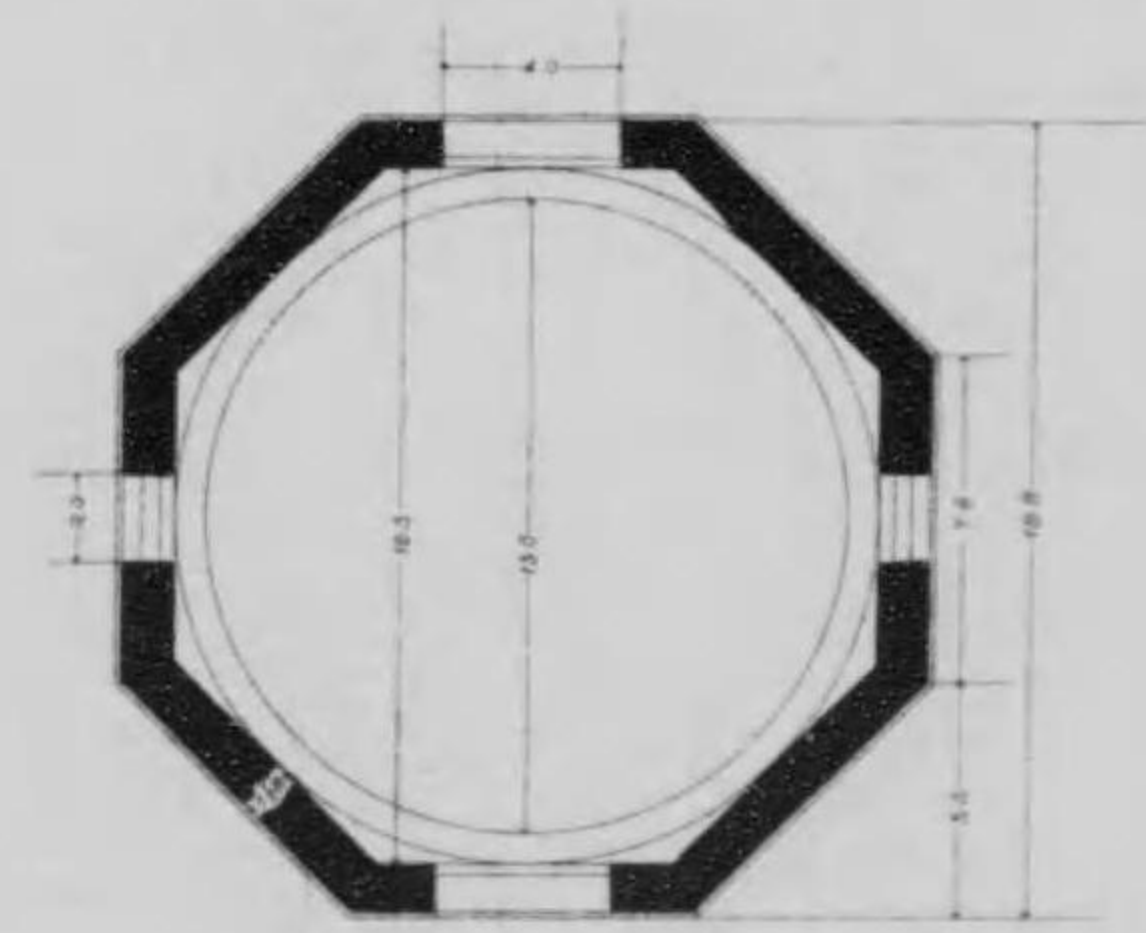

切斷平面圖

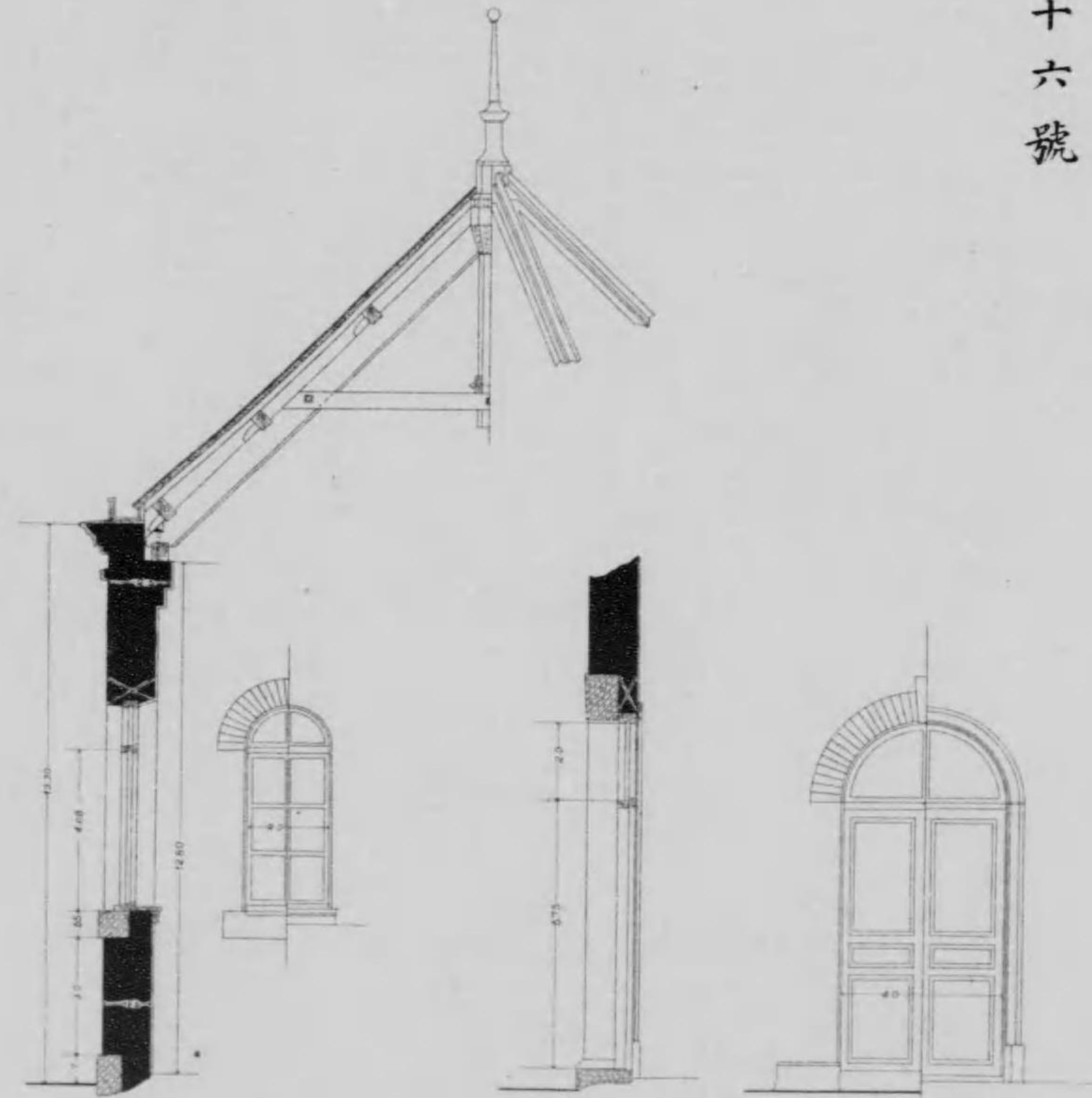

断面圖

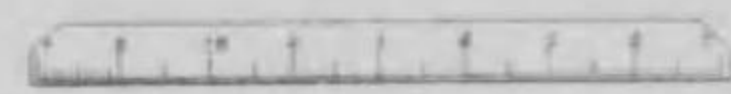

唧筒配置圖

第四十七號

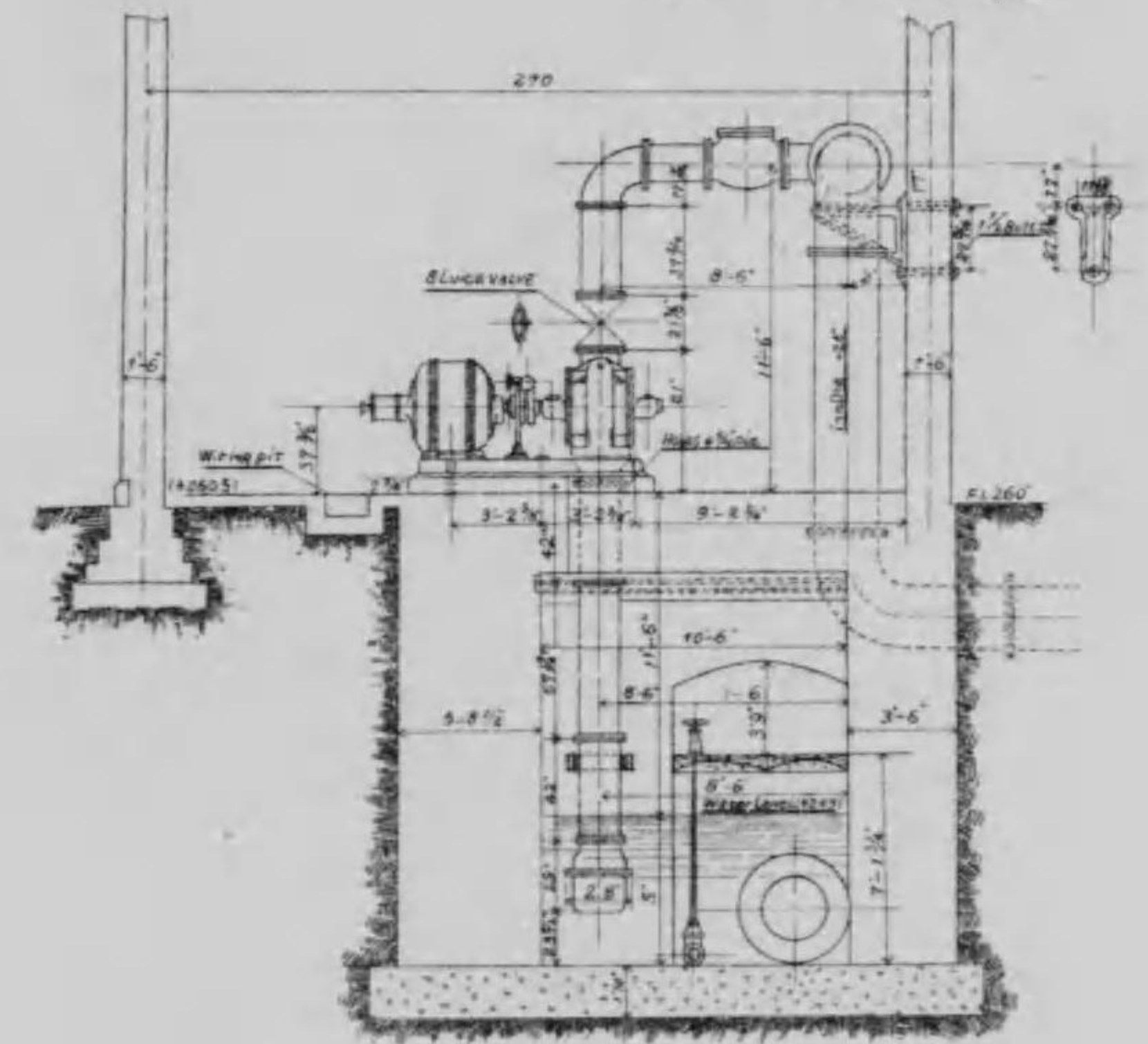
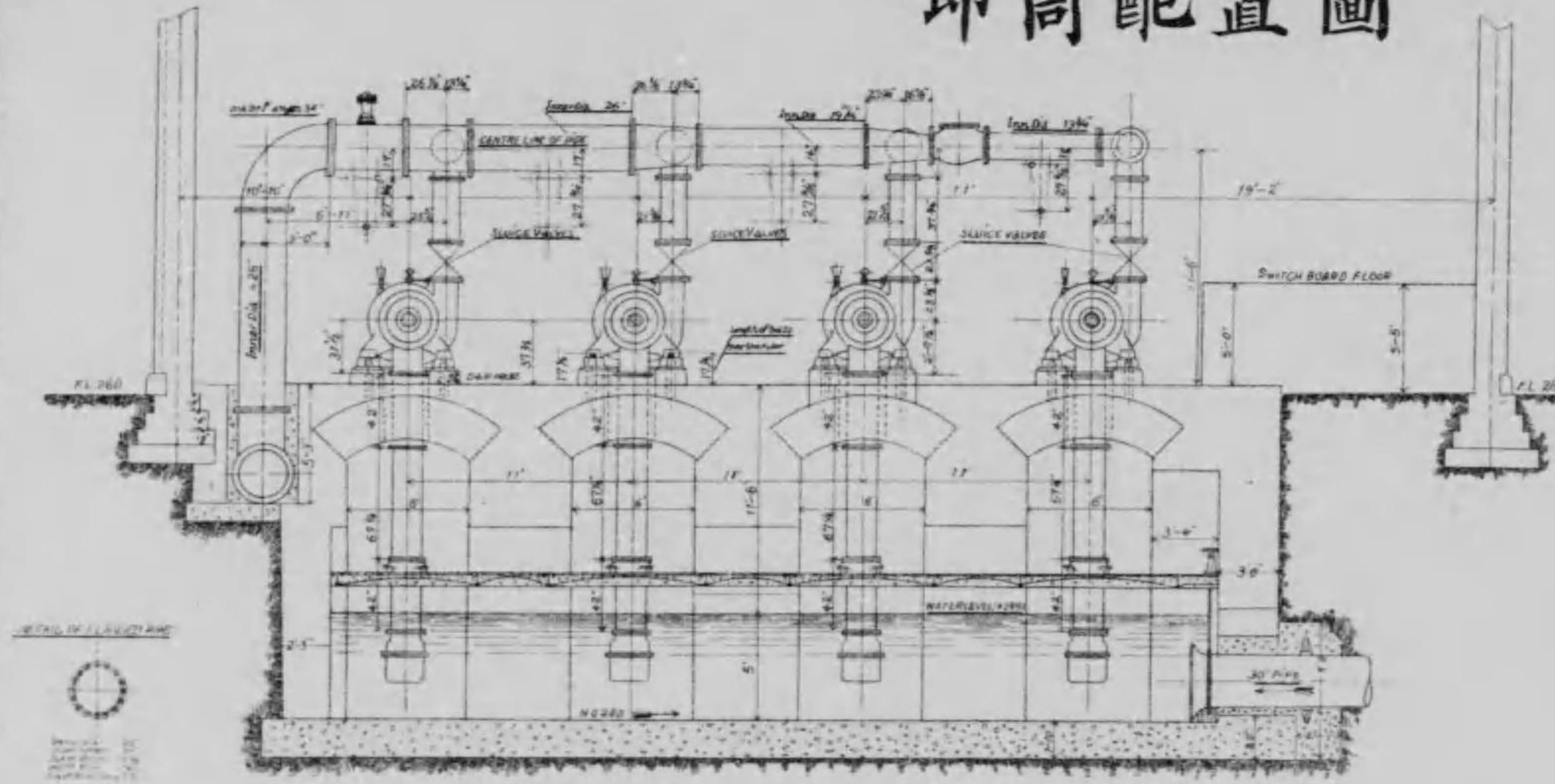

縱斷圖

圖斷橫

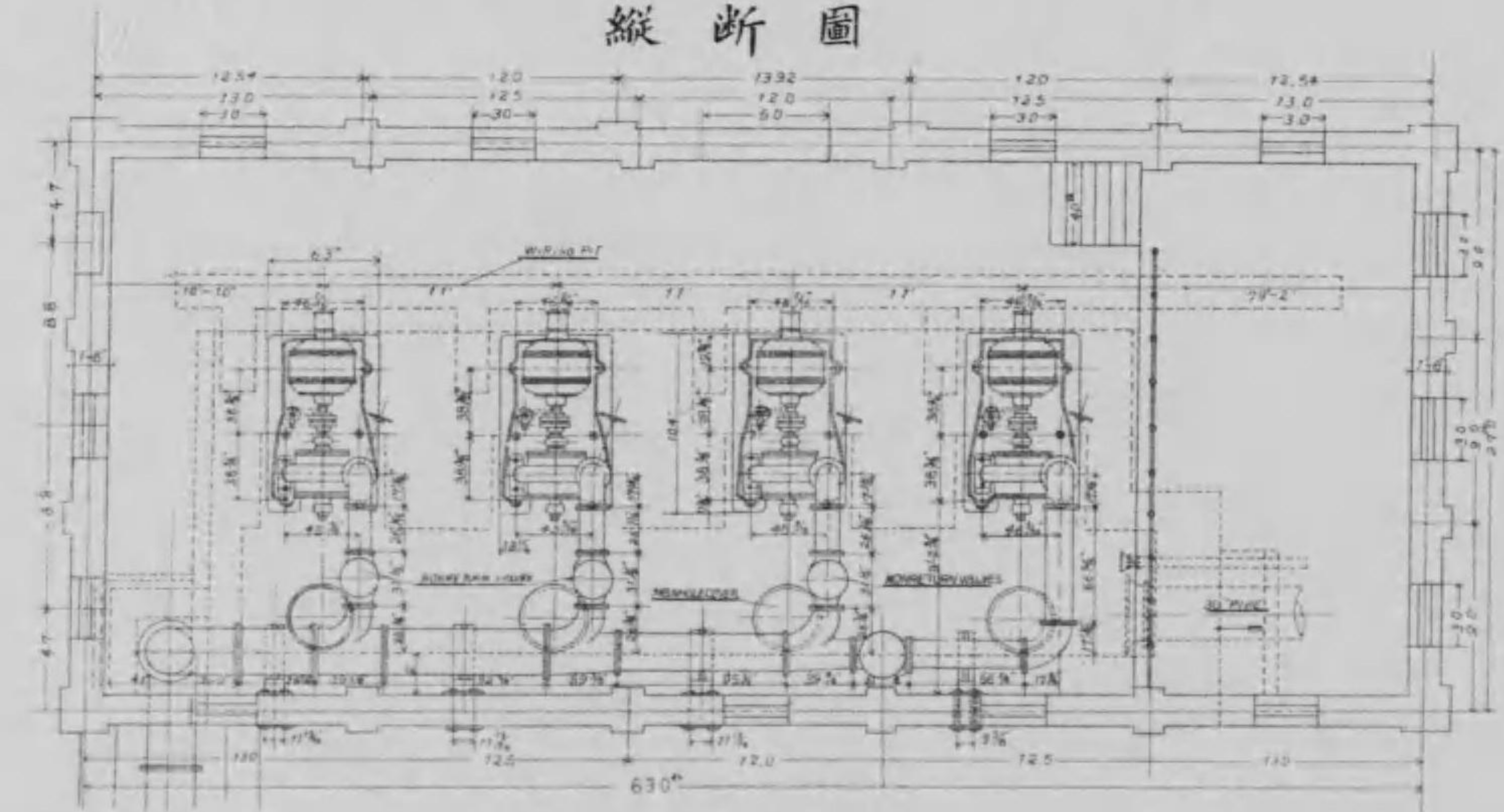

平面圖

KYOTO MUNICIPAL WATER WORKS

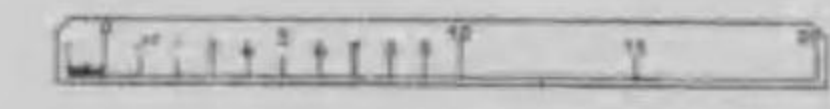

唧筒詳細圖(其一)

第四十八號

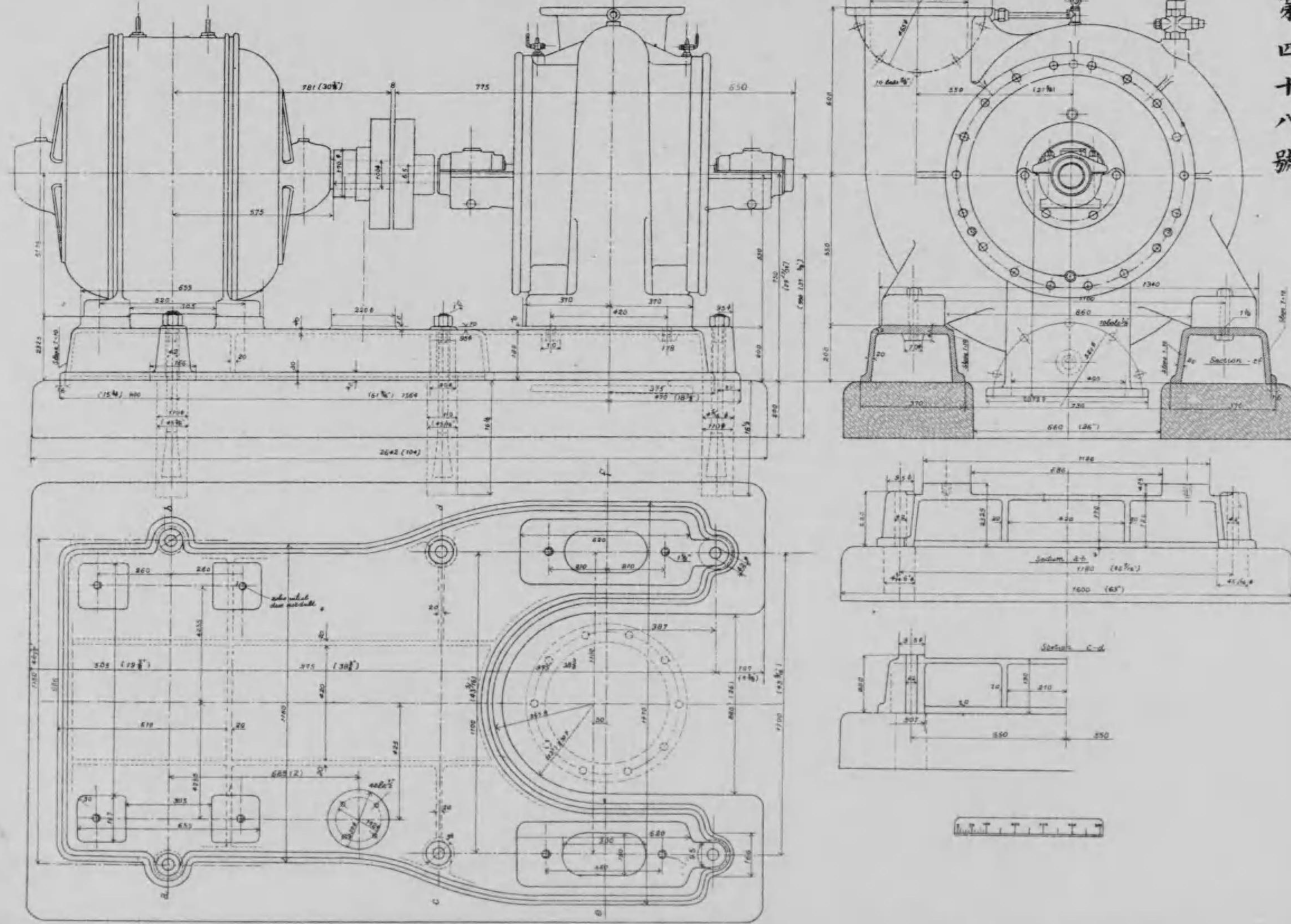

唧筒詳細圖(其二)

第四十九號

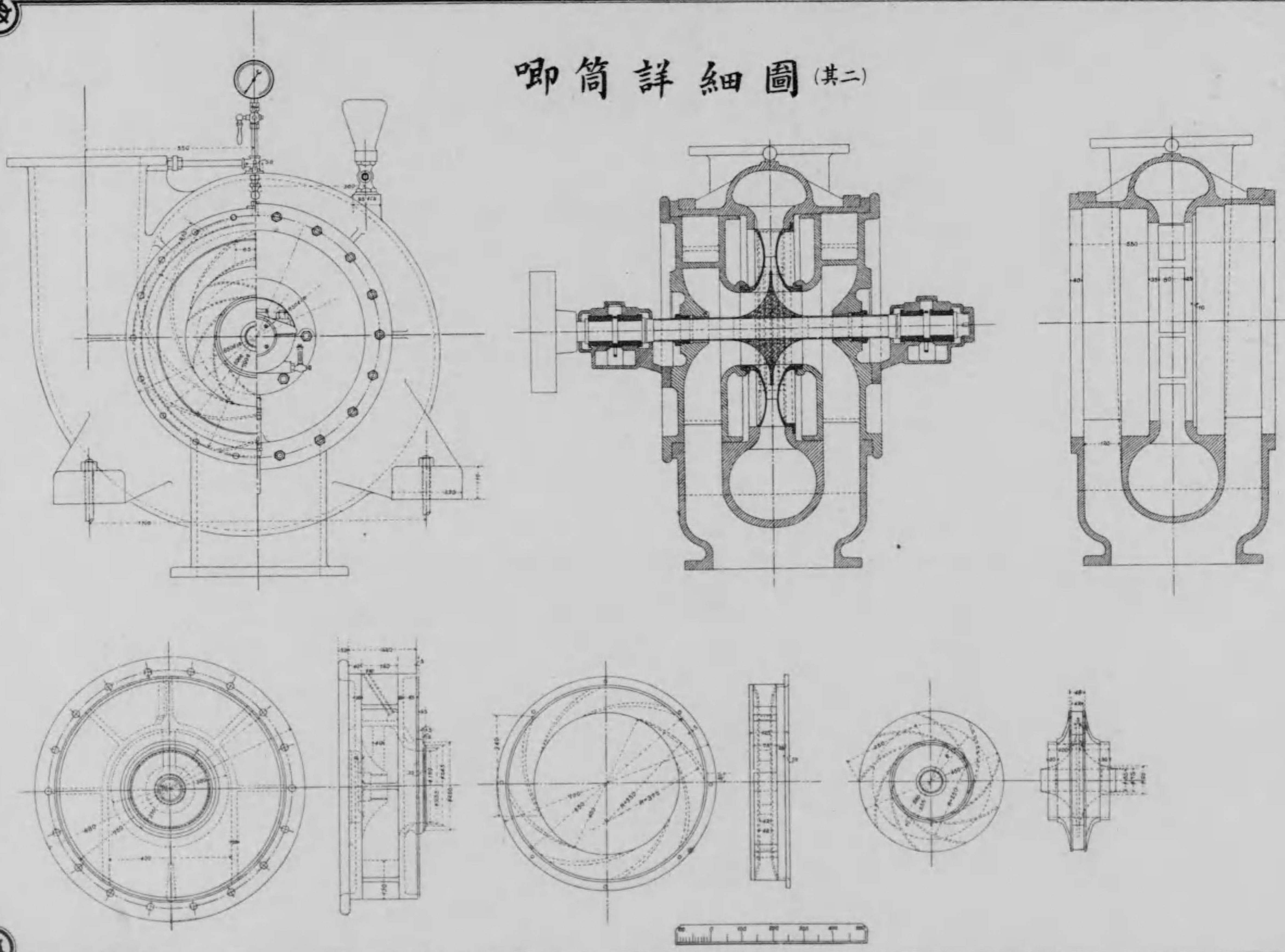

唧筒室建圖

第五十號

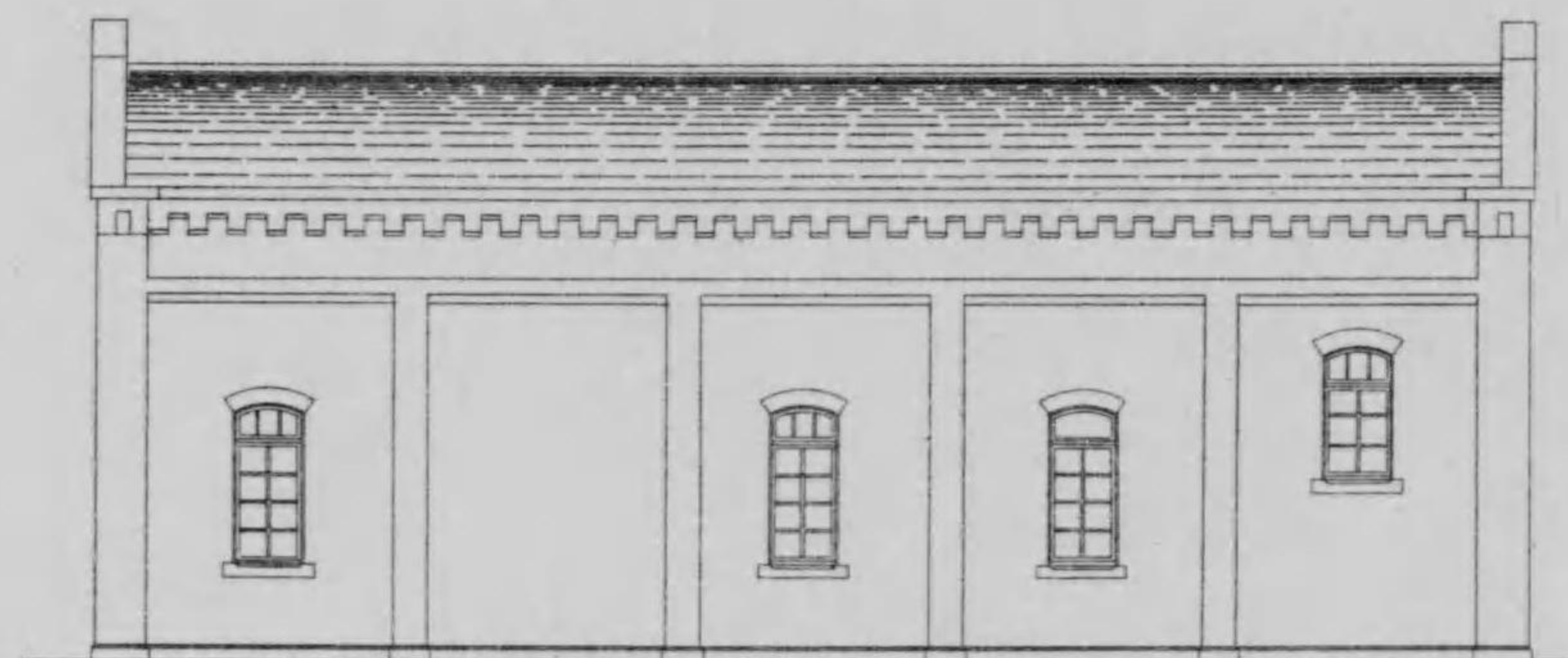

南側建圖

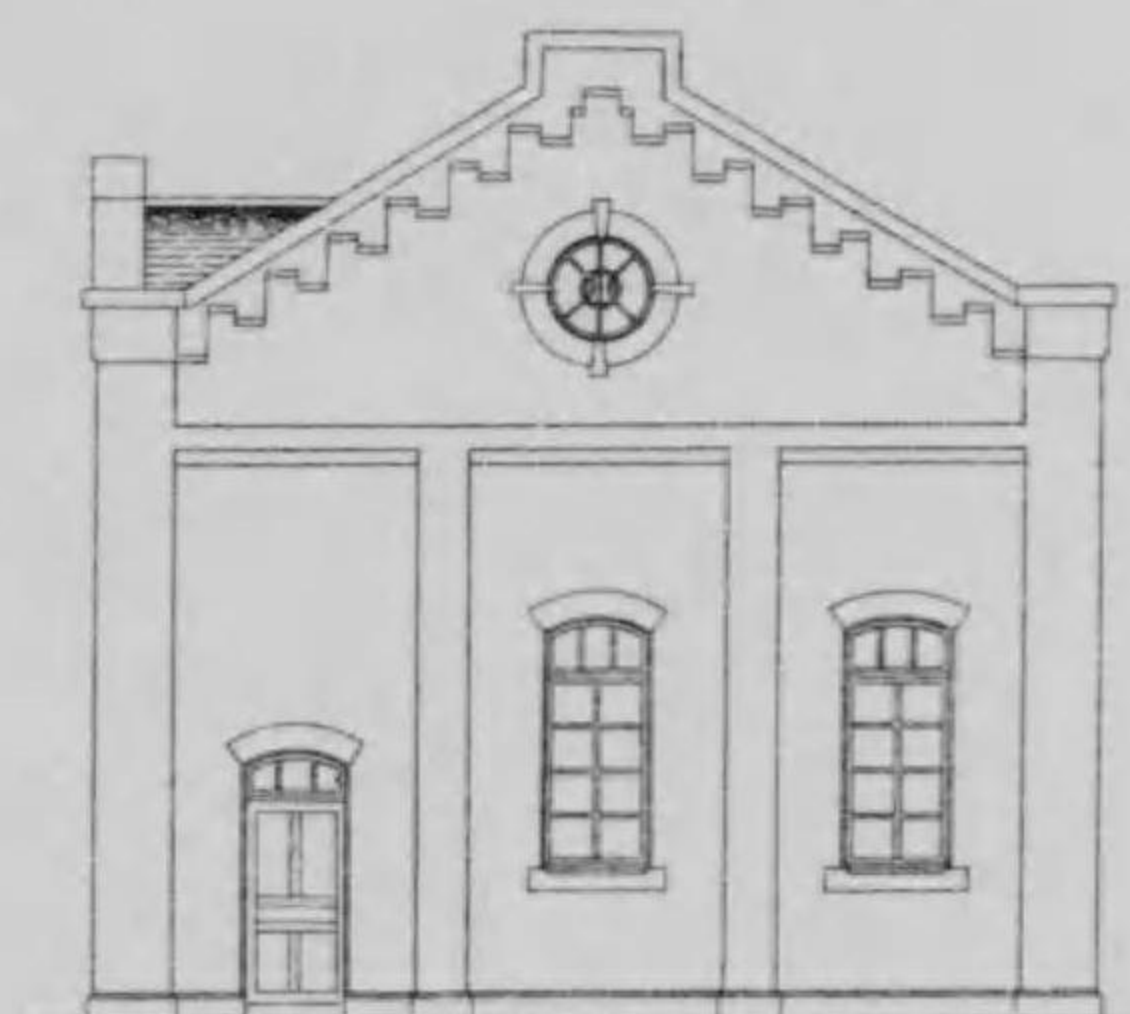

西側建圖

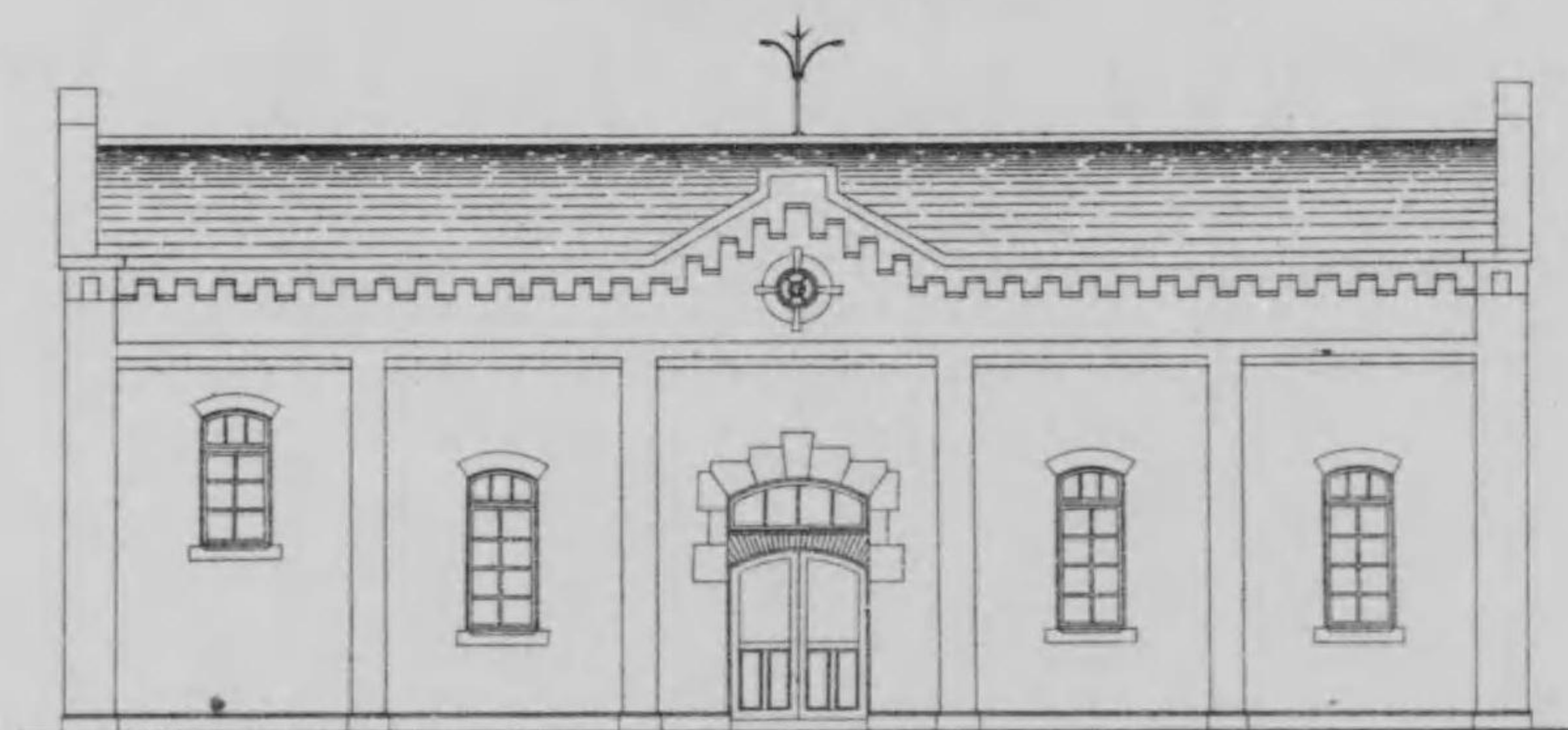

正面圖

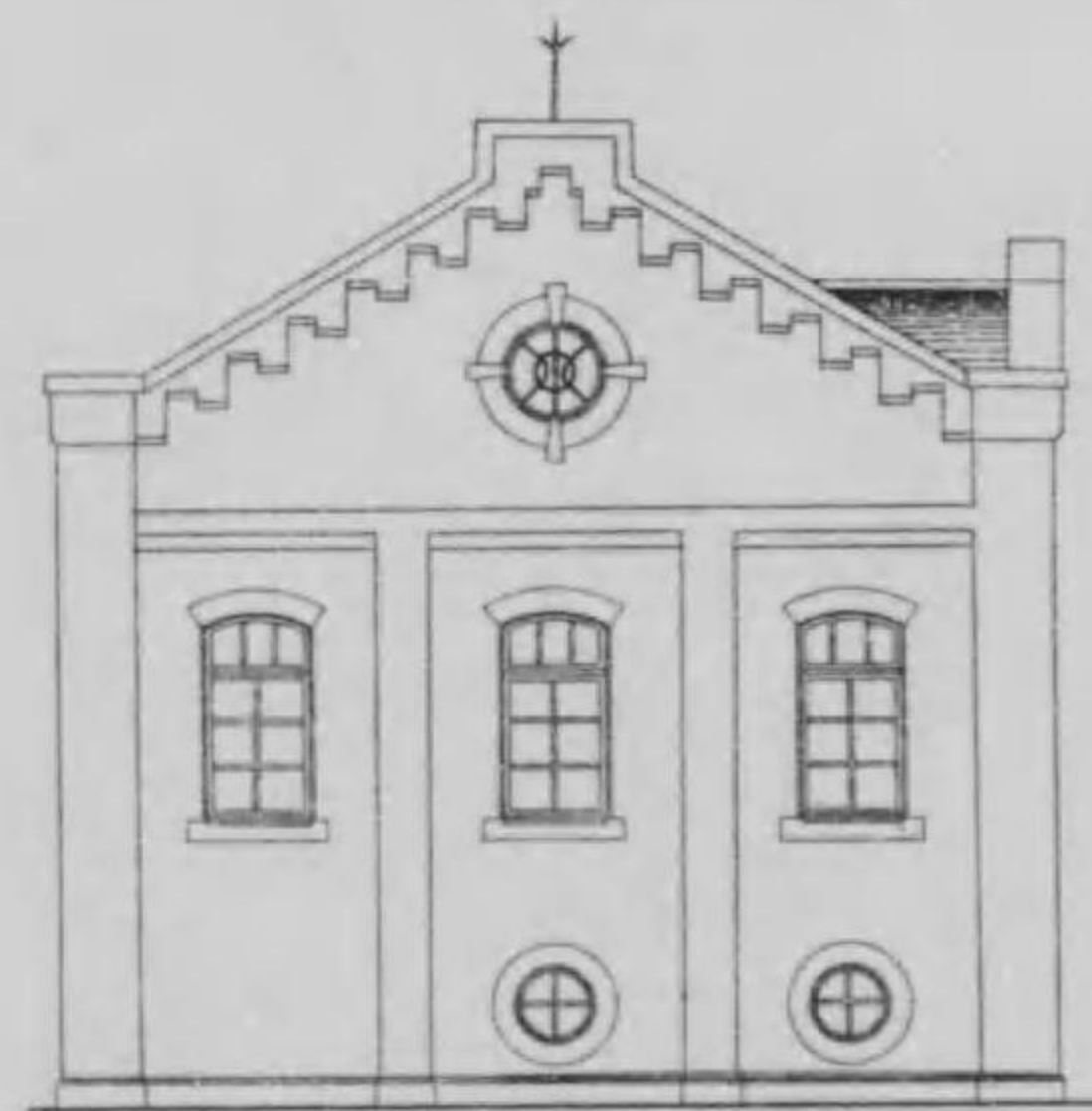

東側建圖



配水池構造圖 (高區其一)

第五十一號

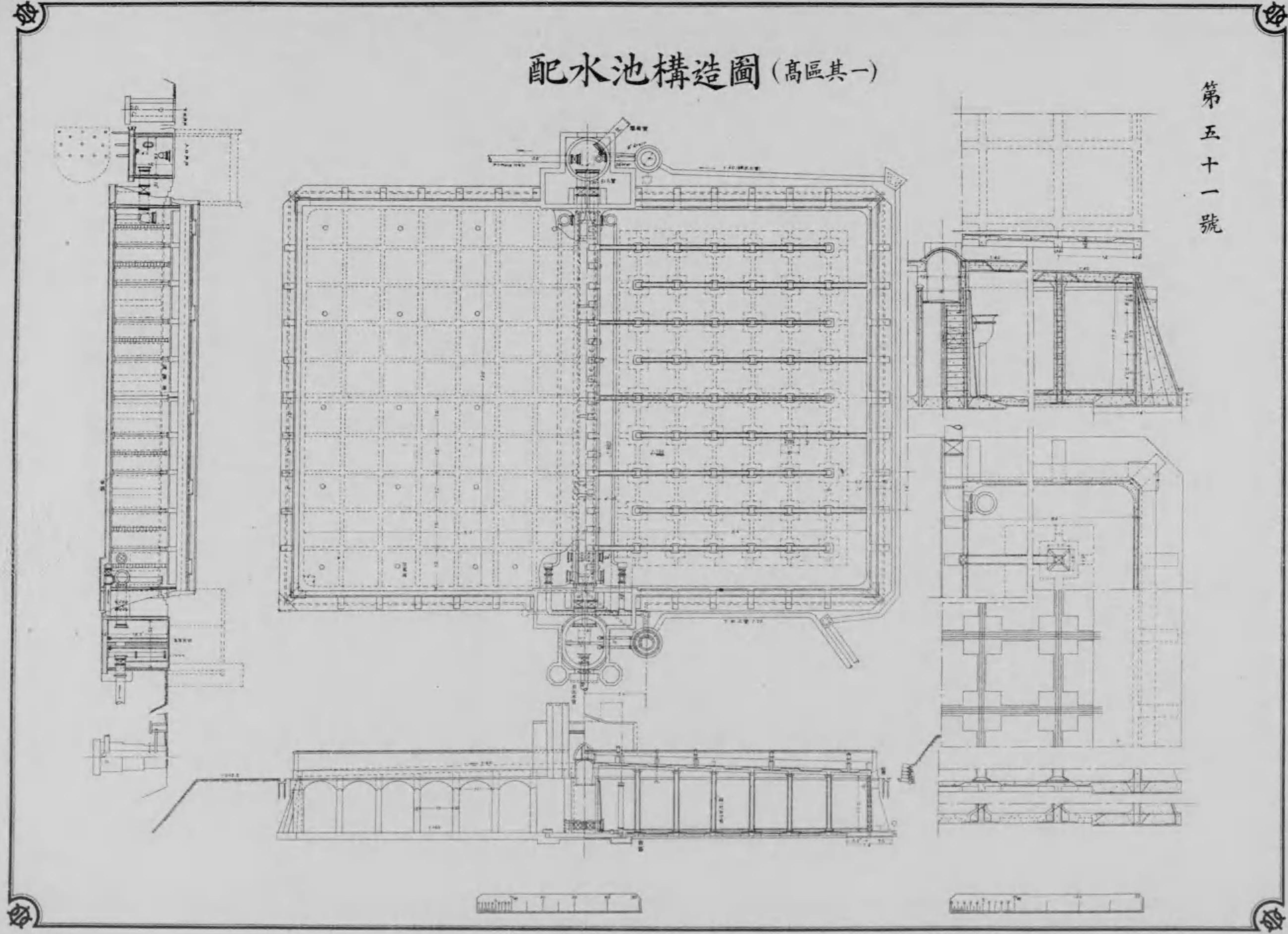

配水池構造圖 (高區其二)

第五十二號

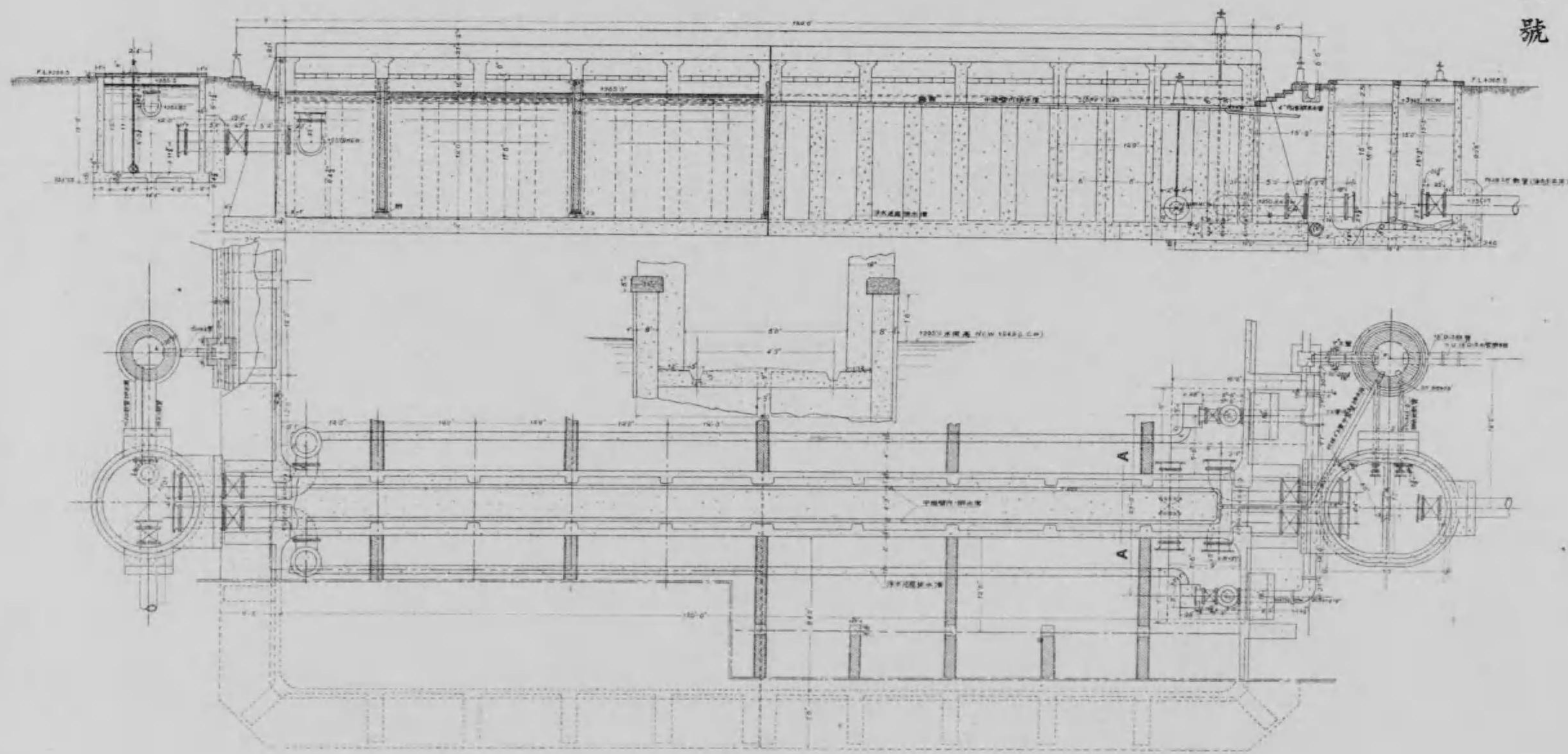

XXXXXXXXXXXX

配水池構造圖 (低區其三)

第五十三號

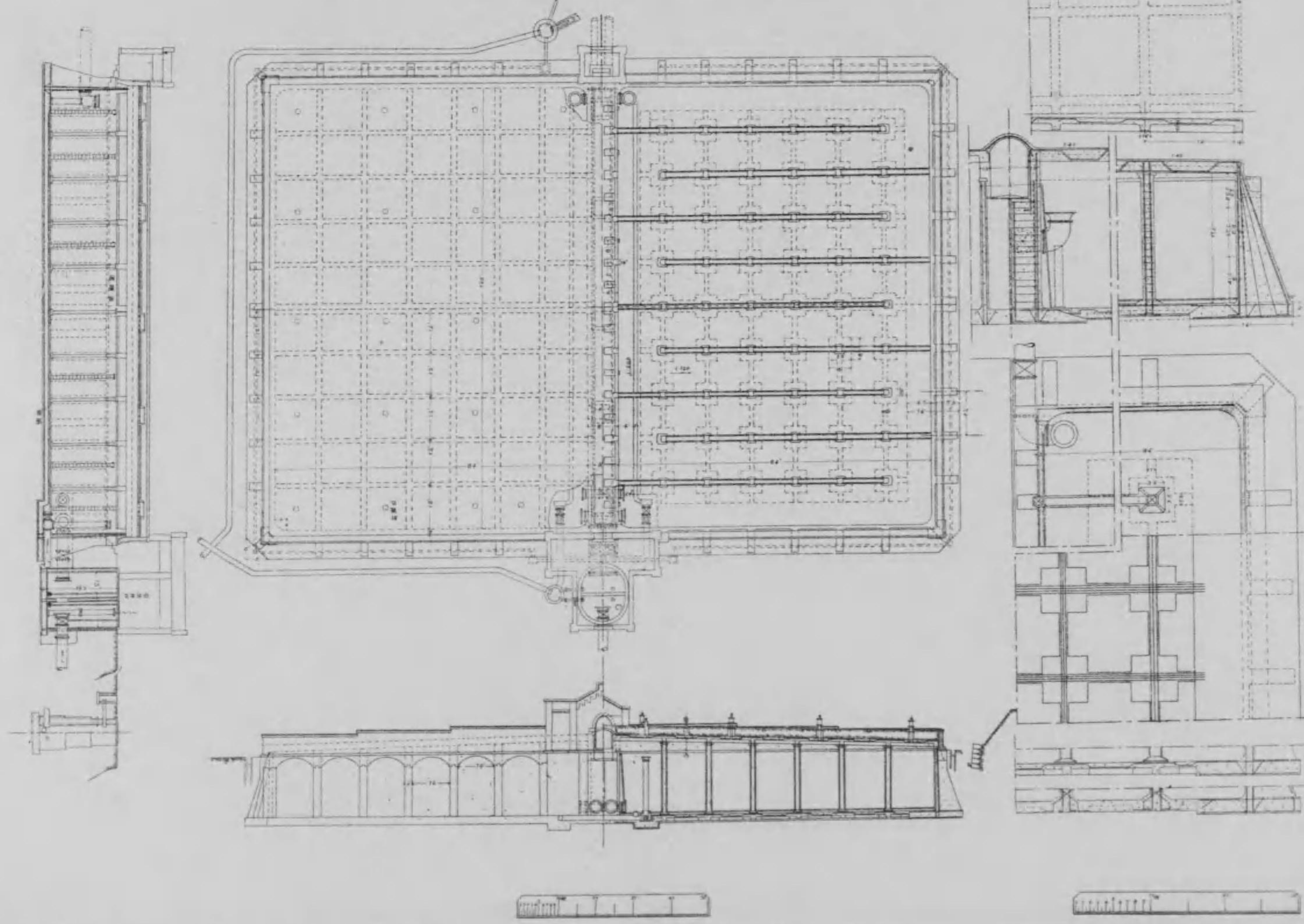

配水池構造圖 (低區其四)

第五十四號

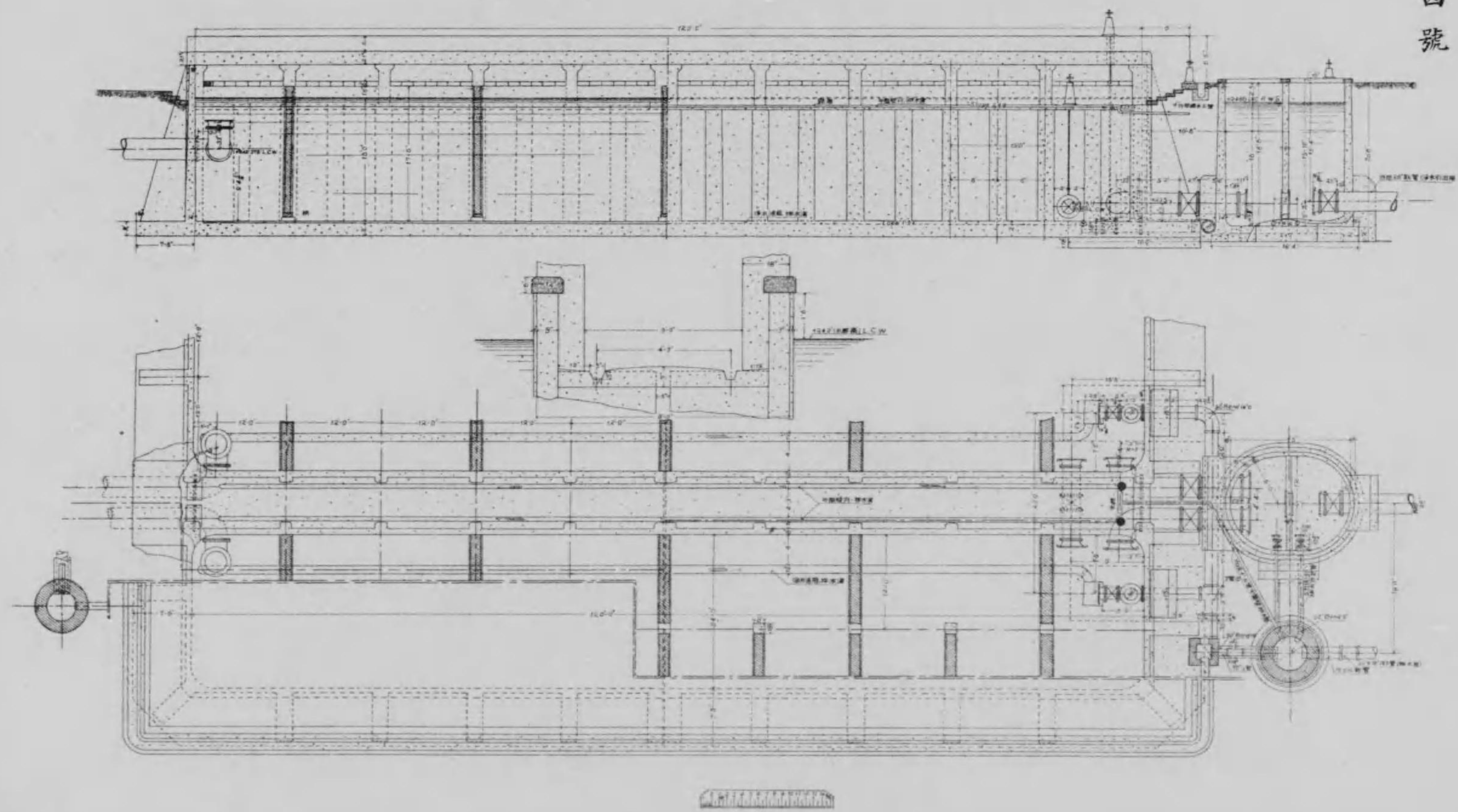

配水池構造圖(其五)

第五十五號

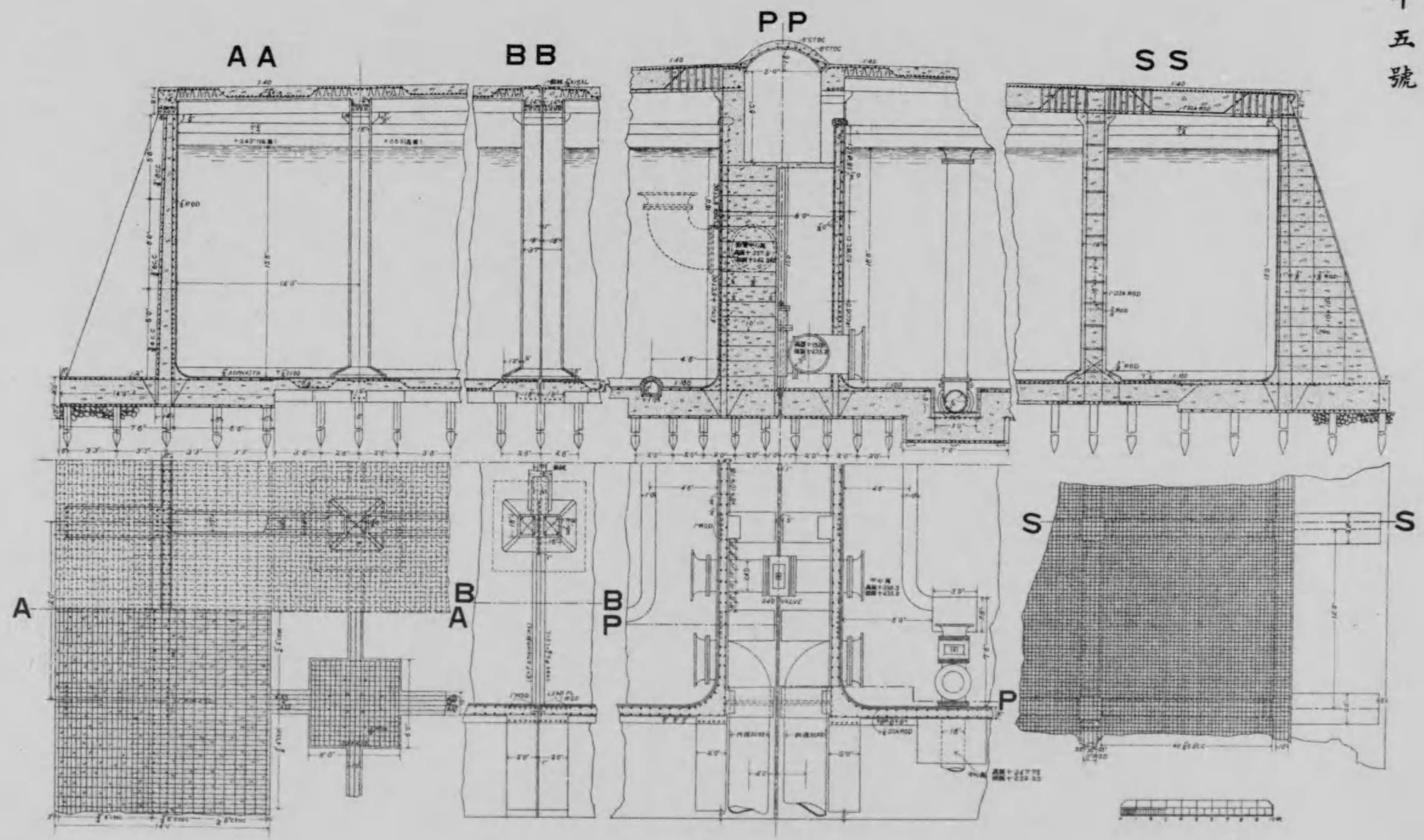

配水池構造圖 (其六)

BB

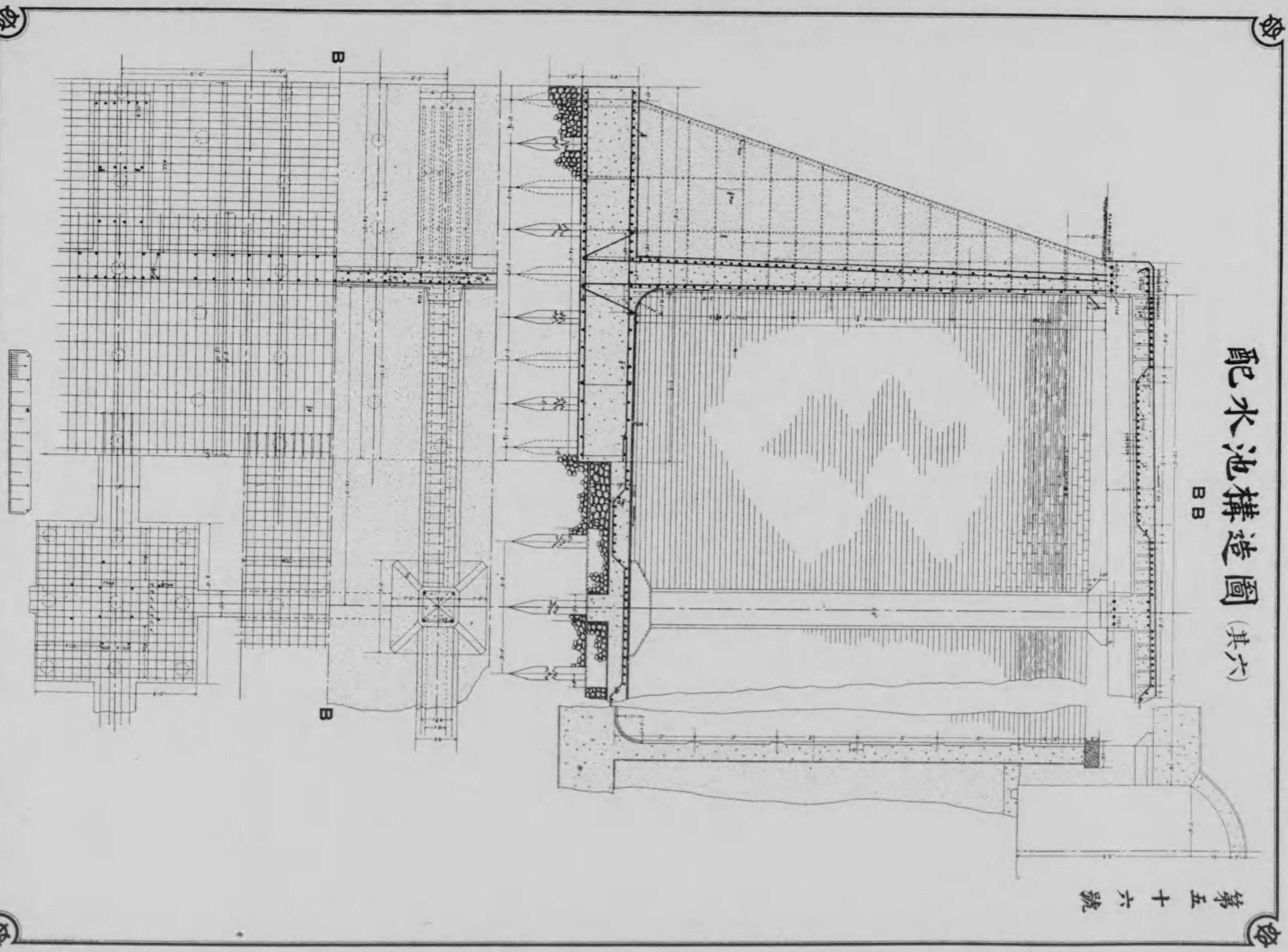

第五十六號

配水池構造圖 (其七)

第五十七號

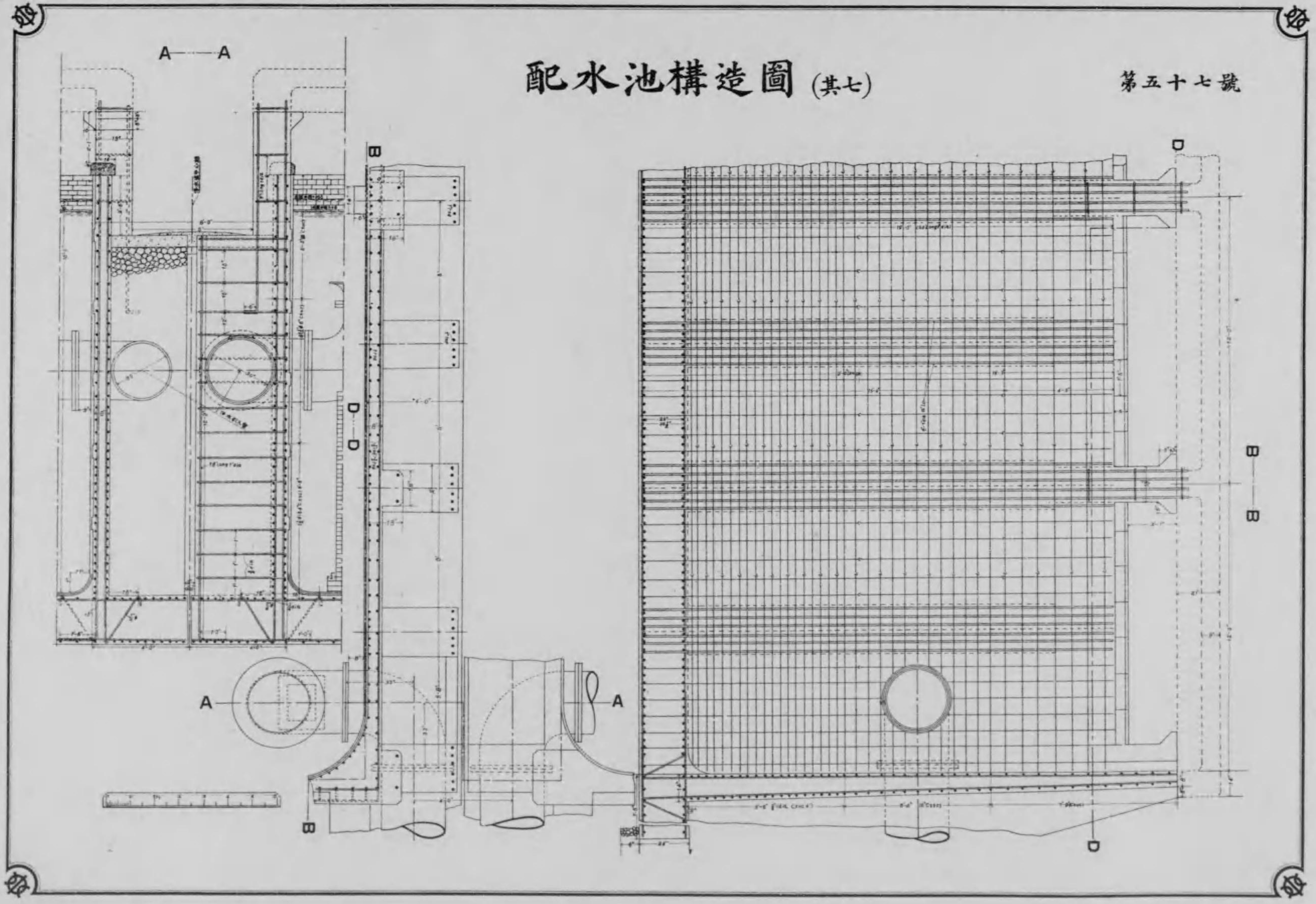

配水池構造圖(其八)

第五十八號

底部鉄筋配列圖

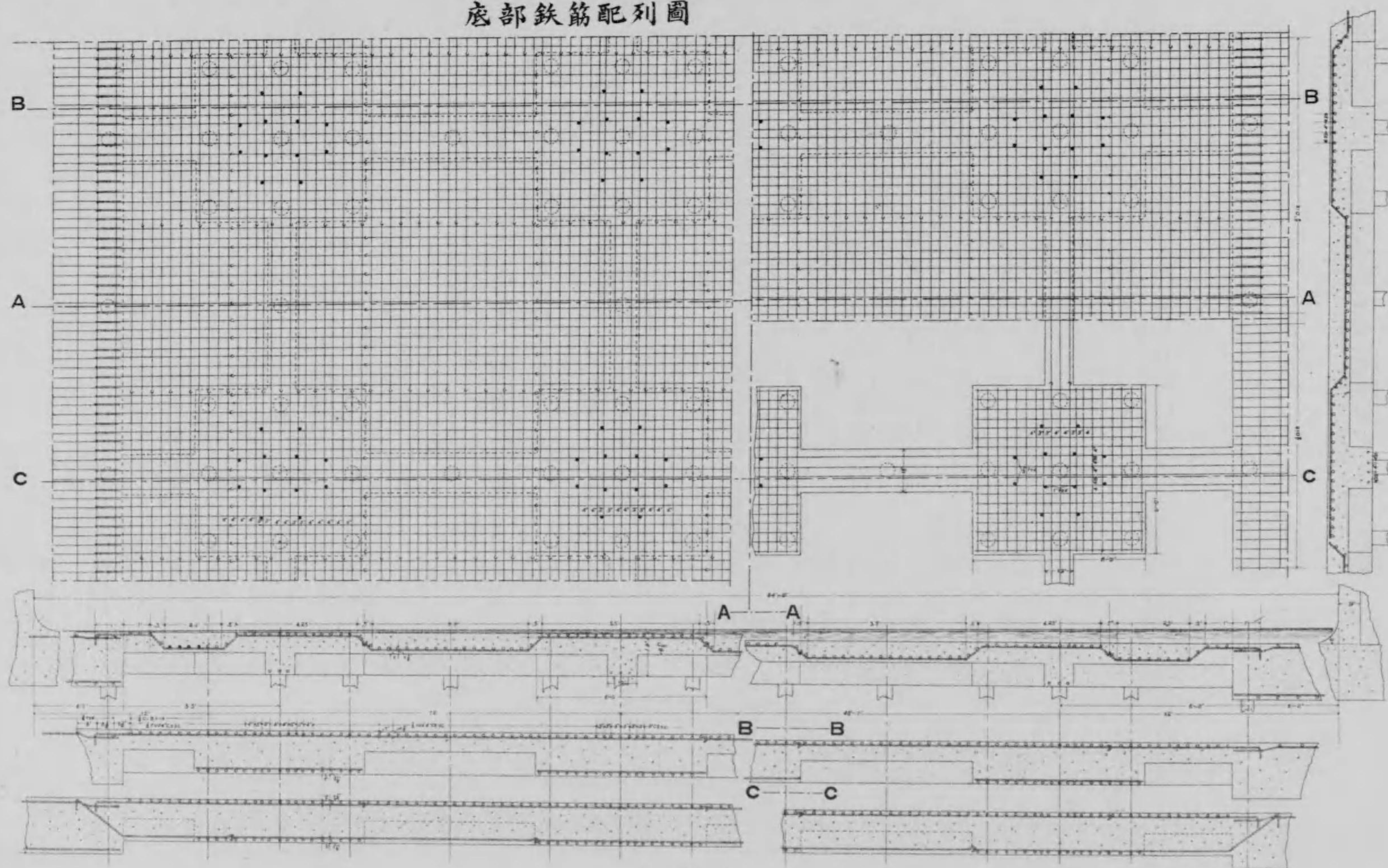

縮尺



上覆鉄筋配列圖

配水池構造圖 (其九)

第五十九號

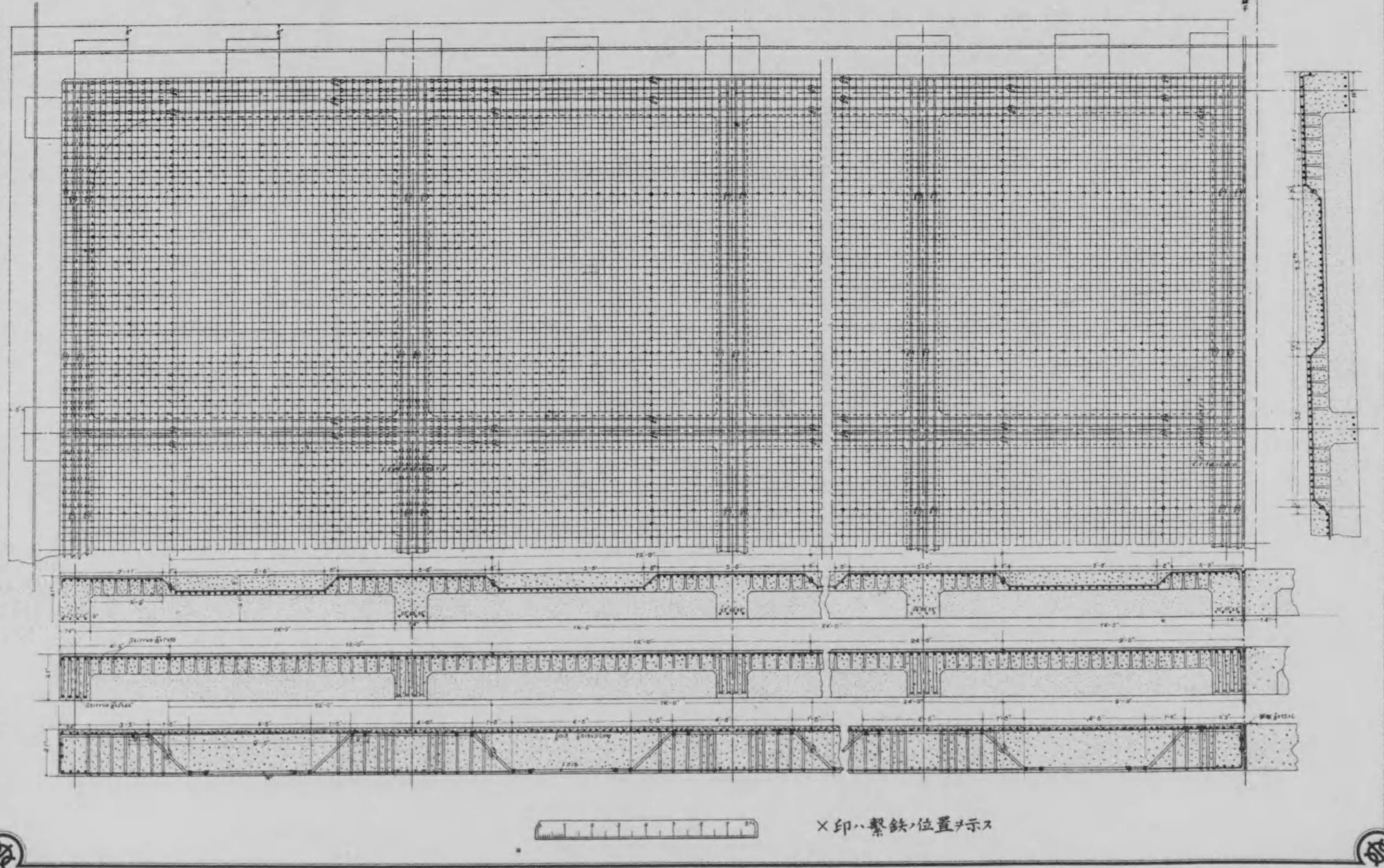

×印ハ繫鉄ノ位置ヲ示ス

配水池構造圖(其十)

第六十號

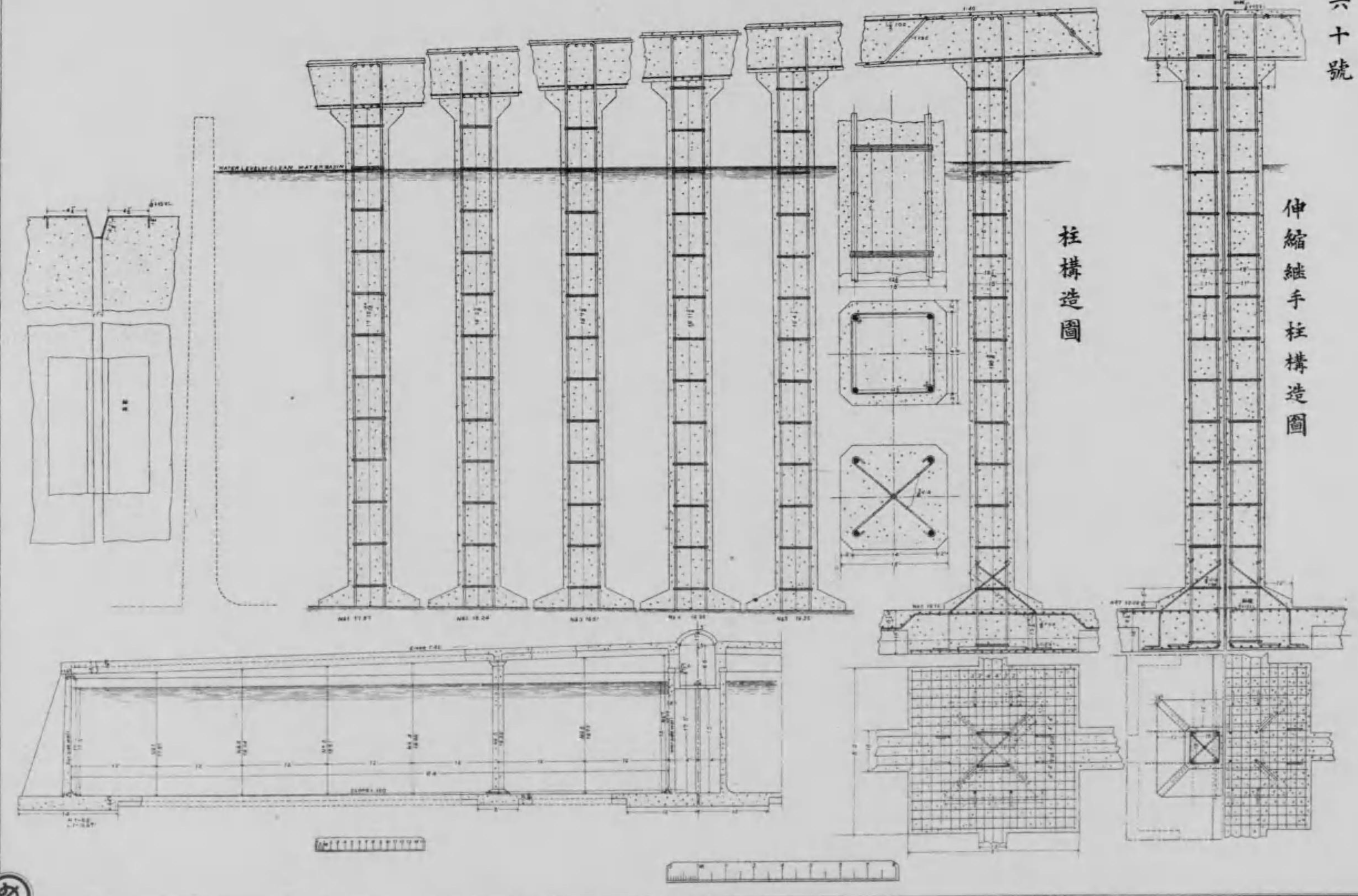

柱構造圖

伸縮縫手柱構造圖

配水池構造圖 (其十一)

第六十一號

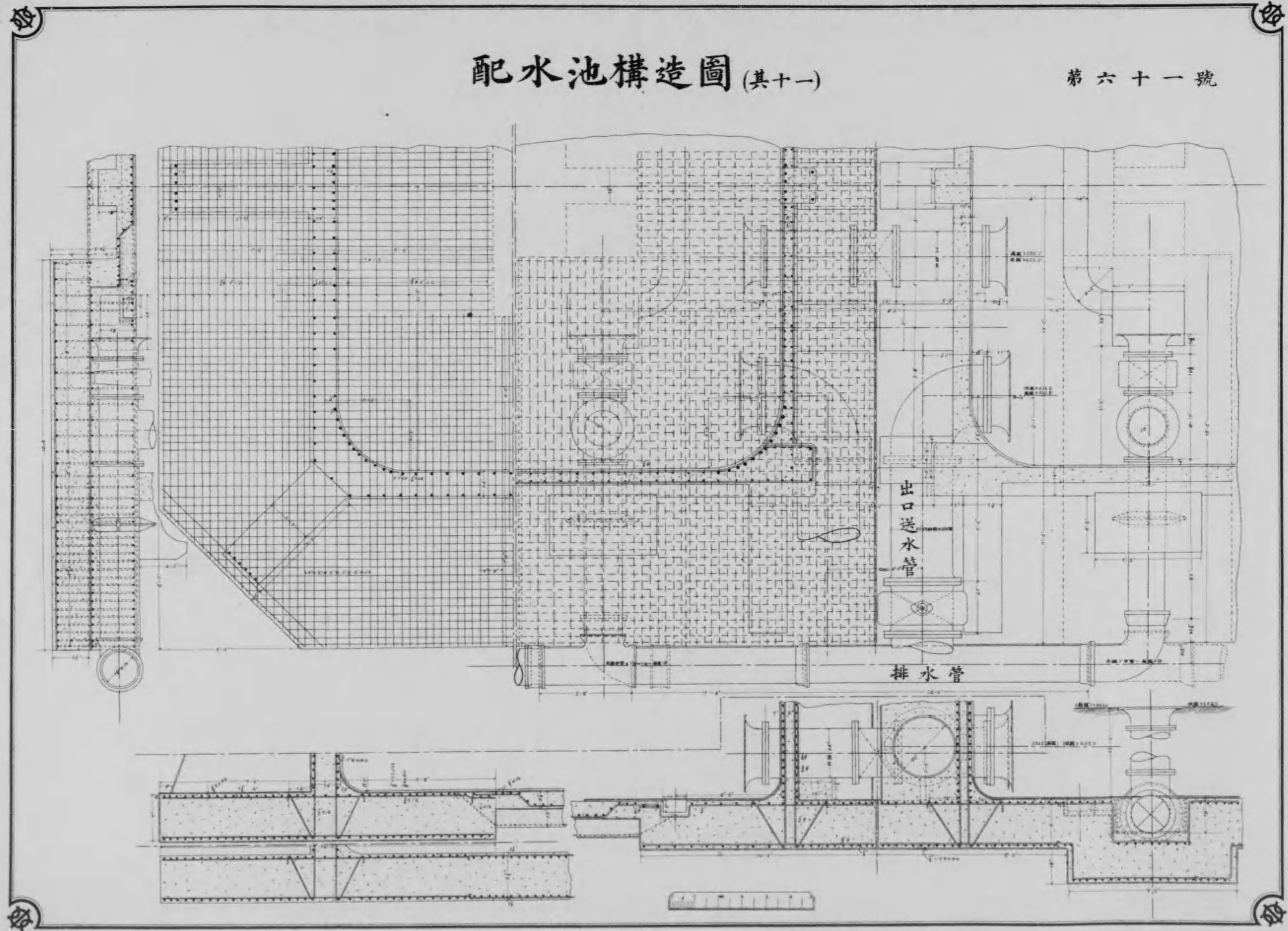

配水池周壁基礎拱橋圖

第六十二號

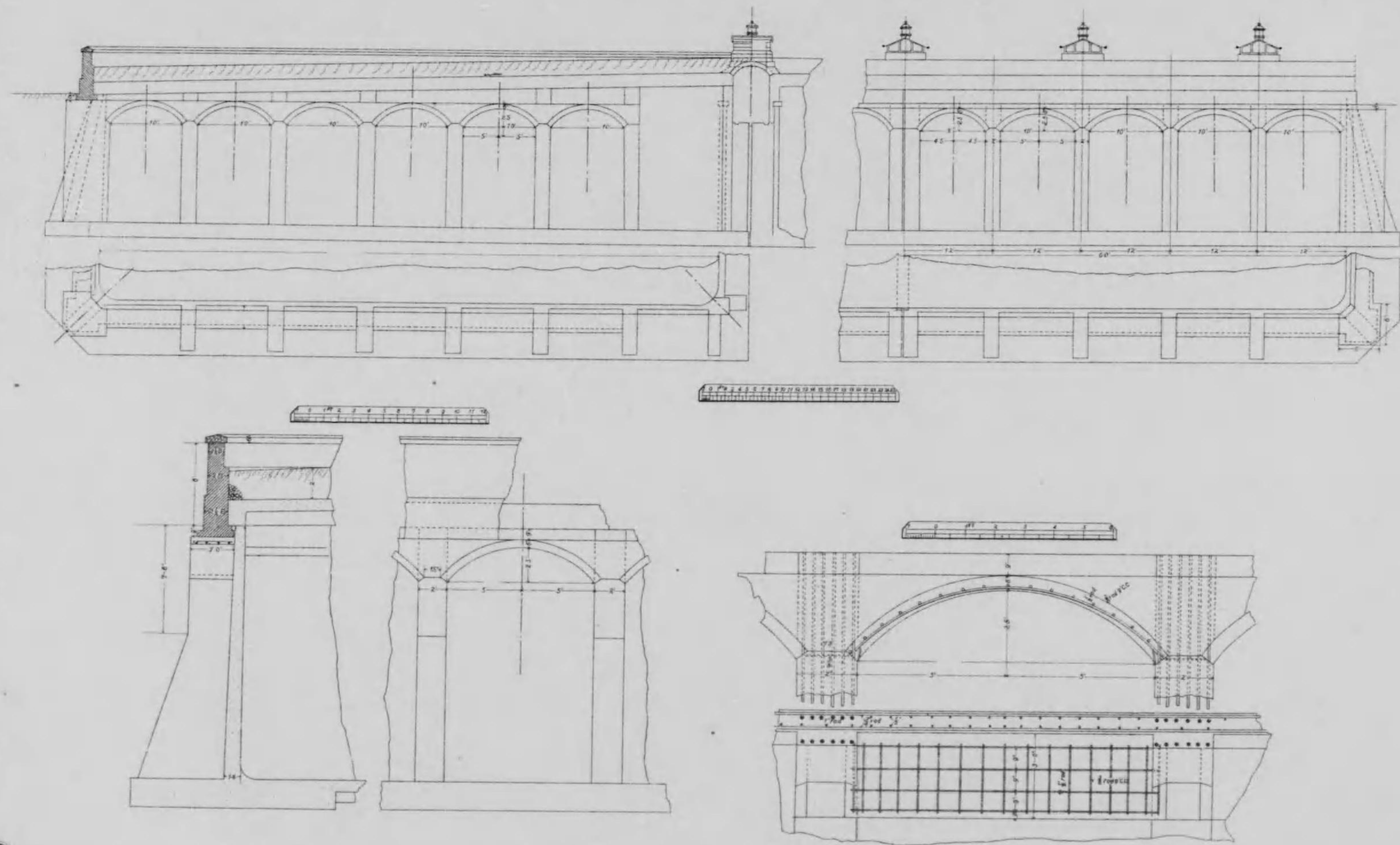

低區配水池 鋁上家圖

第六十三號

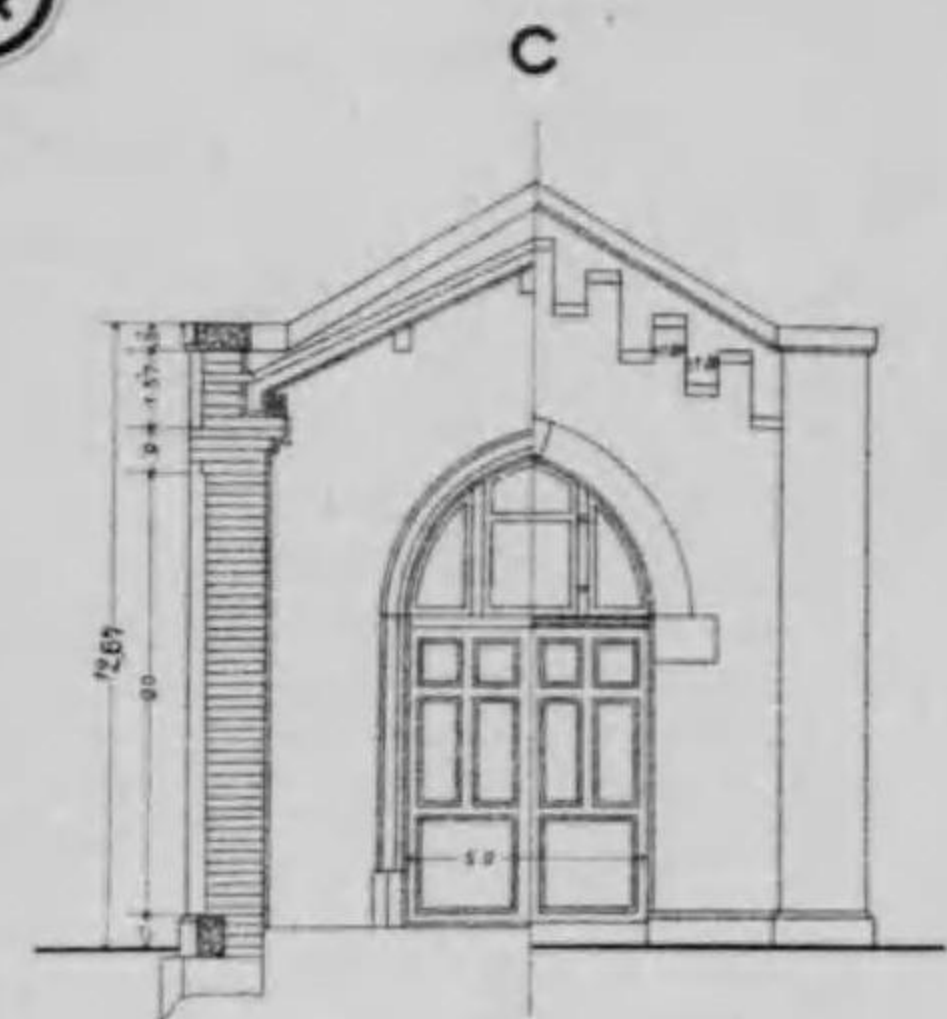

入口詳細圖

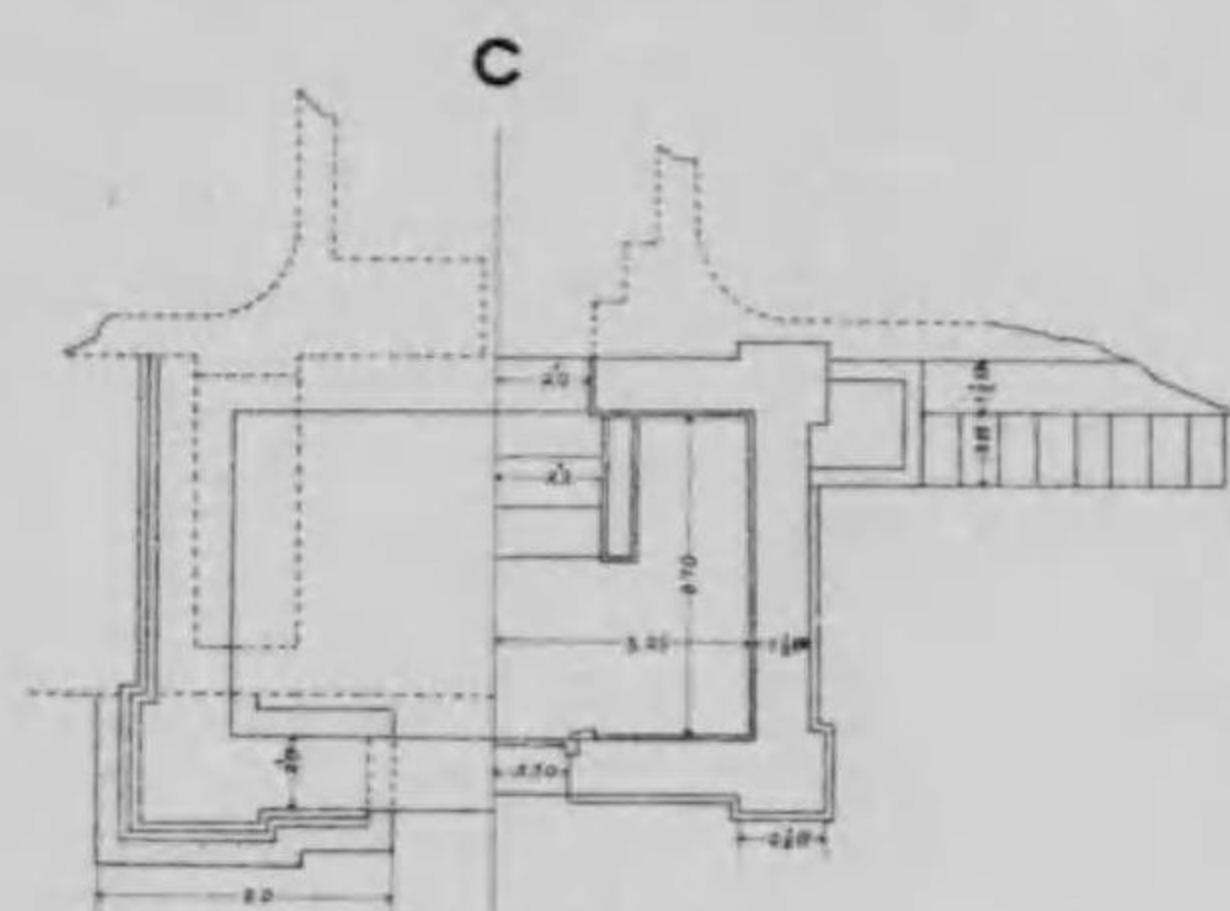
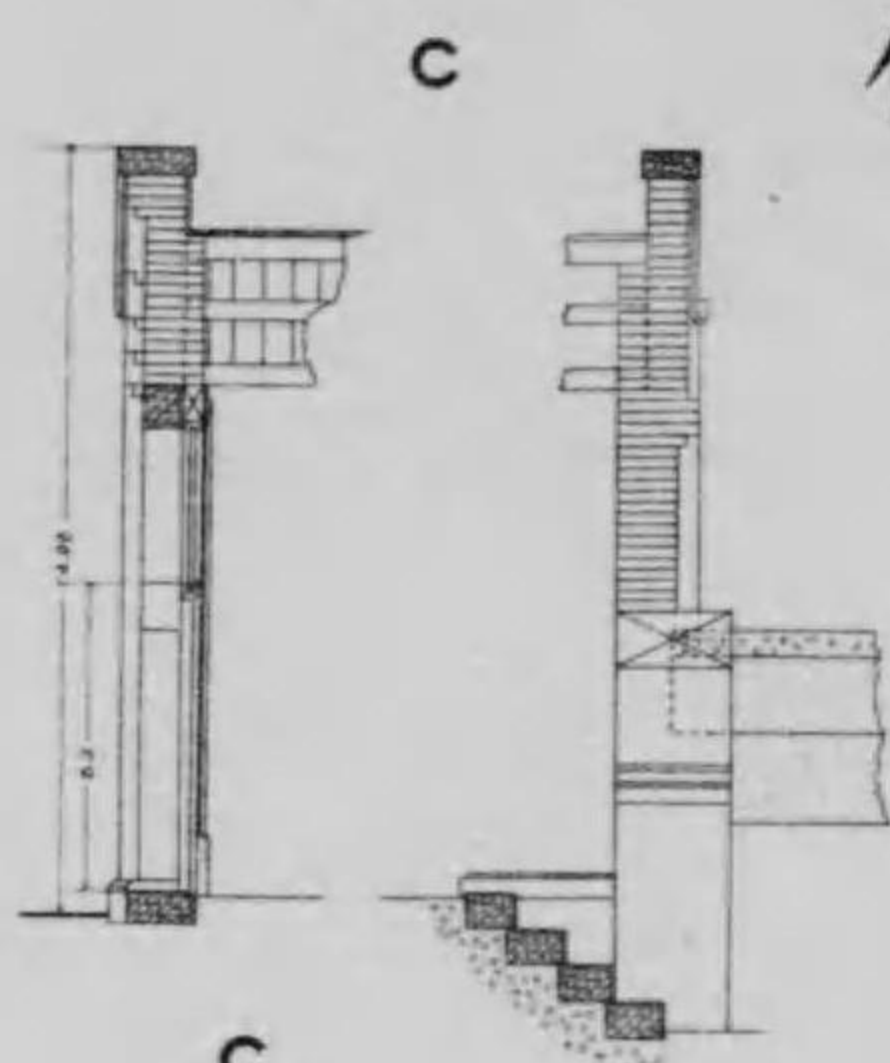

入口平面圖

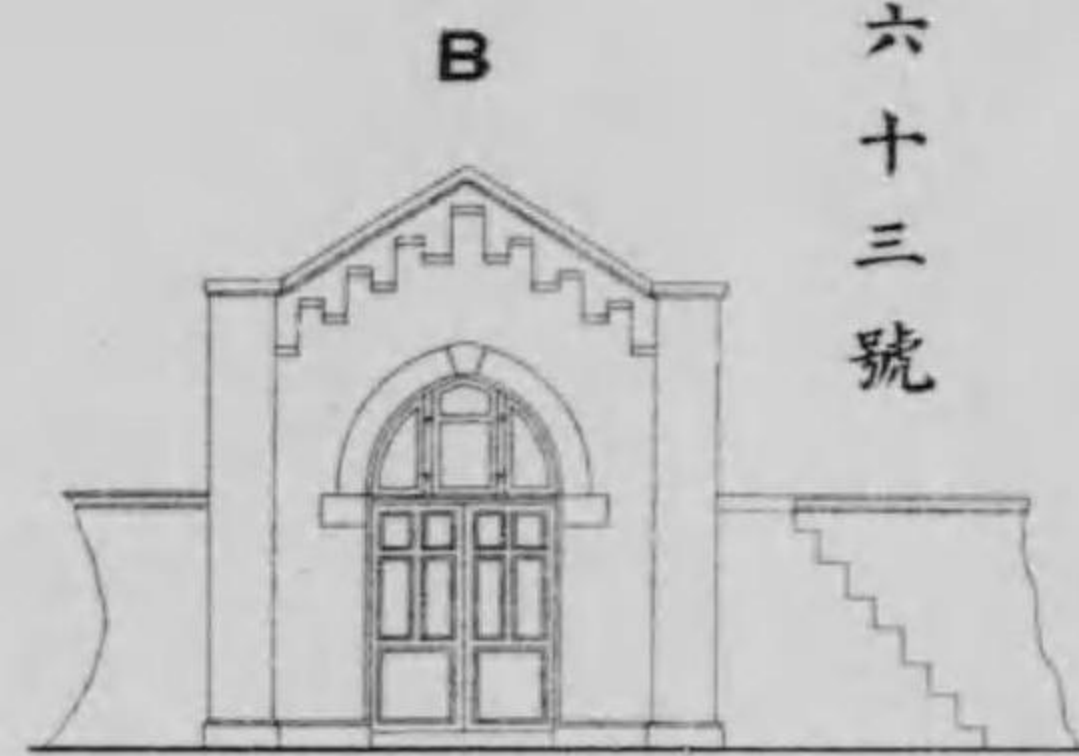
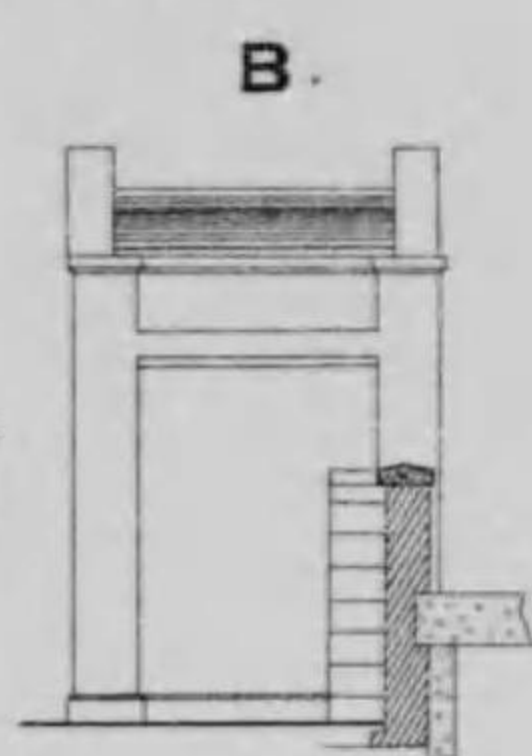

入口正面圖

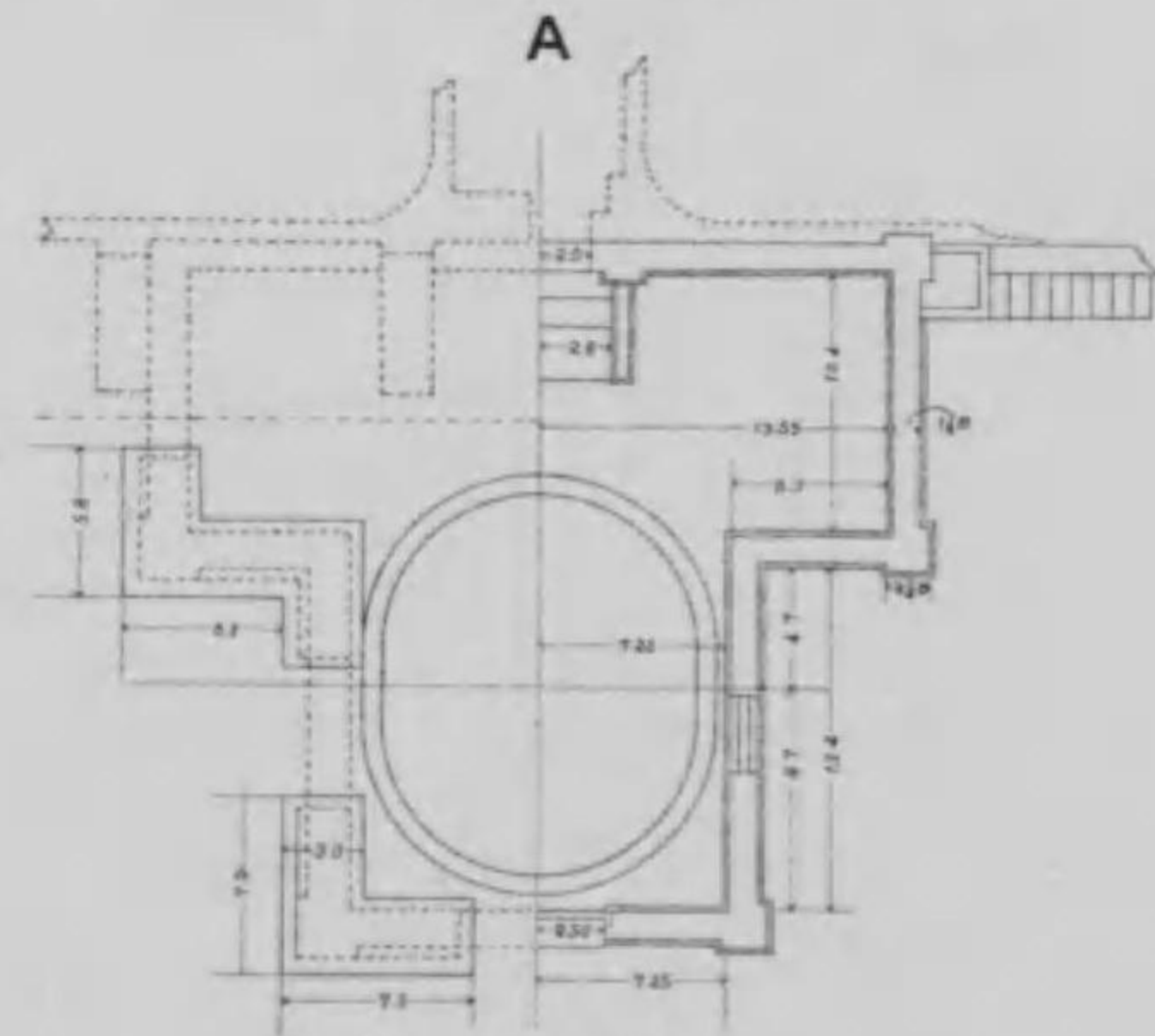
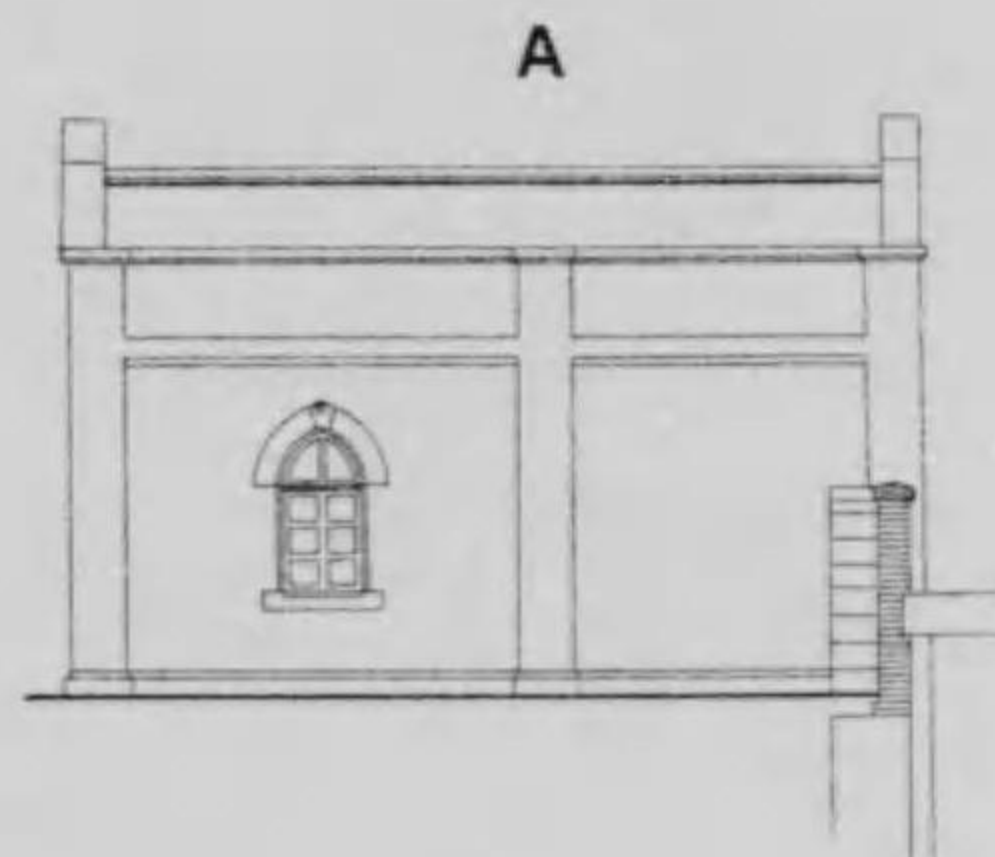
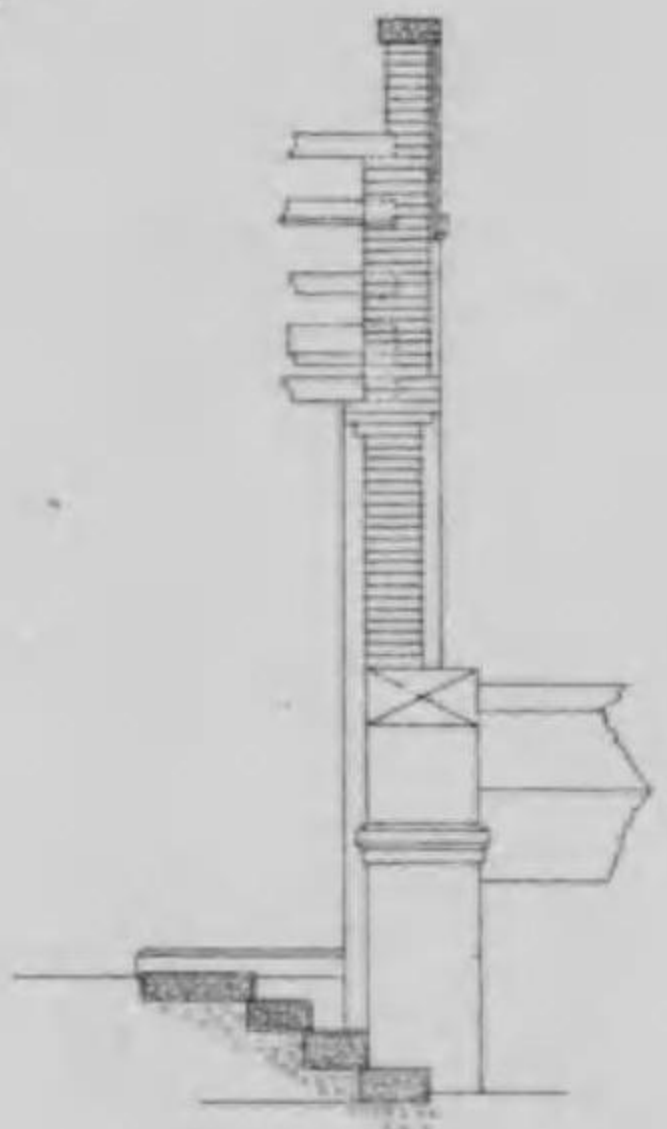
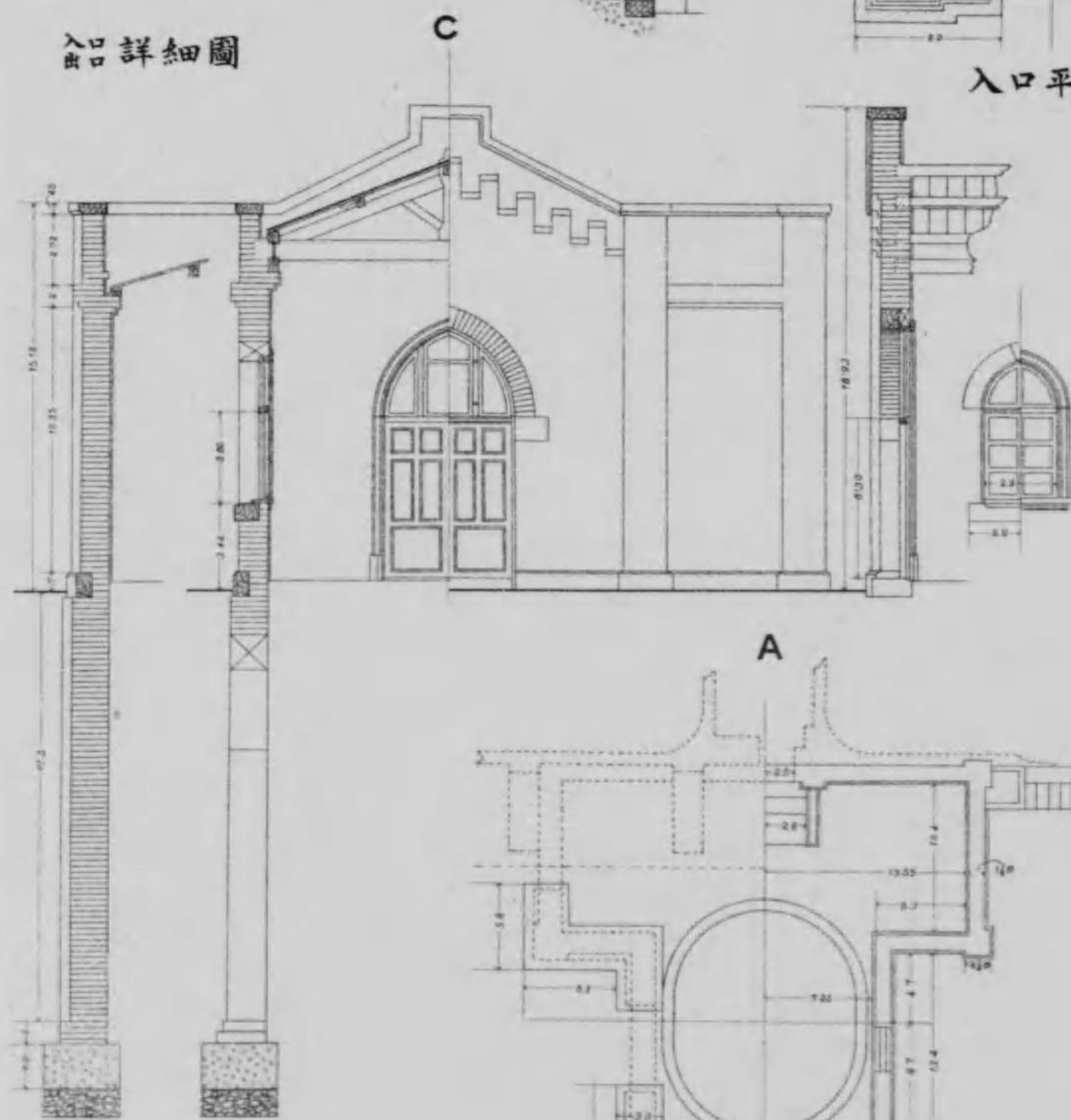

出口平面圖

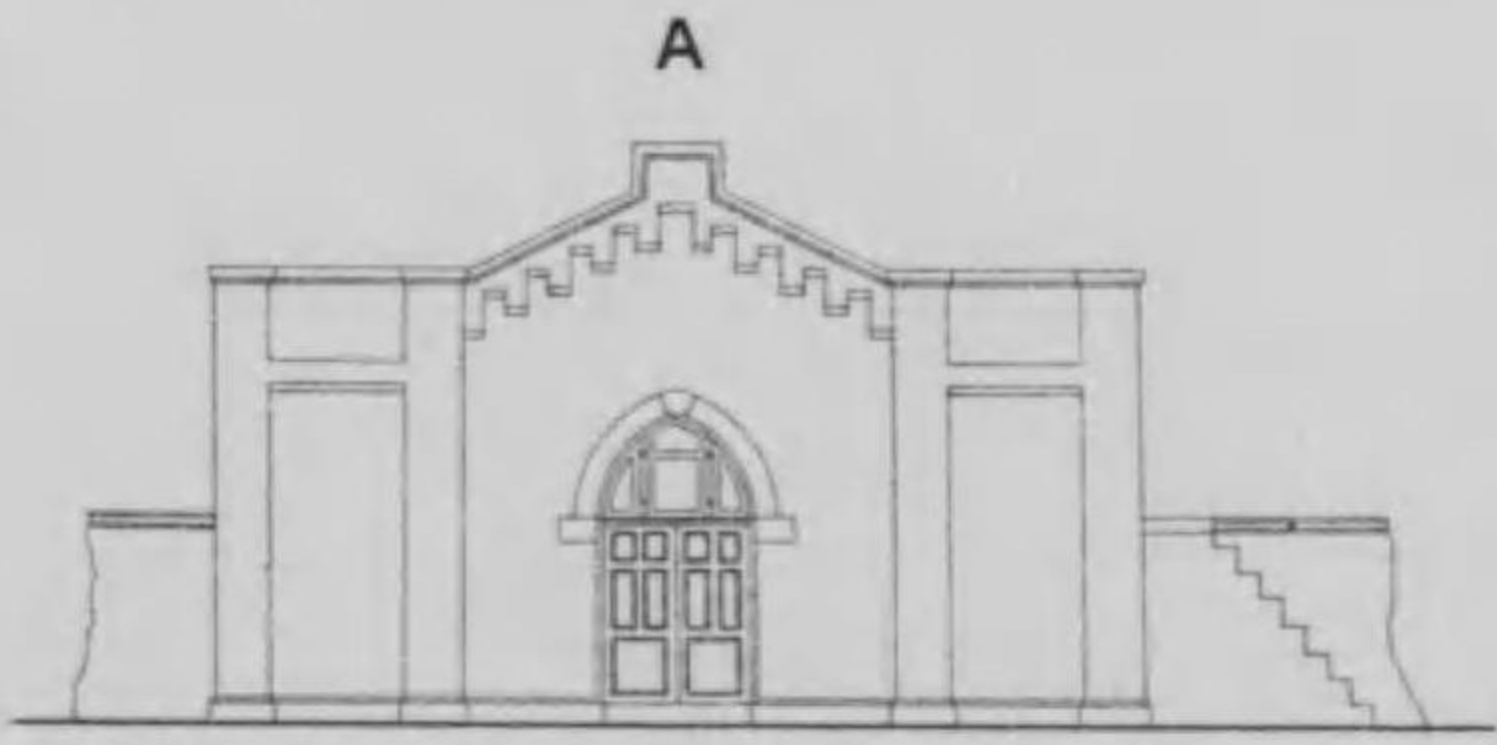

出口正面圖

A 縮尺

B 縮尺

C 縮尺

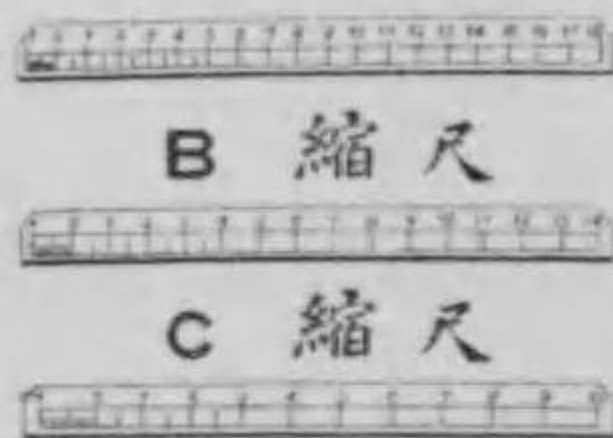

高區及低區配水池周壁圖 第六十四號

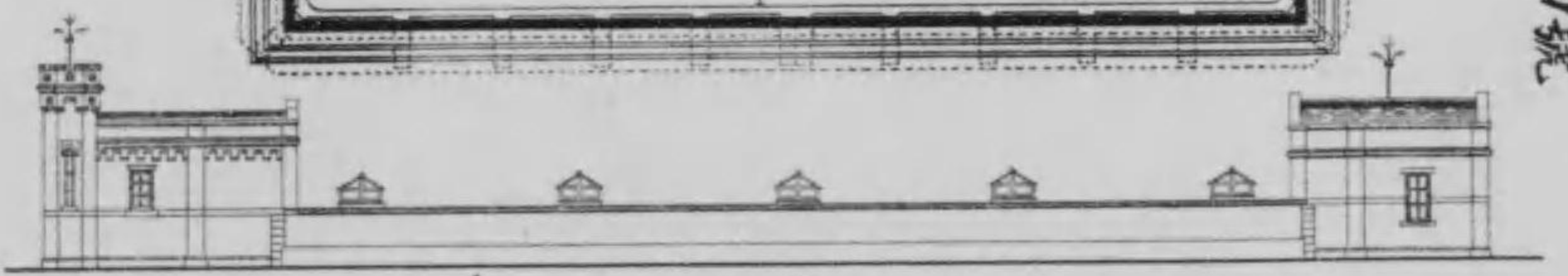
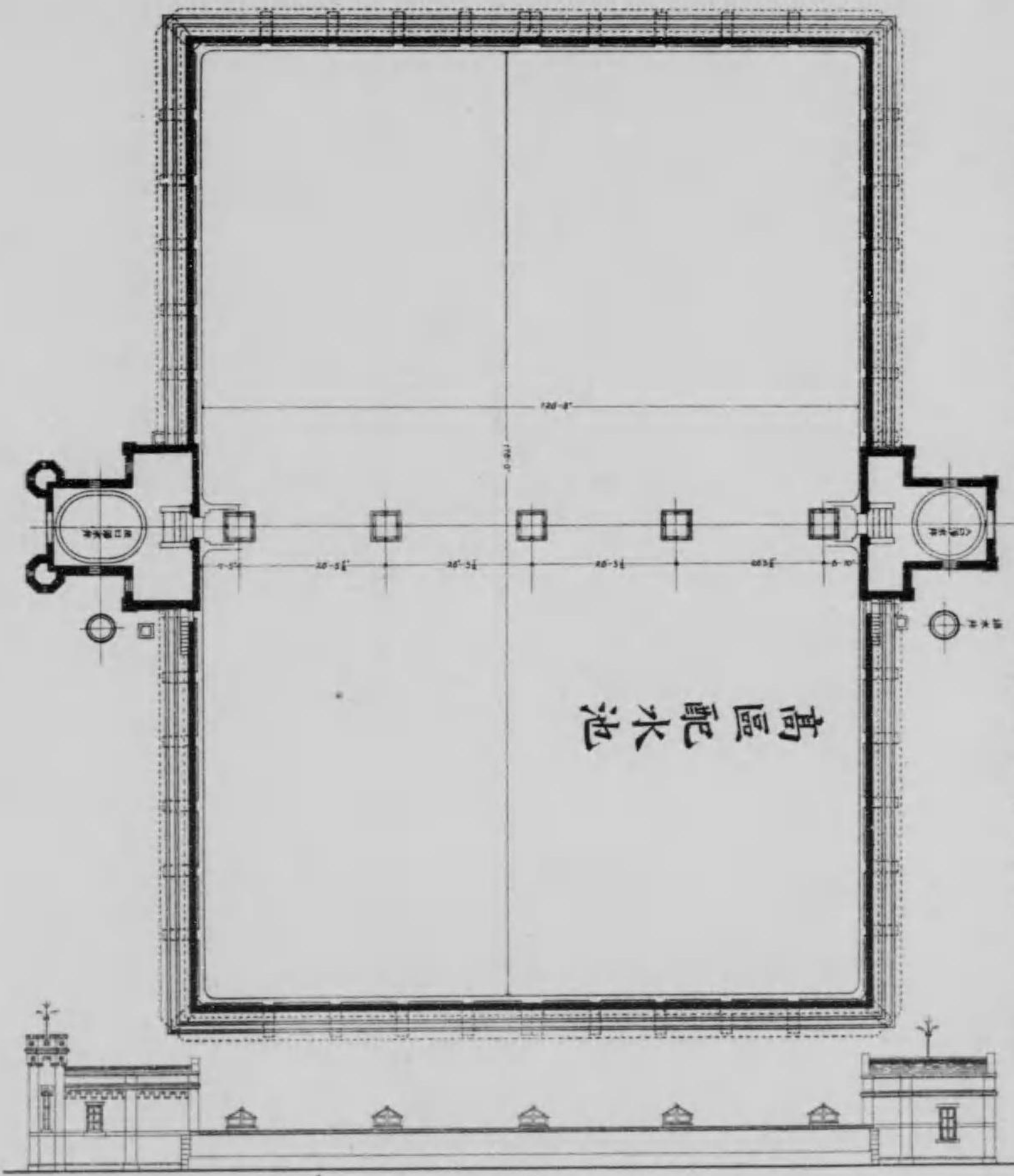

側面圖

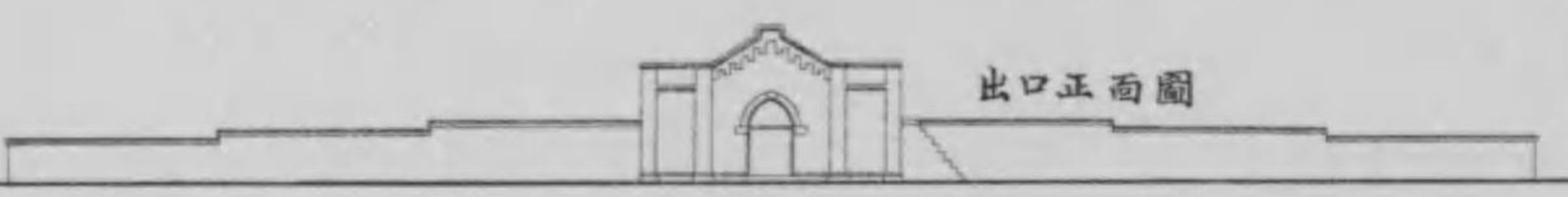
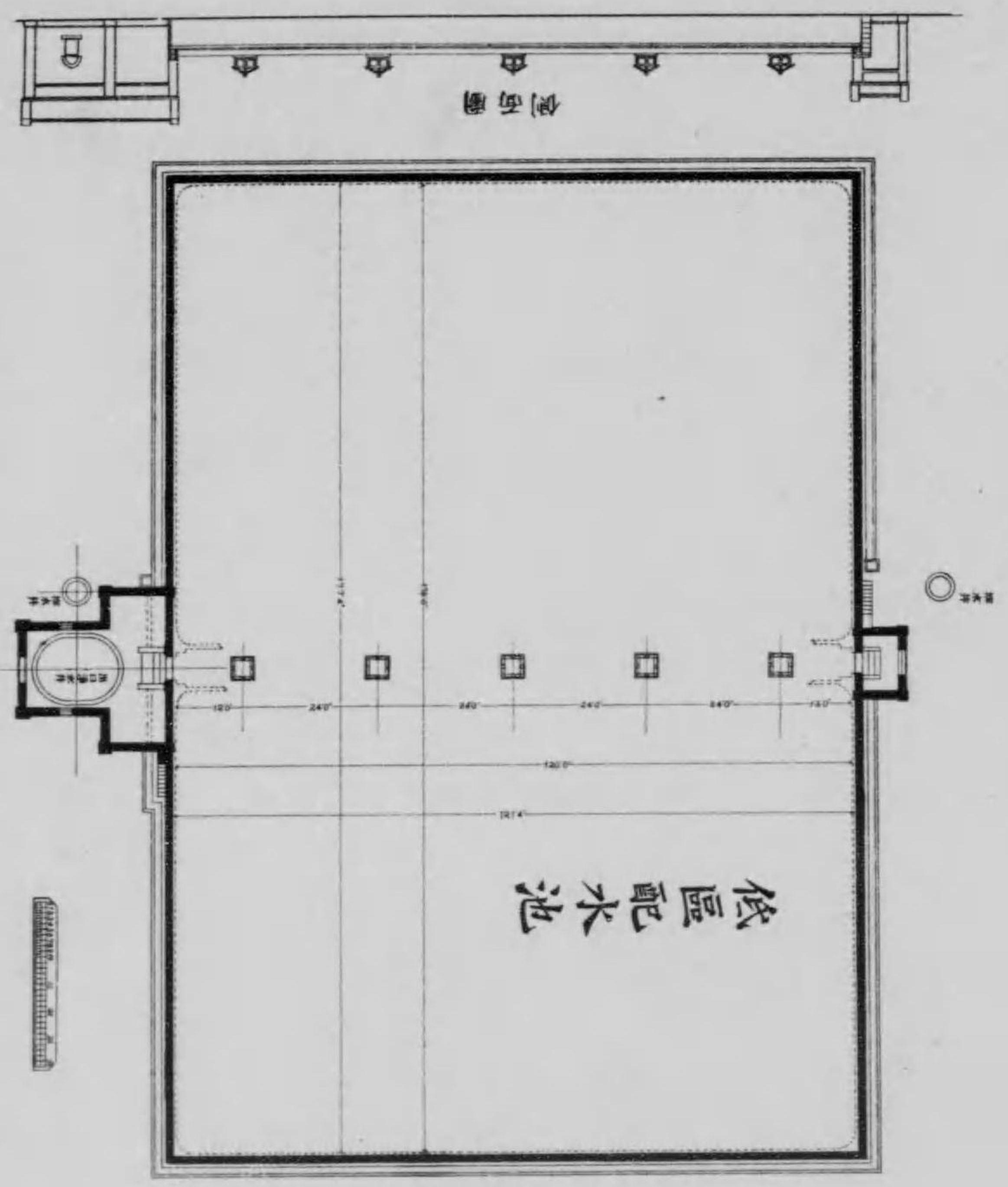

出口正面圖

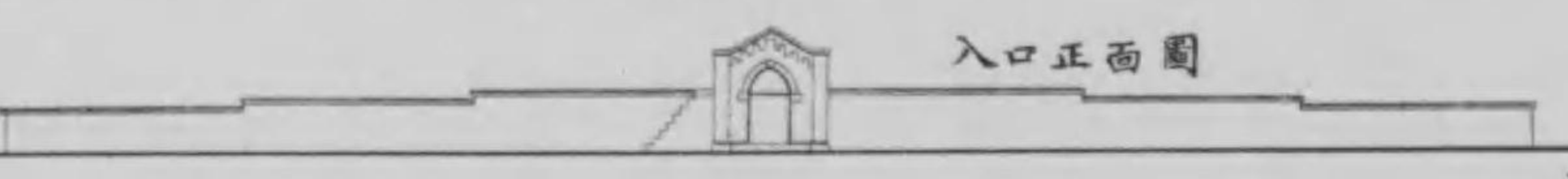

入口正面圖



入口正面圖



出口正面圖

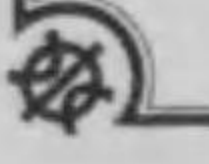
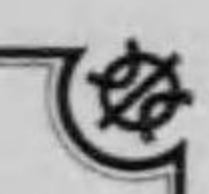

每

正面圖

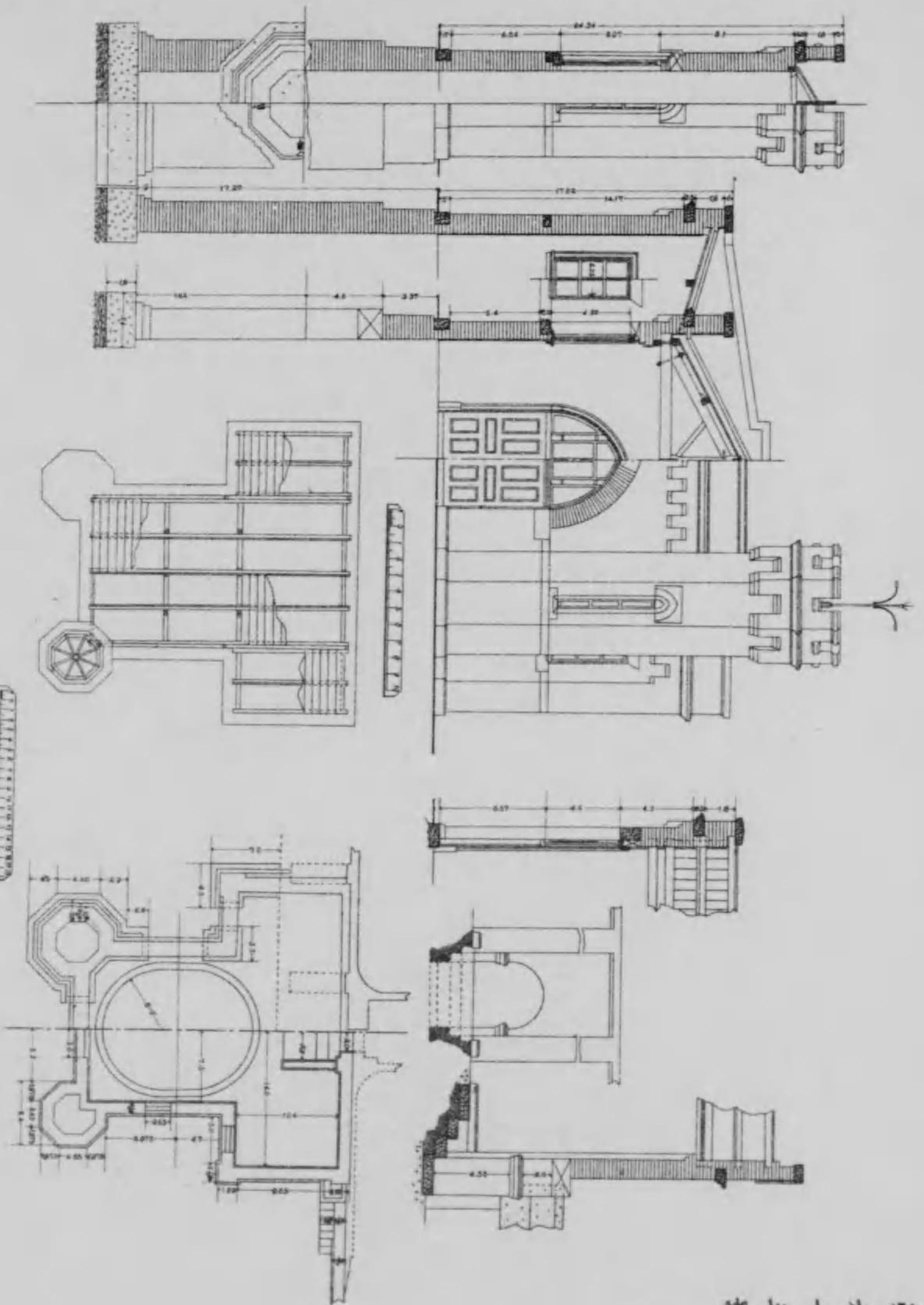

入口井上家圖

出口井上家圖

正面圖

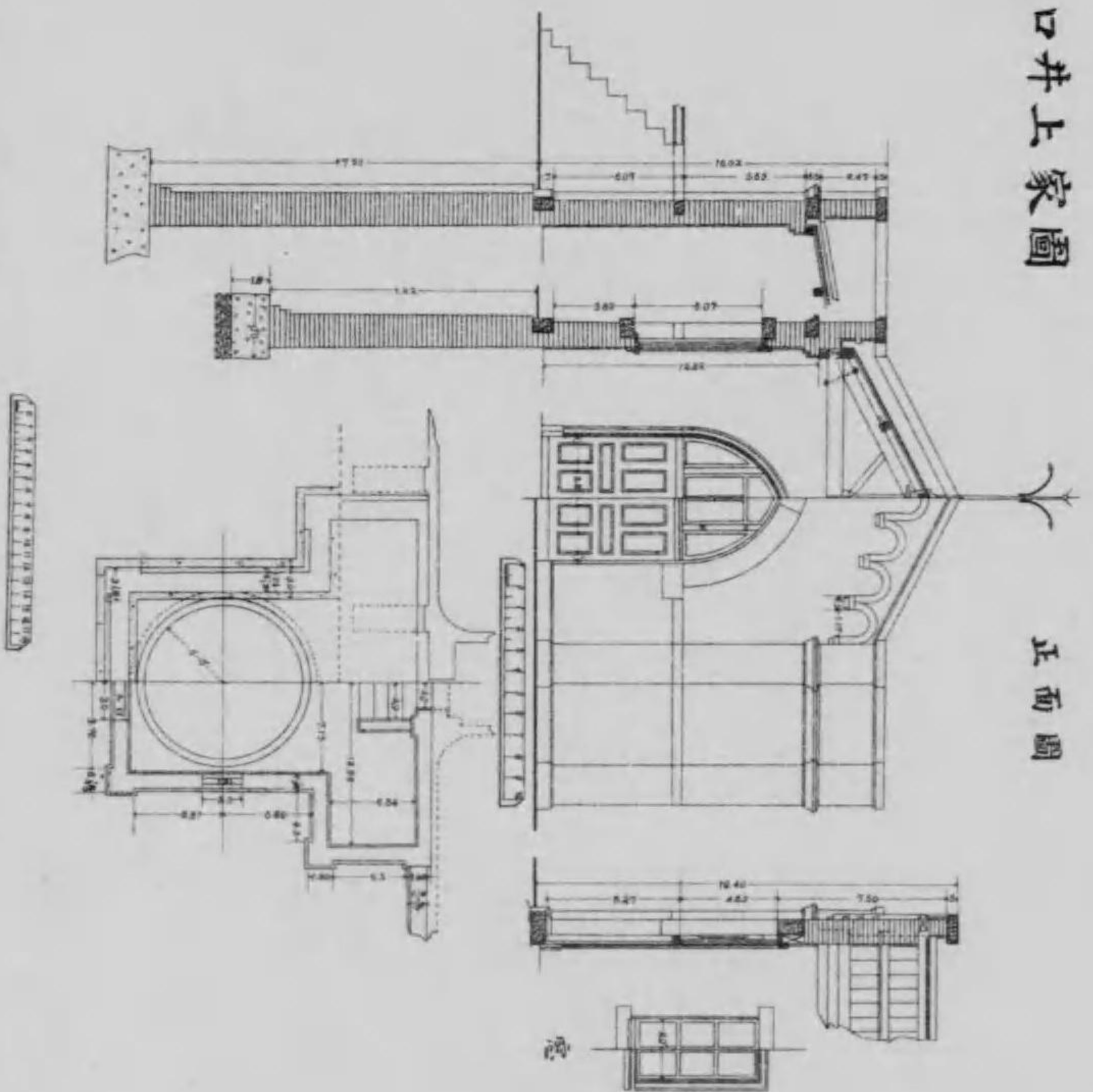

高區配水池入口井上家圖

每

每

計量器配置圖

第六十六號

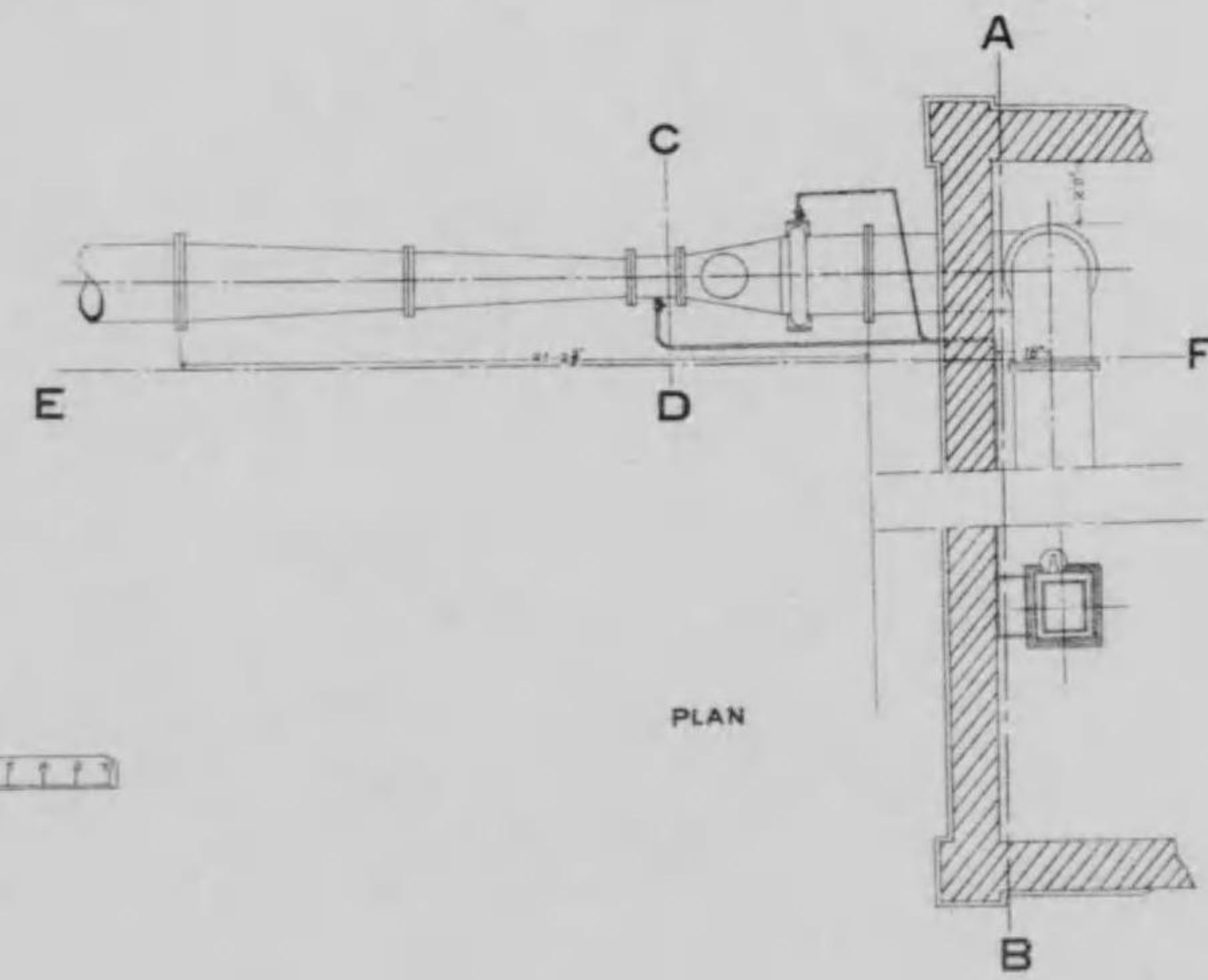
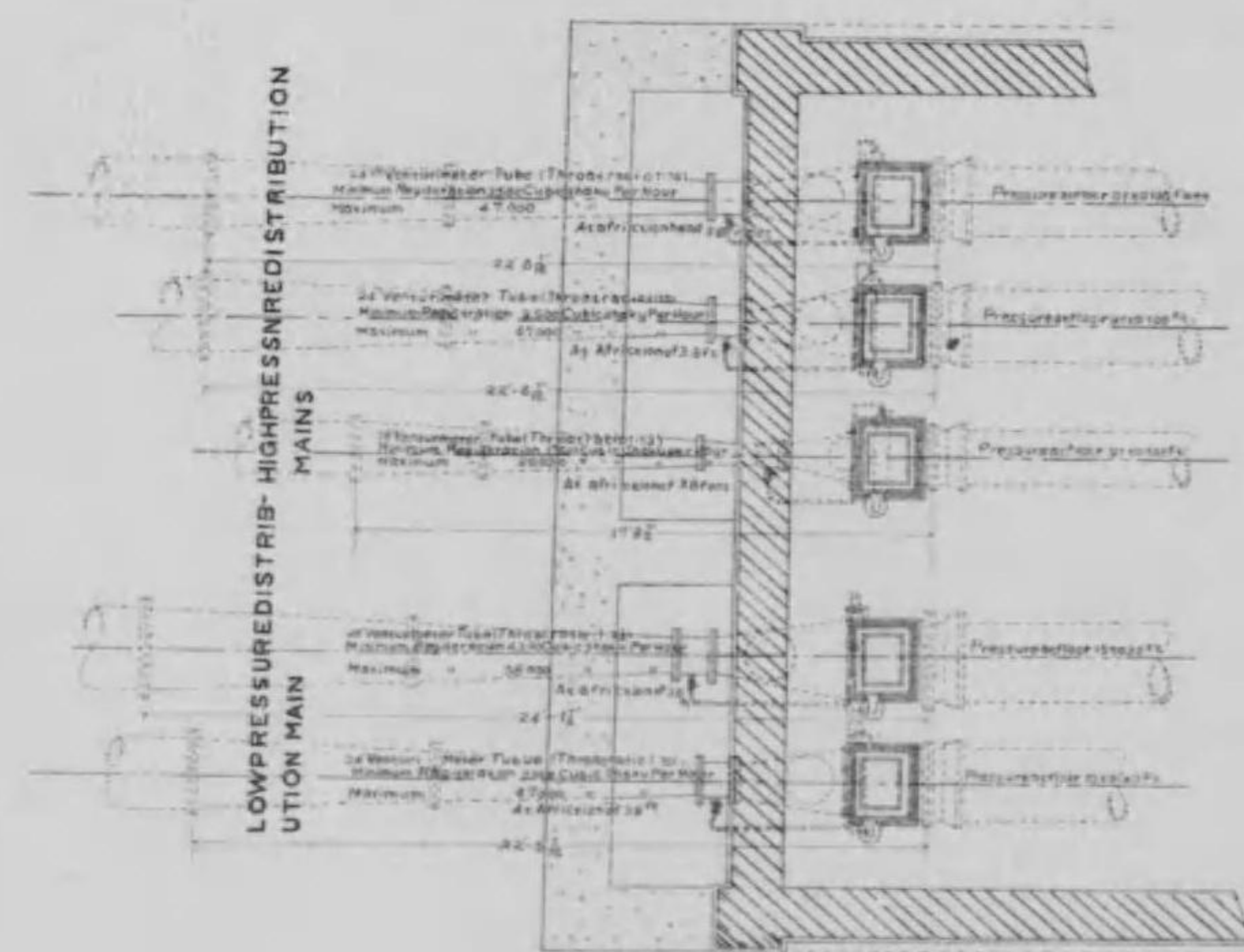
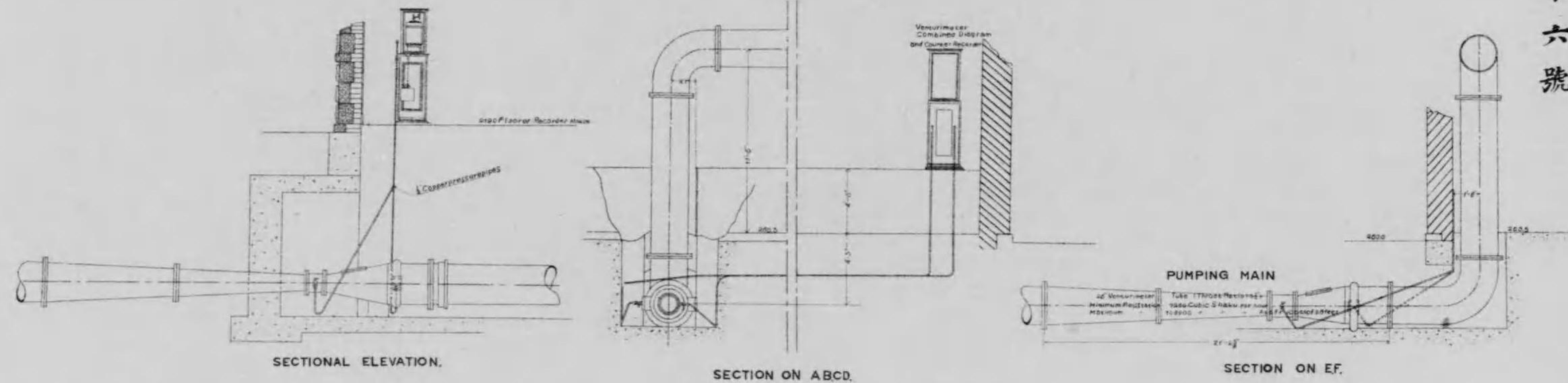

計量室地下室構造圖

第六十七號

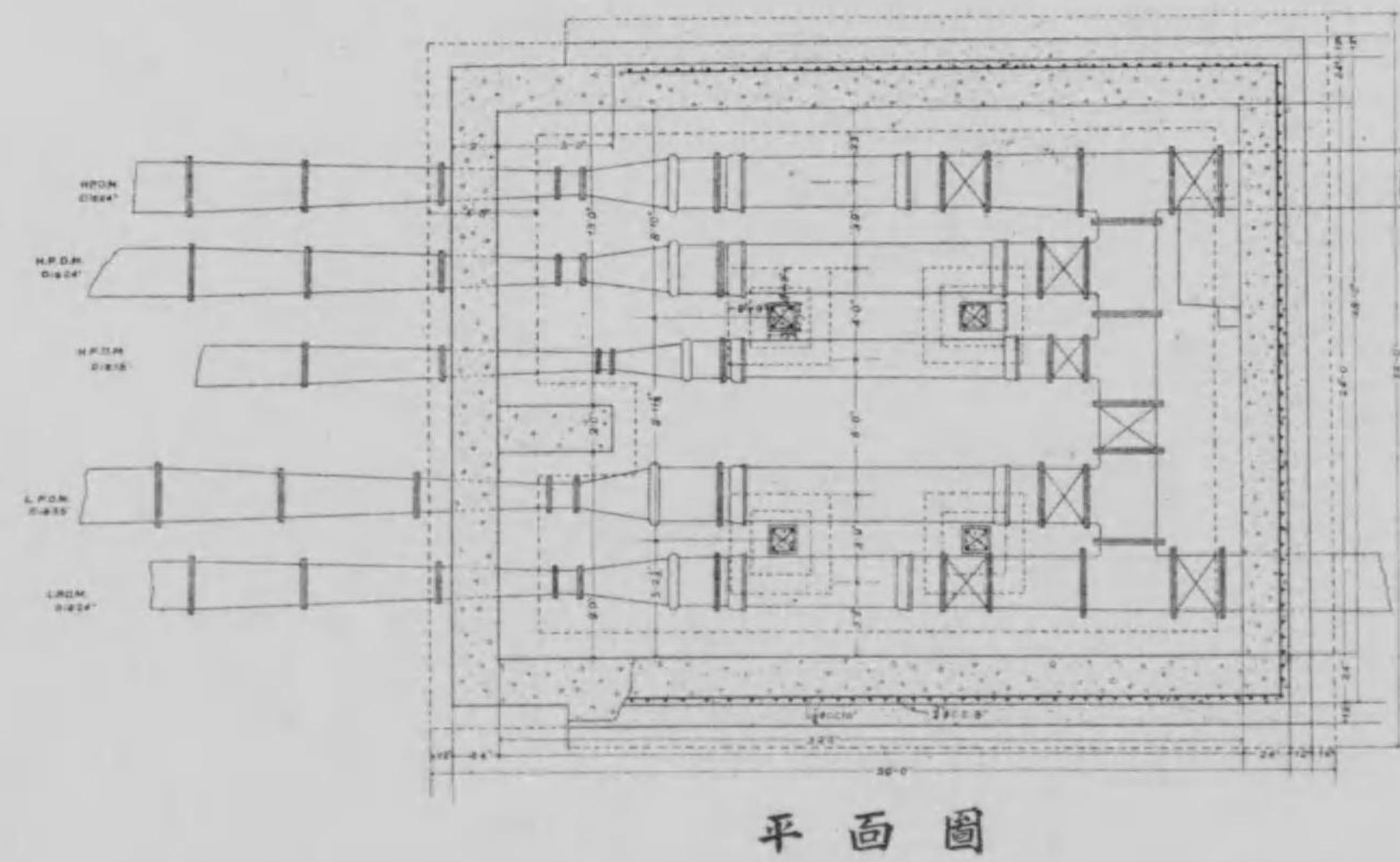
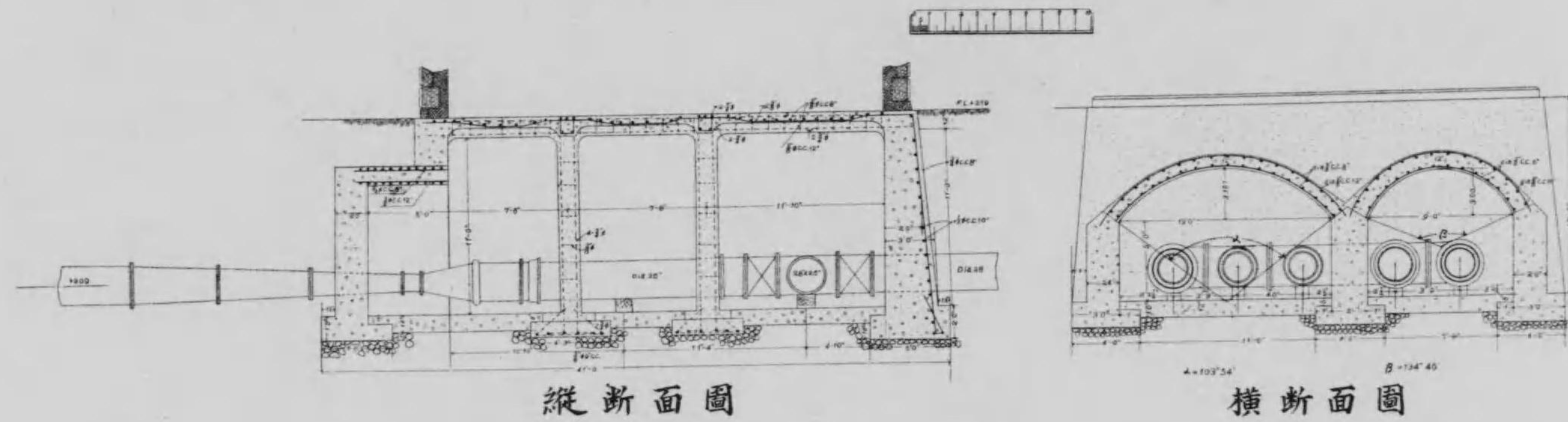

平面圖

第六十八號

計量室建圖

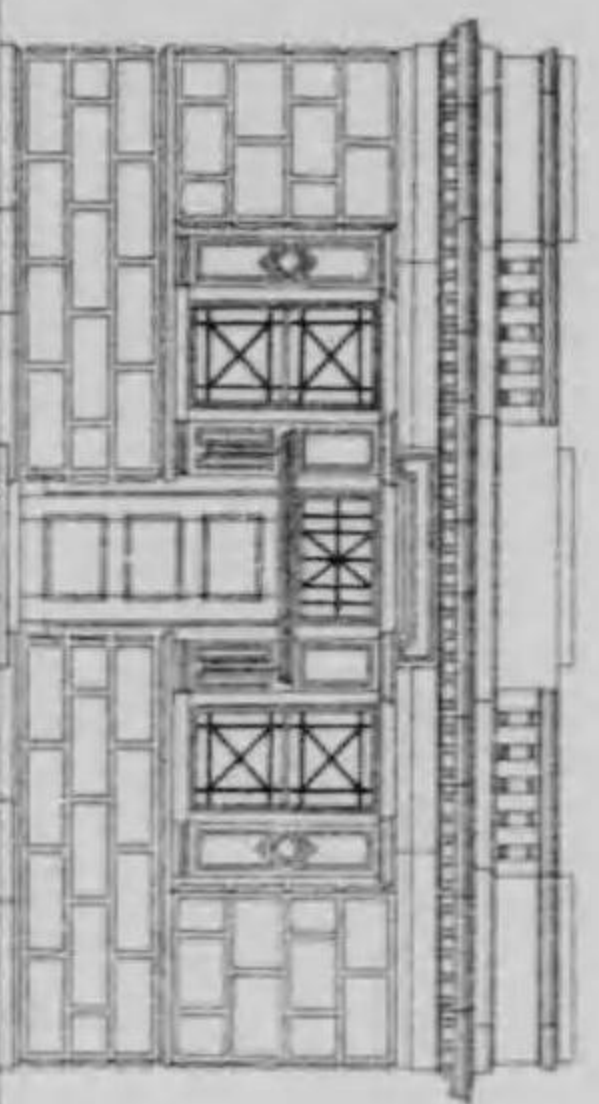
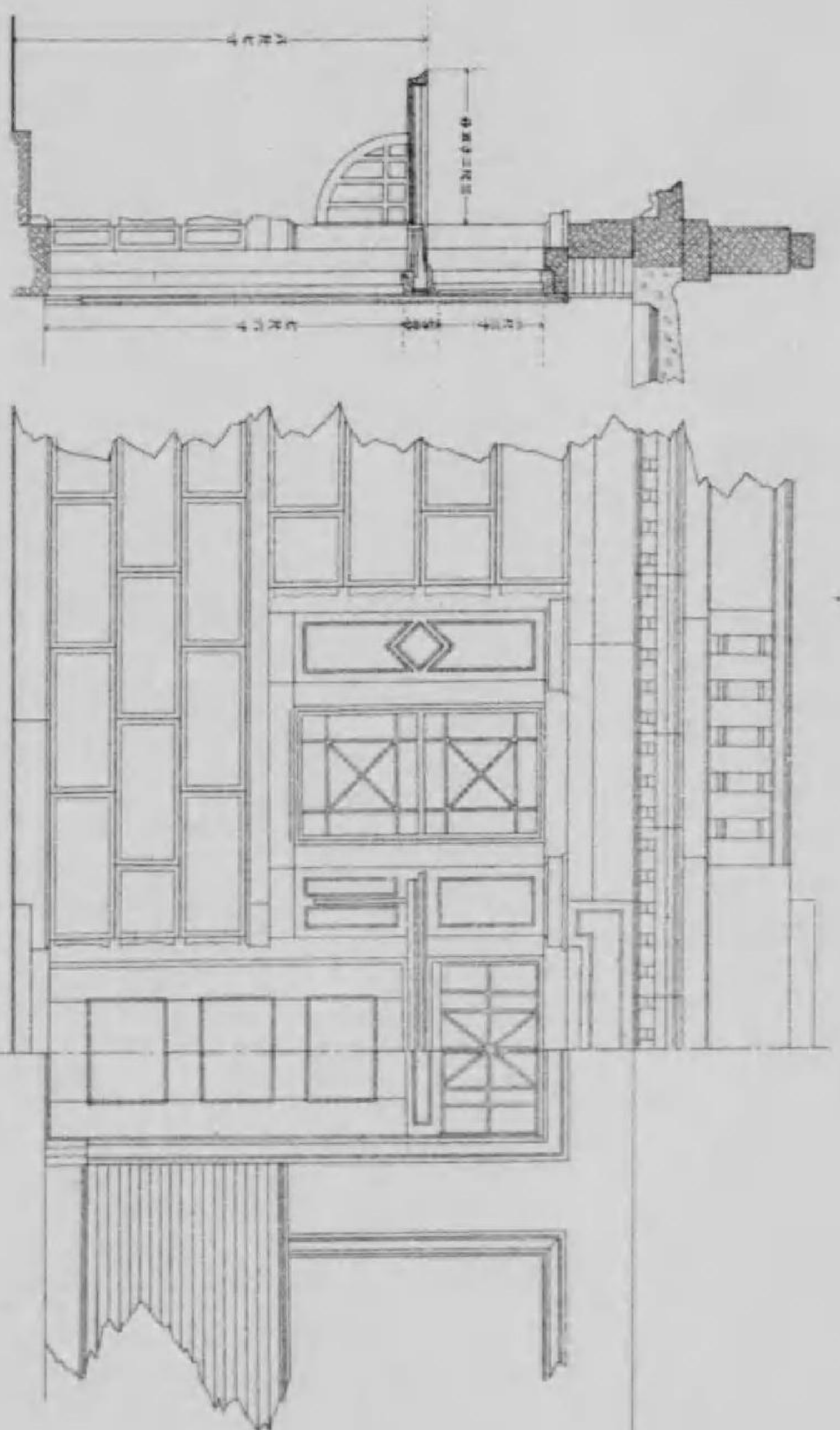

正面

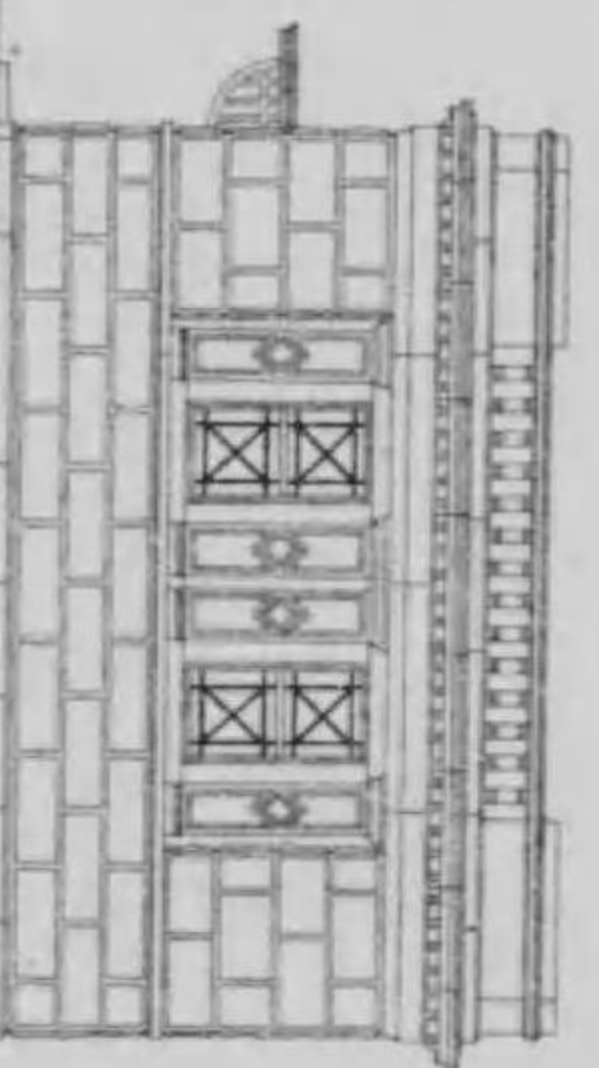

側面

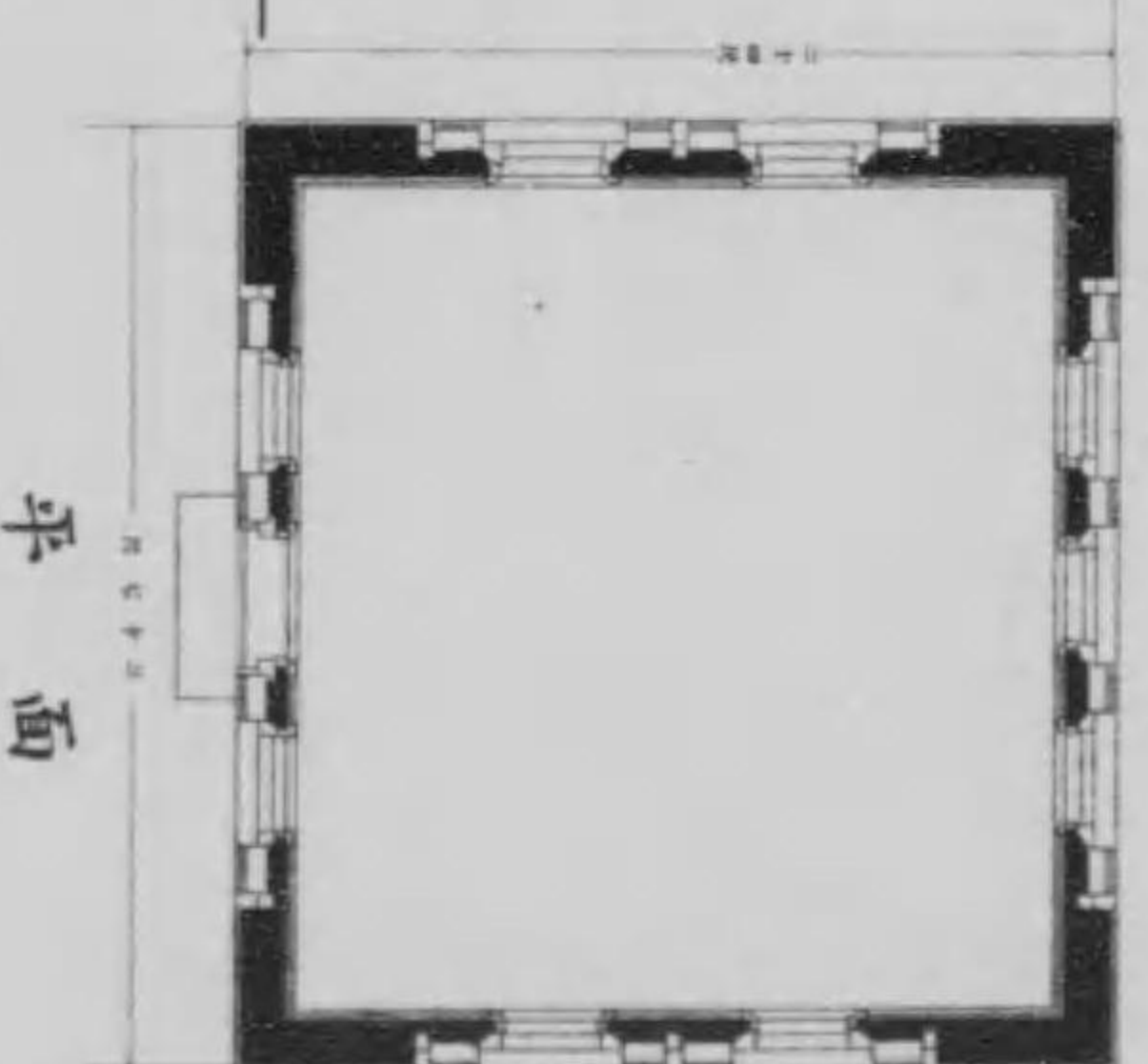

平面

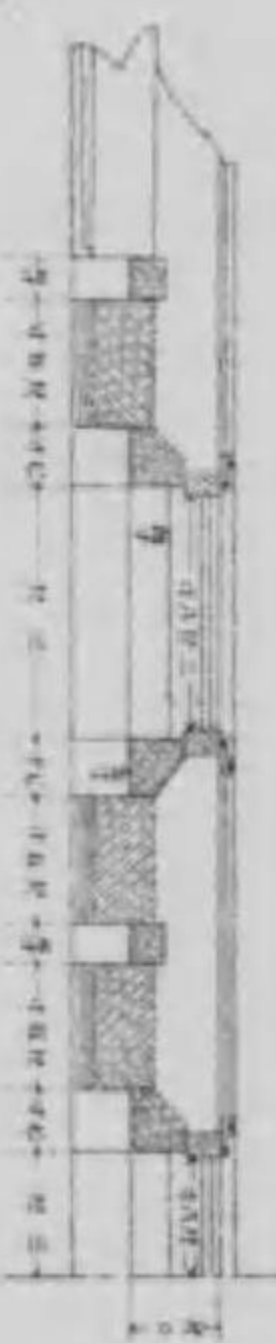
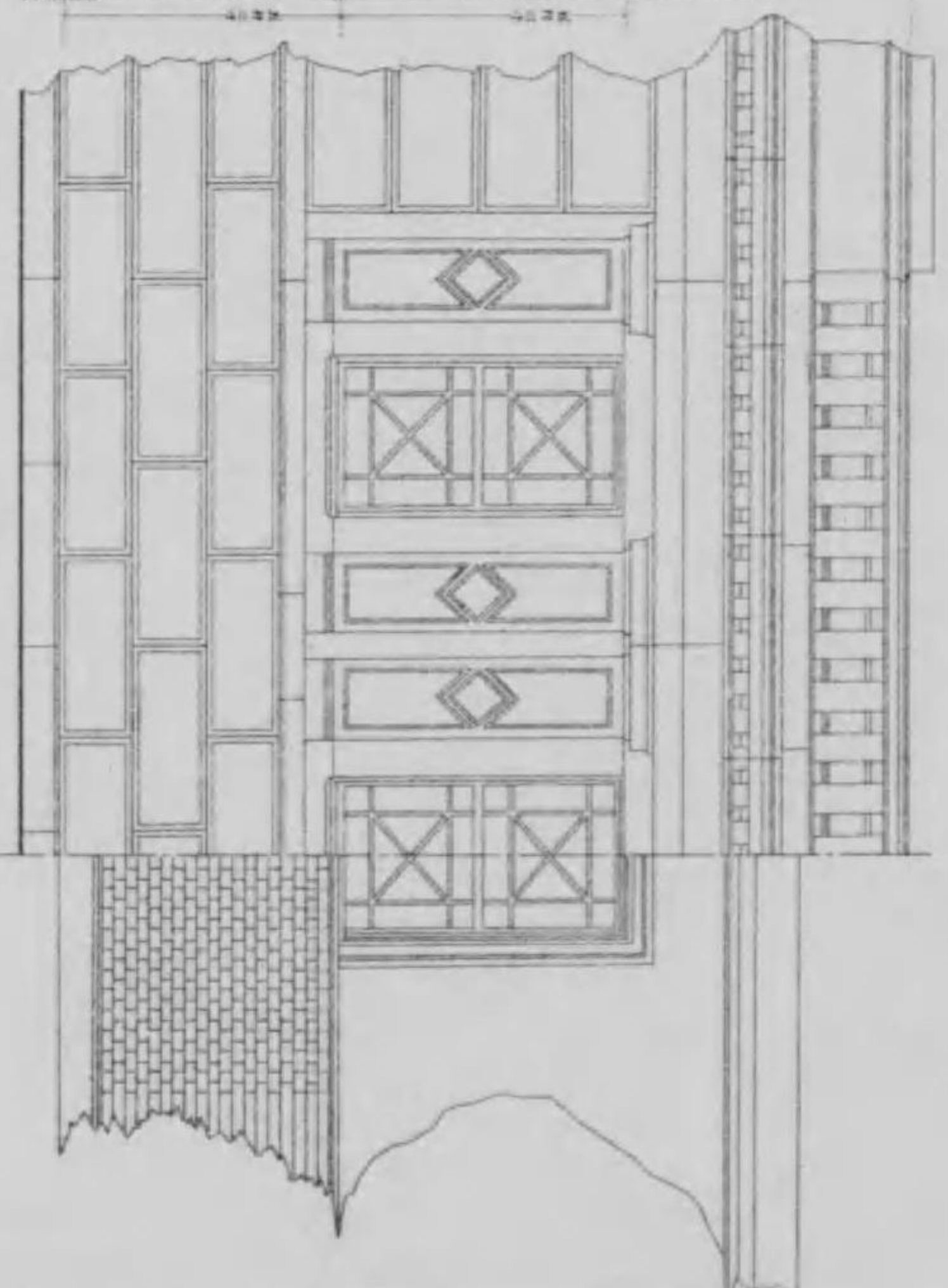
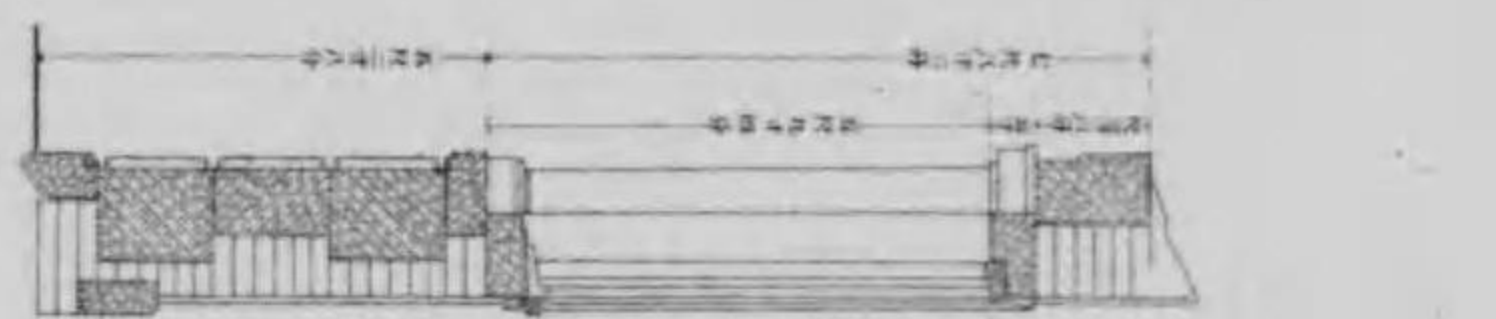
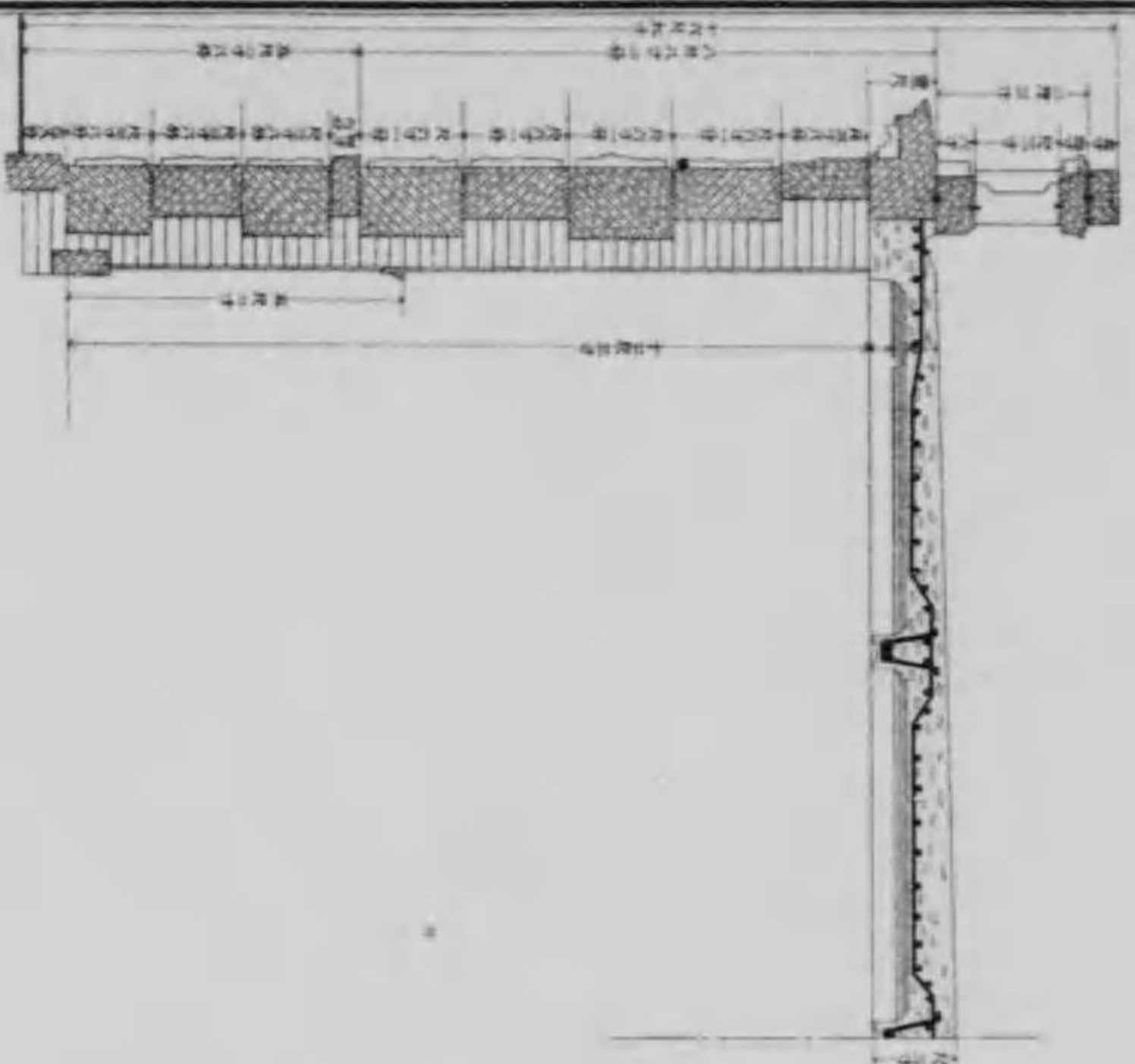

華頂川暗渠構造圖

第六十九號

縱斷圖

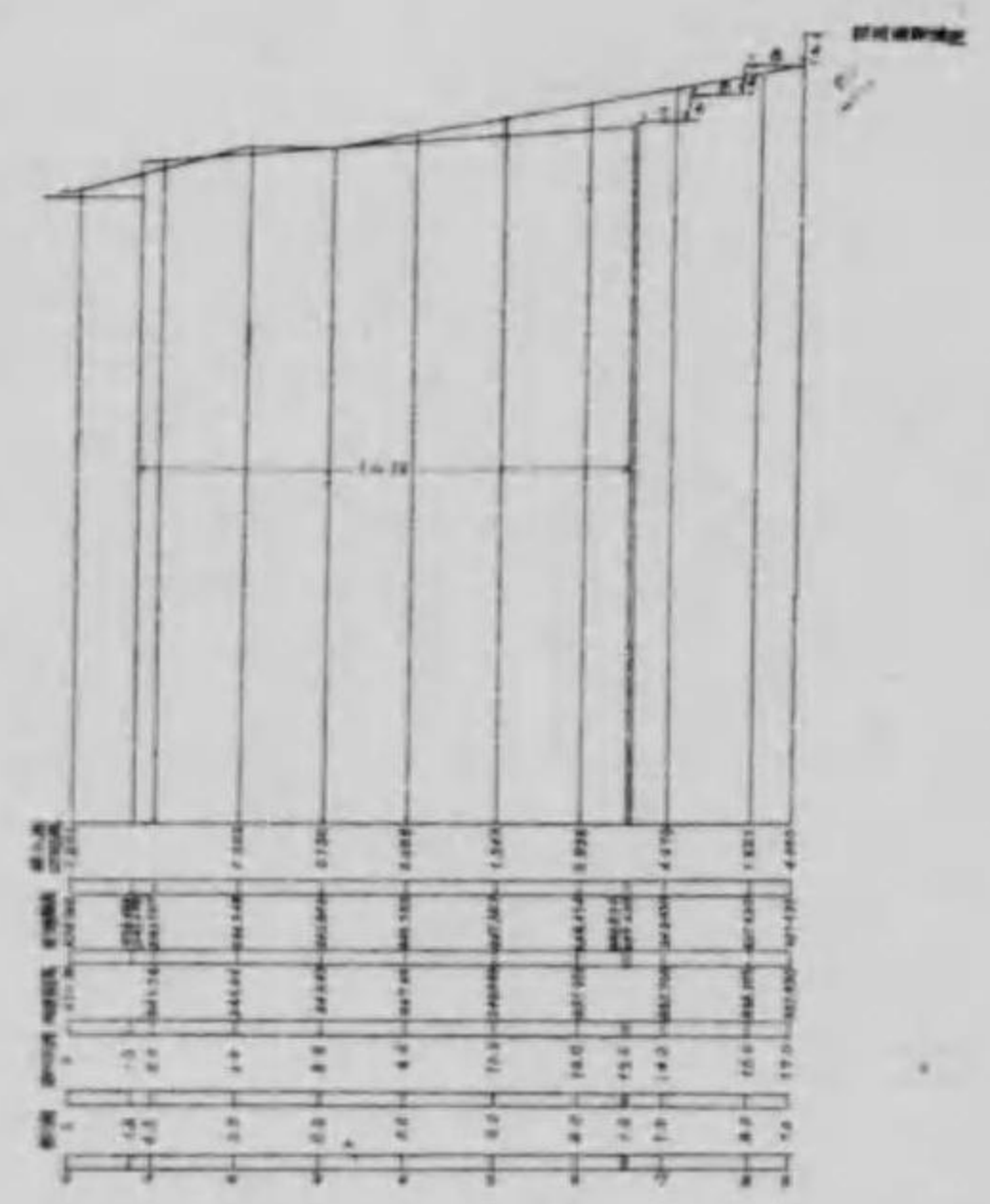

橫斷圖

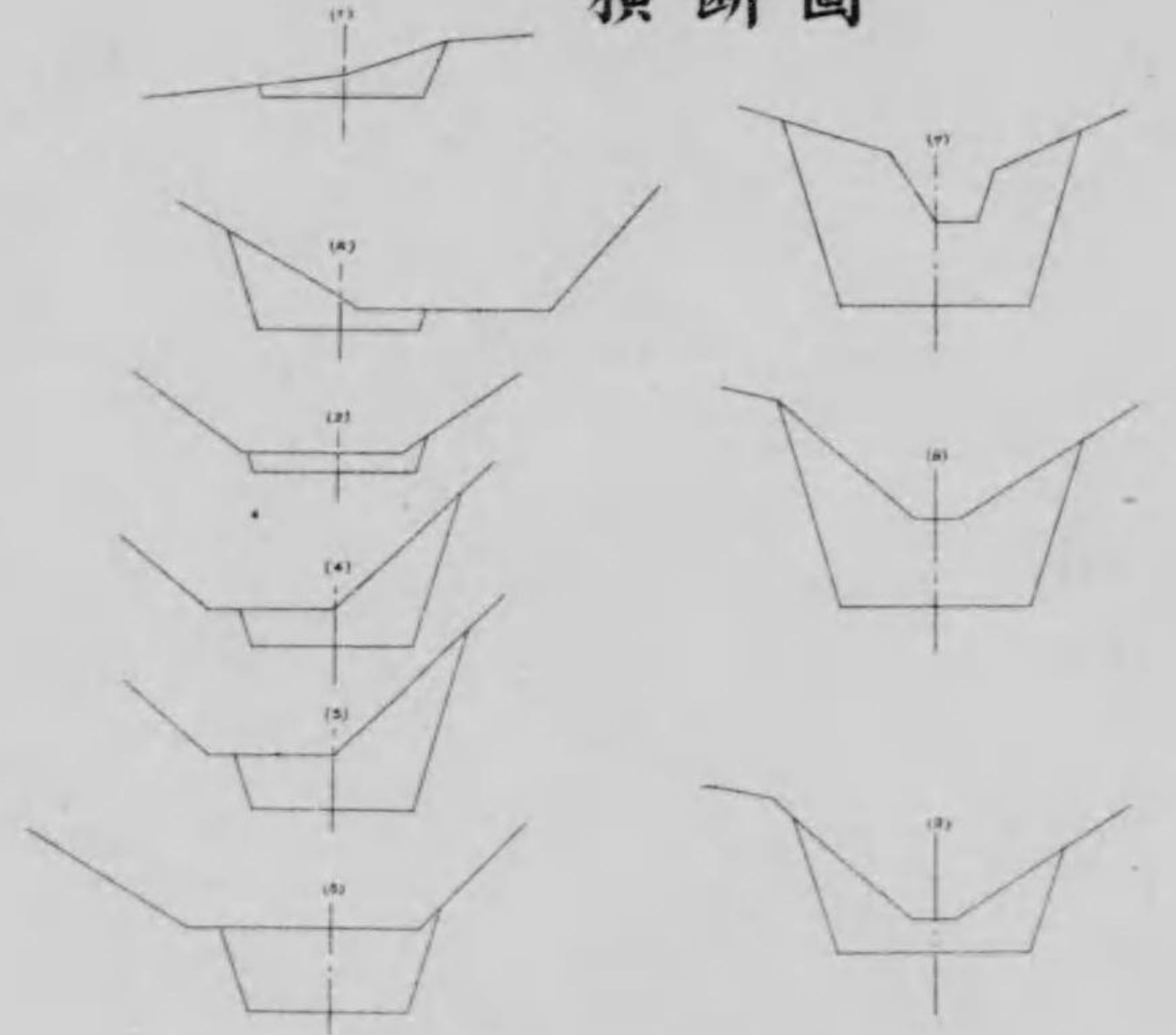

縱断面詳細圖

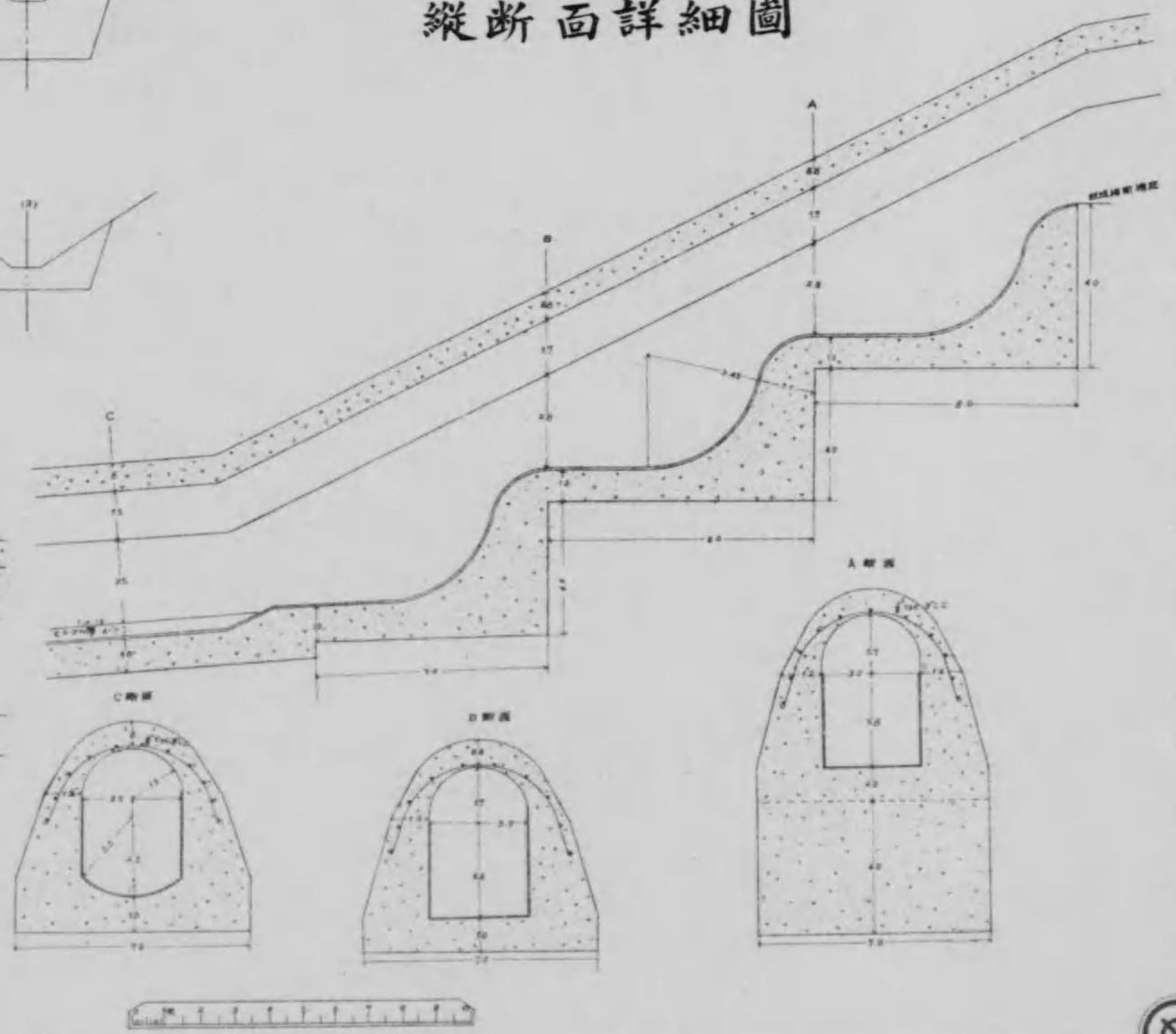

正面圖

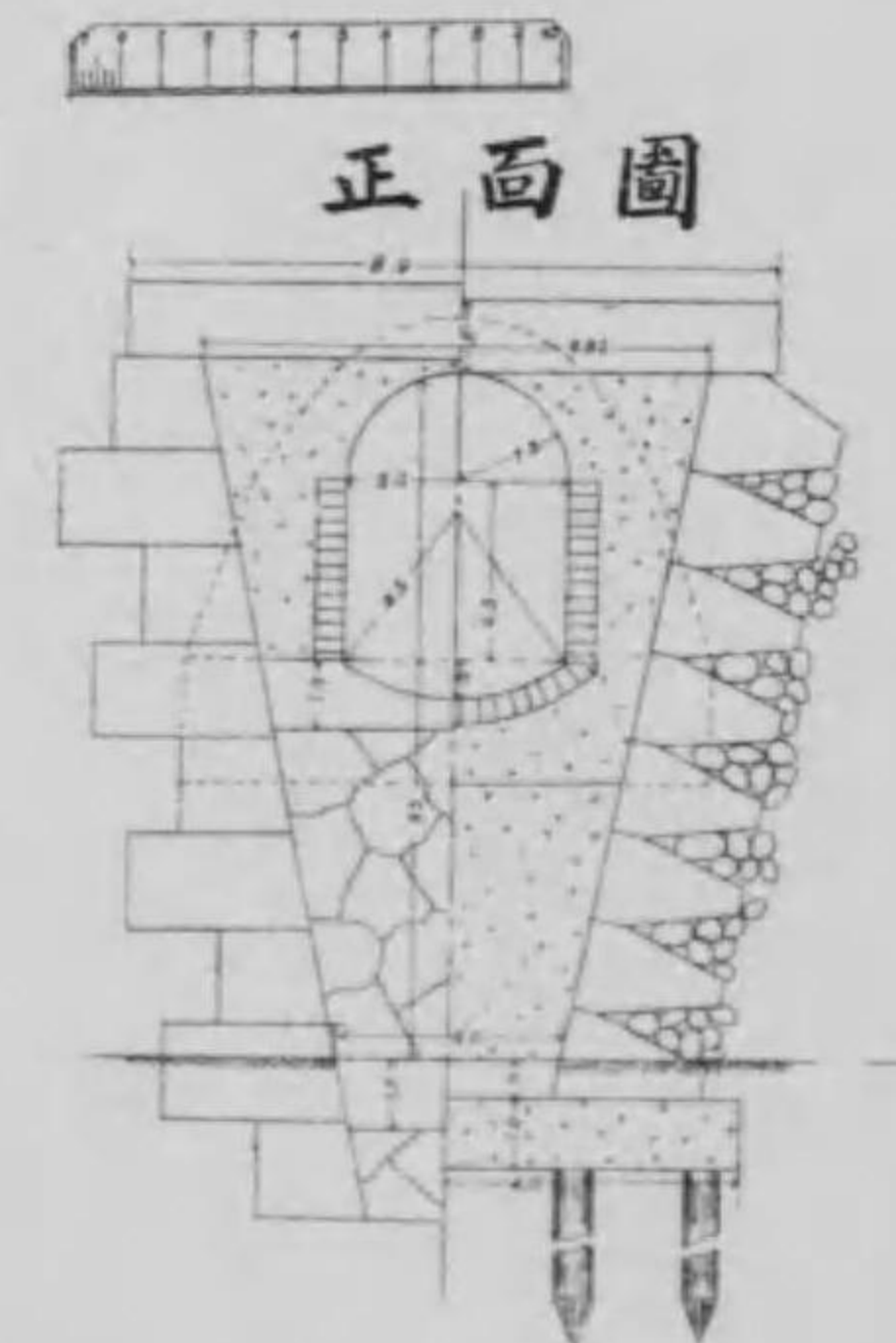

側面圖



高區配水池東法裾石垣及地下渠構造圖

第七十號

平面圖

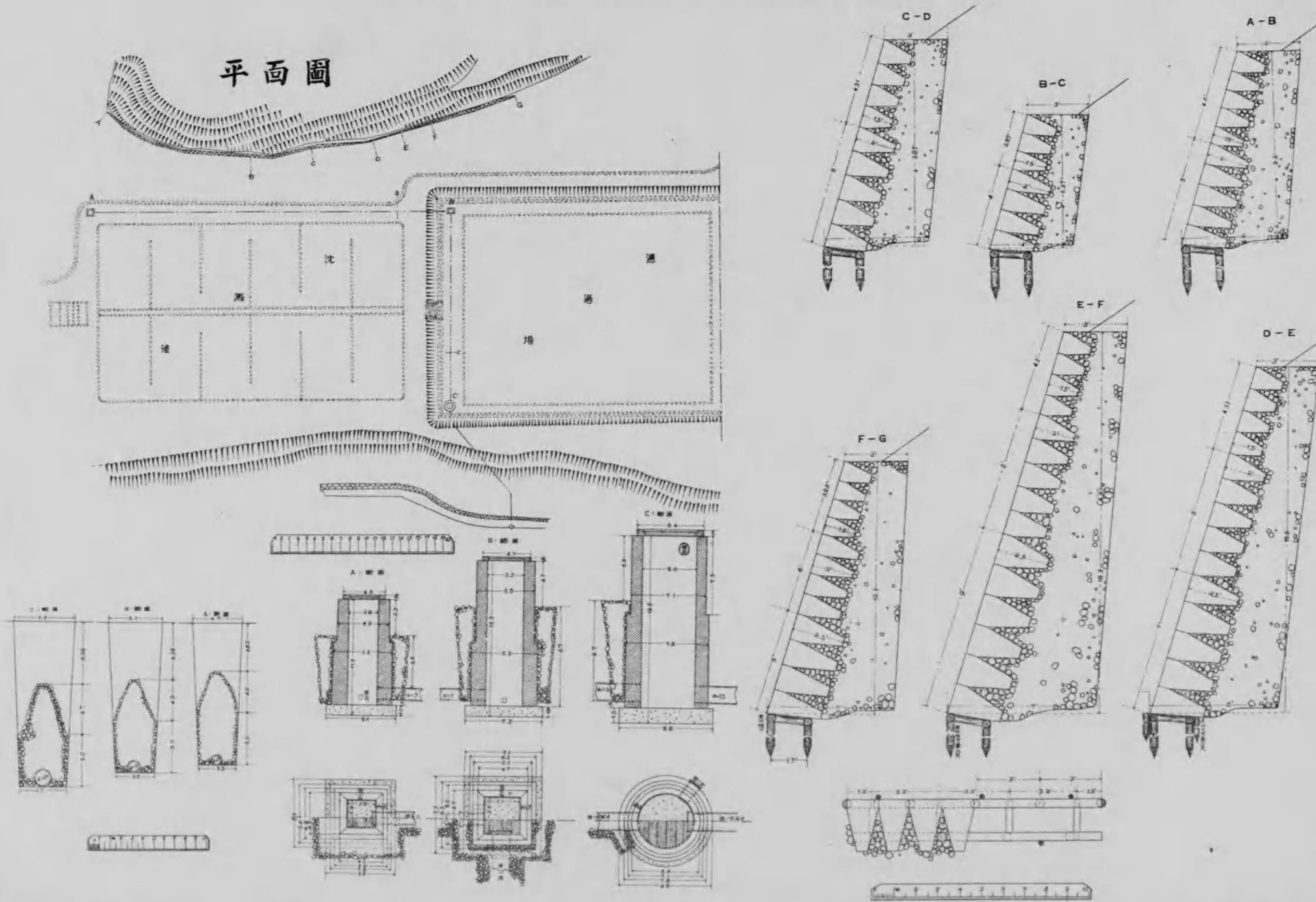

淨水地東法裙石垣圖

第七十一號

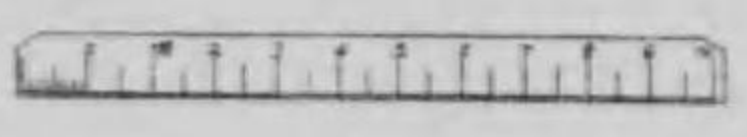
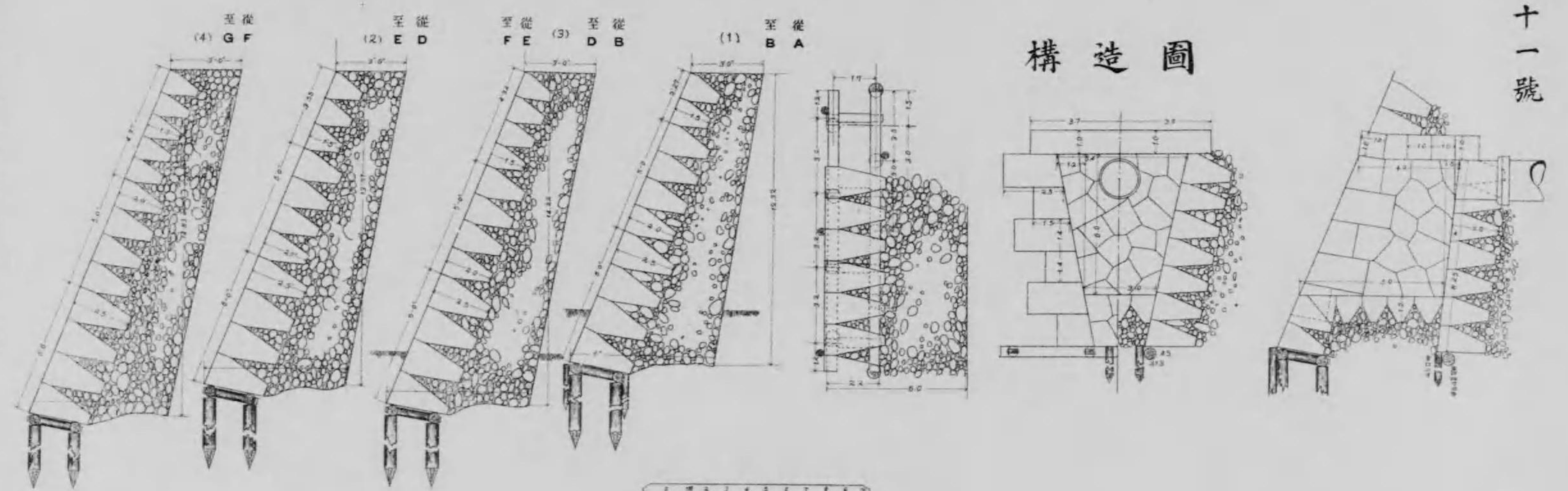

平面圖

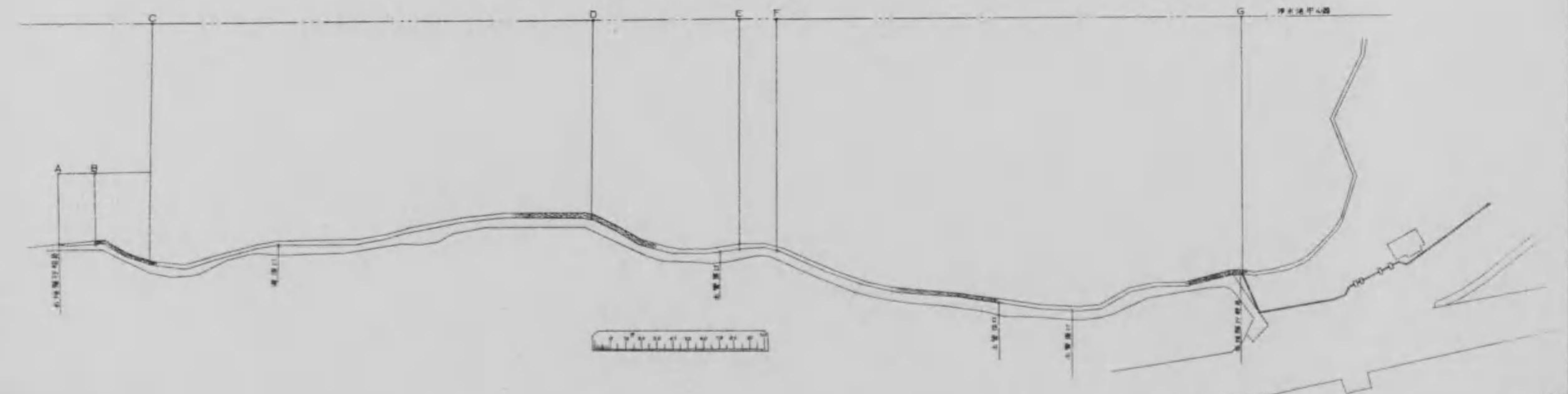

圖橋管鐵道廣水疏

第七十二號

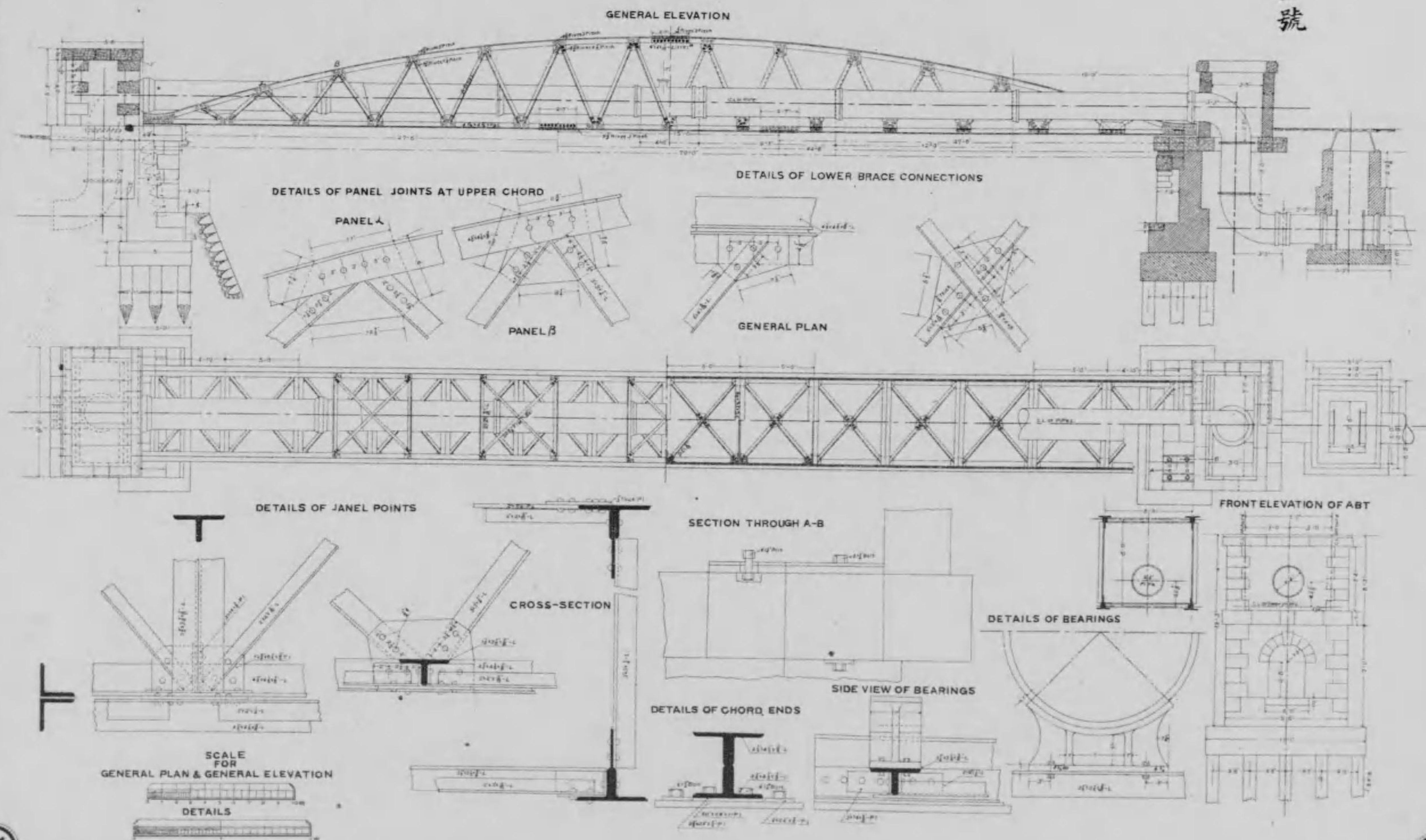

圖橋管鉄條二水疏

第七十三號

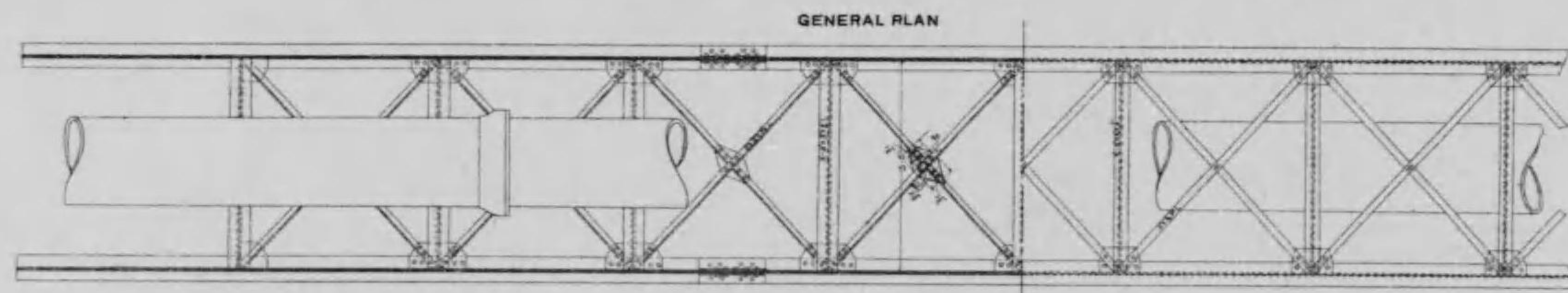
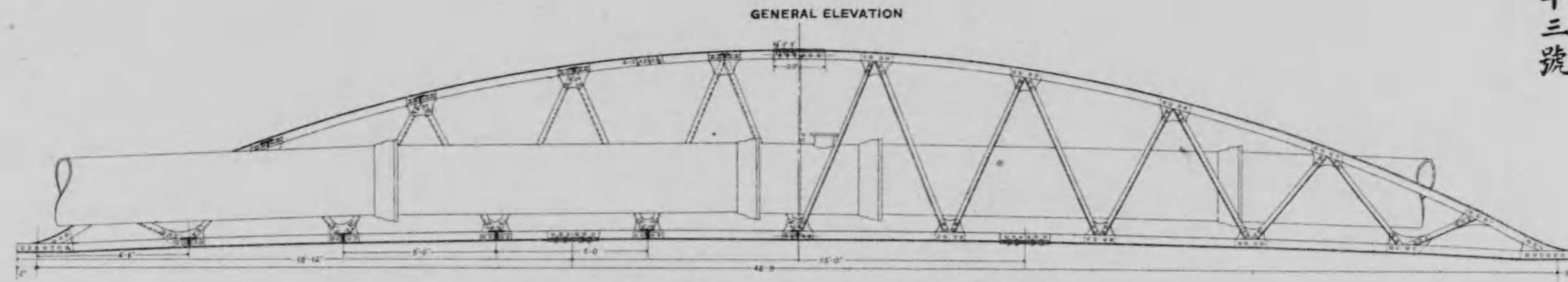

DETAILS OF PANEL JOINTS AT UPPER CHORD

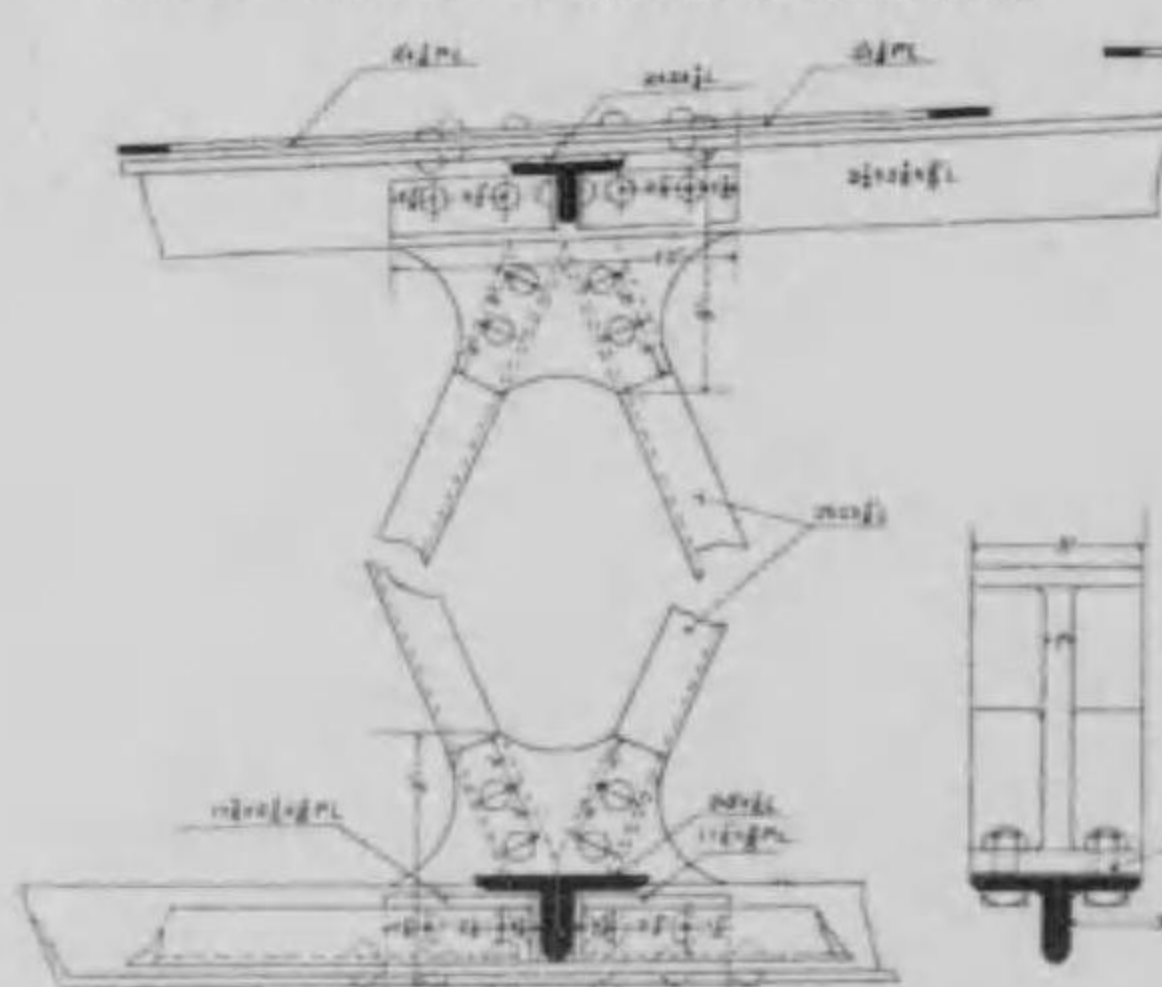

DETAILS OF PANEL JOINTS

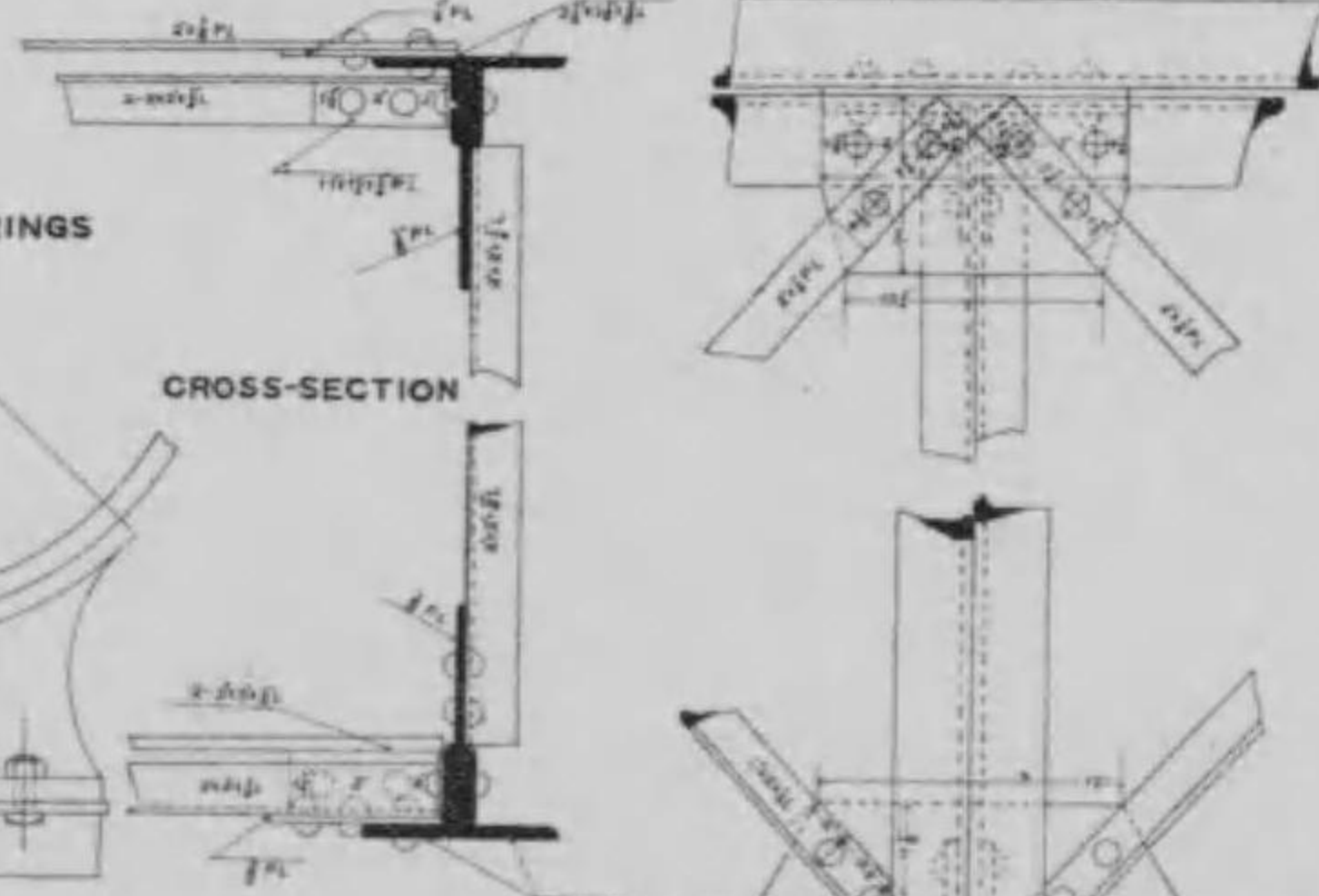

DETAILS OF BEARINGS

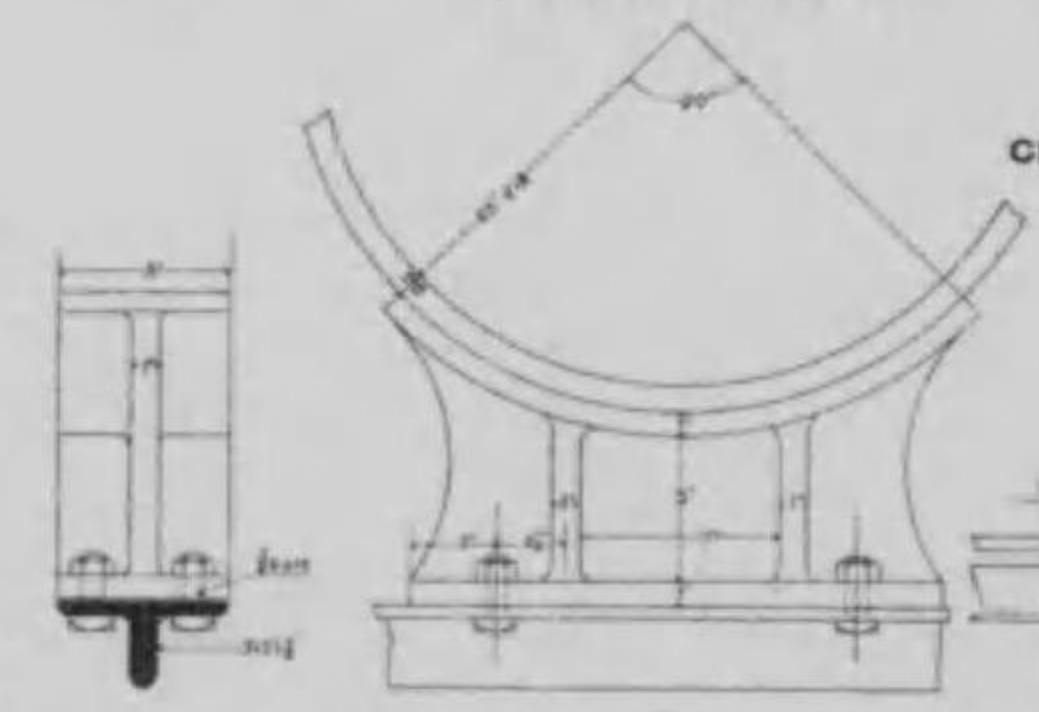

CROSS-SECTION

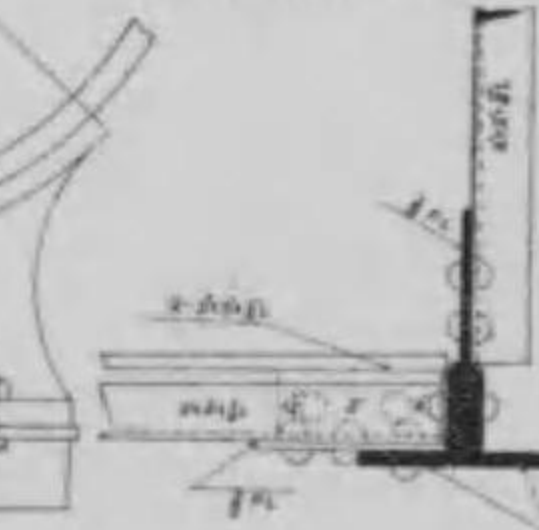

DETAILS OF PANEL JOINTS AT LOWER CHORD

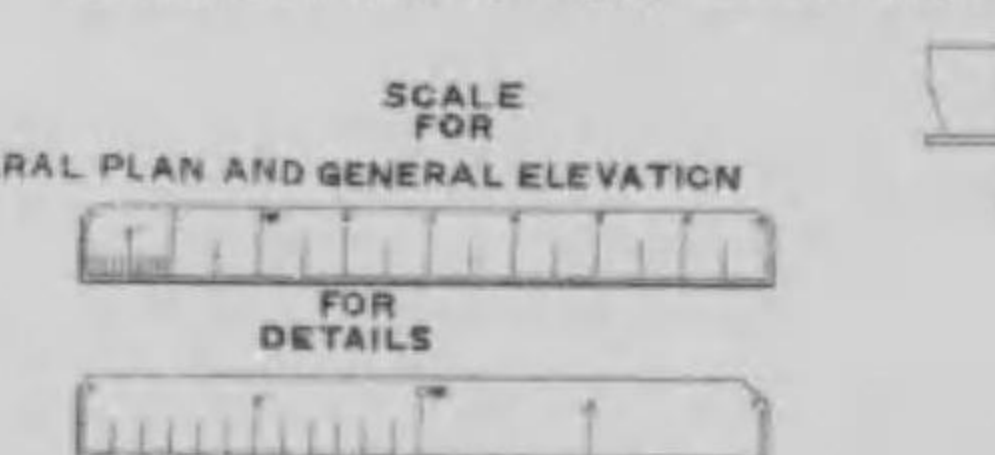

JOINT OF CHORD

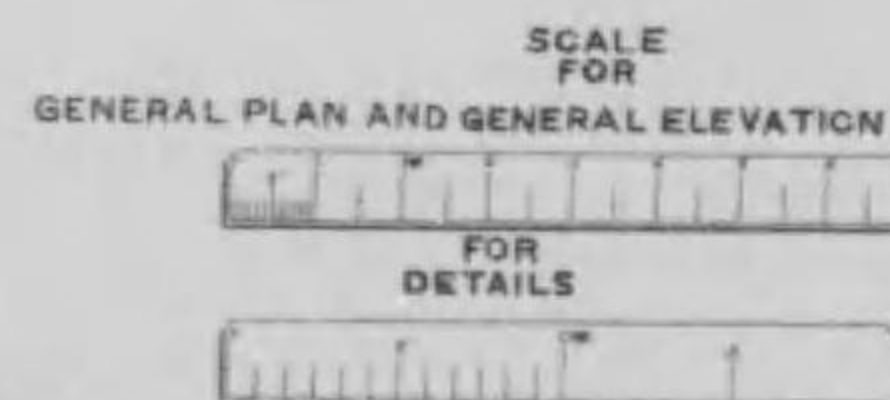
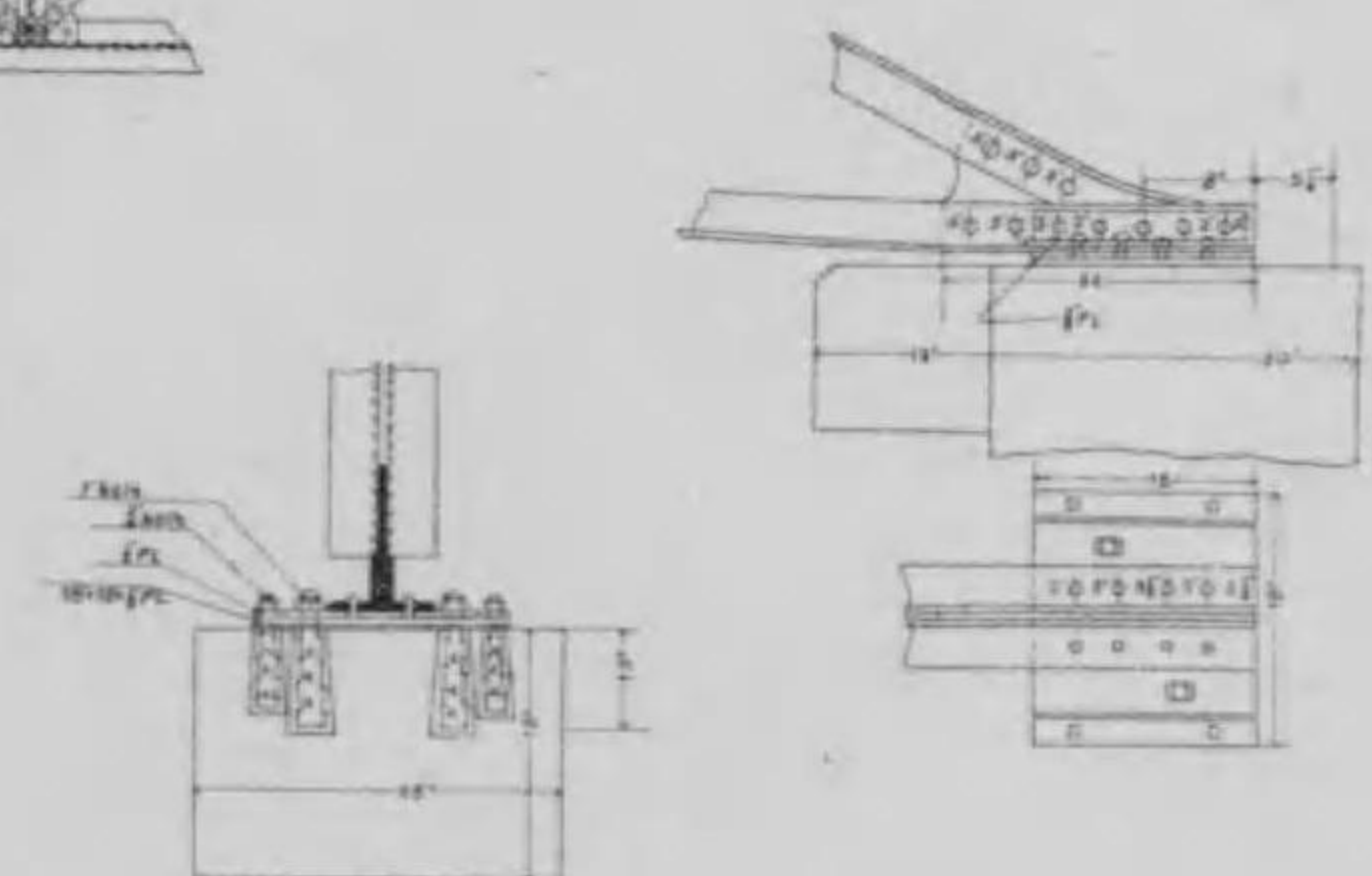
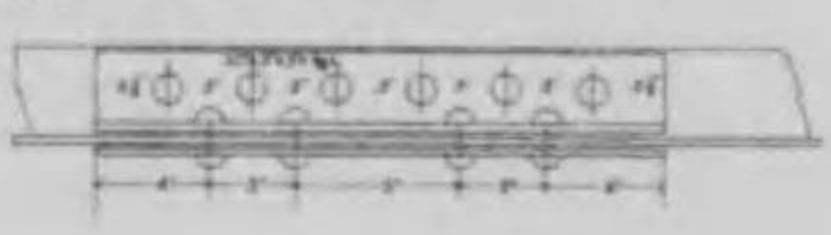

新一條鴨川橫斷布設圖

第七十四號

平面詳細圖

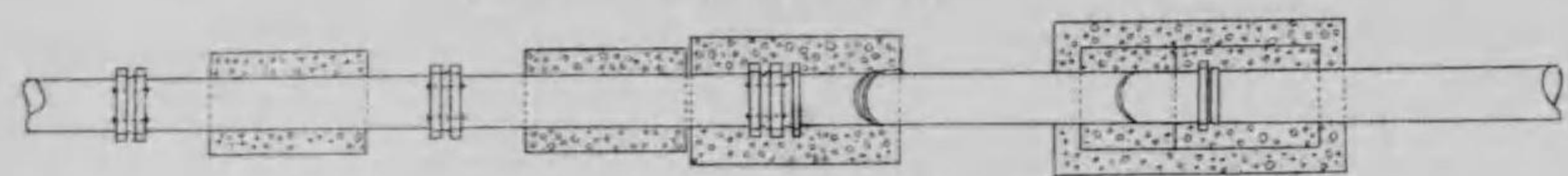

平面圖

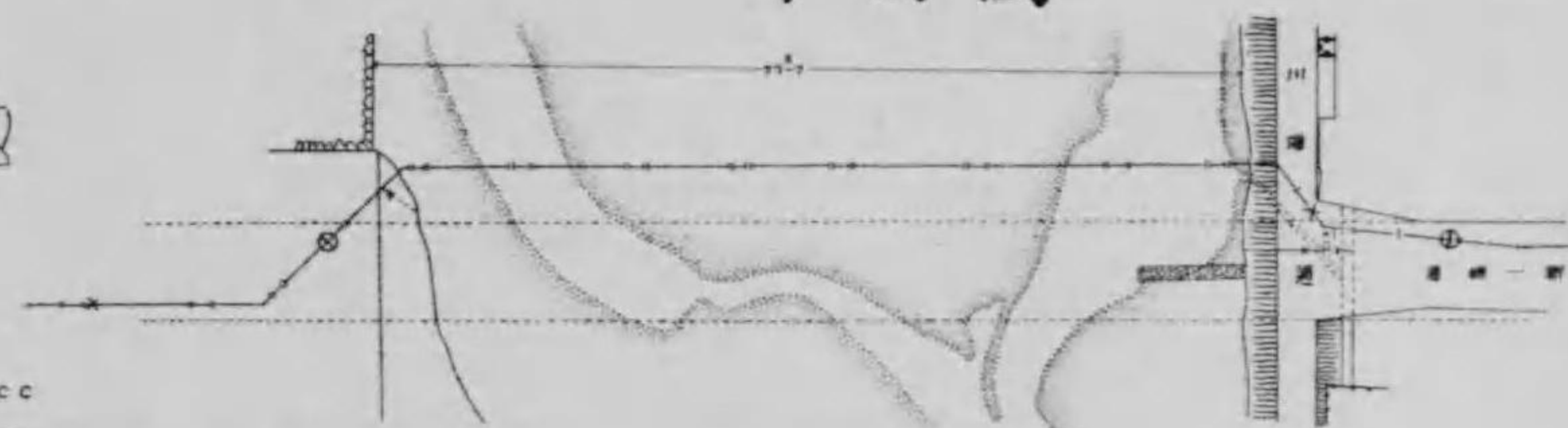

縱断面詳細圖

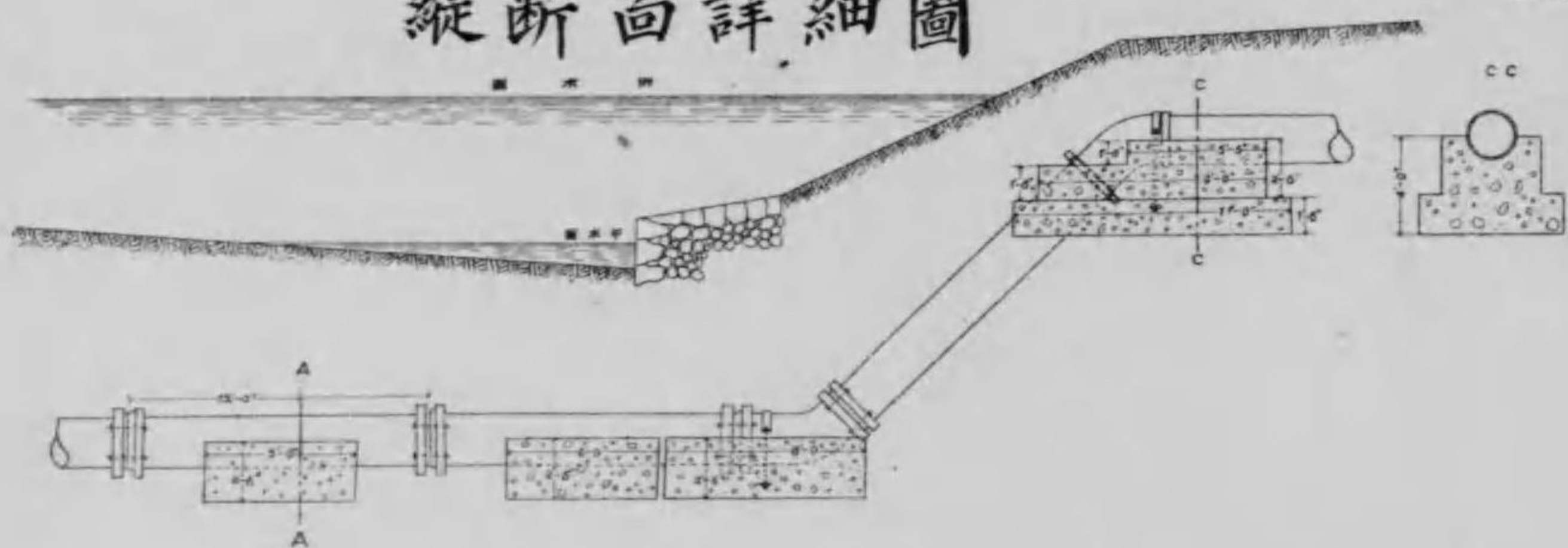

縱断面圖

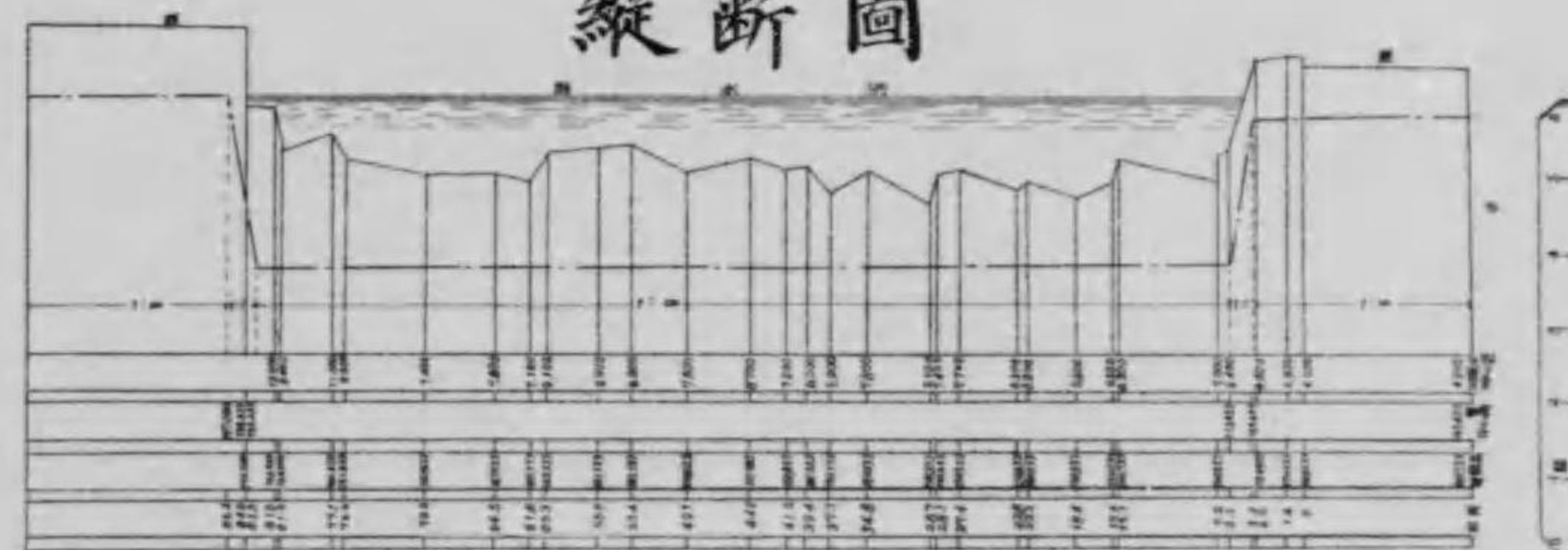

鉛止器之圖

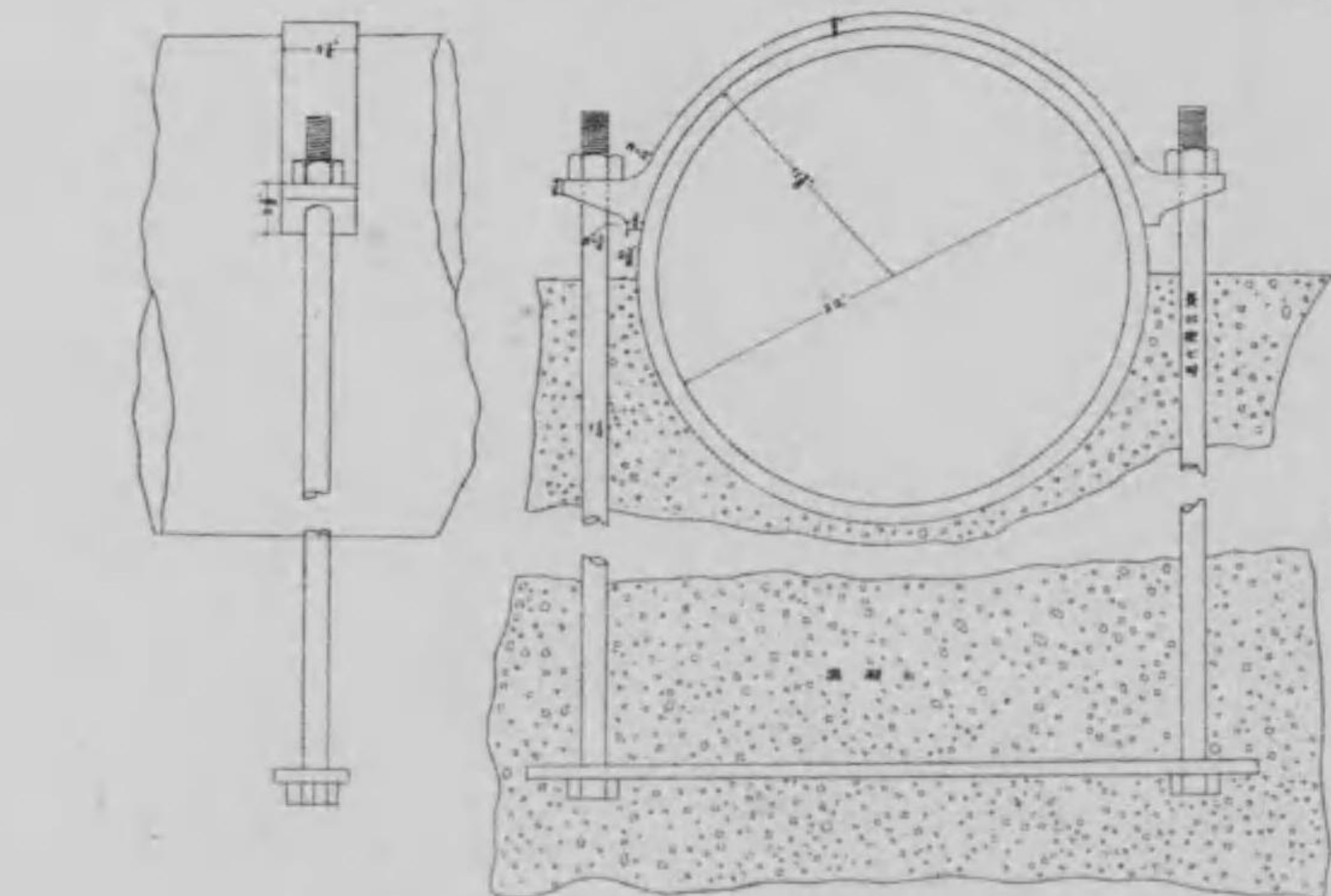

水中作業器之圖

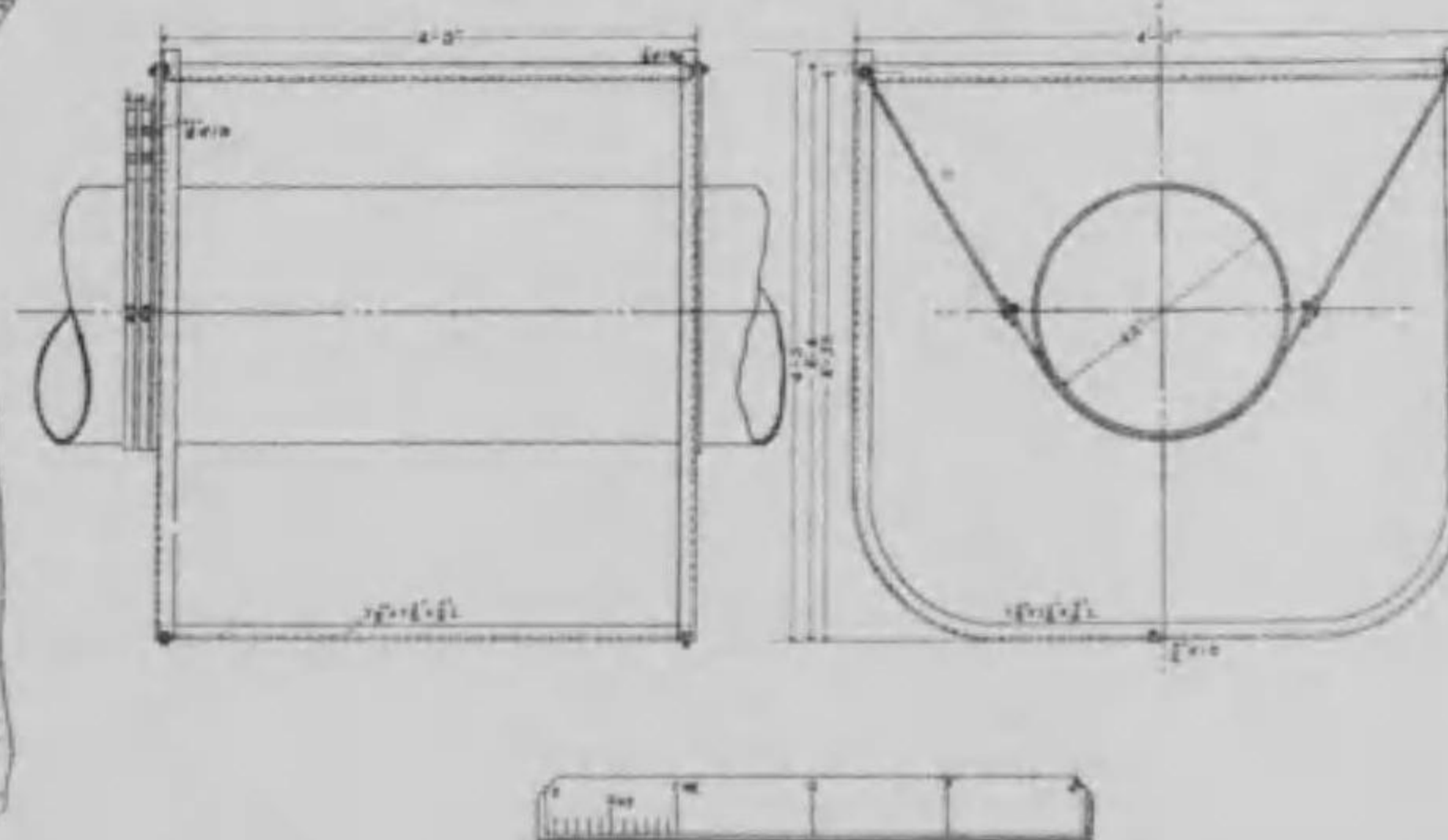

二條鴨川横断布設圖

第七十五號

縦断面詳細圖

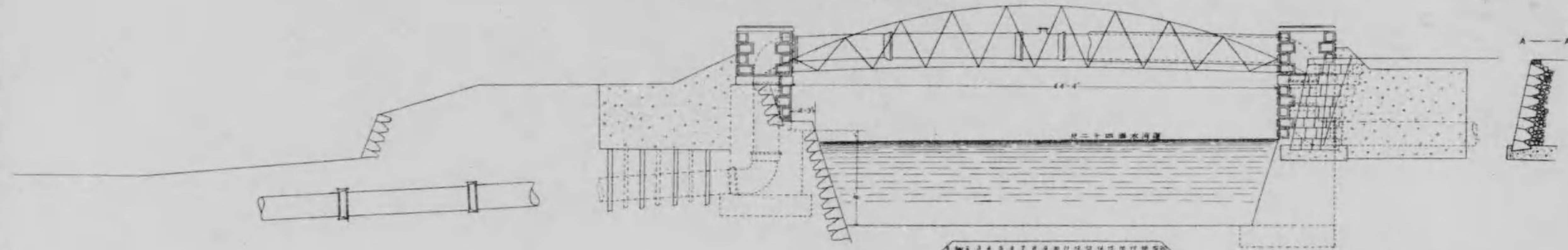

運河西側橋台

運河東側橋台

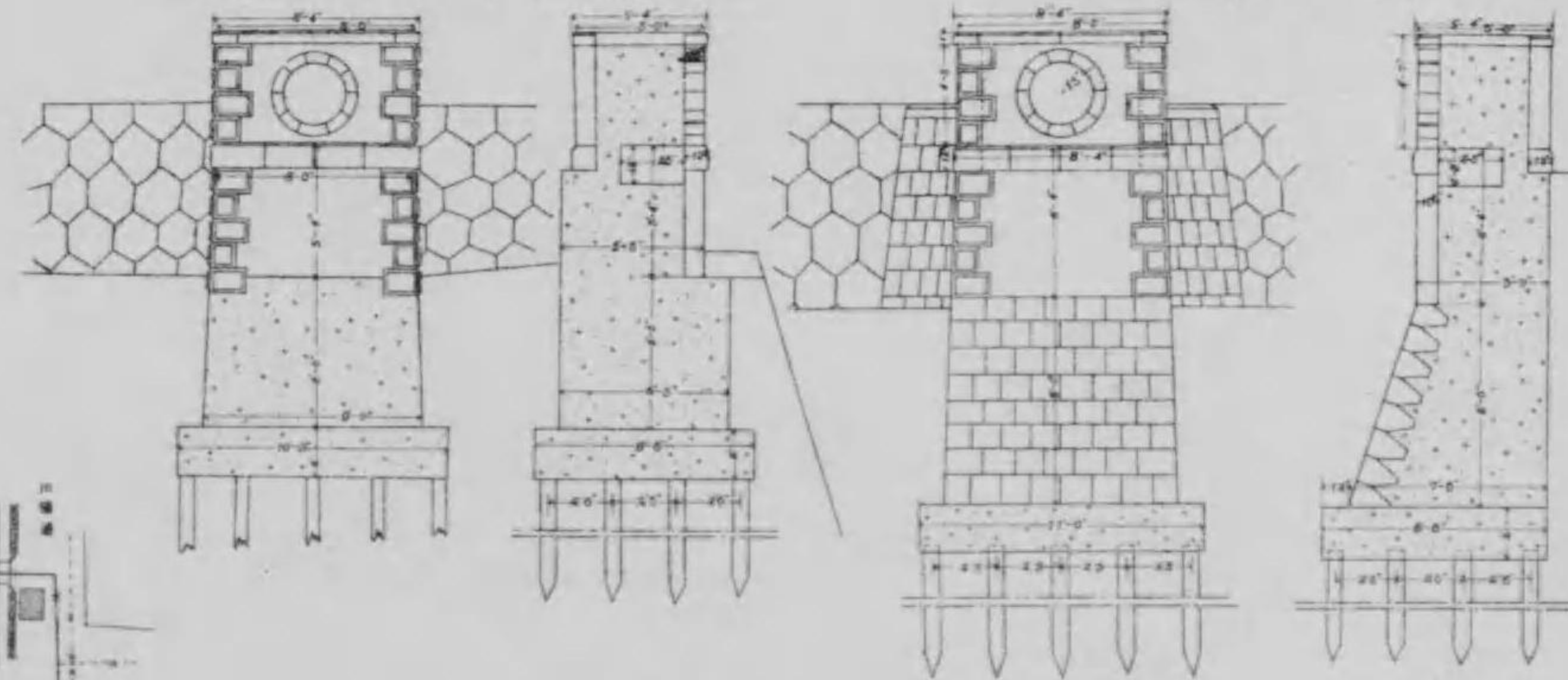
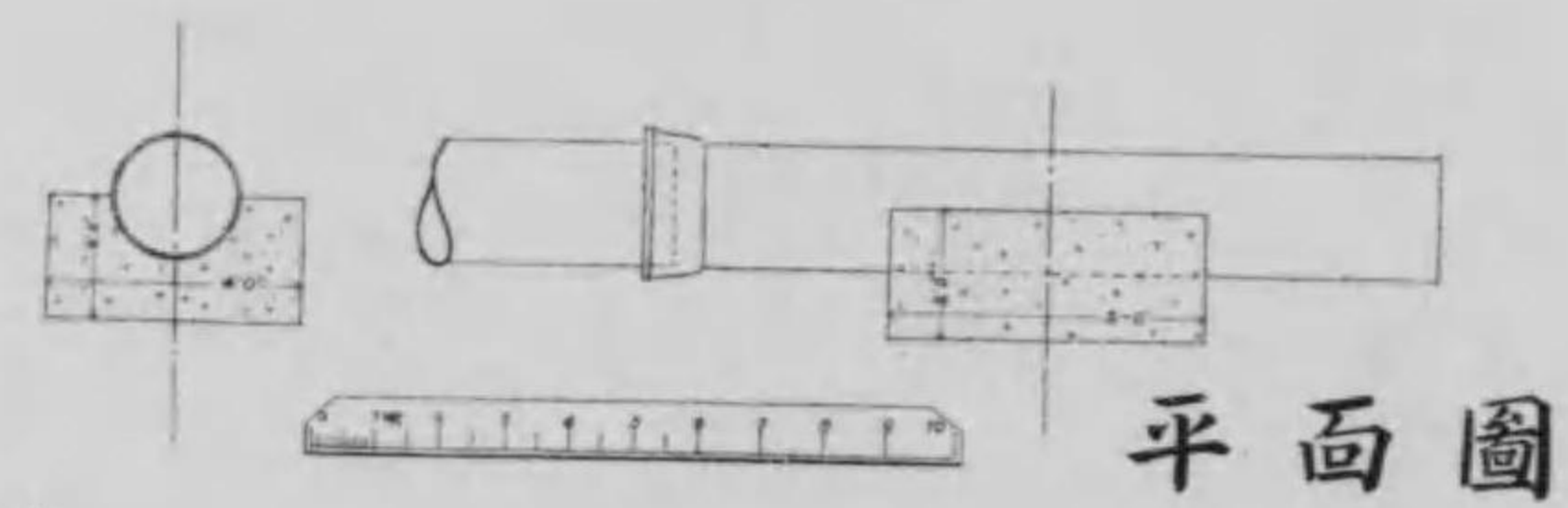

縦断面圖

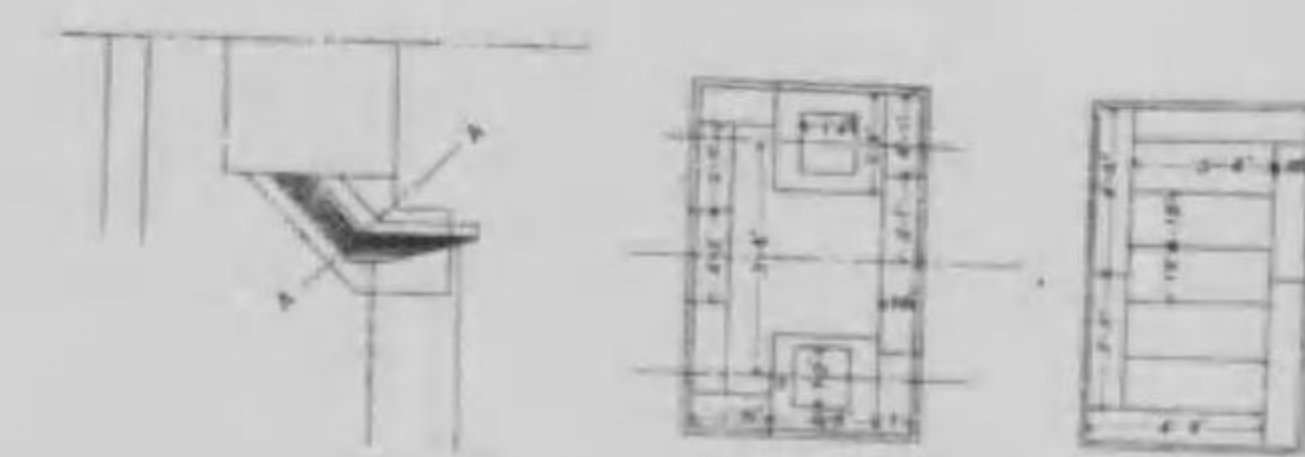
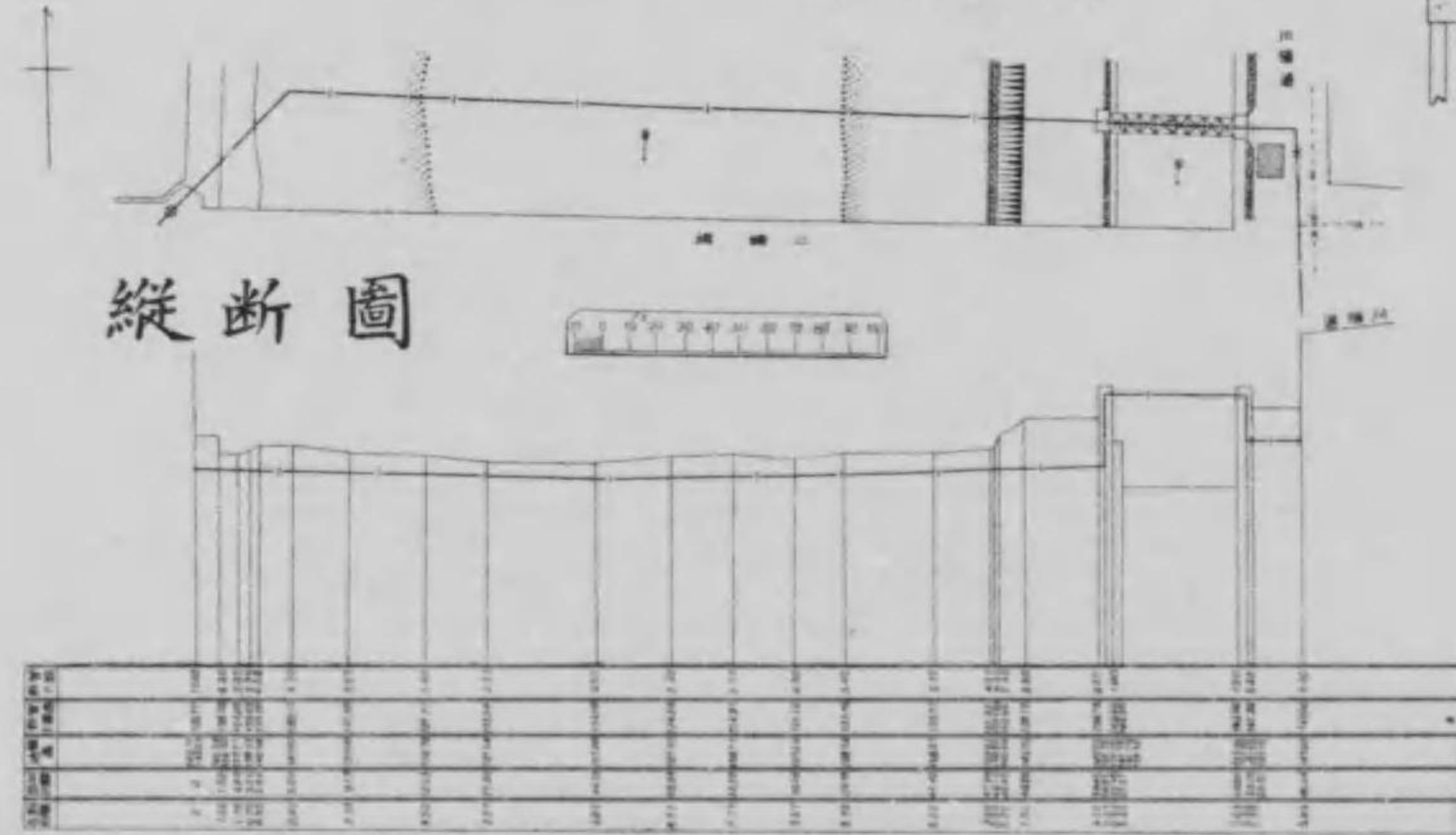

四條鴨川横断布設圖

第七十六號

平面圖

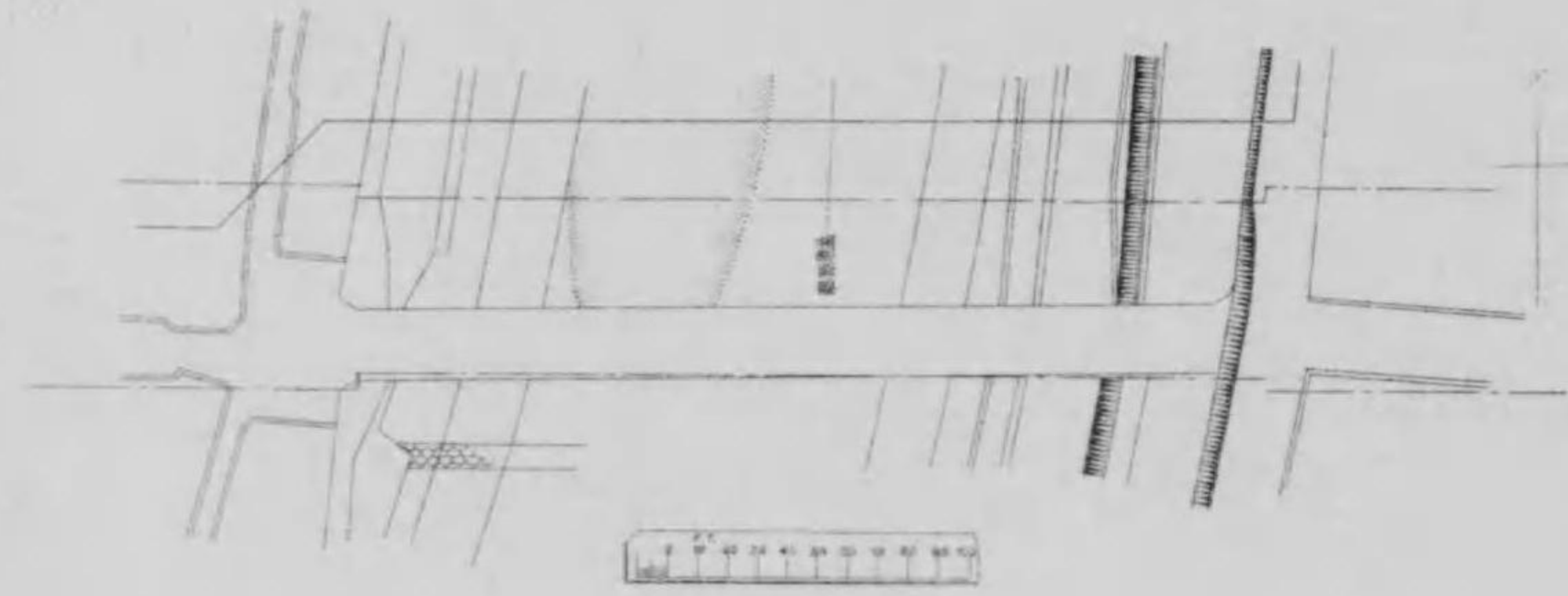

縦断面詳細圖

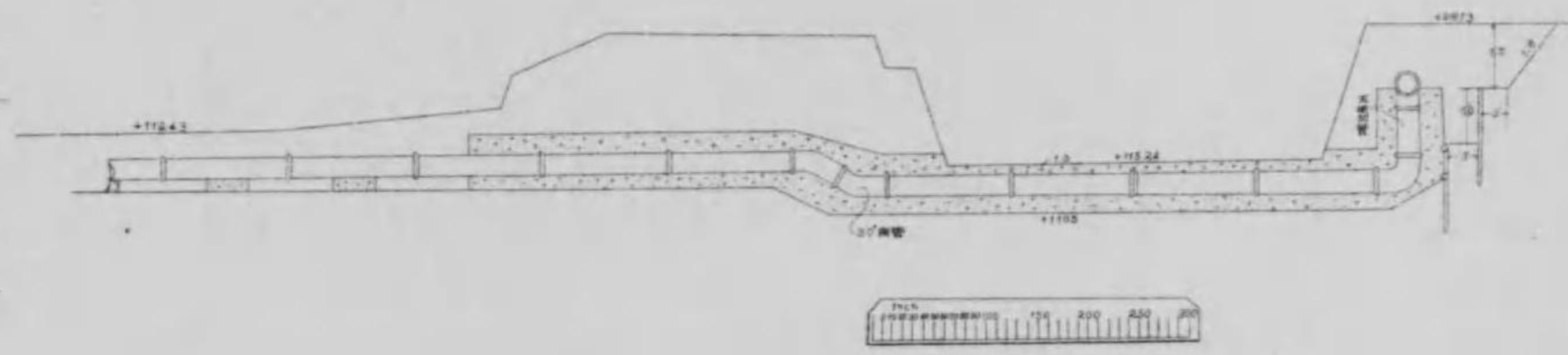

縦断面圖

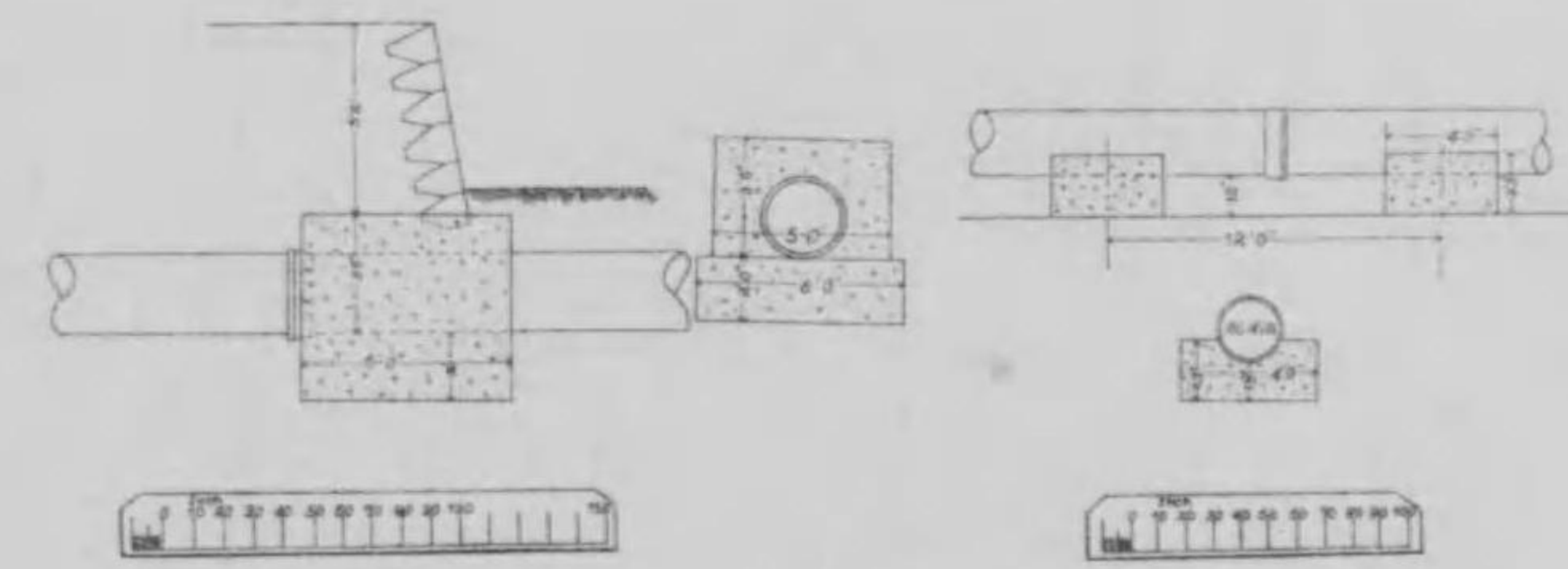
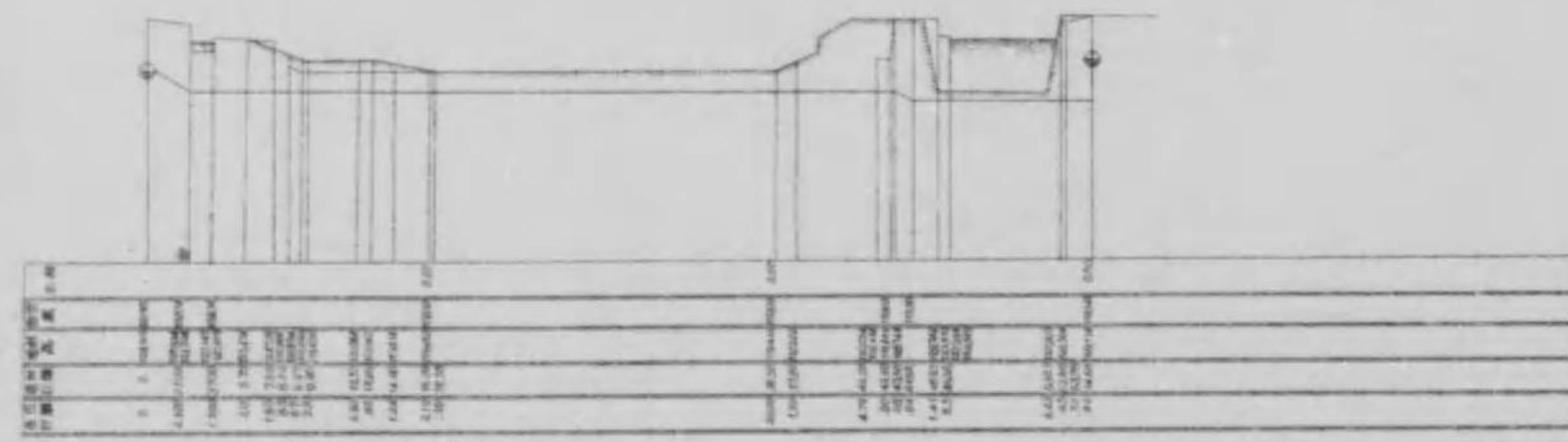

七條鴨川横断布設圖

第七十七號

縦断面詳細圖

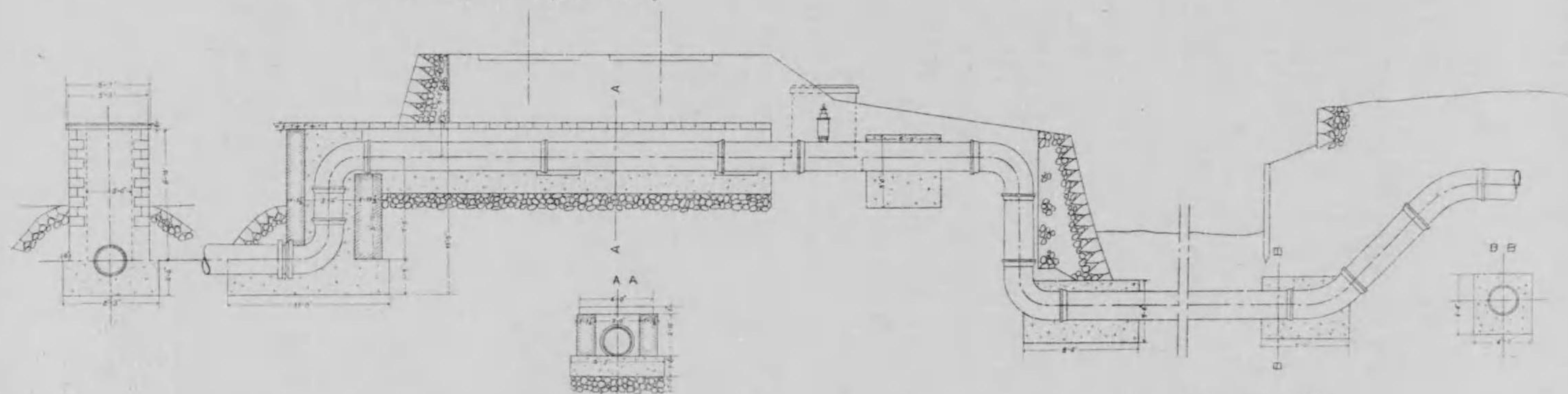

平面圖

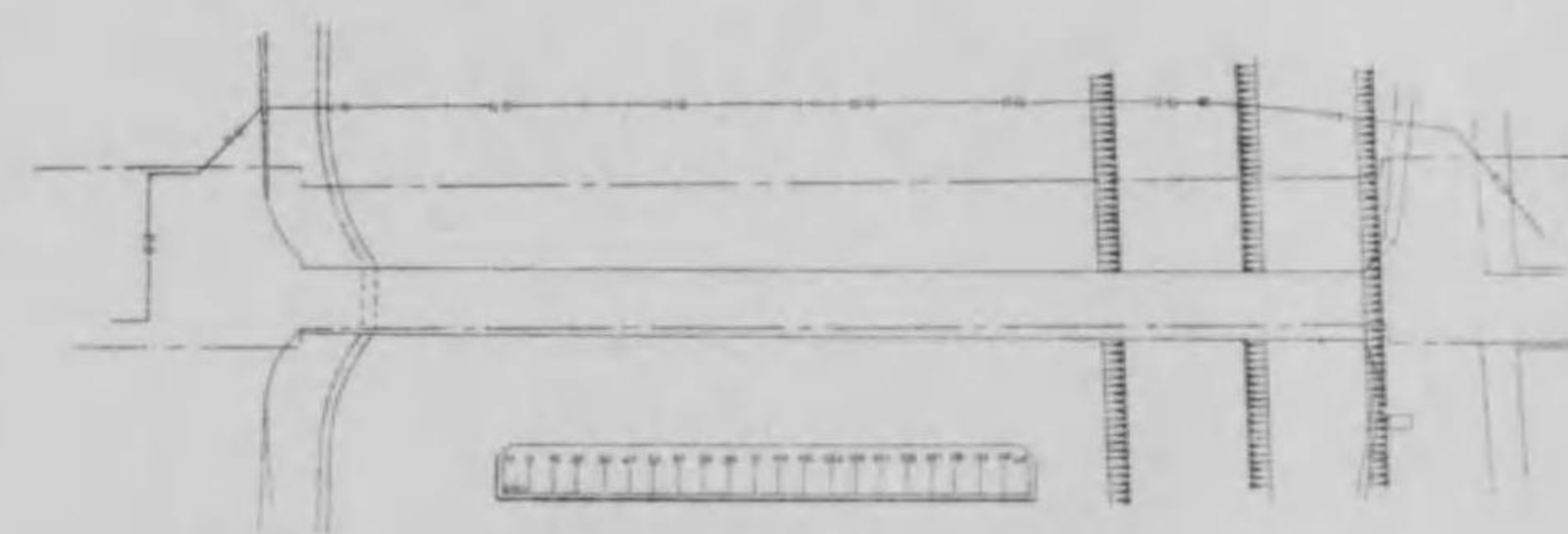

縦断面圖

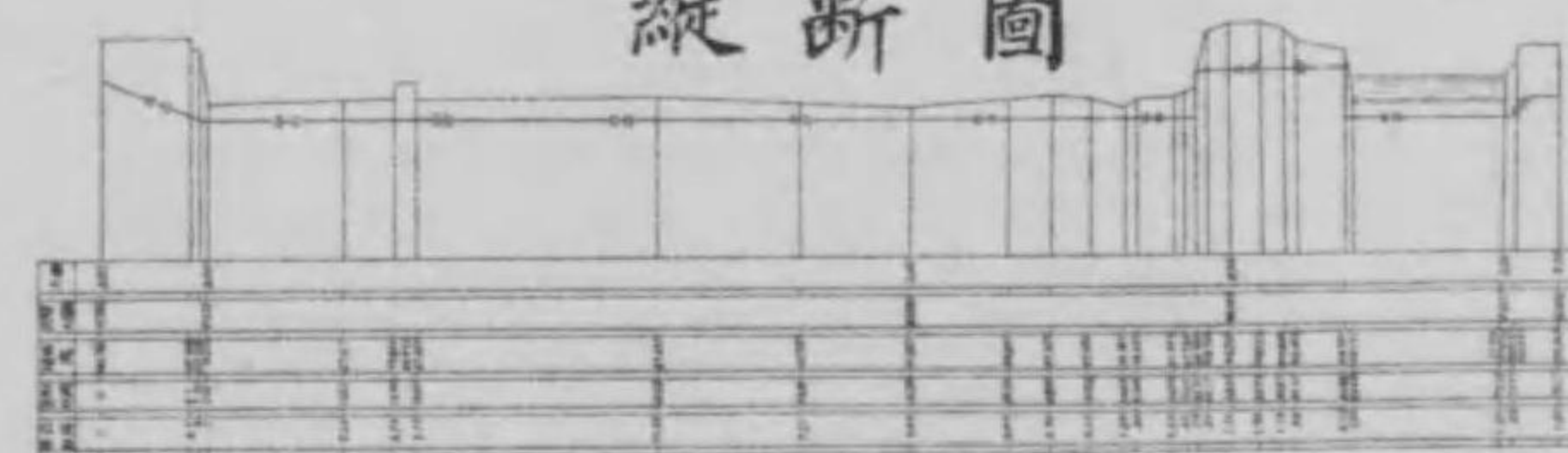
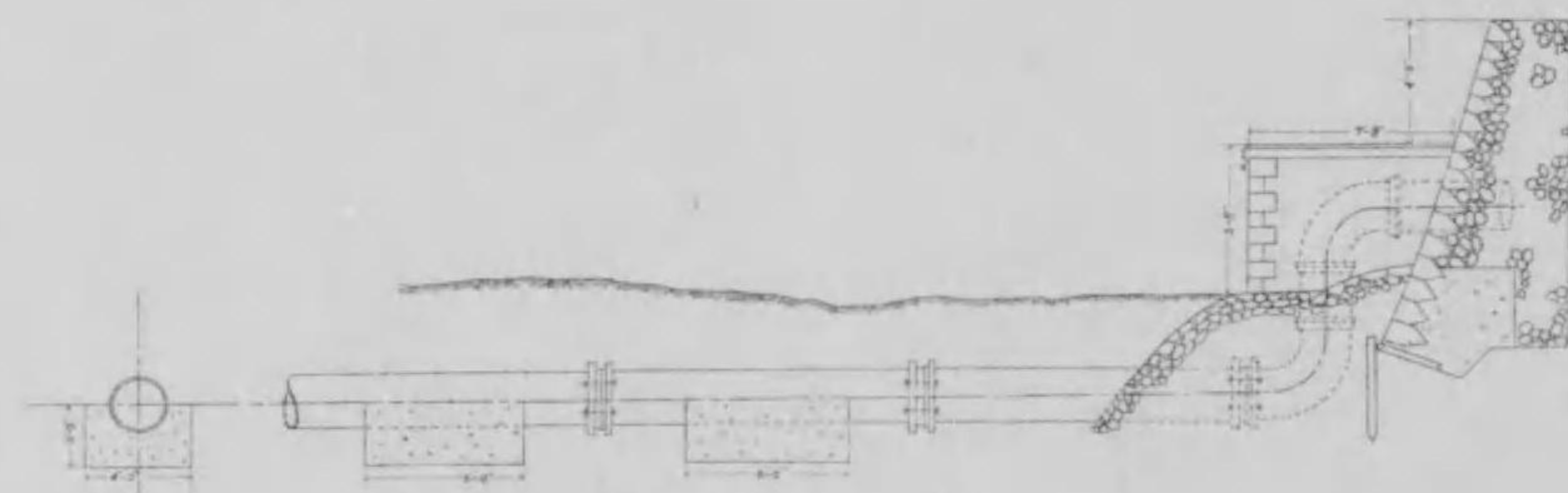

淨地用

三十六吋制水瓣圖

第七十八號

三十吋制水瓣圖

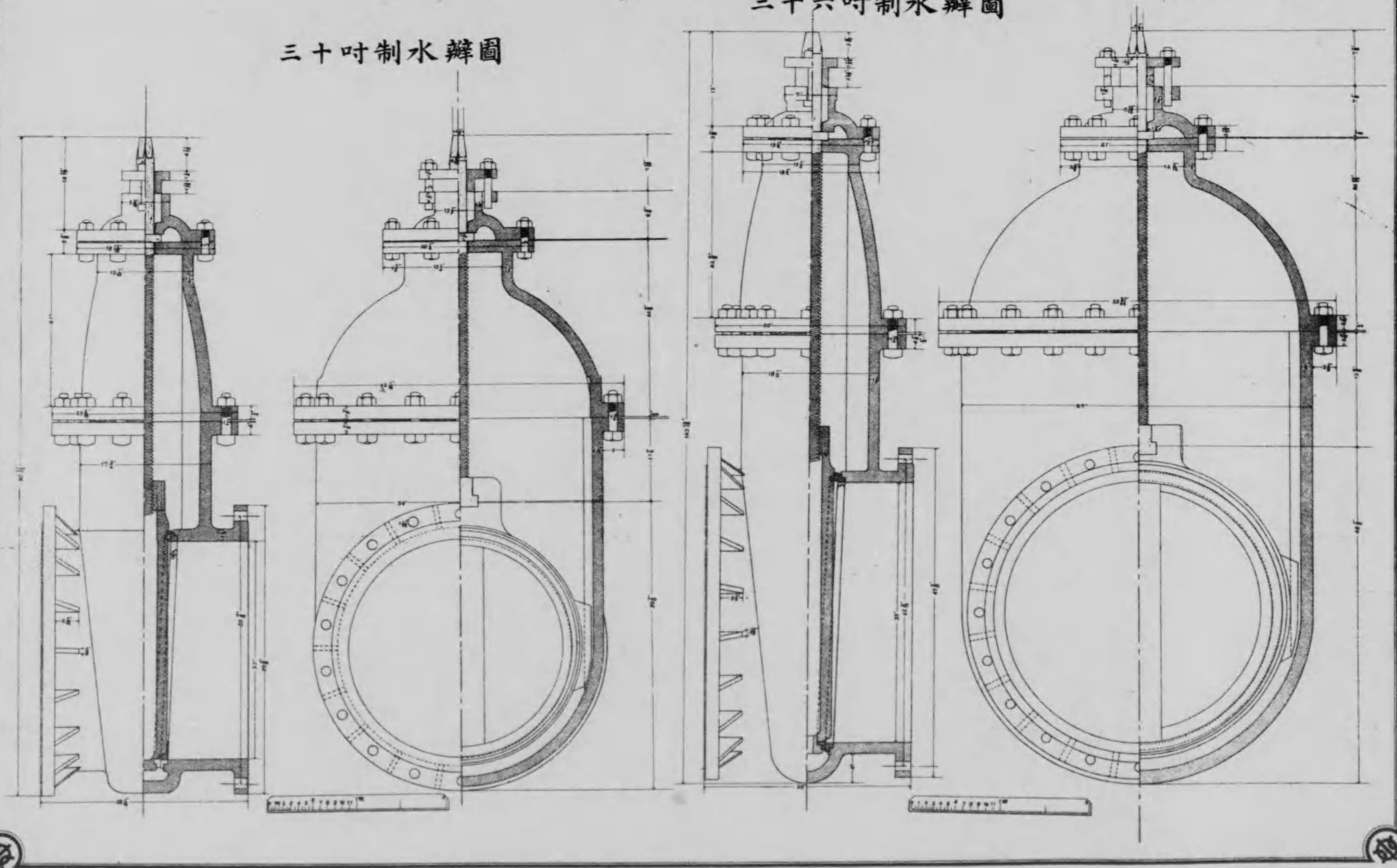

第七十九號

淨水地用
二十八吋制水瓣圖

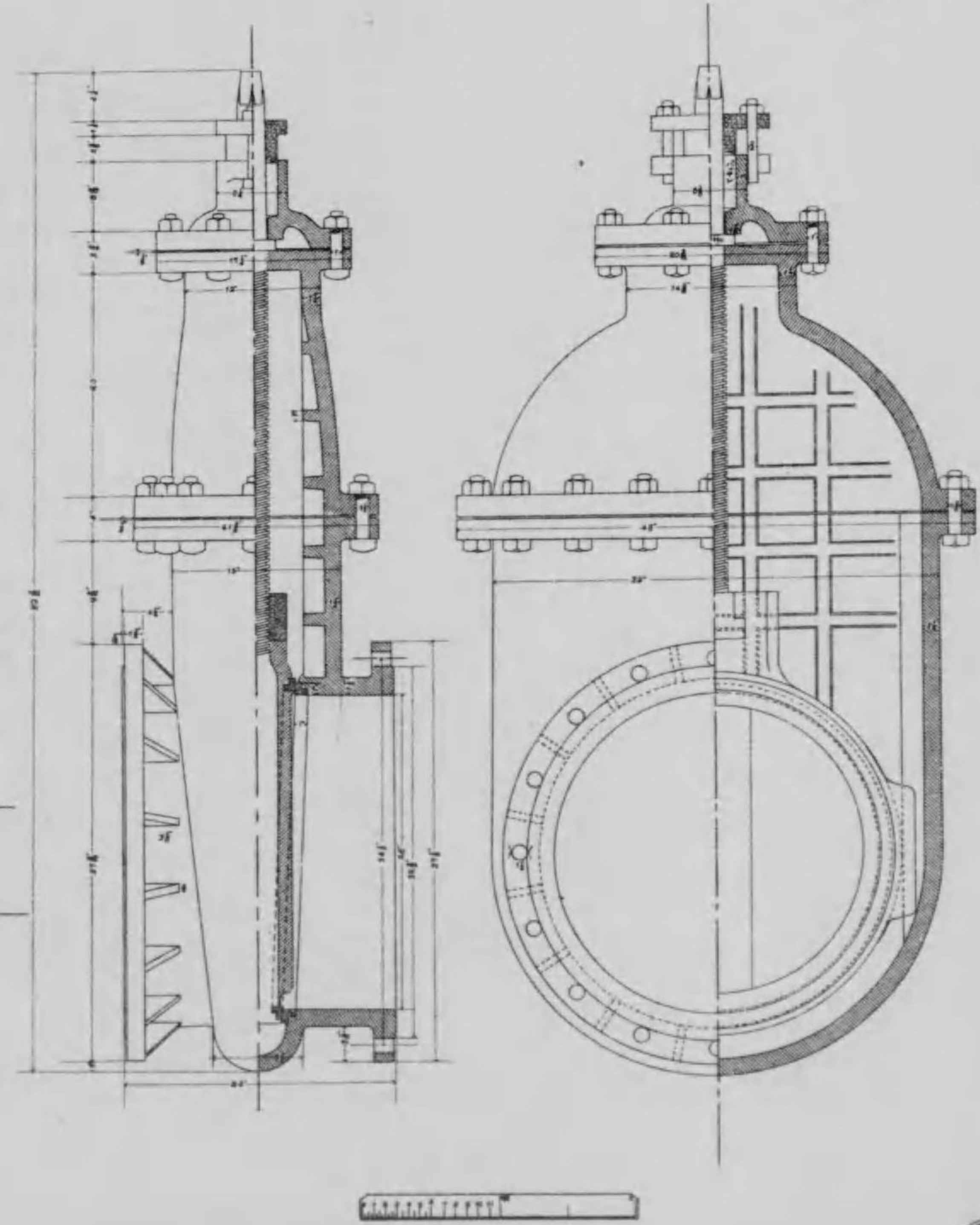

淨水地用
二十八吋制水瓣圖

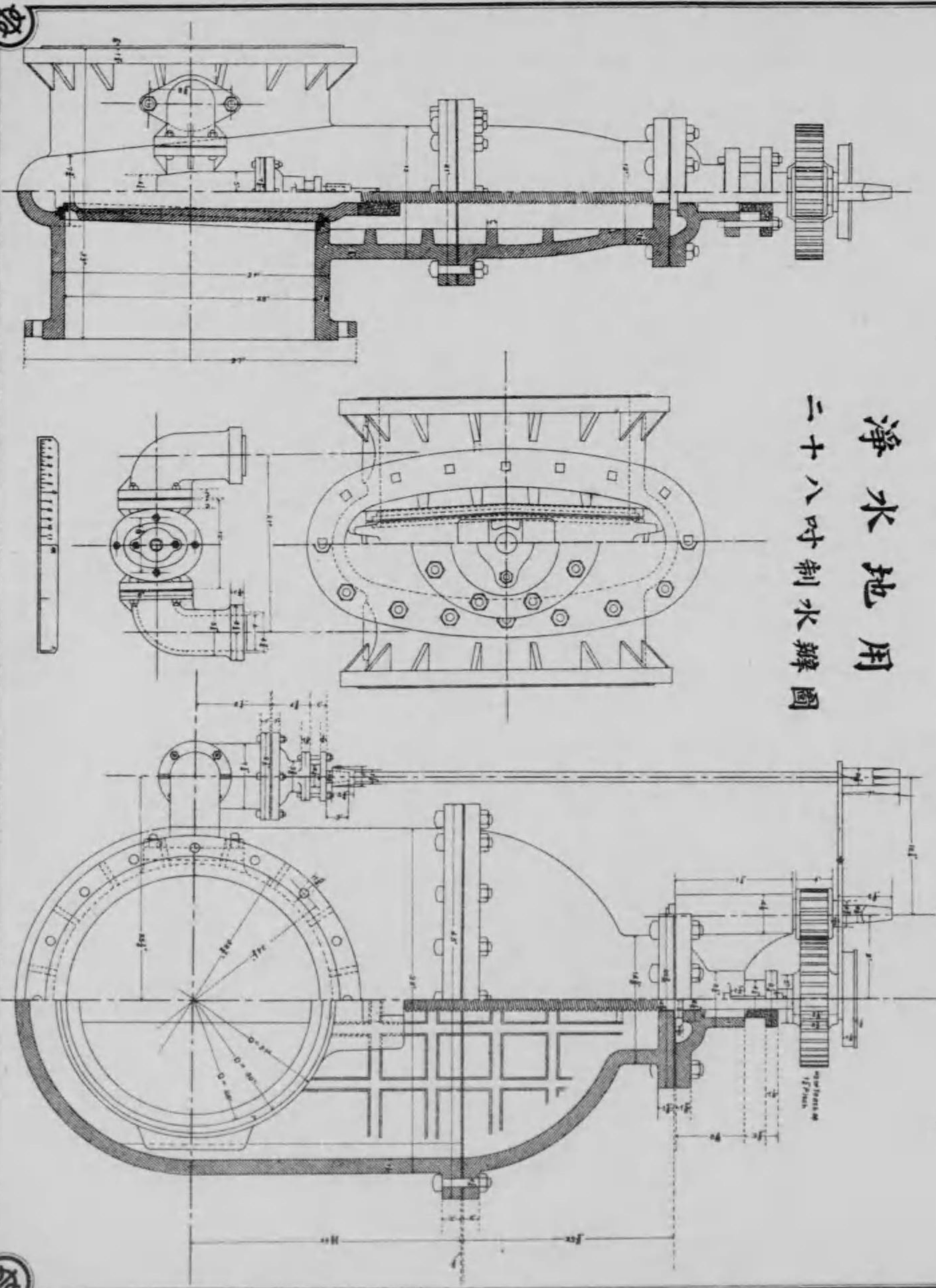

二十四吋制水瓣圖

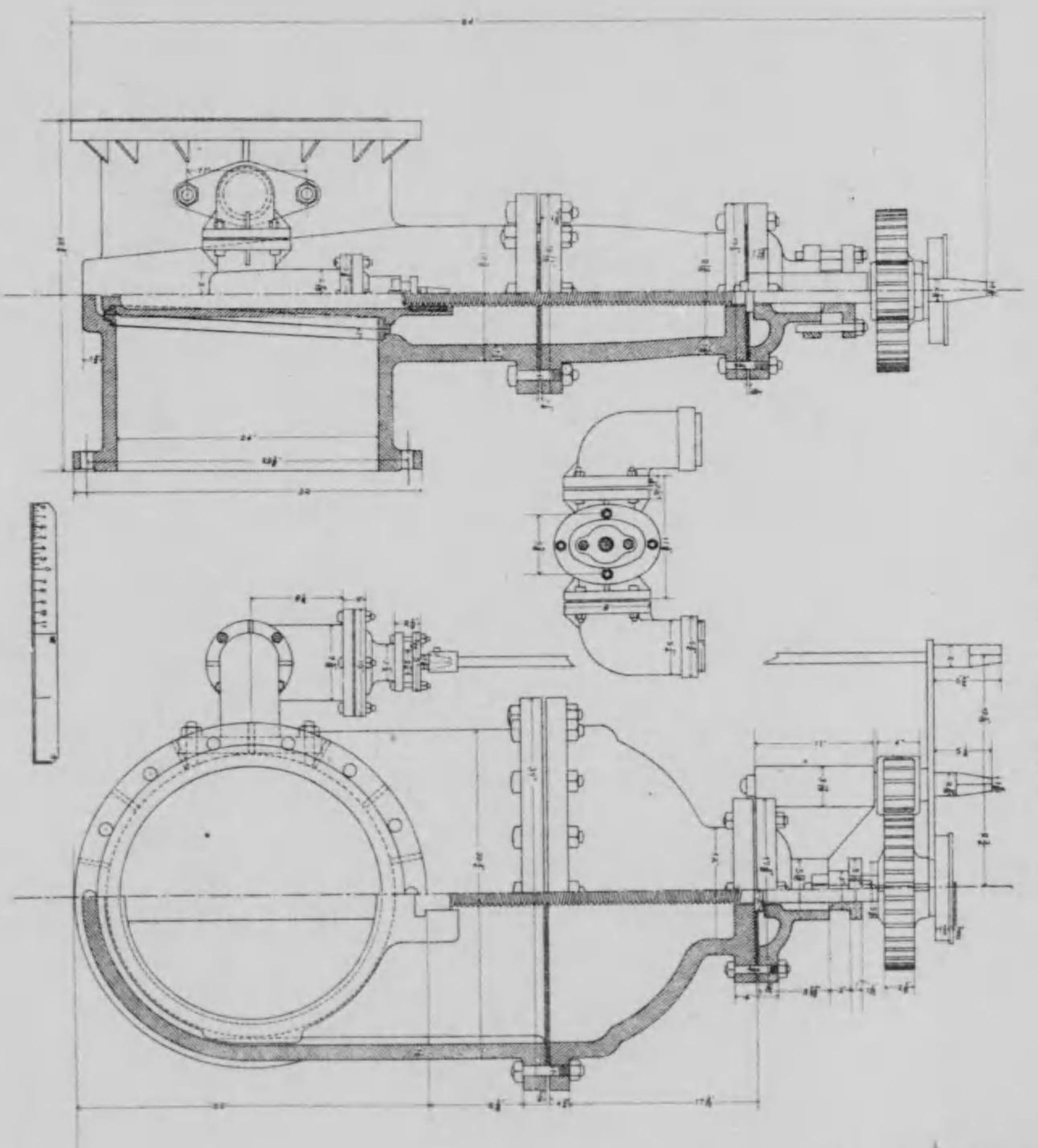

第八十號

配水用

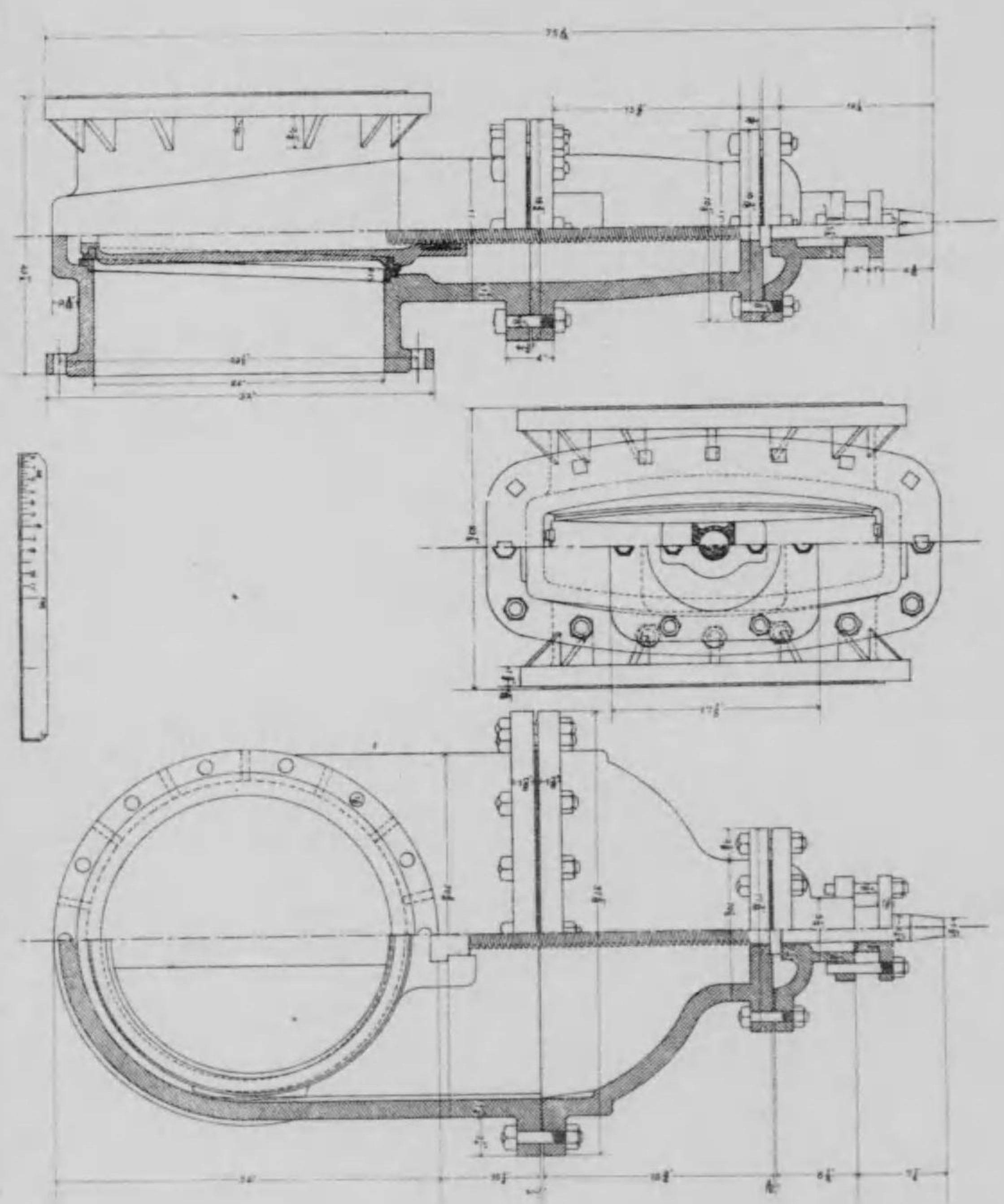

淨水地用

淨水地用

二十六吋制水瓣圖

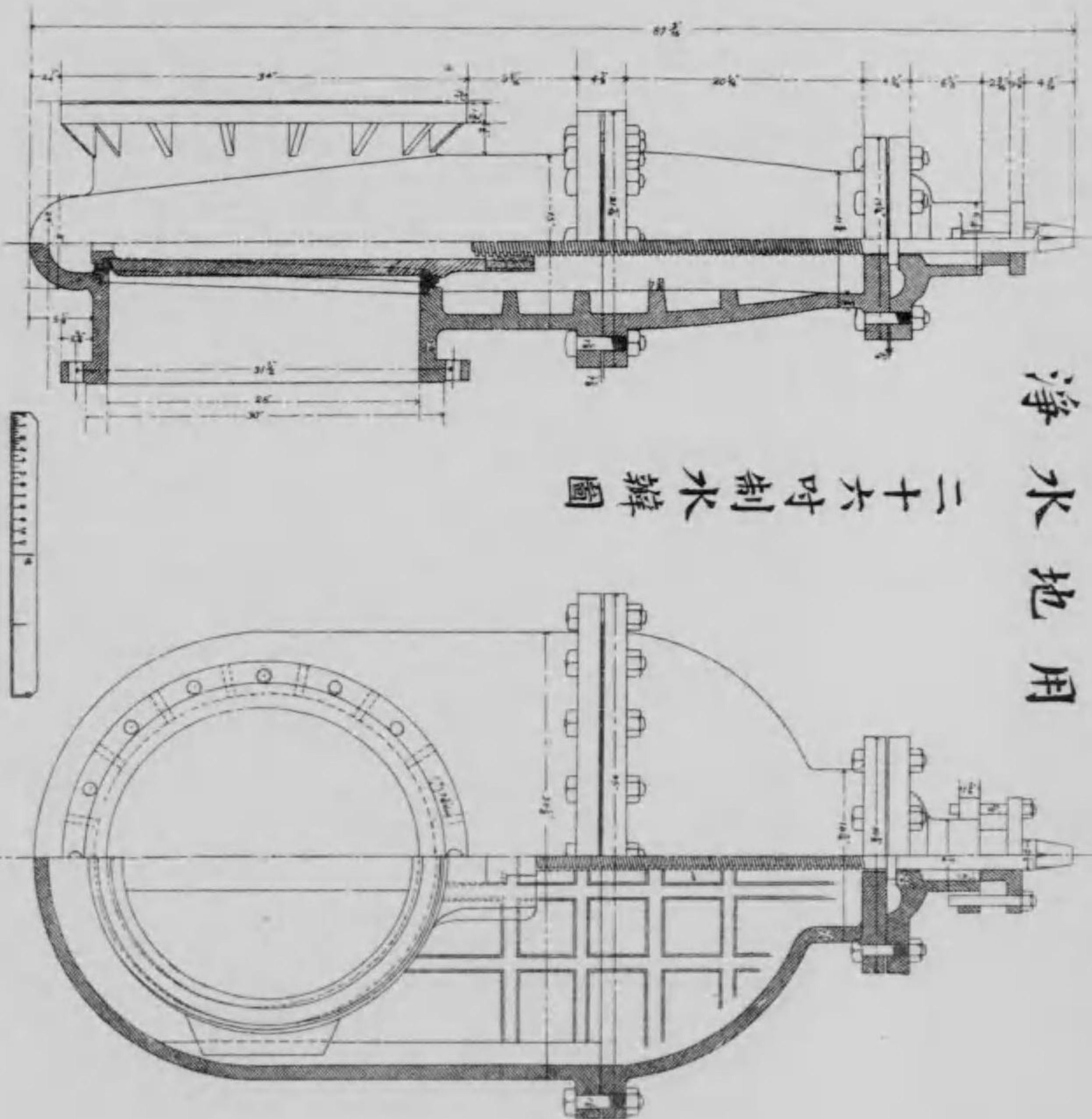

第八十二號

配水用

十八吋制水瓣圖

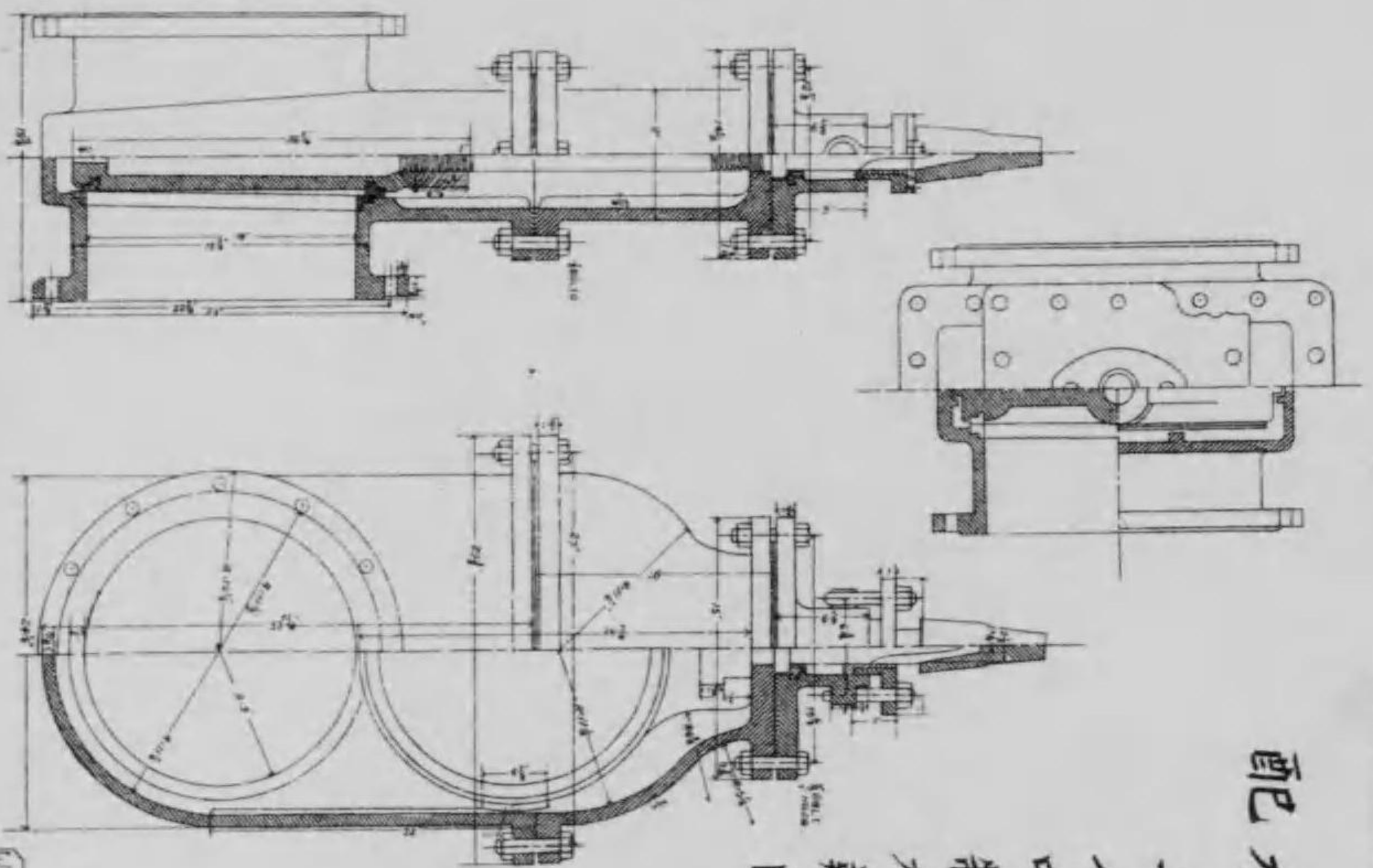

十六吋制水瓣圖

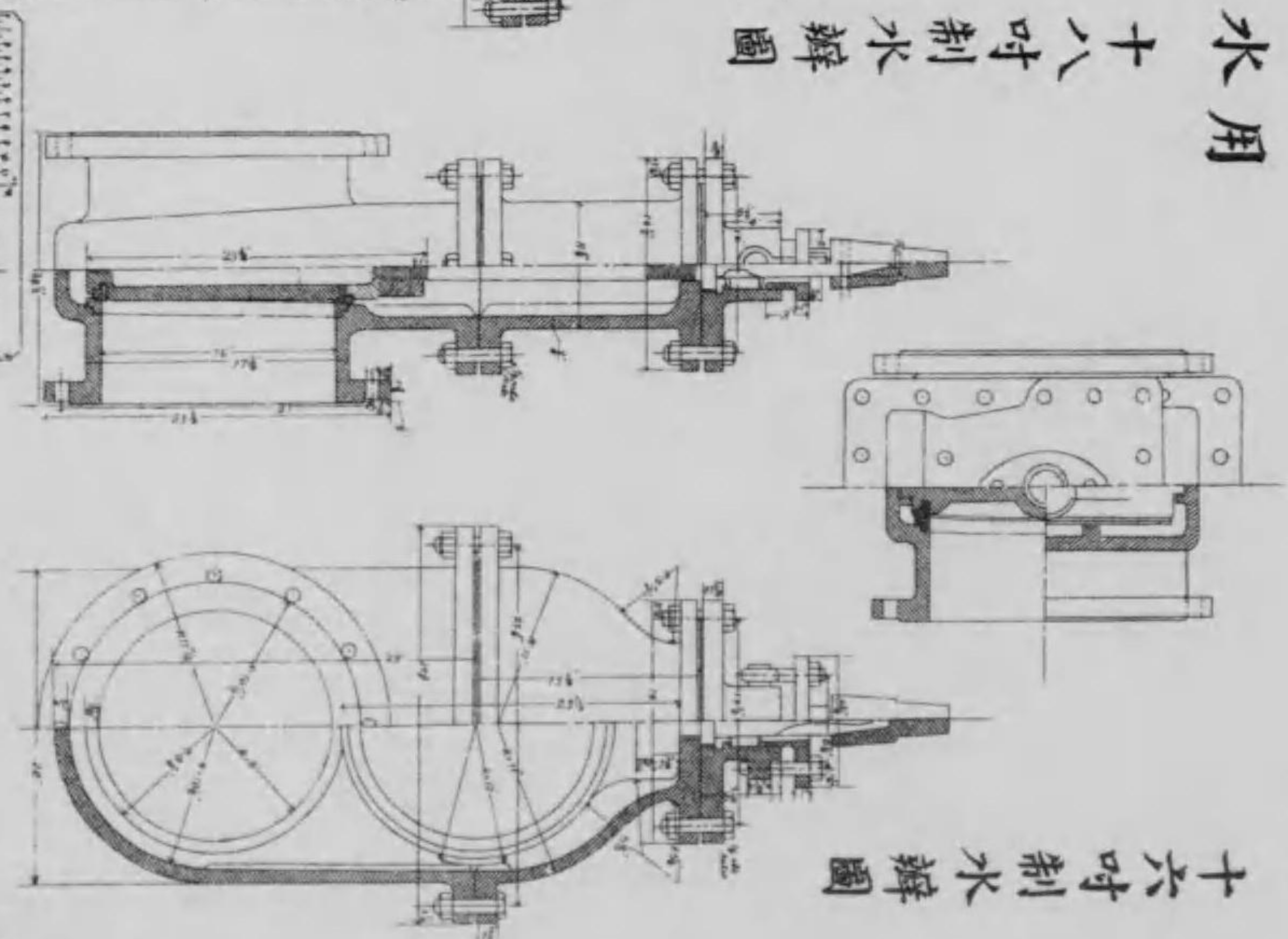

配水用

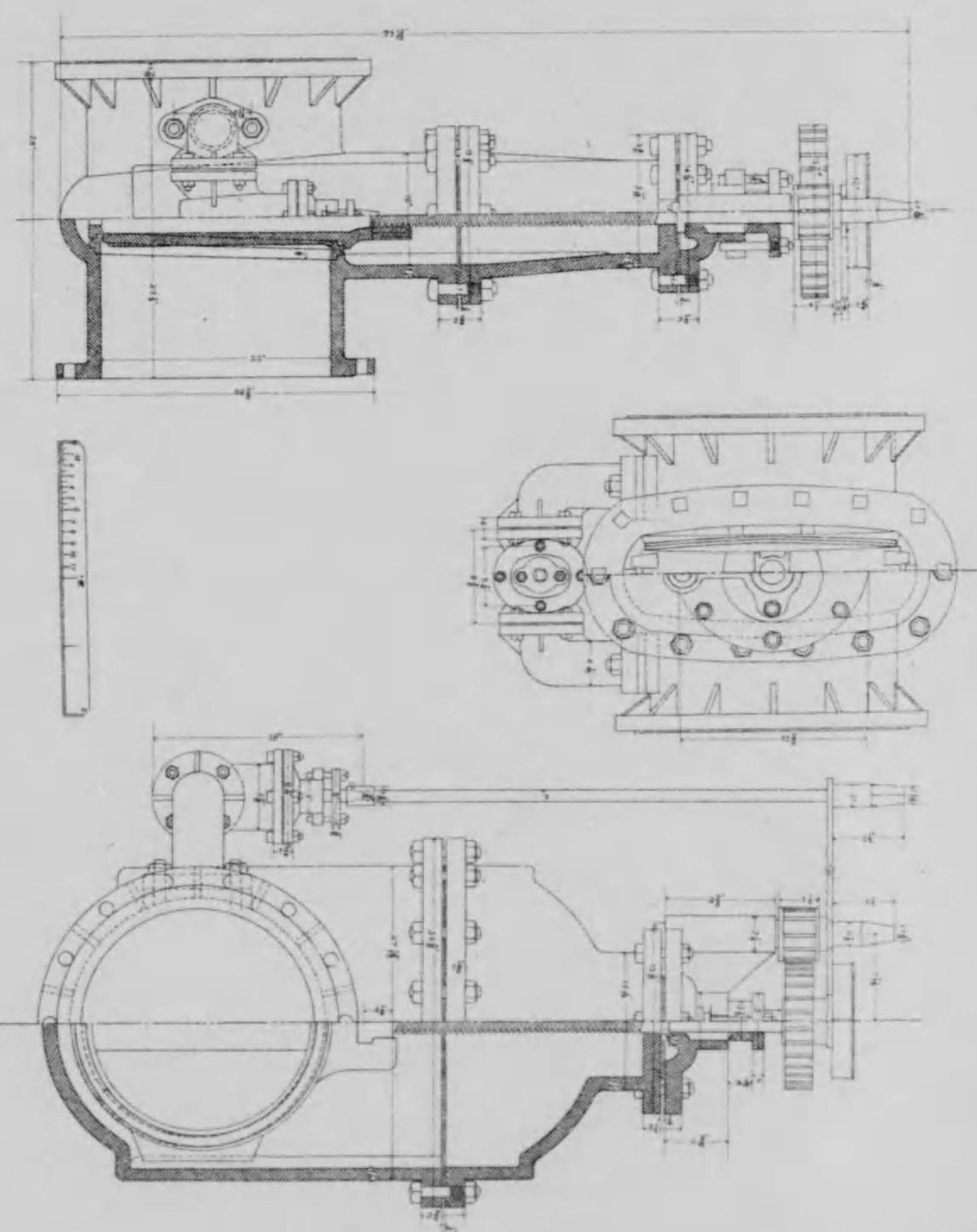

二十吋制水瓣圖

第八十二號

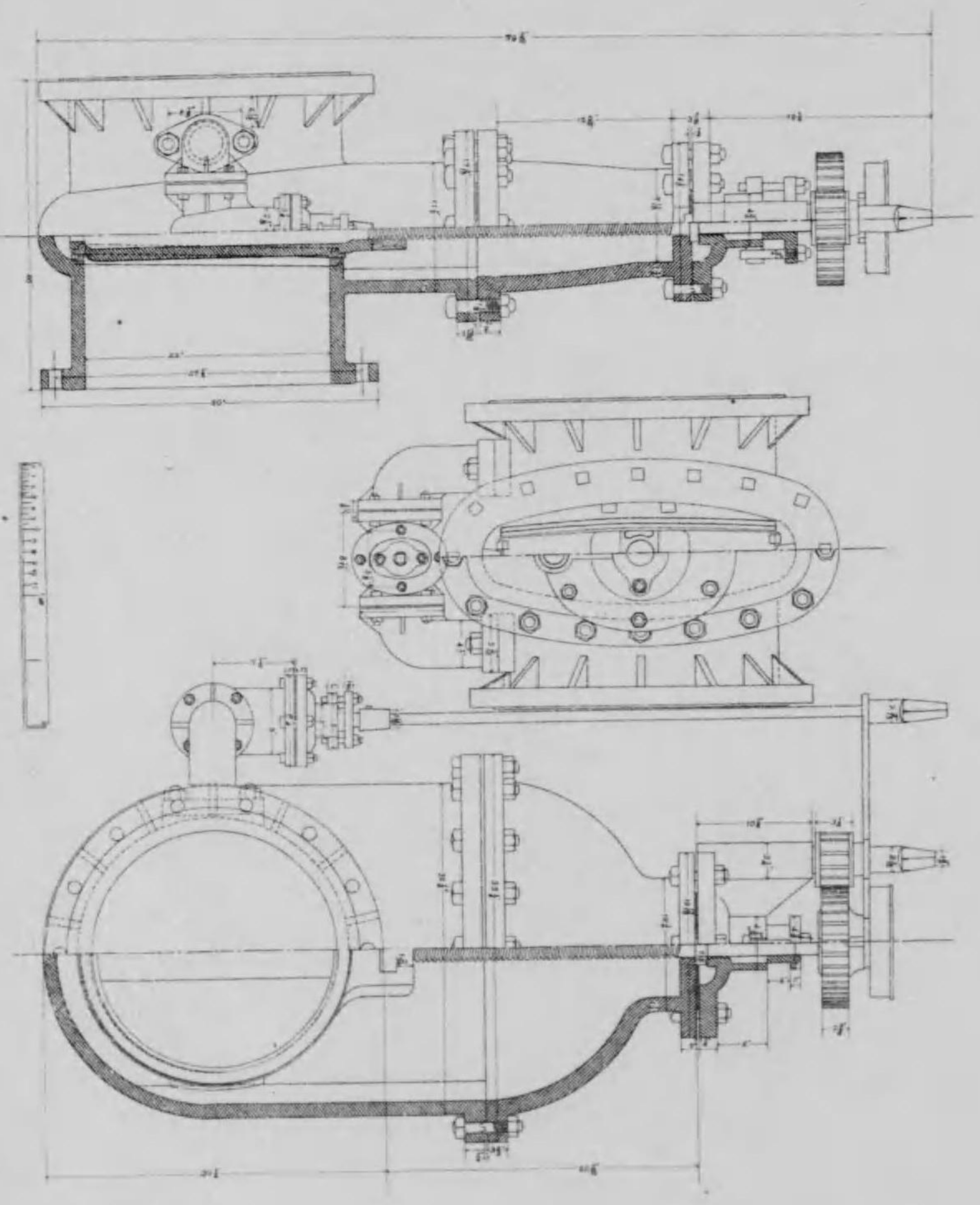

二十二吋制水瓣圖

配水用
制水瓣圖

第八十三號

十四吋

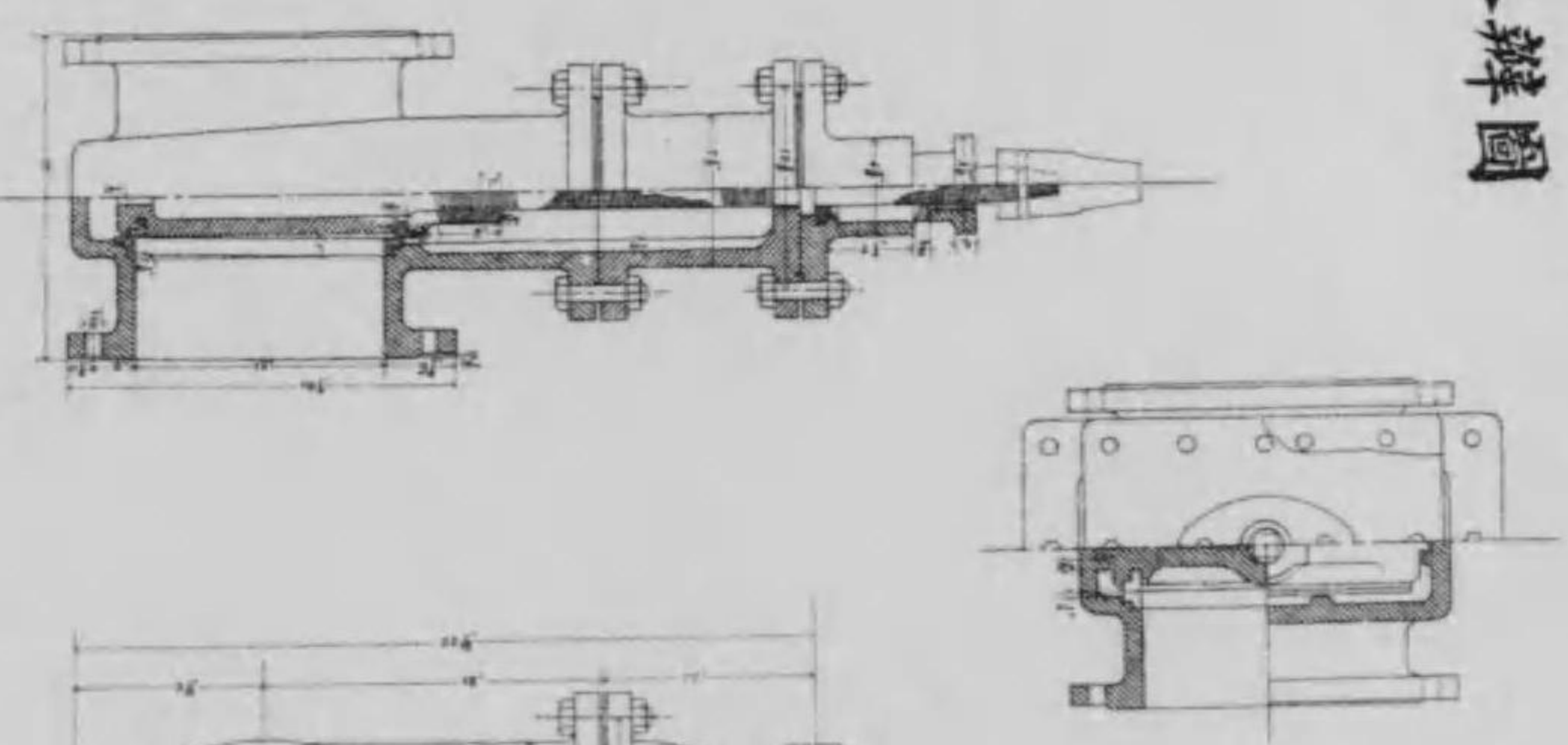
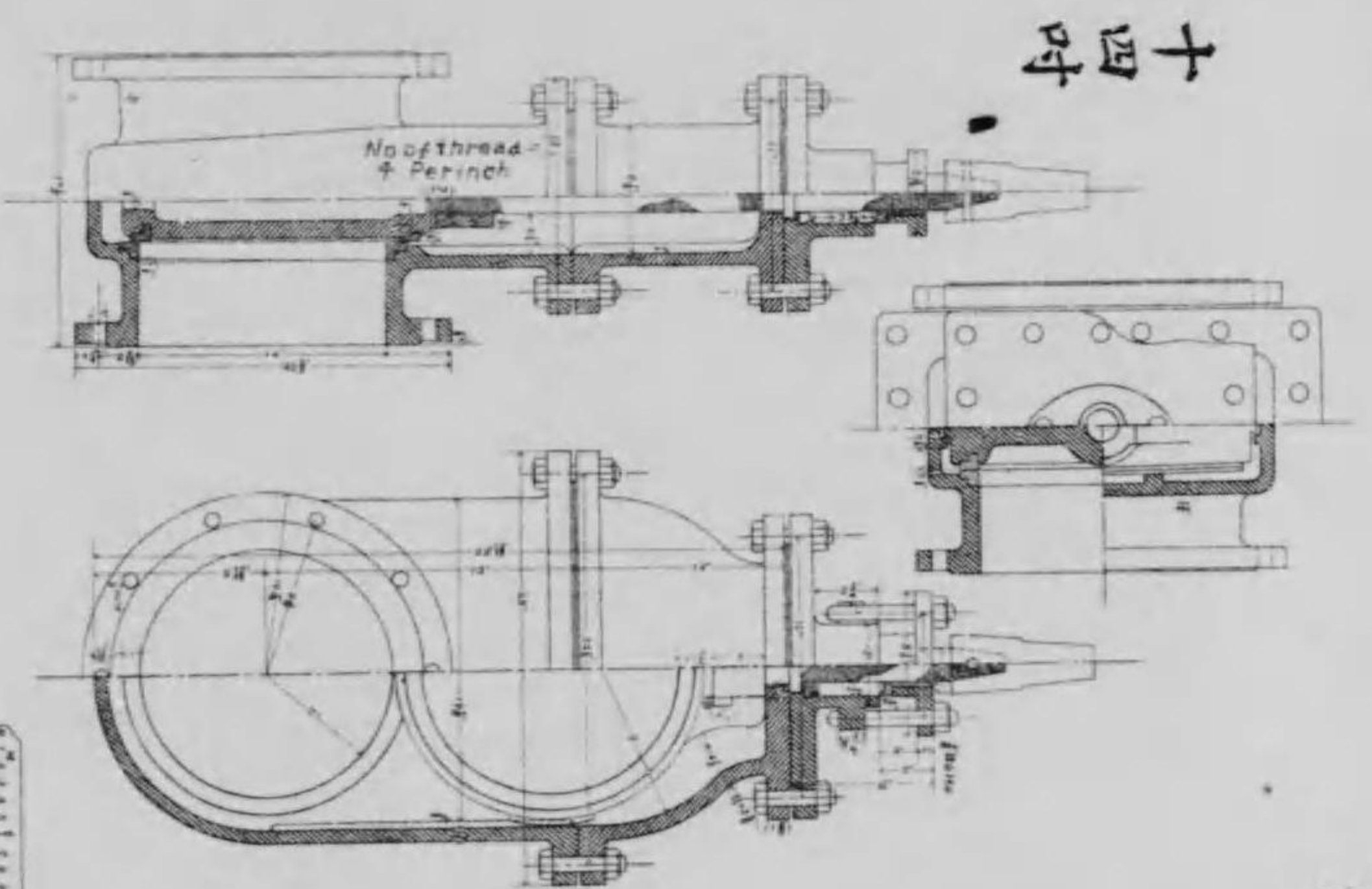

十二吋

十吋

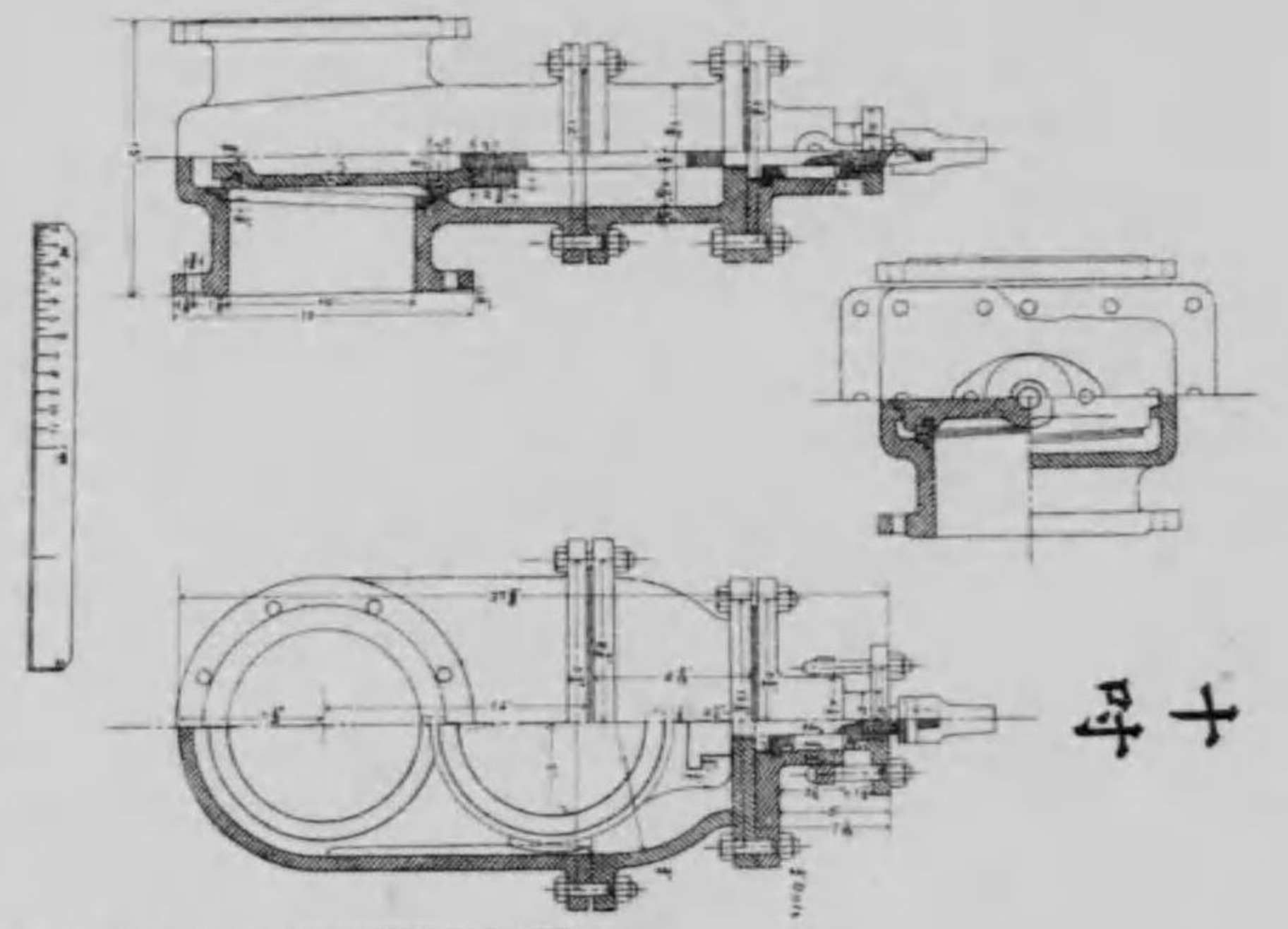

九吋

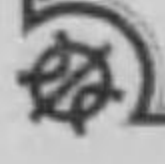
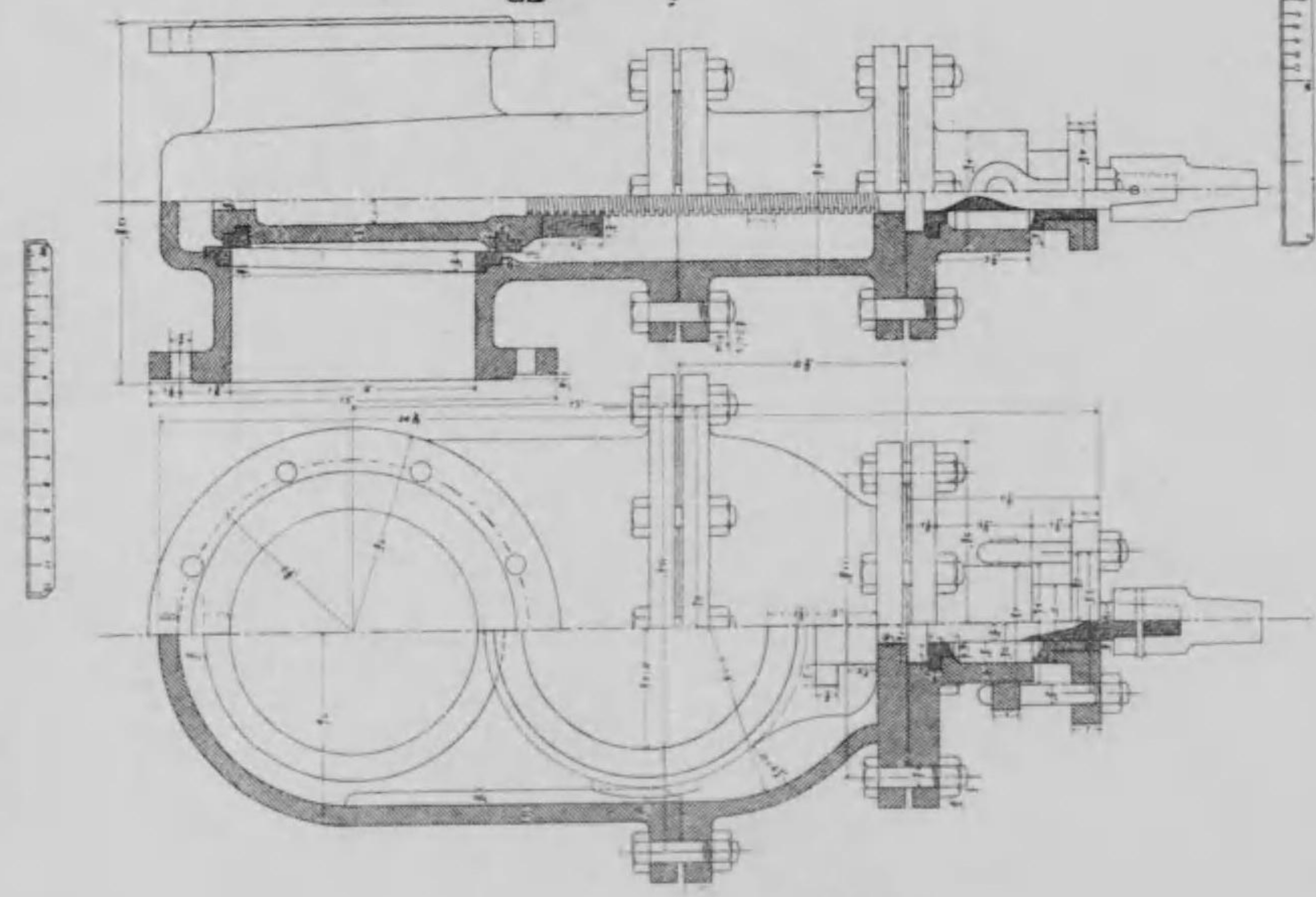

配水用

五吋制水瓣圖

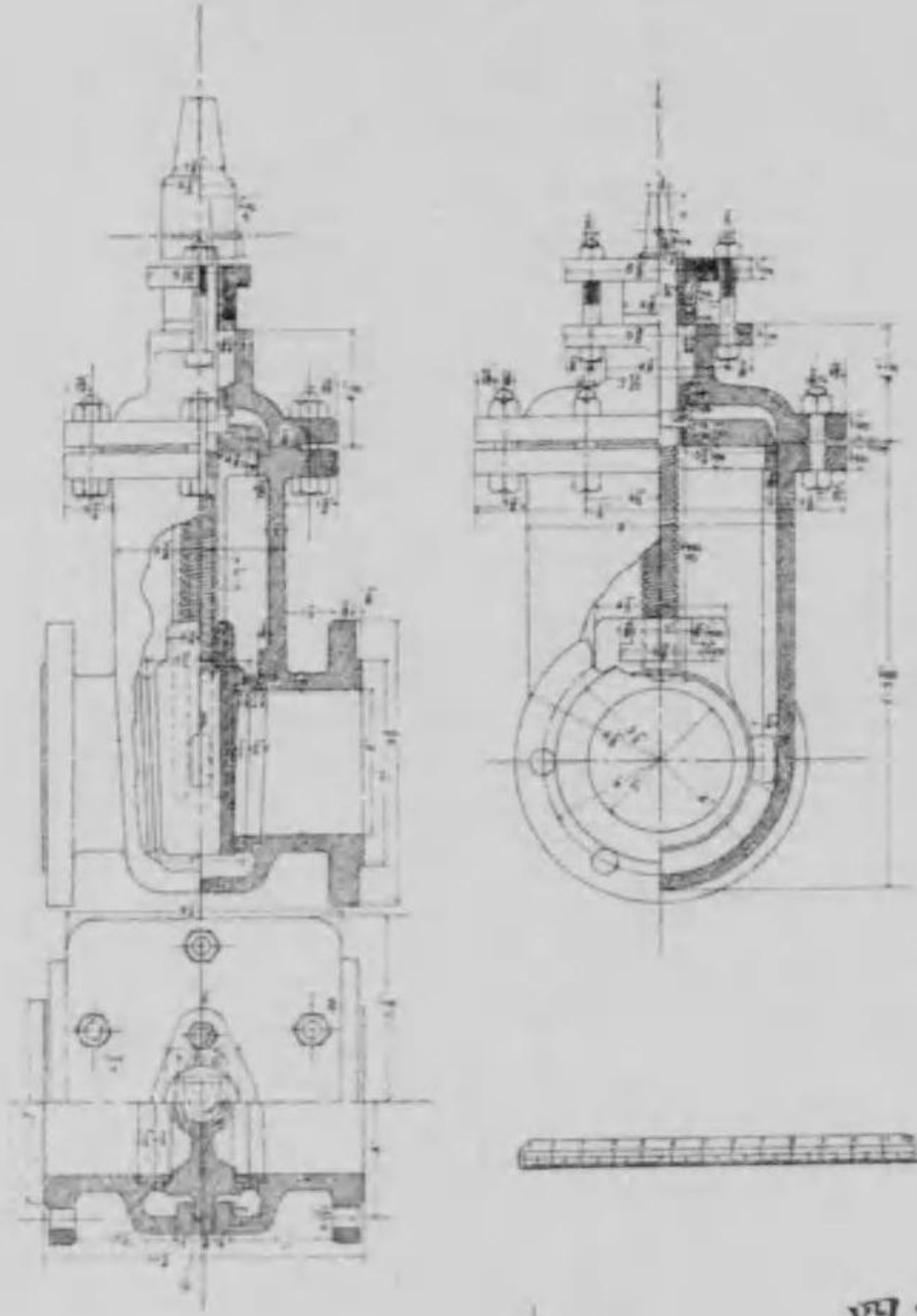

八吋制水瓣圖

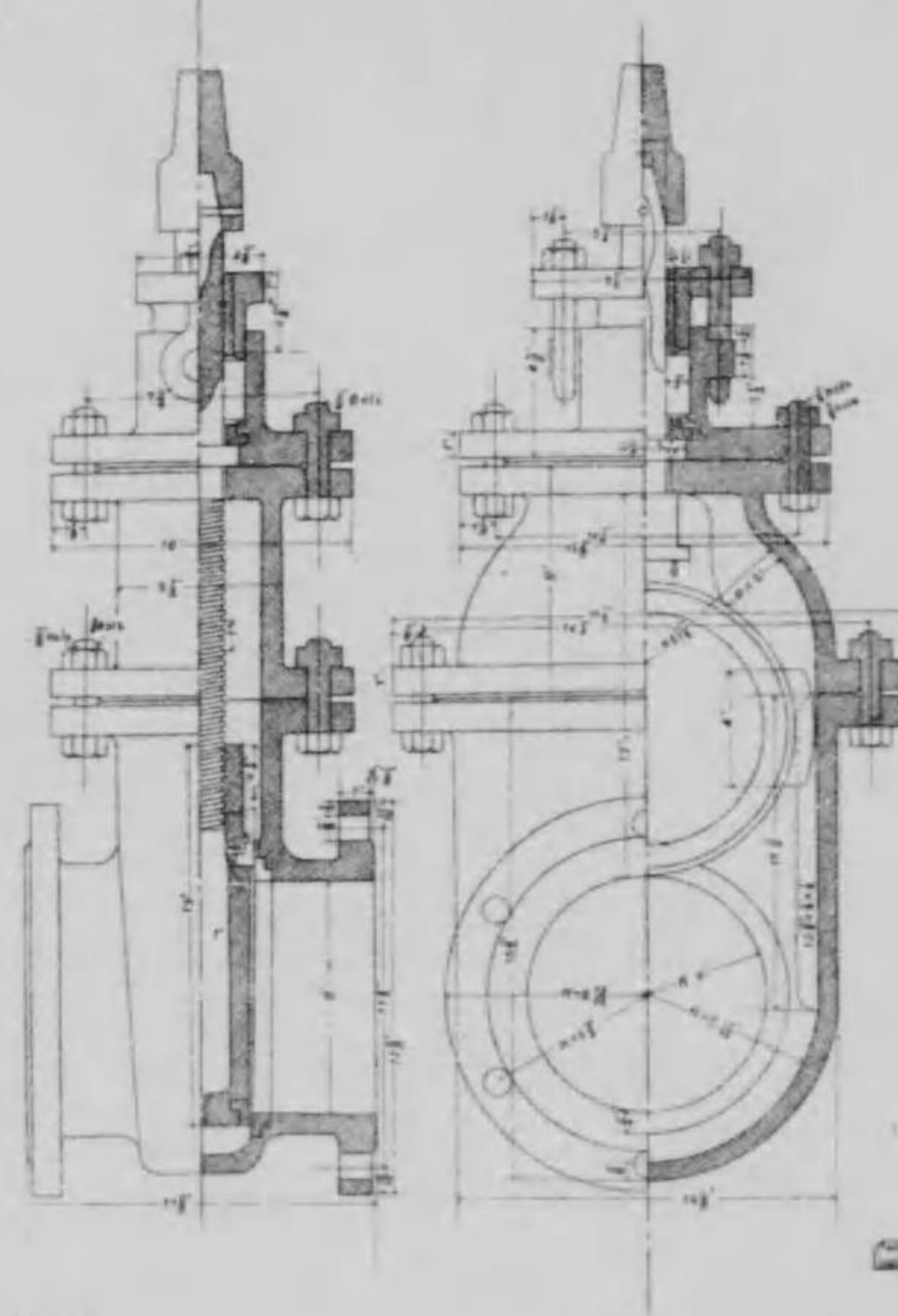

六吋制水瓣圖

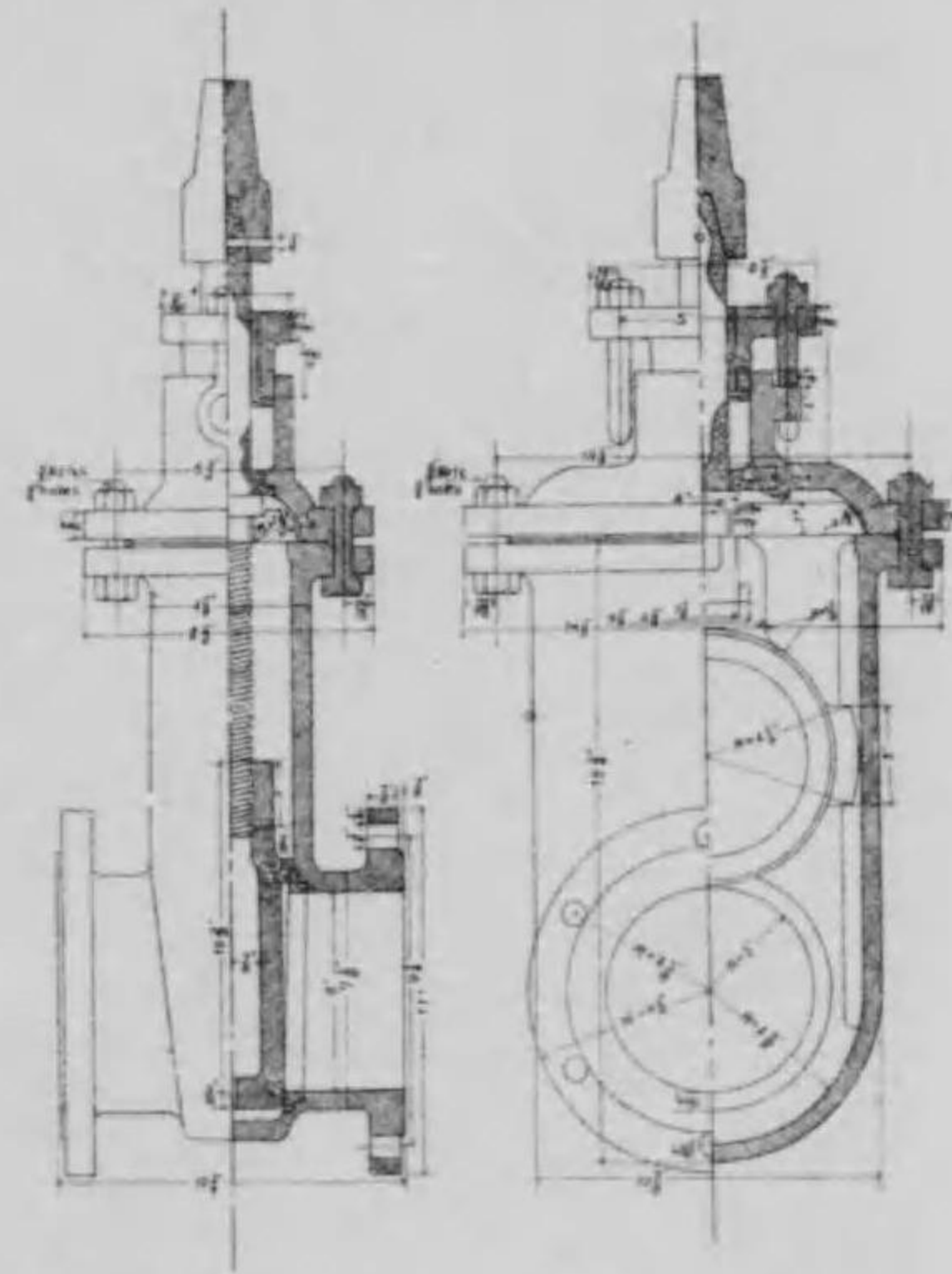

四吋制水瓣圖

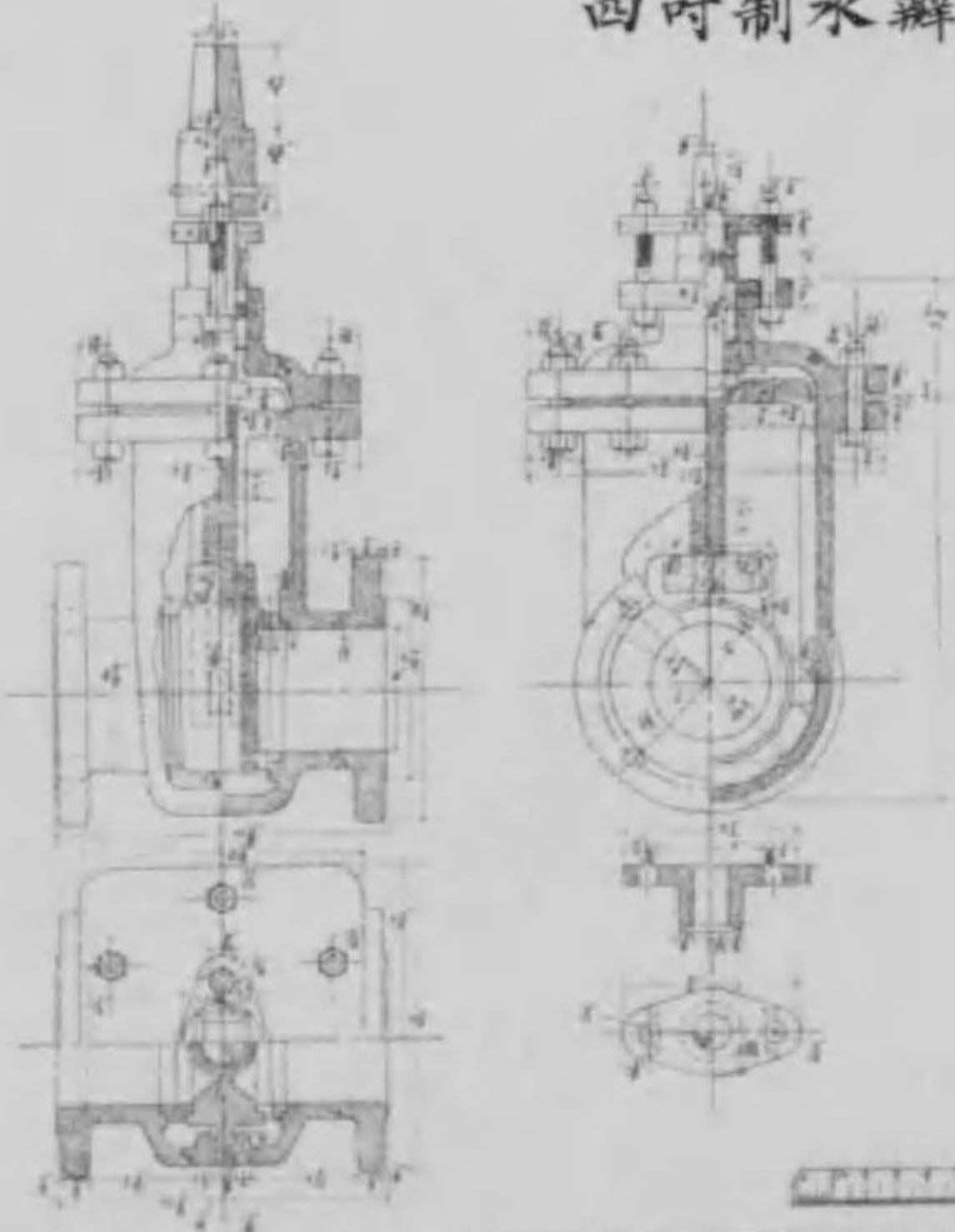

三吋半制水瓣圖

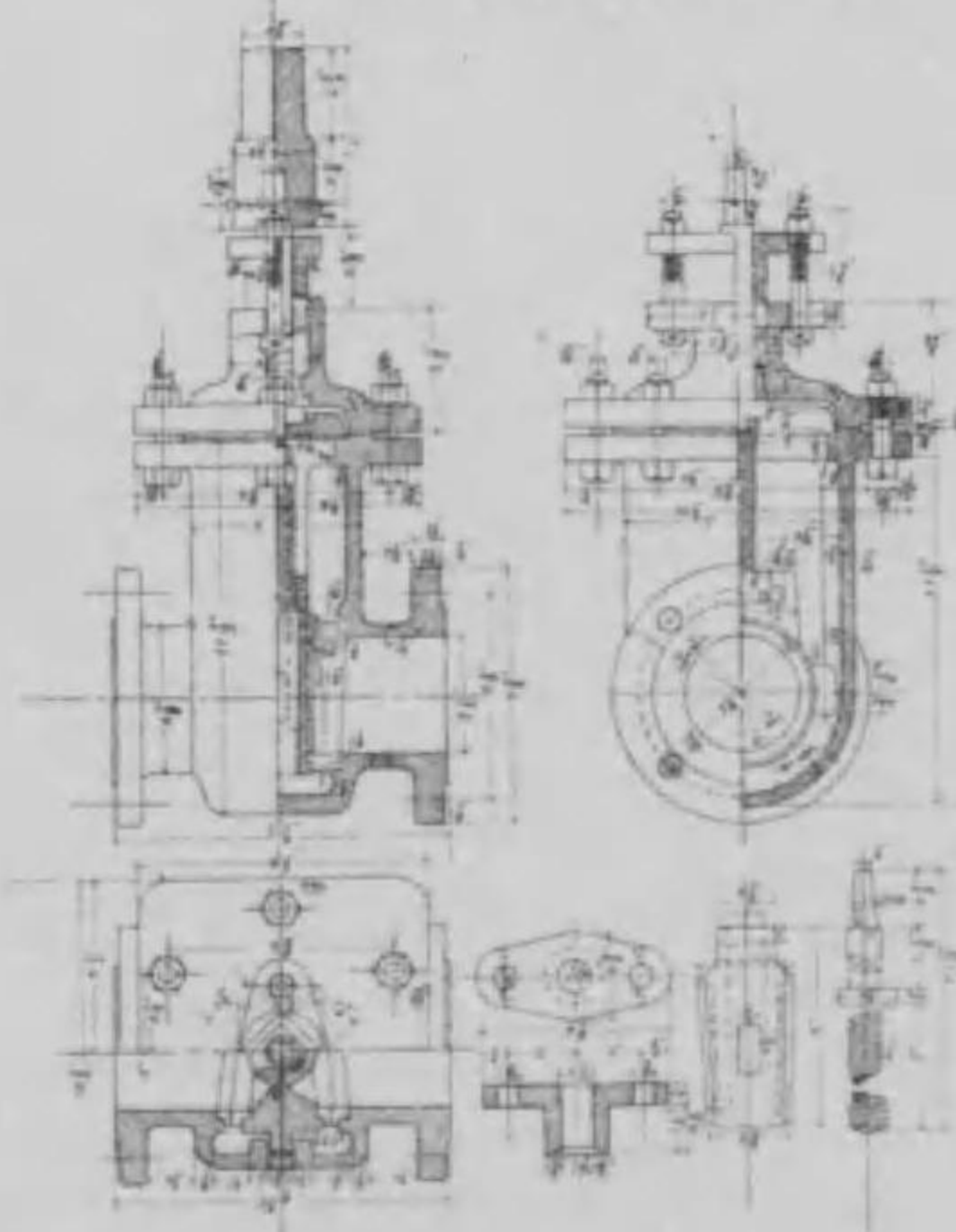

防火栓圖

第八十五號

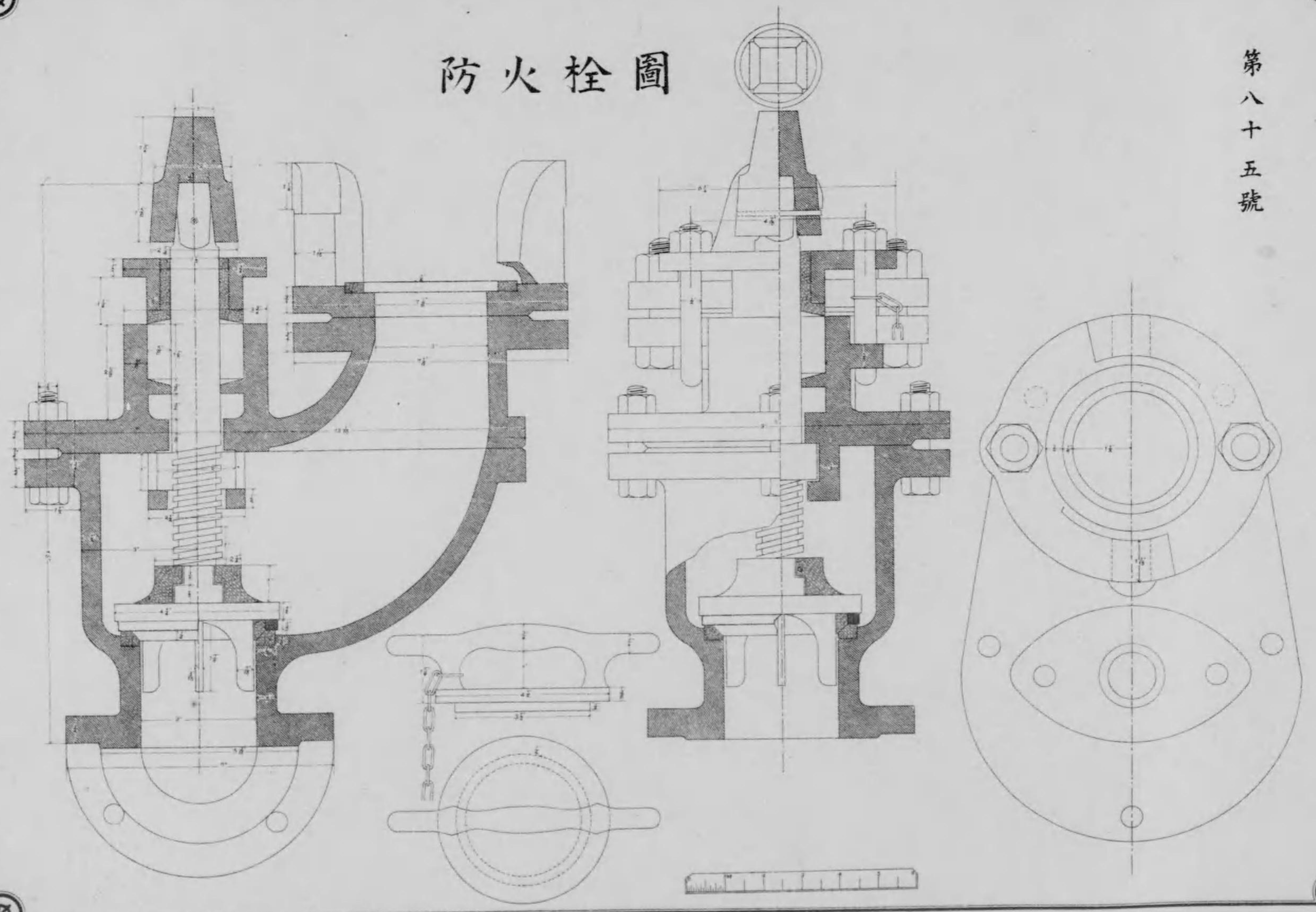

三吋排氣瓣圖

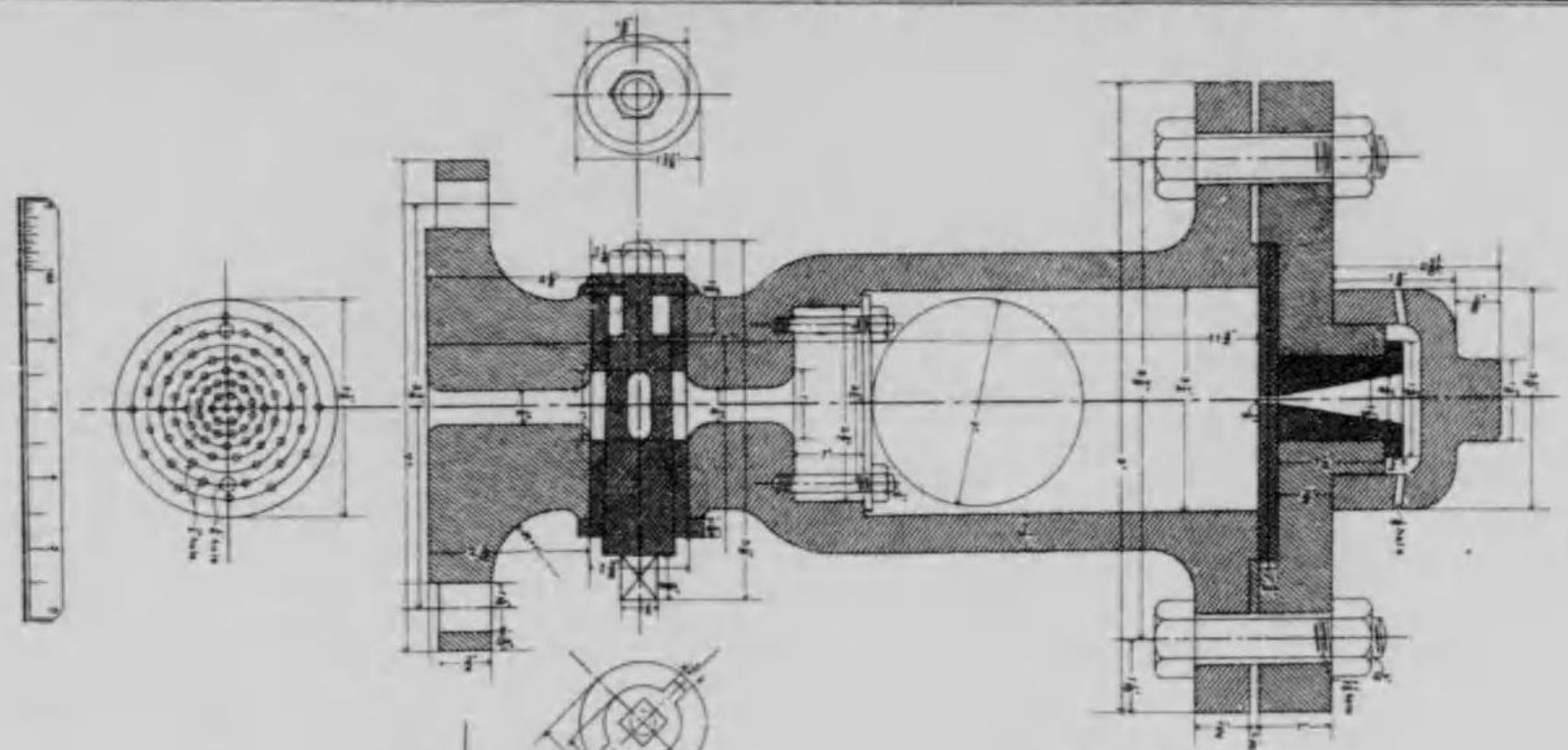

六吋排氣瓣圖

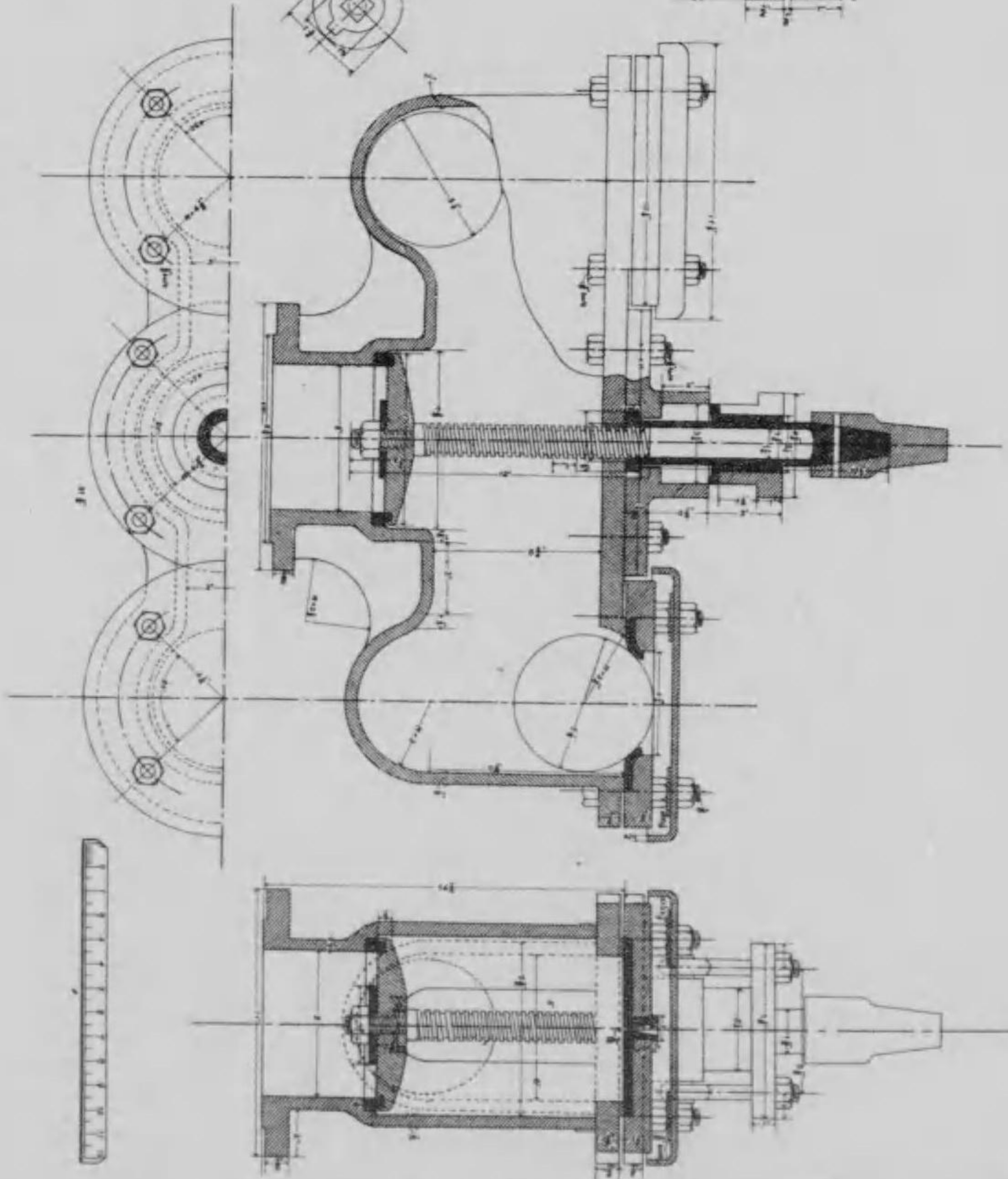

第八十六號

四吋排氣瓣圖

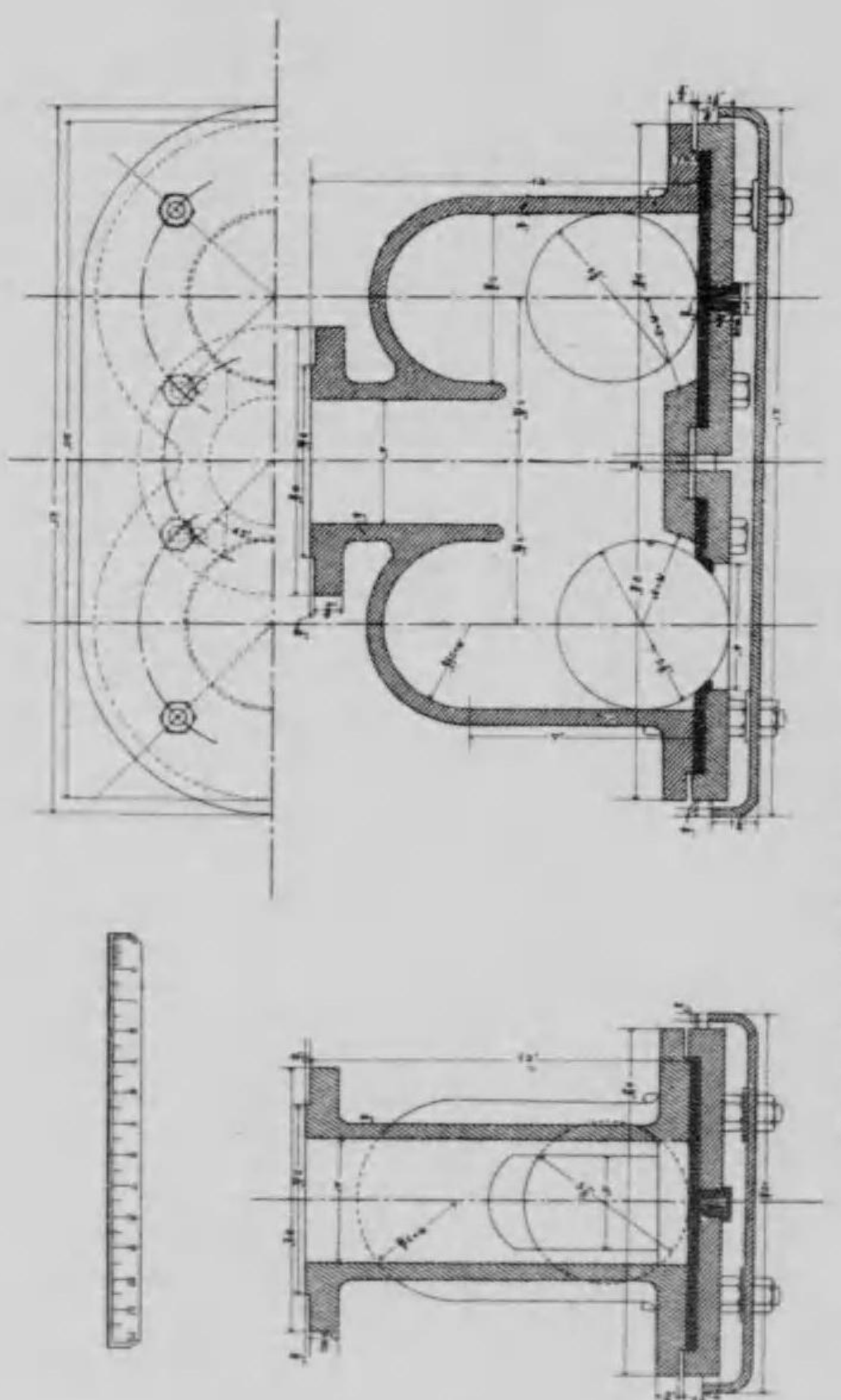

制水瓣防火栓及排氣瓣蓋圖

第八十八號

二十八吋以下制水瓣蓋圖

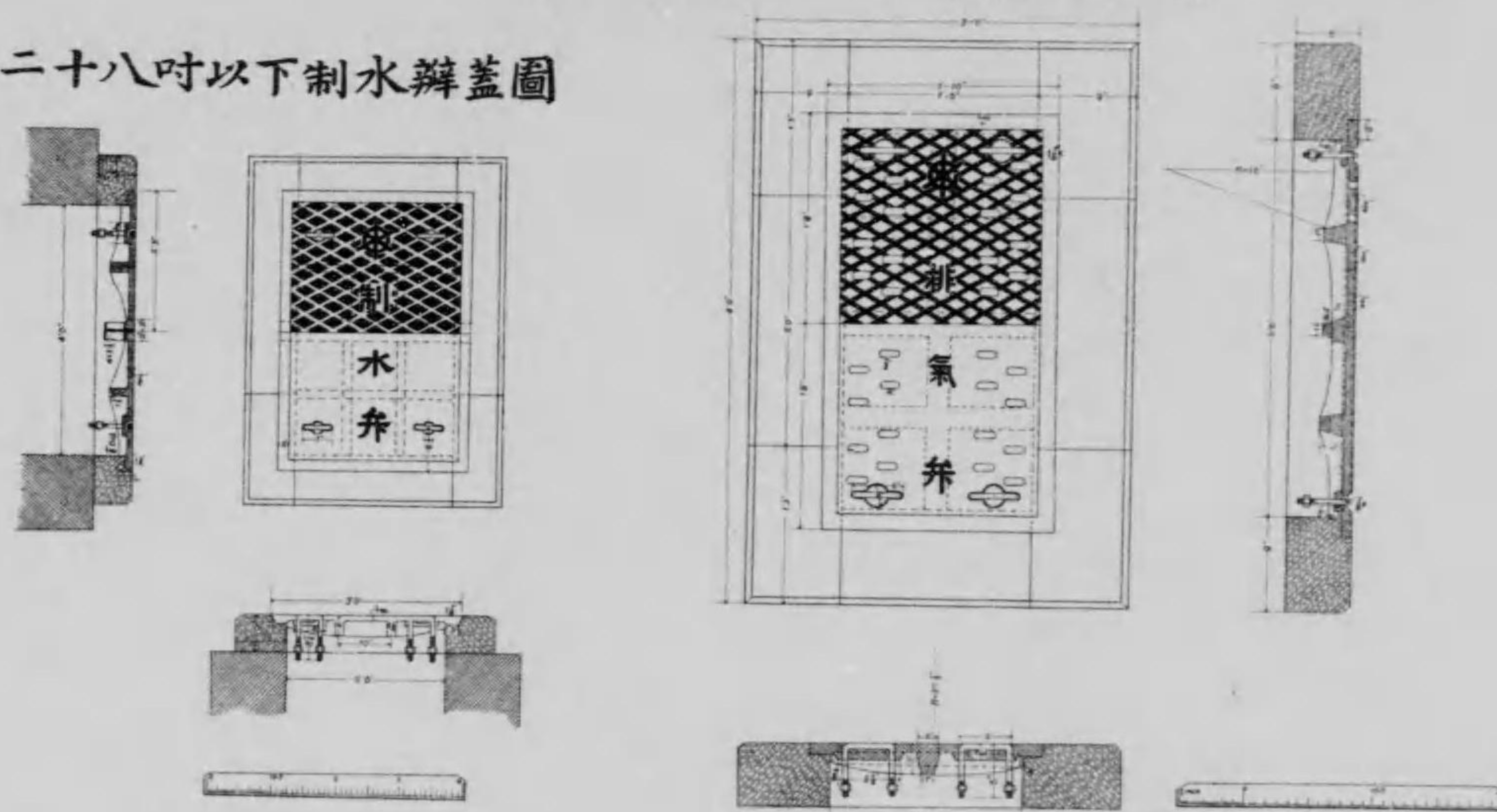

十吋以下制水瓣蓋圖

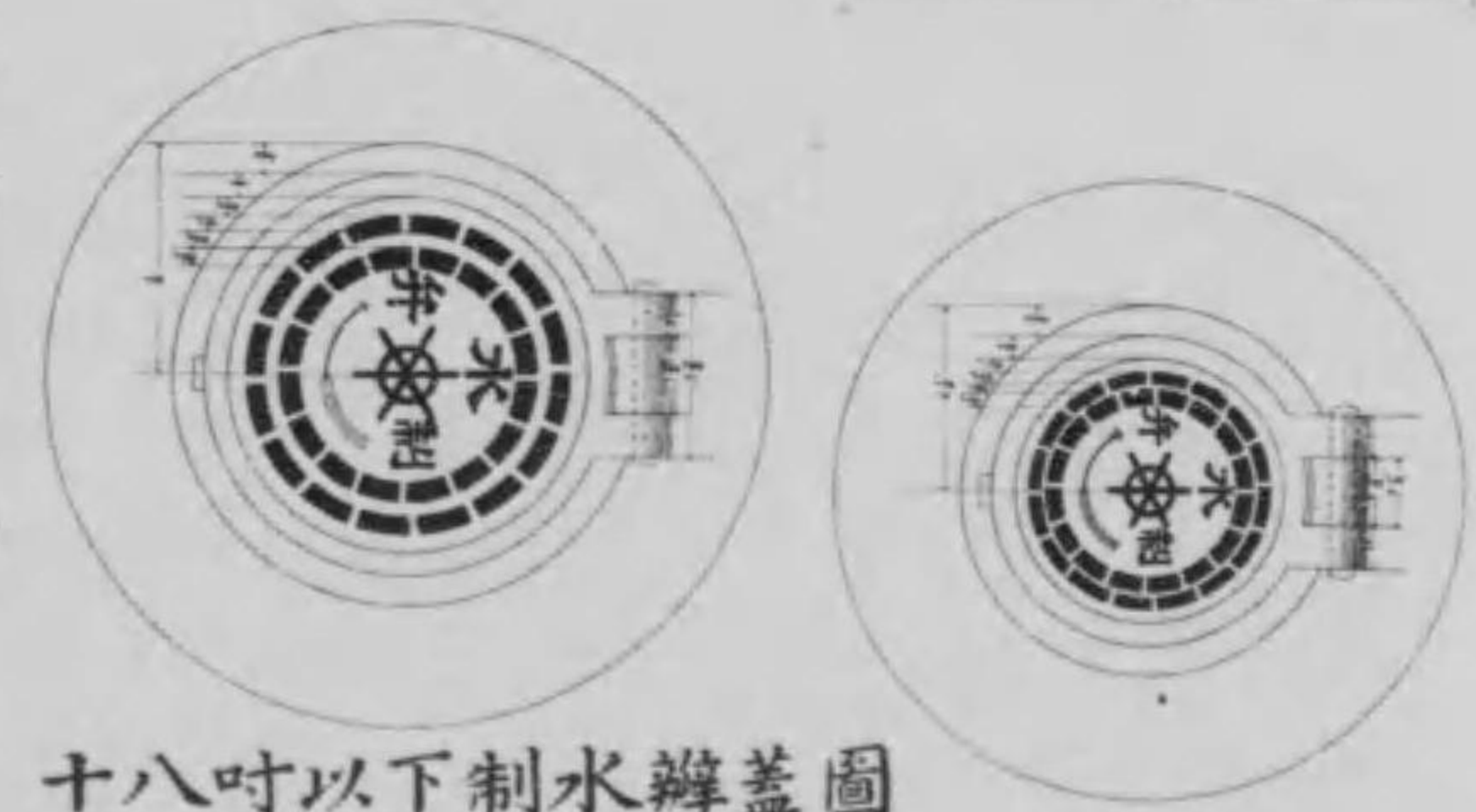
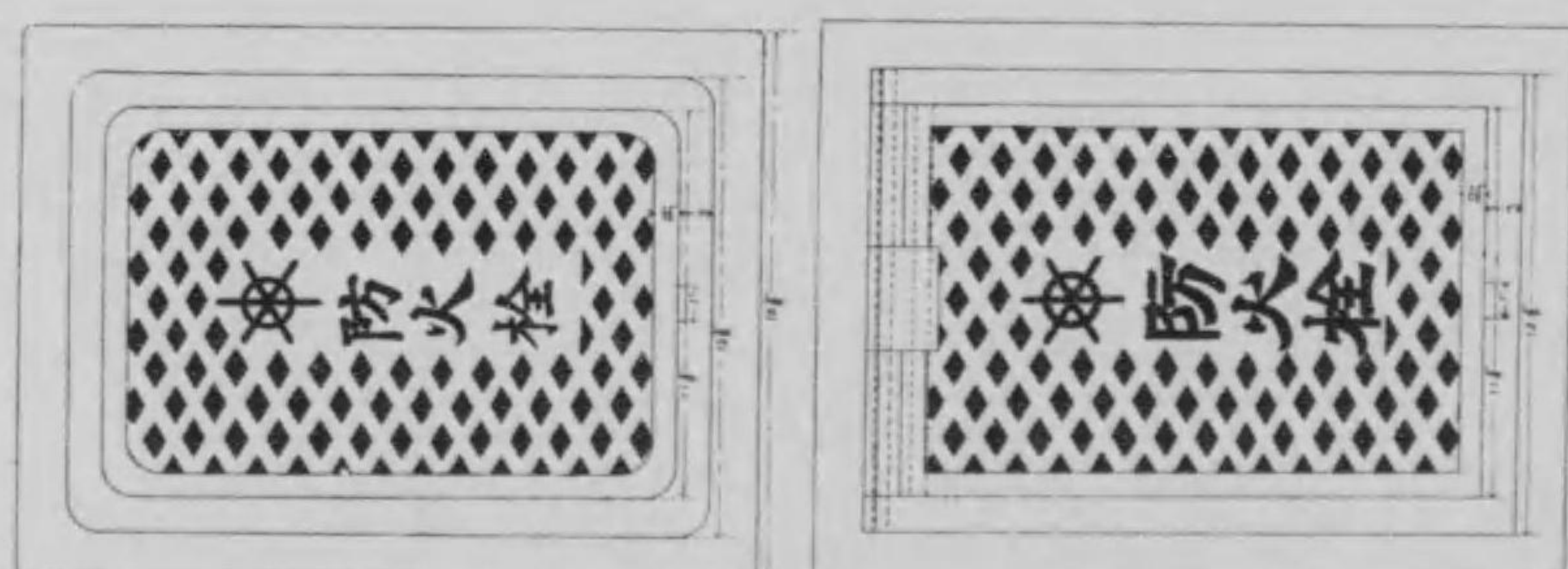
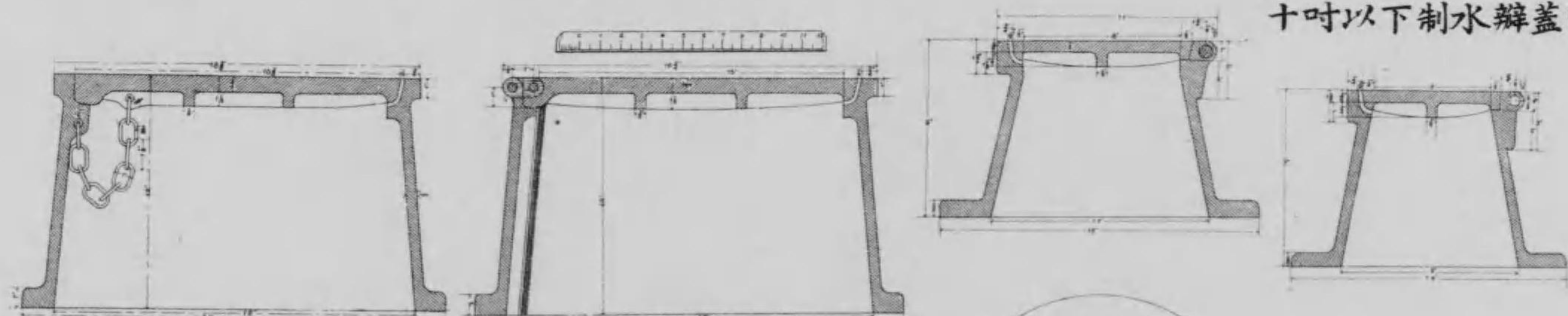

十八吋以下制水瓣蓋圖

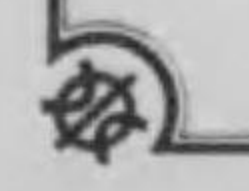
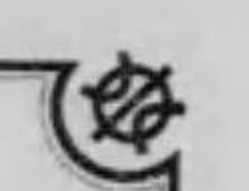

鉄管寸方圖 (其一) 配水用

Socket and Spigot Pipes

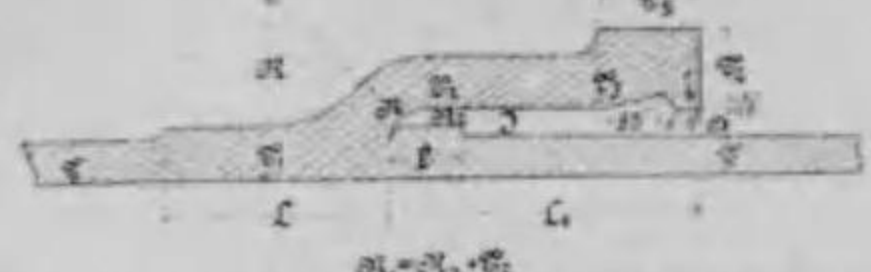

Table with columns for pipe size, length, weight, and other specifications for socket and spigot pipes.

Cross Pieces



Table listing various cross piece sizes and their corresponding weights.

Waper Pieces with Socket

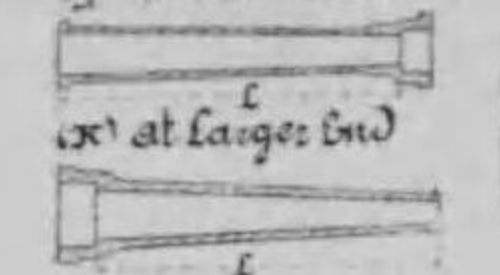

Table listing waper pieces with socket specifications and weights.

Waper Pieces with Spigot

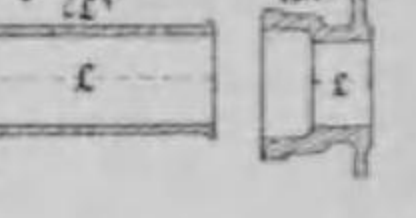

Table listing waper pieces with spigot specifications and weights.

Two flanged branch pieces

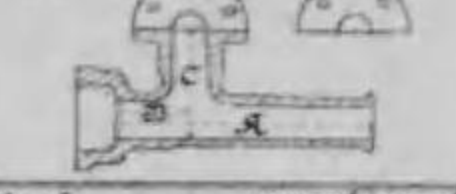

Table listing two-flanged branch piece sizes and weights.

The flange pipes



Table listing flange pipe specifications and weights.

Angled Branch Pieces



Table listing angled branch piece sizes and weights.

Two flanged branch pieces



Table listing two-flanged branch piece sizes and weights.

Special Castings

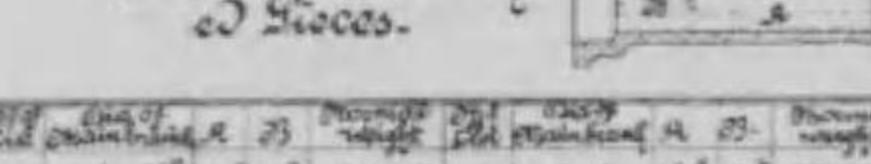

Table listing special casting specifications and weights.

45° or 60° bends

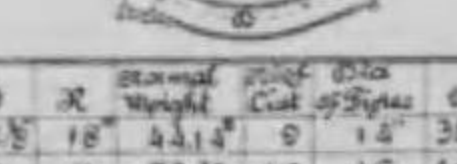

Table listing 45 or 60 degree bend sizes and weights.

30° or 45° bends

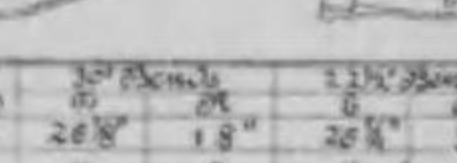

Table listing 30 or 45 degree bend sizes and weights.

Caps



Table listing pipe cap specifications and weights.

Whimbles

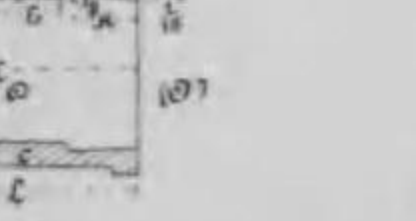

Table listing pipe whimble specifications and weights.

Waper pieces with flange

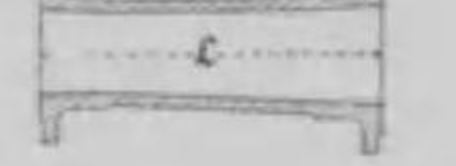

Table listing waper pieces with flange specifications and weights.

淨水用

鉄管寸方圖 (其二)

第九十號



Flange (a)



Flange (b)

Ball-headed Pipe

Ball-headed Pipe	1	2	3	4	5	6	7	8	9	10	11	12	13	14	15	16	17	18	19	20
Weight	1.2	1.5	1.8	2.1	2.4	2.7	3.0	3.3	3.6	3.9	4.2	4.5	4.8	5.1	5.4	5.7	6.0	6.3	6.6	6.9

Special Casting



Special Casting	1	2	3	4	5	6	7	8	9	10	11	12	13	14	15	16	17	18	19	20
Weight	1.2	1.5	1.8	2.1	2.4	2.7	3.0	3.3	3.6	3.9	4.2	4.5	4.8	5.1	5.4	5.7	6.0	6.3	6.6	6.9

Special Casting



Special Casting	1	2	3	4	5	6	7	8	9	10	11	12	13	14	15	16	17	18	19	20
Weight	1.2	1.5	1.8	2.1	2.4	2.7	3.0	3.3	3.6	3.9	4.2	4.5	4.8	5.1	5.4	5.7	6.0	6.3	6.6	6.9

Quarter or 90° Bend



Quarter or 90° Bend	1	2	3	4	5	6	7	8	9	10	11	12	13	14	15	16	17	18	19	20
Weight	1.2	1.5	1.8	2.1	2.4	2.7	3.0	3.3	3.6	3.9	4.2	4.5	4.8	5.1	5.4	5.7	6.0	6.3	6.6	6.9



Quarter or 90° Bend	1	2	3	4	5	6	7	8	9	10	11	12	13	14	15	16	17	18	19	20
Weight	1.2	1.5	1.8	2.1	2.4	2.7	3.0	3.3	3.6	3.9	4.2	4.5	4.8	5.1	5.4	5.7	6.0	6.3	6.6	6.9

90° Bend

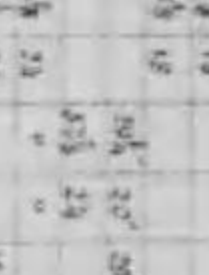

90° Bend	1	2	3	4	5	6	7	8	9	10	11	12	13	14	15	16	17	18	19	20
Weight	1.2	1.5	1.8	2.1	2.4	2.7	3.0	3.3	3.6	3.9	4.2	4.5	4.8	5.1	5.4	5.7	6.0	6.3	6.6	6.9

Cast Pipe



Cast Pipe	1	2	3	4	5	6	7	8	9	10	11	12	13	14	15	16	17	18	19	20
Weight	1.2	1.5	1.8	2.1	2.4	2.7	3.0	3.3	3.6	3.9	4.2	4.5	4.8	5.1	5.4	5.7	6.0	6.3	6.6	6.9

Soft Pipe

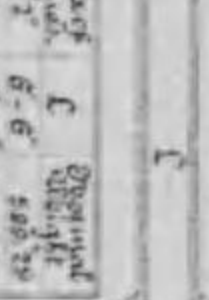

Soft Pipe	1	2	3	4	5	6	7	8	9	10	11	12	13	14	15	16	17	18	19	20
Weight	1.2	1.5	1.8	2.1	2.4	2.7	3.0	3.3	3.6	3.9	4.2	4.5	4.8	5.1	5.4	5.7	6.0	6.3	6.6	6.9

Spigot

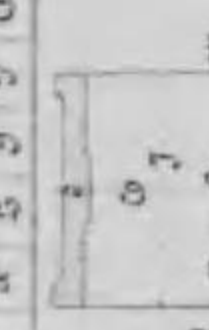

Spigot	1	2	3	4	5	6	7	8	9	10	11	12	13	14	15	16	17	18	19	20
Weight	1.2	1.5	1.8	2.1	2.4	2.7	3.0	3.3	3.6	3.9	4.2	4.5	4.8	5.1	5.4	5.7	6.0	6.3	6.6	6.9

Solid and Split Pipes



Solid and Split Pipes	1	2	3	4	5	6	7	8	9	10	11	12	13	14	15	16	17	18	19	20
Weight	1.2	1.5	1.8	2.1	2.4	2.7	3.0	3.3	3.6	3.9	4.2	4.5	4.8	5.1	5.4	5.7	6.0	6.3	6.6	6.9

Flange Pipes



Flange Pipes	1	2	3	4	5	6	7	8	9	10	11	12	13	14	15	16	17	18	19	20
Weight	1.2	1.5	1.8	2.1	2.4	2.7	3.0	3.3	3.6	3.9	4.2	4.5	4.8	5.1	5.4	5.7	6.0	6.3	6.6	6.9

See Socket



See Socket	1	2	3	4	5	6	7	8	9	10	11	12	13	14	15	16	17	18	19	20
Weight	1.2	1.5	1.8	2.1	2.4	2.7	3.0	3.3	3.6	3.9	4.2	4.5	4.8	5.1	5.4	5.7	6.0	6.3	6.6	6.9

See Flange



See Flange	1	2	3	4	5	6	7	8	9	10	11	12	13	14	15	16	17	18	19	20
Weight	1.2	1.5	1.8	2.1	2.4	2.7	3.0	3.3	3.6	3.9	4.2	4.5	4.8	5.1	5.4	5.7	6.0	6.3	6.6	6.9

大正二年六月二十五日印刷
大正二年六月二十九日發行

發行者 京都市役所

印刷者 井手正三
京都市上京區南禪寺町字高岸

印刷所 合資商報會社
京都市上京區柳馬場通二條下ル

終