

欽定西清古鑑

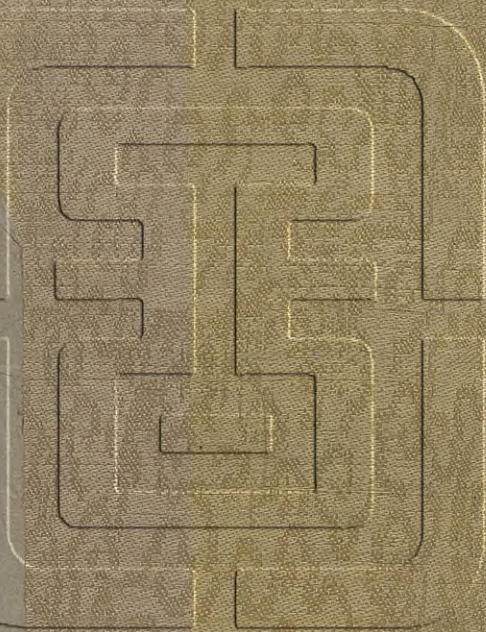

18
19
20
21
22
23
24
25
26
27
28
29
30
31
32
33
34
35
36
37
38
39
40
41
42

$\frac{1}{2}$

320

846.1

= 4

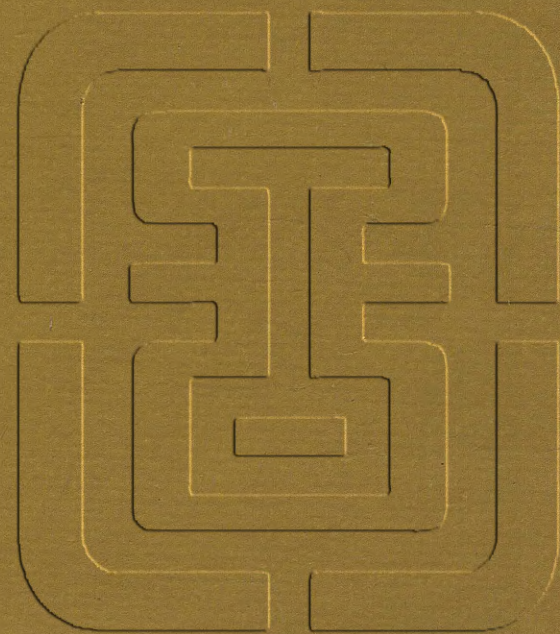
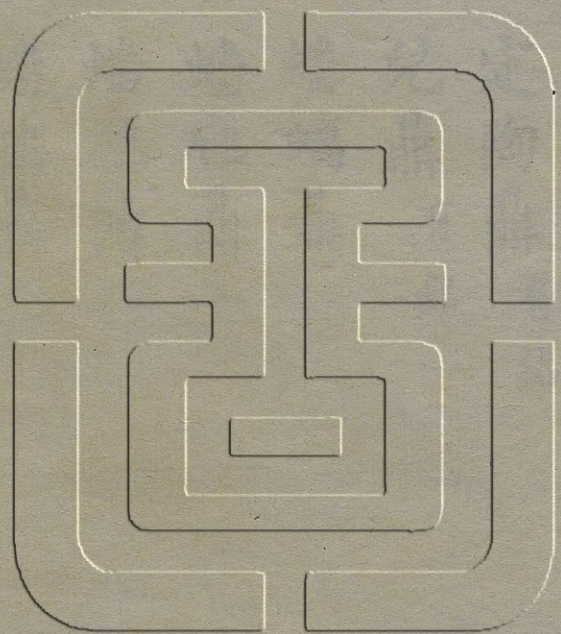

西清古鑑卷七目錄

鼎七

漢

定陶鼎

有銘

兒鼎

有銘

蟠螭鼎

蟠虺鼎

蟠虺鼎

蟠虺鼎

三犧鼎

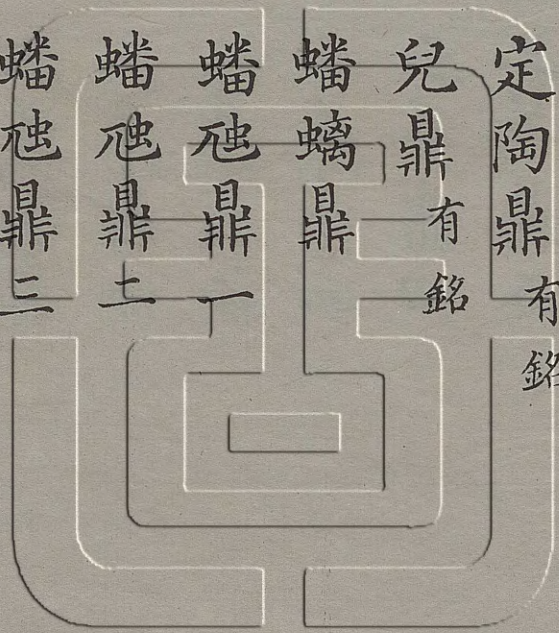
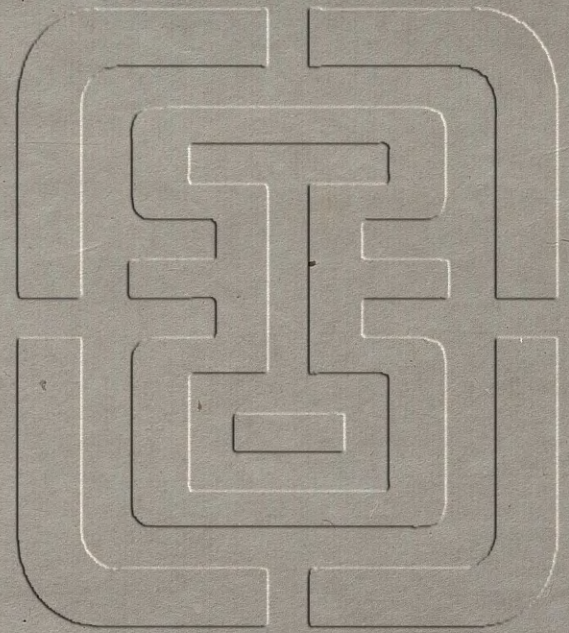

三犧鼎二

三犧小鼎

三羊鼎一

三羊鼎二

三羊鼎三

三羊鼎四

三羊鼎五

三羊鼎六

三羊小鼎

夔紋鼎一

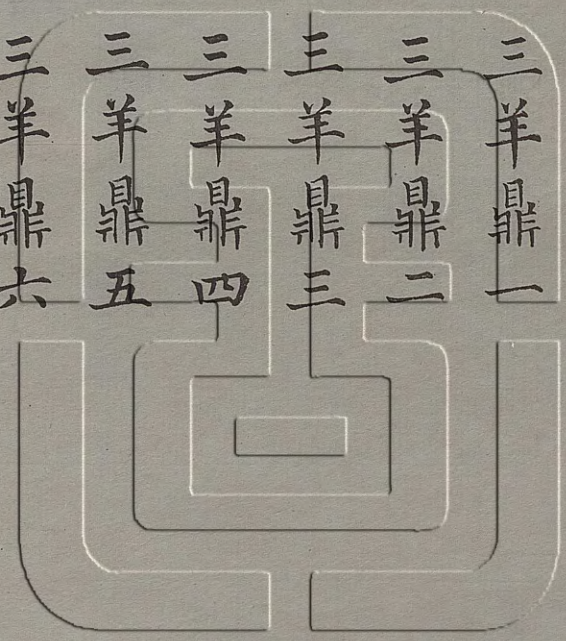

夔紋鼎二

夔紋鼎三

弦紋鼎一

弦紋鼎二

弦紋鼎三

弦紋鼎四

弦紋鼎五

弦紋鼎六

弦紋鼎七

弦紋鼎八

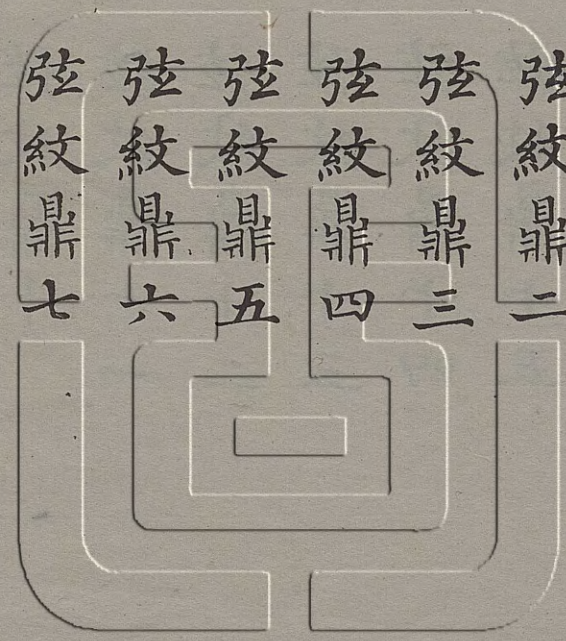

弦紋鼎九

弦紋鼎十

弦紋鼎十一

弦紋鼎十二

弦紋鼎十三

弦紋鼎十四

弦紋鼎十五

弦紋鼎十六

帶紋小鼎

素鼎一

素鼎二

素鼎三

素鼎四

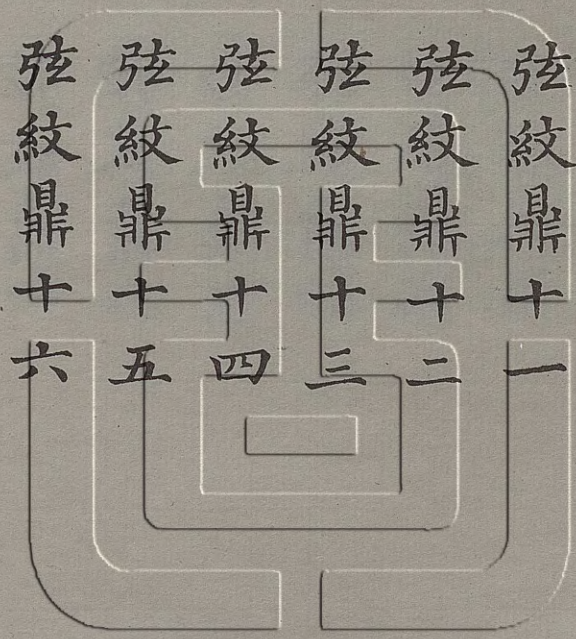
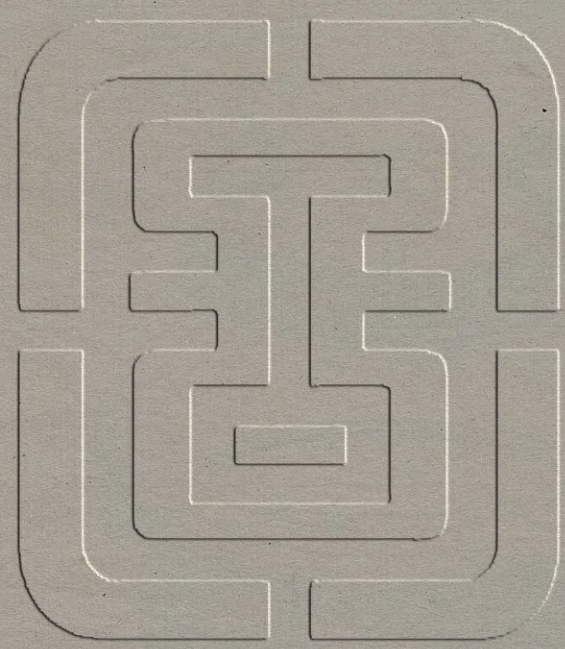

漢定陶鼎

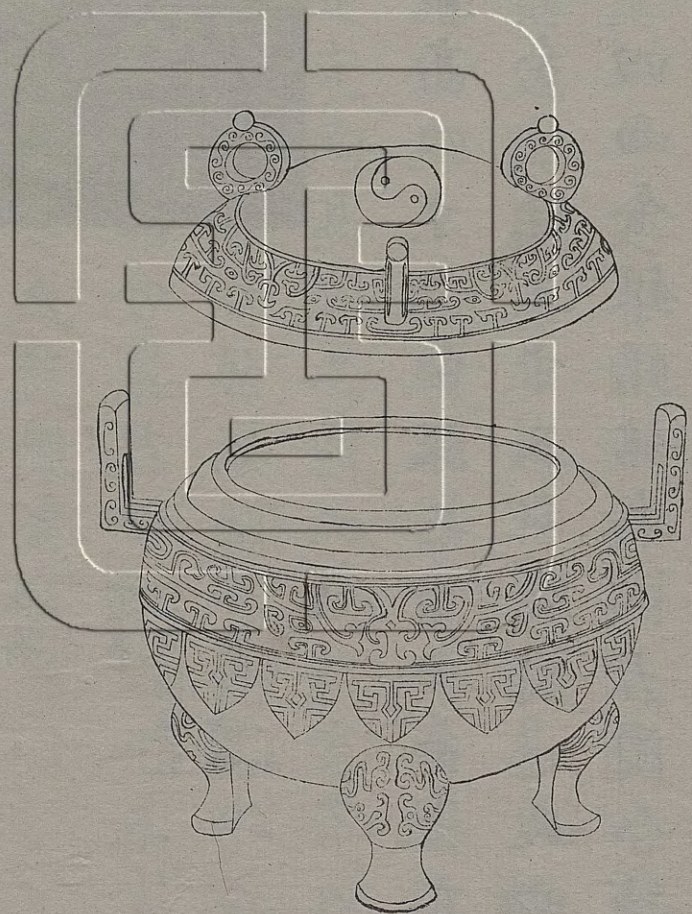

高廟

高廟

都倉

都倉

定陶廟容
十斗并重
兩

定陶廟容
斗并重
兩

右通蓋高四寸一分深二寸七分耳高一寸三

分濶八分口徑三寸五分腹圍一尺四寸九分

重五十四兩金銀錯銘與博古圖合缺三字彼

特純素為異并字博古圖讀作共字非是今從

薛尚功釋文仍作并博古圖謂定陶為趙共王

恢以共王初封梁梁為彭越舊封漢書有立越

為梁王都定陶之文也按地理志濟陰郡注宣

帝甘露二年更名定陶前此定陶非國名銘詞

不應稱定陶廟其非趙共王明甚又按惠帝紀

令郡諸侯王立高廟此器前云高廟後云定陶

廟當是定陶高廟之鼎而鑄於宣帝以後者耳

都倉博古圖未詳然漢制有衡官水司空都水

農倉又郡國諸倉農監都水六十五官長丞皆

屬焉此云都倉或監製者官名

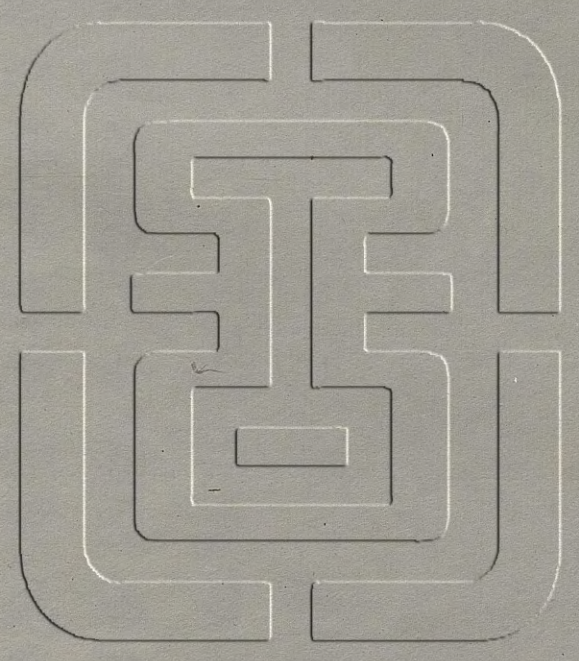

漢兒鼎

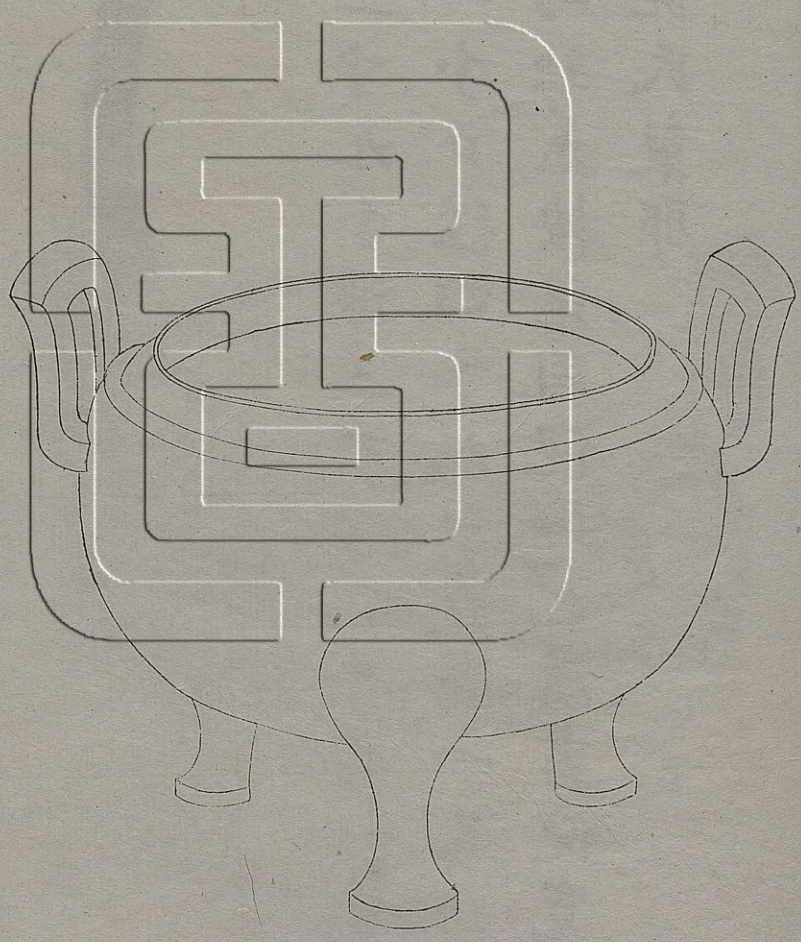

明
兒

右高三寸九分深三寸一分耳高一寸七分濶
一寸一分口徑四寸九分腹圍一尺八寸重四
十七兩缺蓋按兒同倪姓也漢書倪寬作兒寬
鼎其倪氏製耶

漢蟠螭鼎

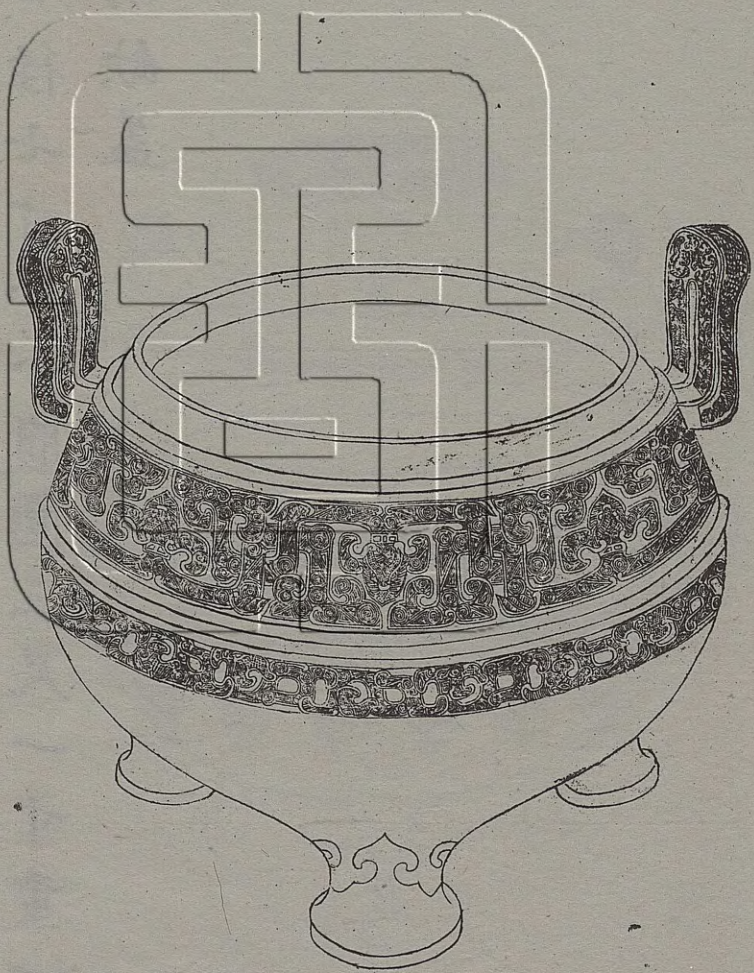

右高七寸深五寸九分耳高二寸四分濶二寸
 一分口徑七寸八分腹圍三尺一寸重一百六
 十五兩缺蓋

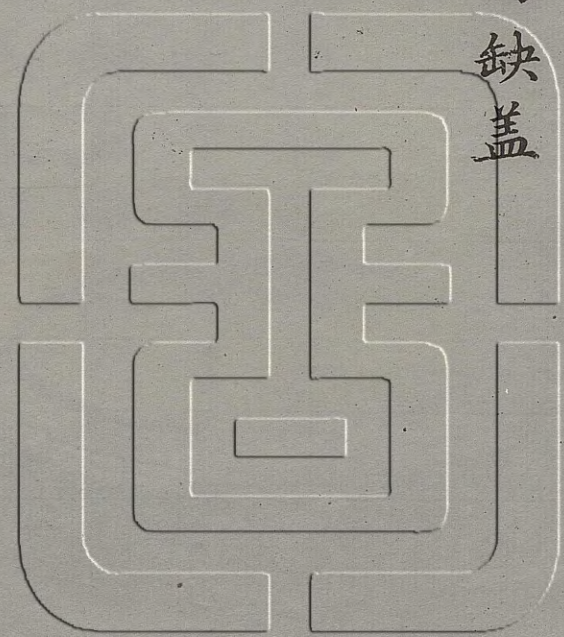

漢蟠虺鼎一

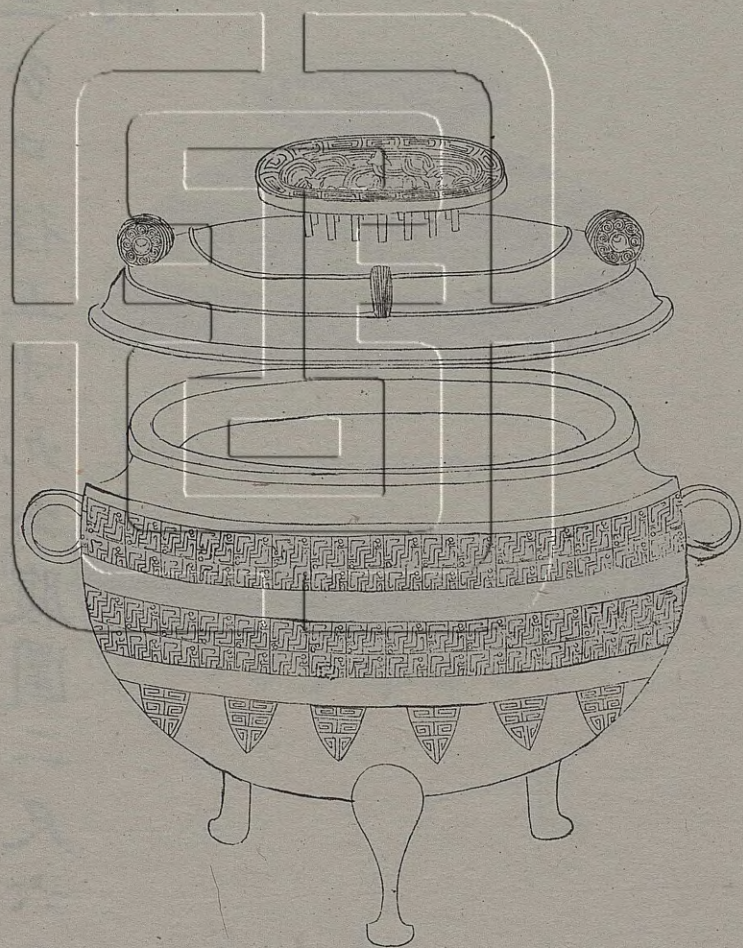

右通蓋高六寸一分深三寸八分耳在旁高八分濶三分口徑五寸九分腹圍二尺六分重五十七兩

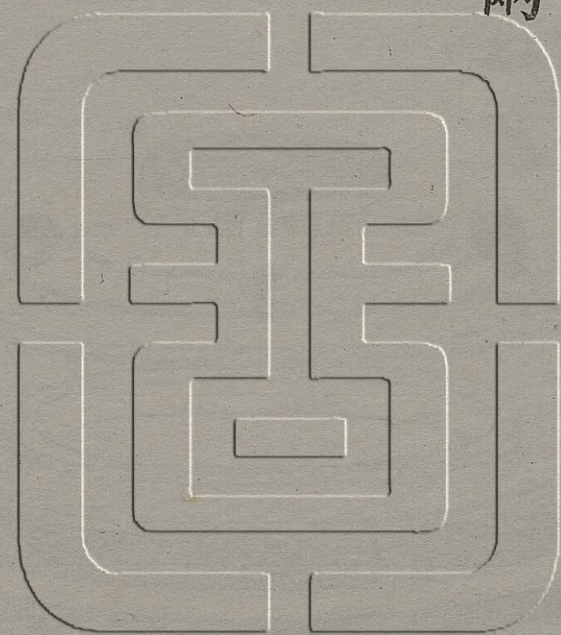

漢蟠虺鼎二

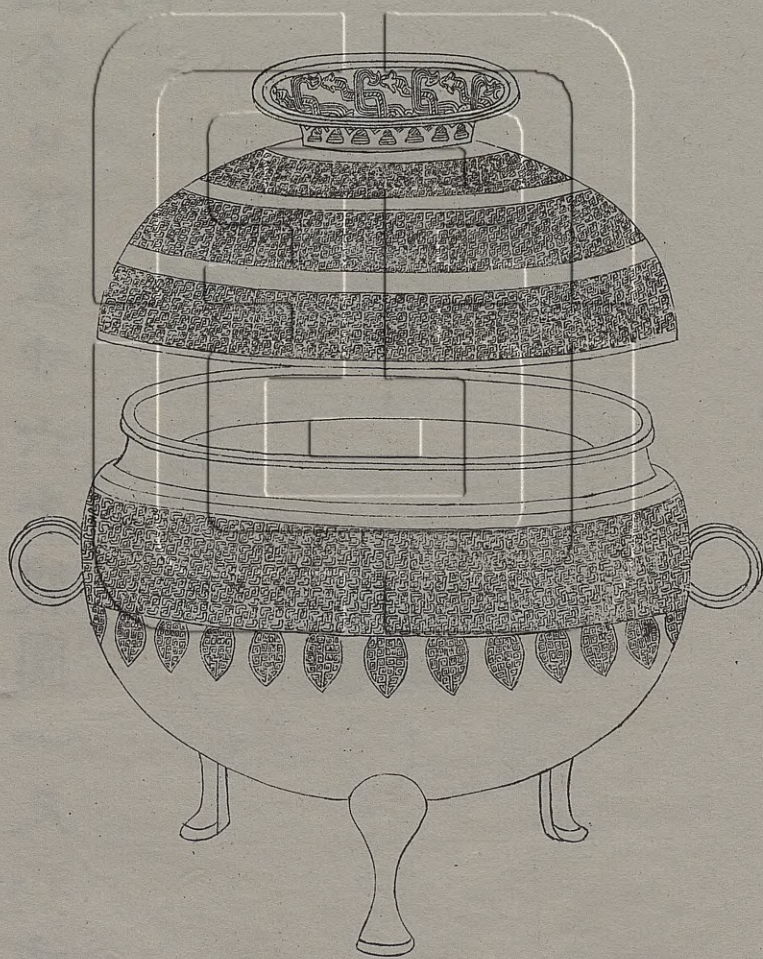

右通蓋高五寸八分深三寸一分耳在旁高八分濶三分口徑五寸六分腹圍一尺八寸重四十二兩

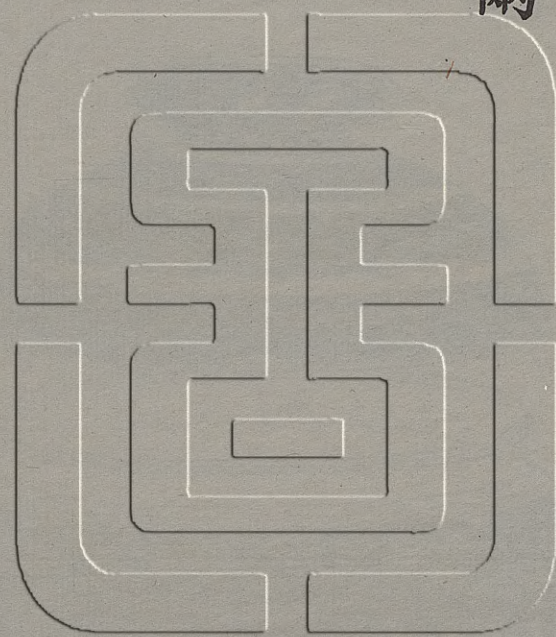

漢蟠虺鼎三



右通蓋高三寸三分深二寸二分耳高一寸濶
八分口徑三寸一分腹圍一尺一寸重二十五
兩金銀錯

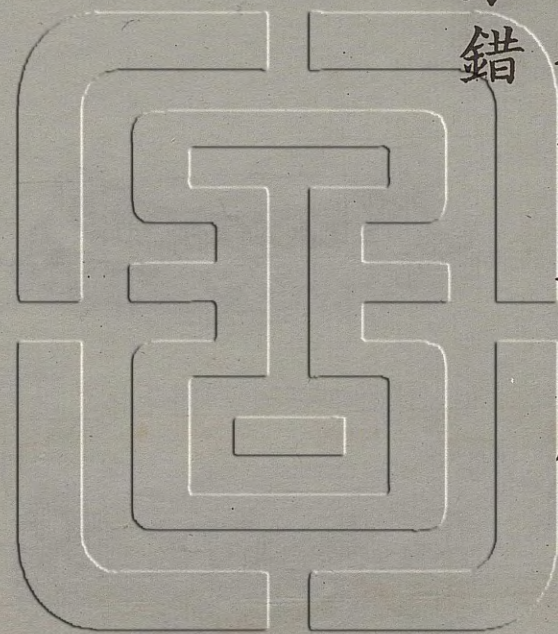

漢三犧鼎一

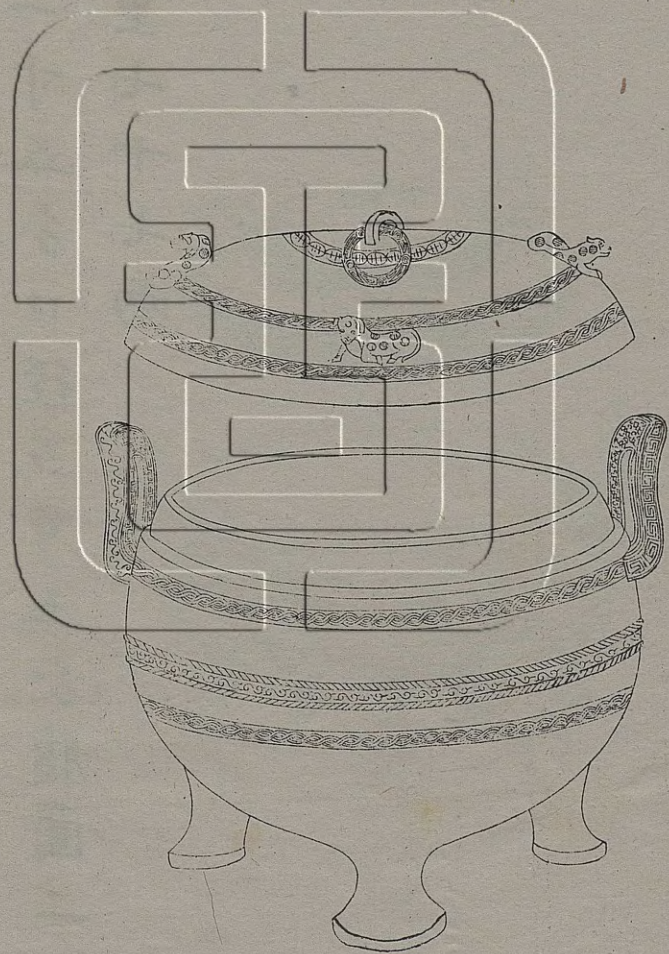

右通蓋高五寸九分深三寸九分耳高一寸八
 分濶一寸五分口徑五寸五分腹圍二尺一寸
 二分重七十七兩



漢三犧鼎二

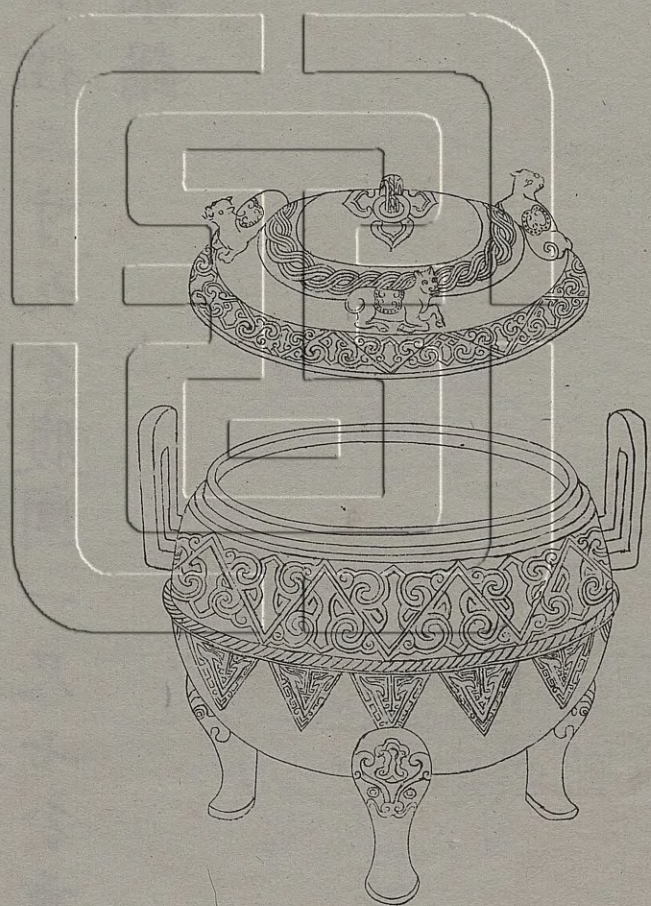

右通蓋高三寸二分深一寸八分耳高一寸濶
 七分口徑二寸九分腹圍一尺七分重一十七
 兩金銀錯

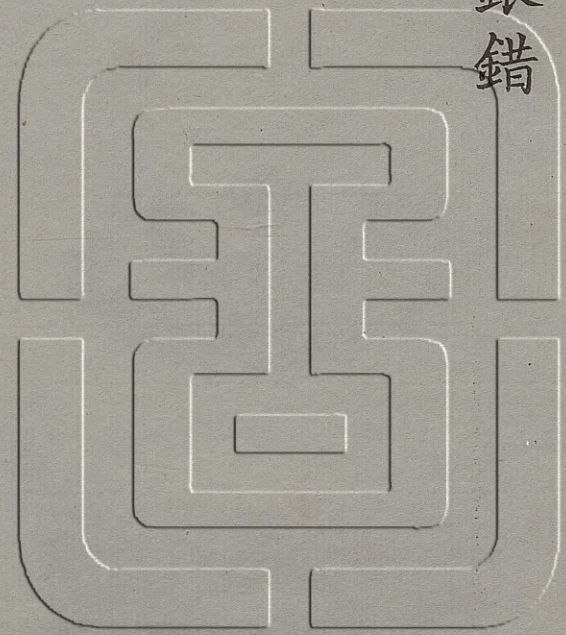

漢三犧小鼎

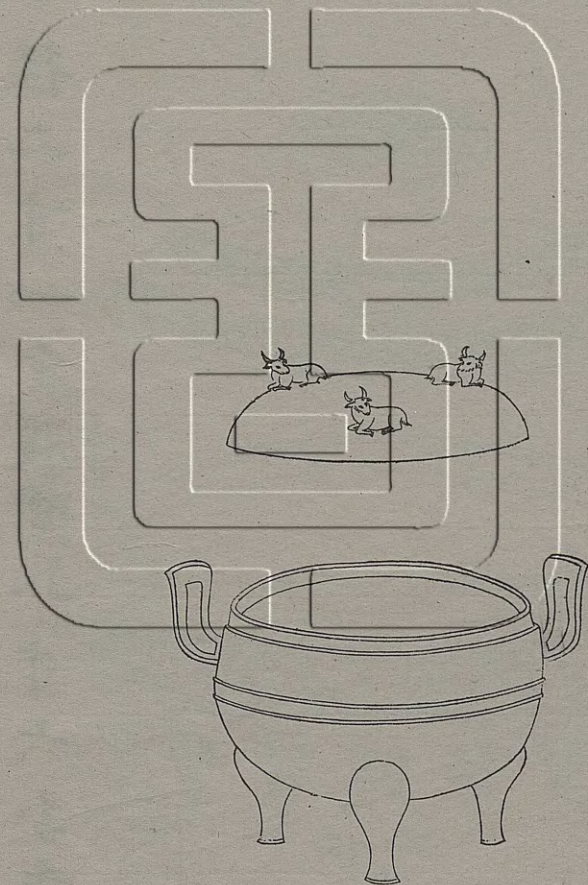

右通蓋高二寸四分深一寸五分耳高九分濶六分口徑二寸一分腹圍八寸六分重一十五兩

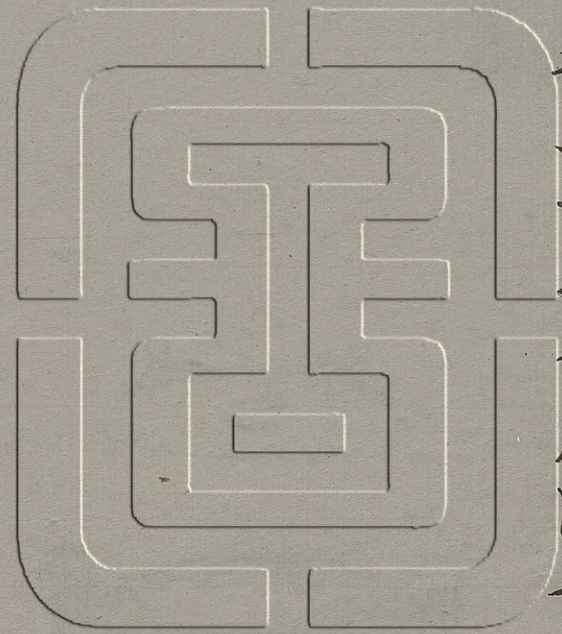

漢三羊鼎一

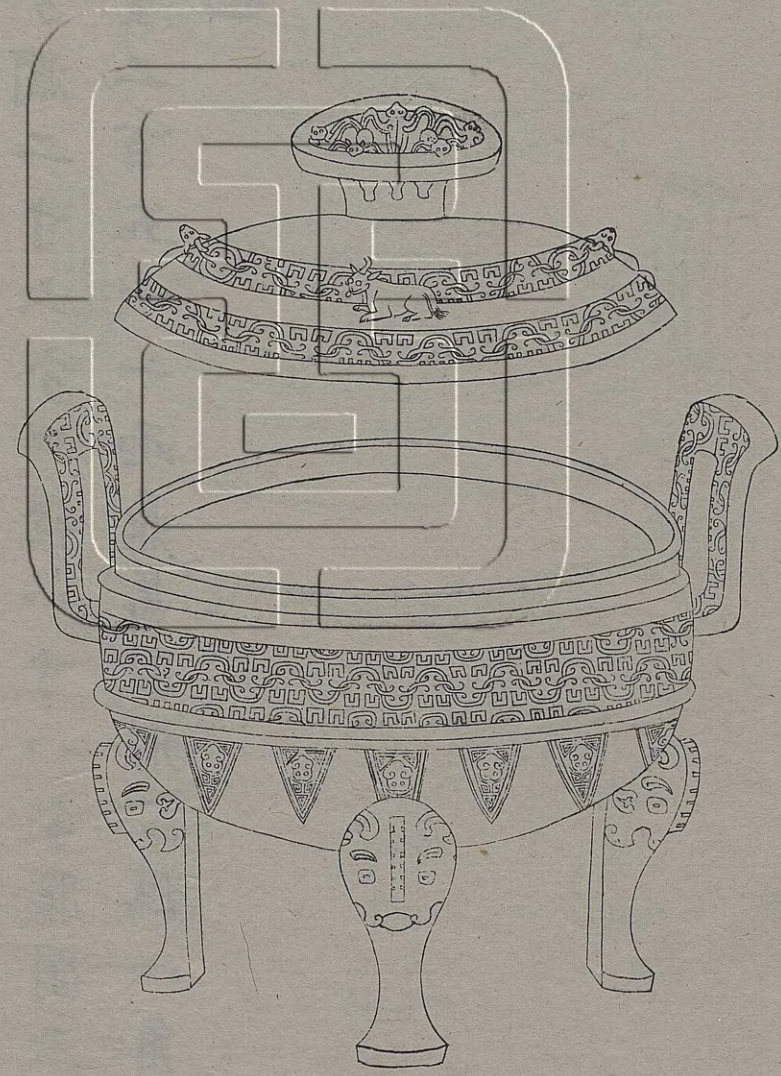

右通蓋高一尺一寸二分深五寸一分耳高三寸五分濶二寸六分口徑八寸八分腹圍三尺八分重二百五十一兩鼎蓋獸形三俱一角蓋神羊也

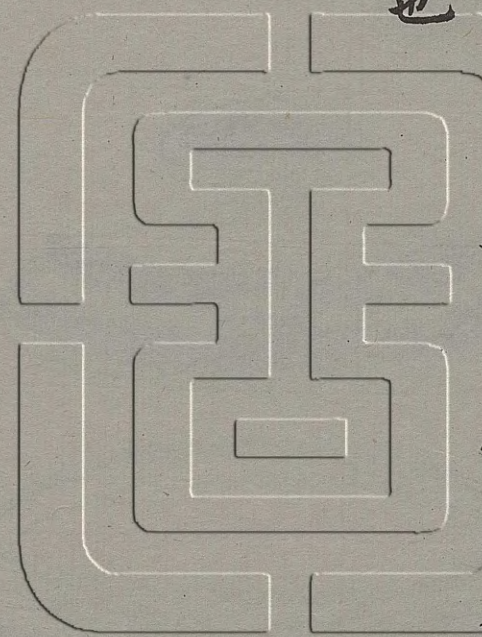

漢三羊鼎二

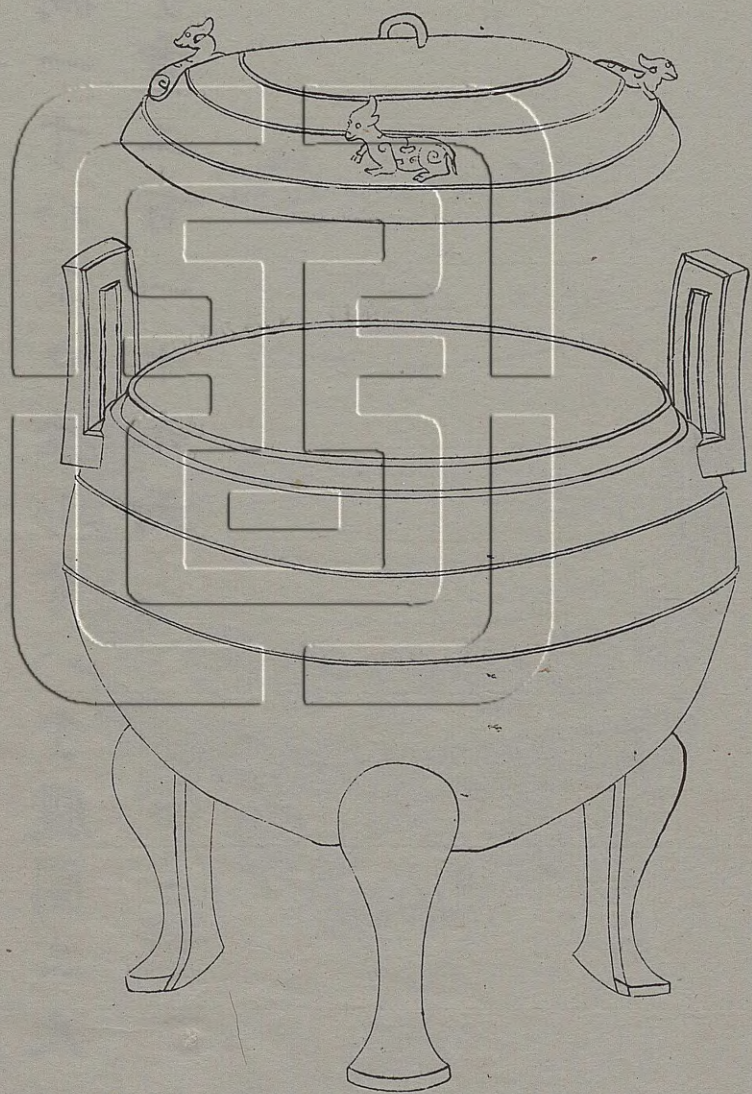

右通蓋高九寸八分深五寸八分耳高二寸六分濶一寸八分口径七寸八分腹圍二尺八寸三分重二百一十九兩

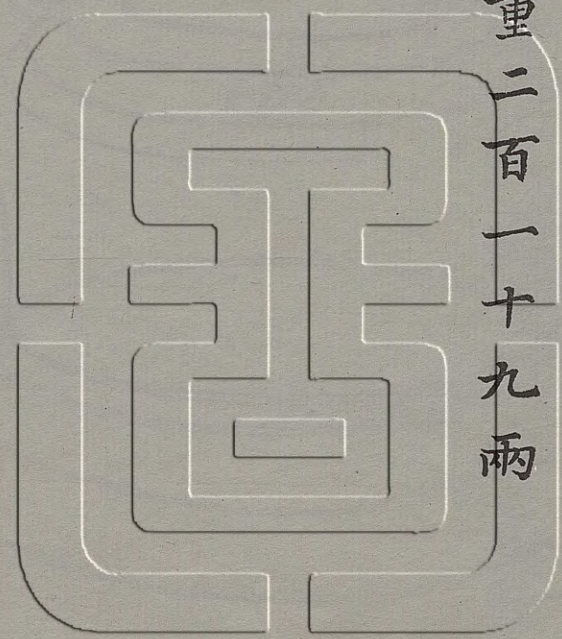

漢三羊鼎三

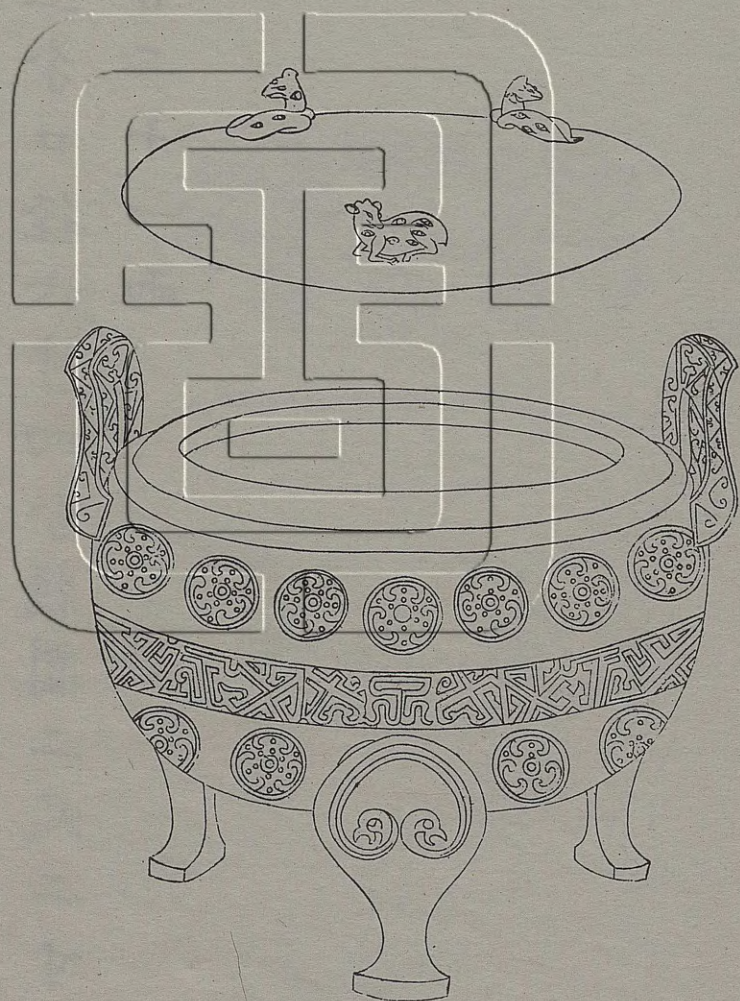

右通蓋高六寸深三寸六分耳高二寸二分濶
 一寸三分口徑六寸四分腹圍二尺二寸三分
 重一百二十一兩

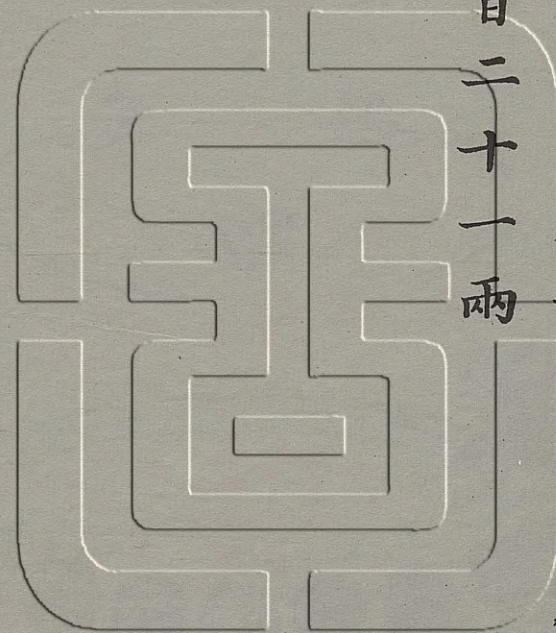

漢三羊鼎四



西清古鑑

卷十

鼎

三

右通蓋高五寸八分深三寸九分耳高二寸二分潤一寸五分口徑五寸六分腹圍二尺一寸重一百六兩

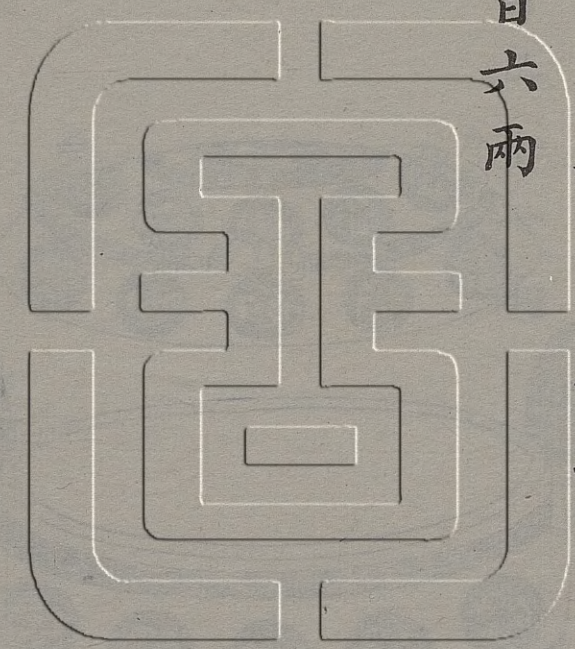

漢三羊鼎五

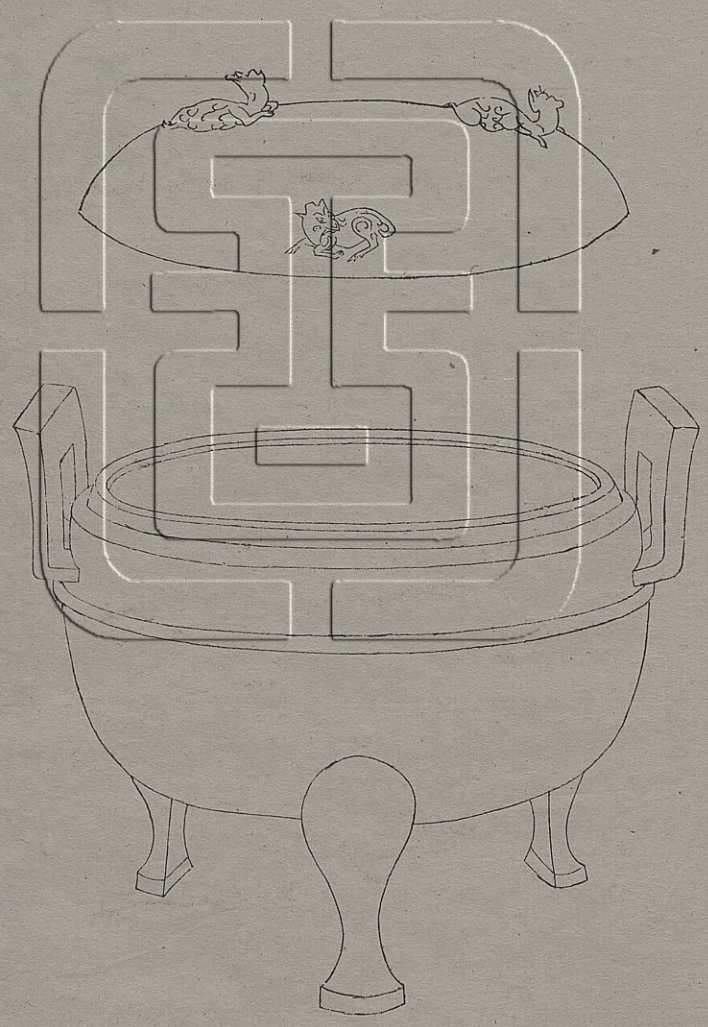

右通蓋高四寸九分深二寸六分耳高一寸三分
 濶九分口徑四寸一分腹圍一尺五寸七分
 重四十五兩



漢三羊鼎六

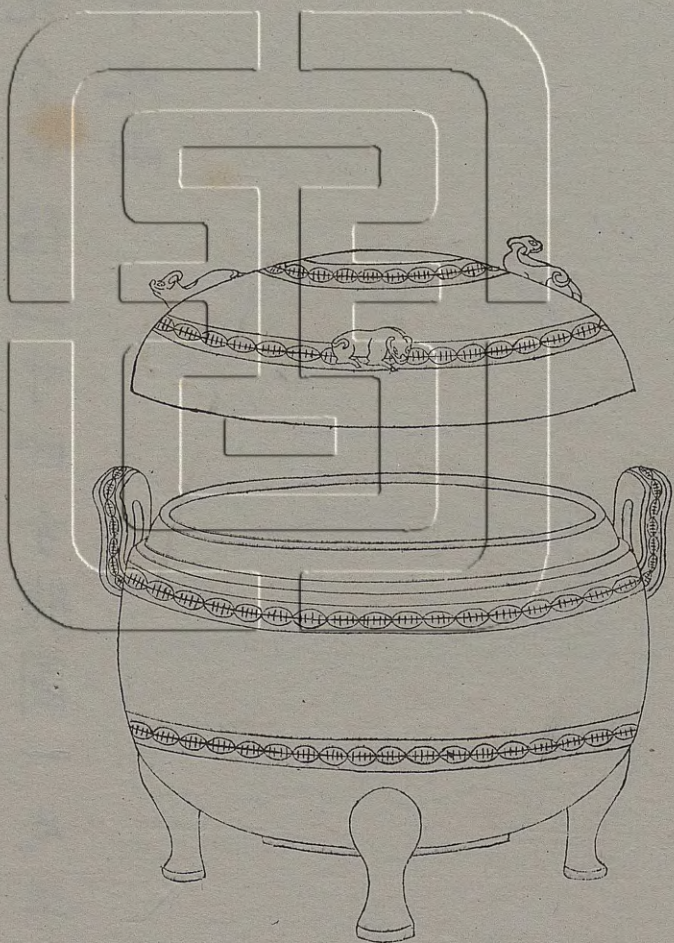

右通蓋高三寸二分深二寸四分耳高一寸一分濶九分口徑三寸四分腹圍一尺二寸八分重二十九兩

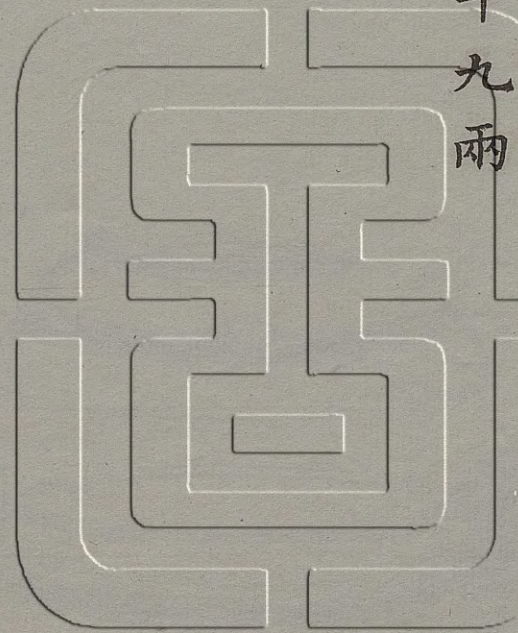

漢三羊小鼎

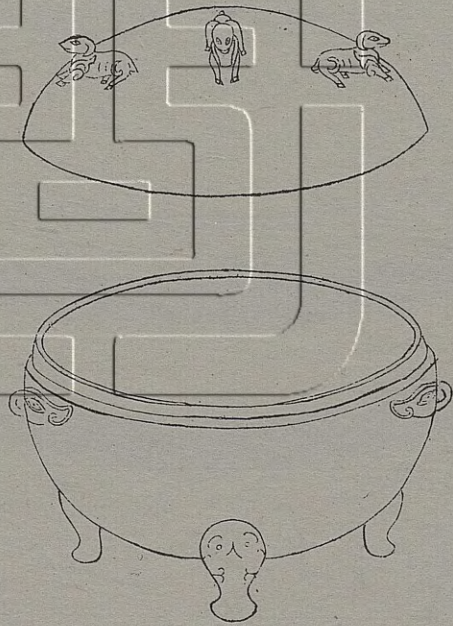

右通蓋高三寸二分深一寸四分獸耳在旁口
徑二寸四分腹圍八寸五分重一十四兩

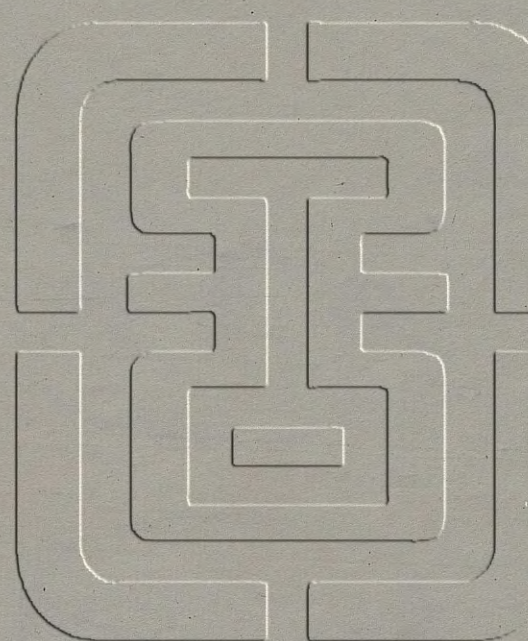

漢夔紋鼎一

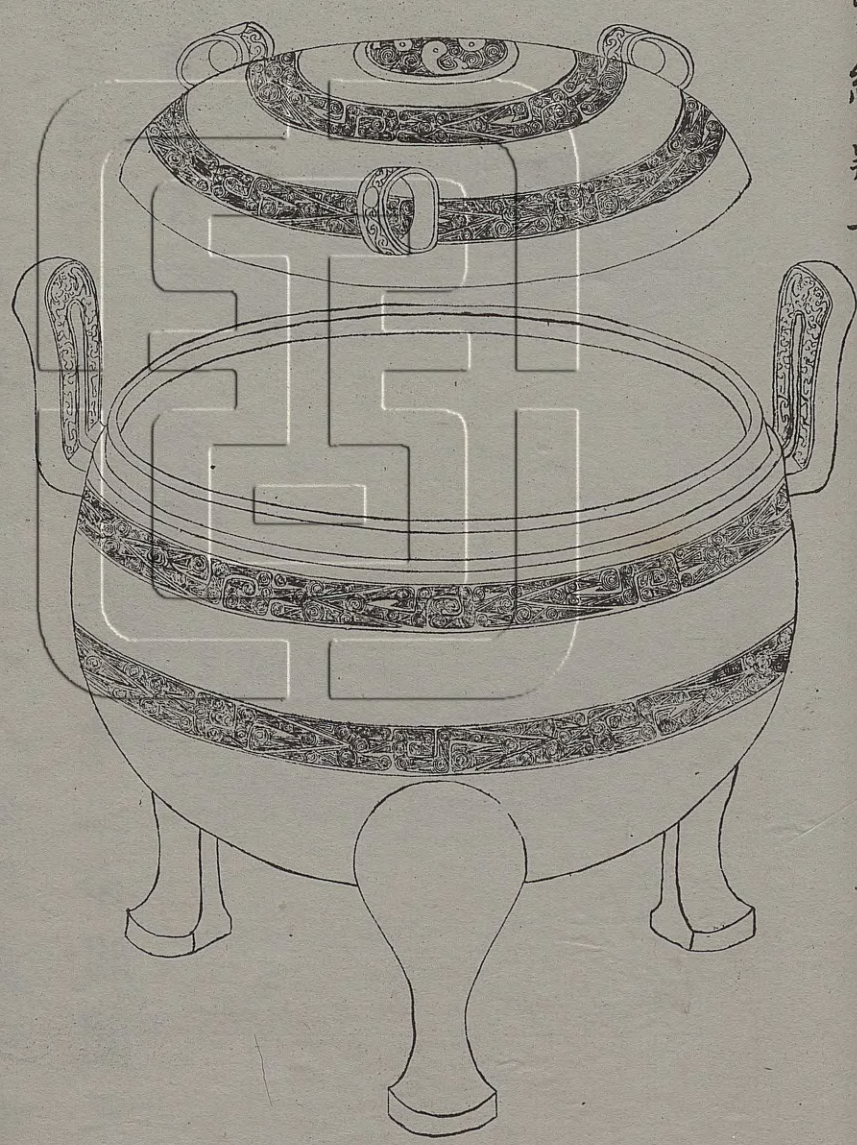

右通蓋高一尺五分深六寸八分耳高三寸五
 分濶二寸八分口徑一尺一寸二分腹圍三尺
 九寸重二百九十一兩



漢夔紋鼎二



右通蓋高六寸六分深四寸五分耳高一寸九分濶一寸六分口徑六寸五分腹圍二尺一寸六分重七十一兩

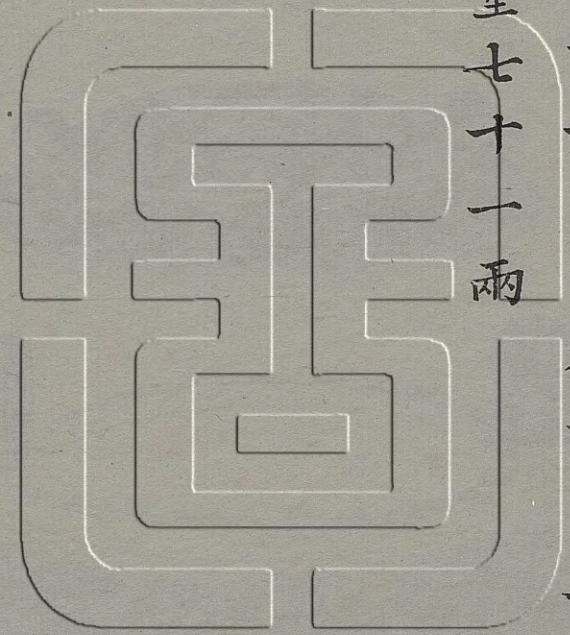

漢夔紋鼎三

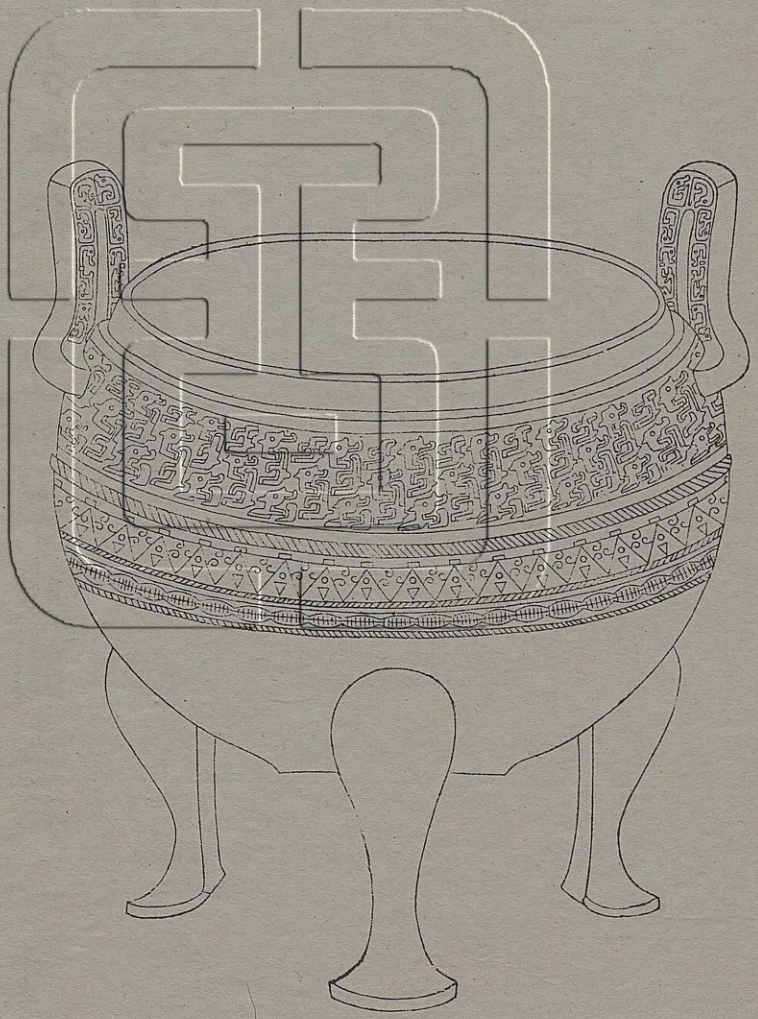

右高八寸二分深六寸二分耳高二寸八分濶
 二寸一分口徑八寸四分腹圍三尺一寸二分
 重二百三十五兩缺蓋



漢弦紋鼎一

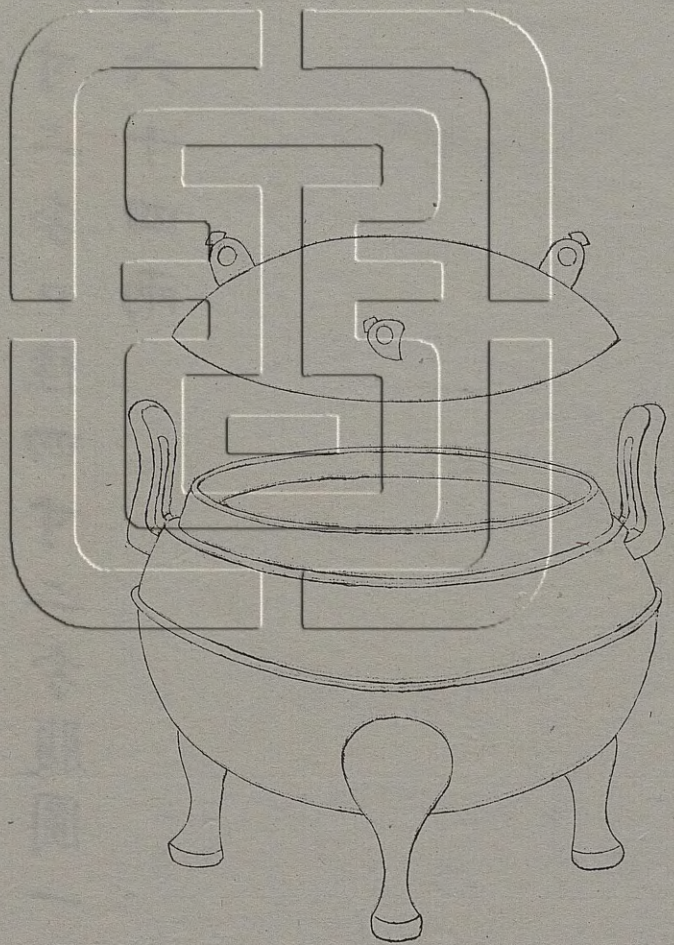

右通蓋高四寸九分深三寸一分耳高一寸八分濶一寸二分口徑四寸二分腹圍一尺七寸五分重六十四兩



漢弦紋鼎二



右通蓋高七寸九分深四寸耳高二寸濶一寸
 四分口徑五寸八分腹圍二尺一寸九分重九
 十五兩

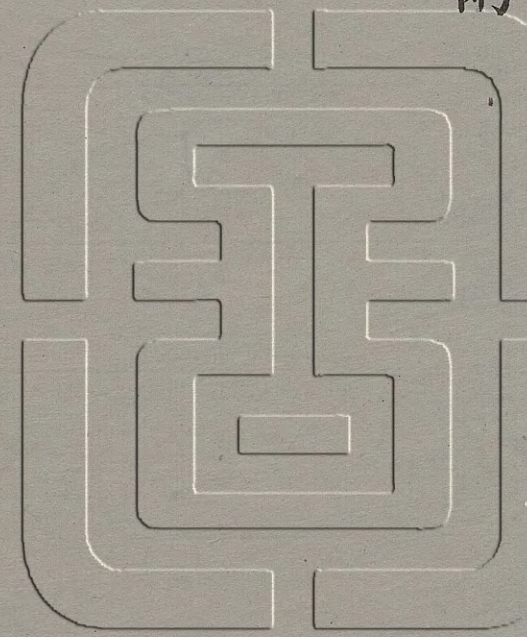

漢弦紋鼎三

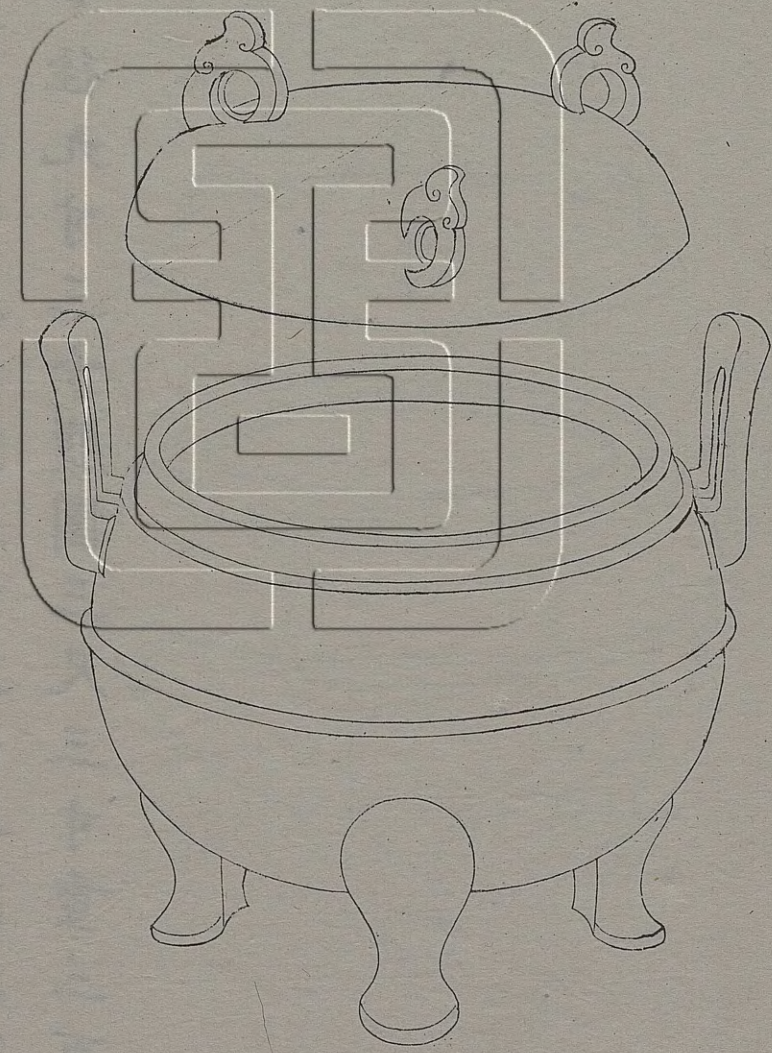

西清古鑑

卷十 鼎

三

右通蓋高八寸三分深五寸五分耳高三寸濶
 二寸口徑九寸三分腹圍三尺三寸重三百三
 十兩

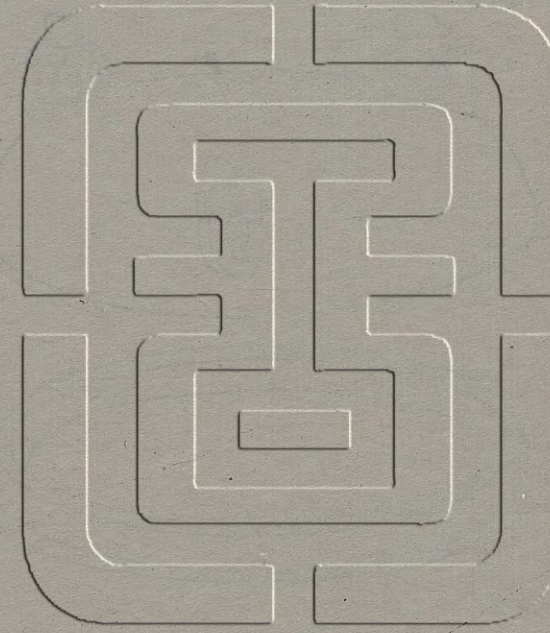

漢弦紋鼎四



右通蓋高五寸二分深三寸三分耳高二寸濶
 一寸四分口徑四寸六分腹圍二尺六分重九
 十七兩

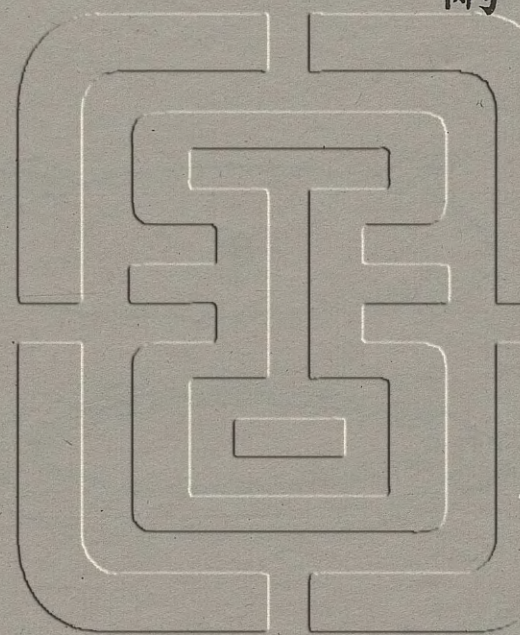

漢弦紋鼎五

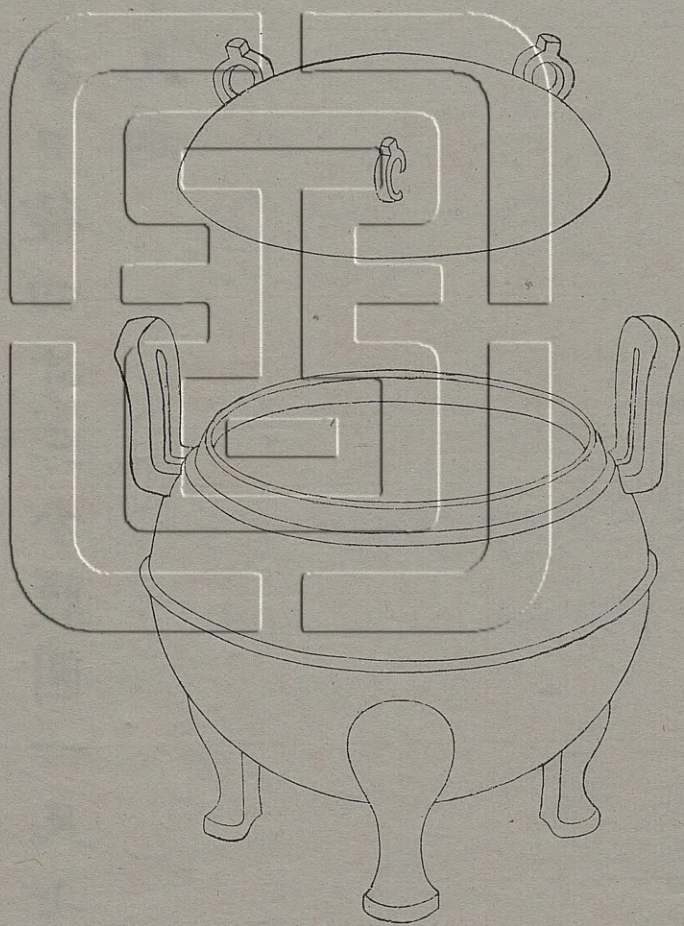

右通蓋高五寸深三寸二分耳高一寸七分濶
 一寸一分口徑四寸三分腹圍一尺七寸二分
 重五十九兩

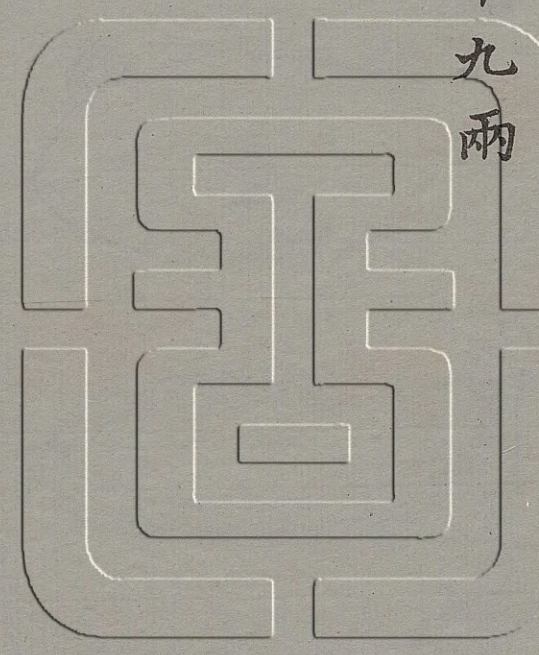

漢弦紋鼎六

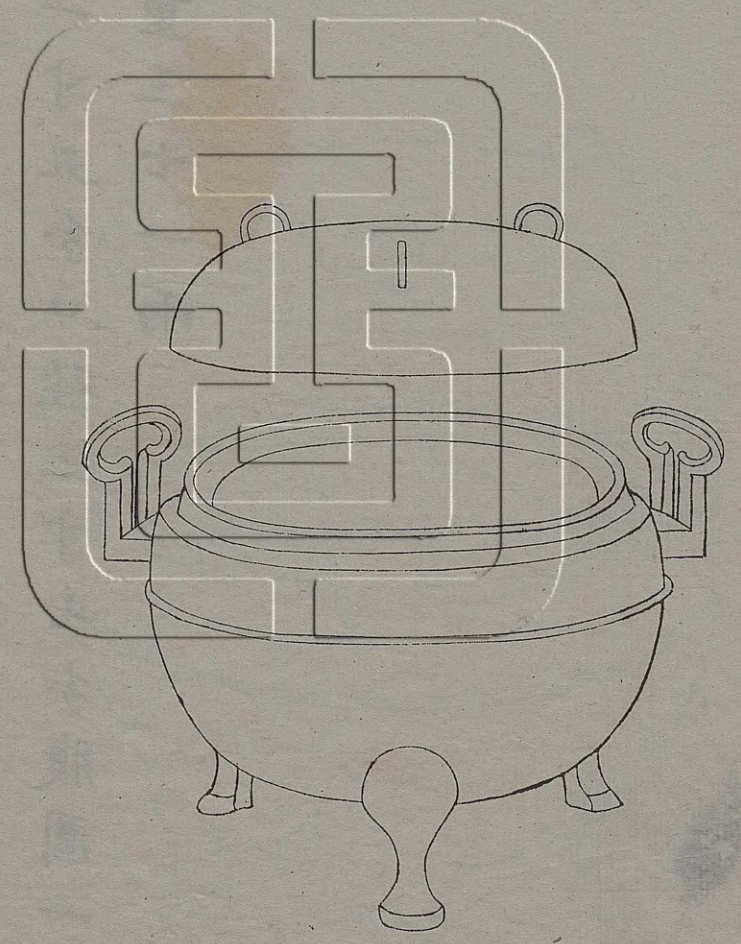

西清古金

卷十 鼎

十一

右通蓋高三寸九分深二寸五分耳高一寸四分
 分濶一寸五分口徑三寸七分腹圍一尺三寸
 五分重三十一兩

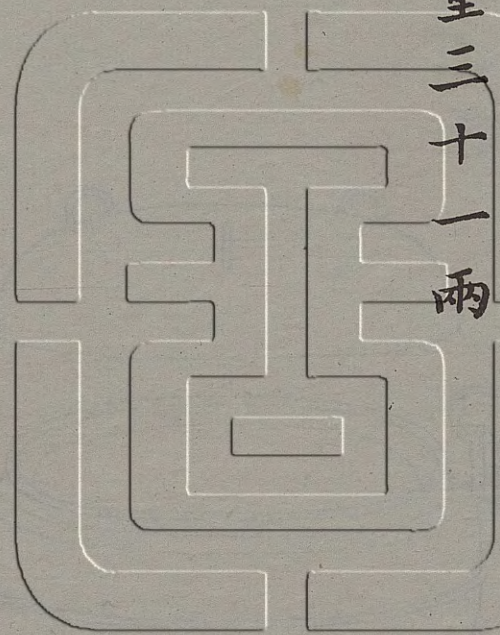

漢弦紋鼎七

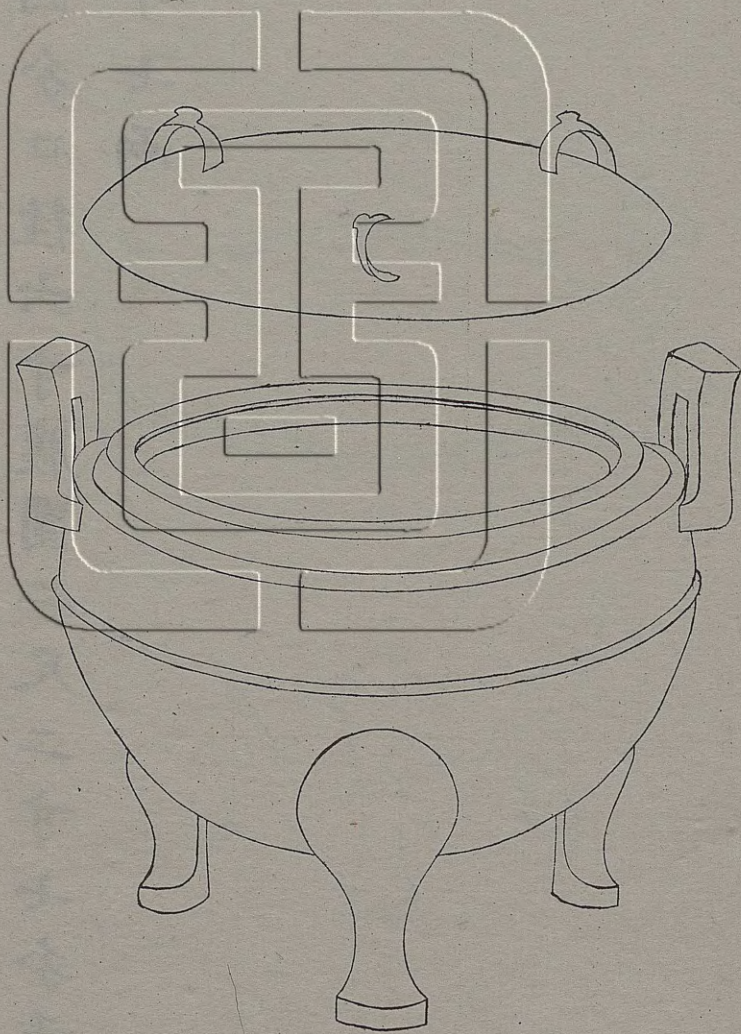

右通蓋高六寸二分深四寸二分耳高二寸濶
 一寸四分口徑六寸腹圍二尺二寸七分重一
 百四十七兩



漢素鼎一

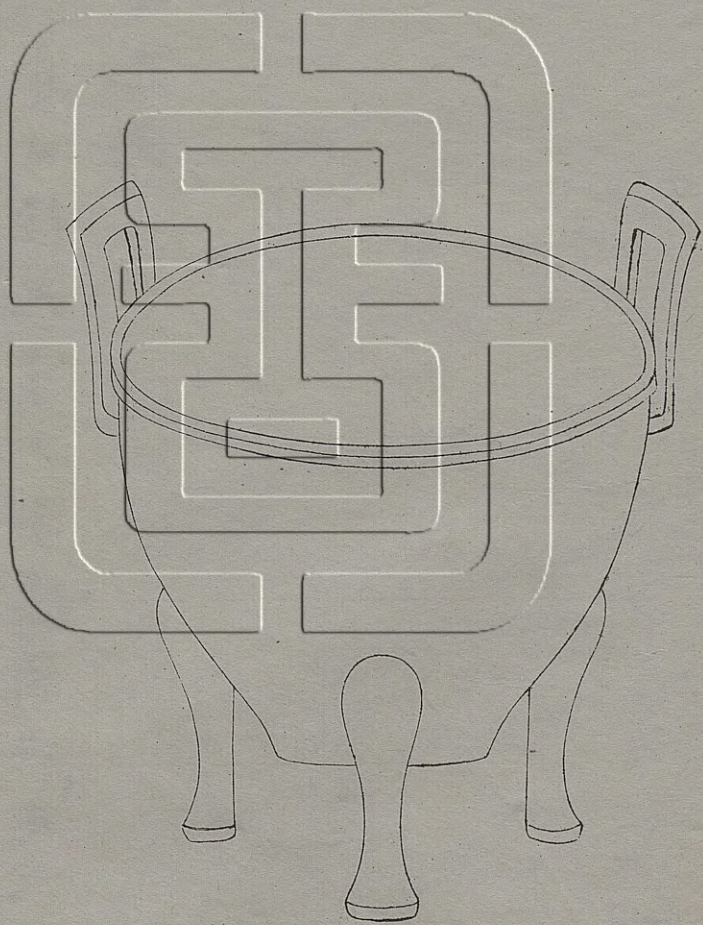

右高七寸五分深五寸六分耳高二寸五分潤
 一寸六分口徑九寸二分腹圍二尺八寸五分
 重八十九兩



漢文紋鼎九

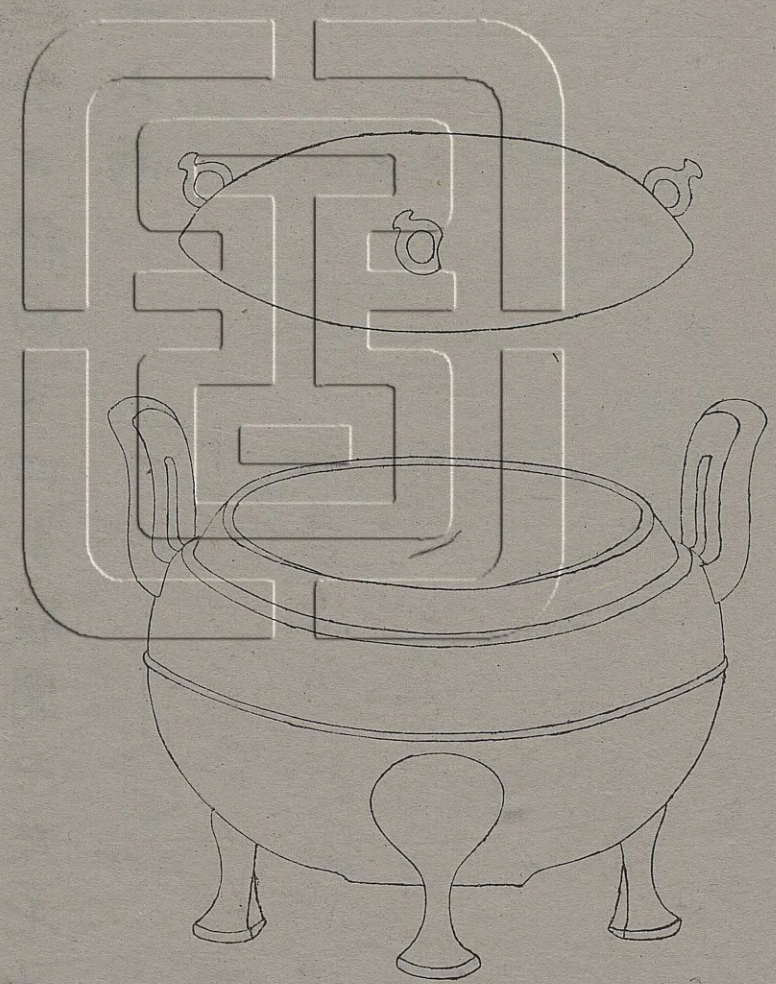

西清古金
 卷七
 鼎

右通蓋高五寸深二寸九分耳高一寸四分濶一寸一分口徑四寸四分腹圍一尺七寸一分重二十六兩

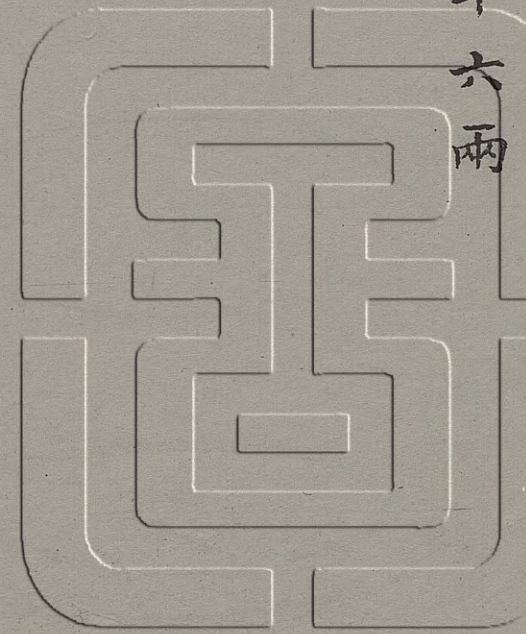

漢弦紋鼎十

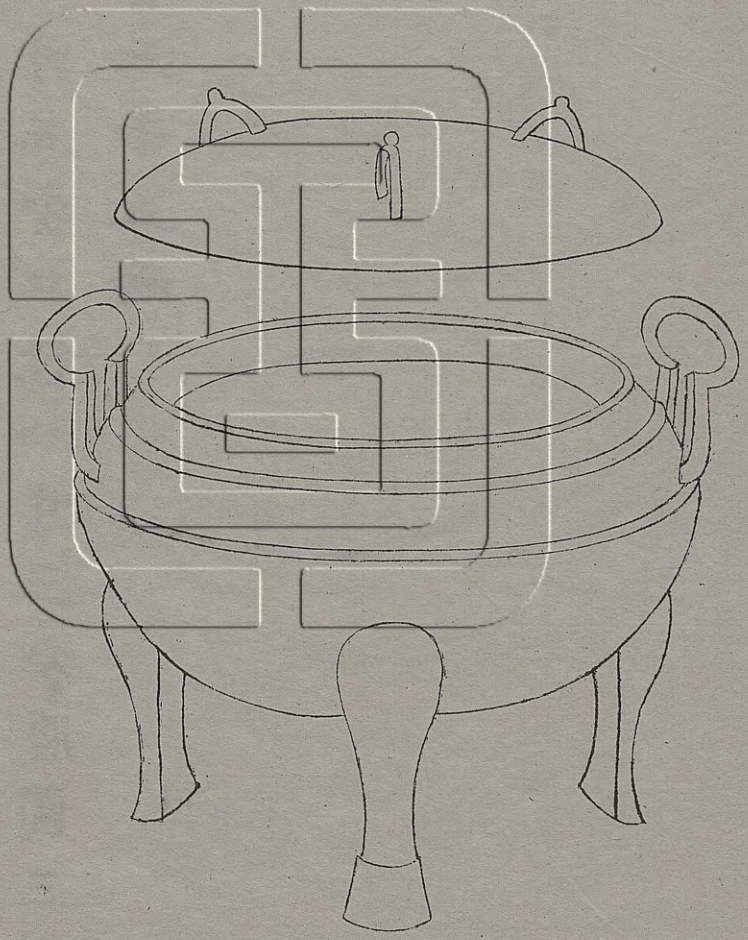

右通蓋高八寸八分深五寸一分耳高三寸四分濶二寸五分口径八寸三分腹圍三尺四分重二百三十五兩

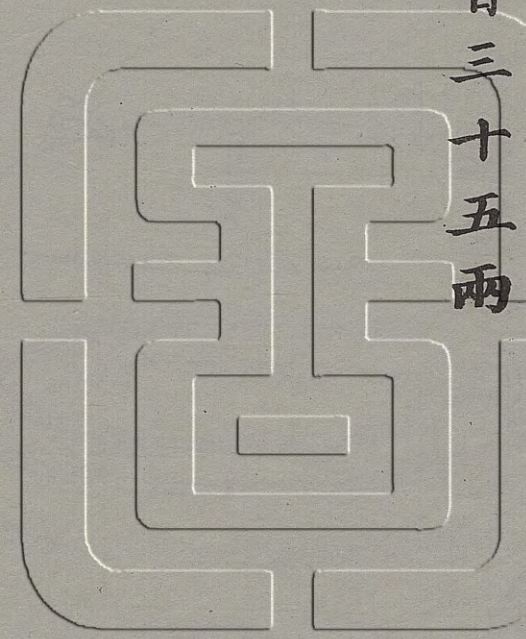

漢弦紋鼎十一

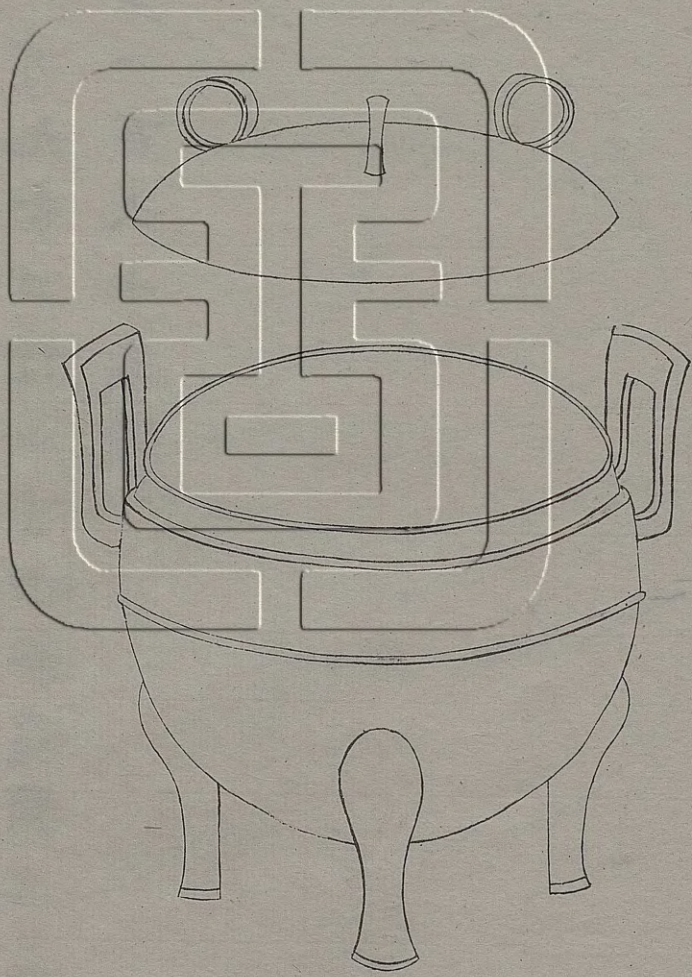

右通蓋高七寸八分深五寸二分耳高二寸九分濶一寸九分口徑七寸四分腹圍二尺六寸三分重一百六十三兩

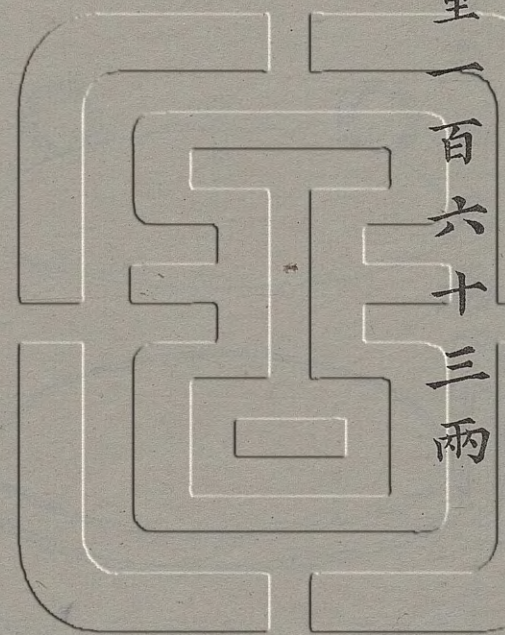

漢弦紋鼎十二

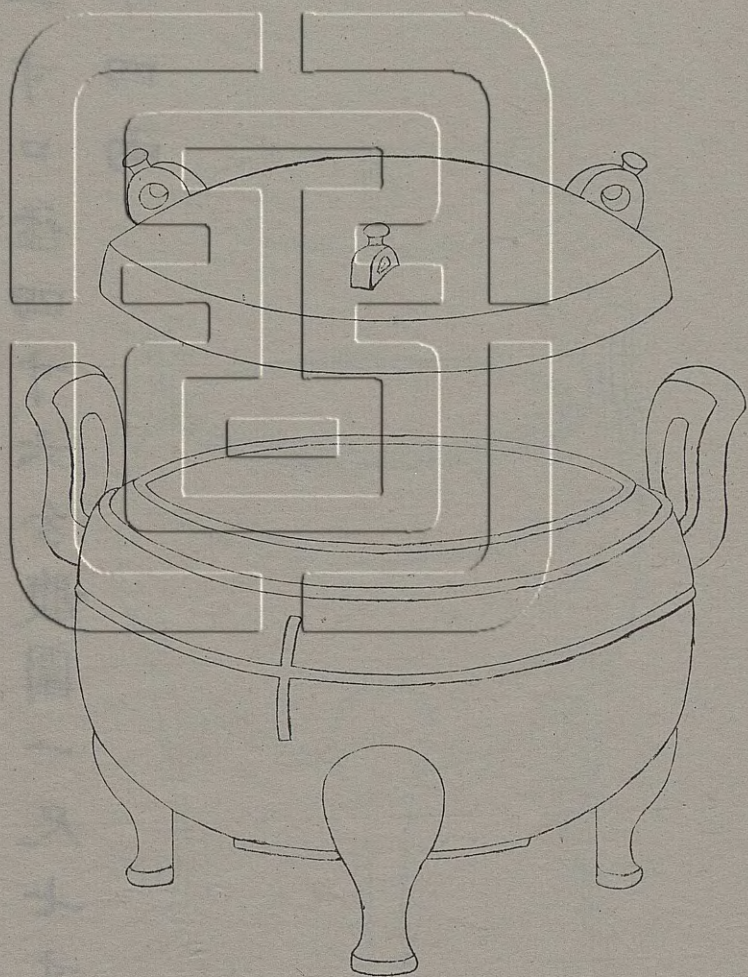

右通蓋高四寸五分深二寸九分耳高一寸六分濶一寸口徑四寸六分腹圍一尺七寸五分重六十四兩

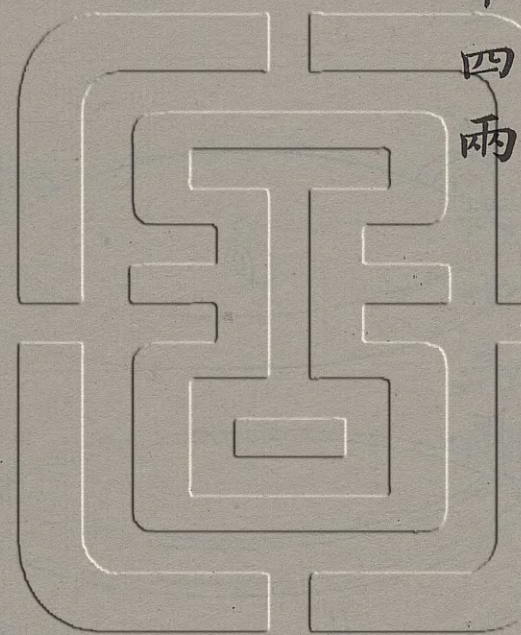

漢弦紋鼎十三

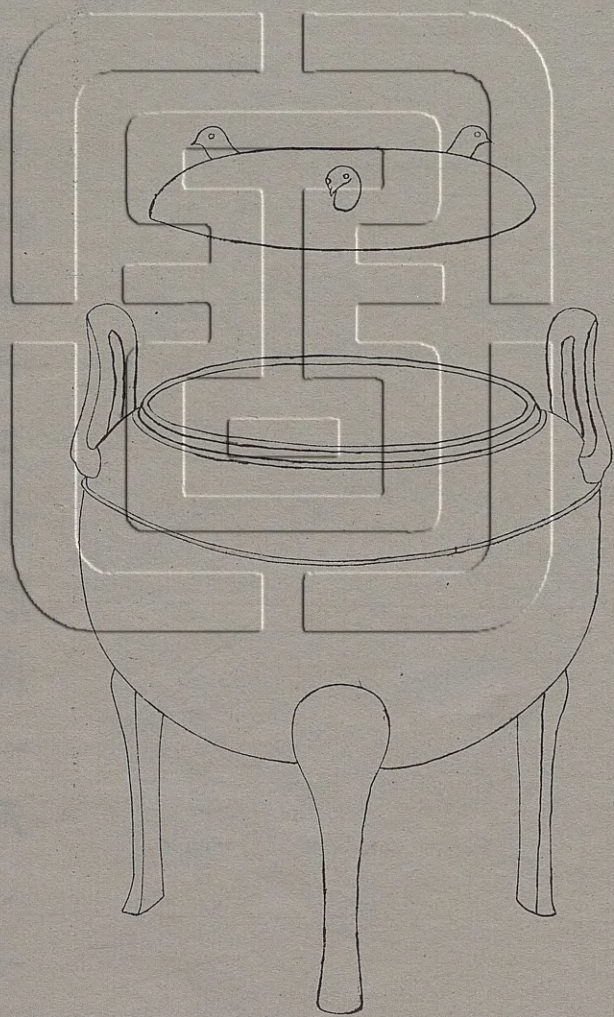

右通蓋高六寸一分深三寸四分耳高一寸七分濶一寸口徑四寸三分腹圍一尺八寸重八十五兩

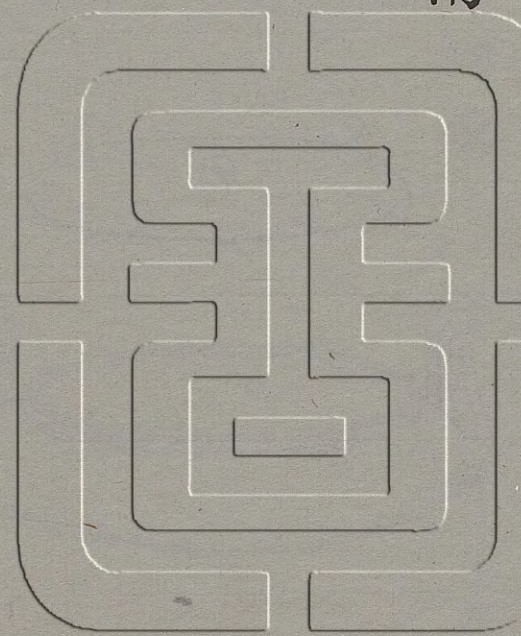

漢弦紋鼎十四

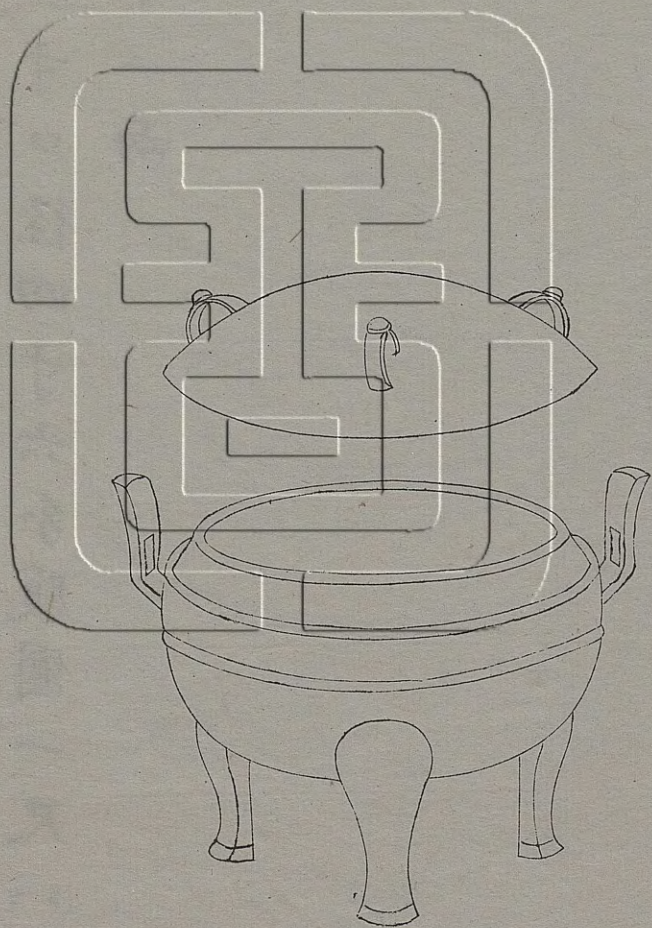

右通蓋高四寸九分深三寸一分耳高一寸八分濶一寸口徑四寸六分腹圍一尺八寸四分重七十一兩

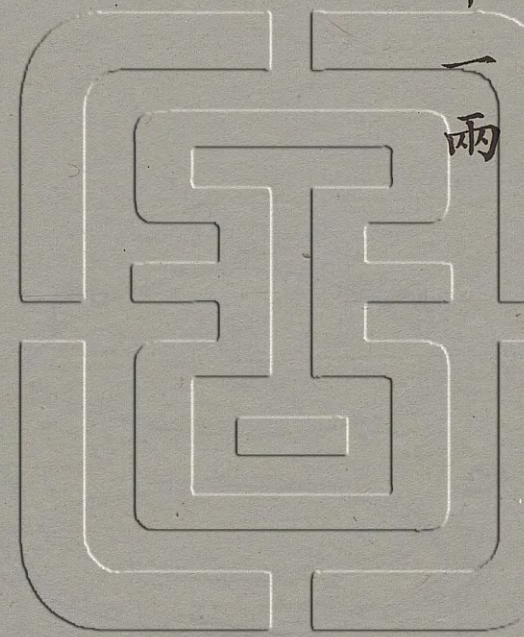

漢弦紋鼎十五

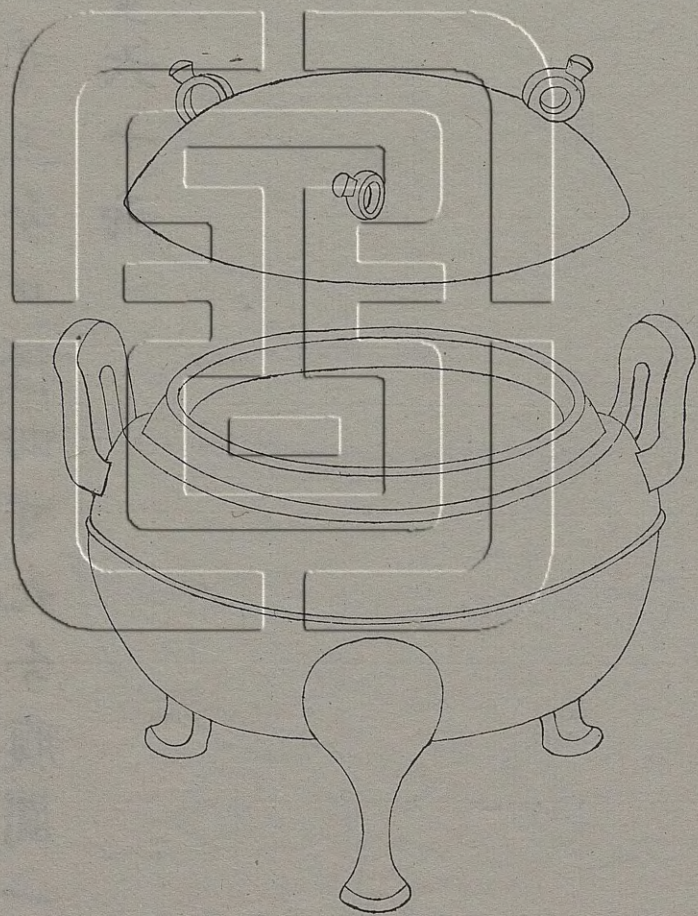

右通蓋高五寸四分深三寸一分耳高一寸六分潤一寸三分口徑四寸九分腹圍一尺八寸五分重六十兩

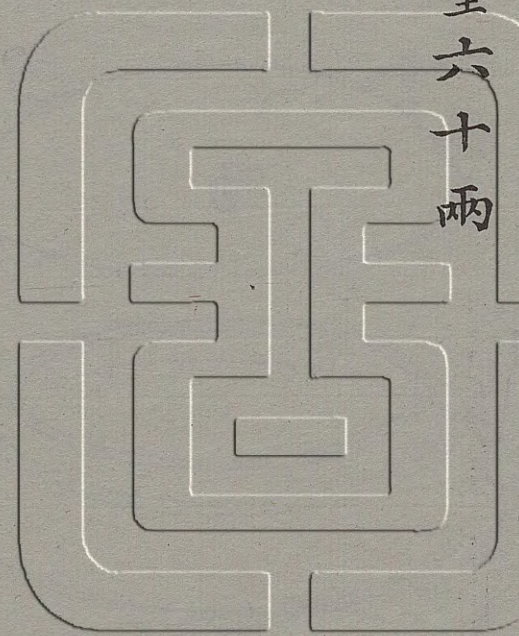

漢弦紋鼎十六

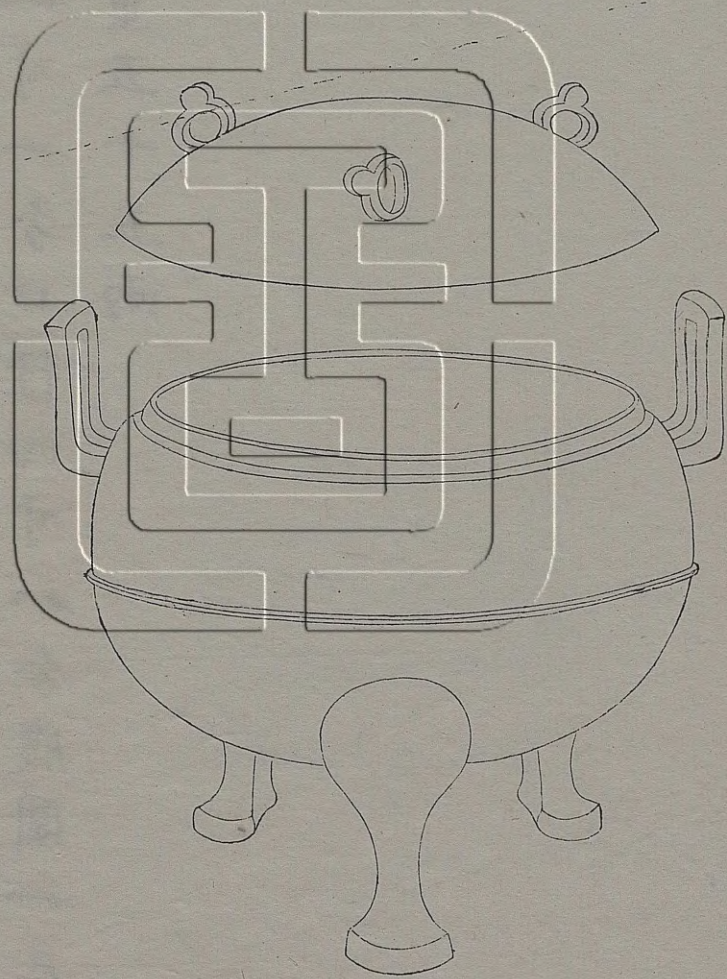

右通蓋高五寸一分深三寸四分耳高一寸五分
潤一寸一分口徑四寸八分腹圍一尺八寸
五分重五十五兩

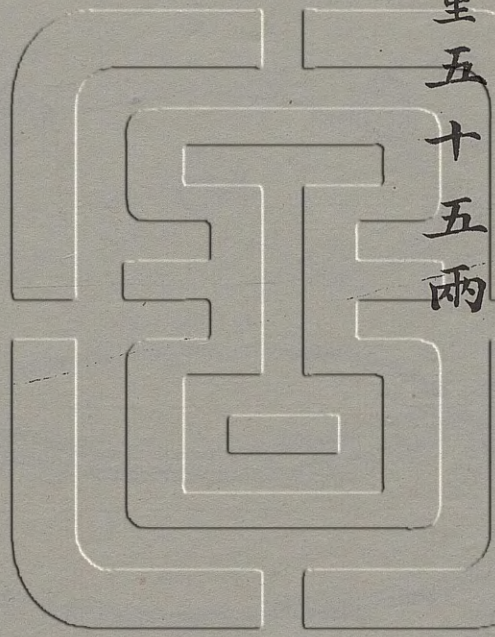

漢帶紋小鼎

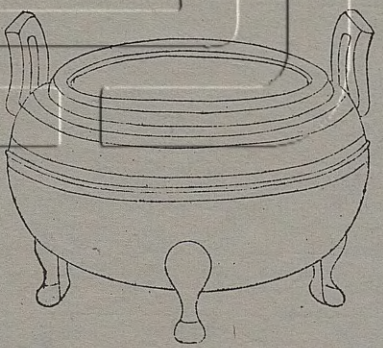
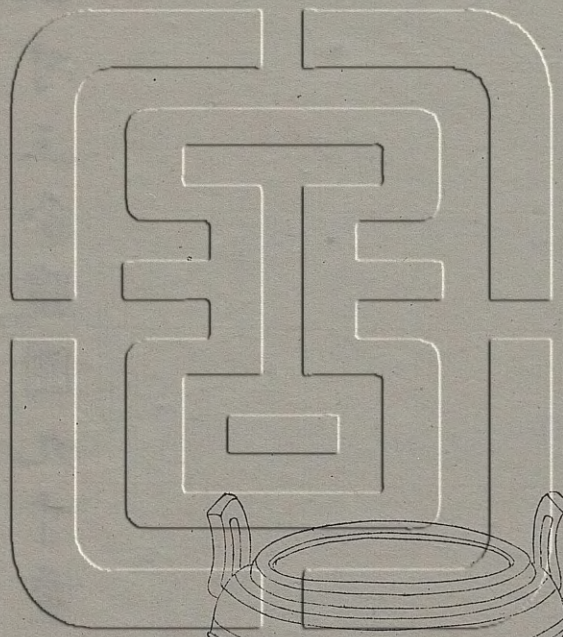

右高一寸八分深一寸五分耳高八分濶五分
口徑二寸三分腹圍九寸重九兩缺蓋

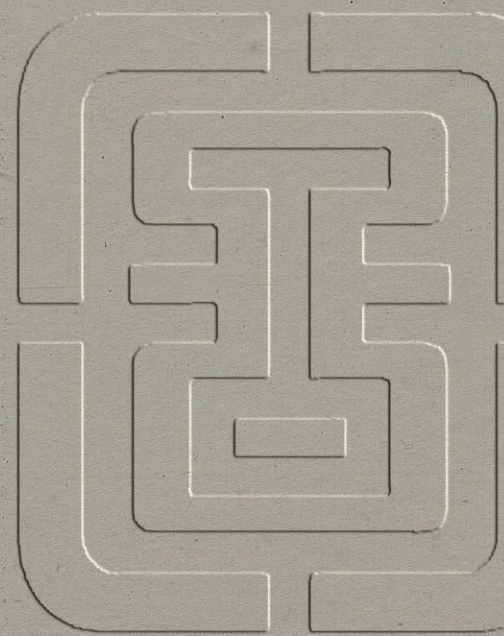

漢素鼎一

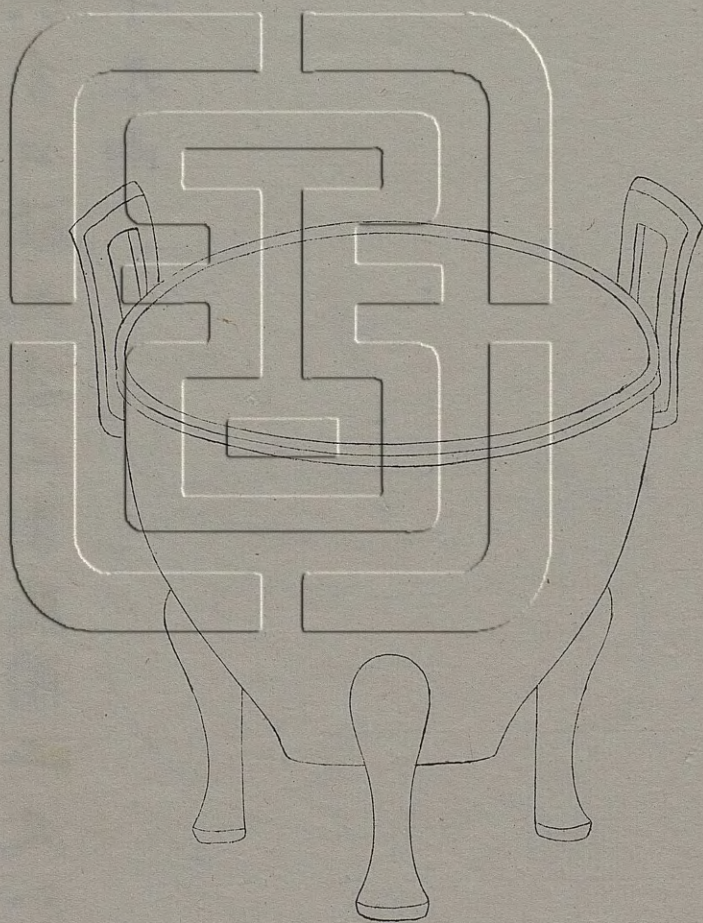

右高七寸五分深五寸六分耳高二寸五分潤
 一寸六分口徑九寸二分腹圍二尺八寸五分
 重八十九兩

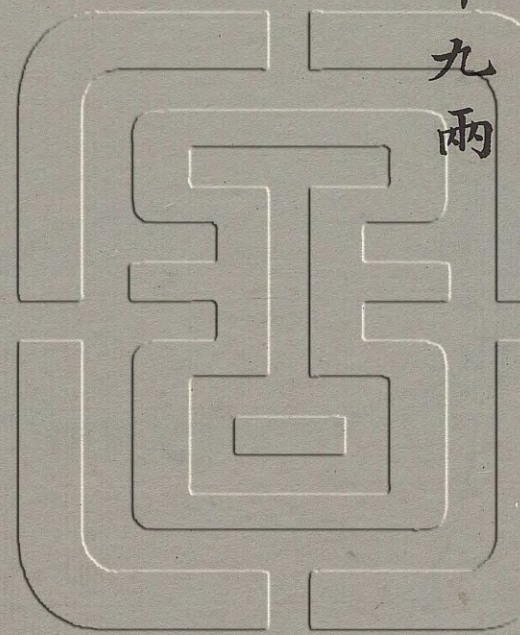

漢素鼎二

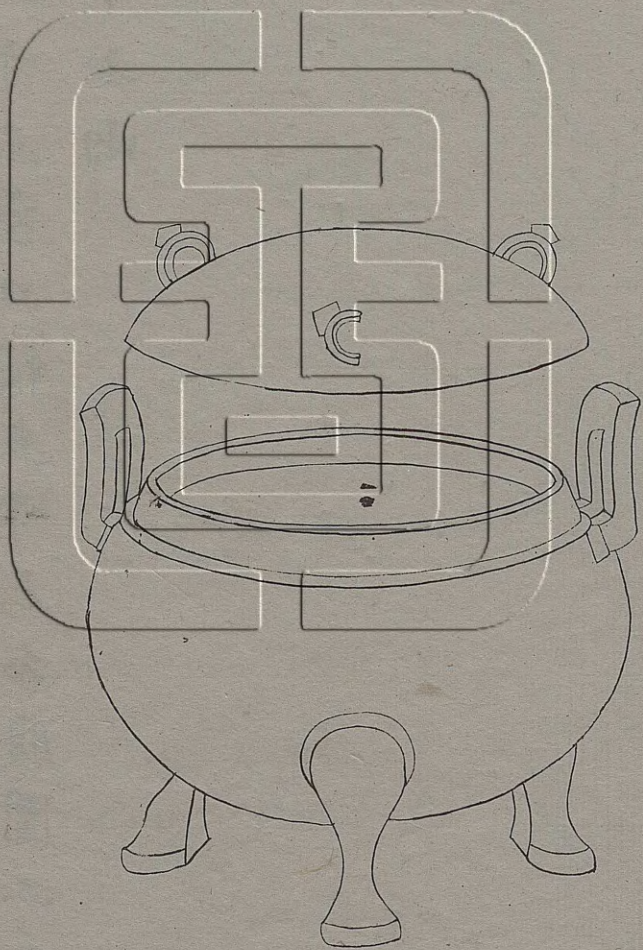

右通蓋高五寸九分深三寸四分耳高二寸二分潤一寸三分口徑五寸三分腹圍二尺一寸重八十七兩

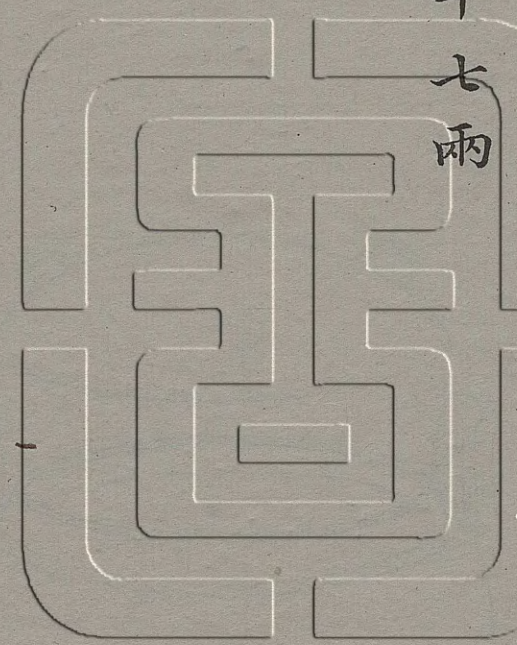

漢素鼎三

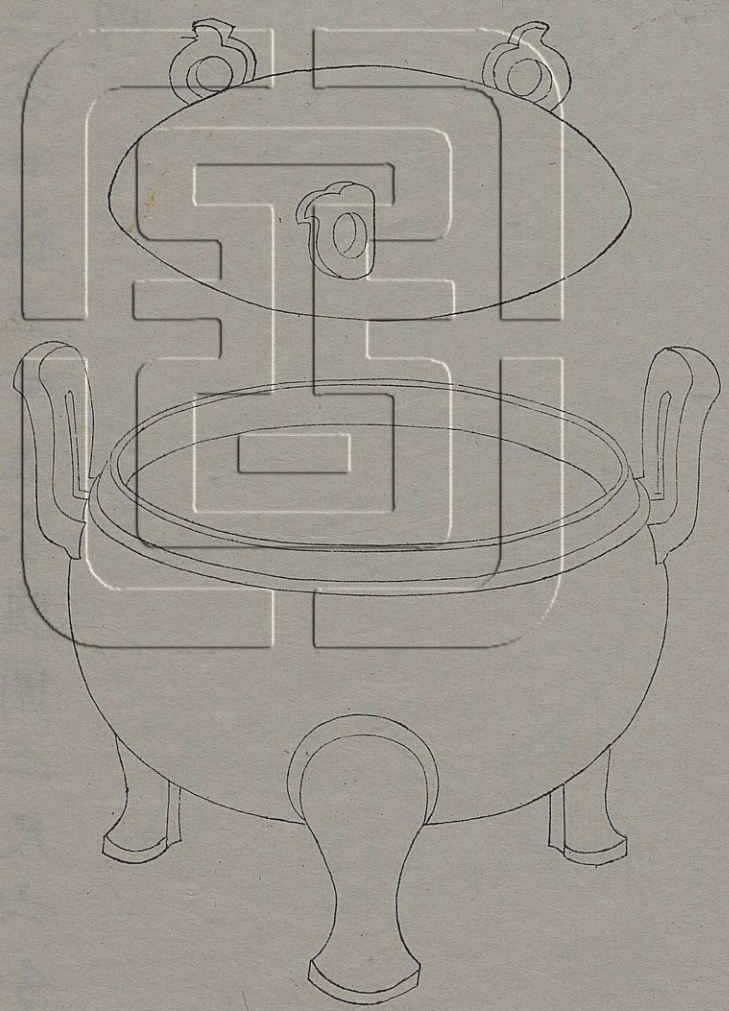

右通蓋高五寸三分深三寸三分耳高二寸濶
一寸三分口徑五寸五分腹圍二尺六分重八
十九兩

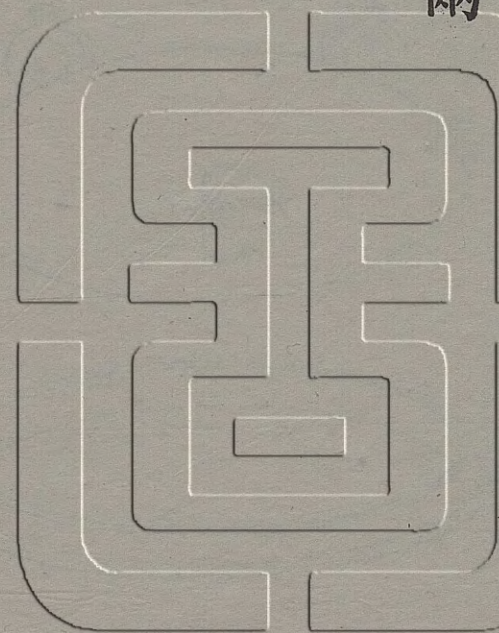

漢素鼎四

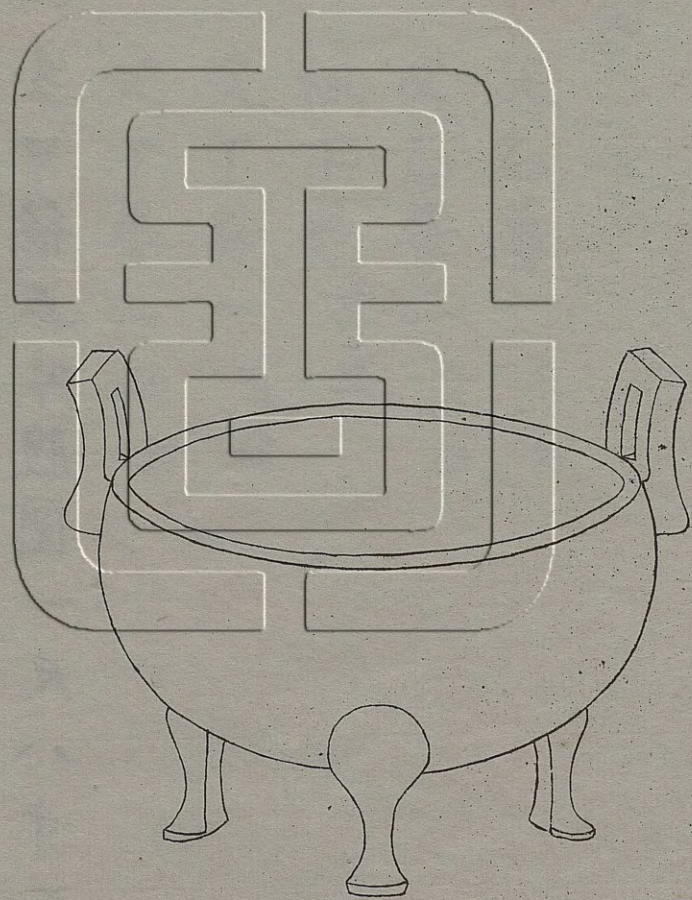

右高三寸六分深二寸六分耳高一寸八分濶
 一寸一分口徑五寸腹圍一尺八寸二分重五
 十兩

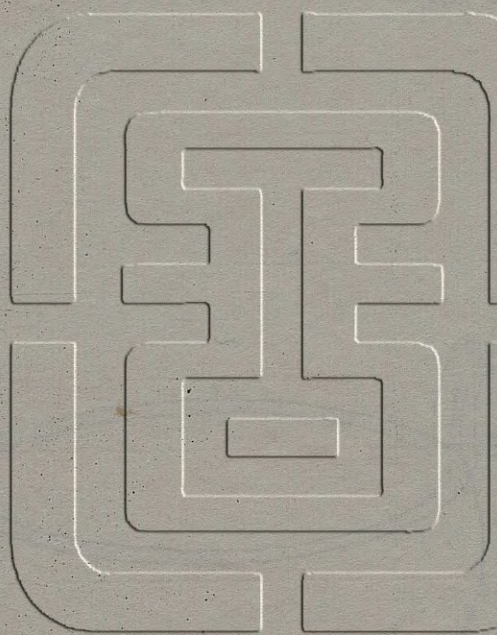

西清古鑑卷八目錄

尊一

商

父乙尊一 有銘

父乙尊二 有銘

祖丁尊 有銘

父丁尊一 有銘

父丁尊二 有銘

父丁尊三 有銘

父丁尊四 有銘

已尊 有銘

父已尊 有銘

母已尊 有銘

父辛尊 有銘

父癸尊 有銘

冊尊 有銘

立戈尊 有銘

饗饗尊

帶耳尊

父乙尊蓋 有銘

周

乙公尊一 有銘

乙公尊二 有銘

萬壽尊 有銘

父已尊 有銘

癸公尊 有銘

貫尊 有銘

伯和尊一 有銘

伯和尊二 有銘

伯和尊三 有銘

伯矩尊 有銘

伯尊 有銘

邢侯尊 有銘

諸姬尊 有銘

孔尊 有銘

商尊 有銘

效尊 有銘

季受尊 有銘

車尊 有銘

鬲尊一 有銘

鬲尊二 有銘

內事尊 有銘

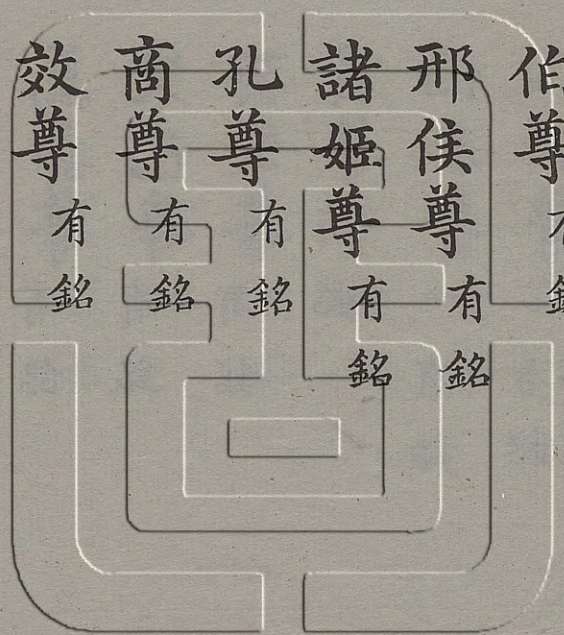
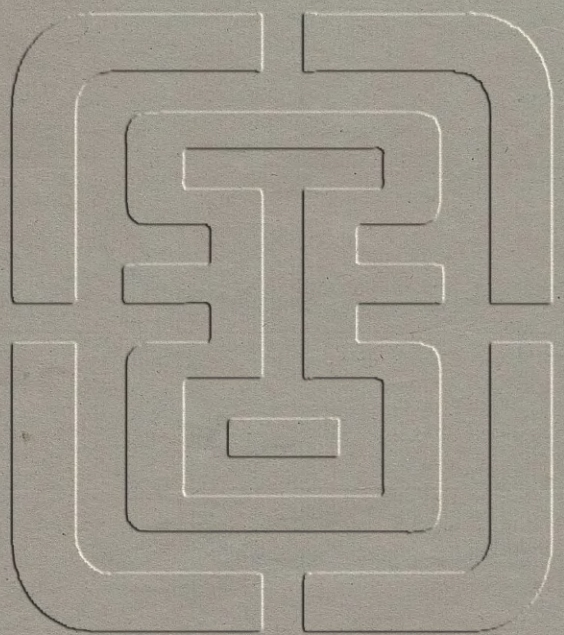

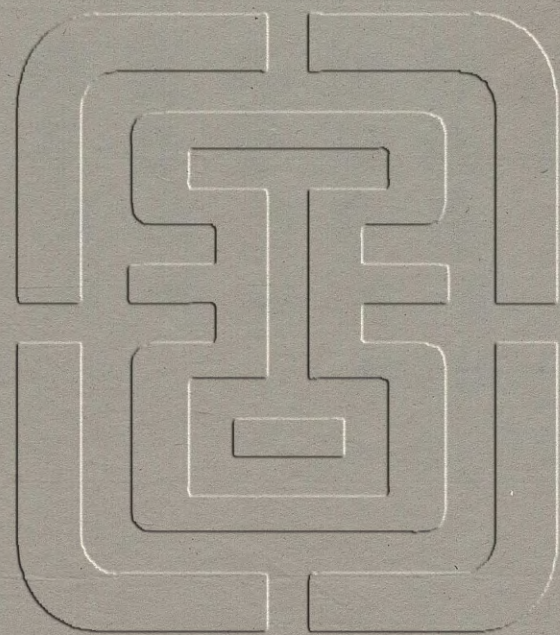

商父乙尊一

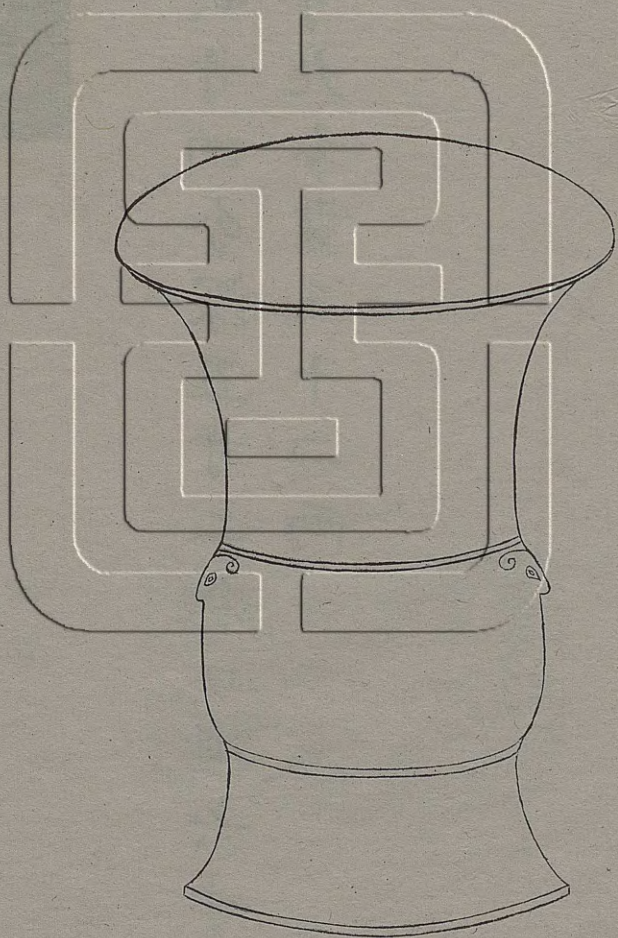

父乙

父乙

右高六寸四分深五寸二分口徑六寸腹圍一尺一寸九分重三十二兩

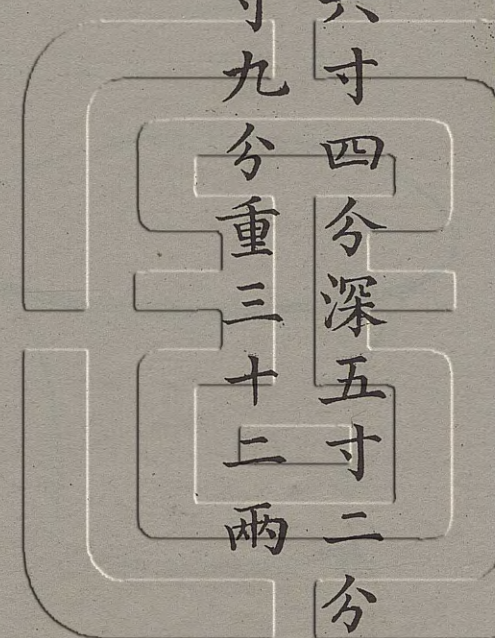

商父乙尊二

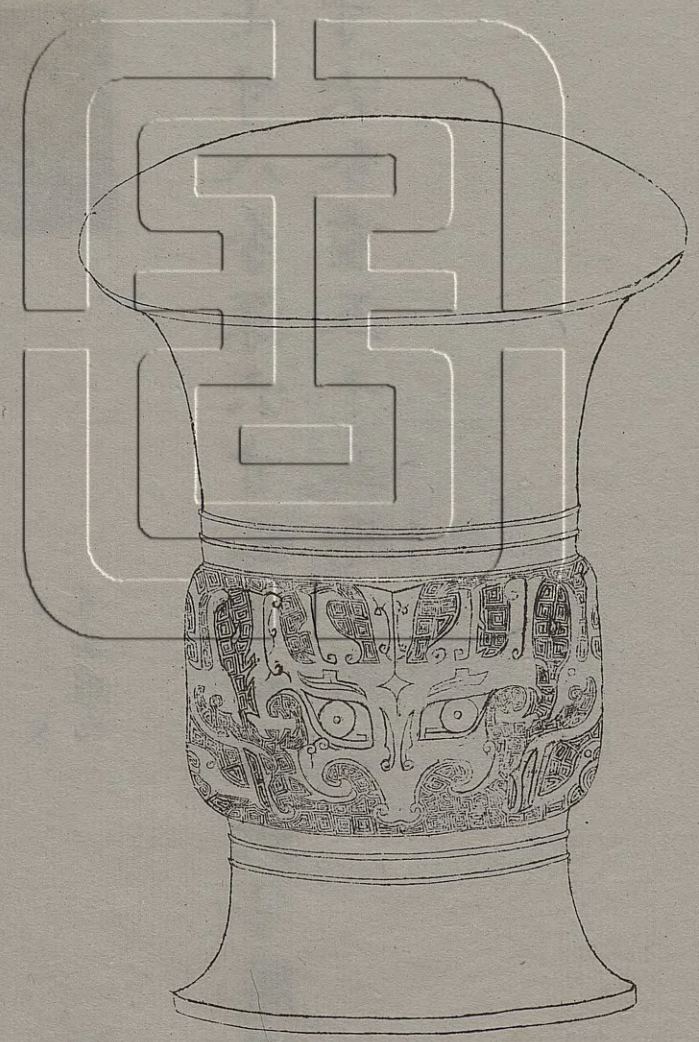

商清古鑑 卷八 尊

右高七寸八分深六寸三分口徑六寸腹圍一尺一寸六分重五十五兩

弓矢形乙父

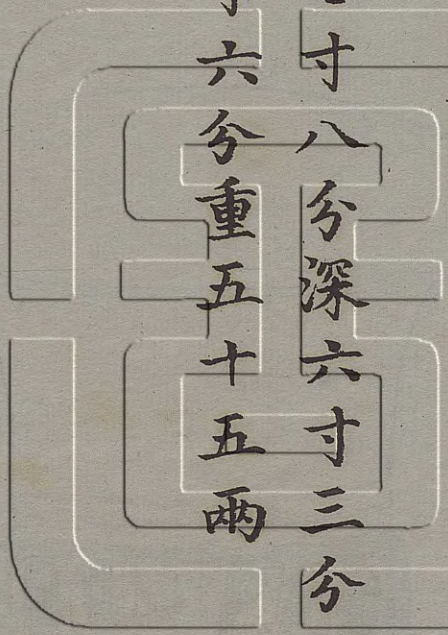

商祖丁尊

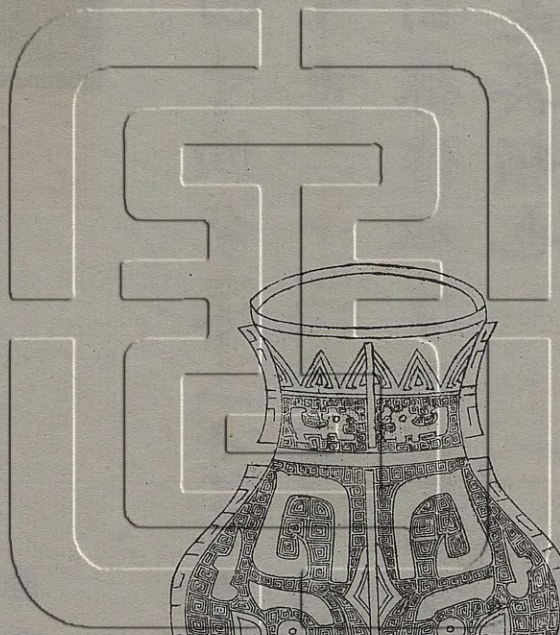
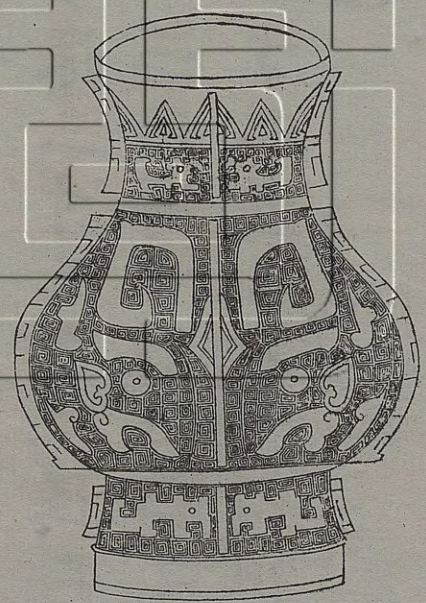



祖丁

右高四寸四分深三寸三分口徑二寸四分腹
 圍九寸重二十一兩博古圖有祖丁尊銘作立
 旗形曰孫作祖丁此僅二字亦曰祖丁腹俱作
 饗饗是其類也

商父丁尊一

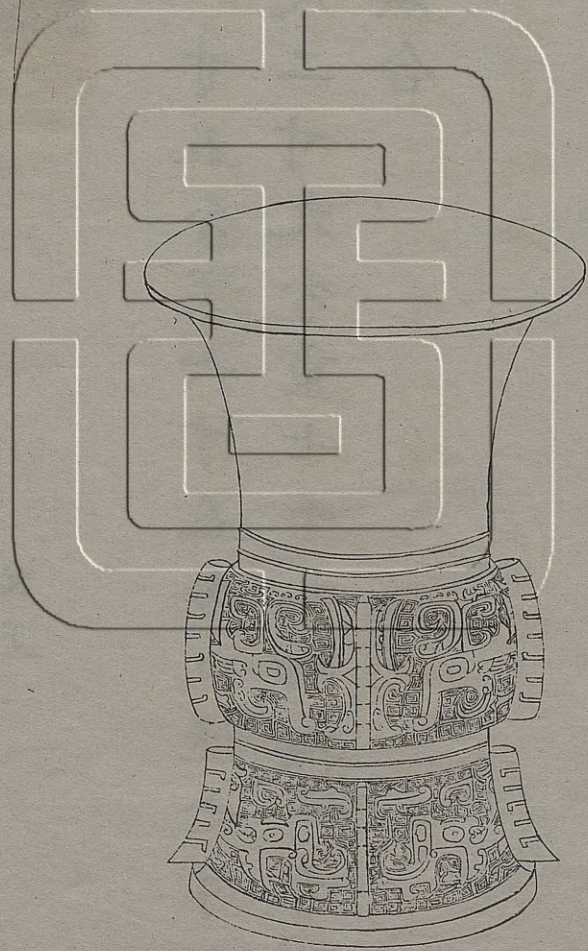

父丁

右高八寸五分深六寸五分口徑六寸四分腹
 圍一尺二寸九分重七十九兩與博古圖所載
 銘製俱合

父丁

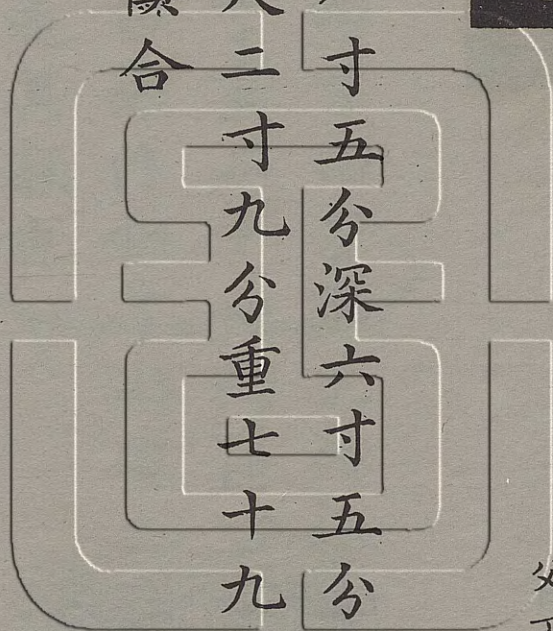

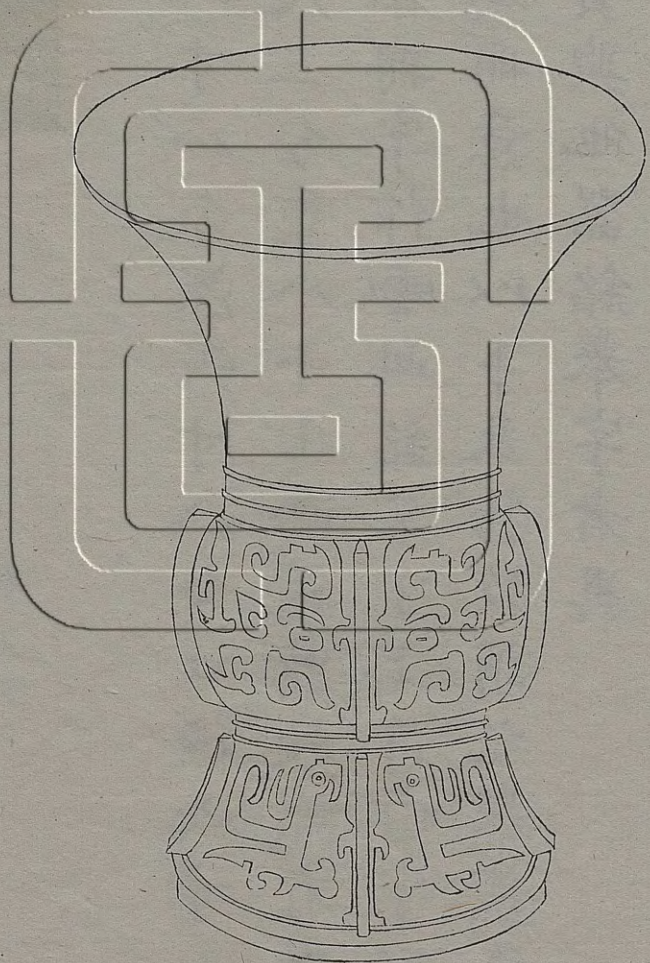

商父丁尊二



商父丁

舉父丁

右高八寸八分深六寸八分口徑六寸七分腹圍一尺三分重八十七兩鐘鼎款識有舉冊父癸卣舉冊字作此銘父丁上作字形相近或即舉冊意也以手奉物故謂之舉蓋象形商人尚質與他器銘舉字者異

商父丁尊三

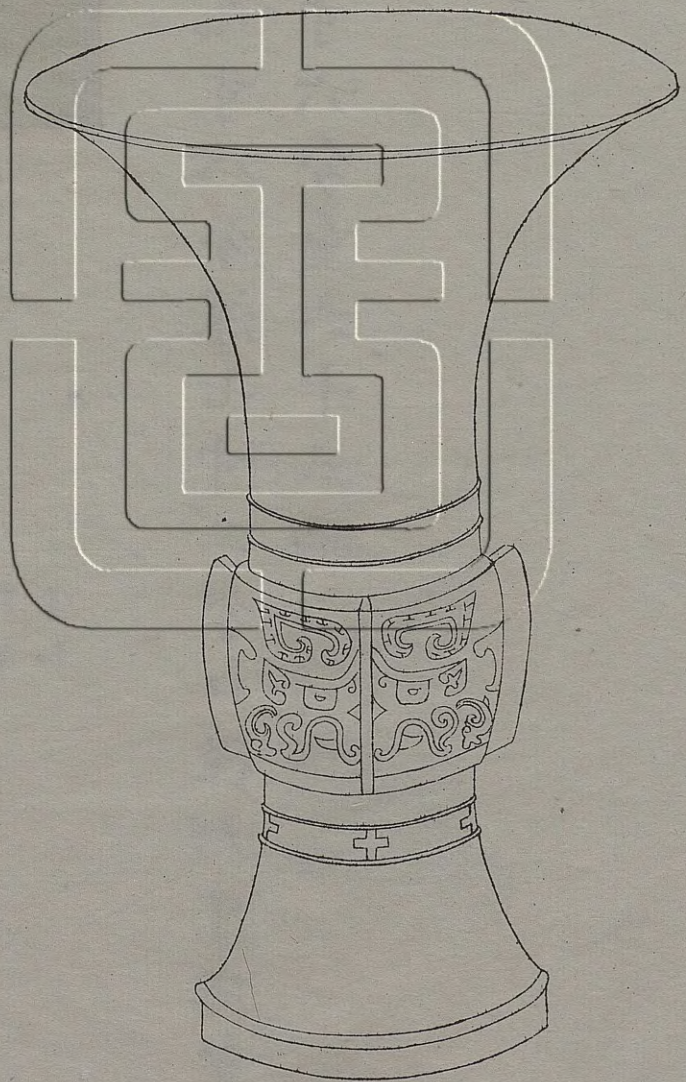

尊

六

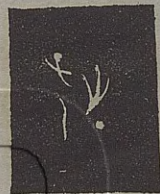

右高九寸八分深七寸二分口径六寸六分腹圍九寸六分重六十三兩

父丁
子乙

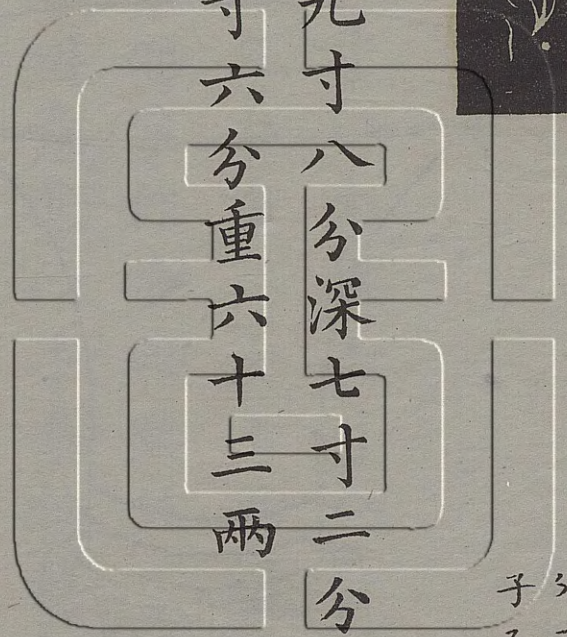

商父丁尊四

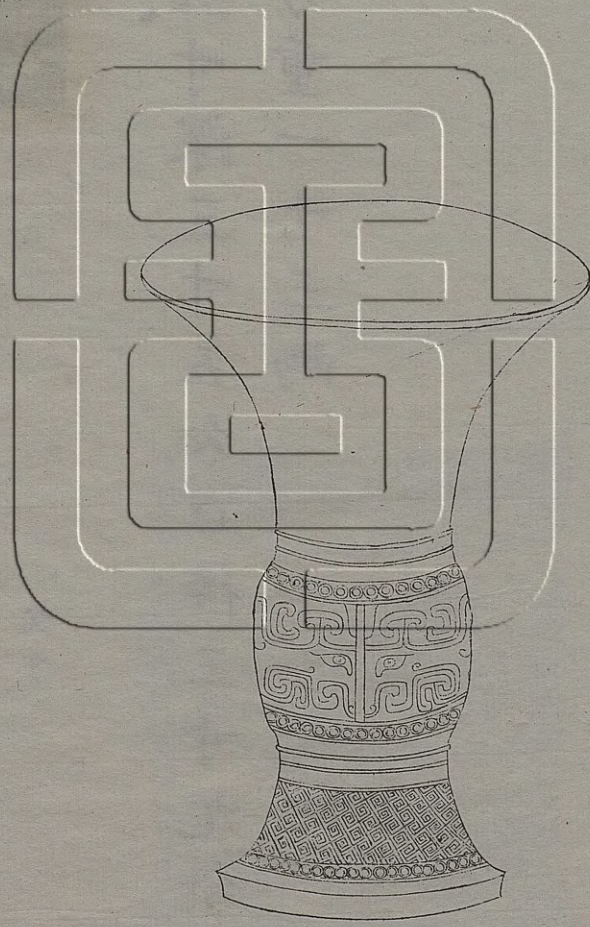

子
父

子
父

右高五寸深三寸五分口徑三寸九分腹圍五寸七分重一十三兩

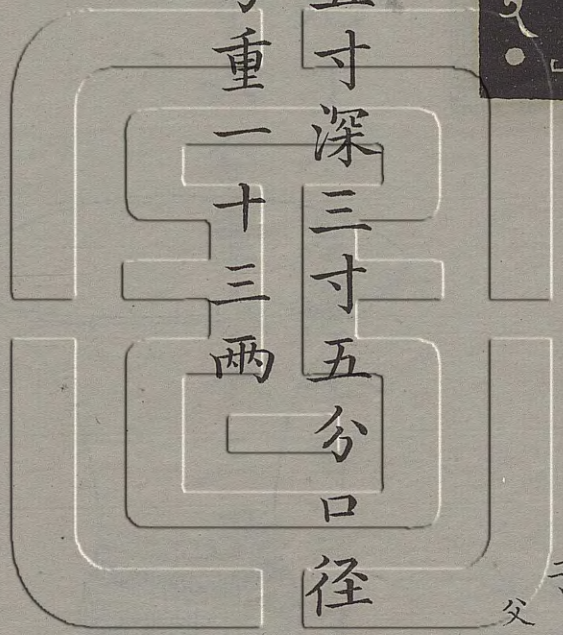

商已尊

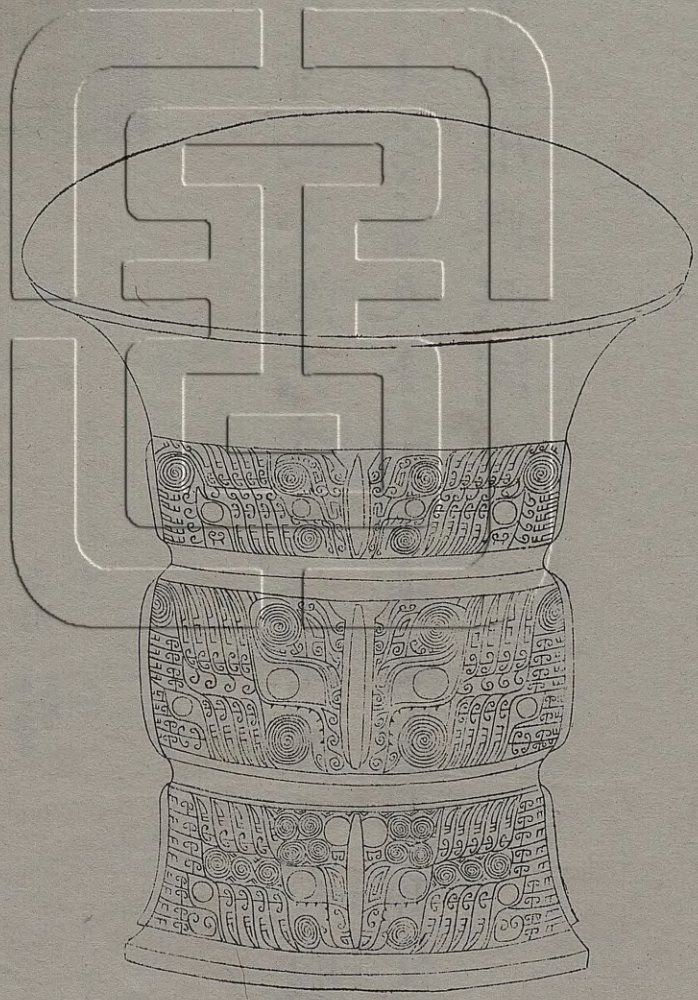

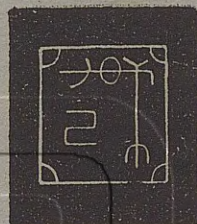

右高七寸四分深六寸口徑七寸三分腹圍一尺六寸七分重九十一兩博古圖載商父癸鼎作戈穿貝形與此同

中 亞形
已 立戈穿貝形

商父己尊

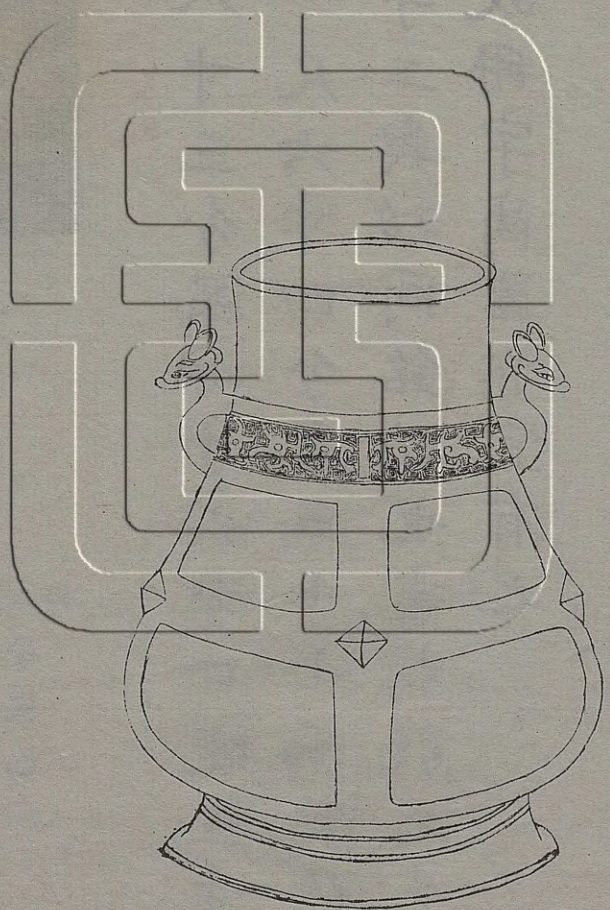

冊工冊

人父己

冊工冊
子父己

右高八寸三分深七寸六分口縱三寸橫四寸
腹圍一尺六寸四分重五十七兩銘作二冊中
為工字工與功同銘功也書稱殷之先人有典
有冊故冊字商器亦宜有之

商母己尊

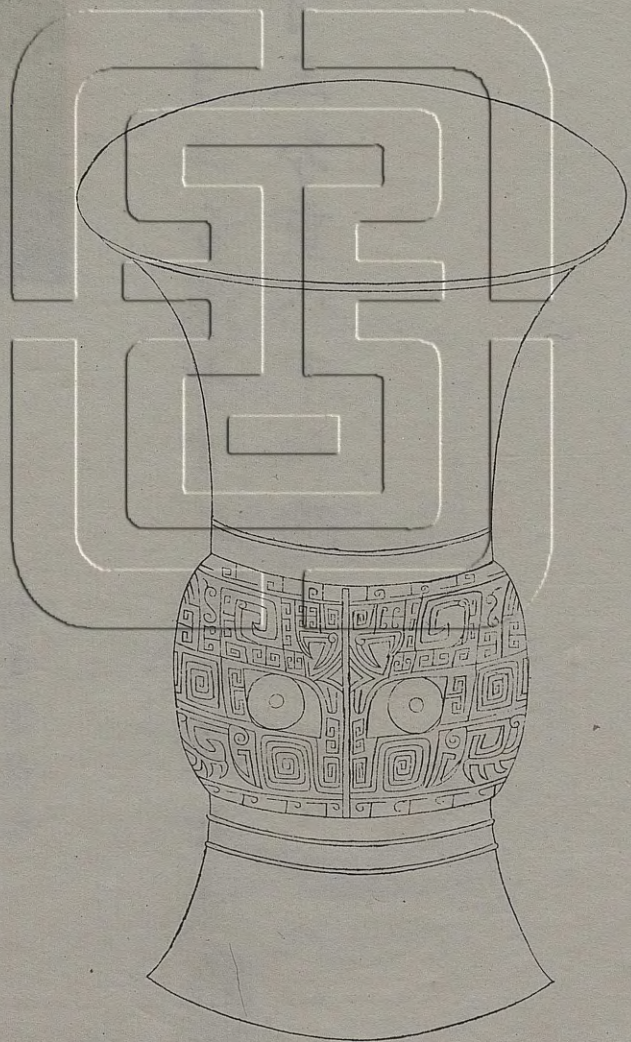

西清古鑑

卷八

七

非子孫母己

析子孫母己

右高九寸二分深七寸二分口径七寸腹圍一尺四寸三分重八十七兩

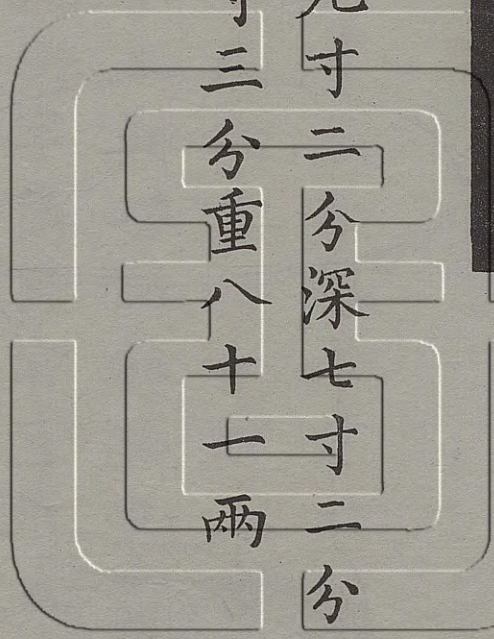

商父辛尊



商父辛尊

尊

冊冊
父辛

冊冊
父辛

右高七寸五分深六寸七分口縱三寸一分橫
四寸腹圍一尺五寸一分重五十九兩

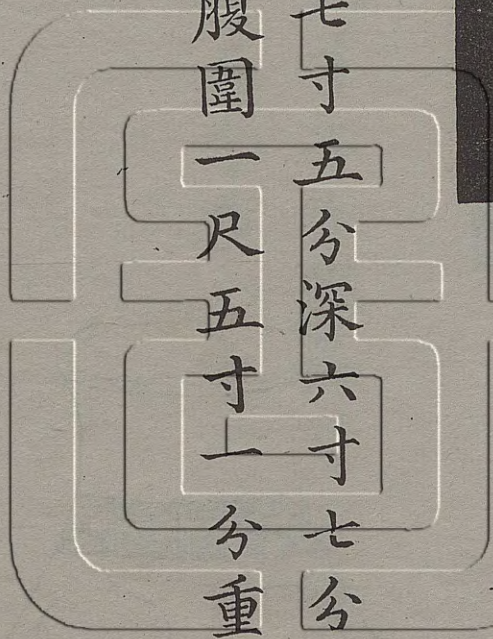

商父癸尊

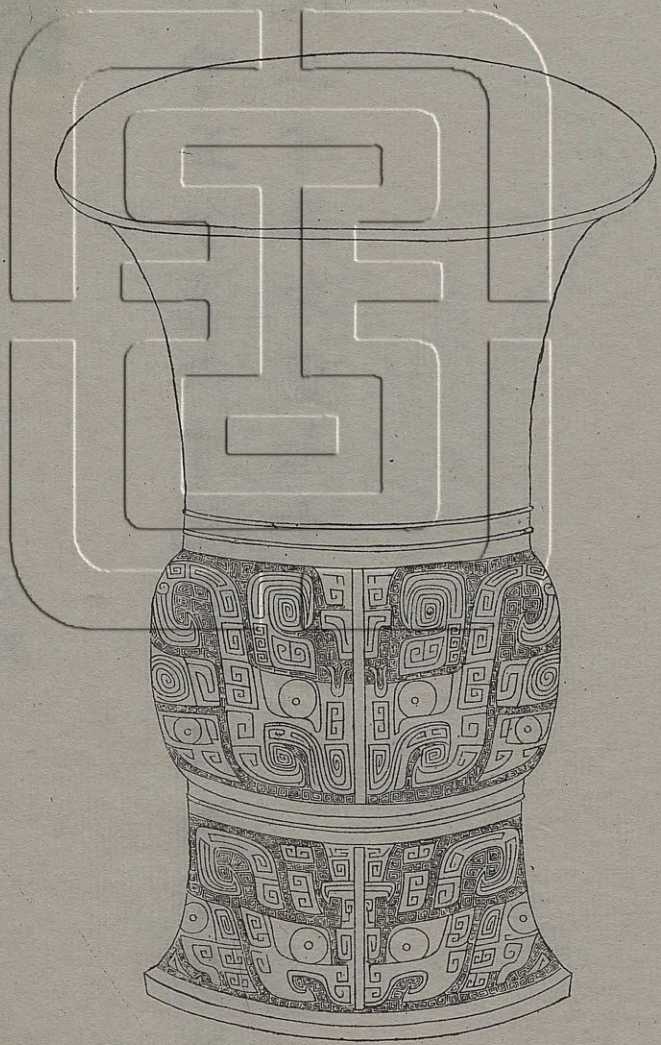

父癸

右高八寸五分深六寸九分口径六寸五分腹圍一尺二寸五分重七十一兩

父癸

商冊尊





右高一尺四寸六分深一尺六分口径九寸三分腹圍二尺四分重三百六十三兩

冊

商立戈尊





立戈形

右高六寸一分深五寸二分口徑如之腹圍一尺一寸六分重四十九兩

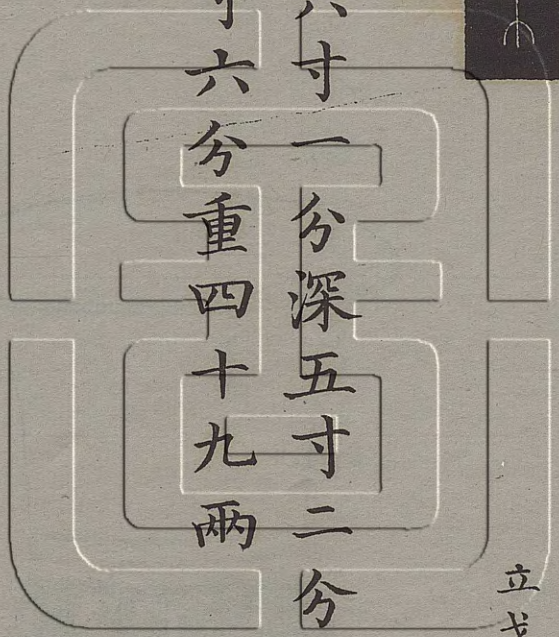

商饗饗尊



右高七寸六分深六寸三分口徑六寸二分腹圍一尺一寸九分重四十七兩

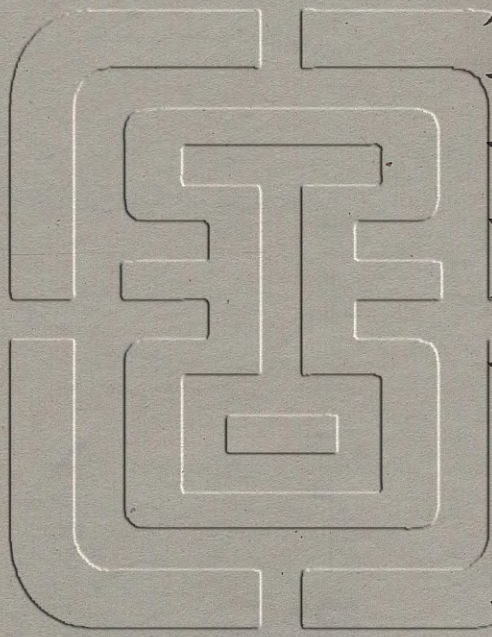

商帶耳尊

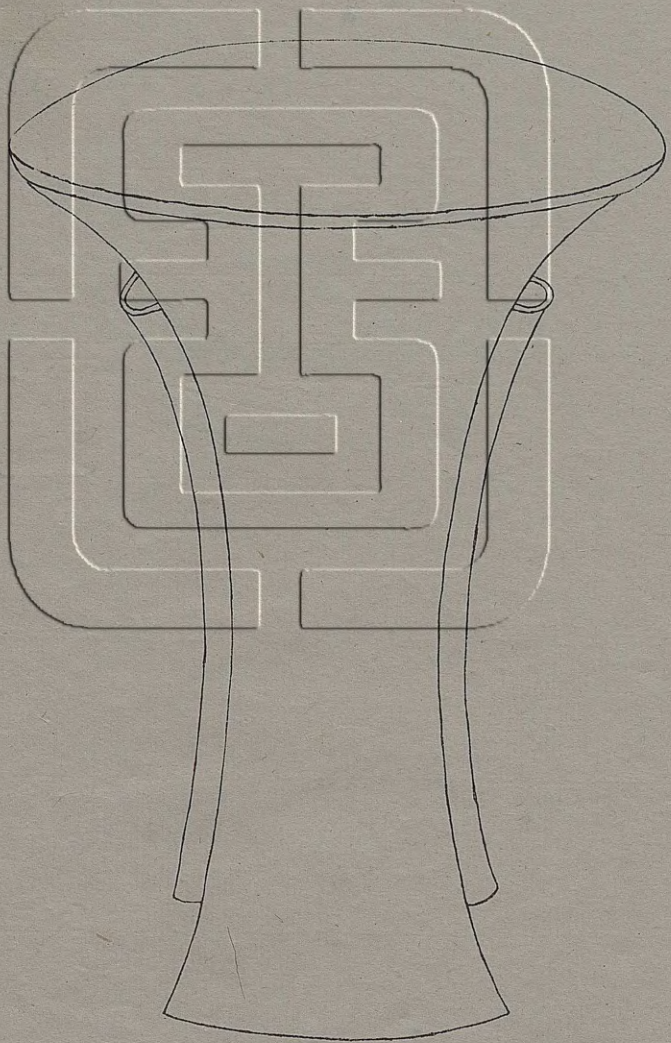

右高八寸八分深五寸八分口径五寸八分重五十二兩

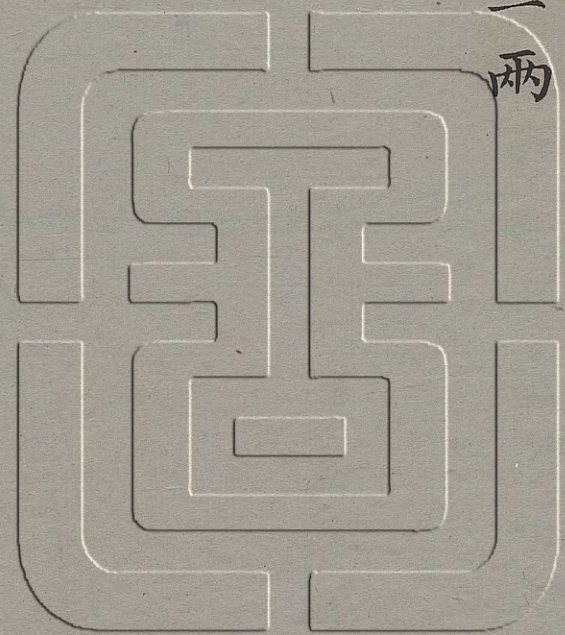

商父乙尊盖

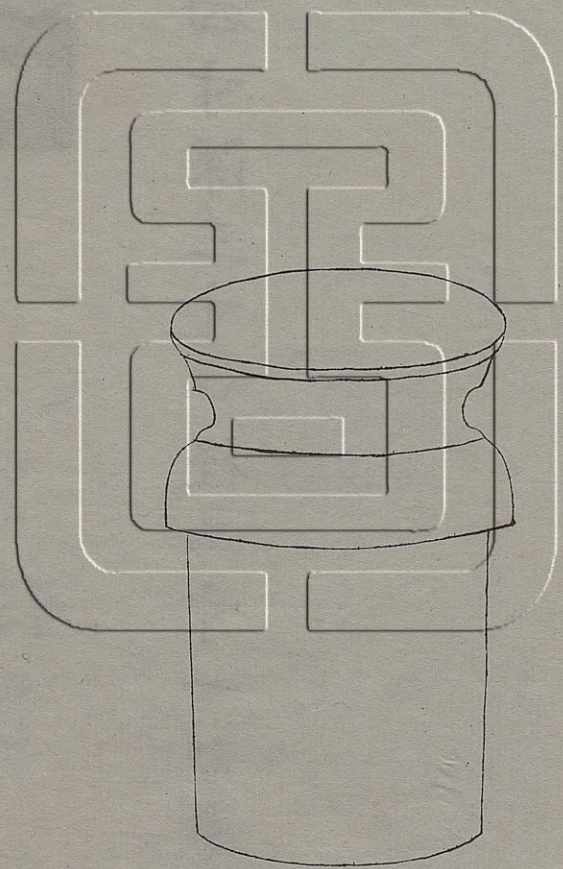

五
五

格中
父乙
橫戈

右高四寸深三寸口径二寸一分重一十二兩五銖

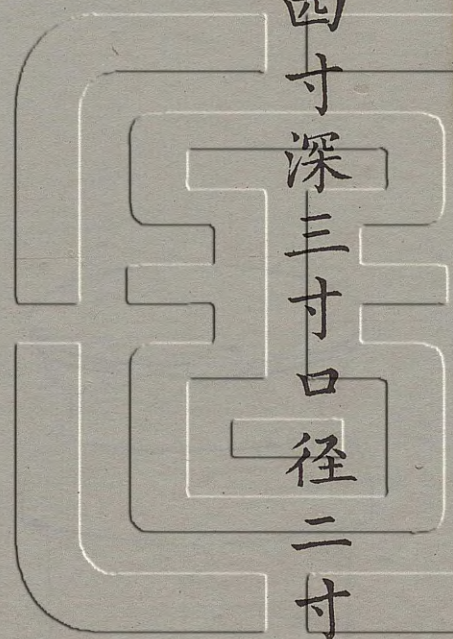

周乙公尊一

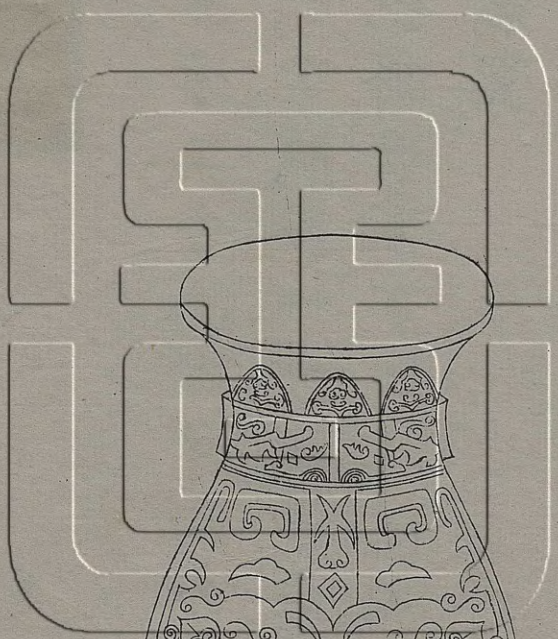
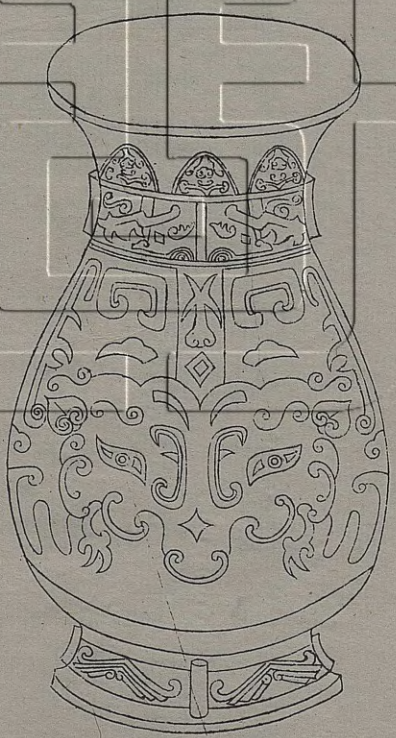

乙公作
萬壽

乙公作
萬壽

右高五寸二分深四寸四分口縱三寸二分橫
三寸六分腹圍一尺七分重二十九兩金銀錯
按史記齊世家丁公呂伋之子為乙公得據銘
知為齊器

周乙公尊二

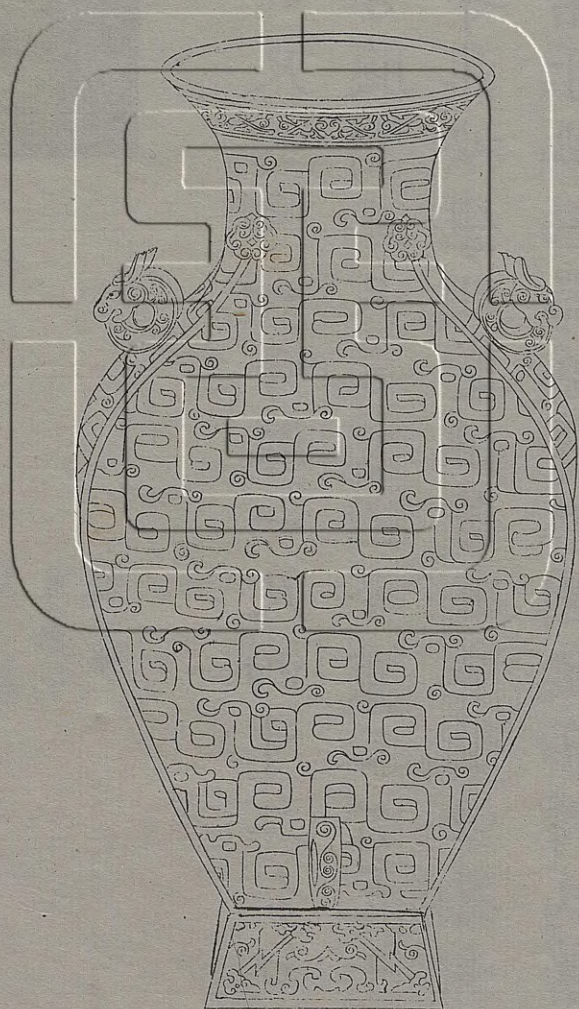



乙公作
萬壽
尊鼎子
孫永

右高一尺六寸一分深一尺四寸二分口徑六寸五分腹圍三尺三寸六分重三百九十五兩
銘曰尊鼎按禮明堂位著殷尊也注著者無足而底著于地此器為尊然圈足不得為著尊又宋黃伯思云鼎之無足者曰著鼎顧此器與鼎象更弗類不得謂之著鼎又明甚且銘首五字與前乙公尊合仍命之曰乙公尊又夢溪筆談得古銅黃彝刻畫甚繁大體似繆篆又如闌楯間所畫迴波曲水之文此紋鏤近之

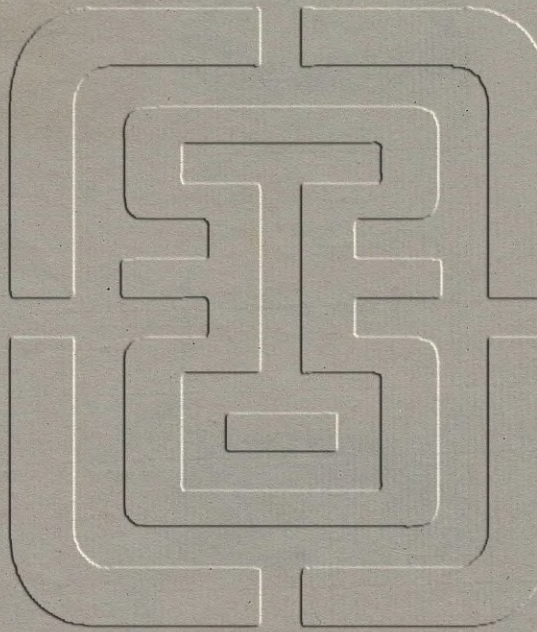

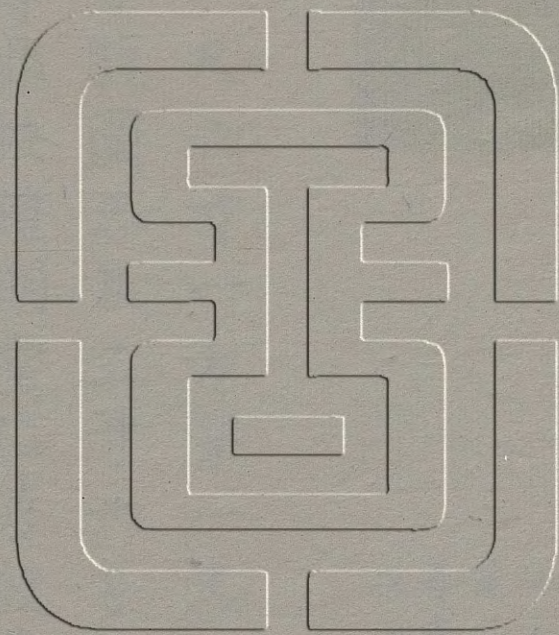

周萬壽尊

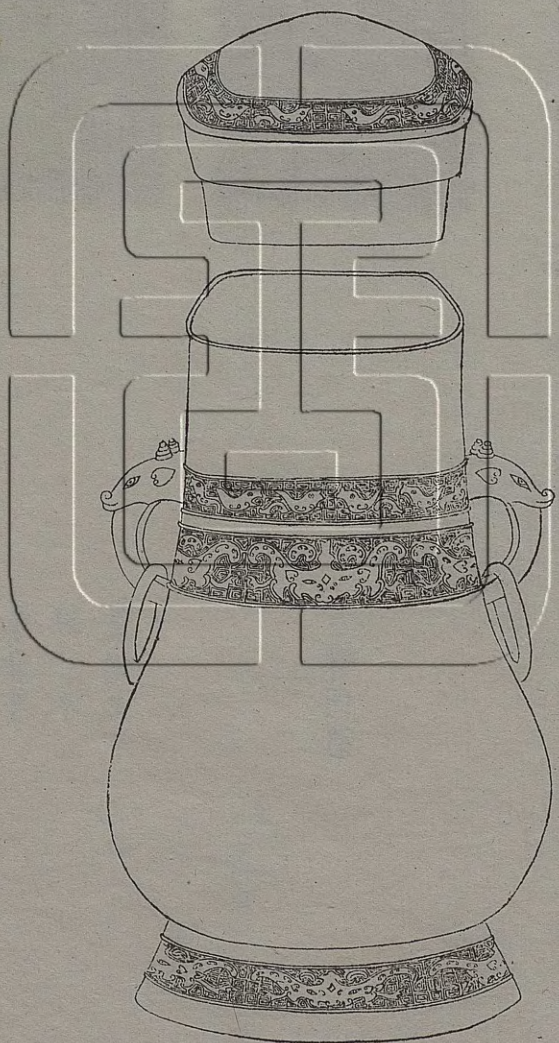

蓋



萬壽
尊鼎子
孫永
寶用之

器

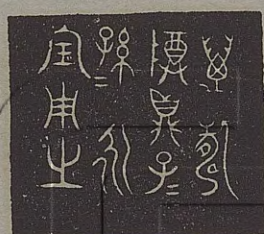

音釋同前

右通蓋高一尺五寸三分深一尺一分口縱四寸二分橫五寸七分腹圍二尺五寸六分重二百一十五兩形制銘文與前器同惟無乙公字蓋一時物也昔人謂臣下為君上監制子孫為父祖專設其銘款咸祝祈壽祉期之世世此三器俱銘曰萬壽是其義矣

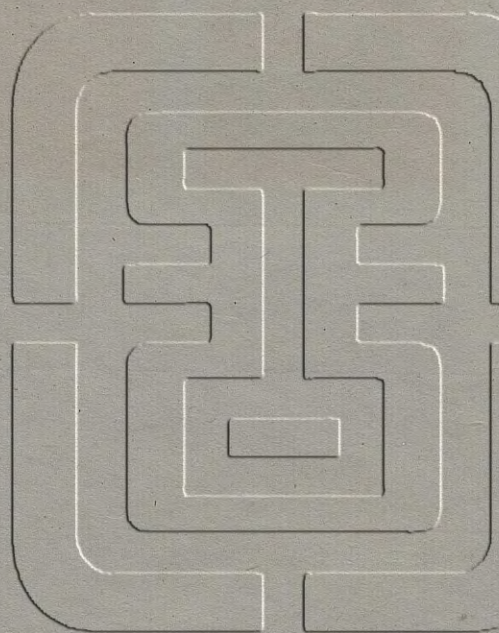

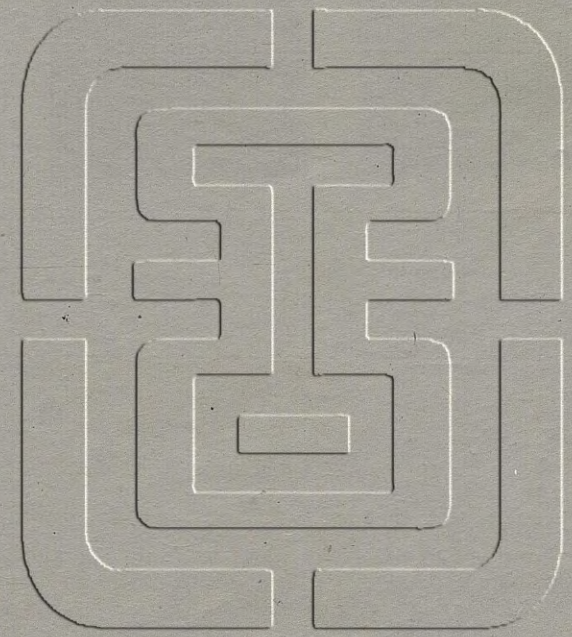

周父己尊

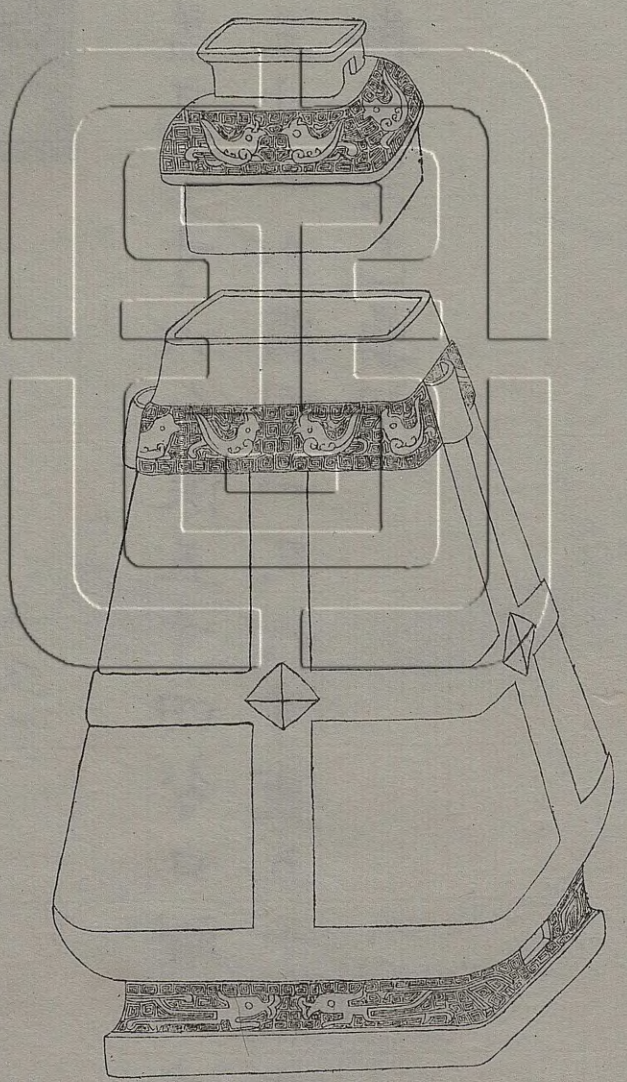

周癸公尊

右通蓋高七寸六分深五寸四分口縱二寸六分橫三寸一分腹圍七尺六寸重五十九兩銘五字與周父己壘同

尊 癸 作 父 己

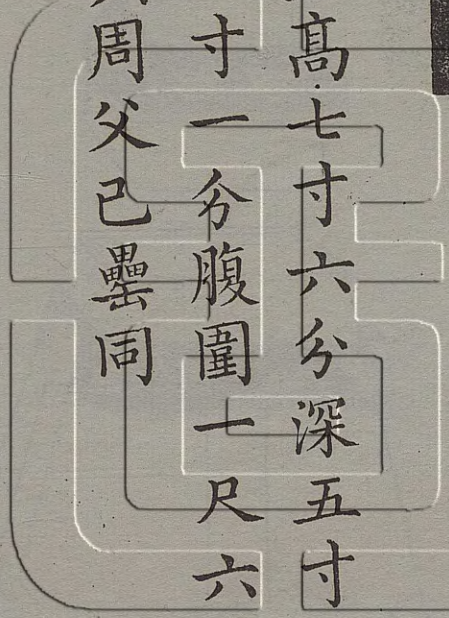

周癸公尊

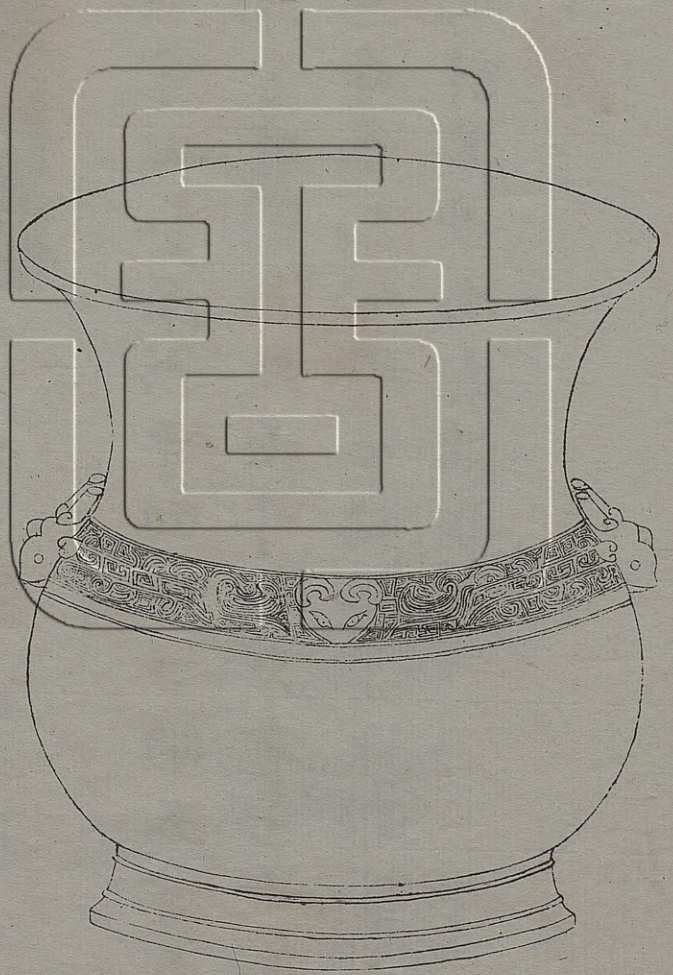

寶尊
丁亥五月作曰癸公

寶尊 彝

右高六寸七分深六寸四分口縱五寸五分橫六寸三分腹圍一尺七寸七分重七十五兩齊癸公慈母為乙公得子銘稱丁亥則昭王始立之歲也許其世次亦昭合

周貫尊

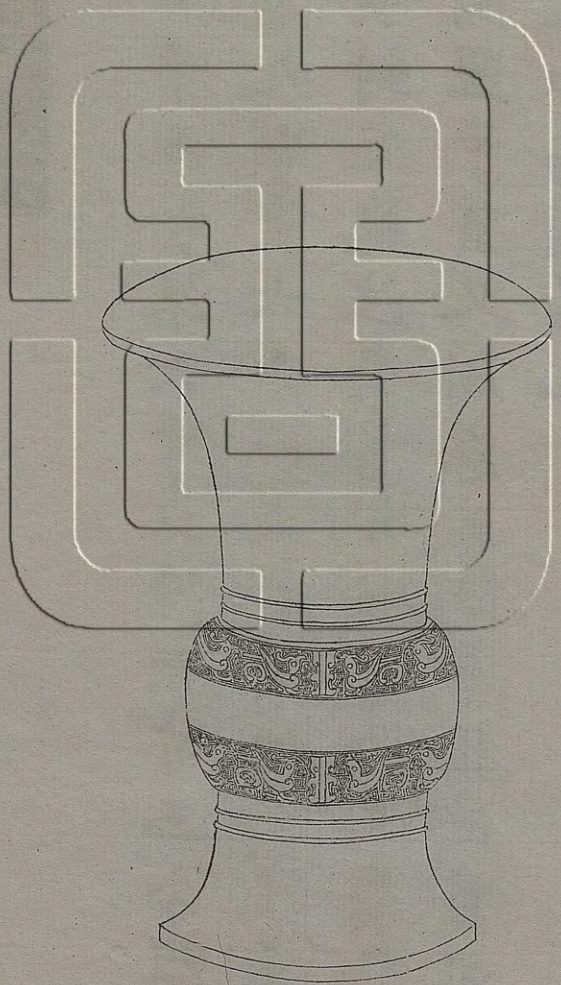



母貫

右高七寸五分深六寸口径六寸三分腹圍一尺二寸九分重六十一兩按禮明堂位崇鼎貫鼎大璜封父龜注崇貫封父皆國名魯僖公二年四國盟于貫又周惠王後有原伯貫此器銘曰貫故知為周器也

周伯和尊一

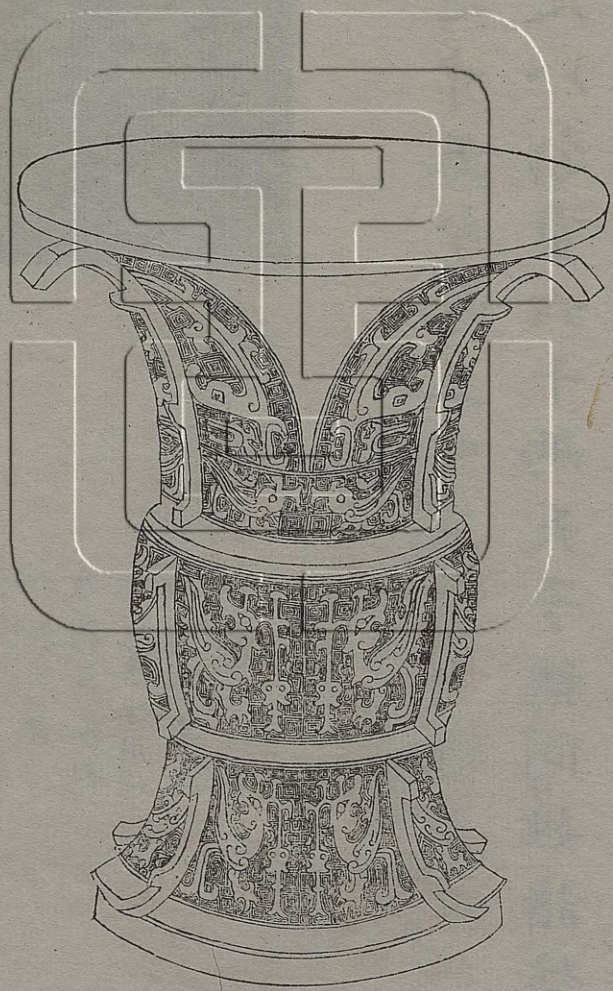

惟王命元年
 正月初吉丁亥
 伯和父若曰
 乃稽。敢對
 揚皇君休用作
 其萬年子孫
 永寶用

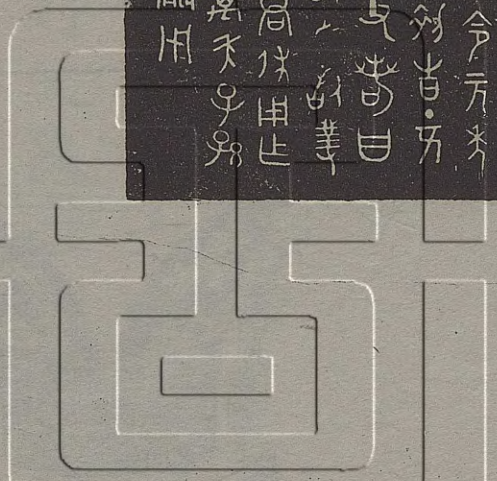

惟王命元年
 正月初吉丁亥
 伯和父若曰
 乃稽。敢對
 揚皇君休用作
 其萬年子孫
 永寶用

右高七寸五分深五寸五分口径五寸八分腹
 圍一尺八分重六十兩天子稱同姓諸侯曰伯
 父叔父而衛武公名和博古圖毀敦考謂伯和
 父為衛武公良是武公以宣王十五年即位至

平王元年東遷命衛侯和為公此銘稱王命元
 年當是平王元年矣

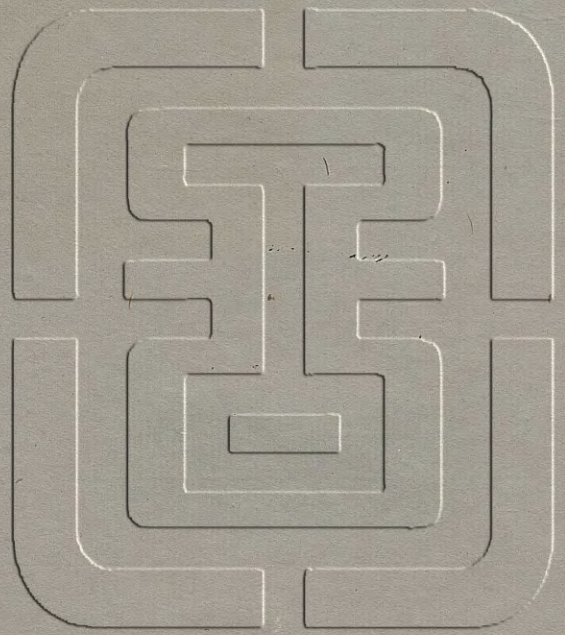

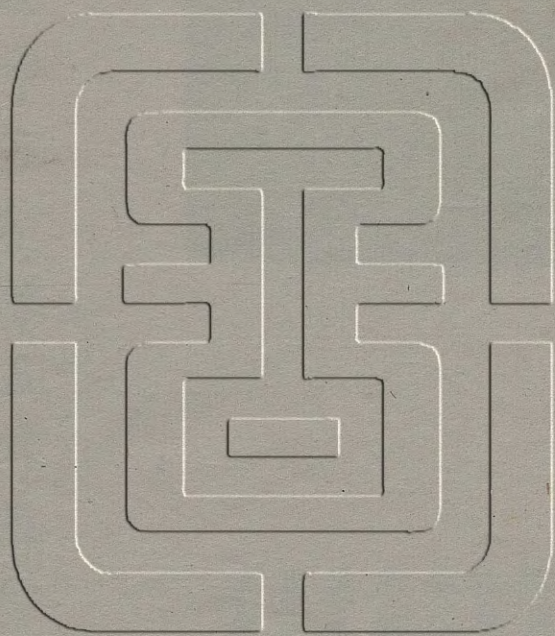

周伯和尊二

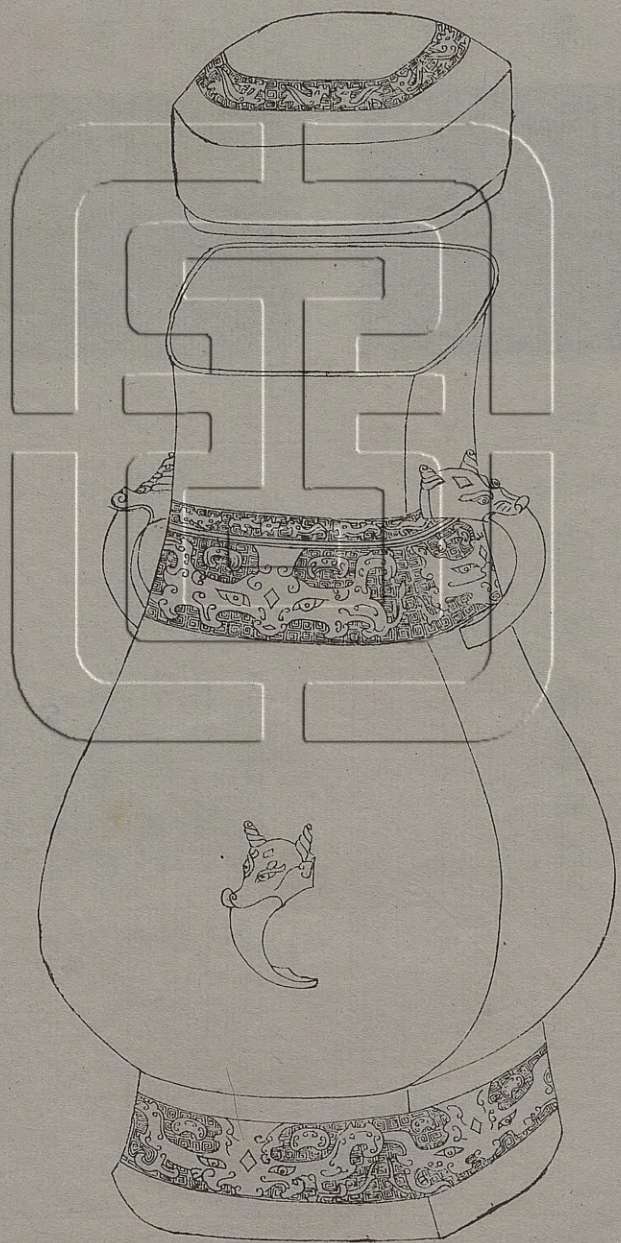

盖

惟王。元。正。初。吉。丁。伯。和。父。若。曰。乃。稽。首。敢。對。揚。皇。君。休。用。其。萬。年。子。永。寶。用。

器

惟王。元。正。初。吉。丁。伯。和。父。若。曰。乃。稽。首。敢。對。揚。皇。君。休。用。其。萬。年。子。永。寶。用。

惟王。元。正。初。吉。丁。伯。和。父。若。曰。乃。稽。首。敢。對。揚。皇。君。休。用。其。萬。年。子。永。寶。用。

音釋同前

右通盖高一尺五寸二分深一尺四分口縱四寸四分橫六寸腹圍二尺四寸八分重二百八十三兩銘與前伯和尊同

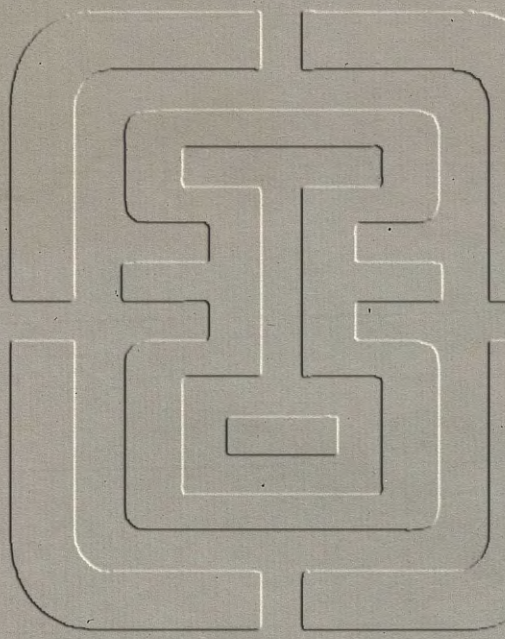

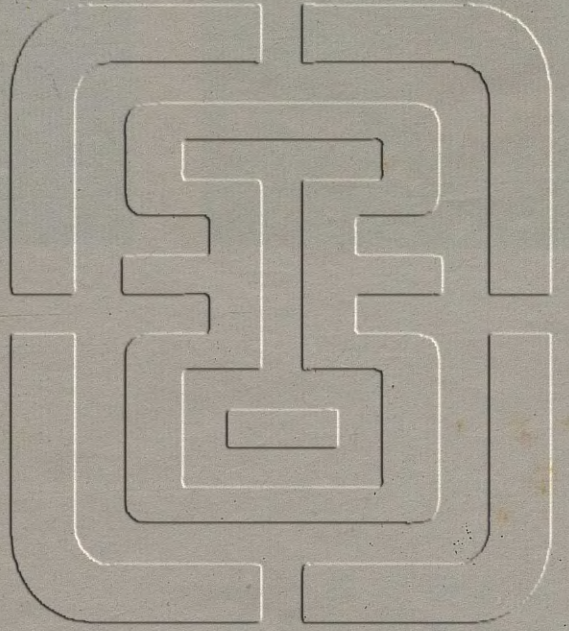

周伯和尊三



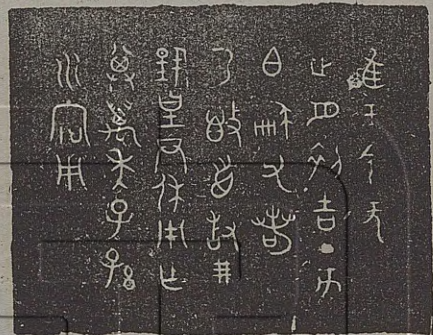

惟王命元
正月初吉丁亥
伯和父若
乃稽首敢對
揚皇君休用作
其萬年子孫
永寶用

右高一尺五寸七分深一尺三寸一分口縱五寸七分橫六寸九分腹圍二尺七寸四分重三百四十七兩金銀錯

周伯矩尊



盖

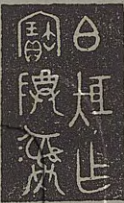

伯矩作寶尊彝

器

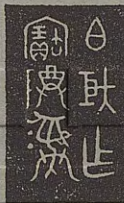

音釋同前

右通盖高七寸七分深五寸五分口縱二寸三分横三寸三分腹圍一尺三寸重四十七兩伯矩不可考意如伯冏伯服耳

周伯尊

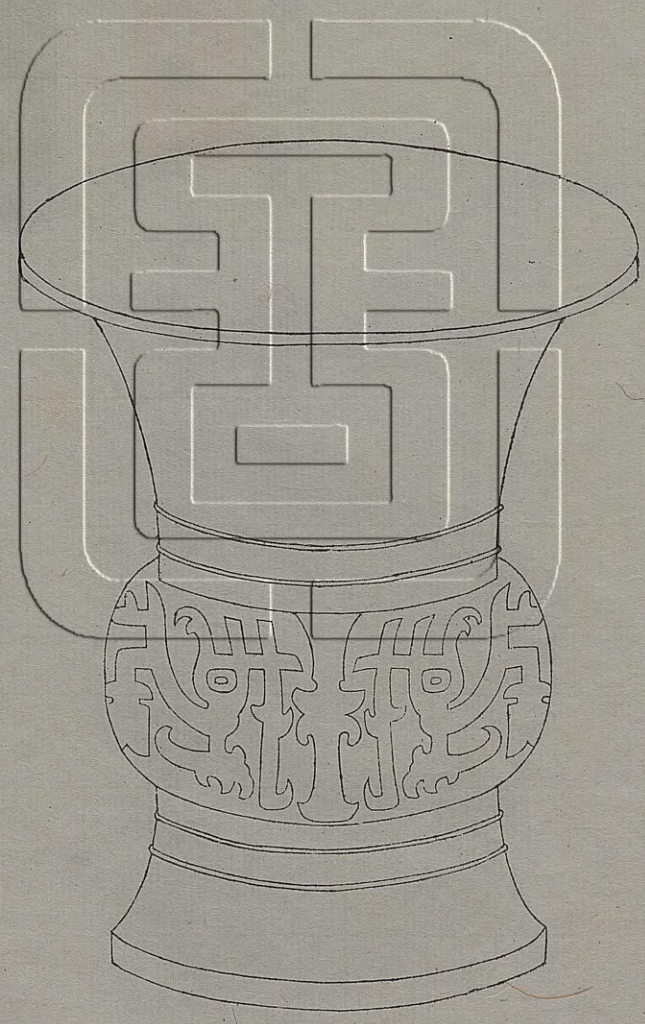

伯作彝

伯作彝

右高七寸二分深五寸九分口径六寸三分腹圍一尺二寸七分重五十三兩

周邢侯尊

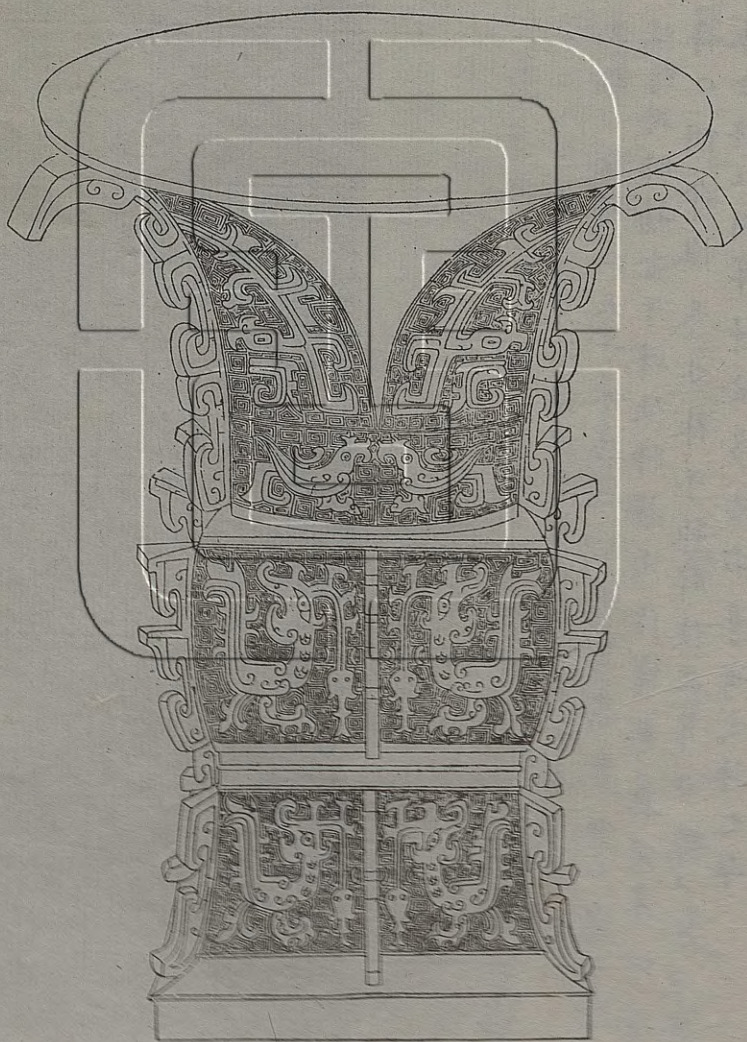

以王射良是錫諸虎臣酉酉盖酒字古通又龔
 字古通恭書甘誓恭行天罰古文或作共或作
 龔銘龔字屢見大抵皆恭字耳



周諸姬尊

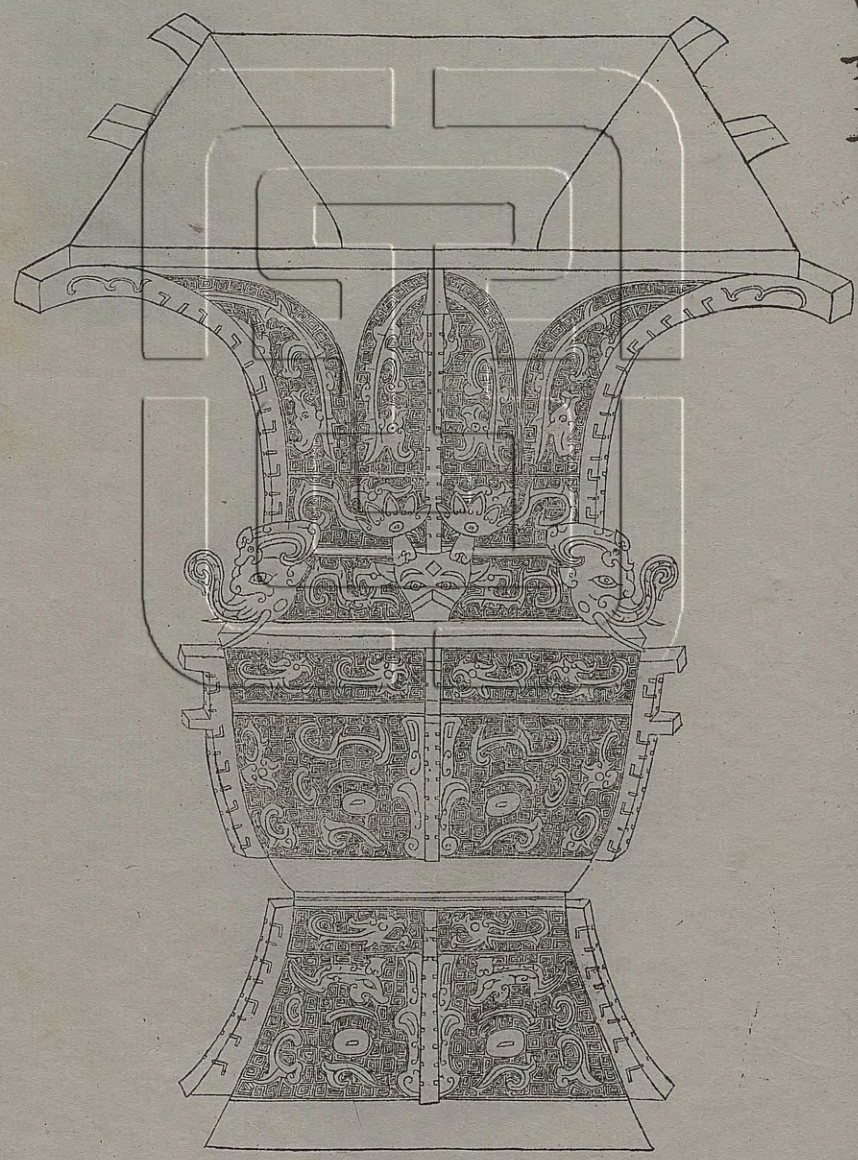

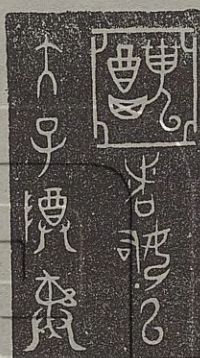

亞形
三格上
尊
諸姬已
天子尊彝

右高一尺四寸二分深一尺五分口縱橫俱如之腹圍二尺六寸重五百八十七兩按漢陽諸姬則姬姓之國皆是銘自稱諸姬盖王族耳

周孔尊



大尊彝
孔作父已

大尊彝
孔作父已

右高一尺二寸深一尺五分口径四寸九分腹
圍二尺四寸一分重二百一十一兩金銀錯銘
左旋讀款曰孔作不可考周人最著者宰孔以
冢宰兼三公是也

周商尊

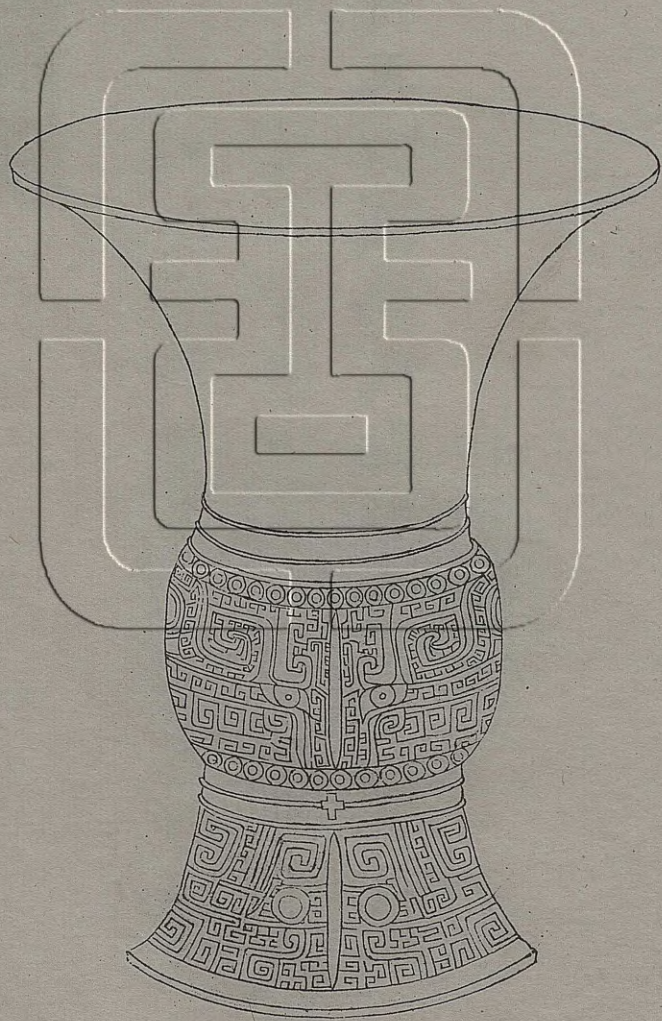

商父辛
冊

商作父辛
冊

右高八寸六分深六寸三分口径六寸八分腹圍一尺二寸二分重七十七兩按魯有鉏商齊有子商又以商為氏銘稱商作人名也

周效尊



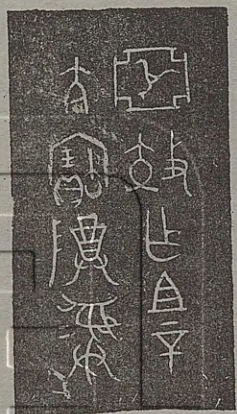

亞形鳥
效作祖辛

大寶尊彝

右高八寸九分深七寸三分口径六寸二分腹圍一尺三寸重七十兩紹興古器評有此尊銘十一字今止存八曰效作蓋其子孫所製祭器也

周季受尊

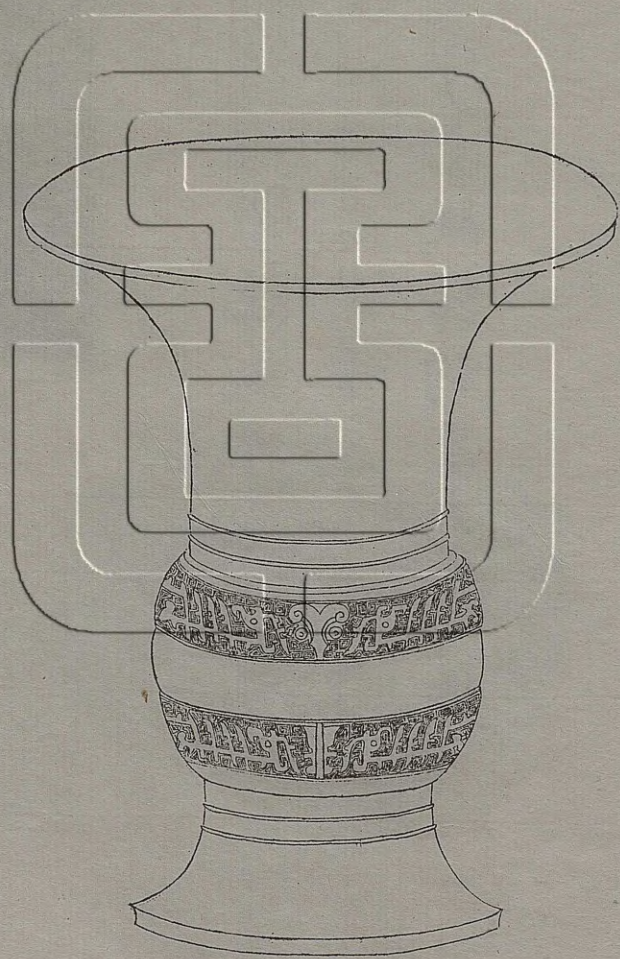

世考收以典彝
貝册保乃休用
休于季受

作者。父尊彝
貝册保乃休用
休于季受

右高六寸四分深五寸五分口径五寸八分腹
圍一尺一寸二分重五十五兩剥落不可識者
三字受字亦缺銘詞蓋左旋讀

周車尊

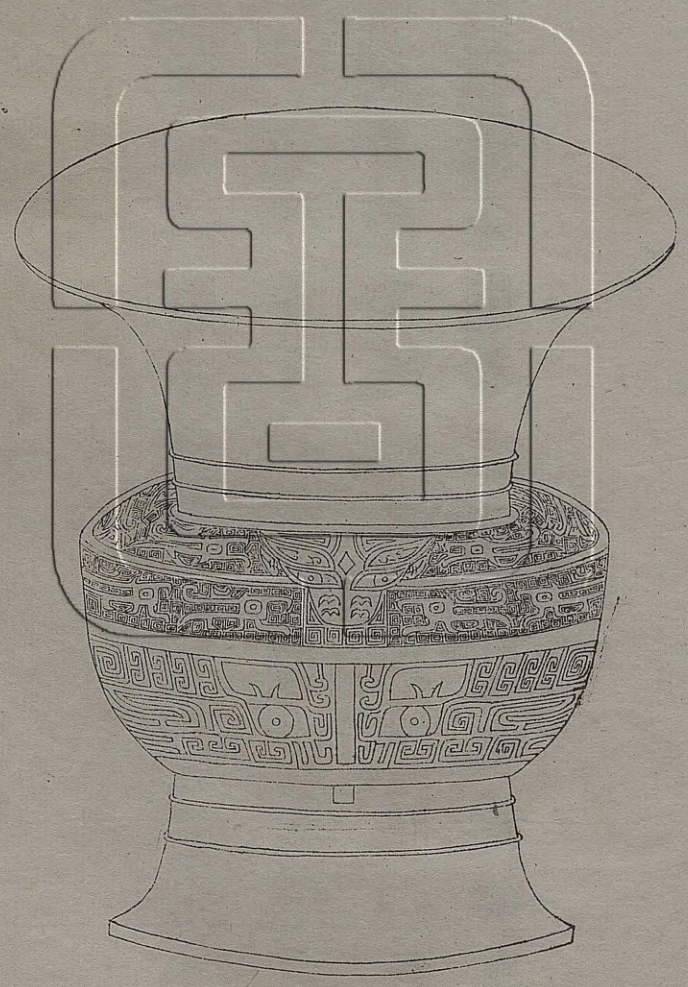

車

車

右高七寸三分深五寸八分口徑七寸四分腹圍一尺八寸四分重八十九兩宋紹興張掄評周車罍謂車軼則致敗而酒之流足以敗德蓋罍為酒器故云爾尊亦盛酒物也銘曰車其以此耶

周鬯尊一

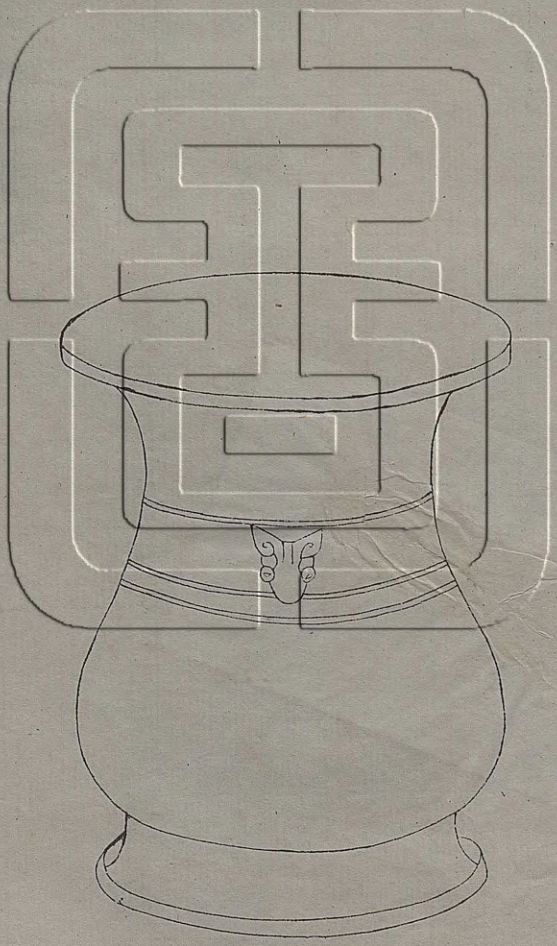

尊
乙
父
乙
寶
尊
彝

尊作父乙
寶尊彝

右高五寸一分深四寸七分口徑五寸四分腹圍一尺四寸重五十三兩
尊字當句如尊鼎是也

周鬯尊二

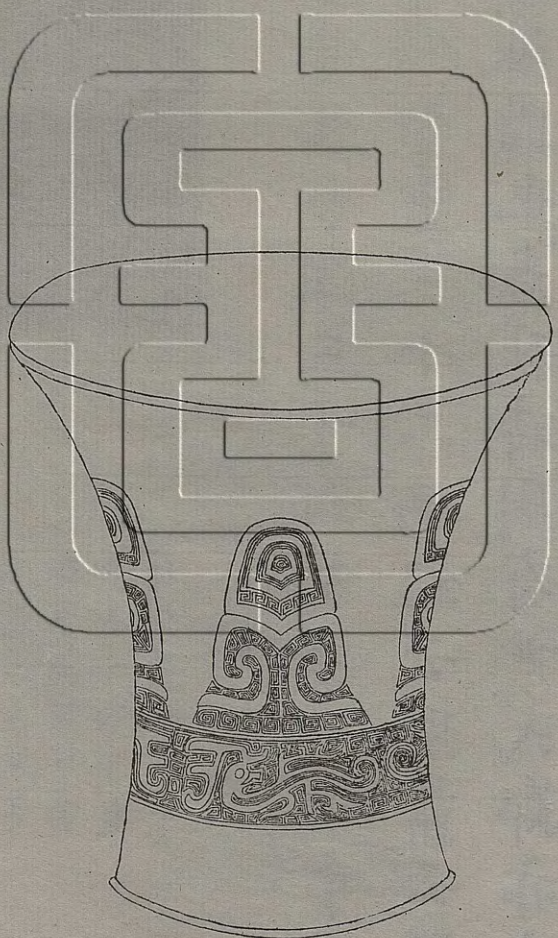

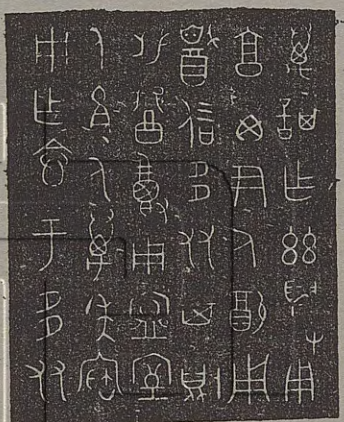

萬祺作茲。用
享。尹人配用
釁信多友其尊
作釁彝用寧室
人員人萬年寶
用作享於多友

右高四寸五分深三寸六分口径四寸五分腹
圍八寸四分重三十二兩銘云用釁云釁彝猶
之飲鼎餼鼎也春秋時周有尹氏鄭亦有尹氏
員通作嬭有嬭氏是也曰配曰室人蓋家廟中
器多友意如周官大旅謂其衆也銘首蓋人名

周內事尊



命王南征。王
 命生辦事。口命
 字生。錫金。首用
 作敦寶尊彝。用對
 揚王休。其萬年永
 寶用饗。內事人
 命王休。其萬年永
 寶用饗。內事人

惟王南征在。王
 命生辦事。公宗
 字生錫金。首用
 作敦寶尊彝。用對
 揚王休。其萬年永
 寶用饗。內事人

右高一尺二寸深八寸九分口径九寸四分腹
 圍一尺八寸八分重五百七兩兩耳有帶按曲
 禮外事以剛日內事以柔日漢儒以外事為治
 兵此銘首稱惟王南征疑為外事而末云內事
 蓋追叙所饗者之功伐而此器則是其宗廟所

用陳氏謂內事如宗廟之祭冠昏之禮皆是故
 銘詞仍云內事也

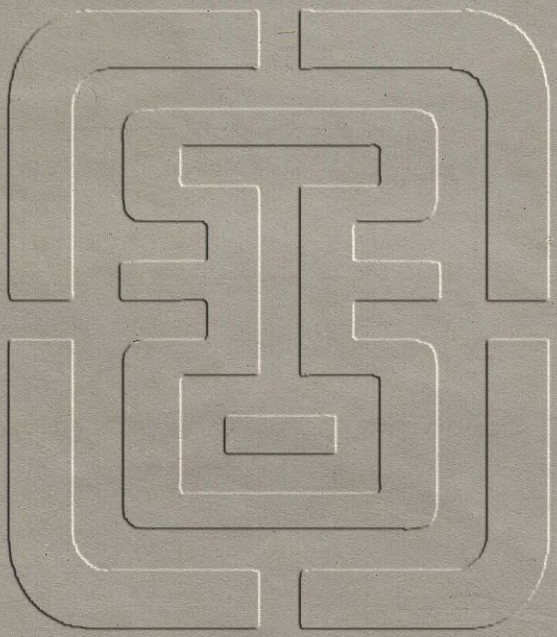

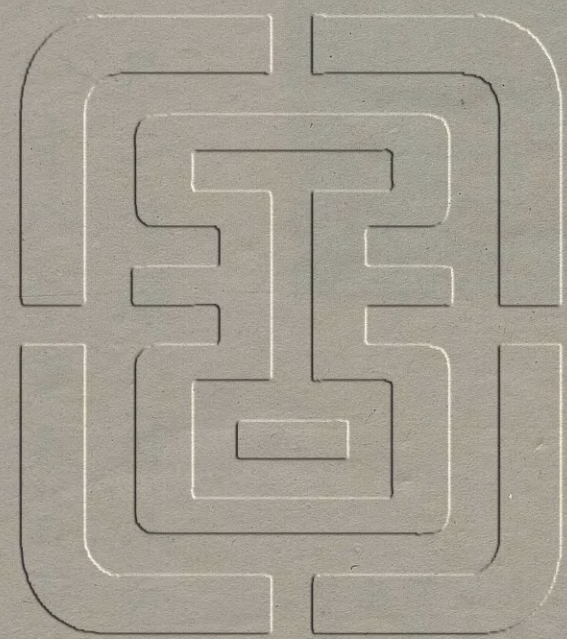
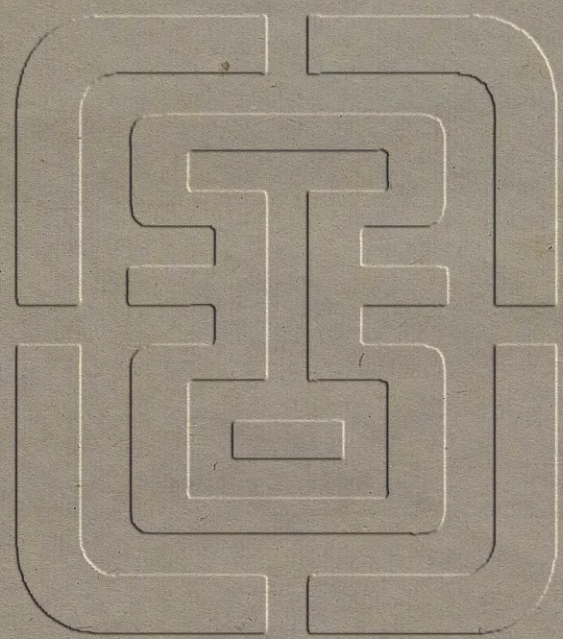

西清古鑊

卷八

四



