

HEADQUARTERS
1st Battalion, 5th Marines
1st Marine Division (Rein) FMF
FPO, San Francisco 96602

UNCLASSIFIED

3/CHB/glk
5750
5 July 1967

00185767

~~SECRET~~

From: Commanding Officer
To: Commanding General, 1st Marine Division (Rein) FMF
Via: Commanding Officer, 5th Marines

Subj: Command Chronology for period 1-30 June 1967

Ref: (a) MCG 5750.2A
(b) FMFPACO 5750.8
(c) DivO 5750.2B

Encl: (1) 1st Battalion, 5th Marines Command Chronology

1. In accordance with the provisions of references (a), (b) and (c),
enclosure (1) is submitted.

J. P. White
J. P. WHITE
Acting

DOWNGRADED AT 3 YEAR INTERVALS
DECLASSIFIED AFTER 12 YEARS
DOD DR 5200.10

COPY NO 3 OF 10 COPIES

~~SECRET~~

5TH MAR 820 FILES

00870-67
COPY NO. 3879

UNCLASSIFIED

FM/5th MAR
CWD QIKK
1 MAR 1967

UNCLASSIFIED

HEADQUARTERS
1st Battalion, 5th Marines
1st Marine Division (Rein) FMF
APO, San Francisco 96602

COMMAND CHRONOLOGY

1 June 1967 to 30 June 1967

INDEX

- PART I - ORGANIZATIONAL DATA
- PART II - NARRATIVE SUMMARY
- PART III - SEQUENTIAL LISTING OF SIGNIFICANT EVENTS
- PART IV - SUPPORTING DOCUMENTS

UNCLASSIFIED

PART I

UNCLASSIFIEDORGANIZATIONAL DATA1. Designation

1st Battalion, 5th Marines (Rein)

Commander

1-30 June 1967

LTCOL P. L. HILGARTNER

SUBORDINATE UNITS

H&S Company

1-25 June 1967

CAPT H. G. LYLES

25-30 June 1967

CAPT A. C. BLADES

Company A

1-2 June 1967

CAPT R. G. BABICH

2-30 June 1967

CAPT B. K. BRODIE

Company B

1-30 June 1967

CAPT T. D. REESE

Company C

1-30 June 1967

CAPT H. C. JOHNSTON

Company D

1-30 June 1967

1STLT D. L. MCINTURFF

ATTACHED UNITS

Det, Btry D, 2ndBn, 11thMar (1-9 June 1967)

1STLT B. MARRS

(9-30 June 1967)

2NDLT N. F. CARLUCCI, JR.

Det, 1st Dental Company (1-10 June 1967)

LT D. E. ELDRED (USN)

1st Plat, Co B, 1stEngrBn (1-30 June 1967)

2NDLT G. L. NEWKIRK

1st Plat, Co B, 1stSPBn (1-30 June 1967)

2NDLT C. B. KEPPORD

1-1

ENCLOSURE (1)

UNCLASSIFIED

UNCLASSIFIED

2. Location.

1-5 June 1967 1st Battalion, 5th Marines (-)(Rein) participated in Operation UNION II

15-22 June 1967 1st Battalion, 5th Marines (-)(Rein) participated in Operation ADAIR

25-30 June 1967 1st Battalion, 5th Marines (-)(Rein) participated in Operation CALHOUN

1-30 June 1967 1st Battalion, 5th Marines (-)(Rein) Combat Base located at Hill 51 (BT 025343); QUE SON, RVN

1-30 June 1967 1st Battalion, 5th Marines (Rear) located in CHU LAI (BT 533084); CHU LAI, RVN

1-30 June 1967 Det, 1st Battalion, 5th Marines located at ISA (BT 296235); TAM KY, RVN

1-8 June 1967 Company C (-) 1st Battalion, 5th Marines (-)(Rein) located at NUI LAC SON (BT 024288); QUE SON, RVN

8-30 June 1967 Company D (-) 1st Battalion, 5th Marines (-)(Rein) located at NUI LAC SON (BT 024248); QUE SON, RVN

3. Staff/Officers.

Executive Officer

1-30 June 1967
MAJ J. P. WHITE

S-1 Officer

1-30 June 1967
WO J. E. PERRY

S-2 Officer

1-30 June 1967
2NDLT V. J. VERNANZI

S-3 Officer

1-30 June 1967
MAJ C. H. SLACK

S-4 Officer

1-30 June 1967
CAPT A. C. BLADES

S-5 Officer

1-30 June 1967
CAPT G. L. MCKAY

Air Liaison Officer

1-30 June 1967
CAPT D. L. MONROE

Medical Officer

1-30 June 1967
 LT K. P. DONNELLY (USNR)

Supply Officer

1-2 June 1967
 1STLT J. L. LULFS

2-15 June 1967
 SSgt K. J. CARROLL

15-30 June 1967
 GYSGT W. E. HENSLEY

Communication Officer

1-30 June 1967
 CLPT G. L. MCKAY

Motor Transport Officer

1-30 June 1967
 2NDLT A. DESCHAMPS

Legal Officer/Adjutant

1-30 June 1967
 2NDLT G. S. LIDBACK, JR.

Chaplain

1-30 June 1967
 LT C. J. MERRIN (USNR)

4. Average Monthly Strength.

<u>USMC</u>		<u>USN</u>	
<u>Officers</u>	<u>Enlisted</u>	<u>Officers</u>	<u>Enlisted</u>
28	895	3	44

UNCLASSIFIED

PART II

NARRATIVE SUMMARY

1. Personnel and Administration. This Battalion operated at below 90% of manning level during the entire month of June 1967. Battalion and company administration was handled at administration rear (CHU LAI, RVN). Difficulties were encountered in some areas due to distance and lack of communications between QUE SON and CHU LAI. Disciplinary problems were below average. Pay calls and sale of piasters were conducted in the field for all personnel. Mobile exchange runs were made providing essential items for health and comfort. 400 cans of iced beer were served by the 1st Battalion, 5th Marines. The iced beer was presented by Premier KY with his compliments for the Battalion's performance on Operation UNION I. A temporary chapel was erected and divine services were conducted each worship day. An awards ceremony was conducted at the combat base on 24 June 1967. The Regimental Commander presented 1 Bronze Star, 10 Purple Hearts and 2 Vietnamese Crosses of Gallantry to Battalion personnel. During the month of June, 51 awards for heroism or meritorious service were processed and forwarded recommending approval.

2. Organizations and Operations.

a. The 1st Battalion, 5th Marines participated in Operation UNION II against enemy forces from 1 June 1967 until termination on 5 June 1967.

b. With the termination of Operation UNION II, the battalion returned to the Combat Base at Hill 51 (BT 025345) in the vicinity of QUE SON, RVN and continued the development of the base. Company operations, platoon and squad patrols were conducted on a daily basis to clear and control areas adjacent to the Combat Base.

c. On 15 June 1967, the 1st Battalion, 5th Marines was committed to Operation ADMIN and was involved in the operation until its termination on 23 June 1967. On 25 June 1967, the 1st Battalion, 5th Marines was committed to Operation CALIBURN which continued into July.

d. Tactical wire was improved and triple concertina was completed around the perimeter. Fighting positions were improved and fields of fire were cleared. Tanks and Ontos were integrated into the Combat Base defensive fires.

3. Training.

The 1st Battalion, 5th Marines opened a rifle range with a left lateral limit from (BT 025337) to (AT 993316) and a right lateral limit from (BT 026335) to (BT 005314) for Fam Firing. On 8 June 1967, the first weapons were fired. Training continued on a daily basis with weapons safety, indoctrination for new personnel, familiarization firing of weapons, treatment of POW's in accordance with the rules of the Geneva Convention and the rules of engagement receiving emphasis.

4. Logistics, Equipment and Supply.

a. The 1st Battalion, 5th Marines continued to be supported by the logistical Support Area in TAM KY, RVN (BT 296235) with routine resupply continuing on an alternate day basis.

b. A motor transport garage with 2 mite capacity and a POL dump for fuel storage was completed. Construction was started on the ammunition storage bunker and ground was cleared for the COC bunker.

c. On 10 June 1967, the first hot meal was served at the battalion messhall at the 1st Battalion, 5th Marines Combat Base.

5. Civil Affairs/Civic Action.

a. The US Army Civil Affairs Survey Team conducted a survey of the QUE SON area to determine the requirements and possibilities of civic action in the QUE SON area.

b. Meetings were held frequently with the District Chief of QUE SON with special attention given to the clearness of the area and prevention of the spread of disease. A MEDCAP building was completed in the village of LANH THUONG (5). 871 Vietnamese civilians received treatment at the daily MEDCAP during the month of June, while the combat base at NUI LAC SON treated 161.

c. Twenty-three refugees were evacuated from vicinity (BT 013393) to the QUE SON District refugee center.

6. Communications.

a. During June, wire lines at Hill 51 were cabled and bunker phones were placed in protective boxes. The radio relay to 5th Marine Regiment was approximately 50% reliable. Frequent equipment failures were experienced.

7. Significant cumulative casualties sustained and inflicted.

Friendly Casualties Sustained.

KIA	28
DOW	1
WIAE	55
WIANE	9
NBC	37

Enemy Casualties Inflicted.

VC KIA confirmed	307
VC KIA probable	312
VC WIA probable	85
VCC	25 (1 WIA)
Detainees	67

8. Significant Enemy Ordnance Captured.

- 16 Chinese 7.62mm Assault Rifle Type 56
- 5 US Carbines
- 1 US Browning Automatic rifle caliber 30 M1911842
- 1 US Rifle M-1
- 1 12 Gauge Shotgun
- 1 North Vietnamese modified 7.62 Submachine gun Type 50
- 4 Chinese anti-tank rocket launchers
- 1 M-60 US machine gun
- 3 ChiCom machine guns
- 1 US Machine gun Caliber 30 M1919A4
- 1 French 7.5mm MLE 36
- 1 Russian carbine type 33
- 2 Rifles unknown type

DECLASSIFIED
ENCLOSURE (1)

35 Weapons magazines
 4 Bayonets
 3 scabbards

9. Significant Munitions Found, Captured and Destroyed.

107 rounds 7.62 ammo (US)
 25 ChiCom fragmentation grenades
 5 Defensive (concussion) grenades
 1 Anti-personnel mine
 9 2.75 inch rockets
 1 M-14 anti-personnel mine (boobytrap)
 4 250 pound (US) bombs
 1 M-79 round (dud)
 1 100 pound (US) bomb (dud)
 1 M-16 anti-personnel mine (boobytrap)
 1 105 HE round (dud)
 1 155 HE round (dud)
 3 M-26 fragmentation grenade
 40 rounds 90mm ammunition
 3 57mm canisters
 200 rounds 30 caliber M-1 US ammunition,
 30 rounds 7.62mm Russian ammunition
 1 Z-10 Chinese mine (boobytrap)
 35 rounds 30 caliber ammunition (US)
 1 60mm HE round

10. Significant Enemy Equipment Captured.

2 leather medical carrying cases
 6 packs
 15 Hammocks
 2 Magazine carriers
 11 Pistol belts
 1 First aid packet
 12 Canteens of all types
 10 Canteen covers of all types
 16 Cartridge belts
 14 Ponchos all types
 1 Flashlight
 4 Entrenching tools
 31,900 Plasters
 1 Hand drawn map
 9 Gas masks
 1 Pair of leather boots
 1 Bear trap
 1 Uniform grey

UNCLASSIFIED

11. Significant Caves and Tunnels destroyed.A. Caves.

2 feet high, 8 feet long, 3 feet wide
10 feet high, 45 feet long, 45 feet wide
5 feet high, 5 feet long, 6 feet wide
13 feet high, 16 feet long, 13 feet wide
7 feet high, 7 feet long, 5 feet wide
3 feet high, 10 feet long, 10 feet wide
4 feet high, 8 feet long, 3 feet wide
30 feet high, 30 feet long, 20 feet wide
12 feet high, 12 feet long, 12 feet wide (2)
15 feet high, 45 feet long, 25 feet wide
10 feet high, 45 feet long, 25 feet wide

B. Tunnels.

4 feet high, 30 feet long, 5 feet wide
7 feet high, 500 feet long, 7 feet wide
5 feet high, 40 feet long, 4 feet wide
4 feet high, 160 feet long, 4 feet wide
3 feet high, 12 feet long, 4 feet wide (3)

PART III

SEQUENTIAL LISTING OF SIGNIFICANT EVENTS

(1) 1 June 1967 From 010001H to 051800H the 1st Battalion, 5th Marines participated in Operation Union II. Refer to Tab (a) to Enclosure (1).

(2) 010820H Company B (-) departed combat base to conduct S&D operations in accordance with 1st Battalion, 5th Marines Frag Order 51A-67. Refer to Tab (b) to Enclosure (1).

(3) 010930H Village chief of Phu Binh Hamlet, located in vicinity (AF 984276), arrived at 2nd Platoon, Company C's position at Mui Lac Son located in vicinity (BT 023288) with one Chieu Hoi. Chieu Hoi had turned himself in to the village chief at 311000H. The Chieu Hoi was wearing black clothing, had no ID card and was about 22 years of age. Chieu Hoi was forwarded to 5th Marines S-2.

(4) 010930H A MED/DENT CAP patrol was conducted at Lanh Thuong (5) Hamlet located in vicinity (BT 024346). 4 PF's provided security for the patrol. 34 Vietnamese were treated at MEDCAP. 17 Vietnamese were treated at DENTCAP.

(5) 011035H Company B (-) located in vicinity (BT 011328) received 6 rounds small arms fire from 2-3 unobserved snipers located in vicinity (BT 009328). Fire was received from the west at a distance of approximately 300 meters. Company B (-) returned fire with 150 rounds small arms fire and 5 M-79 rounds and dispatched a squad to search the area. VC broke contact and fled in an undetermined direction. The area was searched with negative results.

(6) 011110H Company B (-) located in vicinity (BT 005334) received 3 rounds small arms fire from an unobserved sniper located in a hut in vicinity (BT 005337). Fire was received from the north at a distance of 300 meters. Company B returned fire with approximately 350 rounds small arms fire and maneuvered two squads into position to assault the sniper position. The position was assaulted and searched. The sniper fled in an undetermined direction. During the search, a squad found a hand drawn map and a tunnel with 2 entrances, located under the hut. Tunnel was 4 feet high, .8 foot long and 3 feet wide. Tunnel was destroyed by engineers and the hand drawn map was forwarded to 5th Marines S-2

(7) 011320H Company B (-) located in vicinity (AF 003356) observed 6 VC located in vicinity (BT 009355) moving in a northerly direction. 5 VC were wearing black clothing and one was wearing green clothing. Company B (-) engaged the VC by firing 300 rounds small arms fire and 10 M-79 rounds. The VC returned fire with 40-50 rounds small arms fire and fled in an undetermined direction. The area was searched with negative results.

(8) 011330H An S-5 representative with the MED CAP patrol in Lanh Thuong (5) Hamlet located in vicinity (BT 024346) was informed by a PF that a platoon of VC armed with automatic weapons were observed moving in vicinity of grid square (BT 0836) on the night of 31 May 1967. PF also reported that a VC company was located in 2-3 caves in vicinity (BT 015365). H&I fires were fired in both reported VC locations. Areas were not searched.

(9) 011543H Company B (-) arrived at the combat base, terminating company S&D operation.

(10) 020120H 1st Battalion, 5th Marines Combat Base perimeter located in vicinity (BT 025343) received 15 rounds of incoming mortar fire from a northerly direction. It was estimated the mortars were located 2000 meters from the combat base in vicinity (BT 024363). 81's and artillery fired counter mortar fire within minutes after the first enemy mortar round hit within the combat base. 81's fired 63 HE rounds and artillery fired 30 105mm HE rounds. Secondary explosions were observed by FO's during the counter mortar barrage. No casualties were sustained within the combat base. Subsequent intelligence reports indicated 4 enemy KIA (probable) and 3 WIA (probable).

(11) 020930H A MED/DENT CAP patrol was conducted in Lanh Thuong (5) Hamlet, located in vicinity (BT 024346). 4 PF's provided security for the patrol. 40 Vietnamese were treated at MEDCAP. 10 Vietnamese were treated at DENTCAP.

(12) 2 June 1967 A water point and purification system was established at the combat base.

(13) 021030H 81mm mortar section while firing registration fires at Nui Lac Son, located in vicinity (BT 023288), fired one short WP round which landed in a friendly position located in vicinity (BT 025282). A squad patrol, with two corpsmen, an interpreter and an S-5 representative were dispatched to assist the villagers. One Vietnamese civilian was wounded. The civilian was not seriously wounded and was administered first aid.

(14) 021340H Local villager pointed out to the perimeter security patrol one M-14 anti personnel mine located in vicinity (BT 021340). The mine was buried about 2 inches beneath the ground in vicinity of a grassy area. The mine was destroyed in place by engineers.

(15) 031215H Combat outpost from Company C located in vicinity (BT 014343) received 4 rounds small arms fire from an unobserved sniper located in vicinity (BT 012338). Fire was received from the south at a distance of approximately 600-700 meters. COP returned fire with 20 rounds small arms fire and searched the area with negative results. Sniper broke contact and fled in an undetermined direction.

UNCLASSIFIED

(16) 030930H A MED/DENT CAP patrol was conducted in Lanh Thuong (5) Hamlet located in vicinity (BT 024346). 4 PF's provided security for the patrol. 27 Vietnamese civilians were treated at MEDCAP. 7 Vietnamese civilians were treated at DENTCAP. 15 bars of soap were distributed to the villagers.

(17) 041230H Combat Outpost from Company C located in vicinity (BT 024324) apprehended one Vietnamese male without ID card, about 35 years of age and wearing black and white clothing. Detainee was moving along a trail toward the COP when he observed the Marines. After observing the Marines, detainee attempted to flee in the opposite direction. Detainee was forwarded to 5th Marines S-2.

(18) 041325H Squad security patrol from Company B, while searching area in vicinity (BT 024337) found a cave 2 feet wide, 3 feet high and 8 feet long. The cave was searched with negative results and destroyed by engineers. 4 June 1967 During the morning, Major General ROBERTSON, the Commanding General 1st Marine Division, and the Regimental S-3 officer, Major ALGER visited the 1st Battalion, 5th Marines combat base located in vicinity (BT 025343) and Company D combat base at NUI LAC SON located in vicinity (BT 024288). The visit lasted for approximately 10 minutes at each position.

(19) 5 June 1967 The Commanding Officer's Mighty Mite and trailer were helilifted from the ISA to the combat base.

(20) 050930H A MED/DENT CAP patrol was conducted in Lanh Thuong (5) Hamlet located in vicinity (BT 024346). 4 PF's provided security for the patrol. 35 Vietnamese civilians were treated at MEDCAP. 20 Vietnamese were treated at DENTCAP. 12 bars of soap were distributed to the villagers.

(21) 051330H Squad Security Patrol 501 located in vicinity (BT 022333) found 2 60mm illumination cannisters and what might possibly have been a homemade mortar tube and base. A Vietnamese male, about 35-40 years of age, without ID card and wearing black clothing was found hiding in an abandoned dwelling. Detainee was apprehended, returned to the combat base and interrogated by 9th IFF. Detainee and what might have been a 60mm mortar tube and base were forwarded to 5th Marines S-2.

(22) 051400H Fire team Combat Outpost 503 located in vicinity (BT 023358) apprehended two Vietnamese males while moving to COP position. The detainees attempted to run when they observed the Marines. Detainees were 40 and 45 years of age, had ID cards and wore white clothing. Detainees were returned to the Combat Base, interrogated by members of 9th IFF and were forwarded to 5th Marines S-2.

UNCLASSIFIED

(23) 051502H Squad Security Patrol 5B2 located in vicinity (BT 024336) found one 250 pound US bomb, one VC homemade gas mask, miscellaneous papers and a pair of khaki trousers. Bomb was destroyed in place by engineers. Papers, gas mask and khaki trousers were forwarded to 5th Marines S-2.

(24) 051630H All 1st Battalion, 5th Marines units participating in Operation UNION II, returned to the combat base.

(25) 051800H Operation UNION II was terminated. Refer to Tab (a) to enclosure (1).

(26) 051800H Company B commenced search and destroy operations, IAW 1st Battalion, 5th Marines Frag Order 59-67. See Tab (c) to enclosure (1).

(27) 051815H Frag Order 59-67 issued to Company B was modified directing Company B to move to CP 15, then to Objective B and to be prepared to continue the attack to relieve NUI LAC SON if it was brought under attack. Refer to Tab (c) to enclosure (1).

(28) 051900H A PF reported to 2nd Platoon, Company C located at NUI LAC SON (BT 023288) that there were 120 VC located in trenches at locations from (BT 996299) to (AT 998299) to (BT 003299). With the use of a BC scope, movement was observed by FO's. Three Vietnamese, dressed in black and with binoculars, were seen observing the Combat Base at NUI LAC SON; also groups of 4 to 5 Vietnamese were observed moving in the area pointed out by the PF. A TAC/A was called to observe the area of reported VC activity. The TAC/A observed 2 groups of 15-20 VC and other small groups of VC moving in the area in vicinity (AT 998299) to (BT 003294). Artillery and air strikes were called on the VC positions, with good target coverage. The TAC/A controlled the airstrikes and observed one secondary explosion and 2 secondary fires. The 2nd Platoon, Company C reported seeing what appeared to be a mortar tube blown into the air during the air strike. The fixed wing aircraft conducting the airstrike received sniper fire from the ground during the runs on the target areas. At 051930H one platoon and Command Group from Company C were helilifted from the Combat Base located in vicinity (BT 024343) to NUI LAC SON. Company B was ordered to move to vicinity of NUI LAC SON, to support Company C if NUI LAC SON was attacked. The areas of the artillery fire and airstrikes were searched the following day at first light by Company B. It was estimated the VC sustained 20 VC KIA probable and lost one mortar destroyed by airstrikes and artillery fire conducted in the area.

(29) 051907H Company B located in vicinity (BT 015332) found one dud M-79 round. Round was destroyed in place by engineers.

(30) 060700H Company B in vicinity (BT 010300H) apprehended Vietnamese male, without ID card, about 35 years of age, dressed in grey and black clothing. Detainee had a military type haircut, and what appeared to be old battle wound on his left arm. Detainee had 1400 piasters in his possession. Detainee was forwarded to the combat base; was interrogated by members of 9th ITT. Detainee and 1400 piasters were forwarded to 5th Marines S-2.

(31) 060715H Company C located at NUI LAC SON observed 5 VC with weapons moving approximately 500 meters to the southwest of Company B's position in vicinity of (BT 009300). An artillery mission was called on the VC. Artillery fire was observed by Company C. Company B searched the area with negative results.

(32) 060845H Company B picked up an informer who stated 300 VC had been moving in a northwesterly direction from vicinity (AT 998299) at 060430H. Battalion S-2 rated the information as F-3. Enemy activities had been reported in this area by local Vietnamese, Marine units and air observers.

(33) 060920H Company C received an intelligence report from a Vietnamese male, who had given reliable information in the past that there were 30 VC located in vicinity (BT 042281) and (BT 048284). A 4.2 mortar mission was fired at the VC locations. Area was not searched.

(34) 060920H Company C OP located at NUI LAC SON observed 10 VC wearing black clothing and carrying weapons moving southwest in vicinity of (AT 982300). Mortar and artillery fire was called on the VC. 40 rounds 4.2 HE and 8 rounds 105mm HE were fired on VC's location. Company B searched the area with negative results.

(35) 060925H Company B was directed to continue attack to Objective G and to be prepared to continue attack to Objective D. Refer to Tab (c) to Enclosure (1).

(36) 060930H A MED/DENT CP patrol was conducted in LANH THUONG (5) hamlet, located in vicinity (BT 024346) with 4 PF's providing security for the patrol. 50 Vietnamese civilians were treated at MEDCAP. 21 Vietnamese civilians were treated at DENTCAP. 13 bars of soap were distributed to the villagers.

(37) 060930H The District Chief of Sub Hamlet QUE SON reported to Company C located at NUI LAC SON that approximately 300 NVA were killed on Operation UNION II. He stated that the smell of death was so strong in the area that the local populace were moving to the area of TRUNG BINH and other parts nearer to highway 1. The chief stated that the NVA had anticipated the battle and had assigned body carrying details to haul away the NVA dead and place them in pre-dug caves and grave sites.

(38) 060945H Company B vicinity (BT 996299) received 40 rounds small arms and automatic fire from an estimated 10 unobserved VC vicinity (AT 982300) and (AT 988307). Fire was received from the northwest at a distance of approximately 1000 meters. 60mm mortar fire and artillery fire was called on the VC locations. The area was searched by Company B with negative results.

3-5

UNCLASSIFIED

ENCLOSURE (1)

(39) 061334H Company B vicinity (AT 995310), received 10-15 rounds small arms fire from an unobserved 2-3 snipers vicinity (AT 999308). Fire was received from the southeast at a distance of 300-400 meters. Company B returned fire with 45-50 rounds small arms fire and searched the area with negative results. Results: 1 USMC WIAE.

(40) 061345H Company B vicinity (AT 989308), found what appeared to be the wreckage of an A4 Skyhawk aircraft, a pilots helmet and a 250 pound US bomb. Captain CLAY: VMA 211 was painted on the helmet. The bomb was destroyed in place by engineers. The helmet was forwarded to the 5th Marines S-2.

(41) 061650H Company B vicinity (AT 990312), observed one Vietnamese male in an open area, who started to run when he was challenged. Vietnamese male was about 30 years of age, wore black and green clothing and was carrying a bag. Company B fired approximately 15 rounds small arms fire killing the VC. The body was searched with negative results. The bag contained miscellaneous items of food and clothing. Results: 1 VC KIA confirmed. Captured equipment was forwarded to 5th Marines S-2.

(42) 061800H Intelligence received from CHIEU HOI at Company B's position located in vicinity (BT 023288) revealed that 40 VC were located in vicinity (AT 995276). A scout sniper team observing through a BC scope observed 10 VC dressed in black clothing, carrying packs and rifles moving in vicinity (AT 995276) in groups of two's. 20 4.2mm HE mortar rounds were fired on VC locations with good target coverage. Observer was unable to determine results of fire mission. An AO arrived on station and directed an airstrike on the area. The area was not searched.

(43) 061940H Company B arrived at Objective D. Refer to Tab (c) to enclosure (1).

(44) 062145H Company B located in vicinity (AT 995334) observed one Vietnamese male approaching their position. The Vietnamese was ordered to halt twice in Vietnamese. The Vietnamese failed to respond to the order, he turned around and fled from Company B. Company B fired 5 rounds small arms fire at fleeing VC. The area was searched the following morning with negative results.

(45) 7 June 1967 The laying of triple concertina wire was completed around the Combat Base.

(46) 070630H Company D conducted platoon reinforced patrol in accordance with 1st Battalion, 5th Marines Frag Order 61-67. Refer to Tab (d) to Enclosure (1).

UNCLASSIFIED

(47) 070930H MED/DENT CAP patrol was conducted in Lanh Thang hamlet located in vicinity (BT 024346). 4 PF's provided security for the patrol. 42 Vietnamese civilians were treated at MEDCAP. 6 Vietnamese civilians were treated at DENTCAP. 200 bars of soap were distributed to the villagers.

(48) 070730H Platoon patrol 5B6 while conducting search and destroy operations in vicinity (AT 990329) found one 100 pound US bomb. Engineers destroyed the bomb in place.

(49) 070820H Platoon Patrol 5B6, in vicinity (AT 991333), received 25-30 rounds small arms fire from 5 VC wearing black clothing, and carrying weapons located in vicinity (AT 987333). Fire was received from the west at a distance of approximately 500 meters. Patrol returned 40-50 rounds small arms fire and requested artillery fire. 7 105mm HE rounds were fired on the VC location with good target coverage. The area was searched with negative results. The VC broke contact and fled in an undetermined direction.

(50) 070900H Platoon Patrol 5B6 located in vicinity (AT 990332) received 20-30 rounds small arms fire from an estimated 6 unobserved VC located in vicinity (AT 987333). Fire was received from a westerly direction at a distance of approximately 400 meters. Patrol returned 35-40 rounds small arms fire and requested artillery. 8 rounds of 105mm HE were fired on the VC location with good target coverage. Patrol searched the area with negative results.

(51) 070950H Platoon Patrol 5B6, vicinity (AT 981344), found a tunnel 30 feet long, 5 feet wide and 4 feet high. The tunnel was searched with negative results and tunnel was destroyed by engineers.

(52) 071125H Platoon Patrol 5B6 located in vicinity (AT 991322) observed 5 VC wearing white khaki clothing and carrying weapons located in vicinity (AT 996319). Patrol fired 5 M-79 rounds, 2 LAWs and 25 rounds small arms fire at VC. The VC positions were assaulted and searched by the patrol. Patrol apprehended one detainee, about 25-27 years of age, wearing grey clothing. Detainee had what looked like pack strap marks on his back and shoulders. During interrogation the detainee would not answer questions. Detainee was forwarded to 5th Marines S-2.

(53) 071130H Platoon Patrol 5D1 while conducting security patrol along assigned route found what appeared to be 5 mortar aiming stakes in vicinity (BT 016365). Stakes were 1½ feet long with yellow cloth attached to the stakes. Stakes were laying beside what appeared to be an excellent mortar position in vicinity (BT 015364). Patrol found a cave 45 feet wide, 45 feet long and 10 feet high. Cave was searched and patrol found 1 pair of boots and a hand written book which appeared to be a diary. The cave was destroyed by engineers. Patrol returned to Combat Base at 1400H. Results: 1 cave destroyed, diary, boots and aiming stakes were forwarded to Battalion S-2 for further disposition.

3-7

ENCLOSURE (1)

(54) 071230H Platoon Patrol 5B5 located in vicinity (AT 994346) apprehended 2 Vietnamese males without ID cards. One male was dressed in grey clothing and the other was dressed in black clothing. Detainee dressed in black clothing admitted being a VC when questioned. The other detainee did not answer questions cooperatively. VC and detainee were forwarded to 5th Marines S-2.

(55) 071240H Platoon Patrol 5B5 located in vicinity (AT 986346) found one bear trap approximately 13" long and 6" wide. Bear trap was forwarded to 5th Marines S-2.

(56) 071345H Squad Security Patrol 5D5 located in vicinity (BT 019362) found 1 M-16 anti-personnel mine. Mine was buried in the ground with prong above ground, covered with a black plastic material. Mine was destroyed in place by engineers.

(57) 071440H Company B located in vicinity (AT 982324) observed 2 VC dressed in black clothing and camouflaged, located in vicinity (AT 976338), a distance of approximately 500-600 meters moving to the southwest. One VC was carrying a weapon. Company B fired 25-30 rounds small arms fire at VC killing one VC. Company B searched the area and found one VC KIA and one blood trail which was followed with negative results. The VC KIA was carrying a bag containing miscellaneous medical supplies and a book which appeared to be a tax collectors book. As the area was being searched members of Company B observed 5 VC located approximately 500-700 meters away moving southwest. Scout sniper fired one round small arms fire at VC and observed one VC fall. The other VC were observed running and carrying the VC KIA in a westerly direction. A reconnaissance insert directed 60mm mortar HE and WP fire which was fired by Company B at the fleeing VC. VC were observed placing the VC KIA in a bushy area. Company B searched the area and found the body of VC KIA lying where VC had moved it. Results: 2 VC KIA confirmed, 1 VC WIA probable, bag containing medical supplies and possible tax collector's book was forwarded to 5th Marines S-2.

(58) 071650H Company B arrived at Objective K and was directed to continue attack to Objective A. Refer to Tab (c) to Enclosure (1).

(59) 071840H Company B arrived at Objective A and set in night defensive perimeter. Refer to Tab (e) to Enclosure (1).

(60) 072200H LP 5A8 located in vicinity (BT 024338) heard movement and about the same time received one incoming fragmentation hand grenade which exploded approximately 20 meters from the LP position. No casualties were sustained. Members of the LP were unable to determine the direction and distance from where the hand grenade was thrown. LP was recalled to the Combat Base and was relocated to (BT 025339).

(61) 080520H Company D commenced search and destroy operations toward NUI LAC SON to relieve Company C. Refer to Tab (e) to Enclosure (1).

(62) 080630H Company B arrived at the combat base terminating company search and destroy operation.

(63) 8 June 1967 Four 106mm recoilless rifles were fired to bore sight and zero the weapons. The 106mm recoilless rifles were established as apart of the perimeter defensive fire.

(64) 8 June 1967 A small arms range was established in vicinity of the Combat Base. Right lateral limit of the range is (BT 025337) to (AT 995315); left lateral limit of the range is (BT 026336) to (BT 007311). Range was established for all weapons organic to the Battalion.

(65) 080900H News reporter from BBC arrived at Combat Base to obtain story of Operation UNION II.

(66) 080950H MEDCAP patrol conducted in LANH THUCNG (5) hamlet located in vicinity (BT 024346). 4 RF's provided security for the patrol. 74 Vietnamese civilians were treated at MEDCAP.

(67) 081220H Company D relieved Company C at NUI LAM SON and Company C commenced search and destroy operations moving toward Objective G. Refer to Tab (e) to enclosure (1).

(68) 081510H Company C arrived at Objective G. Refer to Tab (e) to enclosure (1).

(69) 081530H Company C while moving across rice paddy in vicinity (BT 000305) received 15-20 rounds small arms fire from an unobserved sniper located in vicinity (BT 002312). Fire was received from the north at a distance of approximately 500-600 meters. A few minutes later Company C received 25-30 rounds small arms fire from the southwest from an undetermined number of VC located in vicinity (AT 995293) a distance of approximately 1000 meters. Company C returned fire with 250 rounds small arms fire, 4 60mm HE rounds and called for artillery and 81mm mortar fire. 5 105mm HE rounds and 22 81mm HE rounds were fired on VC locations with good target coverage, covering Company C's movement across the rice paddy. VC positions were searched with negative results.

(70) 081640H Company C secured Objective G. Refer to Tab (e) to enclosure (1).

(71) 082035H Company C was directed to continue attack to Objective M at 090500H and be prepared to continue attack to Objective L on order. Objective M was established at (AT 970310). Intelligence indicated that an NVA battalion was located in vicinity (AT 956307).

(72) 09750H Company C arrived at Objective M. Company C was directed to patrol the area within 1000 meters and be prepared to continue the attack on to Objective L at 1050H.

(73) 090930H MEDCAP patrol was conducted in LANH THUONG (5) hamlet located in vicinity (BT 024346). 4 PF's provided security for the patrol. 34 Vietnamese were treated at MEDCAP. 6 bars of soap and pairs of shorts were distributed to the villagers.

(74) 091000H Company C continued attack to Objective L.

(75) 091030H Company B located in vicinity (BT 018346) received 8 rounds small arms fire from an estimated 3 VC located in vicinity (BT 015345). Fire was received from the southwest from a distance of approximately 300 meters. Company B returned fire with 2 M-79 rounds and 20 rounds small arms fire. One VC wearing black clothing fell during the shooting, got up and fell again as if shot. Company B searched the area and apprehended 2 Vietnamese males in area where fire was received and found one blood trail which was followed with negative results. Results: 1 USMC WIA, 1 VC KIA probable. Detainees were forwarded to 5th Marines S-2.

(76) 091055H LtCol HILLBARTNER, the Commanding Officer, 1st Battalion, 5th Marines and Colonel HOUGHENON, the Commanding Officer, 5th Marines departed Combat Base to visit NUI LAC SON.

(77) 091100H Company C located in vicinity (AT 970314) received 30-35 rounds small arms fire from an estimated 3 unobserved VC located in vicinity (AT 970320). Fire was received from the north at a distance of 600 meters. Company C returned fire with 75-100 rounds small arms fire, 4 60mm rounds, 5 M-79 rounds and 2 3.5 inch rocket rounds. At 1340H while moving to search the area, Company C received an additional 10-15 rounds small arms fire from an unobserved VC located in vicinity (AT 970320) and 30 rounds small arms fire from an estimated 5 unobserved VC located in vicinity (AT 968319). Company C swept the area in vicinity (AT 968319) and observed approximately 30 VC in khaki uniforms. The attack was continued and Company C fired an additional 300 rounds small arms fire and 10 M-79 rounds at VC. The area was searched and Company C found 5 VC KIA confirmed and one Chinese 7.62mm type 56 carbine, serial number DA-66, 1 cartridge belt, 1 M-14 magazine pouch, 1 magazine with 16 rounds, one canteen cover and one khaki uniform. Blood trails were found and followed with negative results. It was estimated the VC sustained 6 VC KIA probable, 4 VC WIA probable. The VC broke contact and fled to the west. Results: 5 VC KIA confirmed, 6 VC KIA probable, 4 VC WIA probable. Captured equipment was forwarded to 5th Marines S-2.

(78) 091109H Company C was ordered to search area in vicinity (AT 970320) and continued attack to Objective L.

(79) 091200H 1st Battalion, 5th Marines mess hall was established at Hill 51. The first hot meal was served at noon, consisting of spaghetti, corn, crackers, pears and hot coffee.

(80) 091300H A Vietnamese Civilian named PHAM TRO was brought to the Combat Base by his PF son. The civilian claimed he was shot in both legs by a VC on 7 June 1967. The Battalion Surgeon examined the civilian and recommended he be evacuated. Civilian was evacuated to 1st Hospital Company for further treatment.

(81) 091630H Company C arrived at Objective Q and established night defensive perimeter.

(82) 091915H Platoon Patrol from Company C located in vicinity (AT 997328) apprehended 2 Vietnamese males, approximately 35-40 years old, wearing black clothing and without ID cards. Detainees were forwarded to 5th Marines S-2.

(83) 092030H Company C was directed to continue attack at 100630H to Objective Q and to be prepared to continue attack on order. Objective Q was established at (AT 978342).

(84) 092200H A red alert drill was conducted to determine the alertness of units within the Combat Base.

(85) 100630H Company B commenced search and destroy operation in accordance with 1st Battalion, 5th Marines Frag Order 63-67. Refer to Tab (f) to enclosure (1).

(86) 100825H Platoon patrol 5D1 located in vicinity (AT 999279) received 20 rounds small arms fire from an estimated 4 unobserved VC located in vicinity (AT 997278). Fire was received from the southwest at a distance of approximately 200 meters. Patrol returned fire with 30-40 rounds small arms fire, 3 M-79 rounds and requested artillery fire. 5 rounds 81mm HE rounds were fired on the VC locations. Patrol while searching the area, apprehended one Vietnamese male about 20 years of age, wearing black and white clothing and without an ID card. Detainee was forwarded to the 5th Marines S-2.

(87) 100830H Company B located in vicinity (BT 014343) found a cave 5 feet high, 6 feet long and 6 feet wide. Cave was searched with negative results and destroyed by engineers.

(88) 100840H Company B commenced movement to vicinity (BT 000352).

(89) 100845H Company C located in vicinity (AT 977336) received 8-10 rounds small arms fire from an estimated 3 unobserved VC located in vicinity (AT 976337). Company C returned fire with 30-40 rounds small arms fire. One VC was observed running across a field. An AC observed approximately 30 VC in the area wearing assorted type clothing. An artillery mission and air strikes were conducted in the area. Company C fired an additional 300 rounds small arms fire, 18 M-79 rounds, 10 60mm HE rounds. Company C observed 8 VC being dragged away from the area. Artillery and air coverage was excellent. The area was searched and heavy blood trails and drag marks were found and followed with negative results. Results: 8 VC KIA probable.

(90) 100900H A MED CLF patrol was conducted in Lanh Thuong (5) hamlet located in vicinity (BT 024346). 4 RF's provided security for the patrol. 44 Vietnamese were treated at MED CLF. 20 bars of soap were distributed to the local villagers. 300 pairs of short trousers were distributed to the children of the QUS SOL area.

(91) 100945H Company B located in vicinity (BT 017345) found a cave 16 feet long, 13 feet wide, and 13 feet high. Cave was searched with negative results and destroyed by engineers.

(92) 101010H Company B located in vicinity (BT 011338) found a cave 7 feet long, 7 feet wide and 5 feet high. Cave was searched with negative results and destroyed by engineers.

(93) 101100H Company B located at (BT 017345) found a tunnel complex 3 feet high, 7 feet wide and 500 feet long. Tunnel was constructed with air vents and had three entrances. Tunnel was searched with negative results and destroyed by engineers with 387 pounds of explosives.

(94) 101100H Company B platoon located at (BT 027350) found a tunnel 40 feet long, 4 feet wide and 5 feet high with two entrances. Tunnel was searched with negative results and destroyed by engineers.

(95) 10 June 1967 All Company 1stSgt's arrived at the Combat Base and established functional field company offices.

(96) 101345H Company B located in vicinity (BT 007354) received 3-4 rounds small arms fire from an unobserved sniper located in vicinity (BT 003358). Fire was received from the northwest at a distance of about 400 meters. Company B returned fire with 10-15 rounds small arms fire and searched the area with negative results.

(97) 101430H Company B located in vicinity (BT 004356) found tunnel located under a huge rock. Tunnel was 3 feet wide and 4 feet high and about 13 feet long. The tunnel was searched with negative results and destroyed by engineers.

(98) 101620H Company C returned to the Combat Base terminating S&D operation.

(99) 101910H Company B commenced S&D operations in accordance with 1st Battalion, 5th Marines Frag Order 64-67. See Tab (G) to Enclosure (1).

(100) 102315H Company B was directed to continue attack to Objective S at 0530H and to be prepared to continue the attack on order. Refer to Tab (G) to Enclosure (1).

(101) 102230H Squad ambush 5A12 located in vicinity (BT 016338) heard Vietnamese voices and movement to the front and flank of the ambush position in vicinity (BT 016337). Squad set in a hasty ambush, sprang the ambush, firing approximately 300 rounds small arms fire and 6 M-79 rounds at the VC. VC returned fire with 50-60 rounds small arms fire and 2 frag grenades. With the use of white parachute illumination, the patrol searched the area with negative results. The area was searched again the following morning with negative results.

(102) 110650H Company B secured Objective S. Refer to Tab (G) to Enclosure (1).

(103) 110700H Reinforced platoon from Company A commenced security patrol in accordance with 1st Battalion, 5th Marines Frag Order 65-67. Refer to Tab (H) to Enclosure (1).

(104) 110710H Company B departed Objective S moving to Objective T. Refer to Tab (G) to Enclosure (1).

(105) 110730H Company B secured Objective T. Refer to Tab (G) to Enclosure (1).

(106) 110850H Company B located in vicinity (BT 047374) received one round sniper fire from an unobserved sniper located in vicinity (BT 049376). Company B returned fire with 10 rounds small arms fire and searched the area with negative results.

(107) 110945H Company B squad patrol located in vicinity (BT 053373) apprehended 4 Vietnamese males, with ages ranging from 14-35 years of age. 3 detainees were wearing black and white clothing. One detainee was dressed in brown and black clothing and was apprehended trying to run out the back door of a hut. 3 detainees had no ID cards. All detainees had vaccination marks and what appeared to be pack strap marks on their shoulders and back. Detainees were forwarded to 5th Marines S-2.

(108) 110950H Company B located in vicinity (BT 043373) observed 4 V with weapons, wearing black clothing moving in a northwest direction in vicinity (BT 043378). Company B fired 40-50 rounds small arms fire and 3 M-rounds at the VC. VC fled into heavy undergrowth. The area was searched with negative results.

(109) 111200H The first mobile PX at the Combat Base was set up in the Battalion Mess Hall from 1200-1500.

(110) 111215H Company A platoon patrol located in vicinity (BT 06036) were informed by local police that 16 VC were located in vicinity (BT 066367). Led by the local police, Company B searched the area. One VC was sighted and was killed when he attempted to flee. 4 Vietnamese were apprehended, 2 males and 2 females. All detainees were identified as VC by local Vietnamese authority. VCC were forwarded to 5th Marines S-2.

(111) 11 June 1967 The S-5 Officer made arrangements with the local civilians where as they would receive all trash and wet garbage from the combat base in return for their services in construction of a chapel and providing timber which would be utilized to build field fortifications.

UNCLASSIFIED

(112) 111800H Squad security patrol 5B3 located in vicinity (BT 055375) found one pair of green trousers, one white shirt, medicine bottles and documents. The Kit Carson Scout identified the documents as some sort of pay roster or tax collectors notes. All items found were forwarded to the Battalion S-2 for further disposition.

(113) 111900H Reinforced platoon from Company A returned to the Combat Base. Refer to Tab (H) to Enclosure (1).

(114) 12 June 1967 Engineers commenced clearance of ground for a Combat Operation Center. 1400 pounds of explosives were utilized to blow a hole for the foundation.

(115) 12 June 1967 GP tents were erected to house supply, S-5 Special Services, S-1 and one tent for each company.

(116) 120900H A MEDCAP patrol was conducted in Lang Thuong (5) hamlet located in vicinity (BT 024346). 4 PF's provided security for the patrol. 26 Vietnamese civilians were treated at MEDCAP.

(117) 121105H Colonel WOESSNER, 1st Marine Division Chief of Staff visited NUI LAC SON.

(118) 121200H Lead elements of Company B located in vicinity (BT 015367) observed 5 VC wearing black clothing, and carrying weapons and packs. When VC spotted the Marines, they fled in a southerly direction. Company B fired 75 rounds small arms fire and 10 M-79 rounds at the fleeing VC. Company B pursued the VC but could not maintain contact. The VC returned no fire and continued to flee in a southerly direction. The area was searched with negative results.

(119) 121330H Company B while conducting search of the area in vicinity (BT 022364) found assorted medical items which were forwarded to 5th Marines S-2.

(120) 121400H Company B located in vicinity (BT 018384) apprehended one Vietnamese male, about 35 years of age, without an ID card, wearing black clothing. Detainee had old shrapnel wounds on his left thigh. When questioned, the detainee revealed that 20 VC operated in the local area and gave names of the VC guerrillas. VCC was forwarded to the 5th Marines S-2.

(121) 121500H Company B moved to search the area in vicinity of (BT 019388). An AO had observed 6-8 VC in the area and called artillery fire on the VC. Company B searched the area with negative results.

(122) 122100H Company D was directed to conduct a reinforced platoon patrol from Combat Base located (BT 023288) to Objective A, established at (AT 982788). The patrol was to locate trails, routes of possible movement and become familiar with the area.

(123) 122135H Company B was directed to continue the attack at 130530H along axis of advance from present position to (BT 015375) to (BT 004370) to (BT 010357) to (BT 020343) to the Combat Base.

(124) 130525H Company B commenced S&D operations to the Combat Base.

(125) 130530H 1st Platoon, Company D commenced S&D operations.

(126) 130815H Company B located in vicinity (BT 019360) found a cave 10 feet wide, 10 feet long and 3 feet high. Cave was searched with negative results and destroyed by engineers.

(127) 130830H Platoon patrol 5D1 located in vicinity (AT 998288) received 30-40 rounds small arms fire from an estimated 30-40 VC, wearing black clothing and carrying weapons located in vicinity (AT 996290) to (AT 994291). Platoon returned fire with 100-150 rounds small arms fire and called artillery and air strikes on the enemy positions. At 131250H the patrol searched the area and found 3 male bodies, which had been hit by napalm. A continued search of the area revealed one blood trail which was followed with negative results. Results: 3 VC KIA confirmed, 1 VC KIA probable.

(128) 130854H Company B arrived at the Combat Base terminating S&D operations.

(129) 130923H Colonel P. L. HILGARTNER, Commanding Officer, 1st Battalion, 5th Marines departed Combat Base to visit NMI LAC SON.

(130) 130930H MEDCAP patrol was conducted in Lanh Thuong (5) hamlet located in vicinity (BT 024346). 4 PF's provided security for the patrol. 36 Vietnamese civilians were treated at MEDCAP.

(131) 131410H Company A commenced S&D operations in accordance with 1st Battalion, 5th Marines Frag Order 66-67. Refer to Tab (I) to Enclosure (1).

(132) 131600H Company A located in vicinity (BT 011338) received 20 rounds small arms fire from an estimated 3-4 unobserved VC located in vicinity (BT 008332). Company A returned fire with 50-100 rounds small arms fire 3 60mm HE rounds. The VC broke contact and fled in an undetermined direction. The area was searched with negative results.

(133) 132000H Company A was directed to send one platoon into Sector II to search for prisoners, using a detainee as a guide; and one to continue search into Sector I depending on TOR of 1st platoon and have one platoon standing by as a Reaction Force.

UNCLASSIFIED

(134) 140615H 1st Battalion, 5th Marines mess hall served its first breakfast. Presently the messhall is serving two meals per day.

(135) 140700H Company A located in vicinity (AT 992332) observed four VC in khaki uniforms approximately 300 meters to the northwest in vicinity (AT 980330). Company A fired 50-100 rounds small arms fire at VC and searched the area with negative results. One Vietnamese woman about 30 years old without ID card, wearing black clothing was apprehended. Detainee was forwarded to 5th Marines S-2.

(136) 140915H Lt. Colonel P. L. HILGARDNER, Commanding Officer 1st Battalion, 5th Marines, departed the Combat Base and conducted a visit of 1st Battalion, 5th Marines personnel admitted to the 1st Hospital Company, Chu Lai.

(137) 140930H A MEDCAP patrol was conducted in Lanh Thuong (5) hamlet. 4 PF's provided security for the patrol. 39 Vietnamese civilians were treated at MEDCAP. Army Civic Action personnel accompanied the patrol to conduct a civic action survey to familiarize them with the Que Son area.

(138) 141140H Company A located in vicinity (AT 982335) received 15-20 rounds small arms fire from the west from one VC dressed in black clothing located in vicinity (AT 975335). Company A sustained 3 casualties. Company A returned fire with 40-50 rounds small arms fire. The sniper was observed to fall as if hit. At 1430H, while helicopters were effecting a medical evacuation for Company A, 30-40 rounds small arms fire were received from the west. Company A returned 40-50 rounds small arms fire and maneuvered into position to assault and search the area where sniper fire was received. The area was searched with negative results. Results: 1 USMC WIAE, 1 USMC WIANE and 1 VC WIA probable.

(139) 141255H Platoon Patrol 5D1 located in vicinity (AT 996288) received 10-20 rounds small arms fire from an undetermined number of VC located in vicinity (AT 995284). Patrol returned 70-80 rounds small arms fire, 5 M-79 rounds and requested artillery fire. 6 rounds 105mm HE were fired on the VC positions with excellent target coverage. The area was searched with negative results.

(140) 141545H Platoon patrol 5D1 returned to NUI LAC SON terminating S&D operation.

(141) 141620H Company A located in vicinity (AT 980336) received 20-30 rounds small arms fire from an estimated 3-4 unobserved VC located in vicinity (AT 984335). Company A returned fire with 50-60 rounds small arms fire and 10 60mm HE rounds. VC fire ceased and the area was searched with negative result.

(142) 141700H Squad security patrol 5G7 located in vicinity (BT 025352) found one dud 155mm HE round. Dud was destroyed in place by engineers.

(143) 142235H Company A was directed to continue advance to Objective B at 150500H. Objective B was established at (AT 990350); Objective C was established at (AT 989325).

ENCLOSURE (1)

(144) 150100H Fire team combat outpost 5E&S7 located in vicinity (BT 025346) received 2 rounds small arms fire from an unobserved sniper located in vicinity (BT 024349). Fire was received from the north at a distance of approximately 300 meters. Illumination was provided and COP observed 2 Vietnamese males fleeing in a northerly direction. COP fired 5-10 rounds small arms fire at fleeing VC. The area was searched at 150600H with negative results. COP was directed to return to the combat base.

(145) 150500H Company A commenced attack on Objective B.

(146) 150620H Scout sniper team attached to Company A in vicinity (AF 982347) observed one VC, dressed in black clothing, running in a treeline. The VC was located approximately 200 meters to the southeast from the scout sniper's position in vicinity (AF 987346). Scout sniper fired one round and killed the VC. The VC's body was searched and a lighter with an imprint 403 was found. VC was about 30 years of age, and had what appeared to be pack strap marks on his shoulder and back. Results: 1 VC KIA confirmed. Lighter was forwarded to 5th Marines S-2.

(147) 15 June 1967. U. S. Army Civic Action Team visited villages between QUE SON and LANH THUONG (5) hamlet, to conduct a survey to determine what Civic Action Program could be established for the local populace.

(148) 150810H Village Chief reported to the Combat Base located at NUI LAG SON that H&I fires fired the previous night in vicinity (BT 049291) had killed 3 VC. Results: 3 VC KIA confirmed.

(149) 150900H A MEDCAP patrol was conducted in LANH THUONG (5) village located in vicinity (BT 024346). 4 PF's provided security for the patrol. 27 Vietnamese civilians were treated at MEDCAP.

(150) 150900H U.S. Army Civil Affairs Survey Team and the Battalion S-5 conducted a survey in hamlets located between QUE SON village located in vicinity (BT 040345) and LANH THUONG (5) village, located in vicinity (BT 025346) in order to gain information concerning living conditions and problems of the Vietnamese people in the area.

(151) 151130H Security patrol 5 Yankee 10, while conducting a routine security patrol in LANH THUONG (5) hamlet located in vicinity (BT 023344) apprehended 5 Vietnamese civilians, 1 male and 4 females. The 5 Vietnamese civilians were pointed out by hamlet police and ARVN personnel as being VC associated. The Battalion S-2 officer interrogated the detainees and one detainee revealed that 2 VC were in LANH THUONG (5) hamlet during the hour of 142000H and 142200H with intentions of gaining information of Marine activities conducted within the combat base. It was further revealed that all detainees had relatives who were active VC. VCC were forwarded to 5th Marines S-2.

(152) 151130H A reconnaissance insert observed 10 VC with 5 weapons, located in vicinity (AF 982352) moving toward Company A's position, located in vicinity (AF 991315). VC were moving southeast and were approximately 800 meters from Company A's position. Company A continued to move in a south west direction. At 151230H Company A in vicinity (AF 987347) received approximately 10 rounds small arms fire from 3-4 observed VC wearing black clothing, located in vicinity (AF 985348). Fire was received from the northwest at a distance of 300-400 meters. Company A returned fire with 50-75 rounds small arms fire. The VC broke contact and fled to the west through thick brush. Company A pursued the VC, but could not regain contact. The area was searched with negative results.

ENCLOSURE (1)

(153) 151200H Squad security patrol 5B13 located in vicinity (BT 016-335) found 2 VC homemade gas masks. Gas masks were forwarded to 5th Marines S-2.

(154) 151519H From 151519H to 242400H June 1967, the 1st Battalion, 5th Marines participated in Operation ADAIR. Refer to Tab (k) to enclosure (1).

(155) 160900H U.S. Army Civic Action Team completed its survey in the QUE SON area and departed the combat base.

(156) 201010H A U.S. Army Psy-War team arrived at the Combat Base to conduct Psy-War operations in the area adjacent to the combat base.

(157) 210930H A MEDCAP patrol was conducted in LAMH THUONG (5) hamlet, located in vicinity (BT 024346). 4 PF's provided security for the patrol. 17 Vietnamese civilians were treated at MEDCAP.

(158) 211600H Major General ROBERTSON, Commanding General, 1st Marine Division visited NUI LAM SON and the Combat Base.

(159) 220930H A MEDCAP patrol was conducted in LAMH THUONG (5) hamlet located in vicinity (BT 024346). 4 PF's provided security for the patrol. 36 Vietnamese civilians were treated at MEDCAP.

(160) 230930H A MEDCAP patrol was conducted in LAMH THUONG (5) hamlet. 4 PF's provided security for the patrol. 25 Vietnamese civilians were treated at MEDCAP.

(161) 230930H MEDCAP patrol was conducted in LAMH THUONG (5) Hamlet, located in vicinity (BT 024346). 4 PF's provided security for the patrol. 25 Vietnamese civilians were treated at MEDCAP.

(162) 241020H LTCOL P. L. HILGARTNER, Commanding Officer, 1st Battalion 5th Marines departed Combat Base for NUI LAM SON to greet the ADC, 1st Marine Division.

(163) 241120H ADC, 1st Marine Division visited Combat Base, accompanied by the Commanding Officer, 1st Battalion, 5th Marines.

(164) 241530H Commanding Officer, 5th Marines, S-2 Officer and S-3 Officer from Regimental Headquarters arrived to discuss Operation CALHOUN.

(165) 241700H An awards and promotion ceremony was conducted at the 1st Battalion, 5th Marines Combat Base. Colonel HOUGHTON was the reviewing officer and presented 1 Bronze Star Medal, 2 Vietnamese Cross of Gallantry and 15 Purple Heart medals to members of the command. Following the awards presentation, LTCOL HILGARTNER meritoriously promoted 3 members of the command to sergeant. Colonel HOUGHTON assisted in pinning on the rank insignia of the Marines promoted.

(166) 242400H Operation ADAIR was terminated. Refer to Tab (k) to Enclosure (1).

(167) 25 June 1967. From 250001H June 1967 to 302400H June 1967, 1st Battalion, 5th Marines participated in Operation CALHOUN. Refer to Tab (1) to enclosure (1).

(168) 260930H MEDCAP patrol was conducted in LAMH THUONG (5) hamlet, located in vicinity (BT 024346). 35 Vietnamese civilians were treated at MEDCAP. A two room hut was constructed by Vietnamese for use by the daily MEDCAP.

ENCLOSURE (1)

(169) 200930H MEDCAP patrol was conducted in LAMH THUONG (5) Hamlet, located in vicinity (BT 024346). 4 PF's provides security for the patrol. 29 Vietnamese civilians were treated at MEDCAP.

(170) 280805H Psychological Operations team conducted a Psy-War broadcast from vicinity (BT 025352) to vicinity (BT 0235) to (BT 0135) and surrounding area. Theme was CHI LU HOI appeal. Length of broadcast was 1½ hours.

(171) 280900H MEDCAP patrol conducted in LAMH THUONG (5) Hamlet, located in vicinity (BT 024346). 4 PF's provides security for the patrol. Vietnamese were treated at MEDCAP.

(172) 290930H MEDCAP patrol conducted in LAMH THUONG (5), Hamlet, located in vicinity (BT 024346). 4 PF's provided security for the patrol. 32 Vietnamese civilians were treated at MEDCAP.

(173) 300930H MEDCAP patrol conducted in LAMH THUONG (5), Hamlet, located in vicinity (BT 024346). 4 PF's provided security for the patrol. 4 Vietnamese civilians were treated at MEDCAP.

(174) 302400H 1st Battalion, 5th Marines continued participation in Operation CAMELHORN.

DECLASSIFIED

PART IV

SUPPORTING DOCUMENTS

- ✓ Tab A 1st Battalion, 5th Marines After Action Report Operation "UNION II"
- ✓ Tab B 1st Battalion, 5th Marines Frag Order 51A-67
- ✓ Tab C 1st Battalion, 5th Marines Frag Order 59-67
- ✓ Tab D 1st Battalion, 5th Marines Frag Order 61-67
- ✓ Tab E 1st Battalion, 5th Marines Frag Order 62-67
- ✓ Tab F 1st Battalion, 5th Marines Frag Order 63-67
- ✓ Tab G 1st Battalion, 5th Marines Frag Order 64-67
- ✓ Tab H 1st Battalion, 5th Marines Frag Order 65-67
- ✓ Tab I 1st Battalion, 5th Marines Frag Order 66-67
- ✓ Tab J 1st Battalion, 5th Marines After Action Report Operation "DAIR"

DECLASSIFIED (1)

~~UNCLASSIFIED~~

HEADQUARTERS
 1st Battalion, 5th Marines
 1st Marine Division (Rein) FMF
 FPO, San Francisco, 96602

3/CHB/glk
 3480
 16 June 1967

~~SECRET~~

00183-67

From: Commanding Officer
 To: Commanding General, 1st Marine Division
 Via: Commanding Officer, 5th Marines

COPY 19 OF 48 COPIES

Subj: Combat After Action Report, Operation "UNION II"

Ref: (a) DivO 3480.1
 (b) 5th Marines Frag Order 28-67
 (c) 5th Marines Frag Order 29-67
 (d) 5th Marines Frag Order 30-67
 (e) 5th Marines Frag Order 31-67
 (f) 5th Marines Frag Order 32-67
 (g) 5th Marines Frag Order 34-67
 (h) 5th Marines Frag Order 35-67
 (i) 5th Marines Frag Order 36-67
 (j) 5th Marines Frag Order 37-67
 (k) 5th Marines Frag Order 38-67

Encl: (1) 1st Battalion, 5th Marines Frag Order 47-67
 (2) Operation and Night Disposition Overlay D-Day
 (3) Operation and Night Disposition Overlay D+1
 (4) 1st Battalion, 5th Marines Frag Order 48-67
 (5) 1st Battalion, 5th Marines Frag Order 49-67
 (6) Operation and Night Disposition Overlay D+2
 (7) Operation and Night Disposition Overlay D+3
 (8) 1st Battalion, 5th Marines Frag Order 50-67
 (9) 1st Battalion, 5th Marines Frag Order 52-67
 (10) Operation and Night Disposition Overlay D+4
 (11) 1st Battalion, 5th Marines Frag Order 53-67
 (12) Operation and Night Disposition Overlay D+5
 (13) 1st Battalion, 5th Marines Frag Order 54-67
 (14) Operation and Night Disposition Overlay D+6
 (15) 1st Battalion, 5th Marines Frag Order 55-67
 (16) 1st Battalion, 5th Marines Frag Order 56-67
 (17) Operation and Night Disposition Overlay D+7
 (18) Operation and Night Disposition Overlay D+8
 (19) Operation and Night Disposition Overlay D+9
 (20) 1st Battalion, 5th Marines Frag Order 57-67
 (21) 1st Battalion, 5th Marines Frag Order 58-67
 (22) Operation Overlay D+10

DOWNGRADED AT 3 YEAR INTERVALS,
 DECLASSIFIED AFTER 12 YEARS.
 DOD DIR 5200.10

~~DECLASSIFIED~~

UNCLASSIFIED

1. Code Name.

Operation "UNION II" (Search and Destroy)

2. Dates of Operation.

260001H May 1967 to 051800H June 1967

3. Location. From 26-30 May 1967, the Battalion participated in Operation UNION II in the central part of the Son District, Quang Nam Province, RVN. On 30 May 1967, the Battalion was helicopter lifted from the combat base (BT 025343) to LZ Robin (BT 012210), located in the northeast part of Tien Phuoc District, RVN. The Battalion commenced a coordinated attack in a northeasterly direction from the LZ into the northwest portion of the Tam Ky District, RVN around the eastern side of Nui Da Ngua (BT 165267) to a northwesterly direction through Thang Binh District, Quang Tin Province, RVN, to combat base located in the Son District, Quang Nam Province, RVN.

4. Control or Command Headquarters.

1stBn, 5thMar (-)(Rein)	LTCOL P. L. HILGARTNER
H&S Co, 1stBn, 5thMar (-)(Rein)	CAPT G. L. MCKAY (Acting)
Co A, 1stBn, 5thMar (-)(Rein) (26May-2Jun67)	CAPT R. G. BABICH
Co A, 1stBn, 5thMar (-)(Rein) (3-5Jun67)	CAPT B. K. BRODIE
Co C, 1stBn, 5thMar (-)(Rein) (26-29Jun67)	CAPT R. J. CASWELL
Co D, 1stBn, 5thMar (-)(Rein) (30May-5Jun67)	1STLT D. L. MCINTURFF
Co F, 2ndBn, 5thMar (-)(Rein) (27May-2Jun67)	CAPT J. A. GRAHAM
Co F, 2ndBn, 5thMar (-)(Rein) (2-5Jun67)	2NDLT W. A. TIGHT

5. Task Organization.

1stBn, 5thMar (-)(Rein)	LTCOL P. L. HILGARTNER
<u>H&S Co, 1stBn, 5thMar (-)(Rein)</u>	CAPT G. L. MCKAY (Acting)
<u>H&S Company (-)</u>	
Det, 81mm Mortar Plt	
Det, Med Plt	
Det, Comm Plt	
Kit Carson Tm	
ARVN Ln Off	
Det, Co B, 1stSPBn	
Det, Co B, 1stEngrBn	
Det, Btry D, 2ndBn, 11thMar	
Det, Hq Co, 5thMar (Scout Sniper Tm)	

DECLASSIFIED

UNCLASSIFIED

Company A (-)(Rein) (26May-2Jun67)

CAPT R. G. BABICH

Company A (-) (3-5Jun67)

CAPT B. K. BRODIE

Det, Co B, 1stSPBn

Det, Co B, 1stEngrBn

Det, Btry D, 2ndBn, 11thMar

Det, H&S Co, 1stBn, 5thMar

Det, 81mm Mortar Plt (FO Tm)

Det, Comm Plt

Det, Med Plt

Det, FAC Tm

S-2 Scout

Kit Carson Tm

Det, Hq Co, 5thMar (Scout Sniper Tm)

Company C (-)(Rein) (26-29May67)

CAPT R. J. CASWELL

Company C (-)

Det, Co B, 1stSPBn

Det, Co B, 1stEngrBn

Det, Btry D, 2ndBn, 11thMar

Det, H&S Co, 1stBn, 5thMar

Det, 81mm Mortar Plt (FO Tm)

Det, Comm Plt

Det, Med Plt

Det, FAC Tm

S-2 Scoute

Kit Carson Tm

Det, Hq Co, 5thMar (Scout Sniper Tm)

Company D (-)(Rein) (30May-5Jun67)

1STLT D. L. MCINTURFF

Company D (-)

Det, Co B, 1stSPBn

Det, Co B, 1stEngrBn

Det, Btry D, 2ndBn, 11thMar

Det, H&S Co, 1stBn, 5thMar

Det, 81mm Mortar Plt

Det, Comm Plt

Det, Med Plt

Det, FAC Tm

S-2 Scout

Kit Carson Tm

Det, Hq Co, 5thMar (Scout Sniper Tm)

Company E, 2ndBn, 5thMar(-)(Rein) (27May-2Jun67)

CAPT J. A. GRAHAM

Company E (-)

(2-5Jun67)

2NDLT W. A. TIGHT

Det, Co B, 1stSPBn

Det, Co B, 1stEngrBn

Det, Btry E, 2ndBn, 11thMar

Det, H&S Co, 2ndBn, 5thMar

Det, 81mm Mortar Plt

Det, Comm Plt

Det, Med Plt

Det, FAC Tm

S-2 Scoute

Kit Carson Tm

Det, Hq Co, 5thMar (Scout Sniper Tm)

UNCLASSIFIED
DECLASSIFIED

6. Supporting Forces.

A. Air.

(1) During period of 26-29 May 1967, no fixed wing aircraft were utilized. Air Force and Marine A/O's were utilized daily throughout the period.

(2) On the morning of D+4, 12 fixed wing aircraft conducted a preplanned LZ preparation of LZ Robin located in vicinity coordinates (BT 100210). Strike was controlled by a Marine TAC/A in support of debarking 1st Battalion, 5th Marines units in vicinity coordinates (BT 100200). Strike was controlled and supported by a four plane flight of Marine UH1E gunships. The strike effectively suppressed moderate sniper fire that was being received from the area. Two A4 aircraft struck enemy sniper positions in vicinity coordinates (BT 124225) which was hindering the advance of Company F. The enemy fire was suppressed. The strike was controlled directly by Company F's FAC Team. One of the A4 aircraft collided with the ground during his second run on the target. Cause of the accident was undetermined.

(3) On D+5 and D+6 Marine and Air Force observation aircraft were utilized extensively by advancing 1st Battalion, 5th Marines units. On D+7 two F-8 and two F-4 aircraft conducted a close air support strike on fortified enemy positions in vicinity coordinates (BT 123324) in support of Company D. The strike was controlled by an Air Force TAC/A in an O1 aircraft. Result of these air strikes was one KBA, confirmed. Four A-4 aircraft conducted a close air support strike at vicinity coordinates (BT 115325) against enemy positions that were hindering the advance of Companies D and F. Five houses were destroyed and 1st Battalion, 5th Marines units were able to sweep the area. The air strikes were conducted by a Marine TAC/A in an O1 type aircraft. During the night of D+7 and morning of D+8, six flights of F-4's, six flights of F-8's and four flights of A-4's conducted continuous air strikes against heavily fortified enemy positions, which were located between vicinity coordinates (BT 095324) and (BT 086318). The strikes were flown in support of Companies D and F which were engaged with a large enemy force. The strikes were controlled by an Air Force C-47 DRAGON SHIP and Marine UH1E gunships. Coordinating instructions and enemy/friendly position reports were supplied by the Company D FAC. During intervals when fixed wing aircraft was not on station, the DRAGON SHIP strafed the target area. One small fortified village was completely destroyed. 5th Marines AIO response to 1st Battalion, 5th Marines immediate requests for tactical air support on D+7 and D+8 was considered to be outstanding. The timeliness and effectiveness of the fixed wing air support provided to 1st Battalion, 5th Marines units contributed directly to the successful accomplishment of the Battalion's mission.

B. Artillery.

(1) Artillery support until D+5 of UNION II was provided by Battery D, 2nd Battalion, 11th Marines. As 1st Battalion, 5th Marines continued the advance on D+5, support shifted to Battery W, 2nd Battalion, 11th Marines. Battery D, 2nd Battalion, 11th Marines again assumed the role as direct support on D+8 and continued to support 1st Battalion, 5th Marines until the conclusion of the operation. Operation "UNION II" was characterized by extensive use of preparation fires. The preparations were very effective and contributed to a noticeable lack of sniper harassment. Observed missions

DECLASSIFIED

~~SECRET~~

during the first 8 days of Operation UNION II were few due to insufficient target areas. On D+8 Battery D supported 1st Battalion, 5th Marines by firing continuous concurrent missions for Companies A, D, and F from 1100H until dark, with excellent effect on the target areas.

(2) H&I fires were used nightly during UNION II on avenues of approach, mortar positions, assembly areas, harbor sites, areas of known VC activity, and routes of communication and resupply.

(3) A total of 267 such areas were denied use to the VC. Artillery support for Operation UNION II was excellent and contributed significantly to the overall success of the 1st Battalion, 5th Marines.

C. Engineer.

(1) Engineer support for Operation UNION II was provided by the 1st Platoon, Company "B", 1st Engineer Battalion attached to the 1st Battalion, 5th Marines.

(2) On 4 June 1967 three separate caves and one tunnel complex were destroyed by the engineers in the vicinity (BT 108316). All caves were approximately 6 feet deep and 3-4 feet high extending 15 feet, 20 feet and 50 feet into the ground. The tunnel complex was 96 feet long and 3 to 5 feet high with wooden planks for decking.

(3) A total of 25 pounds of C-4 demolitions and 688 pounds of cratering charges were used to destroy these caves and the 29 ordinance items listed in paragraph 11e.

7. Intelligence.

a. Estimate of VC Strength, Location, and Disposition in the Objective Area.

(1) Forces anticipated in the immediate area.

<u>UNIT</u>	<u>LOCATION</u>	<u>STRENGTH</u>	<u>TACTICAL DISPOSITION</u>
3rd NVA Regt	BT 095315	2,000	Highly trained and well disciplined

(2) Intelligence was initially provided to this unit by the 5th Marine Regiment and 1st Marine Division PREINTREP 5-67.

b. Enemy Strength and Situation actually determined during the operation.

(1) Estimate of actual strength was determined to have been about 2,000 men including VC and NVA units.

(2) The cadre and soldiers displayed a high degree of self sufficiency and appeared ready to put forth a determined defense.

c. VC/NVA Units Identified.

(1) 3rd NVA Regiment.

d. Significant Intelligence Gained.

DECLASSIFIED

~~SECRET~~

- (1) It was discovered that the Vietnamese populace were friendly and of a cooperative nature when approached for information but at times were hesitant to volunteer information in apparent fear of VC reprisal.
- (2) The suspects captured displayed obvious fear when approached by Marines.
- (3) Interrogation of detainees indicated a strong VC infrastructure, consisting of Youth, Farmers, and Womens Associations.
- (4) The enemy employed a chemical irritant agent.
- (5) The objective of this operation was to fix and destroy VC forces and supplies in the objective area.

e. Terrain.

- (1) Critical Terrain Features.
 - (a) Hill 242 (BT 128226)
 - (b) Hill 123 (BT 165234)
 - (c) Hill 63 (BT 083325)
- (2) The terrain in the objective area of Thang Binh Valley is composed of paddyland surrounded by densely forested mountains with elevations of 100 to 479 meters. Paddyland was interspersed with hills thickly covered with brush.
- (3) Obstacles. Few rivers and streams traverse the objective area and did not present any major problems.
- (4) Avenues of Approach. Trails in the operational area were good to excellent for foot troops.
- (5) Cross Country Movement. No unusual problems were encountered.

f. Weather.

- (1) Throughout the operation, weather was characterized by partly cloudy skies and for the most part, unrestricted visibility.

8. Assigned Mission.

- (1) To conduct search and destroy operations in area of operation to capture or destroy enemy forces and supplies located therein.

9. Concept of Operation.

- (1) The 1st Battalion, 5th Marines establishes blocking positions east

~~SECRET~~
DECLASSIFIED

~~SECRET~~

of valley in vicinity coordinates (BT 067396) to vicinity coordinates (BT 055384), prepared to continue attack on order. Conducts combat patrols between combat base located at (BT 025347) Hill 51 and east west grid line 31 on D-Day.

10. Execution.

a. D-1. 25 May 1967

(1) 251920H 1st Battalion, 5th Marines received 5th Marines Frag Order 28-67 committing the 1st Battalion, 5th Marines to Operation UNION II. See reference (b).

(2) 252130H 1st Battalion, 5th Marines Frag Order was promulgated to all subordinate units. See enclosure (1).

b. D-Day 26 May 1967 (See enclosure (2)).

(1) 260001H At H-6 1st Battalion, 5th Marines units departed combat base to establish blocking positions in accordance with 5th Marines Frag Order 28-67 and as directed by 1st Battalion, 5th Marines Frag Order 47-67. See reference (b) and enclosure (1).

(2) 260530H Units of the 1st Battalion, 5th Marines were established in blocking positions in vicinity coordinates (BT 067396) and (BT 055384).

(3) 260615H Platoon Patrol 5B2 departed combat base on established patrol route in accordance with 1st Battalion, 5th Marines Frag Order 47-67.

(4) 260900H Platoon Patrol 5B2 arrived at checkpoint N.

(5) 260925H Platoon Patrol 5B2 arrived at checkpoint 31.

(6) 261203H Platoon Patrol 5B2 located in vicinity coordinates (BT 044310) apprehended two Vietnamese males, ages 30-35 years old, wearing black clothing running across a rice paddy toward patrol. Detainees were returned to the combat base for questioning and were forwarded to 5th Marines S-2.

(7) 261420H Platoon Patrol 5B2 arrived at checkpoint 1.

(8) 261453H Platoon Patrol 5B2 arrived at checkpoint 3.

(9) 261615H Platoon Patrol 5B2 returned to combat base.

(10) 261615H Company C squad patrol entered hamlet vicinity coordinates (BT 050396) and observed 2 Vietnamese males and 1 female fleeing from the hamlet in a northwest direction. All three were dressed in black clothing, and were approximately 25 years of age. Patrol ordered Vietnamese to halt three times. When Vietnamese failed to halt, Marines fired three rounds small arms fire and two M-79 rounds at Vietnamese wounding the female in the buttocks. A thorough search was conducted for the two males with negative results. The female detainee received first aid for shrapnel wounds, and was forwarded to 5th Marines S-2.

(11) 261700H Company C located vicinity coordinates (BT 066393) observed one Vietnamese male, age 33 dressed in black clothing and straw hat leave a trail and return several moments later carrying a pack. The Vietnamese was apprehended and searched. The detainee and the following equipment

DECLASSIFIED

~~SECRET~~

was forwarded to 5th Marines S-2; one pack, assorted clothing, food, pills, hammock, papers and documents.

(12) 261800H Company C squad patrol located in vicinity coordinates (BT 072397) observed one Vietnamese male age 40 dressed in black and white clothing running in a northwest direction approximately 45 meters from patrol. Patrol apprehended the Vietnamese male. The detainee was questioned by the Battalion S-2 and forwarded to 5th Marines S-2.

(13) 262015H Company A squad patrol 5A5 while moving into position vicinity coordinates (BT 037387) observed 3 Vietnamese following approximately 25 meters to the rear. The rear point fired 3 rounds small arms fire at Vietnamese and observed one Vietnamese fall and get up. All three Vietnamese fled in a westerly direction. Patrol activity altered their positions and set in for the night. Patrol conducted a detailed search of the area at 272100H with negative results. Results: 1 VC WIA probable.

(14) 262100H 1st Battalion, 5th Marines night defensive perimeter and activities were established. See enclosure (2).

c. D+1. 27 May 1967 (See enclosure (3).)

(1) 270400H 1st Battalion, 5th Marines received 5th Marines Frag Order 29-67. See reference (c).

(2) 270600H 1st Battalion, 5th Marines Frag Order 48-67 was promulgated to all subordinate units. See enclosure (4).

(3) 271025H 1st Battalion units commenced S&D operation in accordance with 1st Battalion, 5th Marines Frag Order 48-67. See enclosure (4).

(4) 271131H 1st Battalion, 5th Marines secure Objective D and E. Units patrolled and screened Phase Line White from vicinity coordinates (BT 060360) to (BT 080390).

(5) 271515H Company C Outpost located in vicinity coordinates (BT 074377) observed 3 VC with weapons dressed in gray clothing moving in a northeast direction at a range of approximately 300 meters in vicinity coordinates (BT 077375). Outpost fired 100 rounds of small arms fire at VC. A squad searched the area with negative results.

(6) 271640H Resupply for 1st Battalion, 5th Marines completed.

(7) 271830H OPCON of Company F was passed from 2nd Battalion, 5th Marines to 3rd Battalion, 5th Marines.

(8) 272100H 1st Battalion, 5th Marines night defensive perimeter and activities were established. See enclosure (3).

(9) 272330H 1st Battalion, 5th Marines received 5th Marines Frag Order 30-67. See reference (d).

d.. D+2, 28 May 1967. (See enclosure (6).)

(1) 280830H Company F, 2nd Battalion, 5th Marines squad patrol located in vicinity coordinates (BT 075366) observed 15-20 VC in camouflaged uniforms moving in a southwest direction approximately 1100 meters away in vicinity coordinates (BT 066364). Patrol called for artillery mission, 16 105mm HE and 3 rounds 105mm WP were fired on target with excellent

~~SECRET~~
DECLASSIFIED

coverage. Patrol observed three VC fleeing to the east during artillery missions. Area was searched from coordinates (BT 075366) to (BT 089364) to coordinates (BT 090634), and patrol found a tunnel complex at coordinates (BT 088364), and two holes approximately 4 feet in diameter and 10 feet deep. The tunnel was searched with CS grenades and field protective masks with negative results. Detailed search of the area was conducted with negative results.

(2) 280850H Company A squad patrol located in vicinity coordinates (BT 070358) observed one Vietnamese male, approximately 25 years of age dressed in black clothing, throw an object believed to be a weapon into bushes approximately 100 meters southwest of patrol in vicinity coordinates (BT 069357). Patrol challenged VC and VC failed to halt, patrol fired 10-12 rounds small arms fire, killing the VC. Patrol searched the corpse and found pack strap marks and shrapnel wounds on the VC's body. Results: 1 VC KIA confirmed.

(3) 281200H 1st Battalion, 5th Marines Frag Order 49-67 promulgated to all subordinate units. See enclosure (5).

(4) 281400H Company A located vicinity coordinates (BT 082362) apprehended 2 males age 22 and 60 hiding in a cave. One detainee was dressed in green clothing and the other detainee was dressed in black clothing. Detainees were forwarded to 5th Marines S-2.

(5) 281930H Company A while searching area in vicinity coordinates (BT 085353) to (BT 085356) found 120 rounds 5.56mm ammunition, 1 M26 fragmentation grenade, 1 ChiCom grenade, 1 VC belt with M14 magazine pouch and 4 graves approximately 4 weeks old. Captured equipment was forwarded to 5th Marines S-2.

(6) 282100H 1st Battalion, 5th Marines night defensive perimeter and activities were established. See enclosure (6).

(7) 282158H 1st Battalion, 5th Marines received 5th Marines Frag Order 31-67. See reference (e).

e. D+3 29 May 1967. (See enclosure (7)).

(1) 290055H 1st Battalion, 5th Marine Frag Order 50-67 was promulgated to all subordinate units. See enclosure (8).

(2) 290640H Lead elements of 1st Battalion, 5th Marines crossed Phase Line Black moving to combat base located at Hill 51.

(3) 290845H Company F, 2nd Battalion, 5th Marines reported that a current list of thrust points was lost sometime between 282400H to 290500H vicinity coordinates (BT 077366).

(4) 291220H Company F, 2nd Battalion, 5th Marines squad patrol vicinity coordinates (BT 009406) observed 7 VC wearing packs and helmets running through a treeline approximately 400 meters to the southwest vicinity coordinates (BT 005345). Patrol fired 100 rounds small arms fire at the VC. Patrol received approximately 30 rounds sniper fire. Artillery mission was called and 30 rounds 105mm HE and 2 rounds 105mm WP were fired with excellent coverage. At 291250H while searching area vicinity coordinates (BT 008335) patrol received approximately 20 rounds sniper fire from an undetermined number of VC at approximately 500 meters to the southeast vicinity

DECLASSIFIED

~~SECRET~~

coordinates (BT 0338). Patrol returned fire with 10 rounds small arms fire, 2 rounds 3.5 WP and 5 M-79 rounds. Area was searched with negative results.

- (5) 291430H 1st Battalion, 5th Marines units arrived at combat base.
- (6) 291900H 1st Battalion, 5th Marines night defensive perimeter was established. See enclosure (7).
- (7) 291930H 1st Battalion, 5th Marines received 5th Marines Frag Order 32-67. See reference (f).
- (8) 292215H 1st Battalion, 5th Marines Frag Order 52-67 promulgated to all subordinate units. Company D replaced Company C in the task organization. See enclosure (9).

f. D+4 30 May 1967 (See enclosure (10).)

- (1) 300740H H+10. Lead element of 1st Battalion, 5th Marines departed LZ located vicinity Combat Base for insertion into LZ Robin located in vicinity coordinates (BT 100210). See enclosure (9).
- (2) 300805H Lead elements of 1st Battalion, 5th Marines were inserted into LZ Robin with negative enemy contact.
- (3) 300850H Personnel of 1st Battalion, 5th Marines detected unknown chemical irritants in vicinity coordinates (BT 113218). The chemicals produced no significant results.
- (4) 300855H Completed insertion of 1st Battalion, 5th Marines into LZ Robin, and were conducting an attack on Objective A.
- (5) 300930H All 1st Battalion, 5th Marines units had cleared LZ Robin, and were conducting an attack on Objective A.
- (6) 301135H 1st Battalion, 5th Marines observed friendly A4E aircraft crash in vicinity coordinates (BT 125230). Aircraft came in low, clipped a tree and flipped into a valley vicinity coordinates (BT 130037). 5th Marines were notified.
- (7) 301200H Company F, 2nd Battalion, 5th Marines located vicinity coordinates (BT 125226) received approximately 100 rounds small arms fire from an estimated 6-10 VC at a range of approximately 400 meters to the north located in vicinity coordinates (BT 125230). Company F returned 200 rounds small arms fire and called in air strike. Enemy fire ceased. The area was searched with negative results.
- (8) 301300H 1st Battalion (-) Command Group located vicinity coordinates (BT 131227) received approximately 3 to 5 rounds small arms fire, from an estimated 1 sniper at a range of approximately 400 meters to the north vicinity coordinates (BT 130231). Company A returned 5 rounds small arms fire and searched the area with negative results.
- (9) 301450H Company A located vicinity coordinates (BT 146228) received one round small arms fire from an unobserved sniper at a range of approximately 250 meters to the northwest, located in vicinity coordinates (BT 145229). Company A returned 5 rounds small arms fire and searched the area with negative results. Sniper's most likely route of withdrawal was to the northwest.
- (10) 301910H 1st Battalion, 5th Marines secured Objective A.
- (11) 302100H 1st Battalion, 5th Marines night defensive perimeter and activities were established. See enclosure (10).
- (12) 302200H 1st Battalion, 5th Marines Frag Order 53-67 was promulgated to all subordinate units. See enclosure (11).

~~SECRET~~

DECLASSIFIED

~~SECRET~~

g. D+5 (31 May 1967) (See enclosure (12).)

(1) 310040H 1st Battalion, 5th Marines received 5th Marines Frag Order 34-67. See reference (g).

(2) 310630H Lead element of 1st Battalion, 5th Marines commenced coordinated Search and Destroy Operation to secure Objective B.

(3) 310715H Companies A and F arrived at Phase Line Yellow.

(4) 310730H Companies A and F departed Phase Line Yellow moving to attack and secure Objective B.

(5) 310920H Company F located in vicinity coordinates (BT 159245) received approximately 30 rounds small arms fire from an undetermined number of VC at a range of approximately 350 meters to the north. Company F returned approximately 315 rounds small arms fire and 5 M-79 rounds. The area was searched and Marines encountered one VC with weapon at a distance of approximately 200 meters. Company F fired 10 rounds small arms fire at VC. VC fell as if hit and rolled down the hill in thick brush. A detailed search of the area was conducted with negative results. Results: 1 VC WIA probable.

(6) 310950H 1st Battalion, 5th Marines secured Objective B vicinity coordinates (BT 164249).

(7) 311500H Company F, located vicinity coordinates (BT 158248), apprehended 1 Vietnamese male, age 23. Detainee was questioned by Battalion S-2 and forwarded to 5th Marines S-2.

(8) 311515H Company F squad security patrol located in vicinity coordinates (BT 147254) encountered two VC with weapons in undergrowth approximately 25 meters away. Patrol fired approximately 30 rounds small arms fire killing one VC and capturing one BAR serial number 658465. Patrol searched the area and found heavy blood trails. Blood trails were followed with negative results. It is believed local villagers dragged 2nd VC's body away. The incident resulted in 1 VC KIA confirmed, 1 VC KIA probable and one BAR captured. BAR was forwarded to 5th Marines S-2.

(9) 311545H Commanding Officer, 5th Marines visited 1st Battalion, 5th Marines vicinity coordinates (BT 16249).

(10) 311745H Company D squad patrol located vicinity coordinates (BT 162242) received approximately 20 rounds small arms fire from 4 VC at a range of approximately 350 meters from the west vicinity coordinates (BT 158243). VC were dressed in black clothing and carrying carbines and M-1 rifles. Patrol returned 80 rounds small arms fire and 8 M-79 rounds. Detailed search of the area was made with negative results.

(11) 312000H 1st Battalion, 5th Marines night defensive positions and activities were established. See enclosure (12).

(12) 312245H 1st Battalion, 5th Marines received 5th Marines Frag Order 35-67 See reference (h).

(13) 312345H 1st Battalion, 5th Marines Frag Order 54-67 was promulgated to all subordinate units. See enclosure (13).

h. D+6 (1 June 1967) (See enclosure (14).)

(1) 010800H 1st Battalion, 5th Marines commenced movement to conduct

~~SECRET~~
DECLASSIFIED

coordinated Search and Destroy Operation.

(2) 011000H Company D located vicinity coordinates (BT 189273) received 5 rounds small arms fire from one sniper dressed in black clothing located in vicinity coordinates (BT 188274) at a distance of approximately 200 meters to the west. Company D returned 20 rounds small arms fire killing the VC. Results: 1 USMC WIA, 1 VC KIA confirmed, with the following equipment captured: 1 modified carbine serial number 5403486, 1 magazine and 20 rounds. Captured equipment was forwarded to 5th Marines S-2.

(3) 011105H Companies A and F crossed Phase Line Purple.

(4) 011115H Company D located one mine vicinity Objective 20. Mine was destroyed in place by engineers.

(5) 011235H Company A located in vicinity coordinates (BT 162204) received 8-10 rounds small arms fire from 3-7 VC dressed in black clothing. Company A captured one VC wearing black clothing inside a cave with 1 US Carbine serial number 1783307 and 30,500 piasters. A further search of the area turned up 2 VC KIA confirmed. VC KIA were wearing black clothing. Results: 2 USMC WIA; 2 VC KIA confirmed, 1 VC captured. VCC and captured equipment were forwarded to 5th Marines S-2.

(6) 011530H Company D located vicinity coordinates (BT 189272) apprehended one male, age 17, wearing white clothing hiding in hedgrow trying to avoid friendly troops. Detainee was forwarded to 5th Marines S-2.

(7) 011700H 1st Battalion, 5th Marines Frag Order 55-67 promulgated to all subordinate units. See enclosure (15).

(8) 011700H Company A located in vicinity coordinates (BT 158293) received 5-10 rounds small arms fire from an estimated 4 unobserved VC at a range of approximately 550 meters north in vicinity coordinates (BT 158288). Company A returned fire with 45 rounds small arms fire and swept the area, encountering 1 VC sniper, who fired 3 rounds small arms fire and fled into heavy brush. Patrol fired 15 rounds small arms fire at fleeing VC, VC fell as if hit, area was searched and a heavy blood trail was found. Blood trail was followed with negative results. Incident resulted in one USMC WIA, 1 VC KIA probable.

(9) 012200H 1st Battalion, 5th Marines night defensive perimeter and activities established. See enclosure (14).

(10) 012350H 1st Battalion, 5th Marines received 5th Marines Frag Order 36-67. See enclosure (14).

(11) 012350H 1st Battalion, 5th Marines Frag Order 56-67 was promulgated to all subordinate units. See enclosure (16).

i. D+7 (2 June 1967) (See enclosure (17).)

(1) 020210H Company D on Search and Destroy Operation vicinity coordinates (BT 139310) received 1 round sniper fire from unobserved sniper at a range of approximately 250 meters from the west vicinity coordinates (BT 137312). Company D returned 20 rounds small arms fire and searched area with negative results.

(2) 020620H Company F, 2nd Battalion, 5th Marines located vicinity coordinates (BT 129307) received approximately 10 rounds small arms fire from an undetermined number of VC at a range of approximately 550 meters to

~~SECRET~~
DECLASSIFIED

the northeast vicinity coordinates (BF 132812). Returned approximately 120 rounds small arms fire and 10 60mm mortar rounds. Enemy fire ceased. Area was searched with negative results.

(3) 020805H Company D located vicinity coordinates (BF 125316) received 40-50 rounds small arms fire from an estimated 15 VC at a range of approximately 700 meters to the northwest vicinity coordinates (BF 124323). Returned 100 rounds small arms fire and called for airstrike. Detailed search of area was made after the airstrike and blood trails were found and followed with negative results. Results: 2 VC KIA probable.

(4) 021035H Company F, 2nd Battalion, 5th Marines located vicinity coordinates (BF 112314) received 10-20 rounds small arms fire from 5 VC dressed in black clothing vicinity coordinates (BF 107314). Returned 150-200 rounds small arms and 5 M-79 rounds. Enemy broke contact to the southwest.

(5) 021130H Company D was sweeping the paddy area vicinity coordinates (BF 095322) in a southwesterly direction when elements approaching the village vicinity coordinates (BF 095320) were taken under fire by 80 to 100 well camouflaged NVA in heavily fortified positions. The enemy fire swept across the front and left flank catching the left flank platoons in a cross fire. At approximately 021445H when the reserve platoon was deployed to the right to roll up the enemy flank, it was brought under heavy automatic weapons fire. 60mm mortars were fired on the enemy positions and an assault on the enemy position pulled up short. Company D consolidated its positions at approximately 021940H and continued to engage the enemy through the night with small arms, automatic weapons, artillery and airstrikes, several large secondary explosions being observed. There were 40 NVA KIA confirmed, 75 KIA probable and 50 VC WIA probable while Company D had 17 KIA's, 22 WIA's and 1 DOW. See Enclosure (20).

(6) 021200H Company F advanced to search the area vicinity coordinates (BF 107314) at approximately 021205H, and while moving through the area encountered scattered resistance resulting in 5 NVA KIA confirmed. The company continued down into the flat paddy land at vicinity coordinates (BF 107314) when a Kit Carson scout started shooting at flat mats of hay laying in the paddy. The NVA had concealed themselves under the hay mats and 31 NVA KIA confirmed were counted as Company F advanced. At approximately 021420H, heavy enemy mortar, rocket, small arms and automatic weapons fire were received from vicinity coordinates (BF 094314) from an estimated 300-500 enemy in a heavily fortified trench position. The enemy fire stepped Company F, which consolidated their position and brought heavy fire on the enemy position. At approximately 021520H the reserve platoon was maneuvered to secure the high ground vicinity coordinates (BF 108314) when an estimated 40 VC were encountered. The platoon assaulted the enemy position and there were 35 NVA KIA confirmed. At approximately 021730H the Company F commander led an assault on the enemy defensive command bunker, personally killing 15 NVA before he was killed trying to secure a machine gun bunker. The acting company commander consolidated into night positions vicinity coordinates (BF 100315) at approximately 021920H and called in artillery and airstrikes throughout the night. Results of the engagement: 170 NVA KIA confirmed, 310 NVA KIA probable; 32 USMC KIA, 39 USMC WIA.

DECLASSIFIED

~~SECRET~~

(7) 021400H Company A, the Battalion Reserve, was committed to engage the enemy vicinity coordinates (BT 110315) and ease pressure on the companies. As Company A deployed to engage the enemy they came under sniper fire and recoilless rifle fire, Company A returned fire resulting in 4 NVA KIA confirmed, 2 KIA probable and the capture of 1 Chinese rocket launcher. At 021700H Company A was ordered to linkup with Company F, 2nd Battalion, 5th Marines in the vicinity coordinates (BT 103317) and immediately encountered heavy fire from 25-50 NVA entrenched in area covered with heavy underbrush. The Company returned fire, and assaulted the enemy position. The Company Commander of Company A was killed during this fire fight. At approximately 021900H the dead and wounded were carried out of the area as Company A was repositioned into night security positions. Results of this action were 30 NVA KIA confirmed, 33 KIA probable, 27 WIA probable, while Company A lost 5 KIA and 10 WIA.

(8) 021430H The Battalion Command Group moved into vicinity coordinates (BT 108318) where it was taken under enemy sniper fire and received mortar and rocket attacks throughout the night. The 81mm mortar platoon fired missions all night and a landing zone was set up to evacuate the dead and wounded and receive emergency ammunition supply.

j. D+8 (3 June 1967). (See enclosure (18).)

(1) 030600H 1st Battalion, 5th Marines continued to consolidate, regroup, reorganize and search the area for equipment and wounded and to evacuate the dead and wounded.

(2) 030815H Commanding Officer, 5th Marines visited 1st Battalion, 5th Marines vicinity coordinates (BT 106317).

(3) 030840H Captain BRODIE assigned as Commanding Officer, Company A, 1st Battalion, 5th Marines.

(4) 031430H Newsmen arrived at 1st Battalion, 5th Marines Command Post.

(5) 031530H Battalion Command Post relocated at vicinity coordinates (BT 098316) to set up night defensive positions and conduct patrol activities. See enclosure (18).

k. D+9 (4 June 1967). (See enclosure (19).)

(1) 040930H Company D vicinity coordinates (BT 095316) while searching area found one VC KIA, one completely destroyed 82mm mortar and one badly damaged ChiCom assault rifle AK 47, due to the condition of the weapon, the serial number was not readable.

(2) 041030H Company D vicinity coordinates (BT 093323) on search and security patrol found one ChiCom sub-machine gun serial number L8632, 2 ChiCom grenades, one canteen, two entrenching tools, 1 first aid packet, 30 small arms rounds, one magazine for ChiCom sub-machine gun, and two NVA bodies.

(3) 041045H 1st Battalion, 5th Marines Frag Order 57-67 was promulgated to all subordinate units. See Enclosure (20).

~~SECRET~~
DECLASSIFIED

(4) 041300H 1st Battalion, 5th Marines provided landing zone security for 2nd Battalion, 5th Marines helicopter lift in accordance with Regimental Frag Order 38-67.

(5) 041400H OPCON of Company F, 2nd Battalion, 5th Marines was passed from 1st Battalion, 5th Marines to 2nd Battalion, 5th Marines.

(6) 041520H Commanding General III MAF and Commanding Officer, 5th Marines visited 1st Battalion, 5th Marines vicinity coordinates (BT 095321).

(7) 041700H Enemy equipment captured from 021035H to 041700 was extracted from the Operational area.

(8) 041700H Helicopter lift of 2nd Battalion, 5th Marines units was completed.

(9) 041700H 1st Battalion, 5th Marines departed vicinity coordinates (BT 098317) for Objective K in accordance with Regimental Frag Order 38-67.

(10) 041900H Objective K was secured and 1st Battalion, 5th Marines established night positions and conducted night activities.

(11) 041930H 1st Battalion, 5th Marines Frag Order 58-67 was promulgated to all subordinate units. See enclosure (21).

1. D+10 (5 June 1967) (See enclosure (22).)

(1) 050740H 1st Battalion, 5th Marines units commenced movement from Objective K vicinity coordinates (BT 002329) in trace of 3rd Battalion, 5th Marines.

(2) 051005H 1st Battalion, 5th Marines arrived at Objective Golf, secured landing zone for 3rd Battalion, 5th Marines helicopter lift.

(3) 051020H Leading elements of Battalion Command Group arrived at Combat Base at Hill 51.

(4) 051530H Helicopter lift for 3rd Battalion, 5th Marines completed. Landing zone security at Objective Golf returned to combat base at Hill 51.

(5) 051800H Operation Union II terminated.

11. Results.

a. Friendly casualties.

KIA	54
DOW	1
WIAE	71
WIANE	3

b. Enemy casualties.

KIA confirmed	258
KIA probable	425
WIA confirmed	1
WIA probable	79
Detainees	13

DECLASSIFIED

c. Captured Ordnance

- 12 - Chinese Communist 7.62mm assault rifle type 56., serial numbers: 2L 6535II, 2L4762II, 2L6535II, 2L1061II, 2L8874II, 2L59238II, 2L13446II, 2L8632II, 2L48632II, 3 serial numbers unreadable.
- 2 - U.S. Carbines caliber 30, serial numbers: 1783206, 5403486.
- 1 - U.S. Browning Automatic Rifle, serial number 658465.
- 1 - U.S. Rifle caliber 30 M-1, serial number 107314.
- 1 - 12 gauge shotgun, serial number 970330.
- 1 - North Vietnamese modified 7.62mm Sub-machinegun, type 50, serial number, 90374.
- 4 - Chinese Communist anti-tank grenade launchers, type 56.
- 1 - U.S. M-60 machinegun, serial number 71323R.
- 1 - Chinese Communist 36 caliber machinegun, serial number 214534.
- 2 - Chinese Communist Light Machineguns, serial number 908921, one serial number unreadable.

d. Captured Enemy Equipment

- 7 Magazines, drum for ChiCom light machinegun
- 1 Magazine, Browning Automatic Rifle
- 9 Magazines, for ChiCom sub-machinegun AK-47
- 5 Magazines, for M-16
- 6 Packs, marching
- 11 Hammocks
- 14 Uniforms, (green and khaki)
- 1 Carrier, magazine (.45)
- 2 Bottles assorted pills
- 6 Belts, pistol
- 1 Packet, first aid
- 8 Canteens
- 4 Covers, Canteen
- 9 Belts, cartridge
- 2 Helmets, jungle
- 17 Clips, 7.62 ammo
- 14 Ponchos, NVA type
- 1 Flashlight
- 1 Wire brush
- 4 Entrenching tools
- 1 Bayonet with scabbard
- 30,500 Piasters
- Small quantities of assorted papers, documents and notebooks.

e. Destroyed Enemy Equipment

- 18 ChiCom stick hand grenades (frag)
- 4 Defensive hand grenades (concussion)
- 1 Antipers mine
- 6 2.35 inch rockets

DECLASSIFIED

4 Caves

12. Administrative Matters.

a. Supply.

(1) Resupply was effected by helicopters controlled by the 1st Battalion, 5th Marines HST with the Battalion Command Group. HST's were attached to Company A, Company C and Company D during Operation Union II. Company F, 2nd Battalion, 5th Marines did not have an HST and requests were relayed to the Battalion Command HST over the Tactical Air Request net. During the first three days of Operation Union II, one priority medical evacuation, one routine resupply and a troop lift for Company F were completed.

(2) From 30 May through 1 June one emergency medical evacuation and one routine resupply were completed. On 2 June - 3 June six separate medical evacuations, one emergency resupply and one routine resupply were completed. Troop lifts for 2nd Battalion, 5th Marines and 3rd Battalion 5th Marines were completed on 4 June and 5 June.

(3) The necessity of using the overcrowded Tactical Air Request net for resupply and evacuation requests for company forces was the only problem encountered.

(4) The basic allowance of ammunition and 5 MCI was sufficient for sustained operations by scheduling normal resupply every other day. This combat load did not hinder the movement of the units.

b. Maintenance.

(1) Cleaning equipment for crew served and individual weapons was carried by all units of the 1st Battalion, 5th Marines. There were no maintenance problems during Operation Union II.

c. Transportation.

(1) Transportation for the 1st Battalion, 5th Marines units was limited to the helicopter troop lift on D+4. The troop lift was completed with no problems.

d. Communications.

(1) No significant problems were encountered with communications during Operation Union II. Due to the terrain and distance it was necessary to use the Regimental relay site at NUI LAC SON and a C-117 Airborne Radio Relay during the initial stages of the operation.

e. Medical Evacuation.

(1) Medical support for Operation Union II was provided by company corpsmen and by the Battalion surgeon and two corpsmen with the Battalion

DECLASSIFIED

~~SECRET~~

Command Group. On 2 June 1967 casualties were brought to the Command Group where medical personnel rendered first aid and effected a triage for helicopter evacuation to medical support activities in Chu Lai and DaNang. No significant medical problems were encountered.

13. Special Equipment and Techniques.

(1) No special equipment or techniques were utilized during Operation Union II.

14. Commanders Analysis.

(a) There was little or no contact with noncombatants. Thus, no problems or special actions on CA/PSYWAR were required. NVA forces were disposed in well prepared positions, emphasizing the requirement of a complete fire support plan to include preparation, planned and on call fires.

(b) On one occasion the enemy was found to be hiding under straw mats in an open field, and were detected by a Kit Carson Scout. The effective utilization of Kit Carson scouts is limited only by the imagination of the Unit Commander.

(c) The enemy's employment of an irritant chemical agent did not effect the combat efficiency of the 1st Battalion, 5th Marines, but it does illustrate the enemy's ability to employ a variety of weapons.

15. Recommendations.

(1) That the tenets of proven combat principals continue to be emphasized at all levels.

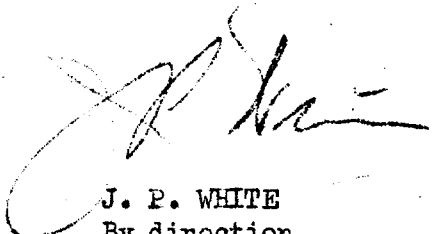

J. P. WHITE
By direction

DECLASSIFIED

1st Battalion, 5th Marines
 QUE SON, RVN
 252130H May 1967

Frag Order 47-67

Ref: (a) Maps, RVN, 1:50,000; Series E 7014, Sheets 6640 II - III.

Task Organization

1stBn, 5thMar (-)(Rein)

H&S Company (-)(Rein)

Det, Co B, 1stSPBn

Det, Co B, 1stEngrBn

Det, Btry D, 2ndBn, 11thMar

Det, 81 Mort Plt

Det, Med Plt

Det, ARVN Ln Off

Det, Kit Carson Tm

Det, Comm Plt

Company A (-)(Rein)

Company A (-)

Det, Co B, 1stSPBn

Det, Co B, 1stEngrBn

Det, Hq Co, 5thMar (Scout Sniper Tm)

Det, Btry D, 2ndBn, 11thMar

Det, H&S Co,

81 FO Tm

Det, Comm Plt

Det, Med Plt

S-2 Scout

FAC Tm

Kit Carson Tm

Company C (-)(Rein)

Company C (-)

Det, Co B, 1stSPBn

Det, Co B, 1stEngrBn

Det, Hq Co, 5th Marines (Scout Sniper Tm)

Det, Btry D, 2ndBn, 11thMar

Plt Co D,

Det, H&S Co,

81 FO Tm

Det, Comm Plt

Det, Med Plt

S-2 Scout

FAC Tm

Kit Carson Tm

LT COL HILGARTNER
 CAPT MCKAY (Acting)

CAPT BABICH

CAPT CASWELL

1. SITUATION. No change.

2. MISSION. Conduct search and destroy operations in area of operation to kill or capture VC, weapons and supplies.

3. EXECUTION.

A. Concept of Operation.

(1) 1st Battalion, 5th Marines deploys to establish blocking positions east of the valley in vicinity coordinates (BT 067396) to vicinity coordinates (BT 055384). See Annex A (Operation Overlay).

(2) Be prepared to continue attack on order.

(3) Conduct patrols between Hill 51 Combat Base and east west grid line 31.

B. Company C.

(1) At H-6 on D-Day move along route of advance to establish blocking position at Objectives A and B. See Annex A (Operation Overlay).

(2) At H-Hour be prepared to continue attack on order.

(3) Be prepared to assume other missions on order.

C. Company A.

(1) At H-5 $\frac{1}{2}$ on D-Day move in trace of Company C to establish blocking position at Objective A. See Annex A (Operation Overlay).

(2) At H-Hour be prepared to continue attack on order.

(3) Be prepared to assume other missions on order.

D. Company B.

(1) At H-30 minutes on D-Day conduct platoon (Rein) combat patrol between Hill 51 Combat Base and east west grid line 31. See Annex A (Operation Overlay).

(2) Be prepared to assume other missions on order.

E. H&S Company.

(1) General Support.

F. Platoon Company D.

(1) Battalion Reserve.

(2) Provide Command Group security.

(3) Be prepared to assume other missions on order.

G. Coordinating Instructions.

(1) H-Hour 0600H; D-Day 26 May 1967.

(2) Position reports hourly at 10 minutes before the hour.

SECRET

- (3) Unclassified Code Name - Operation "UNION II".
- (4) Use of RCA authorized and encouraged.
- (5) Gas mask will be carried by all personnel.
- (6) Flak jackets optional.
- (7) Order of march - Company C, Company A, Command Group and Battalion Reserve.
- (8) Portion of Operation "UNION II" in Que Son NFZ responsibility of 1st Battalion, 5th Marines.
- (9) Spot reports of significant events, particularly when crossing phase lines and checkpoints in securing objectives and contact with enemy forces.

4. ADMINISTRATION AND LOGISTICS. The following thrust points effective at H-Hour:

Day	BT 0731
Month	BT 1132
Animal	BT 0934
Coin	BT 0636

P. L. HILGARTNER
Lieutenant Colonel
Commanding

ANNEX: A-Operation Overlay

OFFICIAL

J. P. WHITE
Major, USMC
Executive Officer

SECRET

1st Battalion, 5th Marines
QUANG BINH, RVN
252000H May 1967

SECRET

ANNEX A-(Operation Overlay) to Frag Order 47-67
Ref: Maps, RVN; 1:50,000; Series L 7014, Sheets 6640 II - III.

01
+ 39

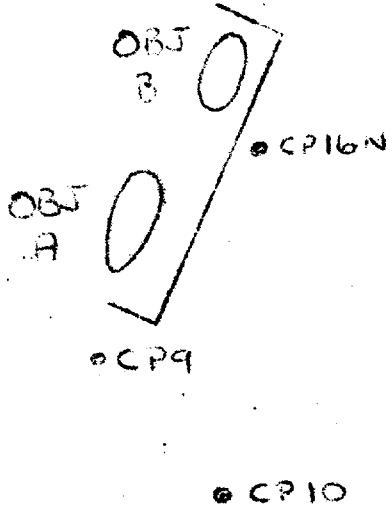

• CP34

• CP16

• CP6

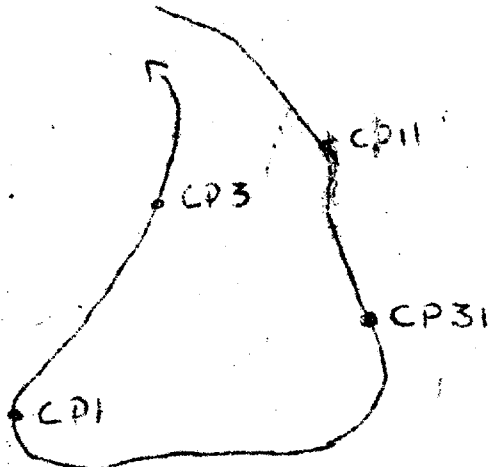

+ 32
07

OFFICIAL

J. P. White

J. P. WHITE
Major, USMC
Executive Officer

P. L. HILGARTNER
Lieutenant Colonel
Commanding

A-1

SECRET

Enclosure (1)

Operation and Night Disposition Overlay D-Day
Ref: Maps, RVN, 1:50,000; Series L 7014 Sheets 6640 II - III

SECRET

Day

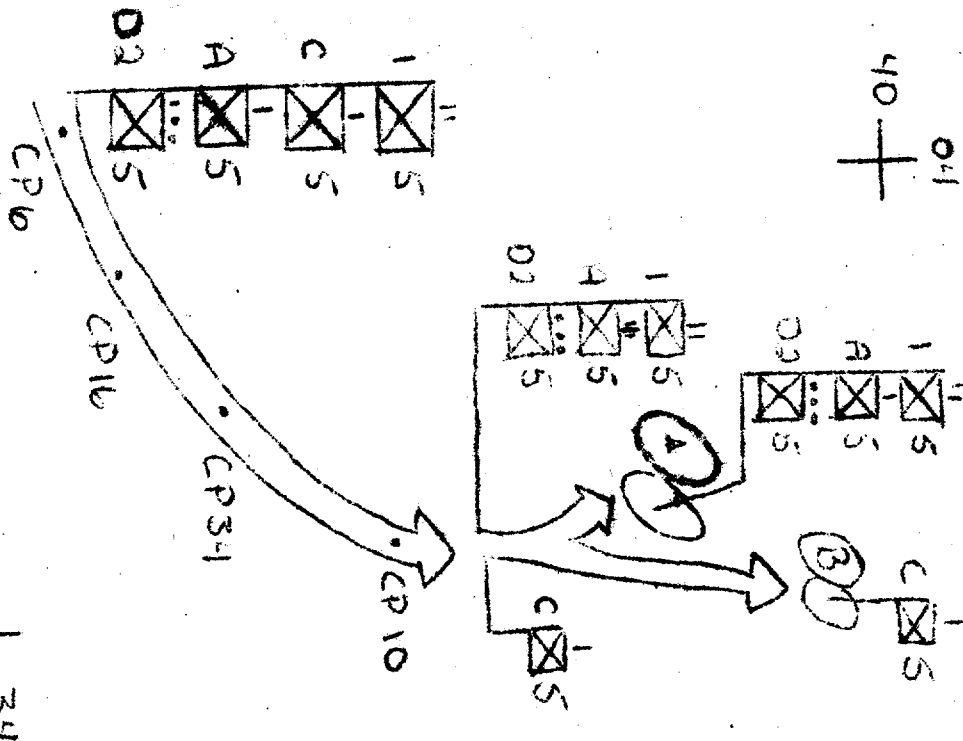

Day

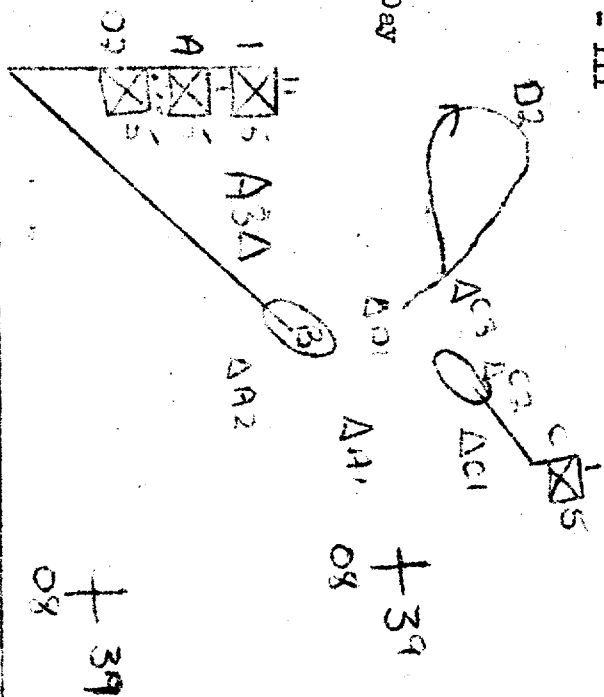

Night

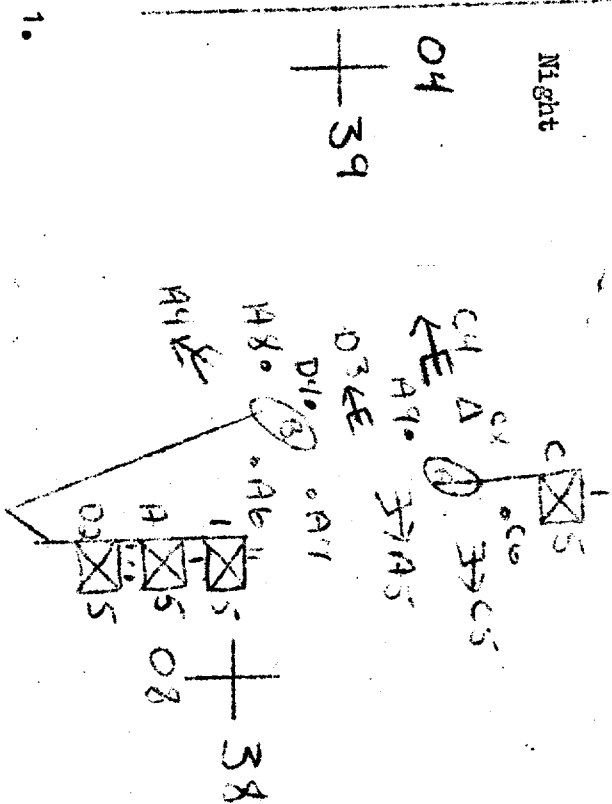

SECRET

Enclosure (2)

SECRET

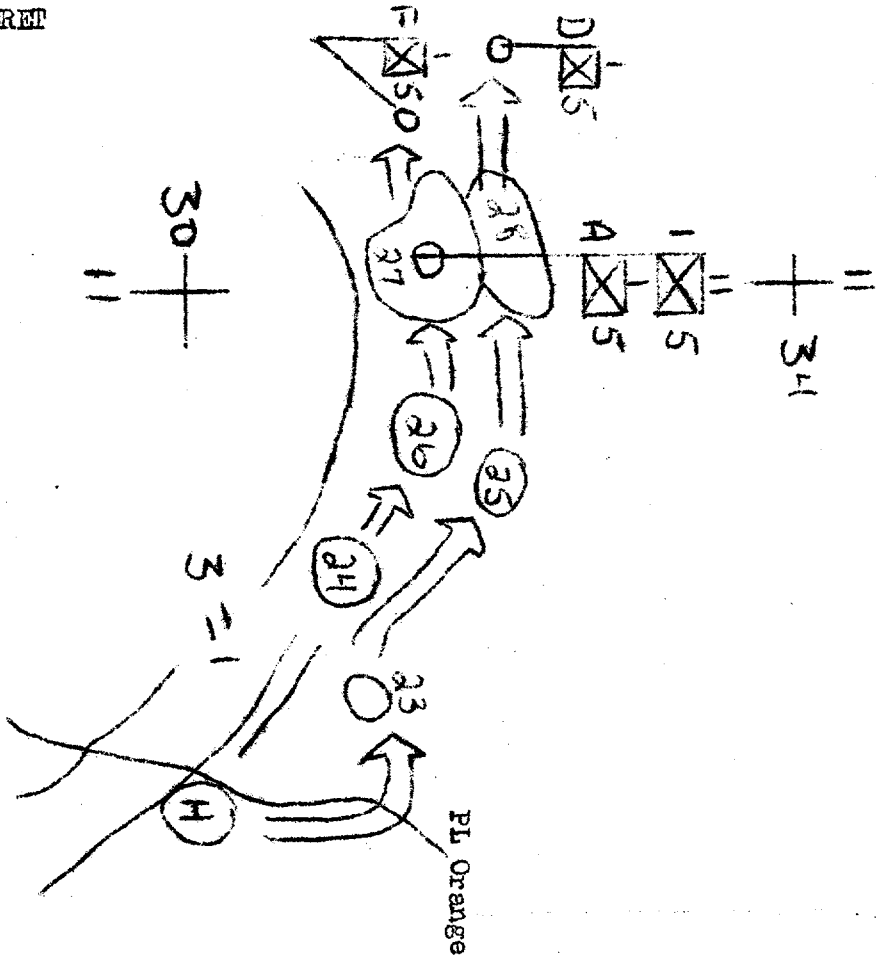

Day

Operation and Night Disposition Overlay D+7
Ref: (a) Maps, RVN; 1:50,000; Series L 7014, Sheets 6640 II - III

Night

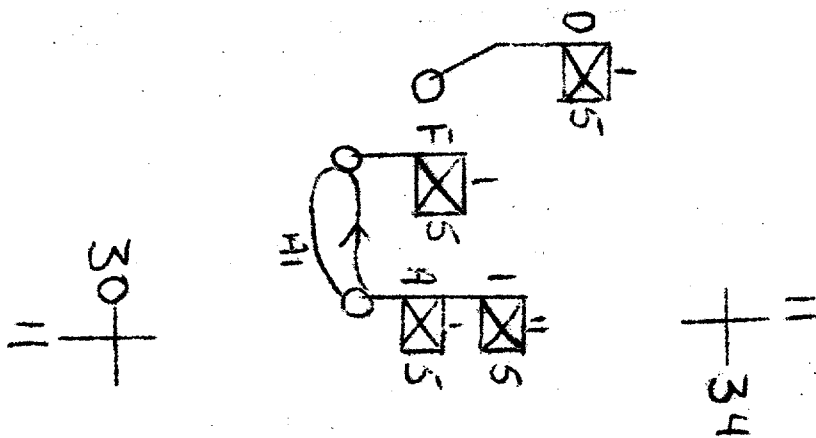

SECRET

Enclosure (17)

SECRET

1st Battalion, 5th Marines
 QUE SON, RVN
 271025H May 1967

Frag Order 48-67

Ref: (a) Maps, RVN; 1:50,000; Series L 7014, Sheets 6640 II - III.

1. SITUATION. No change.
2. MISSION. No change.
3. EXECUTION.
 - A. Company A.
 - (1) On order attack to southeast to secure Objective E, continue attack on order in assigned sector to secure Objective F in zone.
 - (2) Be prepared to continue attack on order.
 - (3) Be prepared to assume other missions on order.
 - B. Company C.
 - (1) On order attack to southeast to secure Objective D, continue attack on order in assigned sector to secure Objective F in zone.
 - (2) Be prepared to continue attack on order.
 - (3) Be prepared to assume other missions on order.
 - C. H&S Company.
 - (1) General Support.
 - D. 2nd Platoon, Company D.
 - (1) Battalion Reserve.
 - (2) Provide Battalion Command Group security.
 - (3) Be prepared to assume other missions on order.
 - E. Coordinating Instructions.
 - (1) H-Hour (0900 for planning purposes); D-Day (27 May for planning purposes).
 - (2) Be prepared to move out on 30 minute notice.
 - (3) Battalion Command Group and Battalion Reserve will follow in trace of Company A.
4. ADMINISTRATION AND LOGISTICS. No change.

SECRET

SECRET

- * 5. COMMAND AND COMMUNICATIONS. No change.

P. L. HILGARTNER
Lieutenant Colonel
Commanding

ANNEX: A-Operation Overlay

OFFICIAL

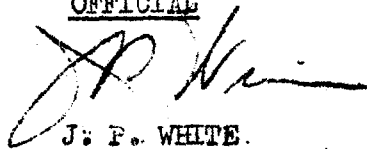

J. P. WHITE.
Major, USMC
Executive Officer

SECRET

1st Battalion, 5th Marines
QUE SON, RVN
2710 May 1967

SECRET

ANNEX A (Operation Overlay) to Frag Order 48-67
Ref: (a) Maps, RVN; 1:50,000 Series L 7014; Sheets 6640 II - III

+ 41
10

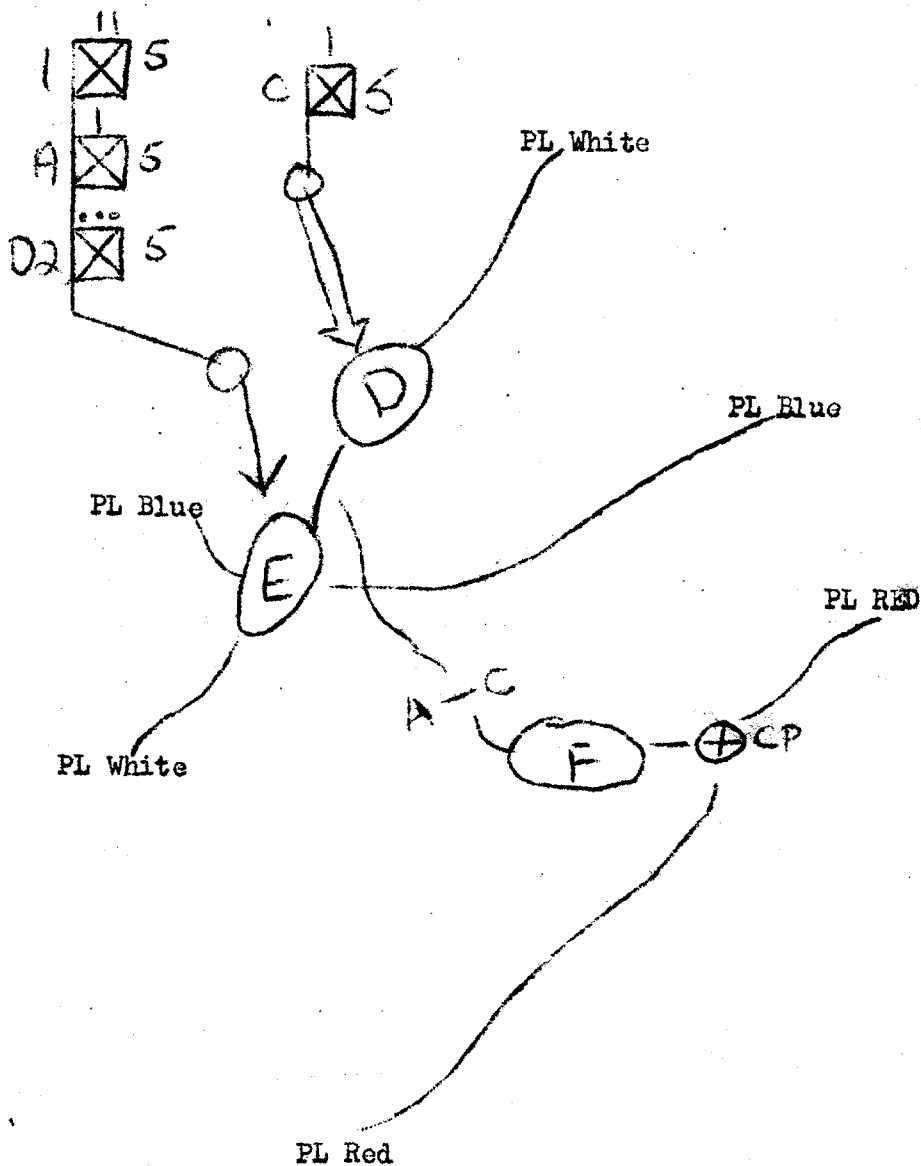

04
33+

OFFICIAL

J. P. WHITE
Major, USMC
Executive Officer

P. L. HILGARTNER
Lieutenant Colonel
Commanding

SECRET

Enclosure (4)

A-1

SECRET

1st Battalion, 5th Marines
 QUE SON, RVN
 281200H May 1967

Frag Order 49-67

Ref: (a) Maps, RVN; 1:50,000; Series L 7014, Sheets 6640 II - III

1. SITUATION. No change.
2. MISSION. No change.
3. EXECUTION.

A. Company C.

- (1) Conduct S&D operations from present position to vicinity (BT 082367) and establish blocking position.
- (2) Be prepared to patrol actively to southeast, northeast and northwest to a range of 700 meters.

B. Company F.

- (1) Conduct S&D operations from present position to vicinity (BT 076366) and establish blocking position.
- (2) Tie in with Company C and conduct S&D operations to the southwest to a range of 1000 meters.

C. Company A.

- (1) Conduct S&D operations from present position to vicinity (BT 077360) and establish blocking position.
- (2) Be prepared to patrol actively to the southwest and south to range of 1000 meters.

D. H&S Company.

- (1) General Support.
- (2) Follow in trace of Company F.

E. 2nd Platoon Company D.

- (1) Battalion Reserve.
- (2) Provide security for the Command Group.
- (3) Follow in trace of Battalion Command Group.

F. Coordinating Instructions.

- (1) Units depart present position as soon as possible and move to

SECRET

SECRET

designated positions.

(2) Submit position reports hourly at 10 minutes before the hour.

4. ADMINISTRATION AND LOGISTICS. No change.
5. COMMAND AND COMMUNICATIONS. No change.

P. L. HILGARTNER
Lieutenant Colonel
Commanding

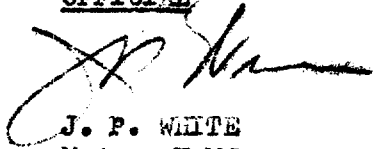
OFFICIAL

J. P. WHITE
Major, USMC
Executive Officer

SECRET

SECRET

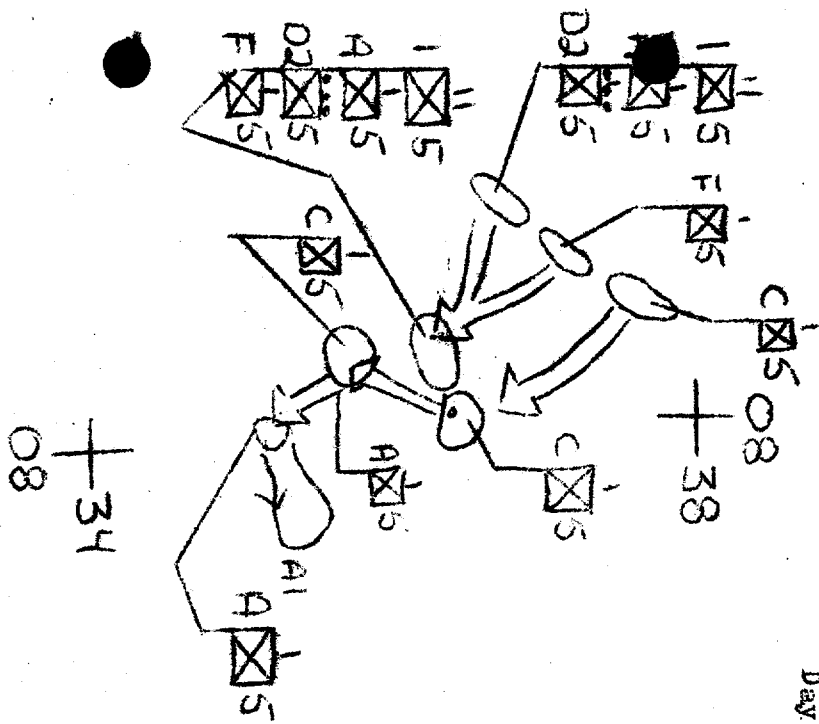

Day

Operation and Night Disposition Overlay D+2
Ref: Maps, RVN; 1:50,000; Series: L 7014, Sheets 6640 II - III

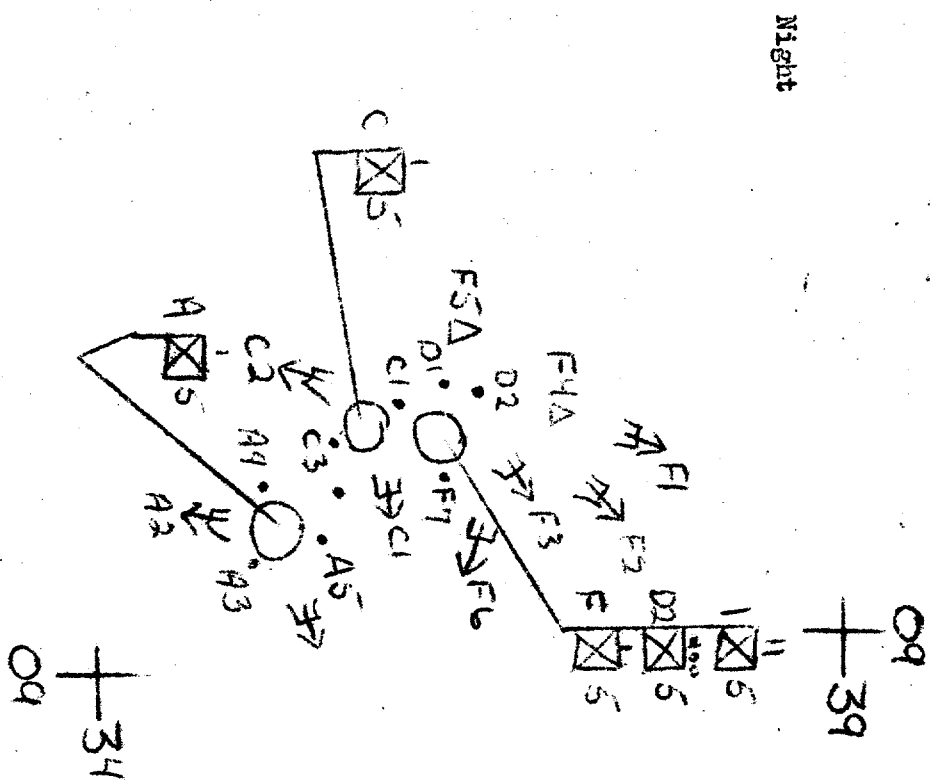

Night

SECRET

Enclosure (6)

SECRET

Operation Overlay D+3
Ref: Maps, RVN, 1:50,000; Series I 7014, Sheets 6640 II - III.

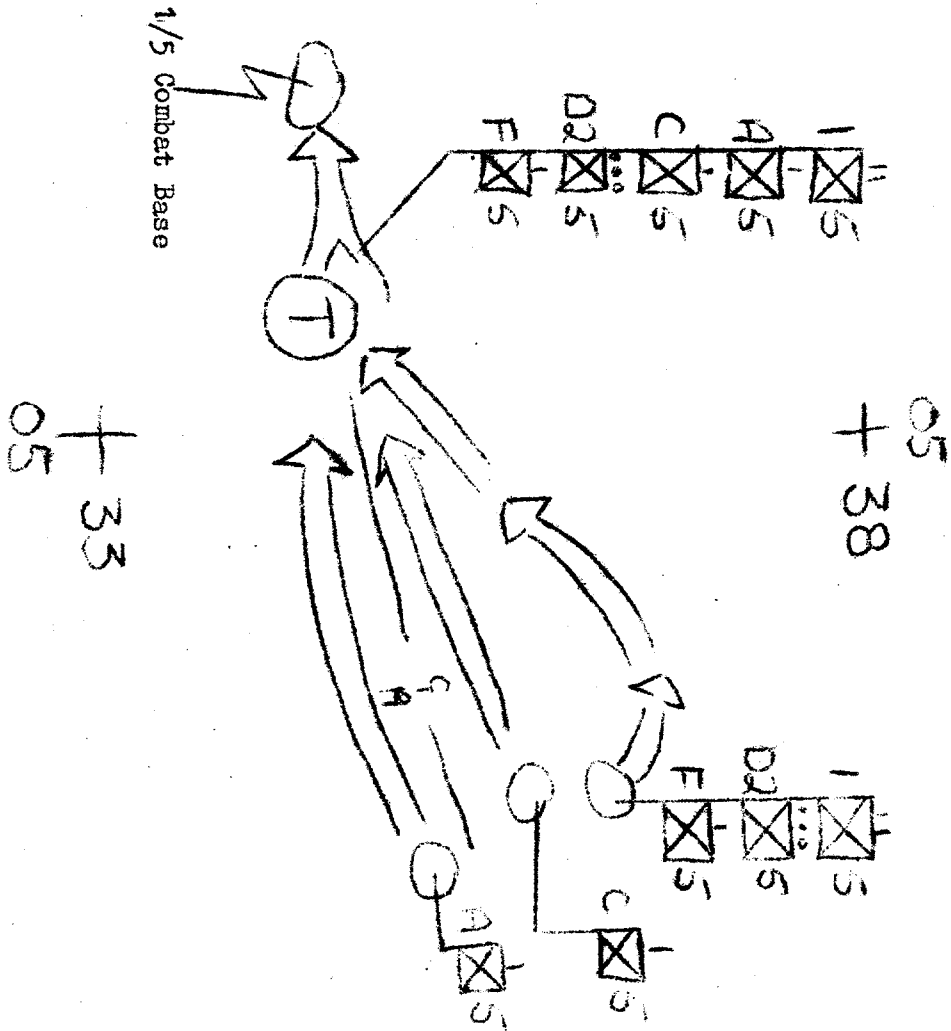

SECRET

Enclosure (7)

SECRET

1st Battalion, 5th Marines
 QUE SON, RVN
 290055H May 1967

Frag Order 50-67

Ref: (a) Maps, RVN, 1:50,000; Series L 7014, Sheets 6640 II - III

1. SITUATION. No change.

2. MISSION. No change.

3. EXECUTION.

A. Company C.

(1) At H-Hour conduct search and destroy operations north of boundary to secure portion of Objective Tango in zone.

(2) Be prepared to continue attack on order.

(3) Be prepared to assume missions on order.

B. Company A.

(1) At H-Hour conduct search and destroy operations south of boundary to secure portion of Objective Tango in zone.

(2) Be prepared to continue attack on order.

(3) Be prepared to assume other missions on order.

C. H&S Company.

(1) General Support.

(2) Battalion Command Group follow in trace of 2nd Platoon, Company

D.

D. Company F.

(1) Battalion Reserve.

(2) At H-Hour move along axis of advance in trace of Battalion Command Group to combat base at Hill 51.

(3) Be prepared to assume other missions on order.

(4) Provide rear and flank security.

E. 2nd Platoon, Company D.

(1) Battalion Reserve move along axis of advance to Combat Base at Hill 51.

(2) Provide security for Battalion Command Group.

SECRET

SECRET

F. Coordinating Instructions.

- (1) H-Hour 0530.
- (2) D-Day 29 May 1967.
- (3) Report lead element reaching Phase Line Black.
- (4) Unit Commanders insure that every man has a fighting hole.

4. ADMINISTRATION AND LOGISTICS. No change.

5. COMMAND AND COMMUNICATIONS. No change.

P. L. HILGARTNER
Lieutenant Colonel
Commanding

ANNEX: A Operation Overlay

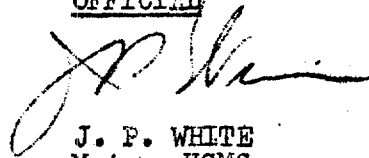
OFFICIAL

J. P. WHITE
Major, USMC
Executive Officer

SECRET

SECRET

1st Battalion, 5th Marines
 QUE SON, RVN
 292215H May 1967

Frag Order 52-67

Ref: (a) Maps, RVN; 1:50,000; Series L 7014, Sheets 6640 II - III

Task Organization (Effective 0500, 30 May 1967)

1stBn, 5thMar (-)(Rein)

LTCOL HILGARTNER

H&S Company (-)(Rein)

CAPT MCKAY (Acting)

H&S Company (-)

Det, 106 RR Plt

Det, Med Plt

Det, Comm Plt

Kit Carson Tm

ARVN Ln Off

Det, Co B, 1stSPBn

Det, Co B, 1stEngrBn

Company A (-)(Rein)

CAPT BABICH

Company A (-)

Det, Hq Co, 5thMar (Scout Sniper Tm)

Det, Btry D, 2ndBn, 11thMar

Det, Co B, 1stSPBn

Det, Co B, 1stEngrBn

Det, H&S Co.

81 FO

Det, 81mm Mortar Plt

Det, Med Plt

Det, Comm Plt

Kit Carson Tm

FAC Tm

S-2 Scout

Company D (-)(Rein)

1STLT MCINTURFF

Company D (-)

Det, Hq Co, 5thMar (Scout Sniper Tm)

Det, Btry D, 2ndBn, 11thMar

Det, Co B, 1stSPBn

Det, Co B, 1stEngrBn

Det, H&S Co.

81 FO

Det, 81mm Mortar Plt

Det, Med Plt

Det, Comm Plt

Kit Carson Tm

FAC Tm

S-2 Scout

SECRET

SECRET

... F Co, 2ndBn, 5thMar (-)(Rein)

CAPT GRAHAM

Company F (-)

Det, Hq Co, 5thMar (Scout Sniper Tm)

Det, Btry E, 2ndBn, 11thMar

Det, Co B, 1stEngrBn

Det H&S Co, 2ndBn, 5thMar

81 FO

Det, Med Plt

Kit Carson Tm

FAC Tm

S-2 Scout Tm

1. SITUATION. No change.
2. MISSION. To conduct search and destroy operations to kill or capture VC and weapons.
3. EXECUTION.

A. Concept of Operation.

(1) 1st Battalion, 5th Marines lands at L-Hour on D+5 in LZ Robin in a column of companies, secures LZ Robin and on order continues attack to secure Regimental Objective A.

B. Company A. (Rein)

(1) At L-Hour on D+5 land in primary LZ (Robin), secure Objective 1, continue attack on order.

(2) If landed in alternate LZ (Blue Jay), secure Objective 4, continue attack on order.

(3) Be prepared to assume other missions on order.

C. Company F. 2ndBn, 5thMar.

(1) Land in primary LZ Robin in trace of Company A, secure Objective 3, continue attack on order.

(2) If landed in alternate LZ (Blue Jay), secure Objective 5, continue attack on order.

(3) Be prepared to assume other missions on order.

D. Det. H&S Company.

(1) General Support.

(2) Land in primary LZ Robin, establish Battalion Command Post on Objective 3.

(3) If landed in alternate LZ (Blue Jay), establish Battalion Command Post on Objective 5.

E. 81 Mortar Platoon.

(1) Initially attached to Company A.

SECRET

SECRET

- (2) On order to General Support.

F. Company D (Rein)

- (1) Battalion Reserve.
- (2) Land in primary LZ Robin in trace of Company F, secure southern sector of LZ, continue attack on order.
- (3) If landed in alternate LZ (Blue Jay), secure northeastern section of LZ, continue attack on order.
- (4) Be prepared to assume mission of Company A or Company F on order.

G. Coordinating Instructions.

- (1) Loading Zone, vicinity (BT 025344) (Hill 51 Combat Base).
- (2) Pick up 1st wave 0710.
- (3) L-Hour 0730.
- (4) In addition to thrust points effected 290900H, any girls name (BT 1223).
- (5) LZ Robin (Primary) (BT 100210)
LZ Blue Jay (Alternate) (BT 113217)
LZ Cardinal (BT 129277)
- (6) Flak jackets optional.
- (7) Use of RCA authorized and encouraged.
- (8) Spot reports on significant events, particularly crossing phase lines and check points, securing objectives, contact with enemy forces.
- (9) Position reports hourly at 10 minutes before the hour.
- (10) HST with first plane, FAC in first wave.

4. ADMINISTRATION AND LOGISTICS.

- (1) Engineers carry maximum demolitions.
- (2) Next regular resupply D+7.
- (3) Routine resupply will be scheduled for 1200. Submit requests prior to 1800H day prior to resupply.
- (4) Three gas masks per rifle company squad.

SECRET

SECRET

5. COMMAND AND COMMUNICATIONS.

- a. ~~A.~~ **Qatry** hand illumination, colored smoke grenades and air panels.

P. L. HILGARTNER
Lieutenant Colonel
Commanding

ANNEX A: Operation Overlay

OFFICIAL

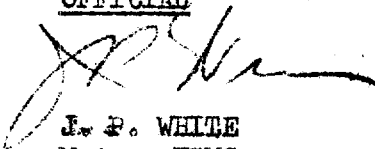

J. P. WHITE
Major, USMC
Executive Officer

SECRET

ANNEX A (Operation Overlay) to Freq Order 52-67
Ref: (a) Maps, RVN, 1:50,000; Series I 7014, Sheets, 6640 II-III

1st Battalion, 5th Marines
QUE SON, RVN
292215H MAY 1967

SECRET
Enclosure (9)

SECRET

09
+ 19

5
11

C10G
OFFICIAL

J. P. WHITE
Major, USMC
Executive Officer

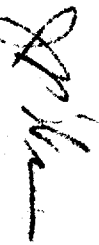

P. L. HIGGARTNER
Lieutenant Colonel
Commanding

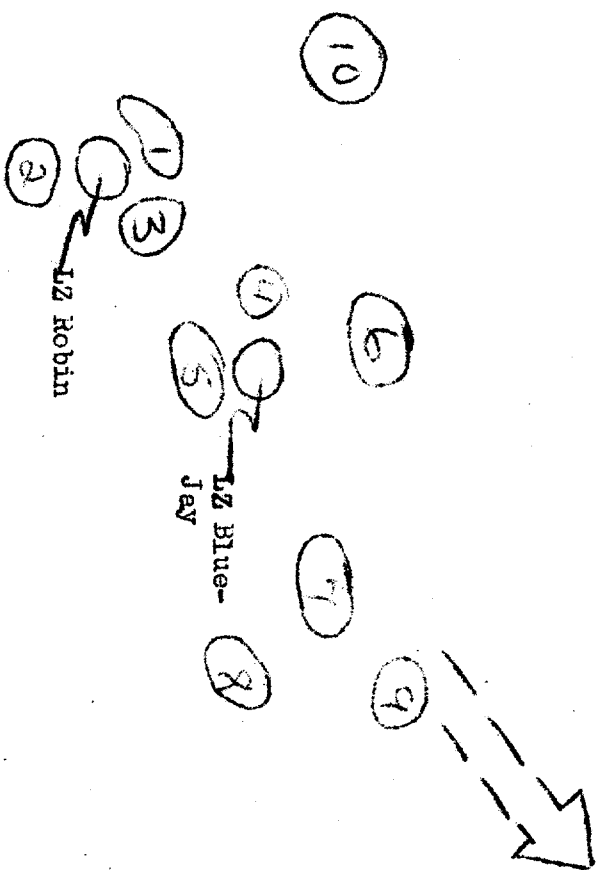

△
Recon
29May67

△
Recon
29May67

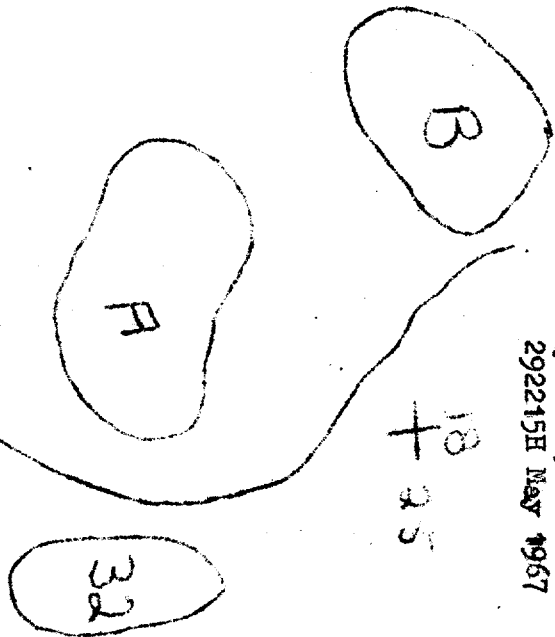

18
+ 25

SECRET

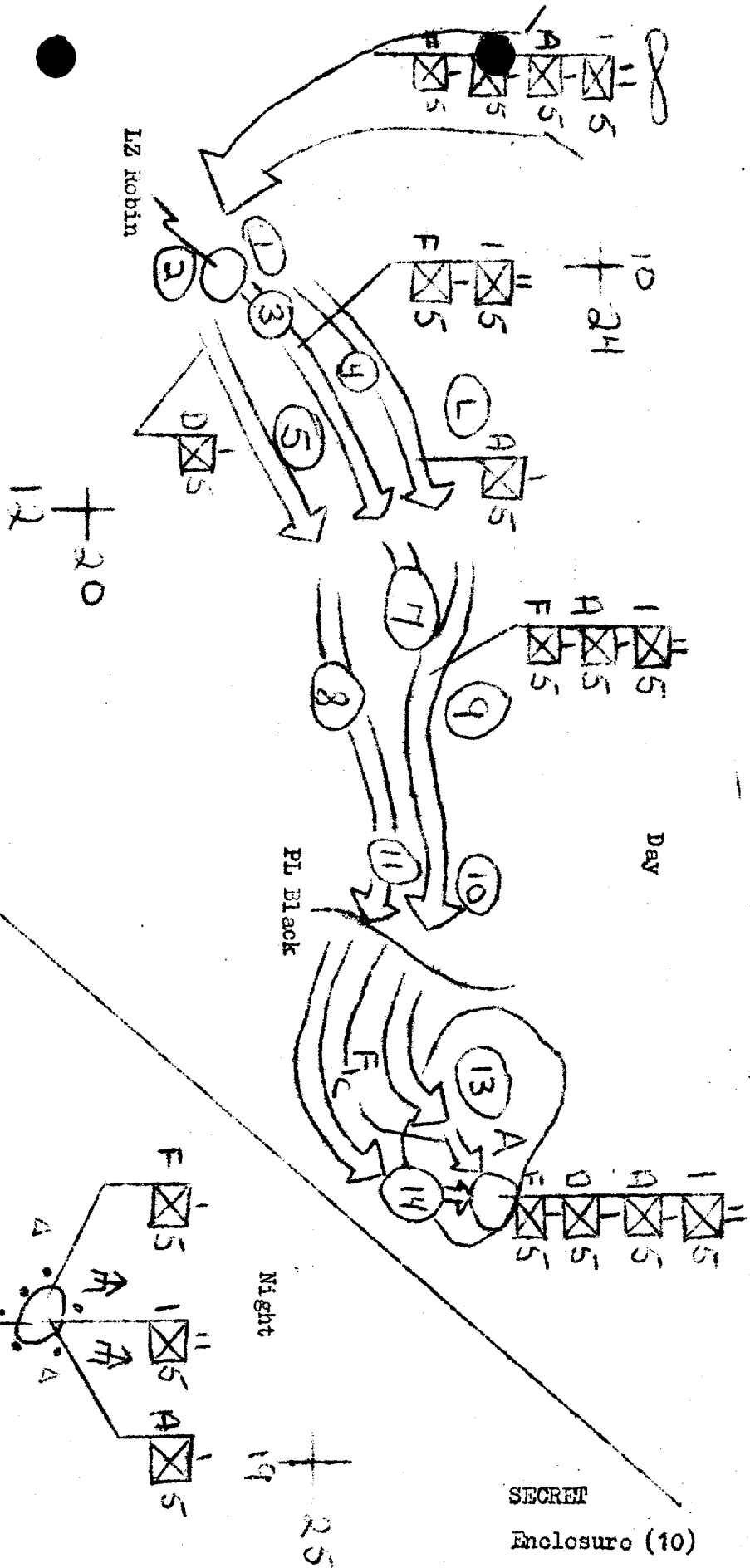

Operation and Night Disposition Overlay D+4
Ref: Maps, NVN, 1:50,000; Series I 7014, Sheets 6640 II - III

SECRET
Enclosure (10)

SECRET

1st Battalion, 5th Marines
 QUE SON, RVN
 302200H May 1967

Frag Order 53-67

Ref: (a) Maps, RVN; 1:50,000; Series L 7014, Sheets 6640 II - III.

1. SITUATION. No change.

2. MISSION. No change.

3. EXECUTION.

A. Concept of Operation.

(1) 1st Battalion, 5th Marines attacks with two companies to seize Objective B, be prepared to continue attack to east along Phase Line Brown.

B. Company A.

- (1) At H-Hour + 1½ hours, attack to seize Objective 16.
 (2) Continue attack on order to seize remaining portion of Objective B in zone.
 (3) Be prepared to continue attack on order.
 (4) Be prepared to assume other missions on order.

C. Company F.

- (1) At H-Hour + 1½ hours, attack to seize Objective 15.
 (2) Continue attack on order to seize remaining portion of Objective B in zone.
 (3) Be prepared to continue attack on order.
 (4) Be prepared to assume other missions on order.

D. Company D.

- (1) Initially Battalion Reserve.
 (2) Provide security for Battalion Command Group.
 (3) Be prepared to assume mission of Company A or Company F on order.

E. Coordinating Instructions.

- (1) H-Hour 0500; D-Day 1 June 1967.
 (2) Contact left to right.
 (3) Preparation fires at 0600H.

4. ADMINISTRATION AND LOGISTICS. No change.

SECRET

SECRET

5. COMMAND AND COMMUNICATIONS. No change.

P. L. HILGARTNER
Lieutenant Colonel
Commanding

ANNEX: A-Operation Overlay

OFFICIAL

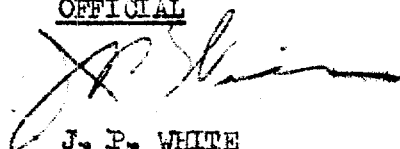

J. P. WHITE
Major, USMC
Executive Officer

SECRET

SECRET

1st Battalion, 5th Marines
QUE SON, RVN
302200H May 1967

ANNEX A (Operation Overlay) to Frag Order 53-67
Ref: (a) Maps, RVN; 1:50,000; Series L 7014, Sheets 6640 II - III.

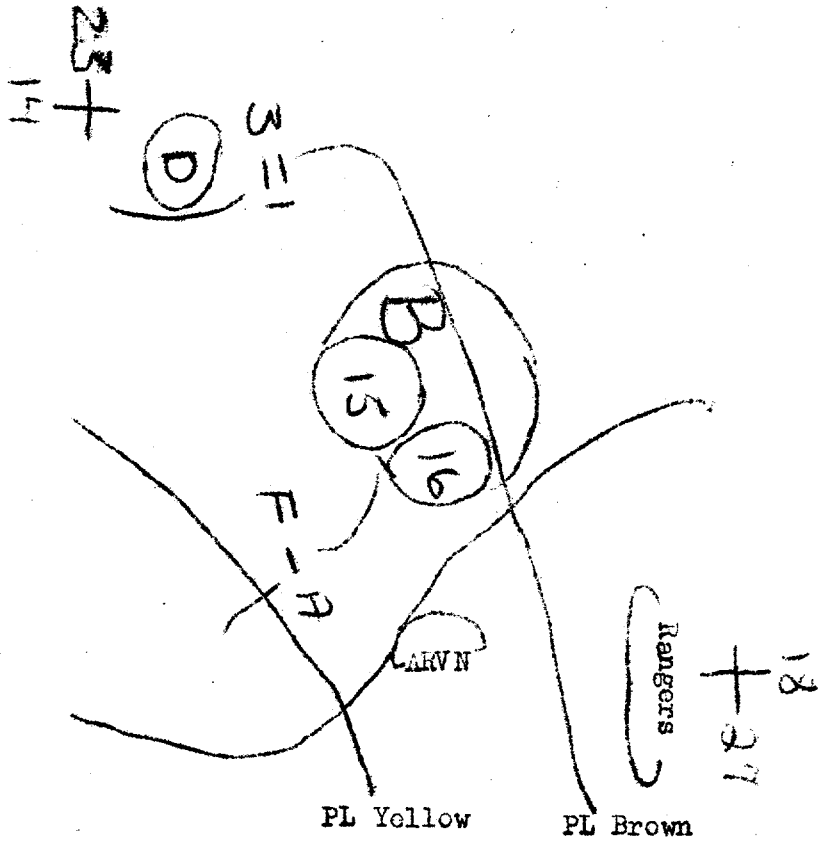

P. L. HILGARTNER
Lieutenant Colonel
Commanding

OFFICIAL

J. P. White

J. P. WHITE
Major, USMC
Executive Officer

SECRET

SECRET

1st Battalion, 5th Marines
 QUE SON, RVN
 312345H June 1967

Frag Order 54-67

Ref: (a) Maps, RVN; 1:50,000; series L7014, sheets 6640 II - III.

1. SITUATION. No change.

2. MISSION. No change.

3. EXECUTION.

A. Concept of Operation.

(1) At H-Hour 1st Battalion, 5th Marines attacks with two companies along axis of advance east of terrain feature vicinity (BT 178267) to seize Objective B.

B. Company A.

(1) At H-Hour attack in zone to seize Objective 17, continue attack on order. Keep traps east of terrain feature vicinity (BT 178267) in zone.

(2) Be prepared to assume other missions on order.

C. Company D.

(1) At H-Hour attack in zone to seize Objective 18, continue attack on order.

(2) Be prepared to assume other missions on order.

D. H&S Company.

(1) General Support.

E. Company F.

(1) Battalion Reserve.

(2) Provide security for Battalion Command Group.

(3) On order, move as directed generally along boundary between Company D and Company A.

(4) Be prepared to assume mission of either attacking unit on order. Priority to Company A.

F. Coordinating Instructions.

(1) H-Hour 0800; D-Day 1 June 1967.

SECRET

SECRET

- (2) Take salt tablets as prescribed.
- (3) Cross Phase Lines only on order.
- (4) Assault units be at LOD at 0730.
- (5) PSN reports hourly at 10 minutes before the hour, Spot reports as significant events occur.

4. ADMINISTRATION AND LOGISTICS. No change.

5. COMMAND AND COMMUNICATIONS. No change.

P. L. HILGARTNER
Lieutenant Colonel
Commanding

ANNEX: A-Operation Overlay

OFFICIAL

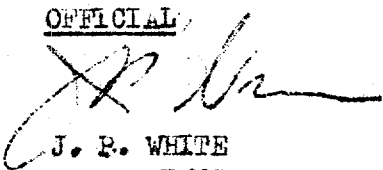

J. P. WHITE
Major, USMC
Executive Officer

SECRET

1st Battalion, 5th Marines
QUE SON, RVN
312500H May 1967

SECRET

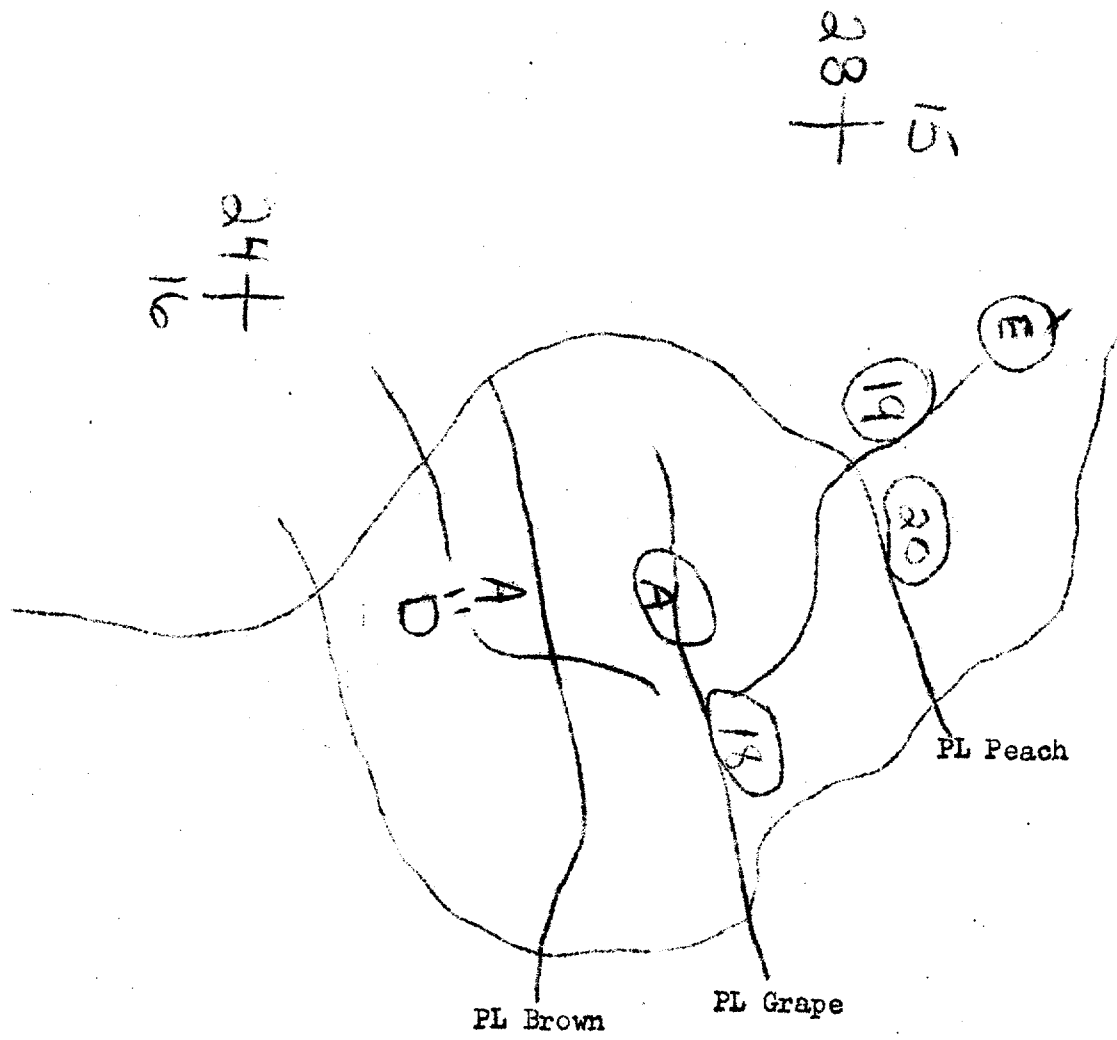
ANNEX A (Operation Overlay) to Frag Order 54-67
Ref: (a) Maps, RVN; 1:50,000; series L 7014, sheets 6640 II III



OFFICIAL

J. P. White
 J. P. WHITE
 Major, USMC
 Executive Officer

P. L. HILGARTNER
 Lieutenant Colonel
 Commanding

SECRET
Enclosure (13)

SECRET

PL Orange

Operation and Night Disposition Overlay D+6
Ref: (a) Maps, RTN, 1:50,000; Series L 7014, Sheets 6640 II -III

Day

18

30

26 +
15

PL Yellow

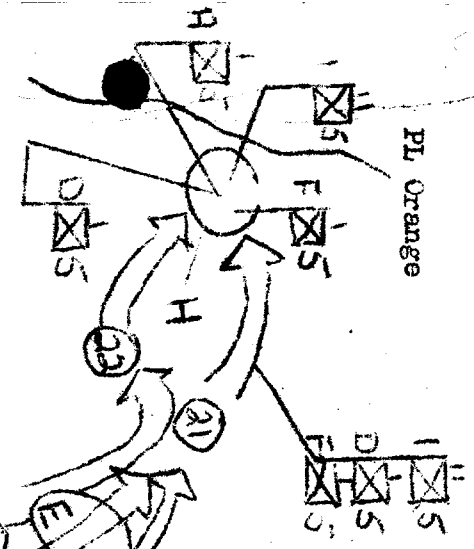

PL Peach

PL Grape

PL Brown

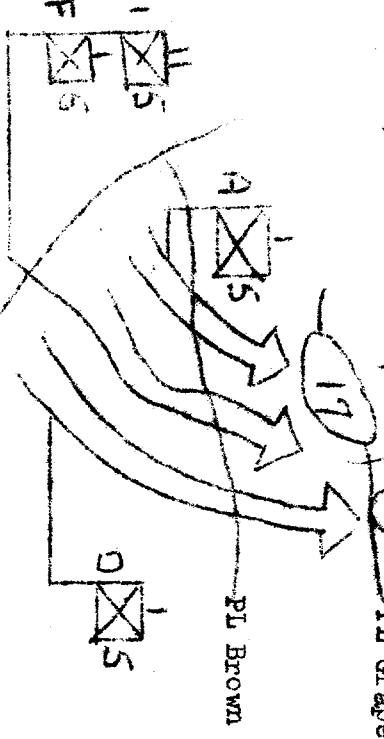

14
32

SECRET
Enclosure (14)

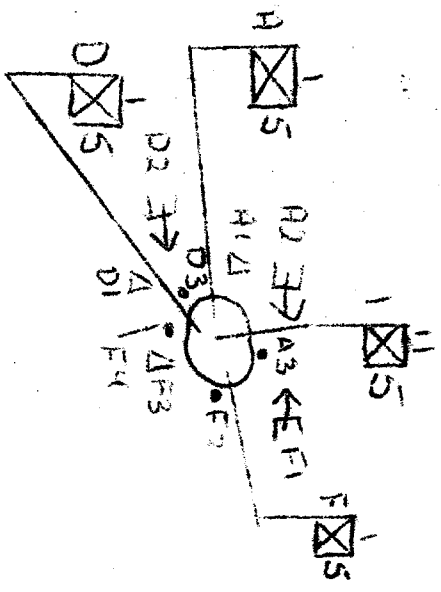

28 +
13

SECRET

1st Battalion, 5th Marines
 QUE SON, RVN
 011700H June 1967

Frag Order 55-67.

Ref: (a) Maps, RVN; 1:50,000; Series L7014, Sheets 6640 II - III.

1. SITUATION. No change.
2. MISSION. No change.
3. EXECUTION.

A. Company A.

(1) On order, deploy from present position, seize and attack Battalion Objective 22, then conduct search and destroy operations to Regimental Objective HOTEL and link up with Company F. See ANNEX A (Operation Overlay).

(2) Be prepared to assume other missions on order.

B. Company F.

(1) On order, deploy from present position along assigned axis of advance, seize northern and western sector of Regimental Objective HOTEL and link up with Company A. See ANNEX A (Operation Overlay).

C. H&S Company.

- (1) General Support.
- (2) Follow in trace of Company F.

D. Company D.

- (1) Battalion Reserve.
- (2) Provide rear and flank security.
- (3) Follow in trace of Battalion Command Group.
- (4) Upon arrival at Regimental Objective HOTEL close defensive positions by making physical contact with Company A and Company F.

E. Coordinating Instructions.

- (1) Limit of advance Phase Line ORANGE.
- (2) H-Hour for planning purposes 1800; D-Day 1 June 1967.
- (3) Coordinating point for Companies A and F is (BT 142300).

SECRET

SECRET

4. ADMINISTRATION AND LOGISTICS. No change.
5. COMMAND AND COMMUNICATIONS. No change.

P. L. HILGARTNER
Lieutenant Colonel
Commanding

ANNEX A - Operation Overlay

OFFICIAL



J. P. WHITE
Major, USMC
Executive Officer

SECRET

SECRET

1st Battalion, 5th Marines
QUE SON, RVN
011 June 1967

ANNEX A (Operation Overlay) to Frag Order 55-67
Ref: (a) Maps, RVN; 1:50,000; Series L 7014; Sheet II - III

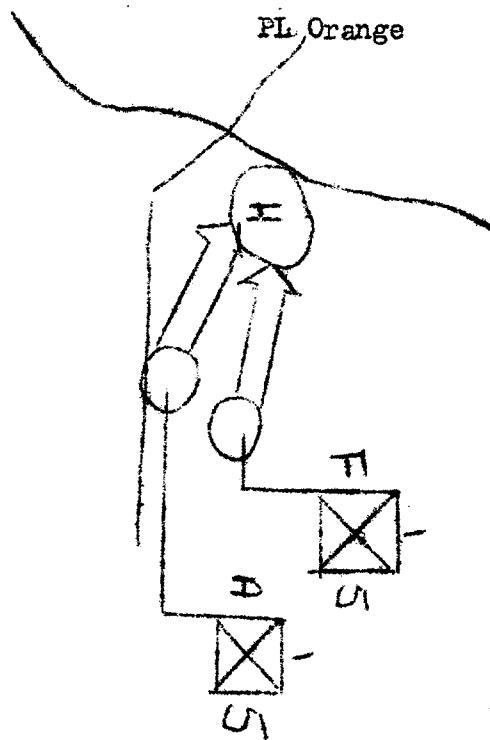
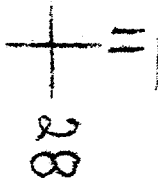

P. L. HILGARTNER
Lieutenant Colonel
Commanding

OFFICIAL

J. P. White

J. P. WHITE
Major, USMC
Executive Officer

SECRET
Enclosure (15)

SECRET

1st Battalion, 5th Marines
 QUE SON, RVN
 012345 June 1967

Frag Order 56-67

Ref: (a) Maps, RVN, 1:50,000; Series L 7014, Sheets 6640 II - III.

1. SITUATION. No change.
2. MISSION. No change.
3. EXECUTION.

A. Company D.

- (1) At 0430 move to attack position Checkpoint #1.
- (2) At H-Hour on order attack to secure Objective 23, search for suspected enemy supply dumps in hamlet located vicinity (BT 138311), continue attack on order.
- (3) Be prepared to assume other missions on order.

B. Company F.

- (1) At H-Hour on order attack to secure Objective 24, continue attack on order.
- (2) Be prepared to assume other missions on order.

C. H&S Company.

- (1) General Support.

D. Company A.

- (1) Battalion Reserve.
- (2) Provide security for Battalion Command Group.
- (3) Move as directed, generally in trace of Company F.
- (4) Be prepared to assume mission of attacking units on order.

E. Coordinating Instructions.

- (1) H-Hour 0500 on order. D-Day 2 June 1967.
- (2) Take salt tablets as prescribed.
- (3) Report all personnel accounted for prior to deployment.
- (4) LOD, Phase Line Orange.
- (5) Cross Phase Lines on order.
- (6) Use RCA in caves, make every effort to get prisoners.
- (7) Rules of engagement apply.

SECRET

SECRET

4. ADMINISTRATION AND LOGISTICS. No change.
5. COMMAND AND COMMUNICATIONS.
 - (a) Red side out for air panels at 0800.
 - (b) Air panels should be distributed throughout unit.

P. L. HILGARTNER
Lieutenant Colonel
Commanding

ANNEXES:

- A - Operation Overlay
- B - Fire Support

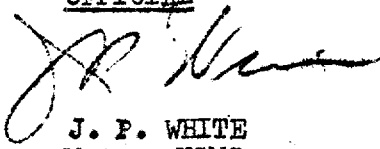
OFFICIAL

J. P. WHITE
Major, USMC
Executive Officer

SECRET

SECRET

ANNEX A (Operation Overlay) to Frag Order 56-67
Ref: (a) Maps, RVN; 1:50,000; Series L 7014,
Sheets 6640 II - III

1st Battalion, 5th Marines
QUE SON, RVN
012345H June 1967

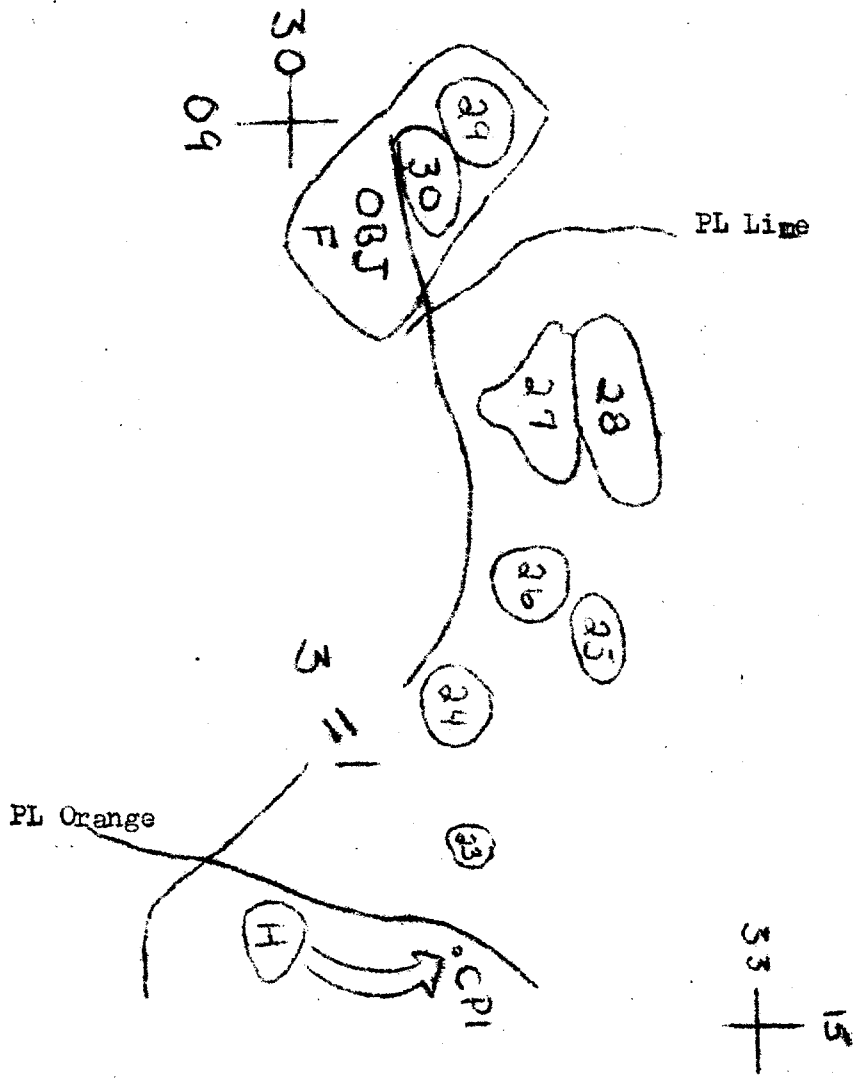

P. L. HILGARTNER
Lieutenant Colonel
Commanding

OFFICIAL

J. P. WHITE
Major, USMC
Executive Officer

SECRET

1st Battalion, 5th Marines
 QUE SON, RVN
 012345H June 1967

ANNEX B (Fire Support Plan) to Frag Order 56-67.

- (1) Artillery preparation fires. See Tab 1 (Fire Support Overlay).
- (2) Air Support.
 - (a) O1-B TAC/A will be available as required for visual reconnaissance of 1st Battalion, 5th Marines operational area as defined in Frag Order 56-67.
 - (b) Fixed wing support will be available as required by 1st Battalion, 5th Marines units for suitable targets.
- (3) Coordinating Instructions.
 - (a) Air will be under control of 1st Battalion, 5th Marines ALO.
 - (b) Decisions on use of air support remains with the Commanding Officer, 1st Battalion, 5th Marines.
 - (c) All air requests must come through the Company FAC Team.
- (4) Preparation Fires.
 - (a) All preparation fires on Objectives 24, 25, 26 will be fired on order about 020450H.
 - (b) All preparation fires on Objectives 27 and 28 will be fired on order as friendly units secure Objective 24.
 - (c) All preparation fires on Objectives 29 and 30 will be fired on order as friendly units secure Objectives 25 and 26.
 - (d) All preparation fires will remain on call.

F. L. HILGARTNER
 Lieutenant Colonel
 Commanding

TAB: 1 - Fire Support Overlay

~~OFFICIAL~~

J. P. White
 J. P. WHITE
 Major, USMC
 Executive Officer

SECRET

B-1

Enclosure (16)

1st Battalion, 5th Marines
QUE SON, RVN
012345H June 1967

SECRET

Tab 1 (Fire Support Overlay) to ANNEX B (Fire Support Plan), to Frag
Order 56-67.

Ref: (a) Maps, RVN; 1:50,000; Series L 7014, sheets 6640 II - III

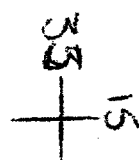
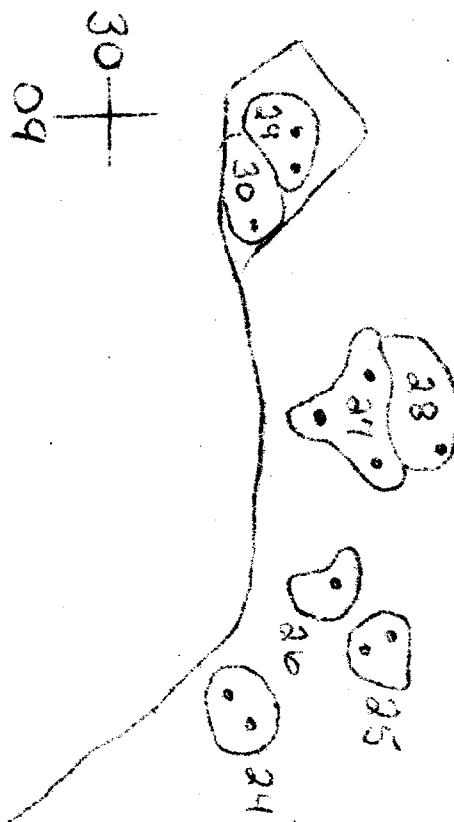

OFFICIAL

J. P. White

J. P. WHITE
Major, USMC
Executive Officer

P. L. HILGARTNER
Lieutenant Colonel
Commanding

B-1-1

SECRET
Enclosure (16)

SECRET

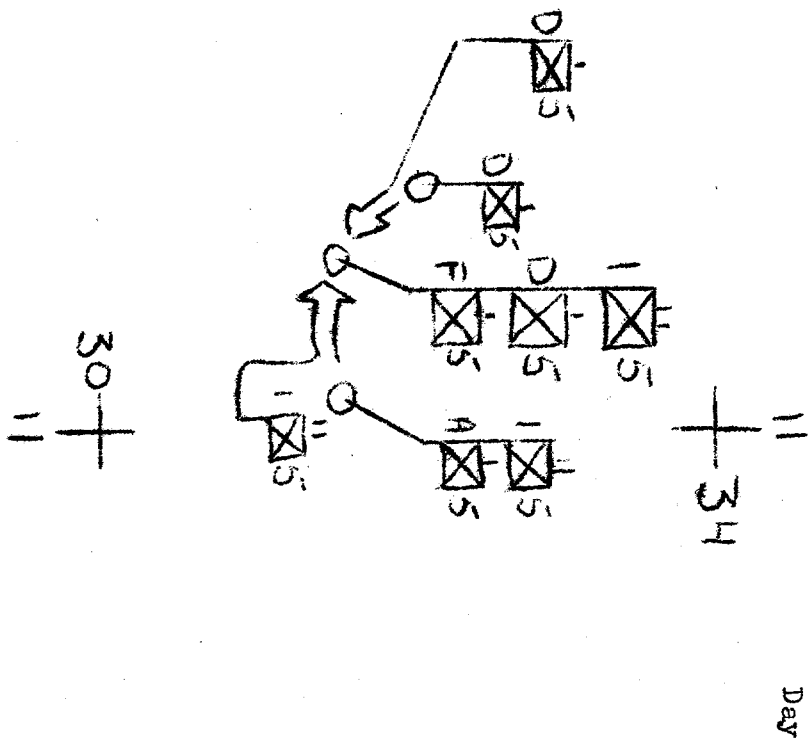

Operation and Night Disposition Overlay D+8
Ref: (a) Maps, IVN; 1:50,000; Series L 7014, Sheets 6640 II - III

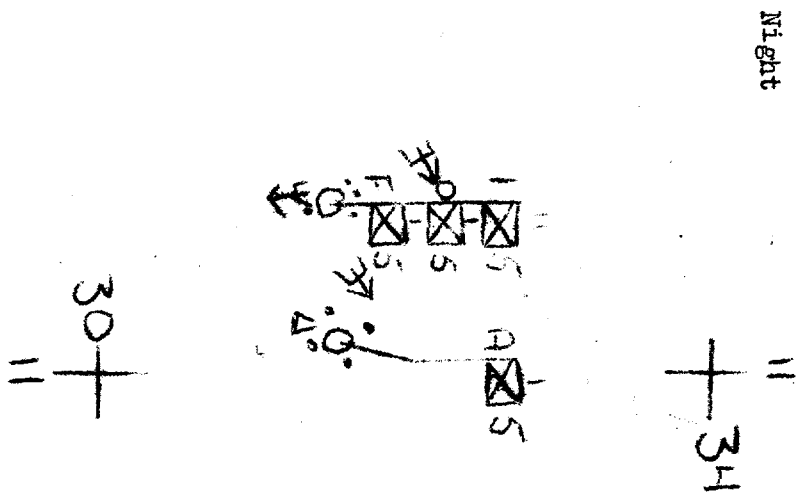

SECRET

Enclosure (18)

SECRET

06
+
31

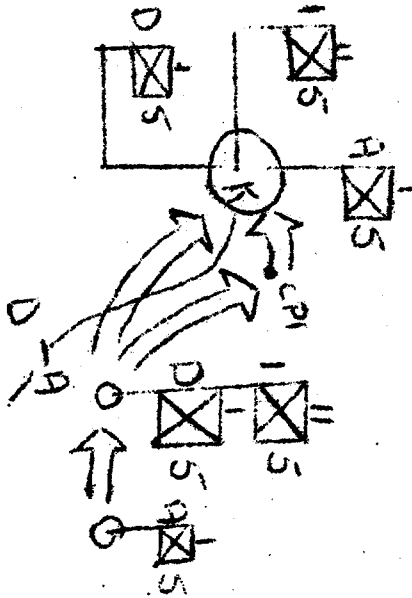

Day

34 +''

Operation and Night Disposition Overlay D-9
Ref: (a) Maps, W/N: 1:50,000; Series L 7014, Sheets 6640 II - III

Night

06
+
31

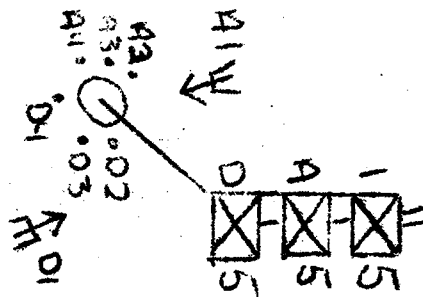

35 +''

SECRET

Enclosure (19)

SECRET

1st Battalion, 5th Marines
 QUE SON, RVN
 041000H June 1967

Frag Order 57-67

Ref: (a) Maps, RVN; 1:50,000; Series L 7014, Sheets 6640 II - III.

1. SITUATION. No change.
2. MISSION. No change.
3. EXECUTION.

A. Company A.

- (1) On order at H-Hour, attack in zone to CP-1, continue attack to Regimental Objective K.
- (2) Be prepared to continue attack on order.
- (3) Be prepared to assume other missions on order.

B. Company D.

- (1) On order at H-Hour, attack in zone to CP-7, continue to Regimental Objective K.
- (2) Be prepared to continue attack on order.
- (3) Be prepared to assume other missions on order.
- (4) Provide flank security for Battalion Command Group.

C. H&S Company.

- (1) General Support.
- (2) Move with Company D.

D. Battalion Reserve.

- (1) Squad from 81's, rear security.

E. Coordinating Instructions.

- (1) H-Hour for planning purposes - 1700.
- (2) All hands take salt tablets as prescribed.
- (3) Conduct thorough search for enemy graves and equipment.
- (4) Using north as 12 o'clock, Company A set in night defensive position from 9 to 3, Company D set in night defensive positions from 3 to 9.
- (5) Unit Commanders submit recommended night activities on arrival at Regimental Objective K.

4. ADMINISTRATION AND LOGISTICS. No change.

SECRET

SECRET

5. COMMAND AND COMMUNICATIONS. No change.

P. L. HILGARTNER
Lieutenant Colonel
Commanding

ANNEX: A-Operation Overlay

OFFICIAL

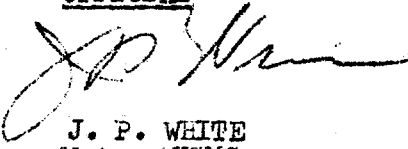

J. P. WHITE
Major, USMC
Executive Officer

SECRET

1st Battalion, 5th Marines
QUE SON, RVN
041000H June 1967

SECRET

ANNEX A (Operation Overlay) to Frag Order 57-67
Ref: (a) Maps, RVN; 1:50,000; series L 7014, sheets 6640 II - III

30
+
07

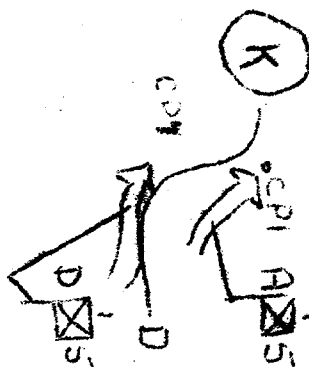

10
+
34

OFFICIAL

J. P. WHITE
Major, USMC
Executive Officer

P. L. HILGARTNER
Lieutenant Colonel
Commanding

SECRET

Enclosure (20)

SECRET

1st Battalion, 5th Marines
 QUE SON, RVN
 4 June 1967

Frag Order 58-67

Ref: (a) Maps, RVN; 1:50,000; Series L 7014, Sheets 6640 II - III.

1. SITUATION. No change.
2. MISSION. No change.
3. EXECUTION.

A. Concept of Operation.

(1) 1st Battalion, 5th Marines follows in trace of 3rd Battalion, 5th Marines to Objective Golf and provides LZ security for helo lift of 3rd Battalion, 5th Marines.

B. Company A.

- (1) On order at H-Hour follow in trace of 3rd Battalion, 5th Marines along axis of advance to Objective Golf. Provide one platoon for LZ security and continue to 1st Battalion, 5th Marines Combat Base.
- (2) Be prepared to assume other missions on order.

C. H&S Company.

- (1) General Support.
- (2) Provide HST for control of 3rd Battalion, 5th Marines helilift at Objective Golf.
- (3) Attach HST to Company A at 050530H.
- (4) Follow in trace of Company A.

D. Company D.

- (1) Battalion Reserve.
- (2) On order at H-Hour, follow in trace of Battalion Command Group along axis of advance.
- (3) Provide flank security for Battalion Command Group.
- (4) Be prepared to assume other missions on order.

E. Coordinating Instructions.

- (1) H-Hour 0600H; D-Day 5 June 1967.
- (2) All personnel take salt tablets.
- (3) Revetment and Stand-To at 0500.

SECRET

SECRET

4. ADMINISTRATION AND LOGISTICS. No change.
5. COMMAND AND COMMUNICATIONS. No change.

P. L. HILGARTNER
Lieutenant Colonel
Commanding

ANNEXES:

- A - Operation Overlay
- B - Fire Support

OFFICIAL

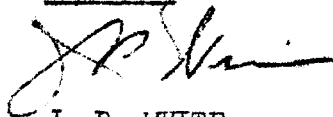

J. P. WHITE
Major, USMC
Executive Officer

SECRET

SECRET

1st Battalion, 5th Marines
QUE SON, RVN
4 June 1967

ANNEX A (Operation Overlay) to Frag Order 58-67
Ref: (a) Maps, RVN; 1:50,000; Series L 7014, Sheets 6640 II - III

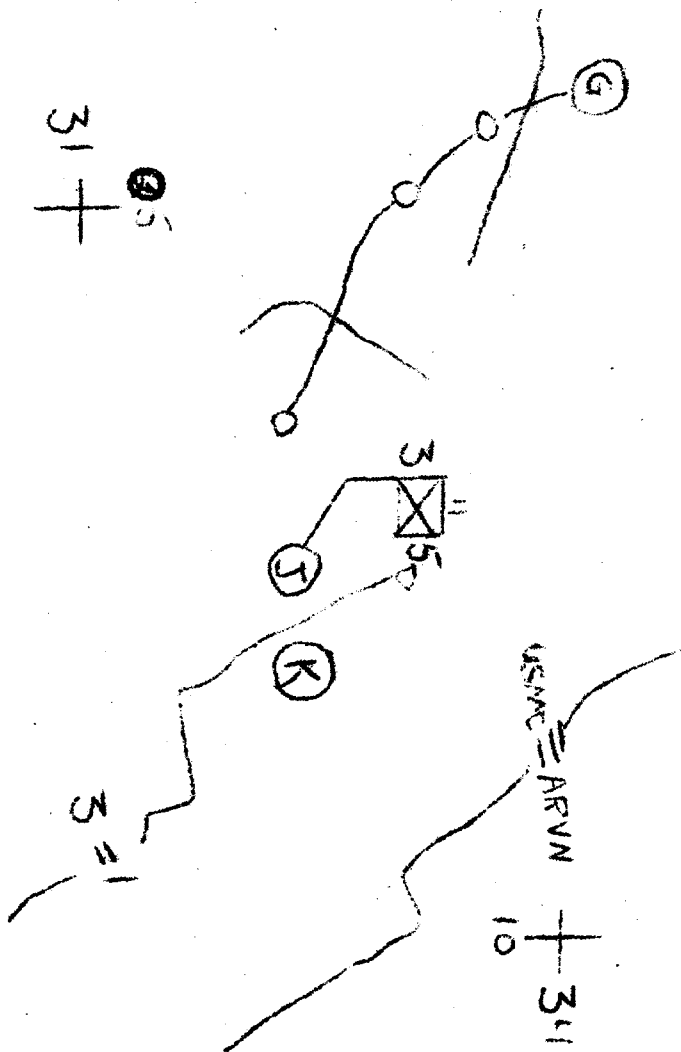

OFFICIAL

J. P. White

J. P. WHITE
Major, USMC
Executive Officer

P. L. HILGARTNER
Lieutenant Colonel
Commanding

A-1

SECRET

Enclosure (21)

SECRET

1st Battalion, 5th Marines
 QUE SON, RVN
 4 June 1967

ANNEX B (Fire Support Plan) to Frag Order 58-67

Ref: (a) Maps, RVN; 1:50,000; Series L 7014, Sheets 6640 II - III.

1. Artillery.

(a) Artillery preparation fires. See Tab 1 (Fire Support Overlay).

2. Air.

(a) O1-E TAC/A will be available on request for visual reconnaissance of 1st Battalion, 5th Marines operational area as defined in Frag Order 58-67.

(b) Fixed wing support will be available as required by 1st Battalion, 5th Marines units for suitable targets.

3. Coordinating Instructions.

(1) Air will be under control of 1st Battalion, 5th Marines ALO.

(2) Decisions for use of air support remains with Commanding Officer, 1st Battalion, 5th Marines.

(3) All air requests must come through Company FAC teams.

P. L. HILGARTNER
 Lieutenant Colonel
 Commanding

TAB: 1 - Fire Support Overlay

OFFICIAL

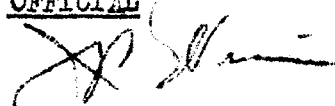
 J. P. WHITE
 Major, USMC
 Executive Officer

SECRET

B-1

Enclosure (21)

SECRET

1st Battalion, 5th Marines
QUE SON, RVN
4 June 1967

Tab 1 (Fire Support Overlay) to Frag Order 58-67

Ref: (a) Maps, RVN, 1:50,000; Series L 7014, Sheets II - III

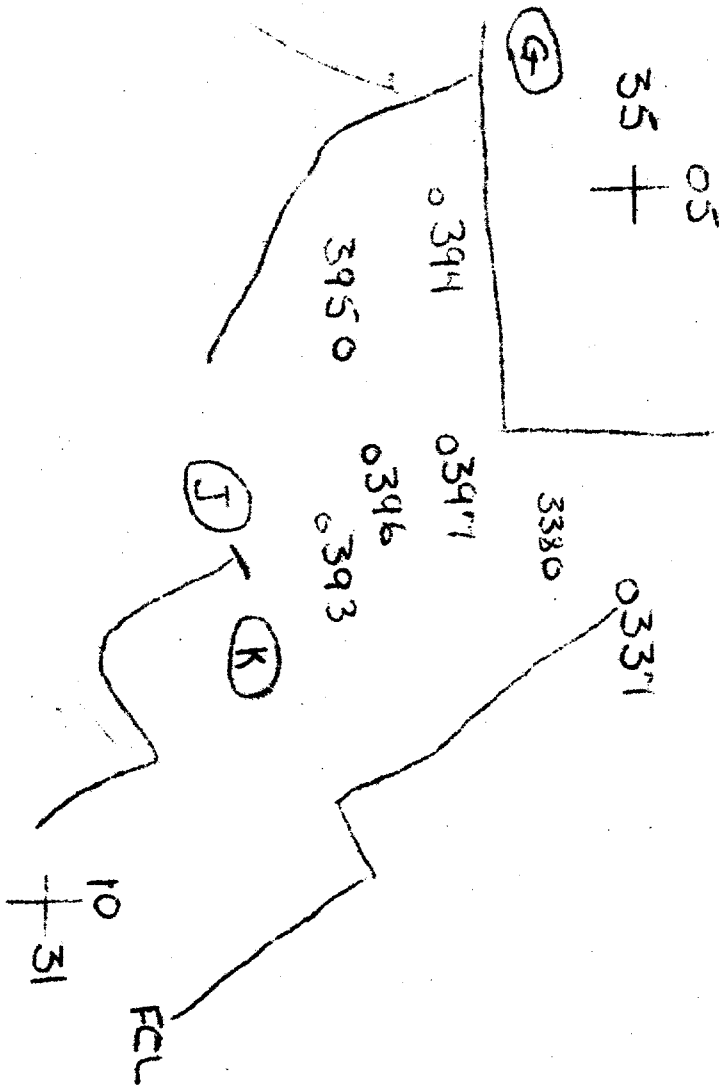

OFFICIAL

J. P. WHITE
Major, USMC
Executive Officer

P. L. HILGARTNER
Lieutenant Colonel
Commanding

B-1-1

SECRET

Enclosure (21)

SECRET

1/5 Combat Base

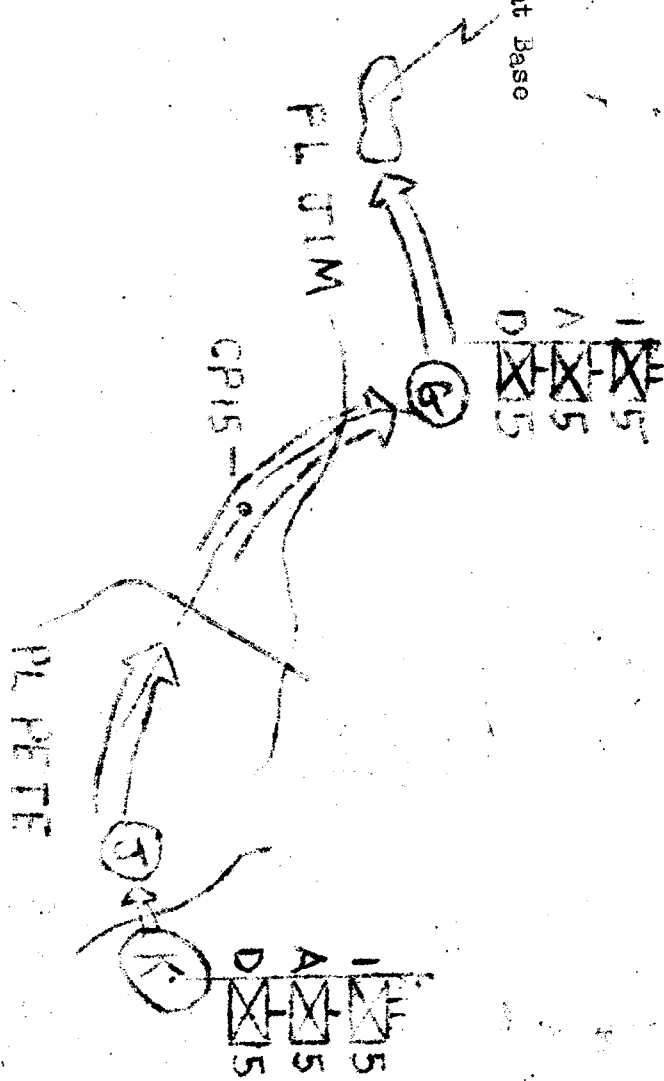

31+
03

Operation Overlay D+10
Ref: (a) maps, INW; 1:50,000; Series L 7014; Sheets II - III

+35
10

SECRET

Enclosure (22)

SECRET

1st Battalion, 5th Marines
 QUÉ SOL RVN
 1 June 1967

Frag Order 51A-67

Ref: (a) Map, RVN; 1:50,000; Series L 7014, Sheet III

Time zone H.

1. SITUATION. No change.
2. MISSION. 1st Battalion, 5th Marines conducts company search and destroy operation to kill or capture VC and weapons, to find and destroy caves, tunnels and fortifications.
4. EXECUTION.
 - a. Company B (-)
 - (1) At 010815H, conduct S&D operations along axis of advance from Combat Base to Objective A.
 - (2) Be prepared to continue attack on order.
 - (3) Be prepared to assume other missions on order.
 - b. Platoon, Company B (Rein)
 - (1) Continue to improve present positions.
 - (2) Continue defense of Combat Base in assigned sector.
 - c. Company C (-)
 - (1) Maintain one platoon on 30 minute standby for emergency Reaction Force.
 - (2) Be prepared to Reinforce Company B (-).
 - (3) Continue defense of Combat Base in assigned sector.
 - (4) Conduct patrol activities as directed.
 - (5) Continue to improve present positions.
 - d. Coordinating Instructions.
 - (1) Reveille - 0500H.
 - (2) Stand-To 0530H-0630H.
 - (3) Extensive use of RCA and demolitions directed on caves.
 - (4) For objectives; See Annex A (Operation Overlay).

SECRET

4. ADMINISTRATION AND LOGISTICS. No change.

5. COMMAND AND COMMUNICATIONS. No change.

P. L. HILGARTNER
Lieutenant Colonel
Commanding

ANNEX: A (Operation Overlay)

OFFICIAL

C. H. Black
C. H. BLACK
Major, USMC

S-3

SECRET

1st Battalion, 5th Marines
QUANG BINH, RVN
1 June 1967

Annex A (Operation Overlay) to Frag Order 51A-67

Ref: (a) Maps: RVN; 1:50,000; Series L7014; Sheet III

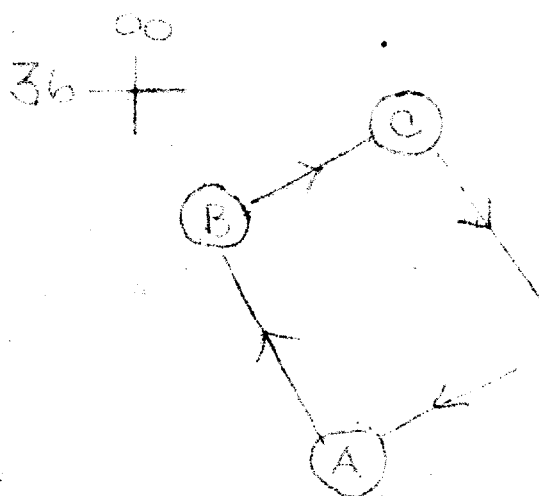

04
+ 32

P. L. HILGARDNER
Lieutenant Colonel
Commanding

OFFICIAL

C. H. BLACK
Major, USMC
S-3

Tab (b) to
enclosure (1)

SECRET

SECRET

1st Battalion, 5th Marines
 QUÉ SON, RVN
 5 June 1967

Frag Order 59-67

Ref: (a) Map, RVN; 1:50,000; Series L 7014, Sheets II-III

Time zone H.

Task Organization effective 050600H June 1967.

Company B (-) (Rein)

CAPT J. D. REESE

Company B (-)

Det, Co B, 1stSPBn

Det, Co B, 1stEngrBn

Det Hq Co, 5thMar (Scout Sniper Tm)

Det, H&S Co, 1stBn, 5thMar

S1 FO Tm

Det, Med Plt

Det, Comm Plt

FAC Tm

S-2 Scout

Kit Carson Tm

1. SITUATION. No change.

2. MISSION. 1st Battalion, 5th Marines conducts company search and destroy operation to kill or capture VC and weapons, to find and destroy caves, tunnels and fortifications.

3. EXECUTION.

a. Concept of Operation. 1st Battalion, 5th Marines conducts company size search and destroy operation.

b. Company B.

(1) At H-Hour commence S&D operations along axis of advance to sieze Objective A, set up night positions and conduct night activities.

(2) Be prepared to continue attack on order.

(3) Be prepared to assume other missions as directed.

c. H&S Company.

(1) General Support.

SECRETd. Company C.

- (1) Battalion Reserve; on 30 minute alert.
- (2) Be prepared to assume Company B's mission on order.
- (3) Be prepared to assume other missions as directed.

e. Coordinating Instructions.

- (1) H-Hour 1800.
- (2) Flak jackets optional.
- (3) Use of RC. Authorized and encouraged.
- (4) Carry three gas mask per rifle squad.
- (5) Position reports hourly at 10 minutes before the hour.
- (6) Submit recommended night activities on arrival at objective.

4. ADMINISTRATION AND LOGISTICS. No change.5. COMMAND AND COMMUNICATIONS.

a. Carry hand illumination, color smoke grenades and air panels.

P. L. HILGARTNER
Lieutenant Colonel
Commanding

ANNEX: A (Operation Overlay)
B (Fire Support Plan)

OFFICIAL

C. H. BLACK
Major, USMC
S-3

Tab (C) to
Enclosure (1)
SECRET

SECRET

1st Battalion, 5th Marines
CUE AN, RVN
7 June 1967

Annex A (Operation Overlay) to Frag Order 59-67

Ref: (a) Maps: RVN; 1:50,000; Series L7014, Sheets II-III

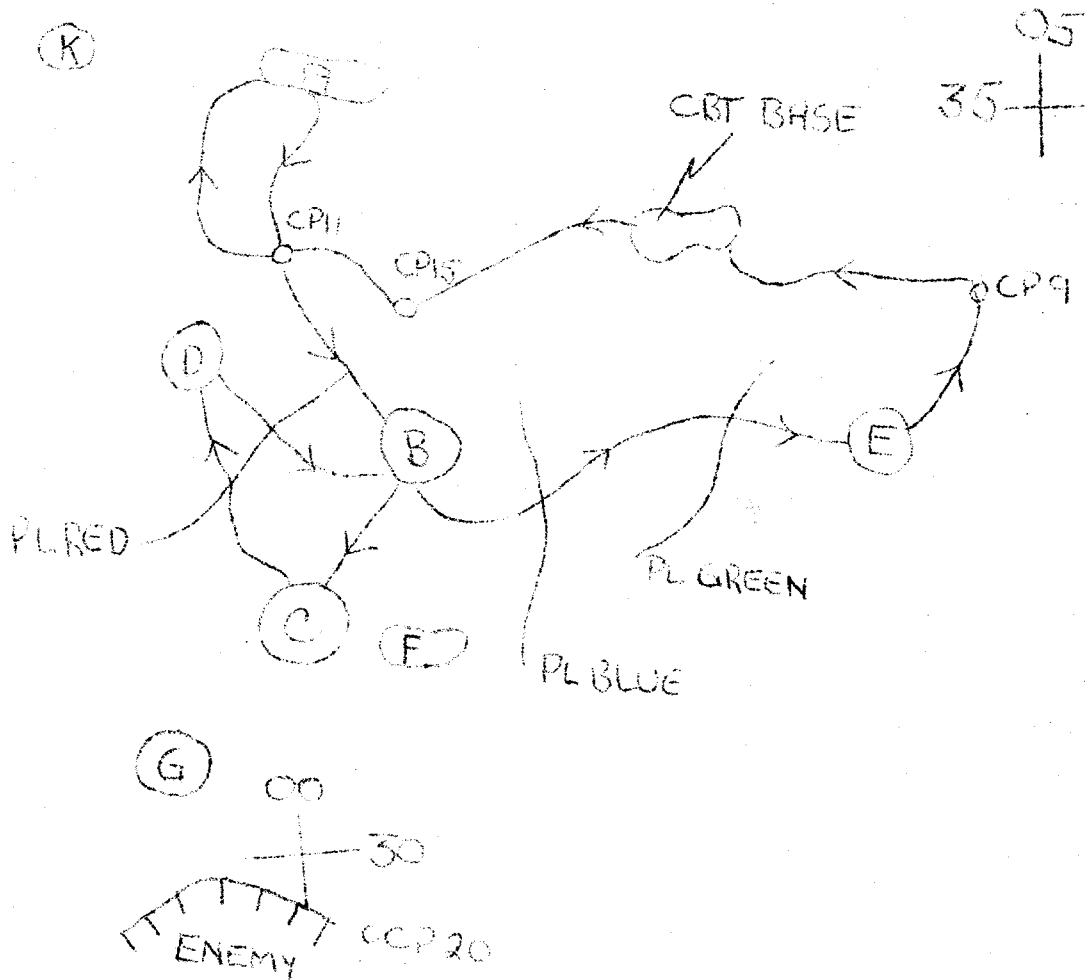

P. L. HILGARTNER
Lieutenant Colonel
Commanding

OFFICIAL

G. H. BLACK
Major, USMC
S-3

Tab C to
Enclosure (1)
SECRET

SECRET

1st Battalion, 5th Marines
QUE SON, VN
5 June 1967

Annex B (Fire Support Plan) to Frag Order 59-67

Ref: (a) Maps, RVN; 1:50,000; Series L7014, Sheets II-III

1. Artillery.

a. Preplanned on call fires to be fired by Company B when necessary in movement to Objective A. See Tab (1) (Fire Support Plan)

2. Air.

a. AO will be available as required for visual reconnaissance of Company B operational area.

b. Fixed wing support will be available as required.

c. Coordinating Instructions.

(1) All air will be under the control of the Air Liaison Officer.

(2) All air request will be channelled through the Company FAC Team.

P. L. HILGARTNER
Lieutenant Colonel
Commanding

Tab (1) (Fire Support Overlay)

OFFICIAL

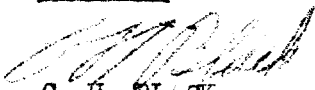
C. H. BLACK
Major, USMC
S-3

Tab (c) to
Enclosure (1)

SECRET

SECRET

1st Battalion, 5th Marines
Camp SON, RVN
5 June 1967

Tab 1 (Fire Support Overlay) to Annex B (Fire Support Plan)

Ref: (a) Maps: RVN; 1:50,000; Series L7014, Sheets II-III

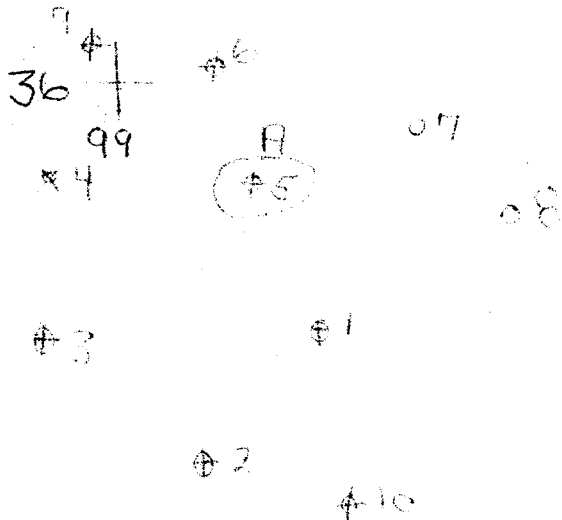

P. L. HILGARTNER
Lieutenant Colonel
Commanding

05
+ 32

OFFICIAL

G. H. Black
G. H. BLACK
Major, USMC
S-3

Tab (c) to
Enclosure (1)

SECRET

SECRET

1st Battalion, 5th Marines
 QUE SON, RVN
 6 June 1967

Frag Order 61-67

Ref: (a) Maps, RVN; 1:50,000, Series L 7014, Sheet III

Time zone H.

1. SITUATION. No change.
2. MISSION. 1st Battalion, 5th Marines conducts company search and destroy operation to kill or capture VC and weapons, to find and destroy caves, tunnels and fortifications.
3. EXECUTION.
 - a. Concept of Operation. Conduct reinforced platoon coordinated, combined search and destroy operation.
 - b. Company .
 - (1) Conduct platoon (Rein) S&D operation in coordination with PF forces from QUE SON District to secure Objective J. Thoroughly search objective area to clear and destroy caves, fortifications and locate possible enemy mortar sites.
 - (2) Be prepared to continue attack on order.
 - (3) Be prepared to assume other missions on order.
 - c. H&S Company.
 - (1) General Support.
 - (2) Provide engineer personnel and equipment for cave and fortification destruction.
 - d. Company D (-).
 - (1) Battalion Reserve.
 - (2) On 30 minute alert.
 - (3) Be prepared to assume other missions on order.
 - e. Coordinating Instructions.
 - (1) H-Hour: 0630H.
 - (2) D-Day: 7 June 1967.
 - (3) PF to arrive at Combat Base maingate at 0630H.
 - (4) Platoon to have engineer, FO, FAC Tm and interpreter capabilities.
 - (5) Objective J is located at (BT 014365).

SECRET

4. ADMINISTRATION AND LOGISTICS.

- a. Each individual will carry 2 MCI'S and 3 full canteens.
- b. All personnel will take salt tablets.

5. COMMAND AND COMMUNICATIONS. No change.

P. L. HILGARTNER
Lieutenant Colonel
Commanding

OFFICIAL

of (U) dsP
(h) signature
C. H. BLACK
Major, USMC
S-3

of (U) dsP
(h) signature

SECRET

1st Battalion, 5th Marines
 LANH WONG, RVN
 27 June 1967

Frag Order 62-67

Ref: (a) Map, RVN; 1:50,000; Series L 7014, Sheet II-III

Time zone H.

1. SITUATION. No change.

2. MISSION. 1st Battalion, 5th Marines conducts company search and destroy operation to kill or capture VC and weapons, to find and destroy caves, tunnels and fortifications.

3. EXECUTION.

a. Concept of Operation. 1st Battalion, 5th Marines relieves Company (-)(Rein) at NUI LAC SON with Company (-)(Rein) and conduct company search and destroy operations to Objective G and L. Prepare to continue attack on order.

b. Company D.

Attachments
 Det, H&S Company
 81 FO Tm
 FAC Tm
 Det, Comm Plt
 Det, Med Plt
 S-2 Scout
 Kit Carson Tm
 Scout Sniper Tm
 Det, Co B, 1stSPBn
 Det, Btry D, 2ndBn, 11thMar
 Plt, Co C (-)

(1) On order at H-Hour commence move to Objective N along axis of advance, relieve Company C at Objective M, and assume responsibility for combat base at that position.

(2) Actively patrol from combat base.

(3) Platoon, Company C (-) detached on arrival Objective M.

(4) Be prepared to assume other missions on order.

(5) Work with RF/PF units in area as feasible.

c. Company C.

Attachments

SECRET

Det, H&S Co
 81 FO Tm
 FAC Tm
 Det, Comm Plt
 Det, Med Plt
 S-2 Scout
 Kit Carson Tm
 Det, Co B, 1st Engr Bn
 Det, Co B, 1st SPBn
 Det, Btry D, 2nd Bn, 11th Mar

(1) On order when relieved by Company D, conduct search and destroy operations to Objective G, continue attack on order along axis of advance of Objective L, be prepared to continue attack on order.

(2) Be prepared to assume other missions on order.

(3) Det, H&S Co
 81 Mortar Section
 106 RR Section
 Det, Mess Section

Detached to Company D on relief of Company C by Company D.

d. Company B.

- (1) Battalion Reserve.
- (2) Occupy defensive positions on Combat Base as directed.
- (3) Be prepared to assume other missions on order.

e. Coordinating Instructions.

- (1) H-Hour 0500H, D-Day 8 June 1967.
- (2) Take salt tablets.
- (3) Use of RCM authorized and encouraged.
- (4) Reports:

(a) Position reports hourly at 10 minutes before the hour.

(5) When moving, take maximum advantage of covered routes offered by the terrain.

(6) Objectives from Frag Order 59-67 remain in effect.

(7) Companies coordinate fire support plans with Battalion FSCC.

4. ADMINISTRATION AND LOGISTICS.

- a. Carry one gas mask per man.
- b. Flak jackets optional.
- c. 5 MCI's per man.

SECRET

5. COMMAND AND COMMUNICATIONS.

- a. Take hand illumination, colored smoke grenades and air panels.

P. L. HILGARTNER
Lieutenant Colonel
Commanding

ANNEX: A (Operation Overlay)

OFFICIAL

G. H. Black
G. H. BLACK
Major, USMC
S-3

SECRET

1st Battalion, 5th Marines
QUANG BINH, RVN
7 June 1967

Annex A (Operation Overlay) to Frag Order 62-67

Ref: (a) Maps: RVN; 1:50,000; Series L7014, Sheet III

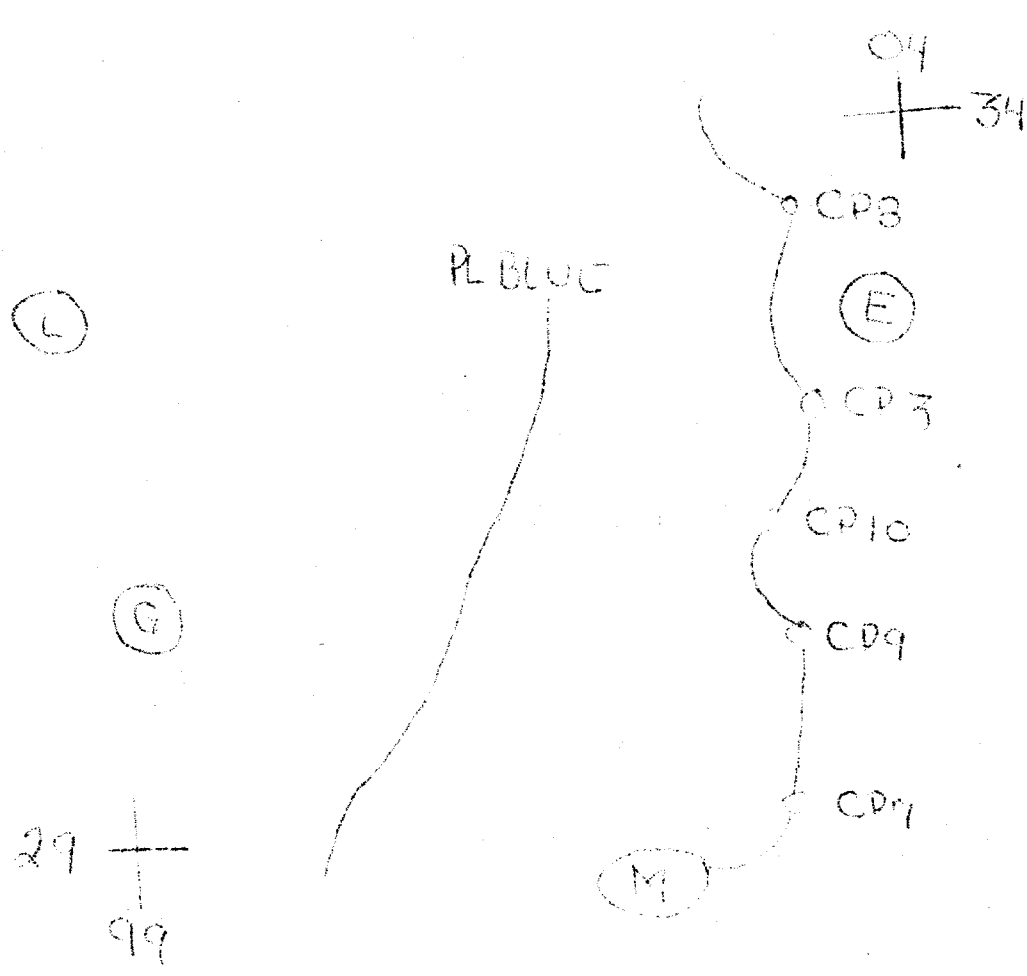

P. L. HILGARTNER
Lieutenant Colonel
Commanding

OFFICIAL

[Signature]
G. H. BLACK
Major, USMC
S-3

Tab (E) to
Enclosure (1)
SECRET

SECRET

1st Battalion, 5th Marines
 QUANG BINH, RVN
 9 June 1967

Frag Order 63-67

Ref: (a) Map, RVN; 1:50,000; Series L 7014, Sheet II-III

Time zone H.

1. SITUATION.

a. Enemy. Interrogation of detainees indicates that approximately 20 VC are living in village of LANH THUONG (2) vicinity coordinates (BT 015345).

2. MISSION. 1st Battalion, 5th Marines conducts search and destroy operations to kill or capture VC and weapons; to destroy caves and tunnels and fortifications.

3. EXECUTION.

a. Concept of Operation. Conduct a Company (-) patrol to LANH THUONG (2) vicinity coordinates (BT 015345), to thoroughly search area and kill or capture VC in the area.

b. Company B.

Attachments

Det, H&S Co

81 FO Tm

FAC Tm

Det, Comm Plt

Det, Med Plt

S-2 Scout

Kit Carson Scout (2 Teams)

Interpreter

Det, Hqs Co, 1stBn, 5thMar (Scout Sniper, Interpreter)

Det, Co B, 1stEngrBn

Det, Btry D, 2ndBn, 11thMar

Det, Co B, 1stSPBn

(1) At H-Hour commence movement to LANH THUONG (2) vicinity coordinates (BT 015345); conduct thorough search to apprehend VC and VCS in area.

(2) Be prepared to assume other missions on order.

c. Battalion Reserve.

(1) Platoon Company B.

(2) Be prepared to assume other missions on order.

SECRET

d. Coordinating Instructions.

- (1) H-Hour 0630 for planning purposes. D-Day 10 June 1967.
- (2) Use of RC. authorized and encouraged.
- (3) Pickup PF guides at gate I at 0630.
- (4) Coordinate fire support with FSCC.

4. ADMINISTRATION AND LOGISTICS.

- a. One gas mask per man.
- b. 40 pounds of demolitions will be carried.
- c. Flak jackets optional.
- d. Take salt tablets.
- e. Packs and 5 MCI's per man.
- f. Take available RC. grenades.

5. COMMAND AND COMMUNICATIONS.

- a. Take air panels and colored smoke.

P. L. HILGARTNER
Lieutenant Colonel
Commanding

OFFICIAL

C. H. BLACK
Major, USMC
S-3

SECRET

1st Battalion, 5th Marines
QUANG BINH, RVN
9 June 1967

Appendix 1 (Fire Support Overlay) to Frag Order 63-67

Ref: (a) Maps: RVN; 1:50,000, Series L7014, Sheets II-III

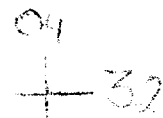
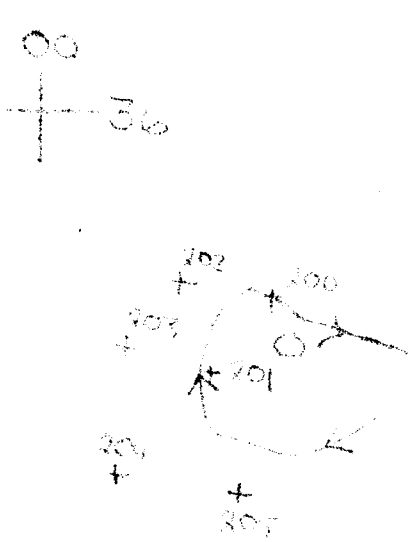

P. L. HILGARTNER
Lieutenant Colonel
Commanding

OFFICIAL

C. H. Black
C. H. BLACK
Major, USMC
S-3

A-1

Tab (F) to
Enclosure (1)

A-1

SECRET

SECRET

1st Battalion, 5th Marines
 QUE SON, RVN
 10 June 1967

Frag Order 64-67

Ref: (a) Map, RVN; 1:50,000; Series L 7014; Sheet II-III

Time zone H.

1. SITUATION. No change.
2. MISSION. 1st Battalion, 5th Marines conducts combined search and destroy operation to kill or capture VC and weapons; to destroy caves, tunnels and fortifications.
3. EXECUTION.
 - a. Concept of Operation. 1st Battalion, 5th Marines conducts Company (-)(Rein) operation to secure assigned objectives, to search for enemy mortar positions and enemy harboring sites.
 - b. Company B.
 - (1) At H-Hour attack to seize Objective R, be prepared to continue attack on order.
 - (2) Be prepared to assume other missions on order.
 - c. Company A.
 - (1) Battalion Reserve.
 - (2) Be prepared to assume other missions as directed.
 - d. Coordinating Instructions.
 - (1) H-Hour 1800H; D-Day 10 June 1967.
 - (2) Use of RCA authorized and encouraged.
 - (3) Position reports hourly 10 minutes before the hour.
 - (4) When moving, take maximum advantage of covered routes offered by terrain.
 - (5) Companies coordinate fire support plans with Battalion FSOC.
 - (6) Linkup with PF Platoon at gate 11 on departure of Combat Base.
4. ADMINISTRATION AND LOGISTICS.
 - a. Carry one gas mask per man.
 - b. Flak jackets optional.
 - c. 5 MCI's per man.
 - d. Take salt tablets.
 - e. Engineers carry 10 pounds of demolitions per man.

SECRET

5. COMMAND AND COMMUNICATIONS.

- a. Take hand illumination, colored smoke grenades and air panels.

P. L. HILGARTNER
Lieutenant Colonel
Commanding

ANNEX:A (Operation Overlay)

OFFICIAL

C. H. Black
C. H. BLACK
Major, USMC
S-3

SECRET

1st Battalion, 5th Marines
QUE SON, RVN
10 June 1967

Annex A (Operation Overlay) to Frag Order 64-67

Ref: (a) Maps: RVN; 1:50,000, Series L7014, Sheets II-III

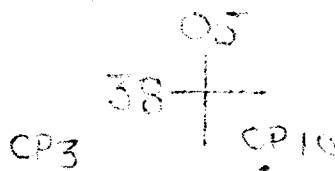

(X)

(u)

(T)

CP7

(R)

(S)

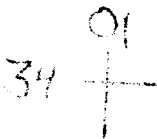

P. L. HILGARTNER
Lieutenant Colonel
Commanding

OFFICIAL

C. H. Black

C. H. BLACK
Major, USMC
S-3

Tab (g) to
ENCLOSURE (1)

SECRET

SECRET

1st Battalion, 5th Marines
QUE SON, RVN
10 June 1967

Appendix 1 (Fire Support Overlay) to Frag Order 64-67

Ref: (a) Maps: RVN; 1:50,000; Series L7014, Sheets II-III

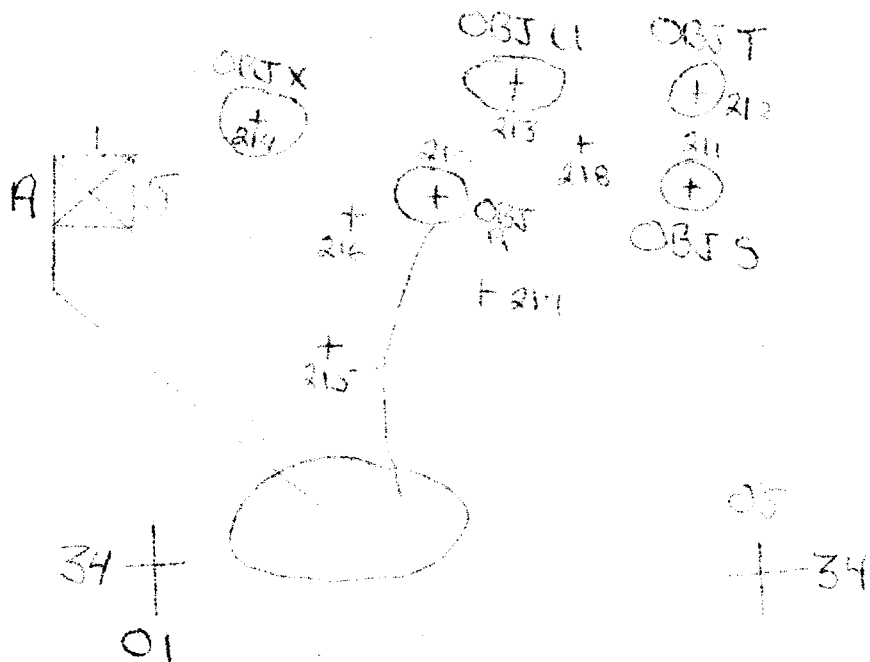

P. L. HILGARTNER
Lieutenant Colonel
Commanding

OFFICIAL

C. H. BLACK
Major, USMC
S-3

Tab (g) to
Enclosure (1)

SECRET

SECRET

1st Battalion, 5th Marines
QLE S RVN
10 June 1967

Frag Order 65-67

Ref: (a) Map, RVN; 1:50,000; Series L 7014, Sheet II-KII

Time zone H.

1. SITUATION. No change.
2. MISSION. Conduct platoon reinforced patrol to provide security for polling places.
3. EXECUTION.
 - a. Conduct platoon (Rein) patrol to provide security for polling area in keeping with US policy of non-attachment with political activities.
 - b. Company A.
 - (1) Conduct platoon (Rein) patrol. See Tab (H) (Operation Overlay).
 - c. Company A (-)
 - (1) Battalion Reserve.
 - (2) be prepared to assume other missions on order.
 - d. Coordinating Instructions.
 - (1) For route of patrol see Operation Overlay.
 - (2) H-Hour 0700 11 June 1967.
4. ADMINISTRATION AND LOGISTICS. No change.
5. COMMAND AND COMMUNICATIONS. No change.

P. L. HILGARTNER
Lieutenant Colonel
Commanding

ANNEX: A (Operation Overlay)

OFFICIALC. H. BLACK
Major, USMC

S-3

1

Tab (H) to
Enclosure (1)

SECRET

SECRET

1st Battalion, 5th Marines
QUE SON, RVN
10 June 1967

Annex A (Operation Overlay) to Frag Order 65-67

Ref: (a) Maps: RVN; 1:50,000; Series L7014, Sheets III

+ 37
02

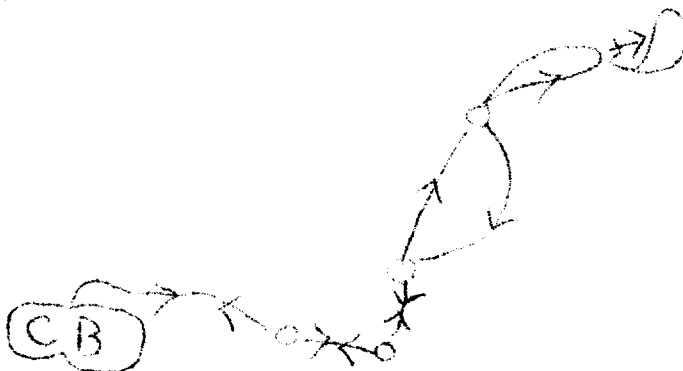

07
+ 33

P. L. HILGARTNER
Lieutenant Colonel
Commanding

OFFICIAL

[Signature]
G. H. BLACK
Major, USMC
S-3

Tab (H) to
Enclosure (1)
Secret

SECRET

1st Battalion, 5th Marines
 QUU SON, RVN
 12 June 1967

Frag Order 66-67

Ref: (a) Map, RVN; 1:50,000; Series L 7014, Sheet II-III

Time zone H.

Task Organization

Company A.

Det, H&S Company

81 FO Tm

PLC Tm

Det, Comm Plt

Det, Med Plt

S-2 Scout

Kit Carson Tm

Det, HqCo, 5th Marines (Scout Sniper)

Det, Company B, 1st EngrBn

Det, Company B, 1stSPBn

Det, Btry D, 2ndBn, 11th Marines

1. SITUATION.

a. Enemy. Intelligence sources indicate that there are 7 caves where VC cadre are located, 2 rice caches and an enemy duty company in the vicinity of XUAN QUU Hamlet. Quang Nam C. G. Studies Center Chief 974 of 31 May 1967.

b. Friendly. No change.

2. MISSION. 1st Battalion, 5th Marines conducts search and destroy operations to kill or capture VC and weapons; to destroy caves, tunnels and fortifications.

3. EXECUTION.

a. Concept. 1st Battalion, 5th Marines conducts one company search and destroy operation to vicinity of Objective Z, secures patrol base and conducts detailed search of area of operations. Prepares to continue attack on order.

b. Company A.

(1) At H-Hour attack to seize Objective Z, secure patrol base and conduct detailed search of the area of operations, prepare to continue attack on order.

(2) Be prepared to assume other missions on order.

SECRET

- c. H&S Company: General Support.
- d. Company C.
 - (1) Battalion Reserve.
 - (2) Be prepared to assume other missions on order.
- e. Coordinating Instructions.
 - (1) H-Hour 1400H, D-Day 13 June 1967.
 - (2) Use of RCL authorized and encouraged.
 - (3) Position reports hourly 10 minutes before the hour.
 - (4) Coordinate fire support plan with Battalion FSCG.
 - (5) Submit night activities by 1300 daily. Submit patrol activities for next day by 1400.

4. ADMINISTRATION AND LOGISTICS.

- a. Carry one gas mask per man.
- b. Flak jackets optional.
- c. 5 MCI's per man.
- d. Engineers carry 10 pounds demolitions per man.
- e. Take salt tablets.

5. COMMAND AND COMMUNICATIONS.

- a. Take hand illumination, colored smoke grenades and air panels.

P. L. HILGARTNER
Lieutenant Colonel
Commanding

- ANNEX: A (Operational Overlay)
- B (Fire Support Plan)(to be issued)

OFFICIAL

C. H. Black
C. H. BLACK
Major, USMC
S-3

SECRET

1st Battalion, 5th Marines
QUE SON, VN
12 June 1967

Annex A (Operation Overlay) to Frag Order 66-67

Ref: (a) Maps: RVN; 1:50,000; Series L7014, Sheets II-III

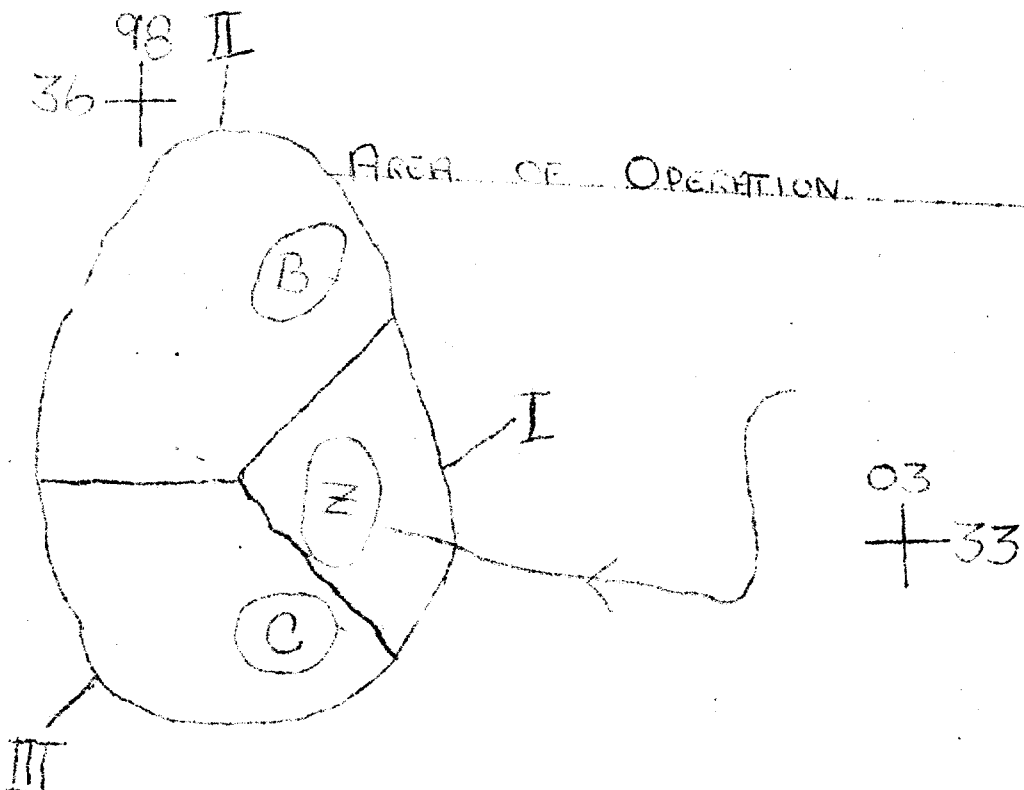

P. L. HILGARTNER
Lieutenant Colonel
Commanding

OFFICIAL

[Handwritten signature]

C. H. BLACK
Major, USMC
S-3

Tab (I) to
Enclosure (1)
Secret

SECRET

1st Battalion, 5th Marines
QUEBON, RVN
12 June 1967

Annex B (Fire Support Plan) to Frag Order 66-67

Ref: (a) Maps: RVN; 1:50,000; Series L7014, Sheets II-III

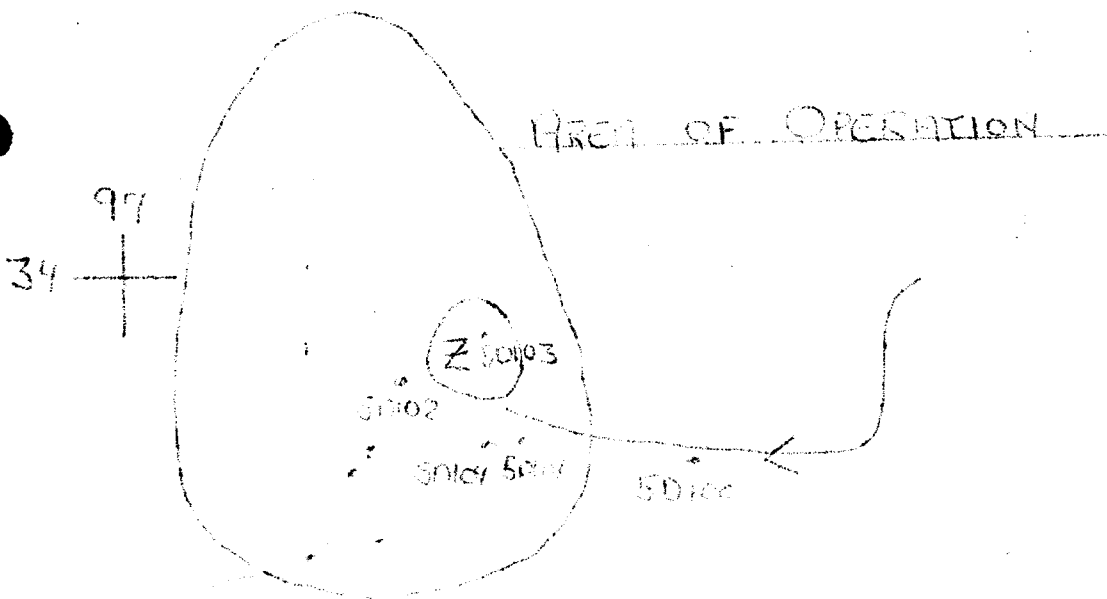

P. L. HILGARTNER
Lieutenant Colonel
Commanding

31 +
04

OFFICIAL

C. H. Black
C. H. BLACK
Major, USMC
S-3

Tab (I) to
Enclosure (1)
SECRET

HEADQUARTERS

1st Battalion, 5th Marines
1st Marine Division (Rein) FMF
FPO, San Francisco, 96602

DECLASSIFIED

3/CMB/glk

3480

12 July 1967

00186-67

Copy 1 of 23 copies.~~SECRET~~

From: Commanding Officer
To: Commanding General, 1st Marine Division (Rein) FMF
Via: Commanding Officer, 5th Marines
Subj: Combat After Action Report; Operation "ADAIR"

Ref: (a) DivO 3480.1
(b) 5th Marines Frag Order 39-67
(c) 5th Marines Frag Order 40-67
(d) 5th Marines Frag Order 41-67
(e) 5th Marines Frag Order 42-67
(f) 5th Marines Frag Order 43-67
(g) 5th Marines Frag Order 44-67

Encl: ✓ (1) 1st Battalion, 5th Marines Frag Order 67-67
✓ (2) Movement and Night Disposition Overlay D-Day
✓ (3) 1st Battalion, 5th Marines Frag Order 68-67
✓ (4) 1st Battalion, 5th Marines Frag Order 69-67
✓ (5) Movement and Night Disposition Overlay D+1
✓ (6) 1st Battalion, 5th Marines Frag Order 70-67
✓ (7) Movement and Night Disposition Overlay D+2
✓ (8) 1st Battalion, 5th Marines Frag Order 71-67
✓ (9) Movement and Night Disposition Overlay D+3
✓ (10) 1st Battalion, 5th Marines Frag Order 72-67
✓ (11) Movement and Night Disposition Overlay D+4
✓ (12) Movement and Night Disposition Overlay D+5
✓ (13) 1st Battalion, 5th Marines Frag Order 73-67
✓ (14) Movement and Night Disposition Overlay D+6
✓ (15) 1st Battalion, 5th Marines Frag Order 74-67
✓ (16) 1st Battalion, 5th Marines Frag Order 74A-67
✓ (17) Modification to 1st Battalion, 5th Marines Frag Order 74-67
✓ (18) Movement and Night Disposition Overlay D+7
✓ (19) 1st Battalion, 5th Marines Frag Order 75-67
✓ (20) Movement and Night Disposition Overlay D+8

5TH MAR S&C FILES

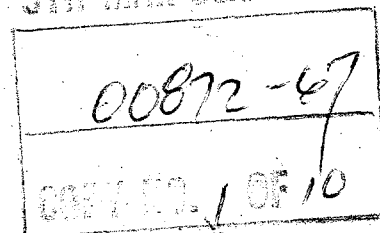
1. Code Name.

Operation ADAIR (Search and Destroy)

2. Date of Operation.

a. 151519H to 242400H June 1967.

DOWNGRADE AT 5 YEAR INTERVALS;
DECLASSIFY AT 10 YEARS.
DOD DIR S20010

~~DECLASSIFIED~~
~~SECRET~~

DECLASSIFIED

b. 1st Battalion, 5th Marines were actively committed to Operation ADAIR at 151519H June 1967.

3. Location. Initially the Battalion landed by helicopter in a landing zone located in grid square (BT 1034) in THANG BINH District; QUANG TIN Province, RVN. During 15-18 June 1967, the Battalion conducted Operation ADAIR in THANG BINH District from the landing zone moving in a southeasterly direction to THANH YEN Hamlet (BT 145325), to a westerly direction to Hill 63 (BT 083329), to a northeasterly direction along road to a fording site located at (BT 123370). In the vicinity of the fording site, the Battalion crossed the SONG LY LY River, which is the boundary from QUANG TIN and QUANG NAM Province. The attack was continued in a northwesterly direction into QUE SON District; QUANG NAM Province, to vicinity Hill 131 (BT 064395) moving westerly along valley to vicinity Hill 381 (AT 994392), to a southerly direction to vicinity GS (AT 9733) and easterly to the combat base, located in QUE SON District QUANG NAM Province RVN, in vicinity (BT 025343).

4. Control or Command Headquarters.

1st Battalion, 5th Marines (-)(Rein)	LTCOL HILGARTNER
1st Battalion, 5th Marines (-)(Rein)(Rear)	MAJ WHITE
H&S Company, 1st Battalion, 5th Marines (-)(Rear)	CAPT LYLES
Company A, 1st Battalion, 5th Marines (-)(Rein)	CAPT BRODIE
Company B, 1st Battalion, 5th Marines (-)(Rein)	CAPT REESE
Company C, 1st Battalion, 5th Marines (-)(Rein)	CAPT JOHNSON
Company D, 1st Battalion, 5th Marines (-)(Rein)	1STLT MCINTURFF
Company L, 3rd Battalion, 5th Marines	CAPT PITTEGILL

5. Task Organization.

1st Battalion, 5th Marines (-)(Rein)	LTCOL HILGARTNER
1st Battalion, 5th Marines (-)(Rein)(Rear)	MAJ WHITE
H&S Company, 1st Battalion, 5th Marines	
Company A, 1st Battalion, 5th Marines (-)(Rein)	
Company D, 1st Battalion, 5th Marines (-)(Rein)	
Det, H&S Company, 1st Battalion, 5th Marines (-)(Rein)	CAPT LYLES
Det, 1st Plat, Company B, 1stSPBn	
Det, Btry D, 2ndBn, 11thMar	
Det, 1st Plat, Company B, 1stEngrBn	
H&S Company (-)	
Det, 106 Plat	
Det, 81 Plat	

DECLASSIFIED

DECLASSIFIED

Det, Flame S
 Det, Med Plat
 Det, Comm Plat
 Det, Service Plat
 Det, Kit Carson Tm
 Det, ARVN Ln Off
 Det, ARVN Interpreter

Company B (-)(Rein)

CAPT REESE

Company B (-)
 Det, 1st Plat, Co B, 1stSPBn
 Det, 1st Plat, Co B, 1stEngrBn
 Det, Btry D, 2ndBn, 11thMar
 Det, HqCo, 5thMar (Scout Sniper Tm)
 Det, H&S Co, 1stBn, 5thMar
 Det, Comm Plat
 Det, Med Plat
 Det, 81 FO Tm
 Det, FAC Tm
 Det, S-2 Scout
 Det, Kit Carson Tm

Company C (-)(Rein)

CAPT JOHNSON

Company C (-)
 Det, 1st Plat, Co B, 1stSPBn
 Det, 1st Plat, Co B, 1stEngrBn
 Det, Btry D, 2ndBn, 11thMar
 Det, HqCo, 5thMar (Scout Sniper Tm)
 Det, H&S Co, 1stBn, 5thMar
 Det, Comm Plat
 Det, Med Plat
 Det, 81 FO Tm
 Det, FAC Tm
 Det, S-2 Scout
 Kit Carson Tm

6. Supporting Forces.a. Air.

(1) Fixed Wing. During Operation ADAIR, fixed wing air support was provided by the 1st Marine Aircraft Wing.

(a) On D+2, an F9 aircraft conducted a strafing attack in vicinity (BT 095315) against a small group of VC retreating before advancing Company B units. An immediate sweep of the area was conducted with negative results. The air strike was controlled by the Air Liaison Officer.

DECLASSIFIED

DECLASSIFIED

(b) On D+5 a TAC/A controlled 2 flights of fixed wing aircraft against enemy troops in vicinity (BT 048418). The TAC/A reported 3 VC KBA, confirmed.

(c) On D+5 a TAC/A controlled 2 flights of aircraft against enemy troops located in vicinity (BT 043398). The TAC/A reported five VC KBA, confirmed.

(d) On D+6 a TAC/A controlled 3 flights of fixed wing aircraft in vicinity (BT 093390). These strikes served as an area preparation for advancing Company B units.

(2) TAC/A and ALO's. TAC/A and ALO's were utilized throughout the operation by all participating units.

(3) FAC Tm/ALO.

- (a) Each participating company was assigned a FAC Team.
- (b) The Air Liaison Officer moved with the Battalion Command Group.

b. Artillery.

(1) Artillery support for Operation ADAIR was provided by Battery D, 2ndBn, 11th Marines. Observed fire missions during the operation were few due to insufficient targets.

(2) On D+5 a coordinated air strike and an artillery fire mission were fired in support of 1st Battalion, 5th Marines in vicinity (BT 048418). The coverage of the target area was excellent. The mission was observed by TAC/A.

(3) H&I fires were used nightly during the operation on avenues of approach, mortar sites, assembly areas, harbor sites, areas of known VC activity and routes of communications and supplies. A total of 125 such areas were fired on to deny their use to the VC.

(4) FO teams were assigned to all participating companies. The artillery Liaison Officer moved with the Battalion Command Group.

7. Intelligence.

a. Estimates of VC strength, location and Disposition in the Objective area.

(1) No estimate was made due to urgency of operational commitment.

b. Enemy strength and situation actually determined during the operation.

(1) Undetermined due to lack of heavy contact.

DECLASSIFIED

~~DECLASSIFIED~~c. VC/NVA units identified.

(1) No units were identified.

d. Significant Intelligence gained.

(1) It was discovered that the Vietnamese populace was conspicuously absent except for a few farmers working the fields and elderly people in the villages.

(2) The suspects captured displayed obvious fear when approached by Marines.

(3) Interrogation of detainees indicated a strong VC infrastructure, consisting of Youth, Farmers, and Women's Associations.

(4) The objective of this operation was to fix and destroy VC forces and supplies in the objective area.

e. Terrain.

(1) Critical terrain features.

- | | | |
|-----|----------|--------------------------|
| (a) | Hill 63 | (BT 083325) |
| (b) | Hill 43 | (BT 123322) |
| (c) | Hill 53 | (BT 129369) |
| (d) | Hill 131 | NUI HON GIAN (BT 062398) |

(2) Terrain in the objective area is composed of paddyland and surrounded by dense underbrush.

(3) Obstacles. Few rivers and streams traverse the objective area and did not present any major problems to troop movement.

(4) Avenues of approach. Trails in the operational area were good to excellent for foot troops.

(5) Cross country movement. No unusual problems were encountered for troop movement.

(6) Tanks experienced some difficulty over most of the objective area being mostly restricted to roads.

f. Weather.

(1) Throughout the operation, weather was warm and humid with unrestricted visibility.

~~DECLASSIFIED~~

DECLASSIFIED

8. Mission. The 5th Marines alerted the 1st Battalion, 5th Marines to be prepared to participate in Operation ADAIR to destroy enemy forces, supplies, equipment, captured weapons and kill or capture VC.

9. Concept of Operation. The 1st Battalion, 5th Marines (-)(Rein) conducts helicopter borne movement from the combat base to a pre-designated landing zone located in vicinity (BT 106346) and continues attack to vicinity (AT 145325).

10. Execution.

A. D-Day. 15 June 1967 (See enclosure (2)).

(1). 151412H 5th Marines directed 1st Battalion, 5th Marines to maintain Command Group and 2 companies on $1\frac{1}{2}$ hour standby for possible participation in Operation ADAIR.

(2) 151419H 5th Marines directed 1st Battalion, 5th Marines to maintain one company on $1\frac{1}{2}$ hour standby for possible participation in Operation ADAIR.

(3) 151430H 5th Marines again directed 1st Battalion, 5th Marines to maintain Command Group and 2 companies on a $1\frac{1}{2}$ hour standby for possible participation in Operation ADAIR.

(4) 151435H Company A conducting search and destroy operations in vicinity of the combat base was directed to return to the combat base.

(5) 151519H 1st elements of Company B were helilifted from the combat base to LZ located in vicinity (BT 106347) for participation in Operation ADAIR. The Command Group and Company C followed in trace of Company B. At 151555H all units had been landed in LZ located in vicinity (BT 106347).

(6) 151530H Company A in vicinity (AT 984345) apprehended one Vietnamese female, about 30 years of age, wearing black clothing. The detainee was pointed out by local villagers as being VC. Detainee was forwarded to 5th Marines S-2.

(7) 151620H Company D combat base located in vicinity (BT 023288) received 15-20 rounds small arms fire from an estimated 3-4 unobserved VC located in vicinity (BT 026287). Two Marines were wounded. Fire was received from a easterly direction from a distance of approximately 350-400 meters. Company D returned fire with 15 60mm mortar rounds, 7 M-79 rounds and 150-200 rounds of small arms fire. A squad was dispatched to search the area. The VC broke contact and fled in an unknown direction. The area was searched with negative results. Result: 2 USMC WIAE.

(8) 151653H Company B departed LZ vicinity (BT 106347) and moved to secure Objective 27.

DECLASSIFIED

DECLASSIFIED

(9) 151700H Company A arrived at the combat base terminating company search and destroy operation.

(10) 151800H 1st Battalion, 5th Marines Frag Order 67-67 was promulgated. See enclosure (1).

(11) 152044H Company B while moving into night positions in vicinity (BT 132324) observed 8-10 VC moving along a rice paddy dike located in vicinity (BT 132325), a distance of 100 meters away. Company B fired 100-150 rounds small arms fire at VC and moved to search the area. During the search Company B found 1 VC WIA confirmed, who later died during the night, 1 US .30 caliber machine gun with serial number 268830, 1 can of .30 caliber ammunition, 1 medical kit, and 1 booklet. VC broke contact and fled in an undetermined direction. Results: 1 VC KIA confirmed. Captured equipment was forwarded to 5th Marines S-2.

(12) 152220H Company B located in vicinity (BT 131324) received 5-10 rounds small arms fire from an unobserved sniper located in vicinity (BT 137321). Fire was received from the south at a distance of 300 meters. Company B returned fire with 10 rounds small arms fire and searched the area with negative results.

b. D+1. 16 June 1967 (See enclosure (5)).

(1) 160300H 1st Battalion, 5th Marines received 5th Marines Frag Order 39-67. See reference (b).

(2) 160420H 1st Battalion, 5th Marines Frag Order 68-67 was promulgated. See enclosure (3).

(3) 160430H 5th Marines directed 1st Battalion, 5th Marines to remain in position and conduct patrols in vicinity Objective 29.

(4) 160630H Platoon patrol 5D1 departed Company D's combat base located at (BT 023288) with 600 pounds of explosives and moved to (AT 993292) to destroy a cave/tunnel complex. The cave/tunnel complex was located in a draw in the vicinity of a mountain. The cave/tunnel complex was found on 14 May 1967 by a platoon patrol operating in the area. Cave/tunnel complex consisted of 2 large caves; one 45 feet wide, 25 feet long and 15 feet high and the other was 65 feet wide, 25 feet long and 10 feet high. There were other smaller caves and tunnels in the immediate area. At 161530H the cave/tunnel complex was destroyed and patrol returned to Company D's combat base.

(5) 160710H a member of platoon patrol 5D1 while moving along route detonated a booby trap at (BT 023288). Booby trap appeared to be a grenade or some small type explosive device. No trip wire or any indication of a tripping device could be located. An emergency medical evacuation was called and completed at 160722H. Result: 1 USMC WIAE.

DECLASSIFIED

DECLASSIFIED

(6) 160710H Company B located in vicinity (BT 133321) sighted 2 VC wearing black clothing and carrying weapons, located in vicinity (BT 131320). Company B fired 30 rounds small arms fire at VC and searched the area with negative results. VC fled in a southwest direction.

(7) 160710H Company B moved to secure Objective 30. Company C moved to secure Objective 28. Battalion Command Group followed in trace of Company C.

(8) 160720H 1st Battalion, 5th Marines reported to 5th Marines that area in vicinity of (BT 142324) and (BT 140320) was searched with no significant results. Patrol found bomb craters. See reference (b).

(9) 160830H Command Group and Companies B and C arrived at Objective J, established a 360 degree perimeter and conducted patrol activities.

(10) 160840H Member of H&S Company located in vicinity (BT 132325) found 3 57mm cannisters. Cannisters were forwarded to 5th Marines S-2.

(11) 161400H Platoon patrol from Company B located at (BT 095314) observed one Vietnamese male running in vicinity (BT 089313). A squad was sent to apprehend the Vietnamese male. Squad received 20 rounds small arms fire from the west at a range of 500 meters while searching area. Patrol returned 20 rounds small arms fire and continued to search for the Vietnamese male. Vietnamese male was apprehended. Detainee was 37 years old, wore black clothing, had ID card and vaccination marks on arms. Detainee was forwarded to 5th Marines S-2.

(12) 161405H Squad security patrol 5A1 located at (BT 018321) apprehended one Vietnamese male about 20 years of age, without ID card and wearing black clothing. The detainee acted nervous and seemed to be frightened. Detainee was forwarded to 5th Marines S-2.

(13) 161620H Squad Patrol 5B4 located in vicinity (BT 105315) found one US canteen and one French 5 gallon water can. Items were forwarded to 5th Marines S-2.

(14) 161700H 1st Battalion, 5th Marines Frag Order 69-67 was promulgated. See enclosure (4).

(15) 161730H Company C commenced movement to Objective 31. Company B and Battalion Command Group followed in trace of Company C.

(16) 161800H A Vietnamese male civilian approached squad security patrol 5A6, located at (BT 032342) and pointed out a booby trap. The booby trap consisted of an M26 grenade, pin pulled, buried in the ground in an upright position with about one inch of the grenade above the surface. The grenade had been recently planted in a grassy area frequently used by Marine patrols. Engineers from the combat base were dispatched to the area and destroyed the grenade in place. The Vietnamese civilian was rewarded 200 piasters for ...

DECLASSIFIED

~~CLASSIFIED~~

pointing out the booby trap.

(17) 161830H Lead elements of Company C arrived at Objective 31.

(18) 162130H Company D received a warning order to be prepared to deploy one platoon from NUI LAC SON to join the 1st Battalion, 5th Marines forward at (BT 083325). Patrol was directed to meet the Company D platoon in vicinity (BT 075320).

(19) 162210H Check points were established for movement of 2nd platoon, Company D; CP 1 located at (BT 035295), CP 2 located at (BT 050302), CP 3 located at (BT 065313).

(20) 162310H 1st Battalion, 5th Marines Frag Order 70-67 was promulgated. See enclosure (6).

c. D+2 17 June 1967 (See Enclosure (7).)

(1) 170430H Company C commenced S&D operations moving to Objective 4. See enclosure (6).

(2) 170430H Company B commenced Company (-) patrol along assigned axis of advance. See enclosure (6).

(3) 170530H 2nd Platoon, Company D departed Nui Lac Son moving to join 1st Battalion, 5th Marines at Objective 31.

(4) 170600H 2nd Platoon Company D arrived at checkpoint 1.

(5) 170655H 2nd Platoon Company D arrived at checkpoint 2.

(6) 170730H Company B located in vicinity (BT 084324) found one 250 pound US bomb dud. Bomb was destroyed in place by engineers.

(7) 170740H 2nd Platoon Company D arrived at checkpoint 3.

(8) 170740H Company C arrived at Objective 4. See enclosure (6).

(9) 170820H 2nd Platoon Company D arrived at Hill 63 and joined the Battalion.

(10) 170840H Company C completed search of Objective 4 with negative results and was directed to move to Objective 3.

(11) 170845H Company C located in vicinity (BT 044313) observed 2 Vietnamese males in vicinity (BT 044314), at a distance of approximately 100-200 meters. Males were wearing grey and black clothing. Marines fired 20 rounds small arms fire at Vietnamese males. One fell in heavy brush. The area was searched and a blood trail was found and followed with negative results. Results: 1 VC WIA probable.

~~DECLASSIFIED~~

~~DECLASSIFIED~~

(12) 171010H Company B (-) was directed to continue on patrol until 1130H and then commence movement to checkpoint E, to link up with tanks from A Co, 1st Tank Battalion and escort them to 1st Battalion, 5th Marines Command Post. Company B (-) was directed to be at Command Post by 1630H.

(13) 171115H Company B located in vicinity (BT 094346) observed 2 VC wearing black clothing running along a rice paddy in vicinity (BT 096346). Company B fired 15 rounds small arms fire at VC. Area was searched with negative results.

(14) 171115H Company C located in vicinity (BT 050298) observed 6 VC wearing black clothing moving across a rice paddy in vicinity (BT 053272). Company C fired 80-100 rounds small arms fire, 6 60mm HE rounds at VC and called for artillery. Artillery fired 40 105mm HE rounds at VC. 3 VC fell when Company C initially opened fire. It is estimated that the VC sustained 3 VC KIA probable. VC fled in an undetermined direction. The area was searched with negative results. Results: 3 VC KIA probable.

(15) 171125H Company B located in vicinity (BT 855345) apprehended one Vietnamese male wearing black and white clothing, about 40 years of age with an ID card. Detainee was forwarded to 5th Marines S-2.

(16) 171220H Company B located in vicinity (BT 104339) observed 5 VC, 3 were wearing black clothing, 1 was wearing black and green clothing, and 1 was wearing khaki and black clothing. Company B fired 100 rounds small arms fire at VC. VC fled in a southeast direction. Area was searched and Company B found one VC KIA confirmed and one blood trail which was followed with negative results. Result: 1 VC KIA confirmed, and 1 VC WIA probable.

(17) 171245H Company C arrived Objective 3, searched objective area with negative results and was directed to proceed to Objective 7, and deploy as a blocking force along Phase Line Red for Company B.

(18) 171320H Company C located in vicinity (BT 062295) observed 3 VC fleeing from a hut. Company C fired 200 rounds small arms fire at VC. As squad approached to search the area, one VC attempted to throw a grenade. The VC was shot and was killed by the explosion of his own grenade. During the search, Company C found 1 US carbine with serial number 5569393; 1 magazine with 10 rounds, 3 cartridge belts, 2 canteens, 4 magazine pouches, 2 bayonets and assorted medical supplies. Company apprehended 2 VCC (1 WIA). Captured items and VCC were forwarded to 5th Marines S-2.

(19) 171325H Company B located in vicinity (BT 095324) apprehended one Vietnamese male, 25 years of age, without ID card wearing black clothing. Detainee admitted he was a VC. VCC was forwarded to 5th Marines S-2.

(20) 171340H Company B arrived at checkpoint E.

(21) 171340H Company B was directed to leave one platoon at checkpoint E and have one platoon continue to checkpoint 4 and move along trail to northwest to checkpoint 5 and return to combat base.

~~DECLASSIFIED~~

DECLASSIFIED

(22) 171400H Company C located in vicinity (BT 066301) received 30 rounds small arms fire from an estimated 5 unobserved VC. Fire was received from north west at a distance of approximately 200 meters. Company C returned fire with 250 rounds small arms fire, and searched the area with negative results. VC broke contact and fled to southwest. Results: 1 USMC WIAE.

(23) 171400H Squad security patrol 5A3, located in vicinity (BT 013355) found a 105mm HE dud. Engineers were dispatched to the area and destroyed the dud in place.

(24) 171420H 1st Battalion, 5th Marines completed resupply of rations and ammunitions.

(25) 171420H Platoon from Company B departed CP E moving to CP 4.

(26) 171525H 5th Marines Frag Order 40-67 was received. See reference (c).

(27) 171530H Company B located in vicinity (BT 091307) approached 3 Vietnamese males on a trail wearing black, blue and white clothing. When the Vietnamese observed Marines they attempted to flee in a southeast direction. Marines gave chase and apprehended 2 males. The third one disappeared in heavy undergrowth. Detainees were about 40 years of age and possessed ID cards. Detainees were forwarded to 5th Marines S-2.

(28) 171510H Company C arrived at Phase Line Red and established blocking positions.

(29) 171620H Company C located in vicinity (BT 072301) apprehended one Vietnamese male on a trail. Detainee had scars on his body, was about 35 years of age and had an ID card. Detainee was forwarded to 5th Marines S-2.

(30) 171630H Company B arrived at 1st Battalion, 5th Marines patrol base.

(31) 171645H Company B linked up with tanks at checkpoint E and commenced movement to 1st Battalion, 5th Marines Command Post.

(32) 171745H Company B located in vicinity (BT 084327) found one 250 pound dud US bomb. Bomb was destroyed in place by engineers.

(33) 171815H 2nd Platoon Company B located in vicinity (BT 091310) apprehended one Vietnamese male who was attempting to evade a Marine patrol. While being interrogated, detainee admitted being a VC. VCC was forwarded to 5th Marines S-2.

(34) 171945H Company B located in vicinity (BT 091339) observed 3 Vietnamese; 2 females and 1 male carrying a dead body camouflaged with twigs and brush. Dead body was a male about 25 years of age which had received head, stomach, and leg wounds. Kit Garson recognized male carrying the body, as a

DECLASSIFIED

DECLASSIFIED

VC. VCC was forwarded to 5th Marines S-2. Result: 1 VC KIA confirmed.

(35) 172000H 1st Battalion, 5th Marines Frag Order 71-67 was promulgated. See enclosure (8).

d. D+3. 18 June 1967. (See enclosure (9)).

(1) 180630H 1st Battalion, 5th Marines units commenced attack from Objective 31 moving to secure Objectives 8 and 9.

(2) 180800H Objective 12 was established at (BT 124363).

(3) 180805H Company B arrived at Phase Line Blue.

(4) 180900H Helicopters landing at the combat base were receiving sniper fire from vicinity (BT 018346) and grid square (BT 0035). Patrols were directed to move to the areas to suppress the sniper fire, and search the area for snipers.

(5) 180905H Battalion Command Group located in vicinity (BT 123355) received 2 rounds small arms fire from 2 snipers wearing green uniforms in vicinity of (BT 118360). Fire was received from the northwest at a distance of approximately 300-400 meters. Tanks located in vicinity Command Group returned fire with 1 90mm HE round and 100 .50 caliber rounds. Area was searched with negative results.

(6) 180945H Squad Security Patrol 5A5 located in vicinity (BT 035325) apprehended one Vietnamese male about 20 years of age, without ID card wearing black clothing. While patrol was checking ID cards of other Vietnamese in the area, a Vietnamese was observed running into a treeline at a distance of 500-600 meters in vicinity (BT 037318). Patrol fired 4 rounds small arms fire at fleeing Vietnamese with negative results. The detainee was forwarded to Battalion S-2, interrogated by members of 9th ITT, and further forwarded to 5th Marines S-2.

(7) 181015H Company L 3rd Battalion, 5th Marines arrived at combat base for Regimental Reserve.

(8) 181100H Squad Security patrol 5A1 located in vicinity (BT 042325) apprehended one Vietnamese male, about 30 years of age, without ID card and wearing black clothing. The detainee, carrying two baskets was moving along a trail in a southerly direction. Detainee was searched and a lighter with 403 imprinted on it was found. Detainee and lighter were forwarded to Battalion S-2. The detainee was interrogated by members of 9th ITT and was forwarded to 5th Marines S-2.

(9) 181135H Squad security patrol 5A1 located in vicinity (BT 044326) asked one Vietnamese male about 50 years of age who was plowing his field, for an ID card. Vietnamese male did not have an ID card on his person. He led the patrol to his house and produced an ID card. The Vietnamese male's house was searched and patrol found one green military uniform and lighter with 405 imprinted on it. Detainee was forwarded to Battalion S-2, and was interrogated by members of 9th ITT. Detainee had a son that was a PF

DECLASSIFIED

DECLASSIFIED

and was registered with Que Son District Headquarters. Detainee was released.

(10) 181145H Squad security patrol 5A5 located in vicinity (BT 008355) observed 3 Vietnamese males in hamlet located in vicinity (BT 009356). Patrol ordered the Vietnamese to halt without results. The Vietnamese attempted to run away from the patrol. The patrol fired about 30 rounds small arms fire at fleeing Vietnamese males; one was killed and the other two were apprehended. The VC KIA was about 20-23 years of age without ID card, wore black clothing and carried an M-26 grenade. The detainees were 30-37 years of age and wore black clothing. Detainees were forwarded to Battalion S-2 and were interrogated by members of 9th ITT. 9th ITT confirmed the Detainees as VC. The VCC were forwarded to 5th Marines S-2.

(11) 181245H Platoon security Patrol 5L1 located in vicinity (BT 020340) found 1 dud 60mm mortar round. Dud was destroyed in place by engineers.

(12) 181450H Company C patrol located a fording site for the tanks in vicinity (BT 122369).

(13) 181500H 1st Battalion, 5th Marines units were directed to move to Objective Q at 181600H. Objective Q was established at (BT 124391).

(14) 181730H Squad Security Patrol 5A4 located in vicinity (BT 006334) received 15-20 rounds small arms fire from 2 unobserved VC, wearing black clothing located in vicinity (BT 003331). Fire was received from the southwest at a distance of about 300 meters. Patrol returned fire with 50-60 rounds small arms fire and physically pursued the VC. The VC broke contact and fled to the southwest. Patrol could not regain contact with the VC. The patrol searched the area with negative results and continued on its assigned mission.

(15) 181815H Company B located in vicinity (BT 123393) received 3 incoming M-79 rounds from an unobserved VC located in vicinity (BT 123395). Rounds were received from the north at a distance of 200 meters. Company B returned fire with 10 rounds 60mm HE and 100 rounds small arms fire. The area was searched with negative results.

(16) 181818H Tanks became stuck in loose earth. 1st Battalion, 5th Marines established security around the tanks.

(17) 182030H 5th Marines Frag Order 41-67 was received. See reference (d).

e. D+4. 19 June 1967. (See enclosure (11).)

(1) 190030H 1st Battalion, 5th Marines Frag Order 72-67 was promulgated. See enclosure (10).

(2) 190720H Company C, located in vicinity (BT 103393) observed 2 VC dressed in green and black clothing moving through heavy brush at a range of

DECLASSIFIED

DECLASSIFIED

500 meters in vicinity (BT 098368). Company C fired 30 rounds small arms fire. VC fled to northwest. The area was searched with negative results.

(3) 190839H Squad Security patrol 5A8 located in vicinity (BT 014354) received 15-20 rounds small arms fire from an estimated 2-3 unobserved VC located in a hedgerow in vicinity (BT 010356). Fire was received from the northwest at a distance of approximately 300 meters. Patrol returned fire with 40-60 rounds small arms fire and 8 M-79 rounds and assaulted the suspected VC positions. The VC fired an additional 10-15 rounds small arms fire at patrol. The patrol returned an additional 120-150 rounds small arms fire and continued the assault. VC broke contact and fled in an undetermined direction. Area was searched with negative results and patrol continued on assigned mission.

(4) 190900H Company C located in vicinity (BT 092392) found 1 butterfly type mine. Mine was destroyed in place by engineers.

(5) 190930H H&S Company squad patrol observed 10 VC moving across paddy wearing black clothing carrying packs and weapons. Patrol fired 20 rounds small arms fire at VC. VC returned fire with 5-10 rounds small arms fire. Patrol searched area and found 1 ChiCom grenade. Grenade was destroyed by engineers. Search was concluded with negative results.

(6) 191150H Company C located in vicinity (BT 057392) observed 10 VC dressed in black clothing carrying weapons, moving northwest in vicinity (BT 051393). Company C fired 100-150 rounds small arms fire at VC. A search of the area disclosed 1 VC WIA wearing green clothing and 1 leather medical bag consisting of assorted medical equipment. VC and medical equipment were forwarded to 5th Marines S-2.

(7) 191240H Squad security patrol 5A8 while crossing a rice paddy in vicinity (BT 010354) received approximately 200-300 rounds semi-automatic small arms fire from an estimated 15 unobserved VC located in vicinity (BT 011353) and (BT 007353). Fire was received from a southerly direction from 2 locations at a distance of 200-400 meters. The squad returned fire with approximately 550 rounds of small arms fire, 12 M-79 rounds and requested 81mm mortar fire. 15 HE rounds and 1 WP round was fired on the VC locations with excellent target coverage. During the mortar fire, 5 VC wearing helmets and green uniforms were observed where 5-6 mortar rounds made direct hits on what appeared to be a freshly dug trench line in vicinity (BT 007353). The patrol consisting of 10 Marines was ordered to break contact with the VC and return to the combat base. The machine gun with the squad did not function properly and the patrol was low on ammunition and had sustained one casualty. It was learned from the debriefing of the patrol leader that the patrol had found a cave complex and 1 105mm HE dud in vicinity (BT 009354). The complex consisted of two rooms; one 6 meters by 5 meters, by 6 meters, the other 6 meters by 6 meters by 6 meters. The caves were searched and patrol found one new hypodermic syringe and miscellaneous bottles of medicine. At 191500H a platoon from Company L, 3rd Battalion, 5th Marines (5L1) was dispatched to the areas to destroy the cave complex and dud round, and search the area where contact had previously been made. While

DECLASSIFIED

DECLASSIFIED

enroute to area in vicinity (BT 014343) 5L1 found one Z-10 anti-personnel mine with trip wire attached. The mine was destroyed in place by engineers. Patrol continued on mission, and in vicinity of (BT 008343) received 50-60 rounds small arms fire from an estimated 10-15 VC located in vicinity (BT 005344). Fire was received from the west at a distance of approximately 300 meters. Patrol 5L1 returned fire with 80-100 rounds small arms fire and requested 81mm mortar fire. 81's fired 14 rounds HE and 10 rounds WP on VC locations with good coverage. Patrol 5L1 searched the area and found what appeared to be drag marks. Marks were followed with negative results. The VC broke contact and fled in an undetermined direction. Patrol continued on to vicinity (BT 011553) and (BT 007353), searched the area and found a freshly dug trench line about 30-40 meters long. The cave complex previously encountered was destroyed. The 105mm dud round had been removed from the site of the cave. One Vietnamese male about 50 years of age, wearing black clothing was apprehended. Detainee was taken to the combat base and interrogated by members of 9th ITT. At 191850H patrol 5L1 returned to the combat base. Results: 1 USMC WIAE. Detainee and assorted medical supplies were forwarded to 5th Marines S-2; 5 VC KIA probable; 1 cave complex and 1 beaby trap, Z10 anti-personnel mine were destroyed.

(8) 191330H Company B located in vicinity (BT 071395) apprehended one Vietnamese male, age 56, wearing white clothing. Man was uncooperative. Detainee was forwarded to 5th Marines S-2.

(9) 191350H Patrol 5B2 located in vicinity (BT 067401) apprehended one Vietnamese male hiding behind a house. Detainee was approximately 42 years old, wore black clothing and had ID card and vaccination marks on right arm. Detainee was forwarded to 5th Marines S-2.

(10) 191810H Company C platoon outpost located in vicinity (BT 061398) observed 4 VC in vicinity (BT 063404) and (BT 057393) dressed in black clothing carrying weapons moving in a westerly direction. Platoon fired 40-60 rounds small arms fire at VC. A search of the area disclosed one VC KIA confirmed and heavy blood trails. Blood trails were followed with negative results. VC broke contact and fled in a westward direction. Results: 1 VC KIA confirmed, and 1 VC KIA probable.

(11) 191900H Squad Ambush 506 located in vicinity (BT 061398) observed 2 VC in vicinity (BT 064406) and (BT 061401) crossing paddies moving in two different directions; one VC proceeding in a southerly direction dressed in gray clothing and carrying a weapon, the other traveling in a easterly direction wearing gray and black clothing and carrying a weapon. Marines fired approximately 25 rounds small arms fire and observed both VC fall. A thorough search of the area was conducted with negative results.

(12) 191925H Platoon Patrol 5B3 located in vicinity (BT 097396) observed 7 VC with weapons moving in a westerly direction at a range of approximately 100 meters. Type of clothing was unobserved due to darkness. Patrol fired approximately 125 rounds small arms fire and observed 3 VC fall.

DECLASSIFIED

UNCLASSIFIED

The area was searched and heavy blood trails and drag marks were found and followed with negative results. Results 3 VC KIA probable.

(13) 191925H Company B patrol located in vicinity (BT 094413) received 4 rounds sniper fire from an unobserved sniper located in vicinity (BT 089414). Fire was received from the west at a distance of 500 meters. One Vietnamese male dressed in green clothing and carrying a weapon was observed running up a mountain. Company B fired 75 rounds small arms fire and 2 M-79 rounds at fleeing VC. The VC was pursued but contact was lost in dense vegetation. A thorough search of the area was conducted with negative results.

(14) 192025H Company B located in vicinity (BT 095403) apprehended one Vietnamese male approximately 25-30 years old. Detainee wore black clothing and had an ID card. Detainee was forwarded to 5th Marines S-2.

(15) 192245H Company B located in vicinity (BT 080398) observed one VC wearing black clothing and carrying a weapon. VC fled to the southeast when he saw the patrol. Patrol fired approximately 30 rounds small arms fire at the fleeing VC. The area was searched with negative results. While searching the area, 1 Vietnamese male was apprehended. Detainee was approximately 50 years old, had ID card and wore black clothing. Detainee was believed to be pay master for the VC. Detainee was forwarded to 5th Marines S-2.

f. D+5. 20 June 1967. See enclosure (12).)

(1) 200720H Company B platoon patrol observed one Vietnamese male in vicinity (BT 069406). The male was challenged and he did not respond to the challenge. Patrol fired 20 rounds small arms fire at Vietnamese male, killing him. The body was searched and patrol found an ID card. VC KIA was about 25 years of age and wore black clothing. One Vietnamese female was apprehended. Detainee was without ID card and was wearing black clothing. Results: 1 VC KIA confirmed, Detainee was forwarded to 5th Marines S-2.

(2) 200730H Company C Platoon Patrol located in vicinity (BT 080405) observed 3 VC dressed in black clothing and carrying weapons moving in a northeast direction located in vicinity (BT 082406). Patrol fired approximately 75 rounds small arms fire and 3 M-79 rounds at VC. VC fled into heavy vegetation. Patrol could not regain contact with the VC. Area was searched with negative results.

(3) 200800H Squad Security Patrol 543 located in vicinity (BT 008330) received 7-8 rounds small arms fire from 2 unobserved snipers, located in vicinity (BT 002335). Fire was received from the northwest at a distance of about 400 meters. Patrol returned fire with 20-30 rounds small arms fire and moved toward the suspected sniper positions. Area was searched with negative results.

(4) 200845H Company B platoon patrol located in vicinity (BT 069413) received 20 rounds small arms fire from 3 VC dressed in gray clothing and carrying weapons, located in vicinity (BT 069414). Fire was received from the north at a distance of approximately 150 meters. Patrol returned 200 rounds small arms fire, 15 M-79 rounds and searched the area. Patrol found 1 VC KIA

DECLASSIFIED

DECLASSIFIED

confirmed, one automatic carbine with serial number 10082995, 1 cartridge belt, 1 ChiCom grenade, and 1 hat. Captured equipment was forwarded to 5th Marines S-2.

(5) 200950H 1st Battalion, 5th Marines located in vicinity (BT 074394) requested air and artillery preparation in vicinity (BT 048418) for support of 1st Battalion, 5th Marines units conducting search and destroy operations. Air and artillery fire missions were conducted in the area from 200950H to 201105H. AO reported small groups of 7-19 enemy fleeing to west and north and 10 KIA probables. Recon inserts reported 4 VC KIA confirmed. Search of area of air and artillery missions produced following results: 1 burned body, 49 destroyed buildings, heavy blood trails, 2 caves destroyed (3 feet high, 4 feet wide, 12 feet long), 6 rolls of barbed wire destroyed and 23 bunkers destroyed. 2 detainees and 3 admitted VC were apprehended. Detainees and VC were forwarded to 5th Marines S-2.

(6) 201050H Company C located in vicinity (BT 047396) received approximately 60 rounds small arms fire from an estimated 4 unobserved VC located in vicinity (BT 046394). Tanks returned fire with 4 90mm HE rounds, and 30 rounds of small arms fire. Company C searched the area and found blood trails which were followed with negative results. It was estimated the VC sustained 2 VC KIA probable.

(7) 201105H Company C platoon patrol located in vicinity (BT 049408) found two VC in a fighting position. VC were wearing black clothing. One VC attempted to run and was killed. The other VC killed himself by detonating a WP grenade. Bodies were searched and packet of pictures was found and forwarded to 5th Marines S-2.

(8) 201210H Member of Company B platoon patrol located in vicinity (BT 051406) detonated a booby trap which appeared to be a hand grenade. Booby trap with trip wire attached was set up in a heavily vegetated area. Results: 2 USMC WIAE.

(9) 201345H Company C platoon patrol with tank attached located in vicinity (BT 046377) received 100-200 rounds small arms and automatic weapons fire from approximately 500 meters to the north. Enemy was dressed in black clothing. Platoon and tanks returned 9 rounds 90mm, 100-200 rounds .30 caliber and 50 rounds .50 caliber. One bunker was completely destroyed by 90mm round. Company C found 2 VC KIA confirmed, heavy blood trails, drag marks, and 3 homemade gas masks. Results: 2 VC KIA confirmed, and 2 VC KIA probable.

(10) 201505H Squad security patrol 544 located in vicinity (BT 012345) received 1 round small arms fire from an unobserved sniper located in vicinity (BT 004348). Fire was received from a northerly direction at a distance of approximately 400-600 meters. Patrol sustained one KIA. Patrol returned approximately 200 rounds small arms fire. The patrol received an additional 20-30 rounds small arms fire from an estimated 4-6 observed VC wearing black clothing. The patrol returned fire with approximately 100-200 rounds small

DECLASSIFIED

DECLASSIFIED

arms fire and requested artillery fire. 7 81mm WP rounds were fired on the VC location with good target coverage. The patrol commenced a search of the area. At 1530H a platoon from Company L was directed to move to the area and assist squad patrol 5A4. At 1600H platoon from Company L and 5A4 linked up and conducted a search of the area and apprehended 3 Vietnamese males, who were hiding in a cave, wearing black clothing. 5A4 and Company L platoon completed the search without any further significant results. The USMC KIA and 3 detainees were returned to the combat base. Detainees were forwarded to 5th Marines S-2. Results: 1 USMC KIA and 3 detainees.

(11) 201555H Company B platoon patrol located in vicinity (BT 053403) received 100-150 rounds small arms fire and automatic weapons fire from village located in vicinity (BT 051404). Fire was received from an estimated 10-15 VC dressed in green and black clothing. Carrying cartridge belts and weapons. Patrol returned 600-700 rounds small arms fire and 43 M-79 rounds. Tracer rounds started fire in one hut which resulted in secondary explosion. Patrol swept through the village, found heavy blood trails and drag marks which were followed with negative results and patrol found 3 2.75 INCH US rockets. Results: 4 VC KIA probable.

(12) 202035H 5th Marines Frag Order 42-67 was received. See reference (e).

(13) 202210H Frag Order 73-67 was promulgated. See enclosure (13).

g. D+6. 21 June 1967. (See enclosure (14).)

(1) 210020H 1st Battalion, 5th Marines Frag Order 74-67 was promulgated. See enclosure (15).

(2) 210550H Company C commenced a search of GS (BT 0441).

(3) 210600H Platoon from Company B moved with tanks to Objective U.

(4) 210805H Platoon patrol 5A1 located in vicinity (BT 016357) received approximately 20 rounds small arms fire from an unobserved sniper located in vicinity (BT 015356), (BT 016359) and (BT 019357). Patrol returned fire with approximately 200 rounds small arms fire and 10 M-79 rounds. Elements were sent out to search the area. A squad observed one VC dressed in khaki and black clothing running. Patrol fired 8-10 rounds at VC, killing him. VC KIA was about 30 years old. The area was searched for a weapon with negative results. It is estimated that another VC was KIA probable. Results: 1 USMC WIAE, 1 VC KIA confirmed and 1 VC KIA probable.

(5) 210915H Squad Security patrol 5L2 located in vicinity (BT 016328) received approximately 200 rounds small arms fire from an estimated 10-12 VC located in vicinity (BT 013327). A PF patrol consisting of about 35 PF's joined patrol 5L2 and assisted in routing the VC from their position. VC were taken under fire with 75 M-79 rounds, 2 LAWS and approximately 1000 rounds small arms fire. The area was searched and the patrol apprehended 2

DECLASSIFIED

~~DECLASSIFIED~~

Vietnamese, 1 female about 25 years of age dressed in white clothing and 1 male about 50-60 years of age dressed in black clothing. Both detainees were without ID cards. Detainees were forwarded to 5th Marines S-2. Results: 1 USMC WIA and 2 detainees.

(6) 211000H Platoon security Patrol 5A1 located in vicinity (BT 011359) apprehended one Vietnamese male about 40 years of age, wearing white clothing and without ID card. Detainee was forwarded to 5th Marines S-2.

(7) 211110H Platoon Patrol 5A1 located in vicinity (BT 011359) received approximately 5 rounds small arms fire from an unobserved sniper located in vicinity (BT 009354). Fire was received from the west at a distance of approximately 300 meters. Patrol returned approximately 100 rounds small arms fire and requested 81mm mortar fire. 4 rounds 81mm HE were fired on the VC positions. Patrol sustained 1 USMC WIA and a medical evacuation was called. Following the completion of the medical evacuation, patrol received approximately 10 rounds small arms fire from an estimated unobserved 3 snipers located in vicinity (BT 009358). Fire was received from the northwest at a distance of 500-600 meters. Patrol returned fire with 100 rounds small arms fire and searched the area with negative results. Results: 1 USMC WIAE.

(8) 211245H Company B squad patrol located in vicinity (BT 099390) found 1 NVA pack, assorted papers and documents and 1 cooking pot which were forwarded to 5th Marines S-2.

(9) 211310H Company C located in vicinity (BT 027408) observed 5 males and 3 female VC dressed in black and grey clothing, with weapons moving in a northerly direction. The VC were taken under fire with 400-500 rounds small arms fire and 3 M-79 rounds. 2 VC fell as if hit during the fire and were assisted by other VC. The area was searched and the following was found: 1 VC KIA confirmed; heavy blood trails which were followed with negative results, 1 M-26 grenade, 1 ChiCom grenade, 30 rounds 7.62 Russian ammunition, 40 rounds 9mm, 2 magazines, 2 cartridge belts, 2 medical pouches, 2 ponchos and 2 gas masks. It was estimated the VC sustained 2 VC KIA probable. Captured equipment was forwarded to 5th Marines S-2.

(10) 211450H Company B was directed to move to Objective 44, then to CP Mike (AT 993382) and then to CP Fred (AT 991377).

(11) 211535H The point of Company B located in vicinity (BT 003095) observed 1 Vietnamese male running from a house carrying a bag. The man was challenged and he failed to respond to the challenge. Point fired 10 rounds small arms fire at the fleeing man, killing him. The VC was searched and the following items of equipment were found: 1 medical bag containing assorted medical equipment. Results: 1 VC KIA confirmed, captured equipment was forwarded to 5th Marines S-2.

~~DECLASSIFIED~~

DECLASSIFIED

(12) 211600H 1st Battalion, 5th Marines Frag Order 73A-67 was promulgated. See Enclosure (14).

(13) 211715H 5th Marines Frag Order 43-67 was received. See reference (f).

(14) 211735H 3rd Platoon, A Company, 1st Tank Battalion and one platoon from Company I, 3rd Battalion, 5th Marines arrived at the combat base.

(15) 211905H 2nd Platoon Company D located in vicinity (BT 016387) received approximately 30 rounds small arms fire from a VC dressed in black and green clothing located in vicinity (BT 018390). Fire was received from the north at a distance of approximately 300 meters. Platoon returned 50 rounds small arms fire and tanks returned fire with 90 rounds .50 caliber and 2 90mm rounds. A thorough search of the area was conducted with negative results.

(16) 211917H Company C was directed to join tanks and proceed to Objective U to establish night defensive positions.

(17) 212055H Squad ambush 5A11 while moving to ambush site observed one male Vietnamese in vicinity (BT 021345) approximately 50 meters away moving from north to south in front of the squad. It appeared that the male was carrying a weapon. Vietnamese male was taken under fire with 10 rounds small arms fire. Squad searched the area with negative results.

D+7. 22 June 1967. (See Enclosure (18).)

(1) 220630H Company C and tank unit commenced move to 1st Battalion, 5th Marines combat base. Company A commenced movement from combat base to link up with 1st Battalion, 5th Marines.

(2) 220754H Company A located in vicinity (BT 990350) received approximately 9 rounds small arms fire from an estimated 3 unobserved snipers located in vicinity (AT 996351). Fire was received from the northwest at a distance of approximately 400 meters. Company A returned fire with 75 rounds small arms fire and searched the area with negative results.

(3) 220930H Modification to 1st Battalion, 5th Marines Frag Order 74-67 was promulgated. See enclosure (17).

(4) 221100H Platoon Patrol 5L2 located in vicinity (BT 013394) apprehended one Vietnamese boy about 10 years of age. Detainee was digging a hole with a bayonet and possessed a trip wire and one M-26 grenade. Detainee was forwarded to 5th Marines S-2.

(5) 221150H Company A Platoon Patrol located in vicinity (AT 983351) received 30-40 rounds small arms fire from an estimated 8 VC, located in

DECLASSIFIED

DECLASSIFIED

vicinity (AT 983355). Fire was received from the northwest at a distance of 400 meters. Patrol returned fire with 100 rounds small arms fire and searched the area. The VC broke contact and fled to the west. During the search, patrol found 4 VC KIA dressed in black clothing and covered with brush as camouflage. Results: 4 VC KIA confirmed.

(6) 221320H Company C platoon patrol located in vicinity (AT 994365) received 10 rounds small arms fire from 3-4 unobserved snipers, in vicinity (AT 988367). Fire was received from the northwest at a distance of approximately 400 meters. Patrol returned fire with 200 rounds small arms fire and 60mm HE rounds. The area was searched and patrol found one blood trail which was followed with negative results. Following the contact the platoon was ordered to commence movement to 1st Battalion, 5th Marines combat base. Results: 1 VC WIA probable.

(7) 221430H Company A located in vicinity (AT 980353), observed 5 VC wearing black clothing sitting in the shade, in vicinity (AT 980353). Company A fired 20-30 rounds small arms fire at VC. VC fled to the west leaving weapons and equipment behind. One VC was observed to have fallen as if hit. following equipment was captured: 2 US M-1 carbines, serial numbers 2216278 and 357367, 1 ChiCom automatic rifle, serial number 7056642, 1 Russian carbine serial number 82422, one French rifle serial number FG 21179, 5 cartridge belts with ammunition and assorted documents. Captured equipment was forwarded to 5th Marines S-2. Results: 1 VC WIA probable.

(8) 220900H Tanks bogged down vicinity (BT 035397), request submitted for tank cables to free tanks.

(9) 221430H Cables received by helilift, tanks freed, resumed movement to combat base.

(10) 221515H Company B located in vicinity (AT 994384) destroyed cave/tunnel found the previous day. Cave/tunnel complex was 30 feet wide by 50 feet long and 20 feet high. Entrance to cave was 12 feet wide, 5 feet high and was cut out of solid rock. 90 cratering charges were used to destroy the cave/tunnel complex. Result, cave/tunnel complex completely destroyed by engineers.

(11) 221650H Company A patrol 5A5 located in vicinity (AT 998342) received approximately 30 rounds small arms fire from an estimated 6 VC snipers located in vicinity (AT 998340). Fire was received from the south at a distance of 400 meters. Patrol returned fire with 75 rounds small arms fire. A search of the area was conducted and patrol found 1 VC KIA confirmed. VC KIA was about 18-20 years of age, wore black clothing and was without ID card. Other VC fled in an undetermined direction. Result: 1 VC KIA confirmed.

DECLASSIFIED

DECLASSIFIED

(12) 221732H H&S Company located in vicinity (AT 993362) received 2 rounds of sniper fire from a sniper located in vicinity (AT 989366). Fire was received from the west at a distance of 400 meters. Artillery fire was called, and 8 rounds 105mm HE and 2 rounds 105mm WP were fired at suspected VC locations. Area was searched with negative results.

(13) 221745H Company C located in vicinity (BT 065375) observed 2 VC wearing black clothing and carrying weapons moving in a southeast direction. Company C fired 60 rounds small arms fire at VC and searched the area. 1 VC KIA about 30 years of age was found. The body and area was searched with no further significant results. Results: 1 VC KIA confirmed.

(14) 221925H Company A patrol located in vicinity (AT 983352) apprehended one Vietnamese male. Detainee initially attempted to run from the patrol. Patrol fired 1 round small arms fire and detainee stopped. Detainee was forwarded to 5th Marines S-2.

(15) 221935H Company B located in vicinity (AT 976343) apprehended one Vietnamese male 65 years old, wearing black clothing and without ID card. When questioned detainee said his son was a VC. Detainee was forwarded to 5th Marines S-2.

(16) 222035H Company C and tanks arrived at 1st Battalion, 5th Marines combat base.

(17) 222130H 5th Marines Frag Order 44-67 was received. See reference (g).

(18) 222115H Company C platoon located in vicinity (AT 983345) apprehended one Vietnamese male age 49, wearing white and khaki clothing. Detainee was forwarded to 5th Marines S-2.

(19) 222230H 1st Battalion, 5th Marines Frag Order 75-67 was promulgated. See enclosure (19).

D-8. 23 June 1967. (See Enclosure (20).)

(1) 230650H Company B and Battalion Command Group commenced movement to the combat base.

(2) 230810H Patrol 5A1 located in vicinity (AT 978340) found a tunnel 4 feet high, 4 feet wide and 160 feet long. Tunnel was searched with negative results. Tunnel was destroyed by engineers.

(3) 230845H Company B and Battalion Command Group arrived at the combat base.

(4) 230937H Company L departed combat base and joined the 3rd Battalion, 5th Marines.

DECLASSIFIED

DECLASSIFIED

(5) 231830H Company A located in vicinity (BT 000323) received 4 rounds small arms fire from the south at a distance of about 300 meters. The sniper was not observed. Company A returned 30 rounds small arms fire and searched the area with negative results. Results: 1 USMC WIA.

(6) 232200H Squad ambush 5A5 while enroute to ambush site heard movement about 100 meters to their front (vicinity (AT 995335)). Within a few minutes the patrol received 2 incoming hand grenades and 8-10 rounds small arms fire. Patrol returned 30-50 rounds small arms fire and 3 M-79 rounds. Patrol was recalled to the combat base and repositioned to another location. The area was searched the following morning with negative results. Results: 2 USMC WIA.

D+9. 24 June 1967.

(1) 241630H Platoon Patrol 5A3 located in vicinity (AT 994337) observed one Vietnamese male running, carrying something wrapped in cloth. Vietnamese male was ordered to halt. Vietnamese male failed to respond to the challenge. Patrol fired one round small arms fire at VC and hit him in the leg. VC was about 30 years old and wore black clothing. The VC was searched and the following items were found: 1 complete change of clothes, container of vitamins B1, merthiolate, roll of gauze, one gas mask, 1 battle dressing and 1 poncho. Detainee and captured equipment was forwarded to 5th Marines S-2.

(2) 241730H Platoon Patrol 5A3 located in vicinity (AT 000340) observed 2 Vietnamese walking down a trail with weapons, dressed in black clothing. The point of the patrol fired 40 rounds small arms fire at VC, killing them. Another VC dressed in black clothing was observed running in the general area at a distance of about 300 meters. Patrol fired one M-79 round at fleeing VC, killing him. Results: 3 VC KIA confirmed and the following equipment was captured, one bolt action springfield rifle, serial number 1792, 1 ChiCom bolt action rifle, serial number 02386, 25 rounds unknown caliber ammunition, 1 ChiCom grenade and assorted medical supplies. Captured equipment was forwarded 5th Marines S-2.

(3) 241730H Platoon Patrol 5A3 located in vicinity (AT 994337) searched a house which a Vietnamese had been running toward. During the search patrol found 3 empty carbine magazines and a picture of HO CHI MINH. One Vietnamese male about 70 years of age wearing black clothing was apprehended. While the detainee was being returned to the combat base he died of a heart attack.

(4) 242400H Operation DAIR terminated.

DECLASSIFIED

DECLASSIFIED

11. Results.a. Friendly Casualties.

KIA	2
WIAE	6
WIANE	3
DOW	0
MIA	0
NBC	13

b. Enemy Casualties.

KIA confirmed	33
KIA probable	51
VC Captured	13
Detainees	37

c. Captured Ordnance.

- 1 US Light Machine Gun, Caliber .30 M1919A4, Serial Number 268830.
- 3 US Carbines Caliber .30, Serial Numbers 5669393, 2916278, 357367.
- 1 French 7.5mm MAS 36, Serial Number: FFG 21479.
- 1 7.62mm Semi-automatic carbine, SKF Type 56, Serial Number 7056642.
- 1 Russian Carbine Type 53, Serial number 2262H.
- 2 Chinese Communist 7.62mm Assault Rifle Type 56, Serial Number 10082995, and one unreadable.
- 2 Rifles type unknown, serial number P1792, D2386.
- 8 Magazines for ChiCom Assault Rifle.
- 3 Bayonets (2 with scabbards).

d. Captured Munitions.

- 3 M-26 grenades (1 booby trap)
- 7 ChiCom hand grenades
- 1 defensive grenade (concussion)
- 40 rounds 9mm ammunition
- 3 57mm canisters
- 1 can 30 caliber ammunition (200 rounds)
- 30 rounds 7.62 Russian ammunition
- 1 Z10 mine (booby trapped)
- 35 rounds 30 caliber US ammunition

e. Captured Equipment.

- 4 Hammocks
- 2 Leather medical carrying cases with assorted medical supplies
- 2 Medical pouches
- 6 Gas masks
- 5 Canteen covers
- 4 Canteens

DECLASSIFIED

DECLASSIFIED

6 Cartridge belts
 5 Pistol belts
 1 Pack
 1 Small cooking pot
 Assorted medical supplies
 Assorted documents/pictures/booklets

f. Cave/Tunnel complexes destroyed.

Cave, 30ft. x 50ft. x 20ft.

Tunnel, 4ft. x 4ft. x 160ft.

Cave complex consisting of two large rooms, one 45ft. x 25ft. x 15ft. and 45ft. x 25ft. x 10ft.

2 tunnels 3ft. x 4ft. x 12ft.

2 Caves 12ft. x 10ft. x 12 ft.

24 Fortified positions

49 Dwelling (destroyed by air)

g. US munitions found and destroyed.

3 2.75 inch rockets

1 105mm HE round

2 250 pound bombs (US)

1 60mm mortar round

12. Administrative Matters.

a. Supply

(1) Initially each individual Marine carried a marching pack, six MCI's, three canteens, individual weapons and a basic allowance of ammunition.

(2) Each unit carried its organic machine guns, rocket launchers, and 60mm mortars and a basic allowance of ammunition.

(3) There were no significant problems encountered in resupplying the Battalion.

b. Maintenance.

Personnel carried their own weapons cleaning equipment. Individual and crew served weapons were cleaned and inspected daily. There were no problems encountered with weapons or ammunition during the operation.

c. Treatment of Casualties and Evacuation and Hospitalization.

(1) During Operation ADLIR, medical treatment was initially administered to the wounded and sick by three corpsmen attached to each company and by the

~~CLASSIFIED~~

Battalion Surgeon and two corpsmen attached to the Command Group.

(2) Medical evacuations were called by a Helicopter Support Team attached to each company. The company team requested a helicopter medical evacuation through the Command Helicopter Team located with the Command Group. The Command Helicopter Support Team then relayed the request to the Logistical Support Area located in TAM KY, RVN. When the helicopter was on the way, the unit requesting the helicopter was notified. The appropriate HST provided guidance in to the landing zone and the medical evacuation was completed.

(3) When evacuations were completed, evacuees were forwarded to a collecting and clearing company located at the LSA, and further evacuated to DaNang, CHU LAI, or a hospital ship as appropriate.

d. Transportation

(1) On 15 June 1967, the 1st Battalion, 5th Marines was helilifted to a landing zone located in vicinity (BT 106346) without enemy contact.

(2) Helicopters were used to provide normal resupply and medical evacuation for units actively participating in the operation and the combat base located in QUE SON, RVN.

(3) Helicopter support was adequate and the only type of transportation utilized. No problems were encountered.

e. Communications.

No problems were encountered with communications during the entire operation.

f. Medical Evacuation

(1) Despite extremely high temperatures, this battalion avoided heat casualties by rigid control of salt and water. No cases of heat exhaustion were found among personnel of this battalion. The omission of upper torso body armor and command attention to proper consumption of salt tablets during the operation greatly aided in the reduction of heat casualties.

(2) There were no problems encountered in the collecting and evacuation of casualties.

~~DECLASSIFIED~~

DECLASSIFIED

13. Special Equipment and Techniques.

1. There were no special equipment or techniques used.

14. Commanders Comments:

a. Operation Adair was characterized by light contact, limited to occasional sniper fire and no organized enemy resistance.

b. The mobility of tanks in direct support of the 1st Battalion, 5th Marines was acceptable in most circumstances but mobility is extremely limited in wet paddy lands.

15. Recommendations.

c. None.

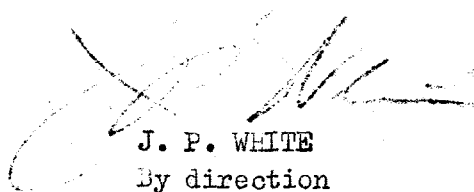

J. P. WHITE
By direction

DECLASSIFIED

SECRET

1st Battalion, 5th Marines
 QUE SON, RVN
 151800H June 1967

Frag Order 67-67

Ref: (a) Map, RVN; 1:50,000; Series L 7014, Sheets 6640 II-III

Time zone H.

1. SITUATION. No change.

2. MISSION. The 1st Battalion, 5th Marines conducts search and destroy operations to kill or capture VC and weapons and destroy caves, tunnels and fortifications.

3. EXECUTION.

TELFORM

a. Company B.

- (1) Secure portion of Objective 27 in zone of action.
- (2) Be prepared to continue attack on order.
- (3) Follow in trace of Company C as it passes to north of Objective 27.

b. Company G.

- (1) Pass to north of Objective 27 and continue attack to Objective 28.
- (2) Be prepared to continue attack on order.

c. H&S Company.

- (1) General Support.

d. 1st Battalion, 5th Marines (Rear).

- (1) General Support.
- (2) Maintain the defense of the combat base.
- (3) Conduct patrol activities.

e. Coordinating Instructions.

- (a) Objective 27 located at (BT 110330)
- (b) Objective 28 located at (BT 125325)
- (c) Objective 29 located at (BT 148325)

TELFORM

4. ADMINISTRATION AND LOGISTICS. No change.

SECRET

5. COMMAND AND COMMUNICATIONS. No change.

P. L. HILGARTNER
Lieutenant Colonel
Commanding

Annex A: Operation Overlay

OFFICIAL

C. H. Black
C. H. BLACK
Major, USMC
S-3

SECRET

1st Battalion, 5th Marines
QUE SON, RVN
151800H June 1967

Annex A (Operation Overlay) to Frag Order 67-67

Ref: (a) Maps, RVN, 1:50,000; Series L7014, Sheets 6640 II-III

O-Z LZ

15
+ 34

27

28

29

32 +
10

P. L. HILGARTNER
Lieutenant Colonel
Commanding

OFFICIAL

C. H. BLACK
Major, USMC
S-3

ENCLOSURE (1)
SECRET

A-1

SECRET

Movement and Night Disposition Overlay D-Day

Ref: Maps, RVN; 1:50,000; Series L7014, Sheets II-III

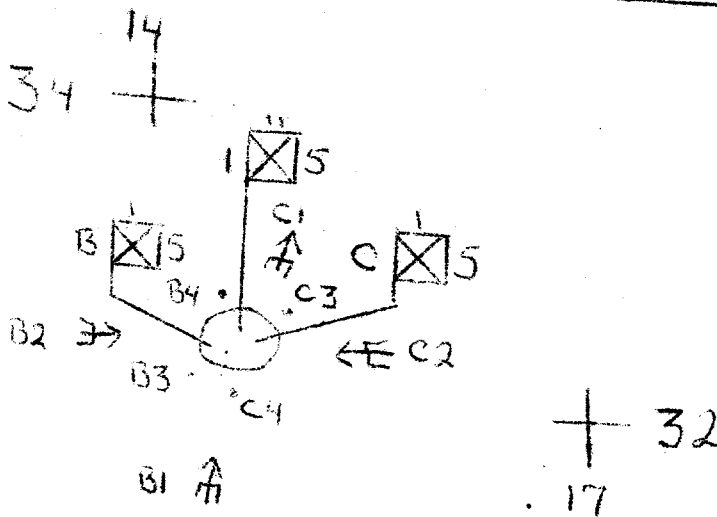
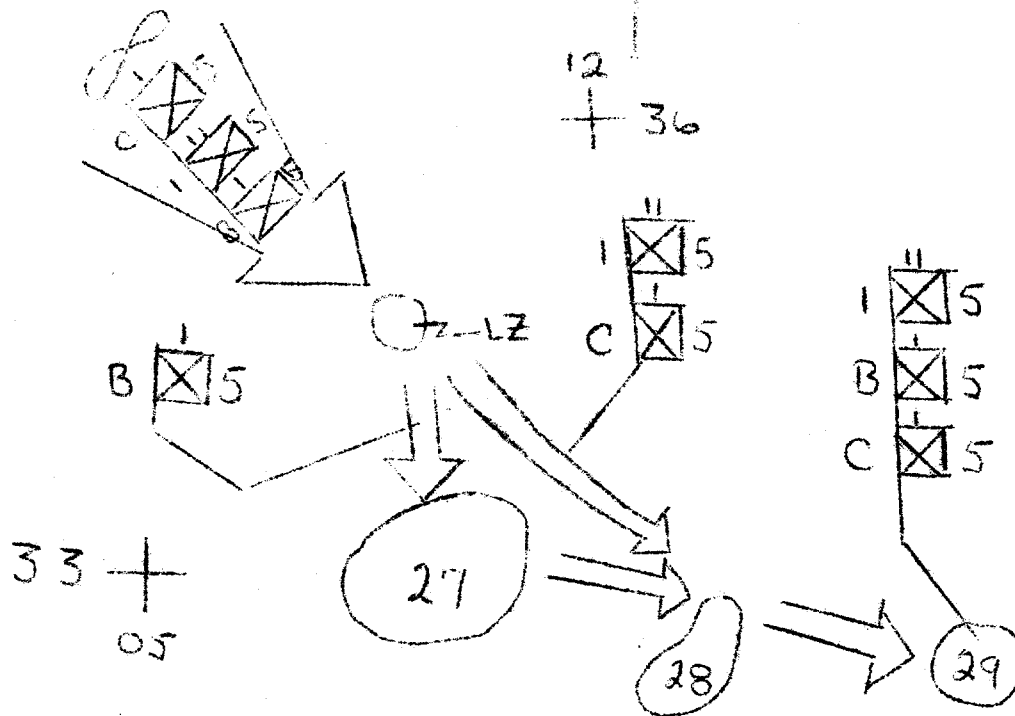

ENCLOSURE (2)

SECRET

SECRET

1st Battalion, 5th Marines
 QUE SON, RVN
 160420H June 1967

Frag Order 68-67

Ref: (a) Map, RVN; 1:50,000, Series L 7014, Sheet II-III.

Time zone H.

1. SITUATION. No change.

2. MISSION. The 1st Battalion, 5th Marines conducts search and destroy operations to kill or capture VC and weapons and destroy caves, tunnels and fortifications.

3. EXECUTION.

a. Concept of Operation. 1st Battalion, 5th Marines conducts attack on Objective J with two companies abreast, prepares to continue attack on order.

b. Company B.

- (1) On order, at H-Hour +1 attack to seize Objective 30.
- (2) Continue attack on order.
- (3) Be prepared to assume other missions on order.

c. Company C.

- (1) On order, at H-Hour +1 attack and seize Objective 28.
- (2) Continue attack on order.
- (3) Be prepared to assume other missions on order.
- (4) Provide flank security for Battalion Command Group.

d. H&S Company.

- (1) General Support.
- (2) Follow in trace of Company C.
- (3) Provide rear security.

e. Battalion Reserve.

- (1) One platoon from Company C designated as Battalion Reserve.
- (2) H&S Company, Battalion Security Group designated as Battalion Reserve.

Reserve.

f. 1st Battalion, 5th Marines (Rear).

- (1) General Support.
- (2) Conduct patrol activities.
- (3) Maintain combat base security.

SECRET

g. Coordinating Instructions.

- (1) Use of RCA authorized and encouraged.
- (2) H-Hour: 0600.
- (3) D-Day: 17 June 1967.

P. L. HILGARTNER
Lieutenant Colonel
Commanding

Annex A: (Operation Overlay)

OFFICIAL

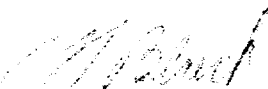

C. H. BLACK
Major, USMC
S-3

SECRET

1st Battalion, 5th Marines
QUE SON, RVN
160420H June 1967

Annex A (Operation Overlay) to Frag Order 68-67

Ref: (a) Maps: RVN, R:50,000, Series L7014, Sheets II-III

14
+ 34

01
+ 31

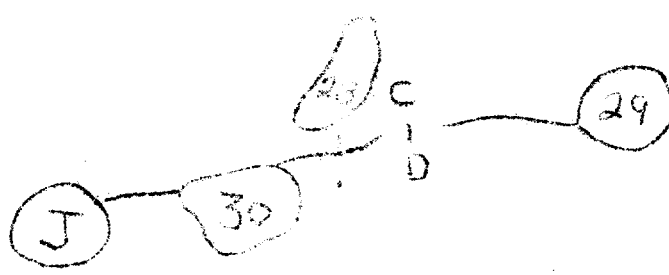

P. L. HILGARTNER
Lieutenant Colonel
Commanding

OFFICIAL

[Signature]
C. H. BLACK
Major, USMC
S-3

ENCLOSURE (3)

SECRET

SECRET

1st Battalion, 5th Marines
 QUE SON, RVN
 161700H June 1967

Frag Order 69-67

Ref: (a) Map, RVN; 1:50,000; Series L 7014, Sheet II-III

Time zone H.

1. SITUATION. No change.
2. MISSION. The 1st Battalion, 5th Marines conduct search and destroy operations to kill or capture VC and weapons and destroy caves, tunnels and fortifications.
3. EXECUTION.
 - a. ~~TRADOC~~ Company C.
 - (1) On order at H-Hour commence move to Objective 31 and set in night defense positions, from 6-12.
 - (2) Be prepared to continue attack on order.
 - (3) Be prepared to assume other missions on order.
 - b. Company B.
 - (1) On order follow in trace of H&S Company to Objective 31. Set in night defensive positions from 12-6.
 - (2) Be prepared to continue attack on order.
 - (3) Be prepared to assume other missions on order.
 - c. H&S Company.
 - (1) General Support.
 - (2) Follow in trace of Company C.
 - (3) Provide flank security for Battalion Command Group.
 - d. Battalion Reserve.
 - (1) Company B have one platoon designated for Battalion reserve.
 - (2) Provide security for Battalion Command Group.
 - e. 1st Battalion, 5th Marines (Rear).
 - (1) ~~TRADOC~~ General Support.
 - (2) Maintain security at combat base.
 - (3) Conduct patrol activities.

SECRET

f. Coordinating Instructions.

- (1) H-Hour 1730 for planning purposes.
- (2) D-Day 16 June 1967.
- (3) North is 12 o'clock for orientation of night defense positions.
- (4) Objective 31 Hill 63 located at (BT 083325).

4. ADMINISTRATION AND LOGISTICS. No change.

5. COMMAND AND COMMUNICATIONS. No change.

P. L. HILGARTNER
Lieutenant Colonel
Commanding

OFFICIAL

C. H. BLACK
Major, USMC
S-3

SECRET

Movement and Night Disposition Overlay D+1

Ref: Maps: RVN, 1:50,000, Series L7014, Sheets II-III

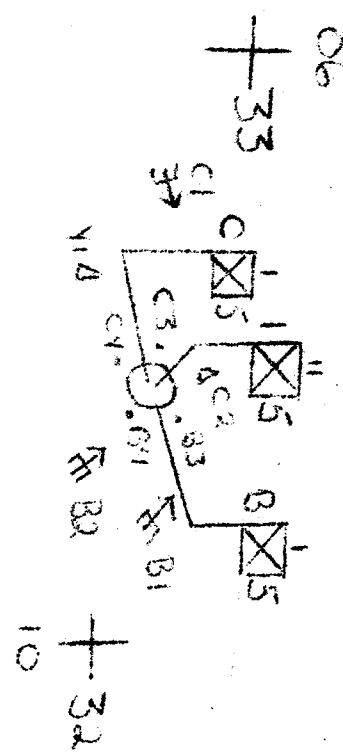
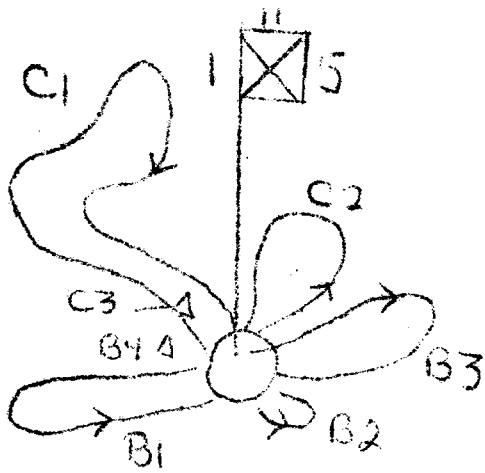
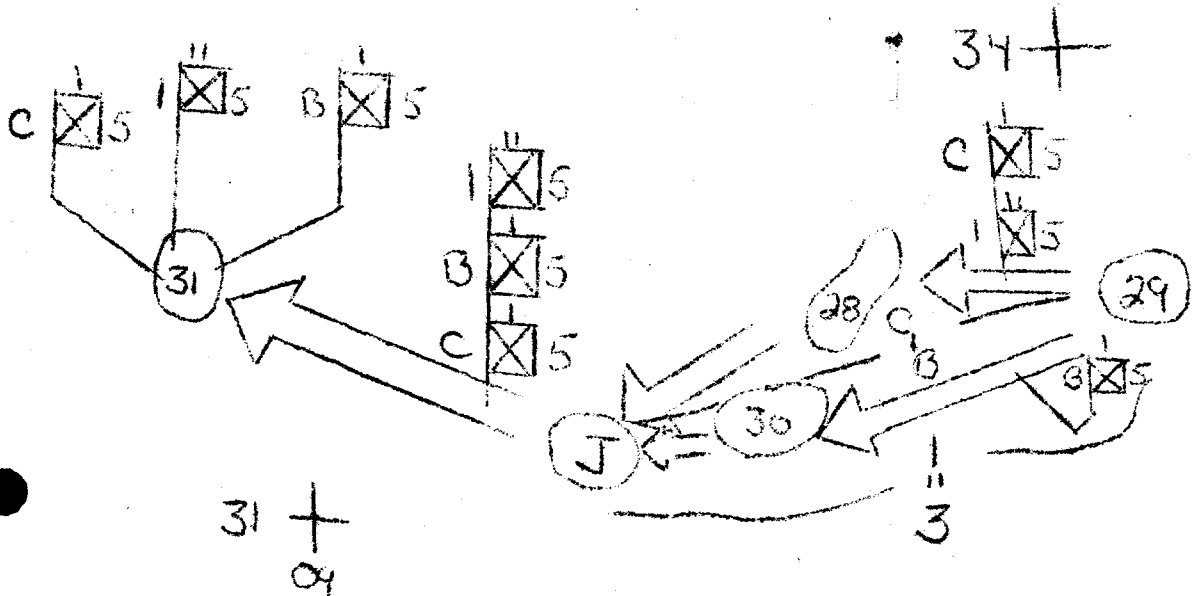

ENCLOSURE (5)

SECRET

SECRET

1st Battalion, 5th Marines
 QUE SON, RVN
 16 June 1967

Frag Order 70-67

Ref: (a) Map, RVN; 1:50,000; Series L 7014; Sheet II-III

Time zone H.

1. SITUATION. No change.

2. MISSION. The 1st Battalion, 5th Marines conducts search and destroy operations to kill or capture VC and weapons and destroy caves, tunnels and fortifications.

3. EXECUTION.

a. Company C.

(1) At H-Hour conduct S&D operations to Objective 4. See Annex A (Operation Overlay).

(2) Be prepared to continue attack on order.

(3) Be prepared to assume other missions on order.

b. Company B.

(1) On order conduct Company (-) patrol along axis of advance. See Annex A (Operation Overlay).

(2) At H-Hour assume responsibility for all around defense of Battalion Sector.

(3) Be prepared to assume other missions on order.

c. Company C.

(1) At H-Hour commence movement to link up with 1st Battalion, 5th Marines command group on Objective 31.

(2) Be prepared to assume other missions on order.

d. H&S Company.

(1) General Support.

e. Battalion Reserve.

(1) Initially Company B.

f. 1st Battalion, 5th Marines (Rear).

(1) General Support.

(2) Maintain Combat Base defense.

(3) Conduct patrol activities.

SECRET

g. Coordinating Instructions.

- (1) H-Hour: 0430H.
- (2) D-Day 17 June 1967.
- (3) Carry all equipment on operation.

4. ADMINISTRATION AND LOGISTICS. No change.

5. COMMAND AND COMMUNICATIONS. No change.

P. L. HILGARTNER
Lieutenant Colonel
Commanding

Annex A: (Operation Overlay)

OFFICIAL

C. H. BLACK
Major, USMC
S-3

Enclosure (6)

SECRET

SECRET

1st Battalion, 5th Marines
QUE SONI, RVN
16 June 1967

Annex A (Operation Overlay) to Frag Order 70-67

Ref: (a) Maps: RVN, 1:50,000, Series L70L4, Sheets II-III

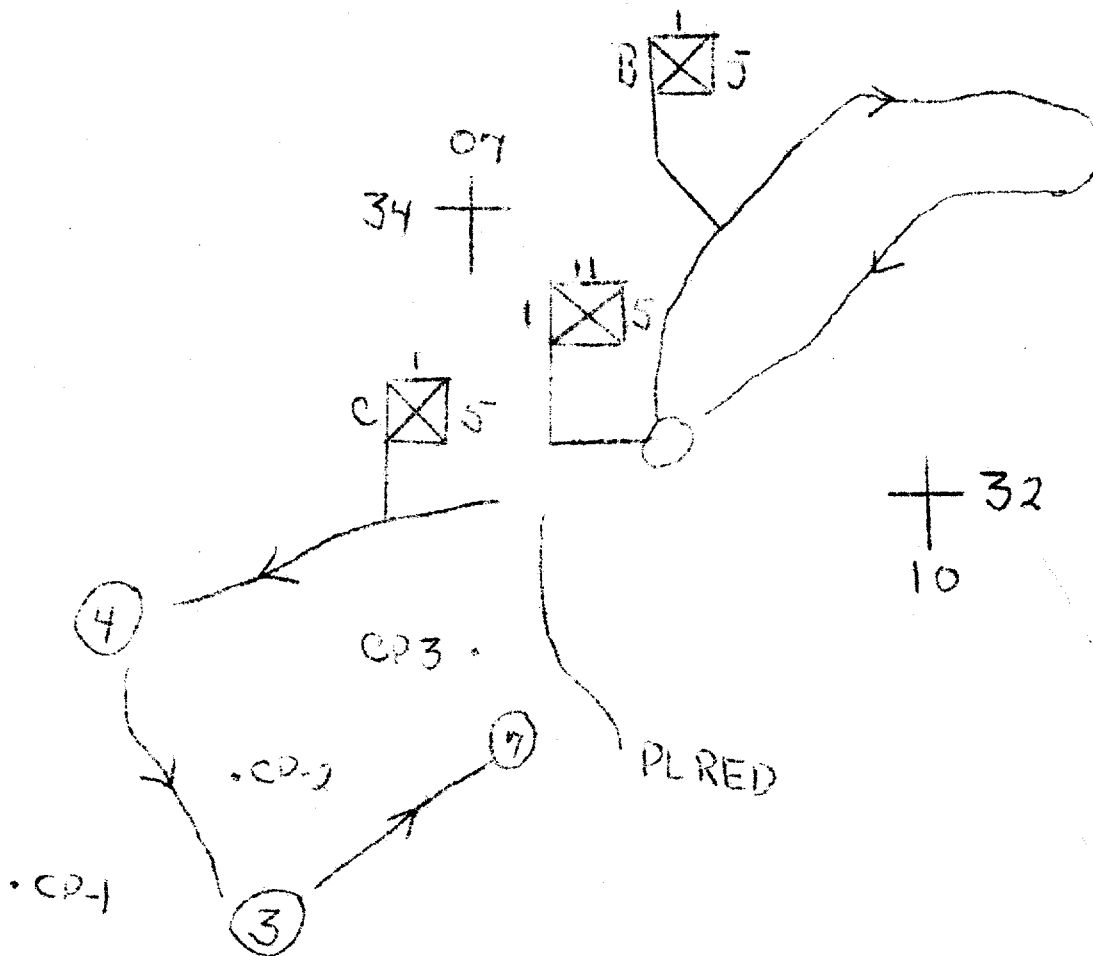

P. L. HILGARTNER
Lieutenant Colonel
Commanding

OFFICIAL

C. H. BLACK
Major, USMC
S-3

ENCLOSURE (6)

SECRET

SECRET

Movement and Disposition Overlay D+3

Ref: Maps: RVN, 1:50,000, Series L7014, Sheets 6640 II-III

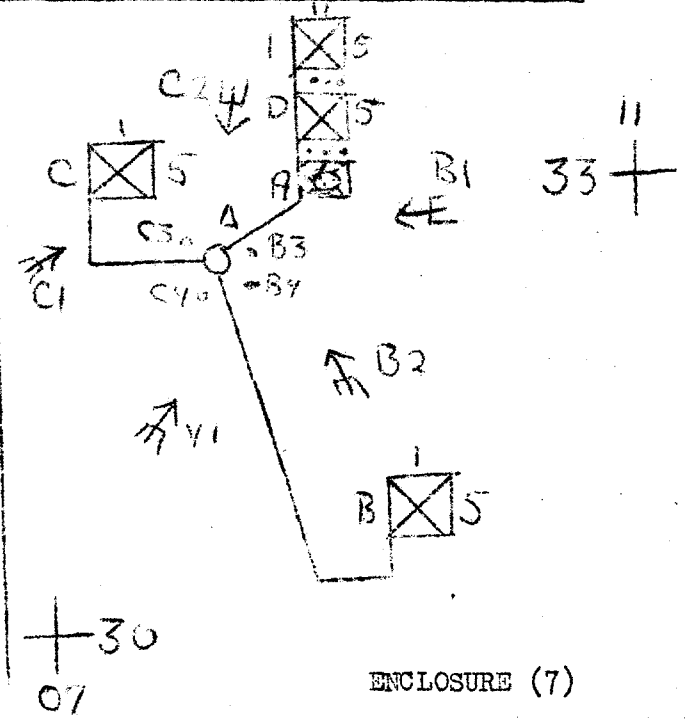
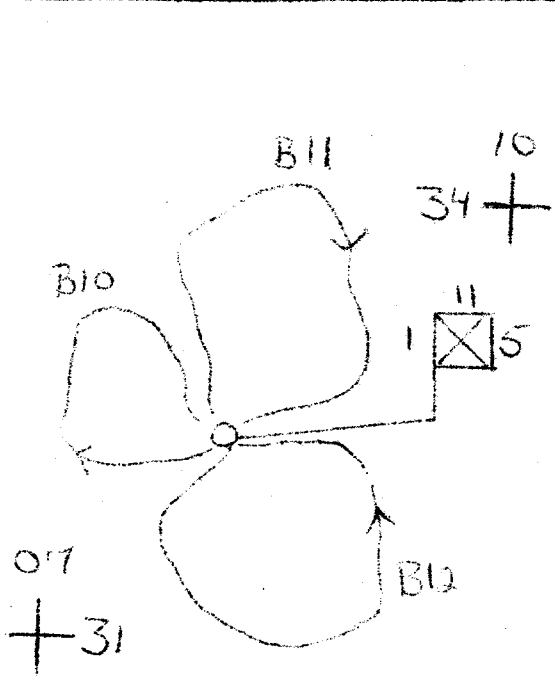
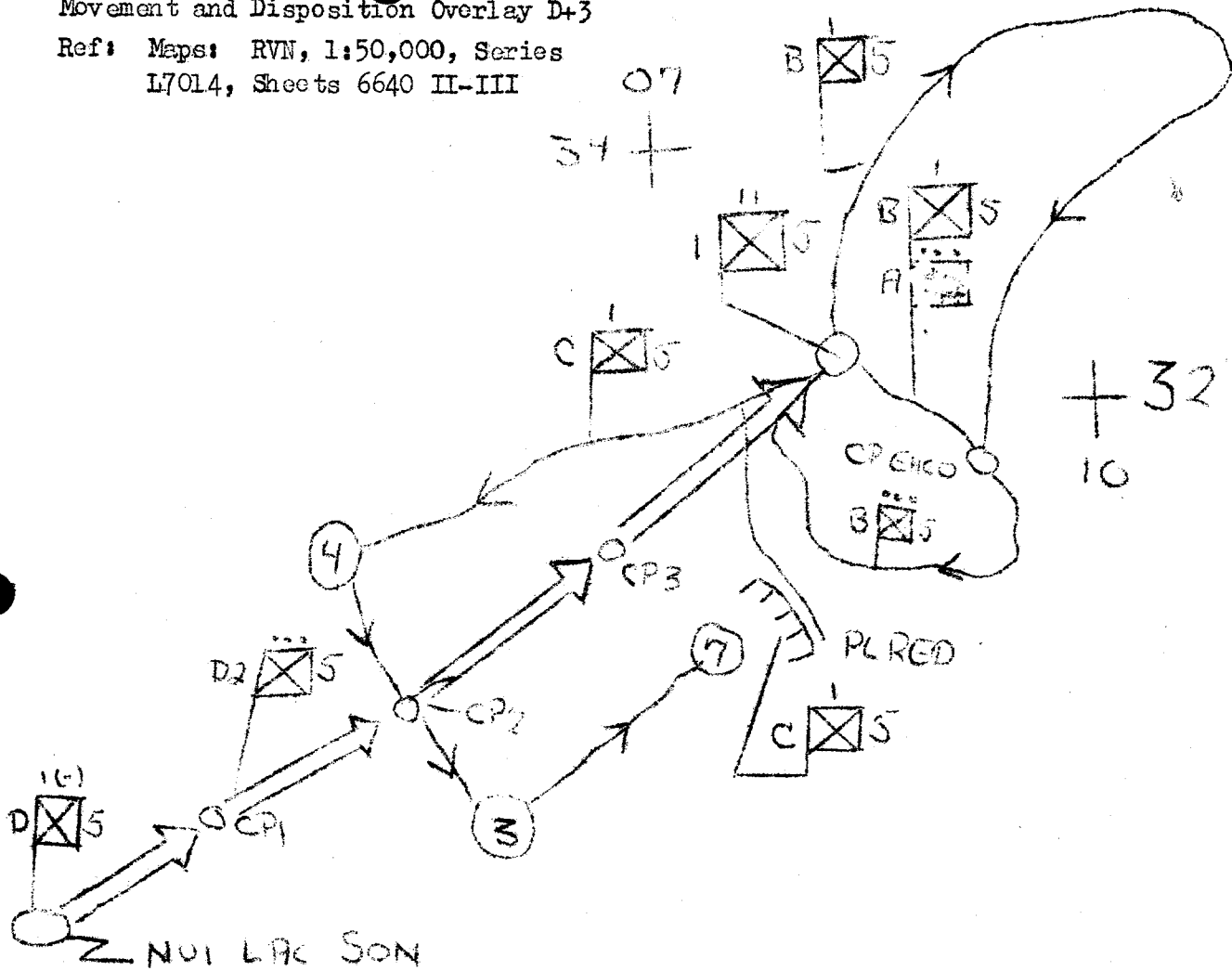

ENCLOSURE (7)

SECRET

SECRET

1st Battalion, 5th Marines.
 QUE SON, RVN
 17 June 1967

Frag Order 71-67

Ref: (a) Map, RVN; 1:50,000; Series L 7014, Sheet II-III

Time zone H.

1. SITUATION.

a. Enemy. No change.b. Friendly Forces. Heavy section, 1st Platoon, Company A, 1st Tank Battalion direct support of 1st Battalion, 5th Marines.

2. MISSION. 1st Battalion, 5th Marines continues attack to destroy enemy forces supplies and equipment and capture VC and weapons.

3. EXECUTION

a. Concept of Operation.

(1) 1st Battalion, 5th Marines conducts search and destroy operations to secure Regimental Objective P.

b. Company B.

(1) On order at H-Hour on D-Day conduct search and destroy operations in assigned zone to secure Objective 9, and continue attack on order.

(2) At H-Hour - 1½ hour commence move to LOD.

(3) Be prepared to assume other missions on order.

c. Company C.

(1) On order at H-Hour on D-Day conduct search and destroy operations in assigned zone to secure Objective 8, continue attack on order.

(2) On order at about H-Hour 1½ hour commence move in trace of Company B to LOD. Be in position on LOD in H½ hour.

(3) Be prepared to assume other missions on order.

d. Heavy Section, 1st Platoon, Company A, 1st Tank Battalion.

(1) One tank in general support. Follow along company boundary in trace of lead companies.

(2) One tank in direct support of Company B and one tank in direct support of Company C. Direct liaison authorized.

ENCLOSURE (8)

SECRET

SECRET

(3) On order at about H-Hour - 1 hour commence move to LOD in trace of Company C.

e. H&S Company.

(1) General Support.

(2) Follow in trace of tanks on boundary between Company C and Company B.

(3) Provide flank and rear security for Battalion Command Group.

f. Battalion Reserve.

(1) 2nd Platoon, Company D.

(2) H&S Company security group.

(3) Be prepared to assume missions as directed.

g. 1st Battalion, 5th Marines (Rear).

(1) General support.

(2) Maintain defense of combat base.

(3) Conduct patrol activities.

h. Coordinating Instructions.

(1) H-Hour 0630H, D-Day 18 June 1967.

(2) Report arrival at objective and phase lines.

(3) Reville 0400H.

(4) Company C has responsibility for road on right of boundary.

4. ADMINISTRATION AND LOGISTICS. No change.

5. COMMAND AND COMMUNICATIONS.

(1) Wear air panels, red side out, dispersed among unit.

P. L. HILGARTNER
Lieutenant Colonel
Commanding

ANNEX: A (Operation Overlay)
B (Fire Support Plan)

OFFICIAL

C. H. Black
C. H. BLACK
Major, USMC
S-3

ENCLOSURE (8)
SECRET

SECRET

1st Battalion, 5th Marines
QUE SON, RVN
17 June 1967

Annex A (Operation Overlay) to Frag Order 71-67

Ref: (a) Maps: RVN, 1:50,000, Series L7014, Sheets II-III

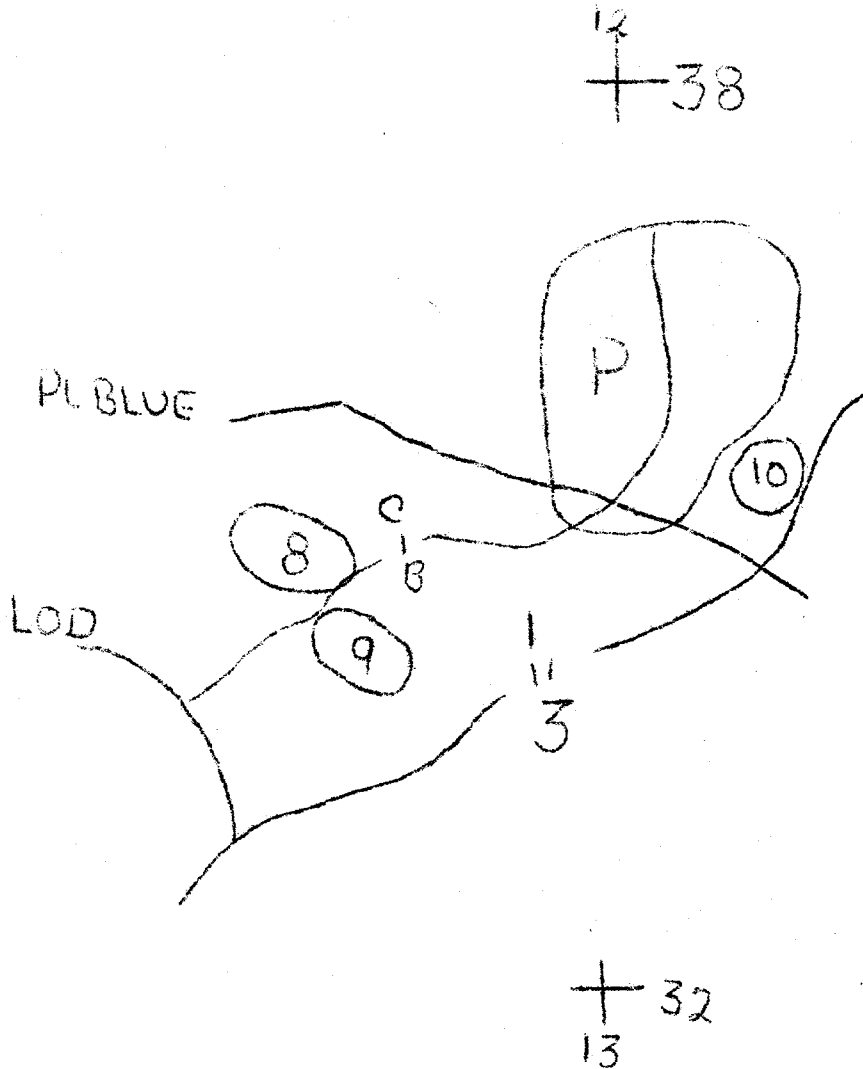

P. L. HILGARTNER
Lieutenant Colonel
Commanding

OFFICIAL

C. H. Black
C. H. BLACK
Major USMC

ENCLOSURE (8)

SECRET

1st Battalion, 5th Marines
QUE SON, RVN
17 June 1967

Annex B (Fire Support Plan) to Frag Order 71-67

Ref: (a) Maps: RVN; 1:50,000; Series L7014, Sheets II-III

1. Artillery.

- a. All artillery will be requested as required.
- b. For on call mission. See Tab 1 (Fire Support Overlay).

2. Air.

- a. TAC/A's will be available for aerial reconnaissance.
- b. Fixed wing air support will be available on an on "Call Basis".
- c. All requests for air support will be made through the Company FAC Team.
- d. Final decision on use of air support remains with the Commanding Officer
1st Battalion, 5th Marines.

P. L. HILGARTNER
Lieutenant Colonel
Commanding

TAB 1 (Fire Support Overlay)

OFFICIAL

C: H. BLACK
Major, USMC
S-3

ENCLOSURE (8)
SECRET

B-1

SECRET

1st Battalion, 5th Marines
QUE SON, RVN
17 June 1967

Tab 1 (Fire Support Overlay) to Annex B (Fire Support Plan)

Ref: (a) Maps: RVN, 1:50,000, Series L7014, Sheets II-III

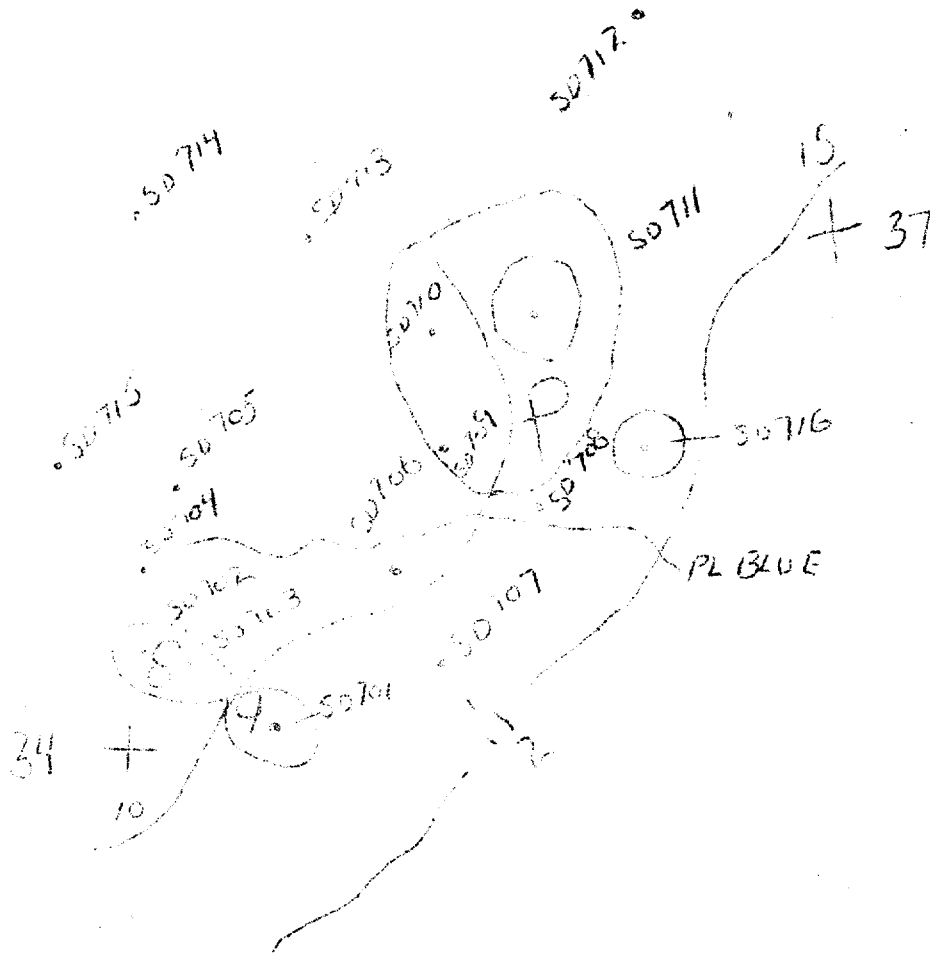

P. L. HILGARTNER
Lieutenant Colonel
Commanding

OFFICIAL

C. H. BLACK
Major, USMC
S-3

ENCLOSURE (8)

SECRET

B-1-1

SECRET

Movement and Night Disposition Overlay D+3

Ref: (a) Maps: RVN, 1:50,000, Series L7014, Sheets II-III

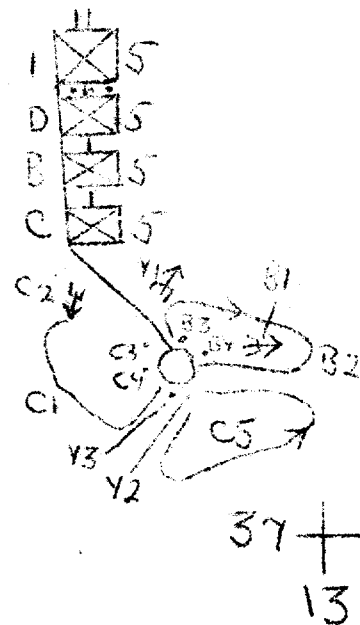
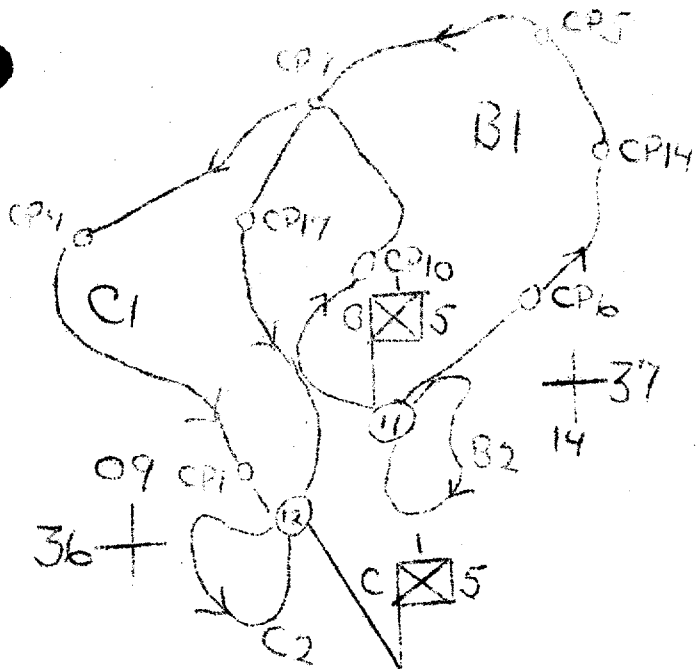
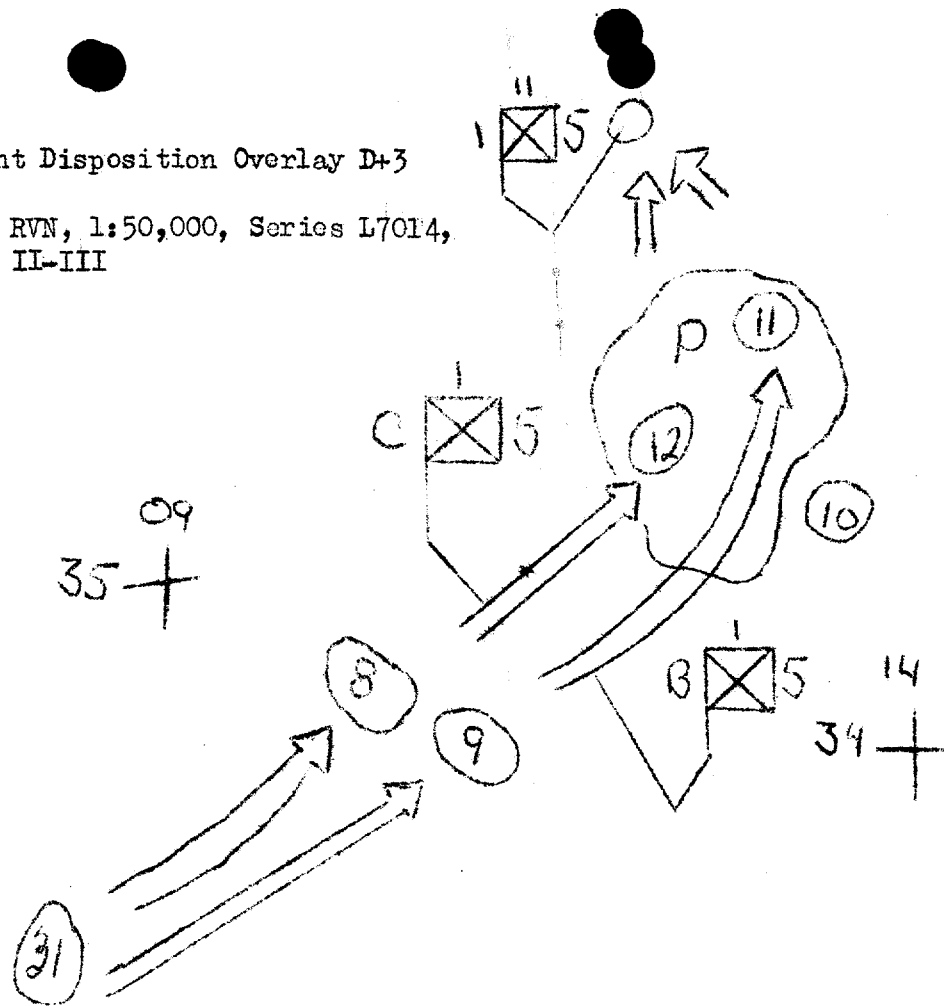

ENCLOSURE (9)

SECRET

SECRET

1st Battalion, 5th Marines
 QUE SON, RVN
 18 June 1967

Frag Order 72-67

Ref: (a) Maps: RVN, 1:50,000; Series L7014, Sheets II-III

Time Zone: H

1. SITUATION. No change.
2. MISSION. To kill or capture VC and weapons, to find and destroy caves, tunnels and field fortifications.
3. EXECUTION
 - a. Concept of Operation. 1st Battalion, 5th Marines attacks with two companies abreast to secure Objective T and on order continue attack to secure Objective U.
 - b. Company B.
 - (1) On order at H-Hour continue attack to seize Objective 39.
 - (2) Continue attack on order.
 - (3) Be prepared to assume other missions on order.
 - (4) Tank Section in direct support.
 - c. Company C.
 - (1) On order at H-Hour continue attack to seize Objective 40.
 - (2) Continue attack on order.
 - (3) Be prepared to assume other missions on order.
 - d. Det. H&S Company.
 - (1) General support.
 - (2) Move in trace of Company C or B as directed.
 - e. 1st Battalion, 5th Marines (Rear).
 - (1) General support.
 - (2) Maintain defense of the Combat Base.
 - (3) Conduct patrol activities.
 - f. Coordinating Instructions.
 - (1) H-Hour 0600H; D-Day 19 June 1967.
 - (2) Report arrival at objectives and phase lines.
 - (3) Contact right to left as far as phase line Black, then as directed.
 - (4) Reveille: 0430H.
 - (5) LOD is present positions.

ENCLOSURE (10)

SECRET

~~SECRET~~

- 4. ADMINISTRATION AND LOGISTICS.
 - a. Take salt tablets.
- 5. COMMAND AND COMMUNICATIONS.
 - a. Display air panels.

P. L. HILGARTNER
Lieutenant Colonel
Commanding

ANNEX: A (Operation Overlay)

OFFICIAL

C. H. BLACK
Major, USMC
S-3

ENCLOSURE (10)

SECRET

SECRET

Annex A (Operation Overlay) to Frag Order 7-2-67

Ref: (a) Maps: RVN; 1:50,000, Series I7014, Sheets II-III

1st Battalion, 5th Marines
QUE SON, RVN
18 June 1967

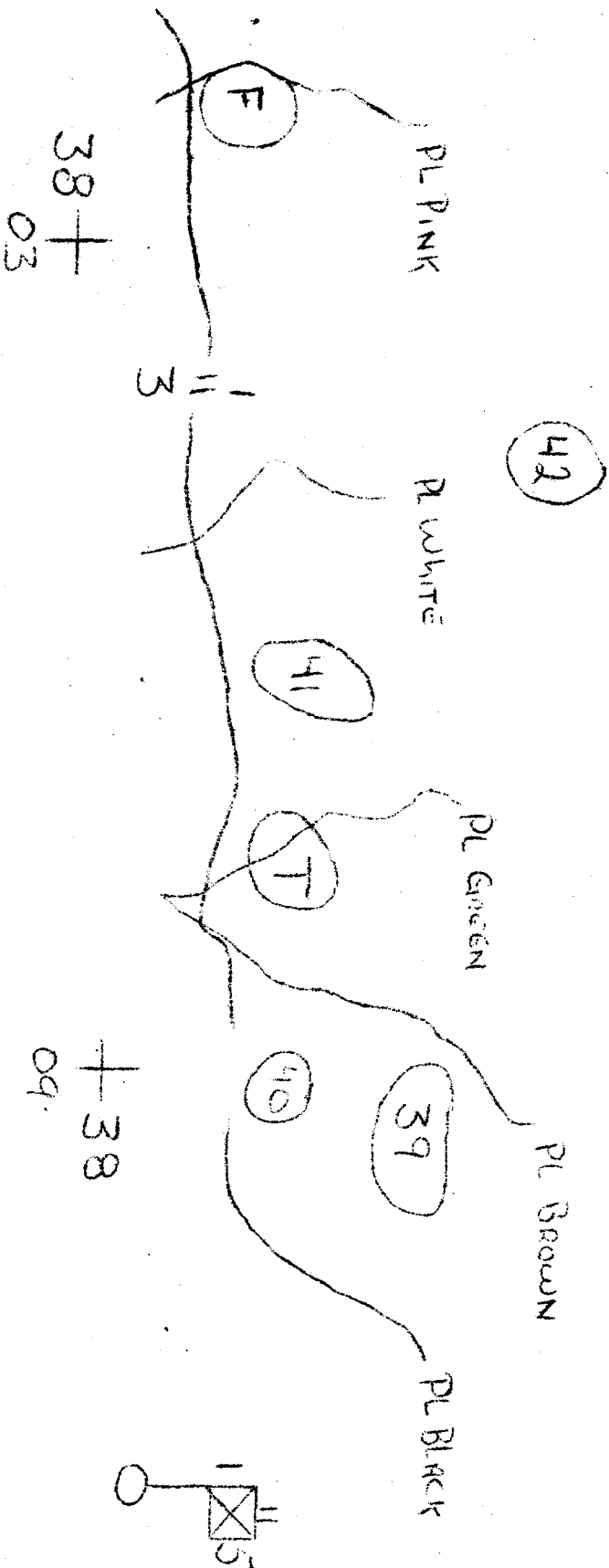

P. L. HICARNEY
Lieutenant Colonel
Commanding

OFFICIAL

C. H. BLACK
Major, USMC

A-1

ENCLOSURE (10)

SECRET

SECRET

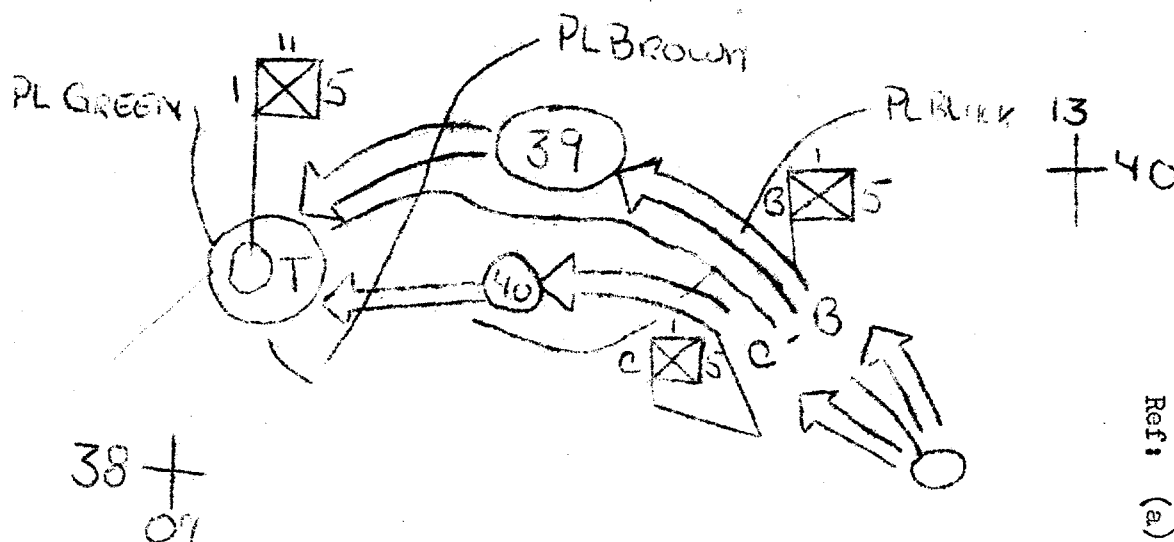

Movement and Night Disposition Overlay D-4
 Ref: (a) Maps: RVN; 1:50,000, Series I7014, Sheets II-III

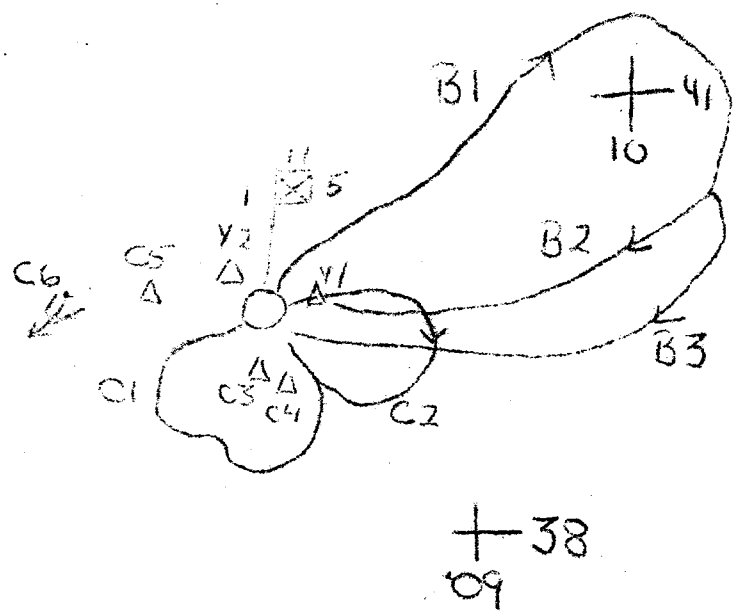
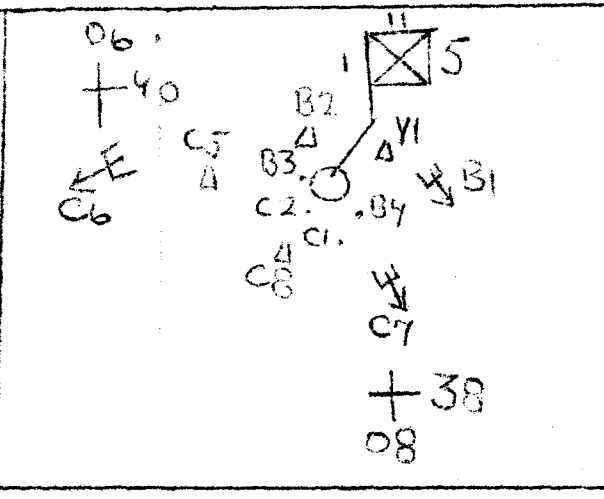
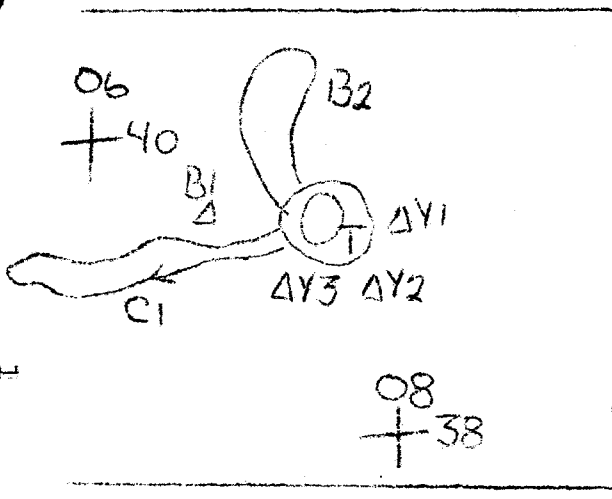

ENCLOSURE (11)
 SECRET

SECRET

Movement and Night Disposition Overlay D+5

Ref: (a) Maps: RVN; 1:50,000, Series L7014, Sheets II-III

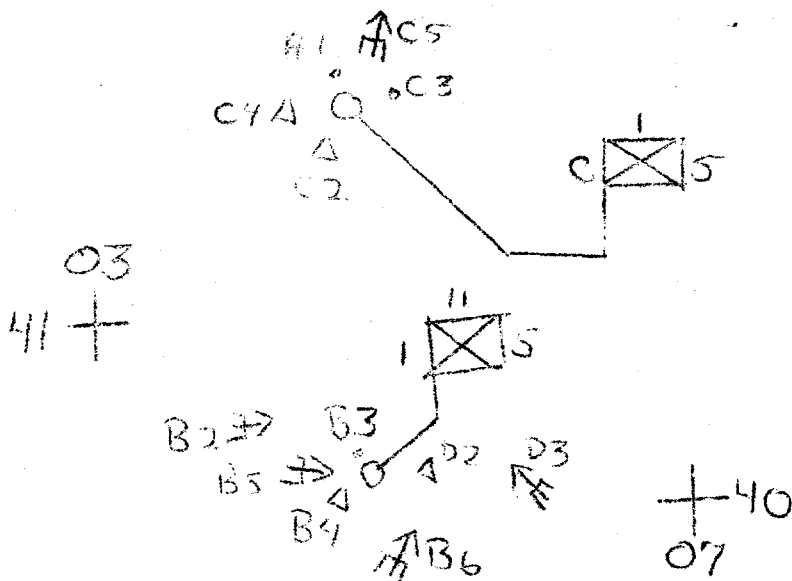
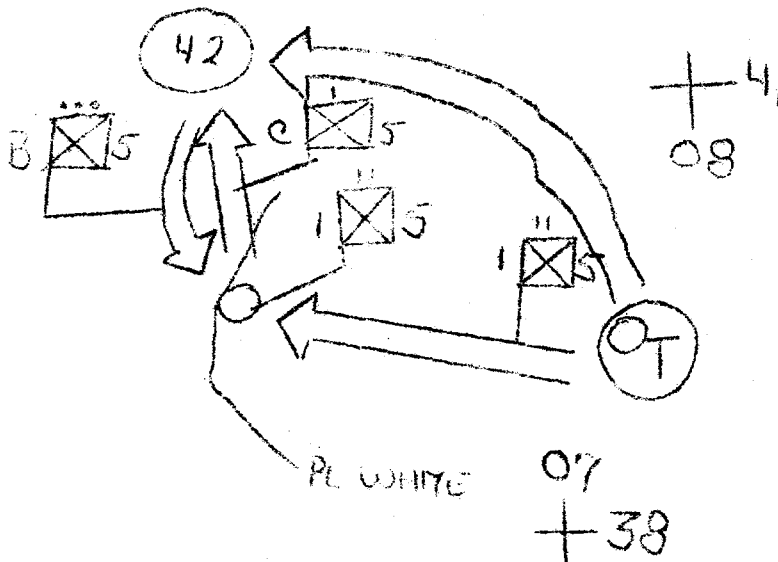
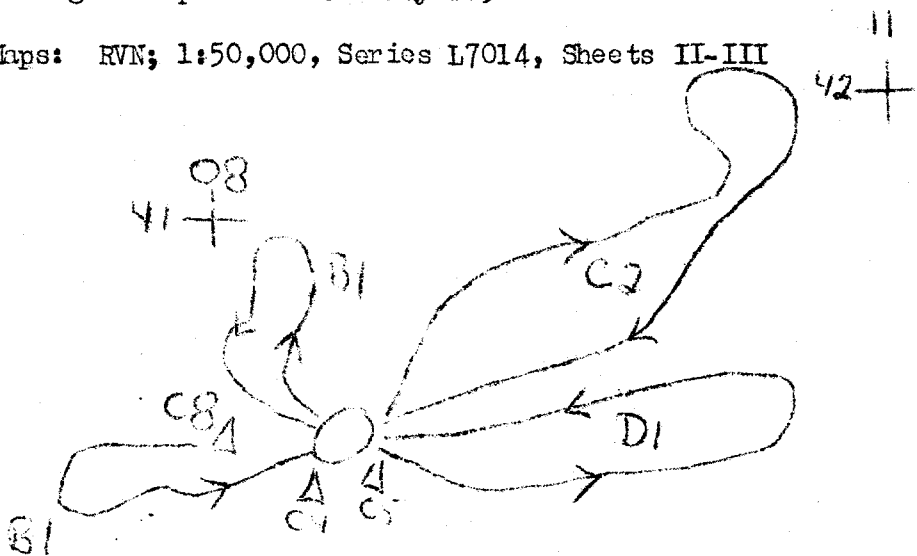

ENCLOSURE (12)

SECRET

SECRET

1st Battalion, 5th Marines
 QUE SON, RVN
 20 June 1967

Frag Order 73-67

Ref: (a) Maps: RVN; 1:50,000; Series L7014, Sheets II-III

Time Zone: H

1. SITUATION. No change.

2. MISSION. The 1st Battalion, 5th Marines conducts search and destroy operations to kill or capture VC and weapons and to destroy caves, tunnels and fortifications.

3. EXECUTION

a. Company C.

(1) At H-Hour-3 hours commence search of general area bounded by coordinates (BT 048418), (BT 041418), (BT 041411), (BT 047412), and make follow-up report on results of search.

(2) At H-Hour on order continue search and destroy operation along axis of advance Lima to secure Objective 43, continue attack on order.

(3) Be prepared to assume other missions on order.

b. Company B.

(1) At H-Hour-3 on order conduct platoon reinforced patrol with Chatsworth units, to vicinity of Objective U.. LOA Phase Line Pete, continue attack on order.

(2) On order continue attack to Objective U, continue attack on order.

(3) Be prepared to assume other missions on order.

c. 1st Platoon, Company A, 1st Tank Battalion.

(1) Direct Support of Company B.

d. Det, F&S Company.

(1) General support.

(2) Follow in trace of Company B.

(3) Provide flank and rear security, for Battalion Command Group.

e. Battalion Reserve.

(1) 2nd Platoon, Company D.

(2) Battalion Security Group.

f. Coordinating Instructions.

(1) H-Hour 0900; D-Day 21 June 1967.

(2) Be alert for mines and booby traps.

ENCLOSURE (13)

SECRET

SECRET

(5) Locations:

- (a) Objective 43 (BT 019399)
- (b) Objective 44 (BT 003396)
- (c) Objective 45 (BT 003379)
- (d) Objective 46 (AT 990370)
- (e) Check Point Bob (BT 027410)

4. ADMINISTRATION AND LOGISTICS.

- a. Take salt tablets as directed.

5. COMMAND AND COMMUNICATIONS.

- a. Display air panels, yellow side out, air panels dispersed within the unit.

P. L. HILGARTNER
Lieutenant Colonel
Commanding

ANNEX: A (Operation Overlay)

OFFICIAL

C. H. BLACK
Major, USMC
S-3

ENCLOSURE (13)

SECRET

SECRET

1st Battalion, 5th Marines
QUE SON, RVN
20 June 1967

Annex A (Operation Overlay) to Frag Order 72-67

Ref: (a) Maps: RVN; 1:50,000, Series L7014, Sheets II-III

40 +
99

44

113

W

PL PINK

45

46

+ 36
01

P. L. HILGARTNER
Lieutenant Colonel
Commanding

OFFICIAL

C. H. BLACK
Major, USMC
S-3

ENCLOSURE (13)

SECRET

SECRET

1st Battalion, 5th Marines
 QUE SON, RVN
 21 June 1967

Frag Order 74-67

Ref: (a) Maps: RVN, 1:50,000, Series L7014, Sheets II-III

Time Zone: H

1. SITUATION. No change.
2. MISSION. To kill or capture VC and weapons, destroy caves, tunnels and fortifications.

3. EXECUTION

a. Company C (-).

(1) At H-Hour-30 minutes commence movement with Chatsworth unit by most possible route to Hill 51 Combat Base.

(2) Be prepared to assume other missions on order.

b. Company A.

Det, Co B, 1stIngrBn
 Det, Btry D, 2ndBn, 11thMar
 Det, Co B, 1stSPBn
 Det, HqCo, 5thMar (Scout Sniper)
 Det, H&S Company
 81 FO Tm
 Det, Comm Plat
 Det, Med Plat

(1) At H-Hour commence movement along Phase Line Mary to establish company patrol base vicinity Objective 48, actively patrol in 1st Battalion, 5th Marines zone as directed.

(2) Link up with 1st Battalion, 5th Marines and continue attack on order

(3) Be prepared to assume other missions on order.

c. Company B.

(1) On order conduct platoon (Rein) patrol to cave complex along patrol route to be designated.

(2) On order continue attack to Objective 47, continue attack on order.

(3) Be prepared to assume other missions on order.

d. Heavy Section, Company A, 1st Tank Battalion.

(1) Direct support of Company C.

ENCLOSURE (15)
 SECRET

SECRET

e. Company C.

(1) Conduct patrols as directed, return to combat base on order.

f. Battalion Reserve.

(1) Battalion security group.

(2) 2nd Platoon, Company D.

g. Coordinating Instructions.

(1) H-Hour (0630H) D-Day 22 June 1967.

(2) Company A control linkup with 1st Battalion, 5th Marines.

(3) Take salt tablets.

(4) Air panels, red side out.

(5) Position reports hourly at 10 minutes before the hour.

(6) 1st Battalion, 5th Marines (Rear) monitor all transmission on Battalion TAG nets.

(7) Locations:

Objective 47 (AT 992367)

Objective 48 (AT 989354)

CP Bill (AT 988360)

4. ADMINISTRATION AND LOGISTICS. No change.

5. COMMAND AND COMMUNICATIONS. No change.

P. L. HILGARTNER
 Lieutenant Colonel
 Commanding Officer

ANNEX: A (Operation Overlay)

OFFICIAL

C. H. BLACK
 Major, USMC
 S-3

ENCLOSURE (15)
 SECRET

SECRET

1st Battalion, 5th Marines
QUE SON, RVN
21 June 1967

Annex A (Operation Overlay) to Frag Order 74-67

Ref: (a) Maps: RVN; 1:50,000, Series L7014, Sheets II-III

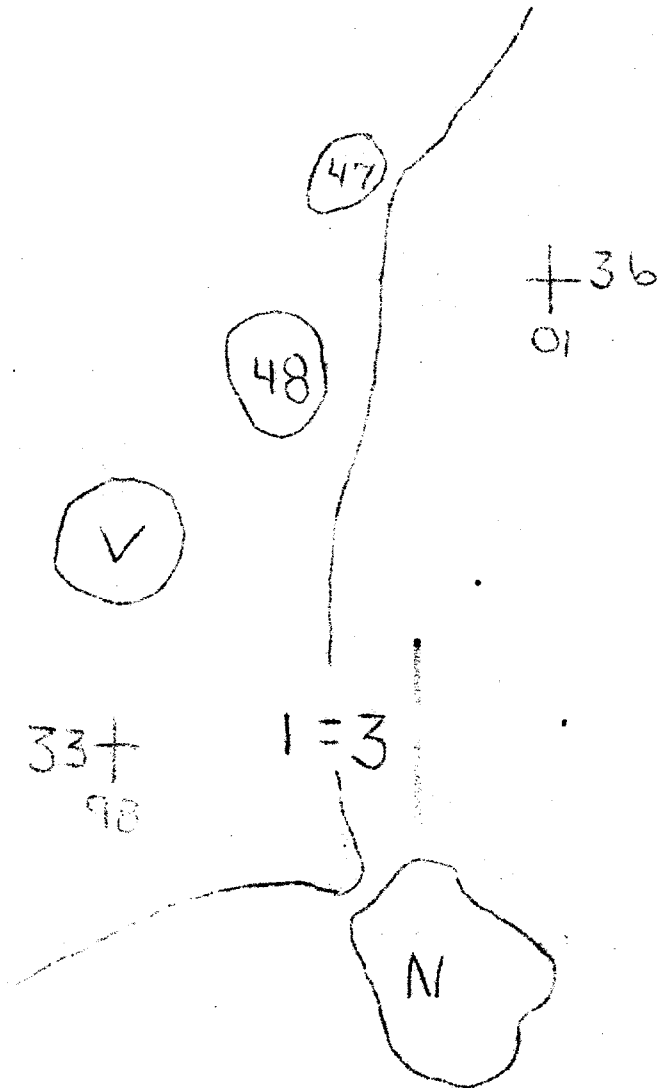

P. L. HILGARTNER
Lieutenant Colonel
Commanding

OFFICIAL

C. H. Black
C. H. BLACK
Major, USMC
S-3

ENCLOSURE (15)

SECRET

SECRET

1st Battalion, 5th Marine
 QUE SON, RVN
 21 June 1967

FRAG ORDER 74A-67

1. SITUATION. No change.
2. MISSION. No change.
3. EXECUTION

a. Company A. At H-Hour, move out along Phase Line Mary in accordance with Battalion Frag Order 74-67 to linkup with 1st Battalion, 5th Marines.

b. Lima Company, 3rd Battalion, 5th Marines. Establish blocking position to support movement of Company A, 1st Battalion, 5th Marines and 3rd Battalion 5th Marines units.

c. India Platoon, 3rd Battalion, 5th Marines.

(1) Be prepared to move out on order in trace of Company A, 1st Battalion 5th Marines to linkup with 3rd Battalion, 5th Marines units vicinity coordinate (BT 007350).

(2) Escort Chatsworth A-3 to linkup point. See Annex A (Operation Overlay).

d. Chatsworth A-3. On order move out with India Platoon, 3rd Battalion 5th Marines, linkup with 3rd Battalion, 5th Marines. See Annex A (Operation Overlay).

e. H&S Company, 1st Battalion, 5th Marines. Conduct daytime activities as directed.

f. Coordinating Instructions.

(1) H-Hour: 0630H, D-Day: 22 June 1967.

4. ADMINISTRATION AND LOGISTICS. No change.
5. COMMAND AND COMMUNICATIONS. No change.

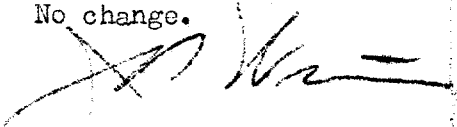
 J. P. WHITE
 Major, U. S. Marine Corps
 Executive Officer

ANNEX: A (Operation Overlay)

ENCLOSURE (16)
 SECRET

SECRET

1st Battalion, 5th Marines
QUE SON, RVN
21 June 1967

Annex A (Operation Overlay) to Frag Order 74A-67

Ref: (a) Maps: RVN; 1:50,000, Series L7014, Sheets II-III

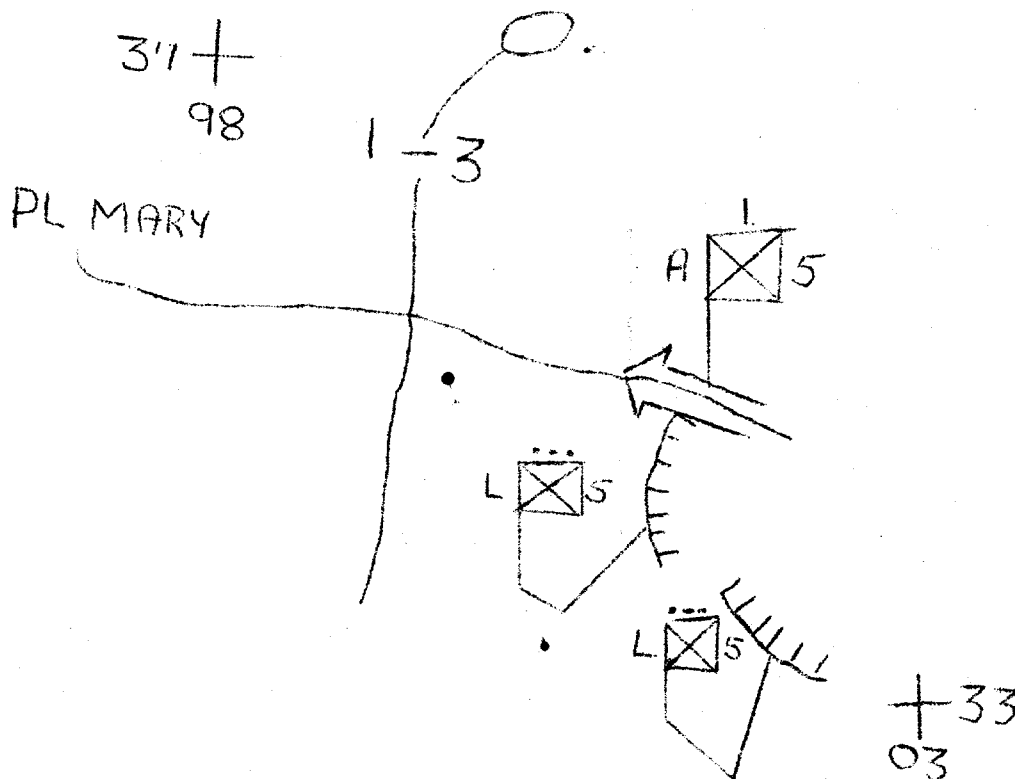

J. P. White
 J. P. WHITE
 Major, U. S. Marine Corps
 Executive Officer

ENCLOSURE (16)
SECRET

SECRET

1st Battalion, 5th Marines
 QUANG SON, RVN
 22 June 1967

Modification to Frag Order 74-67

Ref: (a) Maps: RVN, 1:50,000, Series L7014, Sheets II-III

Time Zone: H

1. SITUATION. No change.

2. MISSION. No change.

3. EXECUTION

a. Company B.

(1) On order attack to seize Objective 49, continue attack on order to seize portion of Objective V in zone.

(2) Report arrival at Phase Line Mary.

b. Company A.

(1) On order continue attack to seize portion of Objective V in zone.

c. Company C-2.

(1) On order continue movement to Objective 48 and then to 1st Battalion 5th Marines Combat Base Hill 51.

d. Det, H&S Company.

(1) At CP Bill move to linkup with Company A on Objective 48.

e. Coordinating Instructions. No change.

4. ADMINISTRATION AND LOGISTICS. No change

5. COORDINATING AND COMMUNICATIONS. No change.

P. L. HILGARTNER
 Lieutenant Colonel
 Commanding

ANNEX: A (Operation Overlay)

OFFICIAL

C. H. BLACK

Major, USMC

S-3

ENCLOSURE (17)
 SECRET

SECRET

1st Battalion, 5th Marines
QUE SON, RVN
22 June 1967

Modification to Frag Order 74-67

Ref: (a) Maps: RVN; 1:50,000, Series L7014, Sheets II-III

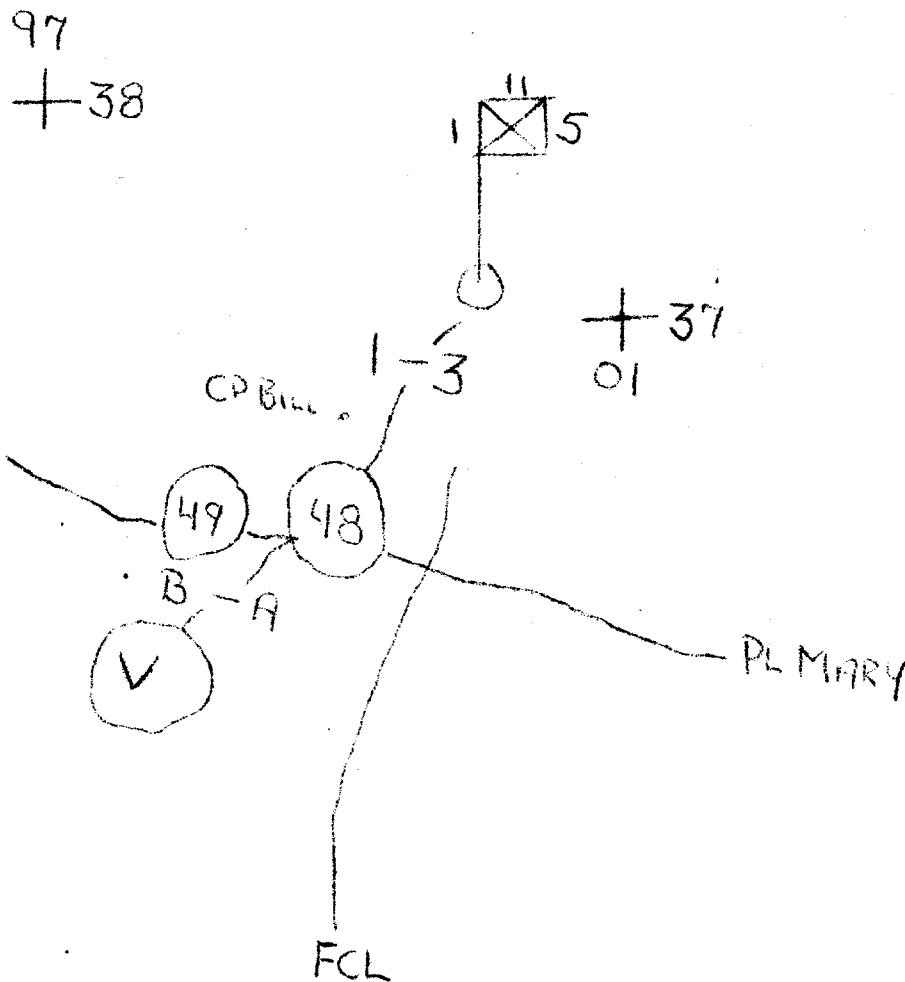

P. L. HILGARTNER
Lieutenant Colonel.
Commanding

ORIGINAL

C. H. BLACK
Major, USMC
S-3

ENCLOSURE (17)

~~UNCLASSIFIED~~

Movement and Night Disposition Overlay D+7

Ref: (a) Maps: RVN; 1:50,000, Series L7014, Sheets II-III

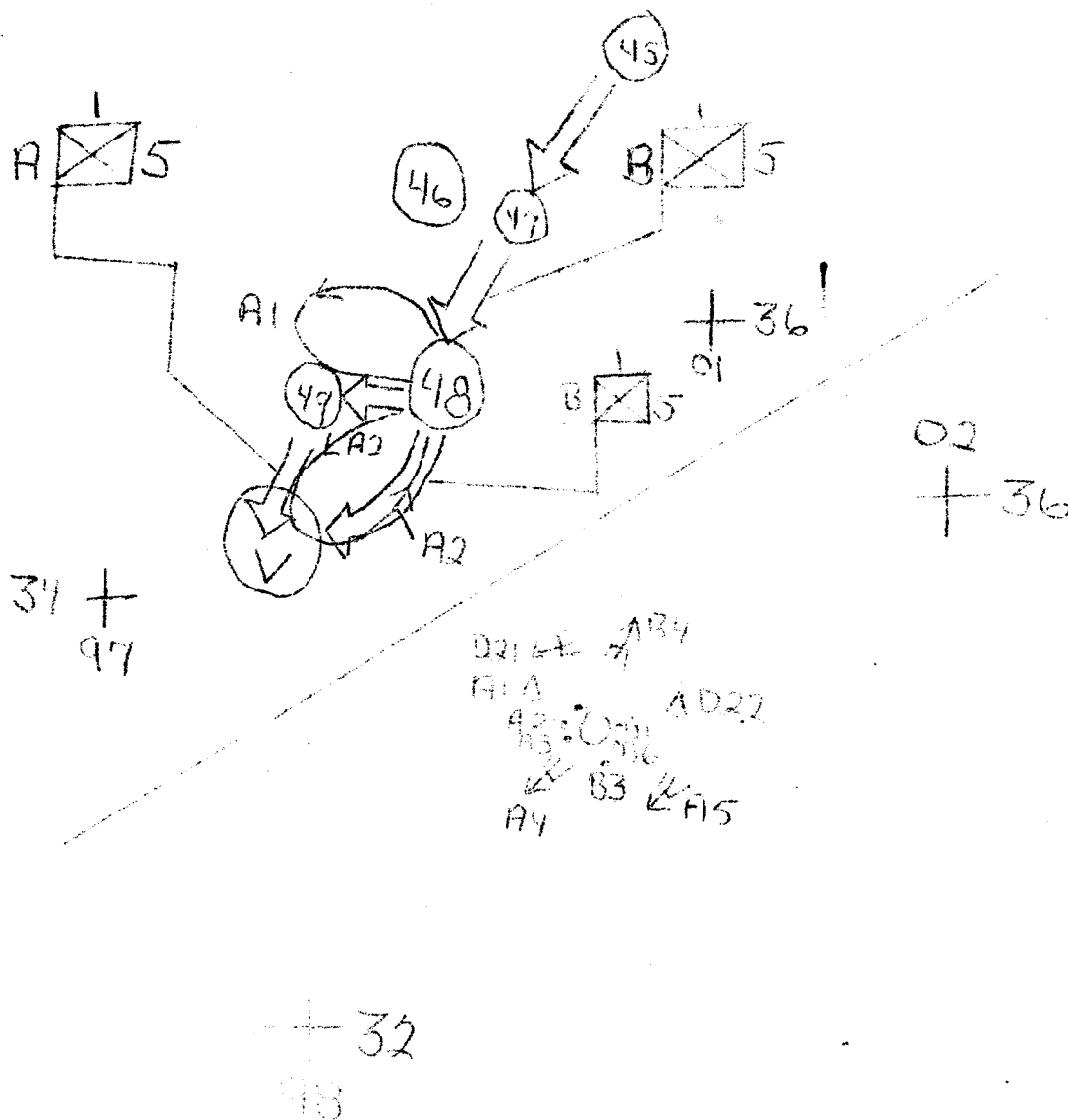

ENCLOSURE (18)

~~UNCLASSIFIED~~

~~SECRET~~**UNCLASSIFIED**1st Battalion, 5th Marines
QUE SON, RVN
23 June 1967

Frag Order 75-67

Ref: (a) Maps: RVN; 1:50,000, Series L7014, Sheets II-III

Time Zone: H

1. SITUATION. No change.

2. MISSION. No change.

3. EXECUTION

a. Company A.

(1) At H-Hour commence patrol activities from present position, continue attack on order.

(2) Be prepared to assume other missions on order.

b. Company B.

(1) On order at H-Hour conduct S&D operation to 1st Battalion, 5th Marine Combat Base along route of advance.

(2) Be prepared to assume other missions on order.

c. Company C.

(1) Provide one platoon (rein) security for movement of Chatsworth units from 1st Battalion, 5th Marines Combat Base to linkup points and return to 1st Battalion, 5th Marines Combat Base with light section of Chatsworth units.

(2) Be prepared to assume other missions on order.

d. Det, H&S Company.

(1) General support.

(2) Provide flank and rear security for Battalion Command Group.

e. Battalion Reserve.

(1) 2nd Platoon, Company D.

(2) Battalion security group.

f. Specializing Instructions.

(1) H-Hour: 0700H, D-Day: 23 June 1967.

(2) Available: 0515H.

4. ADMINISTRATION AND LOGISTICS. No change.

5. COMMAND AND COMMUNICATIONS. No change.

P. L. HILGARTNER
Lieutenant Colonel
Commanding**UNCLASSIFIED**OFFICIAL

ENCLOSURE (19)

C. H. BLACK
Major, USMC

Movement and Night Disposition Overlay D+8

Ref: (a) Maps: RVN: 1:50,000, Series L7014, Sheets TL-III

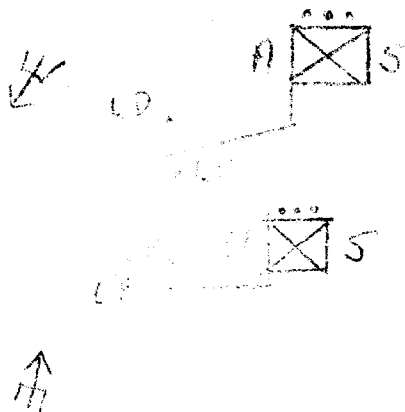
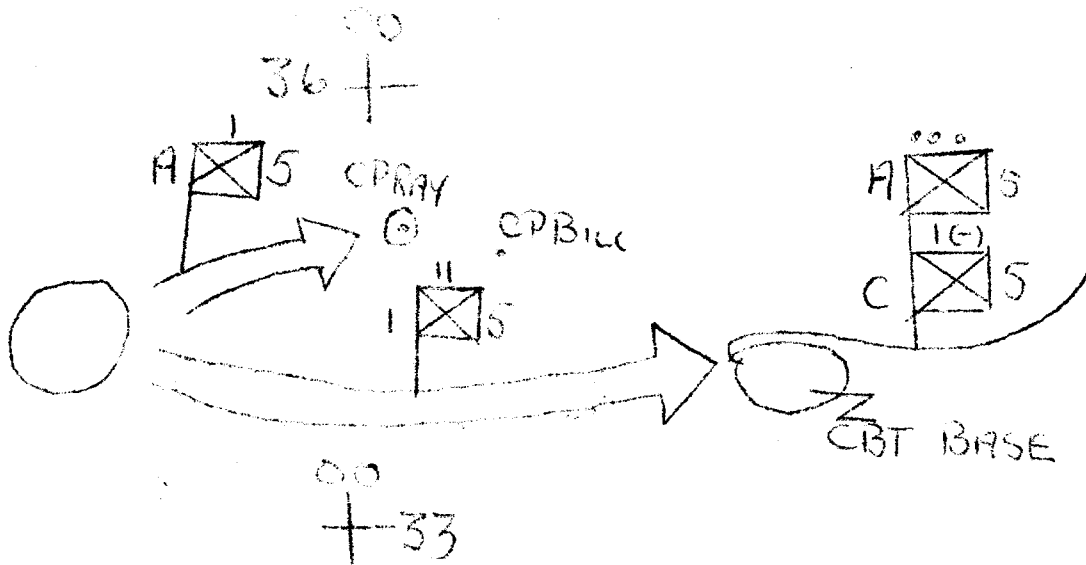

00 04
+ 35

+ 32
00

ENCLOSURE (20)